

TOSHIBA



OWNER'S MANUAL

Integrated High Definition DLP™ Projection Television

COLORSTREAM® HD

CINEMA SERIES HD



HDMI

Compatible with the new Toshiba

Symbio™

Audio/Video Hard Drive Recorder!

See pages 26 and 55 for details.

Note: A high definition tuner and programming are required to view High Definition TV broadcasts. Please contact your cable or satellite provider.

For an overview of steps for setting up and using your new TV, see page 10.

56MX195

62MX195

72MX195



Owner's Record

The model number and serial number are on the back of your TV. Record these numbers in the spaces below. Refer to these numbers whenever you communicate with your Toshiba dealer about this TV.

Model number:

Serial number:

Dear Customer,

Thank you for purchasing this Toshiba TV. This manual will help you use the many exciting features of your new TV. **Before operating the TV, please read this manual completely, and keep it nearby for future reference.**

Safety Precautions

WARNING: TO REDUCE THE RISK OF FIRE OR ELECTRIC SHOCK, DO NOT EXPOSE THIS APPLIANCE TO RAIN OR MOISTURE.

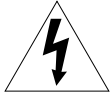

WARNING
RISK OF ELECTRIC SHOCK!
DO NOT OPEN.



WARNING: TO REDUCE THE RISK OF ELECTRIC SHOCK, DO NOT REMOVE COVER (OR BACK). NO USER-SERVICEABLE PARTS INSIDE. REFER SERVICING TO QUALIFIED SERVICE PERSONNEL. (This does not apply to "Lamp unit replacement and care" on pages 119-121 of this manual.)

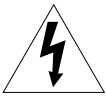

The lightning flash with arrowhead symbol, within an equilateral triangle, is intended to alert the user to the presence of uninsulated "dangerous voltage" within the product's enclosure that may be of sufficient magnitude to constitute a risk of electric shock to persons.



The exclamation point within an equilateral triangle, is intended to alert the user to the presence of important operating and maintenance (servicing) instructions in the literature accompanying the appliance.

Lamp Unit Replacement



CAUTION: HOT SURFACE!

The temperature of the lamp immediately after use exceeds 392°F (200°C). Touching the



lamp before it has cooled will result in severe burns. ALLOW THE LAMP TO COOL FOR AT LEAST ONE (1) HOUR BEFORE REPLACING IT.

The lamp in this product has a limited service life. The length of service life varies depending on product use and user settings. If you use the lamp beyond its service life:

- you may notice a reduction in the colors and/or brightness of the picture, at which time you should replace the lamp unit; and
- the strength of the quartz glass in the lamp will be reduced and the lamp may rupture. If the lamp ruptures, the TV will not operate until the lamp unit is replaced.
- Dispose of the used lamp unit by the approved method for your area.

See "Lamp unit replacement and care" on pages 119-121.



Note: The lamp unit contains mercury.

Disposal of mercury may be regulated due to environmental considerations. For disposal or recycling information, contact your local authorities or the Electronic Industries Alliance (www.eiae.org).

NOTICE OF POSSIBLE TV STAND INSTABILITY



CAUTION: This television is for use only with the Toshiba stand listed below. Use with other carts or stands is capable of resulting in instability causing possible injury.

Television	Stand Model
56MX195	ST xxxx
62MX195	ST xxxx
72MX195	ST xxxx

NOTE TO CATV INSTALLERS IN THE U.S.A.

This is a reminder to call the CATV system installer's attention to Article 820-40 of the U.S. NEC, which provides guidelines for proper grounding and, in particular, specifies that the cable ground shall be connected to the grounding system of the building, as close to the point of cable entry as practical. For additional antenna grounding information, see items 27 and 28 on page 4.

Child Safety

It Makes A Difference Where Your TV Stands

Congratulations on your purchase!

As you enjoy your new TV, keep these safety tips in mind:



The Issue

- If you are like most consumers, you have a TV in your home. Many homes, in fact, have more than one TV.
- The home theater entertainment experience is a growing trend, and larger TVs are popular purchases; however, they are not always supported on the proper TV stands.
 - Sometimes TVs are improperly secured or inappropriately situated on dressers, bookcases, shelves, desks, audio speakers, chests, or carts. As a result, TVs may fall over, causing unnecessary injury.



Toshiba Cares!

- The consumer electronics industry is committed to making home entertainment enjoyable and safe.
- The Consumer Electronics Association formed the Home Entertainment Support Safety Committee, comprised of TV and consumer electronics furniture manufacturers, to advocate children's safety and educate consumers and their families about television safety.

Tune Into Safety

- One size does NOT fit all! Use appropriate furniture large enough to support the weight of your TV (and other electronic components).
- Use appropriate angle braces, straps, and anchors to secure your furniture to the wall (but never screw anything directly into the TV).
- Carefully read and understand the other enclosed instructions for proper use of this product.
- Do not allow children to climb on or play with furniture and TVs.
- Avoid placing any item on top of your TV (such as a VCR, remote control, or toy) that a curious child may reach for.
- Remember that children can become excited while watching a program and can potentially push or pull a TV over.
- Share our safety message about this hidden hazard of the home with your family and friends. Thank you!



2500 Wilson Blvd.
Arlington, VA 22201 U.S.A.
Tel. 703-907-7600 Fax 703-907-7690
www.CE.org

CEA is the Sponsor, Producer and Manager of the International CES®

Important Safety Instructions

- 1) Read these instructions.
- 2) Keep these instructions.
- 3) Heed all warnings.
- 4) Follow all instructions.



- 5) Do not use this apparatus near water.
- 6) Clean only with a dry cloth.
- 7) Do not block any ventilation openings. Install in accordance with the manufacturer's instructions.

- 8) Do not install near any heat sources such as radiators, heat registers, stoves, or other apparatus (including amplifiers) that produce heat.

- 9) Do not defeat the safety purpose of the polarized or grounding type plug. A polarized plug has two blades with one wider than the other. A grounding type plug has two blades and a third grounding prong. The wide blade or the third prong are provided for your safety. If the provided plug does not fit into your outlet, consult an electrician for replacement of the obsolete outlet.

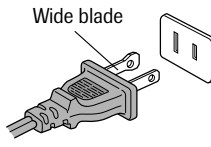

- 10) Protect the power cord from being walked on or pinched, particularly at plugs, convenience receptacles, and the point where it exits the apparatus.

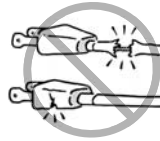

- 11) Only use attachments/accessories specified by the manufacturer.

- 12) Use only with the cart, stand, tripod, bracket, or table specified by the manufacturer, or sold with the apparatus. When a cart is used, use caution when moving the cart/apparatus combination to avoid injury from tip-over.



- 13) Unplug this apparatus during lightning storms or when unused for long periods of time.

- 14) Refer all servicing to qualified service personnel. Servicing is required when the apparatus has been damaged in any way, such as power-supply cord or plug is damaged, liquid has been spilled or objects have fallen into the apparatus, the apparatus has been exposed to rain or moisture, does not operate normally, or has been dropped.

- 14a) Item 14 does not apply to "Lamp unit replacement and care" on pages 119-121 of this manual.

- 14b) **CAUTION:** If the TV is dropped and the cabinet or enclosure surface has been damaged or the TV does not operate normally, take the following precautions:
 - ALWAYS turn off the TV and unplug the power cord to avoid possible electric shock or fire.
 - To prevent personal injury, never handle the damaged television.
 - ALWAYS contact a service technician to inspect the TV any time it has been damaged or dropped.

- 15) **CAUTION:** To reduce the risk of electric shock, do not use the polarized plug with an extension cord, receptacle, or other outlet unless the blades can be inserted completely to prevent blade exposure.

- 16) **WARNING:** This product contains a lamp to project the picture, and requires special safety precautions:

- See pages 117-119 for instructions on lamp unit replacement and care.
- **DO NOT attempt to service this product except as specified on pages 117-119.** The only user-serviceable item in this product is the lamp unit.

Installation, Care, and Service

Installation

Follow these recommendations and precautions and heed all warnings when installing your TV:

- 17) Never modify this equipment. Changes or modifications may void: a) the warranty, and b) the user's authority to operate this equipment under the rules of the Federal Communications Commission.

- 18) **DANGER: RISK OF SERIOUS PERSONAL INJURY, DEATH, OR EQUIPMENT DAMAGE!** Never place the TV on an unstable cart, stand, or table. The TV may fall, causing serious personal injury, death, or serious damage to the TV.



- 19) Never place or store the TV in direct sunlight; hot, humid areas; areas subject to excessive dust or vibration; or locations with temperatures at or below 41°F (5°C).

- 20) Always place the TV on the floor or a sturdy, level, stable surface that can support the weight of the unit.

- 21) Never expose the apparatus to dripping or splashing or place items such as vases, aquariums, any other item filled with liquid, or candles on top of the TV.

- 22) Always place the back of the television at least one (1) inch away from any vertical surface (such as a wall) to allow proper ventilation.

- 23) Never block or cover the slots or openings in the TV cabinet back, bottom, and sides. Never place the TV:
 - on a bed, sofa, rug, or similar surface;
 - too close to drapes, curtains, or walls; or
 - in a confined space such as a bookcase, built-in cabinet, or any other place with poor ventilation.

The slots and openings are provided to protect the TV from overheating and to help maintain reliable operation of the TV.

- 24) Never allow anything to rest on or roll over the power cord, and never place the TV where the power cord is subject to wear or abuse.

- 25) Never overload wall outlets and extension cords.

- 26) Always operate this equipment from a 120 VAC, 60 Hz power source only.

(continued on next page)

Installation (continued from previous page)

- 27) Always make sure the antenna system is properly grounded to provide adequate protection against voltage surges and built-up static charges (see Section 810 of the National Electric Code).

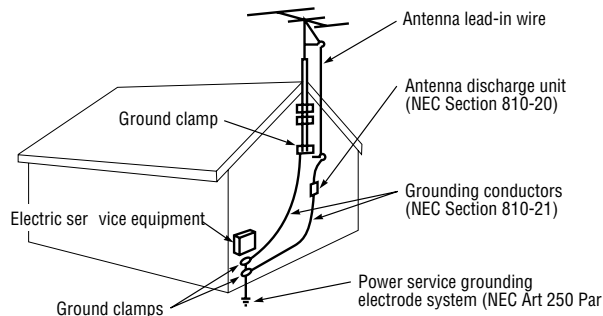

28)  **DANGER: RISK OF SERIOUS PERSONAL INJURY OR DEATH!**

- Use extreme care to make sure you are never in a position where your body (or any item you are in contact with, such as a ladder or screwdriver) can accidentally touch overhead power lines. Never locate the antenna near overhead power lines or other electrical circuits.
- Never attempt to install any of the following during lightning activity: a) an antenna system; or b) cables, wires, or any home theater component connected to an antenna or phone system.

Care

For better performance and safer operation of your TOSHIBA TV, follow these recommendations and precautions:

- 29) Always sit approximately 10–25 feet away from the TV and as directly in front of it as possible. The picture can appear dull if you sit too far to the left or right of the TV, or if sunlight or room lights reflect on the screen. Turn the TV off to check for reflections on the screen, and then remove the source of reflections while viewing the TV.

- 30) Always unplug the TV before cleaning. Never use liquid or aerosol cleaners. Clean only with a soft, dry cloth. Do not spray volatile compounds, such as insecticide, on the cabinet. This may discolor or damage the cabinet.

31)  **WARNING: RISK OF ELECTRIC SHOCK!**

Never spill liquids or push objects of any kind into the TV cabinet slots. 

- 32) If the air temperature rises suddenly (for example, when the TV is first delivered), condensation may form on the lenses. This can make the picture appear distorted or the color appear faded. If this happens, turn off the TV for 6 to 7 hours to allow the condensation to evaporate.

Care (continued from previous column)

- 33) For added protection of your TV from lightning and power surges, always unplug the power cord and disconnect the antenna from the TV if you leave the TV unattended or unused for long periods of time.

- 34) During normal use, the TV may make occasional snapping or popping sounds. This is normal, especially when the unit is being turned on or off. If these sounds become frequent or continuous, unplug the power cord and contact a Toshiba Authorized Service Center.

35) **Special care for DLP™ (digital light Processing) units:**

- Lamp-The in this product has a limited service life. The length of service life varies depending on product use or user settings. If you use the lamp beyond its service life:
- you may notice a reduction in the colors and/or brightness of the picture, at which time you should replace the lamp unit; and
- the strength of the quartz glass in the lamp will be reduced and the lamp may rupture. If the lamp ruptures, the TV will not operate until the lamp unit is replaced.

See “Lamp unit replacement and care” on pages 119–121.

- *Dispose of the used lamp unit by the approved method for your area.*

 *The lamp unit contains mercury. Disposal of mercury may be regulated due to environmental considerations. For disposal or recycling information, please contact your local authorities or the Electronic Industries Alliance (www.eiae.org).*

Service

36)  **WARNING: RISK OF ELECTRIC SHOCK!**

Never attempt to service the TV yourself, except as specified on pages 119–121. 

Opening and removing the covers may expose you to dangerous voltage or other hazards. Failure to follow this WARNING may result in death or serious injury. Refer all servicing not specified in this manual to a Toshiba Authorized Service Center.

- 37) If you have the TV serviced:

- Ask the service technician to use only replacement parts specified by the manufacturer.
- Upon completion of service, ask the service technician to perform routine safety checks to determine that the TV is in safe operating condition.

- 38) When the TV reaches the end of its useful life, ask a qualified service technician to properly dispose of the TV.

Note: *The lamp unit contains mercury. Disposal of mercury may be regulated due to environmental considerations. Dispose of the used lamp unit by the approved method for your area. For disposal or recycling information, please contact your local authorities or the Electronic Industries Alliance (www.eiae.org).*

Digital Light Processing, DLP™ and the DLP medallion are trademarks of Texas Instruments.

FCC Declaration of Conformity Compliance Statement (Part 15):

The **Toshiba 56MX195/62MX195/72MX195 DLP™ projection TV** complies with Part 15 of the FCC rules.

Operation is subject to the following two conditions: (1) this device may not cause harmful interference, and (2) this device must accept any interference that may cause undesired operation.

The party responsible for compliance to these rules is:
Toshiba America Consumer Products, L.L.C.
82 Totowa Rd. Wayne, NJ 07470.
Ph: (973) 628-8000

Note: This equipment has been tested and found to comply with the limits for a Class B digital device, pursuant to Part 15 of the FCC rules. These limits are designed to provide reasonable protection against harmful interference in a residential installation. This equipment generates, uses, and can radiate radio frequency energy and, if not installed and used in accordance with the instructions, may cause harmful interference to radio communications. However,

there is no guarantee that interference will not occur in a particular installation. If this equipment does cause harmful interference to radio or television reception, which can be determined by removing and applying power to the equipment, the user is encouraged to try to correct the interference by one or more of the following measures:

- Reorient or relocate the receiving antenna.
- Increase the separation between the equipment and the receiver.
- Connect the equipment into an outlet on a circuit different from that to which the receiver is connected.
- Consult the dealer or an experienced radio/TV technician for help.

CAUTION: Changes or modifications to this equipment not expressly approved by Toshiba could void the user's authority to operate this equipment.

Important notes about your DLP™ projection TV

- 1) The light source for this TV is a projection lamp unit with a limited service life. When the lamp wears out, the picture may become dark or black or the lamp may fail, at which time you must replace the lamp unit. See "Lamp unit replacement and care" on pages 119-121.
- 2) If you set the lamp mode to Low Power, each time you turn on the TV, the lamp will start out in High Bright mode but will switch to Low Power mode in approximately 1 minute. You will notice a change in screen brightness when this happens. This is normal and is not a malfunction. (See page 80 for details.)
- 3) Each time you turn on the TV, it may take several minutes to go from no picture to full picture brightness.
- 4) The display on this TV is manufactured using a chip that may contain up to 1.3 million microscopic mirrors. Each of these micromirrors measures less than one-fifth the width of a human hair and represents a single pixel on the television display. These micromirrors are mounted on tiny hinges that enable them to tilt either toward the light source (ON) or away from it (OFF). Occasionally, one of these mirrors may become inoperative, creating a light or dark pixel on the projection surface. This is a structural property of DLP™ projection TV technology, and is not a sign of malfunction. Such pixels are not visible when the picture is viewed from a normal viewing distance (see item 29 on page 4).
- 5) Depending on the media you are viewing, it is possible, although unlikely, that a limited number of viewers may see a "rainbow effect" on the screen, which can, in rare instances, result in eye fatigue. This is a rare occurrence related to technology of this type, and is not a sign of TV malfunction.
- 6) Always sit approximately 10-25 feet away from the TV and as directly in front of it as possible. The picture quality may be affected by your viewing position and length of viewing time. If you sit too closely to the TV for too long, you may suffer from eye fatigue. See item 29 on page 4.
- 7)  This TV contains several cooling fans to moderate the internal temperature. You may be able to hear the fans for several minutes after the TV is turned off. This is a function of the Quick Restart standby mode and is not a sign of TV malfunction. You can set the Quick Restart feature to stop the fans as soon as the TV is turned off. See "Setting the Quick Restart feature" on page 56.
- 8) The yellow and blue LED lights at the bottom center of the TV front indicate your TV's current status. If either light flashes, see "LED indications" on page 115 for details.
- 9) When you turn on the TV after connecting the power cord, "Now Booting..." will be displayed on the screen until the picture appears or the yellow LED will blink until the TV turns into standby mode.

Contents

Important Safety Information	2-4	Chapter 5: TV Guide On Screen™ setup	42
FCC Declaration of Conformity Compliance Statement		Setting up the TV Guide On Screen™ system	42
(Part 15):	5	TV Guide On Screen™ Reminder	45
Important notes about your DLP™ projection TV	5	Turning off the TV Guide On Screen™ automatic display feature	45
Chapter 1: Introduction	8	Chapter 6: Setting up your TV	46
Welcome to Toshiba	8	Selecting the menu language	46
Features of your new TV	8	Configuring the antenna input sources	46
Overview of steps for installing, setting up, and		Programming channels into the TV's channel memory	47
using your new TV	10	Programming channels automatically	47
Chapter 2: Connecting your TV	11	Manually adding and deleting channels in the channel memory	48
TV front and side panel controls and connections	11	Programming your favorite channels	49
TV back panel connections	12	Setting up and using TheaterNet™ on-screen device control	50
Overview of cable types	14	Setting up TheaterNet	50
About the connection illustrations	15	Using the TheaterNet control icons	51
Connecting a digital CableCARD™	15	TheaterNet IR device codes	52-54
Connecting a VCR and antenna or Cable TV (no Cable box)	16	Setting the AVHD device skip time	55
Connecting a camcorder	16	Setting the HDMI™ audio mode	55
Connecting a VCR and Cable box	17	Setting the time and date	55
Connecting a VCR and satellite receiver	18	Viewing the CableCARD™ menu	56
Connecting a DVD player with S-video, a VCR, and a Cable box	19	Setting the Quick Restart feature	56
Connecting a DVD player with ColorStream® (component video) and a VCR	20	Viewing the digital signal meter	57
Connecting two VCRs	21	Viewing the system status	57
Connecting an HDMI™ or a DVI device to the HDMI input	22	Chapter 7: Using the TV Guide On Screen™	
Connecting a digital audio system	23	interactive program guide	58
Connecting an analog audio system	23	Setting up the TV Guide On Screen™ system	58
Controlling infrared remote-controlled devices through the TV (IR pass-through)	24	Navigating the TV Guide On Screen™ system	59
Connecting IEEE1394 video devices	25	TV Guide On Screen™ remote control functions	59
Using analog-compatible IEEE1394 devices	25	Video Window	60
Supported signals	25	Panel Menus	60
Using TheaterNet™ on-screen device control	25	Info Box	61
Connecting an AVHD (external hard drive) or D-VHS digital recorder	26	TV Guide On Screen™ Icons	61
IEEE1394 device initialization	26	TV Guide On Screen™ Services	62
IEEE1394 device management	27	LISTINGS screen	62
G-LINK™ connection	28	SEARCH screen	63
Connecting a personal computer (PC)	29	RECORDINGS screen	65
Connecting a home network	30	SCHEDULE screen	66
Chapter 3: Using the remote control	31	Record features	66
Learning about the remote control	31	Remind features	68
Installing the remote control batteries	32	SETUP screen	70
Using the remote control MODE button to control your other devices	33	Change system settings	70
Remote Control functional key chart	34	Change channel display	70
Programming the remote control to operate your other devices	36	Change default options	71
Multi-brand remote control device codes	38		
Chapter 4: Menu layout and navigation	40		
Main menu layout	40		
Setup/Installation menu layout	41		
Navigating the menu system	41		

(Continued on next page)

Contents *(Continued from previous page)*

Chapter 8: Using the TV's features	72	Chapter 9: Using the Locks menu	97
Selecting the video input source to view	72	Entering the PIN code	97
Labeling the video input sources	73	If you cannot remember your PIN code	97
Tuning channels	74	Changing your PIN code	97
Using the ChannelBrowser™	74	Blocking TV programs and movies by rating (V-Chip)	98
Tuning your favorite channels	76	Blocking channels	99
Tuning to the next programmed channel	76	Unlocking programs temporarily	99
Tuning to a specific channel (programmed or unprogrammed)	76	Locking video inputs	99
Switching between two channels using Channel Return	76	Using the GameTimer™	100
Switching between two channels using SurfLock™	76	Using the control panel lock feature	100
Selecting the picture size	77	Chapter 10: Using the memory card JPEG picture viewer/ MP3 audio player	101
Natural picture size	77	Memory card specifications	101
TheaterWide 1 picture size	78	Using the JPEG picture viewer	102
TheaterWide 2 picture size	78	Using the MP3 audio player	103
TheaterWide 3 picture size	78	Memory card care and handling	104
Full picture size	78	Chapter 11: Connecting your TV to the Network	105
Scrolling the TheaterWide® picture	79	Setting up the Network connection	105
Using the auto aspect ratio feature	79	Set up the Email account	106
Selecting the cinema mode (480i signals only)	80	Timer recording via Email	107
Selecting the lamp mode	80	Using the audio player/picture viewer via network	108
Using the POP features	81	Chapter 12: Troubleshooting	112
Using the POP double-window feature	81	General troubleshooting	112
Switching the speaker audio (main or POP)	82	LED indications	115
POP double-window aspect ratio	82	TV Guide On Screen™ FAQs	116–118
Using the FREEZE feature	83	Chapter 13: Appendix	119
Using the favorite channel scan feature	83	Lamp unit replacement	119–121
Adjusting the picture	84	Specifications	122
Selecting the picture mode	84	Limited United States Warranty	123
Adjusting the picture quality	84	Limited Canada Warranty	124
Using the Color Management feature	85	Index	126, 127
Using CableClear® DNR (digital noise reduction)	86		
Selecting the color temperature	86		
Using MPEG Noise Reduction	87		
Using Dynamic Contrast	87		
Using the closed caption mode	88		
Advanced closed captions	88		
Digital closed captions	89		
Adjusting the audio	90		
Muting the sound	90		
Using the digital audio selector	90		
Selecting stereo/SAP broadcasts	90		
Adjusting the audio quality	91		
Using the sub-bass system (SBS)	91		
Using the StableSound® feature	91		
Using the SRS WOW™ surround sound feature	92		
Using the Dolby Virtual with SRS TruSurround sound feature	92		
Turning off the built-in speakers	93		
Selecting the optical audio output format	93		
Setting the On/Off Timer	94		
Setting the sleep timer	94		
Using the PC setting feature	95		
Displaying the Channel Banner	96		
Understanding the auto power off feature	96		
Understanding the last mode memory feature	96		
Using the gray level feature	96		

1 Introduction

Welcome to Toshiba

Thank you for purchasing this Toshiba TV, one of the innovative DLP™ projection TVs on the market. The goal of this manual is to guide you through setting up and operating your TV as quickly as possible.

See “Important notes about your DLP™ projection TV” on page 5.

- This manual applies to models 56MX195, 62MX195, and 72MX195. Before you start reading, check the model number on the back of your TV.
- Instructions in this manual are based on using the remote control. You also can use the controls on the TV control panel if they have the same name as those referred to on the remote control. (MENU on the side panel functions as ENTER when a menu is on-screen or when the TV Guide On Screen™ system is open.)
- The side panel and back panel provide terminals for connecting other equipment to your TV. See page 11 for TV control panel and side panel details. See page 12 for back panel details. See pages 14–30 for instructions on connecting other devices to your TV.
- **Please read all safety and operating instructions in this manual carefully, and keep this manual for future reference.**

Features of your new TV

The following are just a few of the many exciting features of your new Toshiba widescreen, integrated HD, DLP™ projection TV:



- **Integrated digital tuning (8VSB ATSC and QAM)** eliminates the need for a separate digital converter set-top box (in most cases).
- **TV Guide On Screen™** no-fee interactive program guide (Chapters 5 and 7).
- **Digital CableCARD™ slot** for viewing encrypted digital Cable TV programs (page 15).
- **Digital recording** by connecting a D-VHS digital recording device or a **Toshiba Symbio™ Audio/Video Hard Drive Recorder** to one of the IEEE1394 jacks. You can record high definition and standard definition material from either tuner (page 26).
- **Memory card slots** [SD Memory Card, MultiMediaCard, Memory Stick, CompactFlash, xD-PictureCard™] for viewing JPEG files as a “slide show” (page 102) and for playing MP3 files (page 103).
- **TheaterNet™** icons for on-screen control of external **IR** and **IEEE1394** devices (page 50).
- **Two IEEE1394 ports** for multi-device connection and control (page 25).
- **Two HDMI (DVI)** digital, high-definition multimedia interfaces (page 22).
- **Two sets of ColorStream® HD** high-resolution component video inputs (pages 18 and 20).
- **Dolby Digital*** (page 23) and **SRS WOW™** (page 92) audio technologies.
- **Digital Audio Out** optical audio connection (page 23).
- **CableClear® DNR** digital picture noise reduction (page 86).
- Double-window **POP** (page 81) and multi-window **Favorites** (page 83) features.
- **PC IN (Analog RGB)** computer terminal (page 29).
- **RJ-45 (THINC™)** port terminal (page 30).

Note: After you set up the TV Guide On Screen™ system (Chapter 5), the program guide opens automatically by default when you turn on the TV. You can turn off the automatic program guide (page 45) and instead press the TV GUIDE button on the remote control to manually open the program guide.

In the United States, TV Guide and other related marks are registered marks of Gemstar-TV Guide International, Inc. and/or one of its affiliates. In Canada, TV Guide is a registered mark of Transcontinental Inc., and is used under license by Gemstar-TV Guide International, Inc. The TV Guide On Screen system is manufactured under license from Gemstar-TV Guide International, Inc. and/or one of its affiliates. The TV Guide On Screen system is protected by one or more of the following issued United States patents 6,498,895; 6,418,556; 6,331,877; 6,239,794; 6,154,203; 5,940,073; 4,908,713; 4,751,578; 4,706,121.

GEMSTAR-TV GUIDE INTERNATIONAL INC. AND/OR ITS RELATED AFFILIATES ARE NOT IN ANY WAY LIABLE FOR THE ACCURACY OR AVAILABILITY OF THE PROGRAM SCHEDULE INFORMATION OR OTHER DATA IN THE TV GUIDE ON SCREEN SYSTEM AND CANNOT GUARANTEE SERVICE AVAILABILITY IN YOUR AREA. IN NO EVENT SHALL GEMSTAR-TV GUIDE INTERNATIONAL, INC. AND/OR ITS RELATED AFFILIATES BE LIABLE FOR ANY DAMAGES IN CONNECTION WITH THE ACCURACY OR AVAILABILITY OF THE PROGRAM SCHEDULE INFORMATION OR OTHER DATA IN THE TV GUIDE ON SCREEN SYSTEM.

Features of your new TV (continued)

- A recording device is required for recording. Over-the-air or cable access to stations carrying TV Guide On Screen™ data is required for the TV Guide On Screen™ system to operate. TV Guide On Screen™ data is not provided by Toshiba America Consumer Products, L.L.C. The provider of the data may elect to discontinue the service or it may cease to be (or never be) available in your area. In any of these circumstances, the TV Guide On Screen™ feature will not function.
- This product incorporates copyright protection technology that is protected by U.S. patents and other intellectual property rights. Use of this copyright protection technology must be authorized by Macrovision and is intended for home and other limited pay-per-view uses only, unless otherwise authorized by Macrovision. Reverse engineering or disassembly is prohibited.
- WOW, TruSurround, SRS and  symbol are trademarks of SRS Labs, Inc. WOW technology is incorporated under license from SRS Labs, Inc.
- *Manufactured under license from Dolby Laboratories. "Dolby", "Pro Logic" and the double-D symbol are trademarks of Dolby Laboratories.
- CableCARD™ is a trademark of Cable Television Laboratories, Inc.
-  is a trademark.
- MMC and MultiMediaCard are trademarks of Infineon Technologies AG and licensed to MMCA (MultiMediaCard Association).
- Memory Stick is a trademark of Sony Corporation.
- xD-Picture Card is a trademark of Fuji Photo Film Co., Ltd.
- Toshiba is an authorized licensee of the CompactFlash® and CF logo® registered trademarks.

Overview of steps for installing, setting up, and using your new TV

Follow these steps to set up your TV and begin using its many exciting features.

1. **Carefully read the important safety, installation, care, and service information on pages 2–5. Keep this manual for future reference.**
 2. **Observe the following when choosing a location for the TV:**
 - Place the TV on the floor or on the optional TV stand listed in the “Specifications” section (page 122).
- 

NOTICE OF POSSIBLE TV STAND INSTABILITY
DANGER: RISK OF SERIOUS PERSONAL INJURY OR DEATH! Use this TV only with the TOSHIBA TV stand listed in the “Specifications” section (page 122). Use with other stands may result in instability, causing possible injury or death.
3. **Do not plug in any power cords** until AFTER you have connected all cables and devices to your TV.
 4. **BEFORE connecting cables or devices to the TV, learn the functions** of the TV’s connections and controls (pages 11 and 12).
 5. **Connect your other electronic device(s) to the TV** (pages 15–30).
 6. **Connect the G-LINK™ cable** (either one of the enclosed IR blaster cables) from your VCR and/or Cable box (if applicable) to the G-LINK™ terminal so you can use the TV Guide On Screen™ features (applies to VCRs and cable boxes only). See page 28.
 7. **Install the batteries in the remote control** (page 33).
 8. **See “Learning about the remote control”** (page 31) **for an overview of the buttons on the remote control.**
 9. **Program the remote control to operate your other device(s)** (pages 33–39).
 10. **AFTER connecting all cables and devices, plug in the power cords** for your TV and other devices.
 11. **After you plug in the TV power cord, the yellow LED** (on the TV front) **will blink 3 times.** Wait about 30 seconds until the yellow LED lights continuously and then press POWER on the TV control panel or remote control.

See “LED indications” on page 115.
 12. **See “Menu layout and navigation” for a quick overview of navigating the TV’s menu system** (pages 40–41).
 13. **See Chapter 5 for details on setting up the TV Guide On Screen™ system** (if available in your area).
 14. **See Chapter 7 for details on using the TV Guide On Screen™ program guide** (if available in your area).
 15. **Program channels into the TV’s channel memory** (page 47).
 16. **Set up the TheaterNet™ on-screen device control feature** (if applicable to your particular home theater system components) (page 50).
 17. **For details on using the memory card JPEG picture viewer and MP3 audio player, see page 101.**
 18. **For details on using the TV’s features, see Chapter 8.**
 19. **For help, refer to the Troubleshooting Guide (Chapter 12).**
 20. **For technical specifications and warranty information, see Chapter 13.**
 21. **Enjoy your new TV!**

Note: If you sell or transfer this television to a third party, be sure to reset the PIN code as described on page 97 under the heading, “If you cannot remember your PIN code.”

2 Connecting your TV

TV front and side panel controls and connections

Front of TV

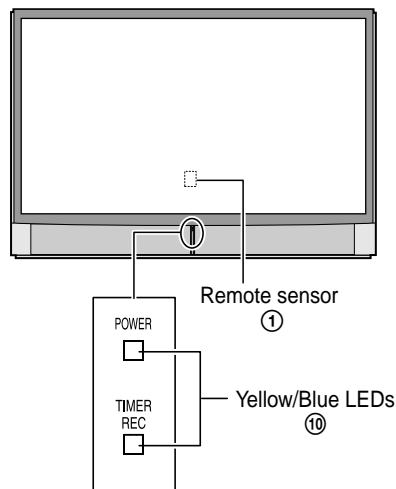

Right side of TV

Side panel

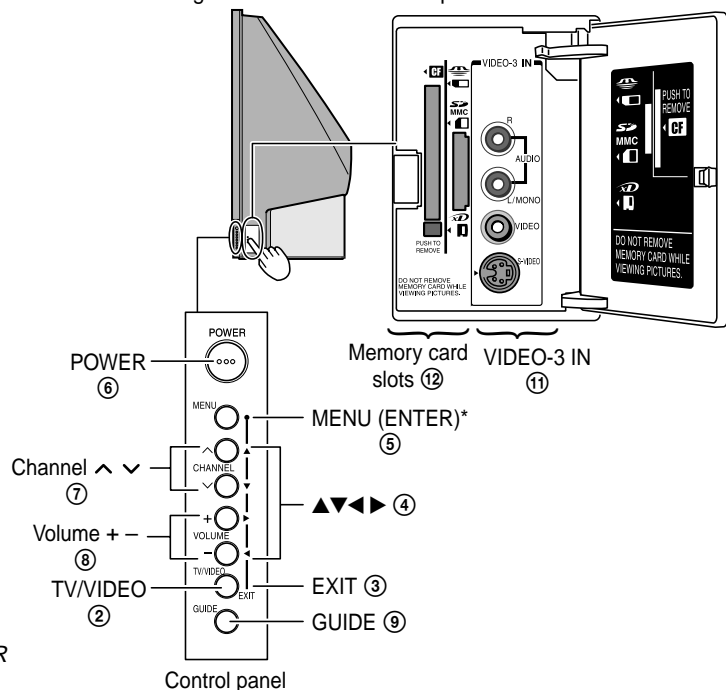

* The MENU button on the TV control panel functions as the ENTER button when a menu is on-screen.

- ① **Remote sensor** (behind the screen) — Point the remote control toward this area of the TV screen. See “Remote control effective range” on page 32.
- ② **TV/VIDEO** — Repeatedly press to change the source you are viewing (ANT 1, ANT 2, VIDEO 1, VIDEO 2, VIDEO 3, HDMI 1, HDMI 2, ColorStream HD1, ColorStream HD2, PC).
- ③ **EXIT** — Press to close an on-screen menu instantly.
- ④ **ARROWS ▲▼◀▶** — When a menu is on-screen, these buttons function as up/down/left/right menu navigation buttons.
- ⑤ **MENU (ENTER)** — Press to access the menu system (see page 40). When a menu is on-screen or the TV Guide On Screen™ program guide is open, the MENU button on the control panel functions as the ENTER button.
- ⑥ **POWER** — Press to turn the TV on and off. If the TV stops responding to the controls on the remote control or TV control panel and you cannot turn off the TV, press and hold the POWER button on the TV front panel for 5 or more seconds to reset the TV.
- ⑦ **CHANNEL ▲▼** — When no menu is on-screen, these buttons change the channel (programmed channels only; see page 47). When a menu is on-screen, these buttons function as up/down menu navigation buttons.
- ⑧ **VOLUME + -** — When no menu is on-screen, these buttons adjust the volume level. When a menu is on-screen, these buttons function as left/right menu navigation buttons.
- ⑨ **GUIDE** — Press to access the TV Guide On Screen™ program guide. (See page 58 for details on using the program guide.)
- ⑩ **Yellow and Blue LEDs**
When the yellow LED lights solid (not blinking), it indicates that recording is in progress.
When the blue LED lights solid (not blinking), it indicates that the TV power cord is plugged in.
See “LED indications” on page 115 for additional information.
- ⑪ **VIDEO-3** — The side panel A/V connections are referred to as “VIDEO 3” and include standard A/V connections plus optional S-video. (The VIDEO 1 and VIDEO 2 A/V connections are on the TV’s back panel; see page 12.)
- ⑫ **Memory card slots** — Insert a memory card into one of the memory card slots to view JPEG files (such as photos) as a “slide show” on your TV or listen to MP3 audio files (see page 101).

TV back panel connections

For an explanation of cable types, see page 14.

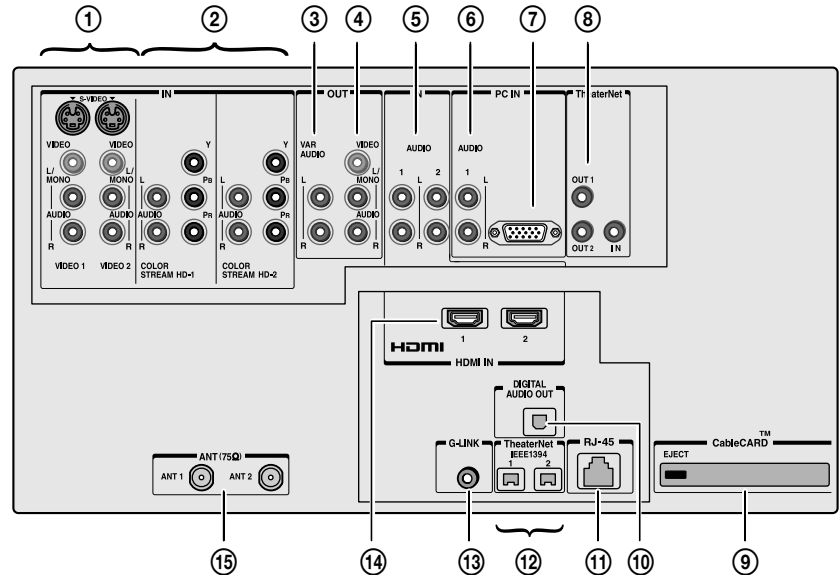
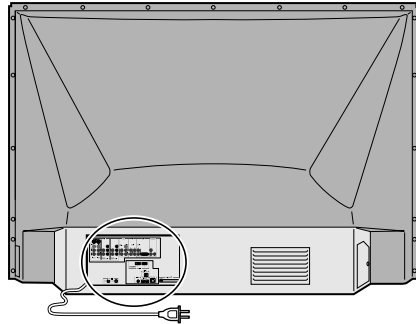

- ① **VIDEO 1 IN** and **VIDEO 2 IN** — Two sets of standard (composite) video and standard audio inputs plus optional S-video inputs for connecting devices with composite video or S-video output.
Note: Standard (composite) video and S-video cables carry only video information; separate audio cables are required for a complete connection.
- ② **ColorStream® HD-1** and **ColorStream® HD-2** — Two sets of ColorStream® high-definition component video and standard stereo audio inputs for connecting devices with component video output, such as a Toshiba DVD player with ColorStream®. See pages 15 and 17.
Note: Component video cables carry only video information; separate audio cables are required for a complete connection.
- ③ **Variable Audio OUT** — Standard analog audio outputs for connecting an analog amplifier with external speakers. See page 20.
- ④ **A/V OUT** — Standard composite video and analog audio outputs for connecting a VCR for editing and dubbing. See page 18 for details.
- ⑤ **HDMI Audio IN** — For use when connecting a DVI device with analog audio output to one of the HDMI inputs. See page 19. Also see item 10 below.
- ⑥ **PC AUDIO IN** — For use when connecting audio from a personal computer. See page 29.
- ⑦ **PC IN** — For use when connecting a personal computer. See page 29.
- ⑧ **TheaterNet™ (IR) OUT** — For controlling infrared remote-controlled devices through the TV. You can connect up to two devices with either one of the enclosed IR blaster cables, and then control the devices using the TV's IR pass-through or TheaterNet™ (on-screen device control) features. See pages 24 and 50.
TheaterNet™ (IR) IN — For connecting to IR OUT on other devices. See page 24.
- ⑨ **CableCARD™ slot** — For use with a digital security card and digital cable TV service (provided by your local cable operator) to view encrypted digital programming. See pages 12 and 51.
- ⑩ **Digital Audio OUT** — Optical audio output in Dolby Digital or PCM (pulse-code modulation) format for connecting an external Dolby Digital decoder, amplifier, A/V receiver, or home theater system with optical audio input. See page 20.

HDMI, the HDMI logo and High-Definition Multimedia Interface are trademarks or registered trademarks of HDMI Licensing LLC.

CableCARD is a trademark of Cable Television Laboratories, Inc.

TV back panel connections (continued)

- ⑪ **RJ-45 (THINC™)*** — For use when connecting a home network See page 30.
- ⑫ **(2) IEEE1394** — Two bi-directional digital IEEE1394 ports for connecting multiple devices with compressed digital video. Because these ports are bi-directional, they can be used for playback and recording. You can control your IEEE1394 devices using the TV's TheaterNet on-screen device control icons. See pages 21–24 and 46.

Note:

- IEEE1394 cable carries both audio and video information; separate audio cables are not required.

- ⑬ **G-LINK™** — For use with one of the enclosed IR blaster/G-LINK™ cables to enable the TV Guide On Screen™ recording features. See page 25.
- ⑭ **(2) HDMI™ IN 1 and 2** — Two High-Definition Multimedia Interface inputs receive digital audio and uncompressed digital video from an HDMI device or uncompressed digital video from a DVI device. See page 19.
- ⑮ **ANT-1 (CABLE) IN and ANT-2 IN** — Two inputs that support analog (NTSC) and digital (ATSC) off-air antenna signals and analog and digital (QAM) Cable TV signals.

Note: If you have an antenna only, connect it to ANT-1. If you have both cable TV and an antenna, connect the cable TV to ANT-1 and the antenna to ANT-2.

***THINC™ System (Toshiba Home Interactive Network Connection) -**

This RJ-45 Port allows select Toshiba Cinema Series TV's to connect to a Desktop or Laptop PC. This revolutionary Home Entertainment Networking System lets you access all of the MP3 audio files or JPEG pictures stored on your PC, using only the TV remote (without ever leaving the couch). If your TV is connected to your audio system, you can even use it to play back all of your MP3 audio files.

Overview of cable types

Note: Two dual-wand IR blaster/G-LINK™ cables are included with your TV. All other required cables, if not provided with your other devices, can be purchased at many electronics accessory suppliers.

- **Coaxial (F-type) cable** is used for connecting your antenna, cable TV service, and/or cable converter box to the ANT-1 and/or ANT-2 RF inputs on your TV.
- **Standard A/V cables (composite video)** usually come in sets of three, and are for use with video devices with standard audio and standard (composite) video output. These cables (and the related inputs on your TV) are typically color-coded according to use: yellow for video, red for stereo right audio, and white for stereo left (or mono) audio.
- **S-video cable** is for use with video devices with S-video output. Separate audio cables are required for a complete connection.

Note: An S-video cable provides better picture performance than a composite video cable. If you connect an S-video cable, be sure to disconnect the standard (composite) video cable or the picture performance will be unacceptable.
- **Component video cables** come in sets of three and are for use with video devices with component video output. (ColorStream® is Toshiba's brand of component video.) These cables are typically color-coded red, green, and blue. Separate audio cables are required for a complete connection.

Note: Component video cables provide better picture performance than a standard (composite) video or S-video cable.
- **HDMI cable** is for use with devices with HDMI (High-Definition Multimedia Interface) output. HDMI cable delivers digital audio and video in its native format. This cable carries both video and audio information; therefore, separate audio cables are not required for a complete HDMI device connection. See page 19 for further details.

Note: HDMI cable provides better picture performance than a standard (composite) video or S-video cable.
- **IEEE1394 cable** is for use with video devices with compressed digital video output that meet CEA specifications for IEEE1394. This cable carries both video and audio information; therefore, no separate audio cables are required for a complete connection. See pages 22–24.

Note:

 - The transmission capability of any IEEE1394 cable used with this TV must be S400 (400 Mbps maximum).
 - IEEE1394 cable provides better picture performance than a standard (composite) video or S-video cable.
- **Dual-wand IR blaster/G-LINK™ cable** is for use with video devices with IR (infrared) remote control. Two of these cables are included with your TV. One is for connection to the G-LINK™ terminal (page 25) to enable TV Guide On Screen™ recording features (Chapters 5 and 7). The other can be used with the TV's IR pass-through feature (page 21) and TheaterNet™ on-screen device control feature (page 45).

Note: The two IR blaster/G-LINK™ cables included with your TV have specific characteristics that allow them to work properly with this TV's IR OUT and G-LINK™ ports. **Never use other aftermarket IR blaster or G-LINK™ cables with this TV.** Other cables may not function properly and can cause damage. THIS TYPE OF DAMAGE IS NOT COVERED BY YOUR TOSHIBA WARRANTY.
- **Optical audio cable** is for connecting receivers with Dolby Digital or PCM (pulse-code modulation) optical audio input to the TV's DIGITAL AUDIO OUT terminal. See page 20.
- **RJ-45 (LAN) cable** is for used to connect to the Internet. See page 30.

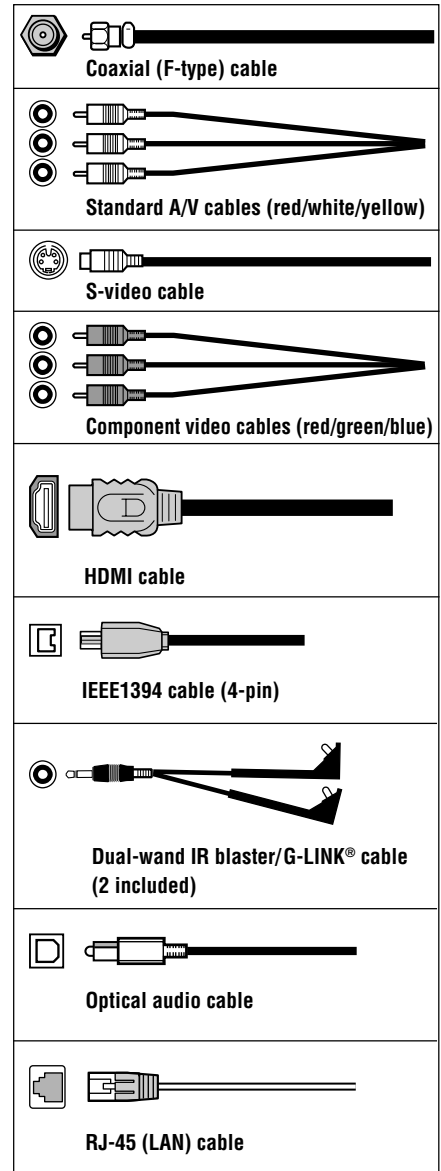

Note: Although your TV includes both HDMI and IEEE1394 connections, it may not operate with another device you have that includes such a connection. For example, the IEEE1394 ports are not intended to operate with current model Mini DV camcorders, and the HDMI input is not intended for connection to a computer. Copyright protection requirements may also prohibit or limit connectivity. See page 19 for details about the HDMI input. See pages 22–24 for details about the IEEE1394 ports.

About the connection illustrations

You can connect different types and brands of devices to your TV in several different configurations. The connection illustrations in this manual are representative of typical device connections only. The input/output terminals on your devices may differ from those illustrated herein. For details on connecting and using your specific devices, refer to each device's owner's manual.

Connecting a digital CableCARD™

This digital television is capable of receiving analog basic, digital basic, and digital premium cable television programming by direct connection to a cable system providing such programming.

A security card (such as a digital CableCARD™), provided by your cable operator, is required to view encrypted digital programming.

Certain advanced and interactive digital cable services (such as video-on-demand, a cable operator's enhanced program guide, and data-enhanced television services) will not work with the use of a CableCARD™ and may require the use of a separate set-top box from your cable operator.

For more information, call your local cable operator.

You will need:

- ▶ one digital CableCARD™ (contact your cable operator)
- ▶ digital cable subscription service (contact your cable operator)

TV back panel

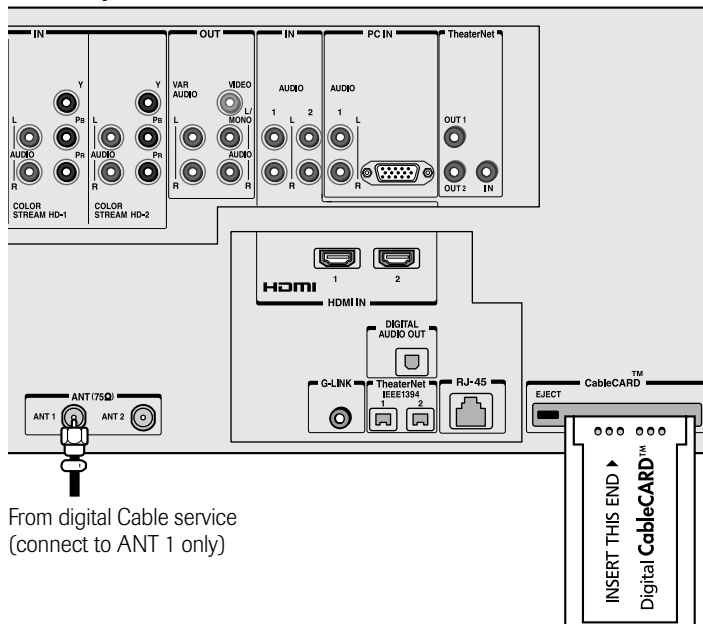

From digital Cable service
(connect to ANT 1 only)

This cable should be connected to ANT 1 terminal directly. If you connect the cable via a VCR, the TV may not receive the signals correctly.

CableCARD is a trademark of Cable Television Laboratories, Inc.

❑ To view encrypted digital channels:

1. Connect your digital Cable TV cable to ANT-1.
2. With the front of the CableCARD™ facing up, insert it into the CableCARD™ slot on the back of the TV (see illustration below left).
3. After the CableCARD™ is inserted, a CableCARD™ option appears in the Applications menu, with informational screens provided by your digital CableCARD™ service. See page 51 for additional information.

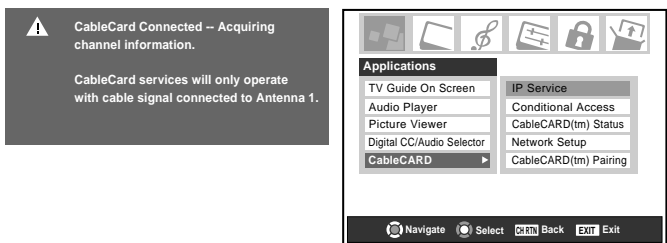

Note:

- Always use the EJECT button to remove the CableCARD™. Never remove the CableCARD™ by hand.
- Never insert any object or card (including, without limitation, a PCMCIA card) other than a CableCARD™ into the CableCARD™ slot.
- Always make sure the CableCARD™ is facing the correct direction.
- Connect the cable for your digital cable TV service to ANT-1 only.
- When using a CableCARD™, channel programming is unnecessary because the CableCARD™ automatically loads the cable channel list into the TV's channel memory (page 42).
- The CableCARD™ may take up to 5 minutes to "pair" with the TV and download channel information. CableCARD™ information and channels will not be available until this process is completed.

CableCARD™ technology, like all new and emerging technology, may from time to time experience compatibility issues due to the different ways in which television manufacturers and cable system operators implement the CableCARD™ specifications. Most issues can be easily resolved. In the event that you experience any performance-related CableCARD™ issues with your Toshiba television, please contact the following:

- **In the U.S.**, call TACP Consumer Solutions at (800) 631-3811 or visit <http://www.tacp.com/customersupport/contact.asp>.
- **In Canada**, call TCL Customer Service at 1-800-268-3404.

Connecting a VCR and antenna or Cable TV (no Cable box)

You will need:

- ▶ one signal splitter
- ▶ three coaxial cables
- ▶ two sets of standard A/V cables
 - For better picture performance, if your VCR has S-video, use an S-video cable (plus the audio cables) instead of the standard video cable. However, do not connect both types of video cables to VIDEO 1 (or VIDEO 2) at the same time or the picture performance will be unacceptable.
 - If you have a mono VCR, connect L/MONO on the TV to your VCR's audio out terminal using the white audio cable only.

To view the antenna or Cable signal:

Select the ANT 1 video input source on the TV.*

To view the VCR:

Turn ON the VCR. Select the VIDEO 1 video input source on the TV.*

To use the TV Guide On Screen™ recording features:

1. Connect the G-LINK™ cable according to the instructions on page 25.
2. Make sure the VCR is connected to the A/V OUT terminals on the TV (see illustration).
3. Set the VCR to the appropriate line input (refer to your VCR owner's manual for details), and then turn OFF the VCR.
4. See Chapter 5 for details on setting up the TV Guide On Screen™ system.
5. See Chapter 7 for details on using the TV Guide On Screen™ system.

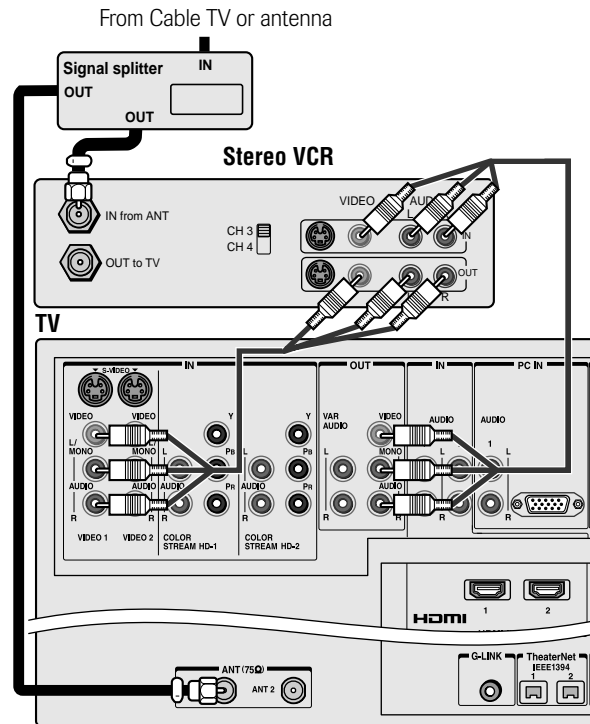

Note: The VIDEO/AUDIO OUT terminals output signals from the ANT 1, ANT 2, VIDEO 1, VIDEO 2, and VIDEO 3 terminals when the appropriate input mode is selected.

The unauthorized recording, use, distribution, or revision of television programs, videotapes, DVDs, and other materials is prohibited under the Copyright Laws of the United States and other countries, and may subject you to civil and criminal liability.

Connecting a camcorder

You will need:

- ▶ one set of standard A/V cables
 - For better picture performance, if your camcorder has S-video, use an S-video cable (plus the audio cables) instead of the standard video cable. Do not connect both an S-video cable and a standard video cable to VIDEO 3 at the same time or the picture performance will be unacceptable.

To view the camcorder video:

Select the VIDEO 3 video input source on the TV.*

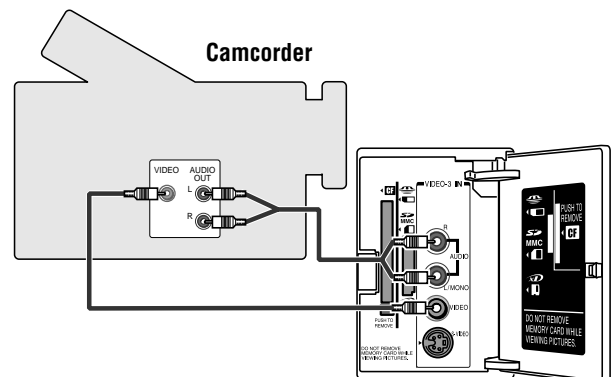

VIDEO 3 inputs on TV right side panel

* To select the video input source, press INPUT on the remote control (see page 67). To program the TV remote control to operate other devices, see Chapter 3.

Connecting a VCR and Cable box

You will need:

- ▶ one signal splitter
- ▶ five coaxial cables
- ▶ two sets of standard A/V cables
 - For better picture performance from your VCR: If your VCR has S-video, connect an S-video cable (plus the audio cables) instead of the standard video cable. Do not connect an S-video cable and a standard video cable to VIDEO 1 (or VIDEO 2) at the same time or the picture performance will be unacceptable.
 - If you have a mono VCR, connect L/MONO on the TV to your VCR's audio out terminal using the white audio cable only.
 - When you use a Cable box, you may not be able to use the remote control to program or access certain features on the TV.

To view basic Cable channels and use the TV's features:

Select the ANT 1 video input source on the TV.* Use the TV controls (control panel or remote control) to change channels and access the TV's features.

To view basic and premium Cable channels:

Turn OFF the VCR. Select the ANT 2 video input source on the TV.* Tune the TV to channel 3 or 4 (whichever channel the Cable box output is set to). Use the Cable box controls to change channels.

To view the VCR:

Turn ON the VCR. Select the VIDEO 1 video input source on the TV.*

Note: A VIDEO 1 connection with an S-Video cable (instead of a standard video cable) will provide better picture performance (as mentioned in the first bulleted item at the top of this page).

* To select the video input source, press INPUT on the remote control (see page 67). To program the TV remote control to operate other devices, see Chapter 3.

The unauthorized recording, use, distribution, or revision of television programs, videotapes, DVDs, and other materials is prohibited under the Copyright Laws of the United States and other countries, and may subject you to civil and criminal liability.

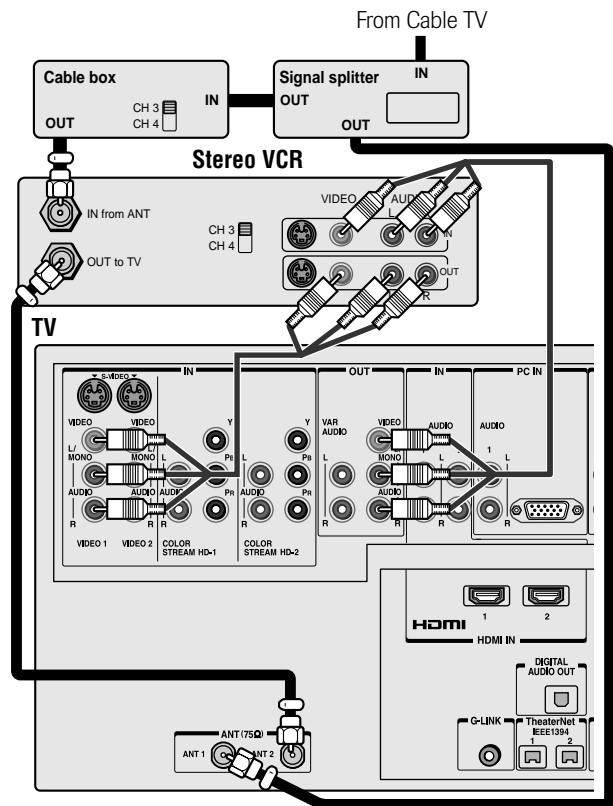

Note: The VIDEO/AUDIO OUT terminals output signals from the ANT 1, ANT 2, VIDEO 1, VIDEO 2, and VIDEO 3 terminals when the appropriate input mode is selected.

To enable the TV Guide On Screen™ system to work with your cable box and to use the TV Guide On Screen™ recording features:

1. Connect the G-LINK™ cable according to the instructions on page 25.
2. Make sure the VCR is connected to the A/V OUT terminals on the TV (see illustration).
3. Set the VCR to the appropriate line input (refer to your VCR owner's manual for details), and then turn OFF the VCR.
4. See Chapter 5 for details on setting up the TV Guide On Screen™ system.
5. See Chapter 7 for details on using the TV Guide On Screen™ system.

Connecting a VCR and satellite receiver

You will need:

- ▶ one signal splitter
- ▶ four coaxial cables
- ▶ one set of component video cables (if your satellite receiver does not have component video, connect the standard A/V cables only)
- ▶ one pair of standard audio cables
- ▶ three sets of standard A/V cables
 - For better picture performance, if your satellite receiver and VCR have S-video, connect S-video cables (plus the audio cables) instead of the standard video cables. Do not connect both types of video cable to VIDEO 1 (or VIDEO 2) at the same time or the picture performance will be unacceptable.
 - If you have a mono VCR, connect L/MONO on the TV (VIDEO 1) to your VCR's AUDIO OUT terminal using the white audio cable only.

To view satellite programs using the component video connections:

Select the ColorStream HD-1 video input source on the TV.*

To view satellite programs using the standard video connections or to record satellite programs:

Turn on all three devices. Set the VCR to the appropriate line input (refer to your VCR owner's manual for details). Select the VIDEO 2 video input source on the TV.*

To view the VCR or view and record antenna channels:

Turn ON the VCR. Tune the VCR to the channel you want to watch. Select the VIDEO 1 video input source on the TV.*

* To select the video input source, press INPUT on the remote control (see page 67). To program the TV remote control to operate other devices, see Chapter 3.

The unauthorized recording, use, distribution, or revision of television programs, videotapes, DVDs, and other materials is prohibited under the Copyright Laws of the United States and other countries, and may subject you to civil and criminal liability.

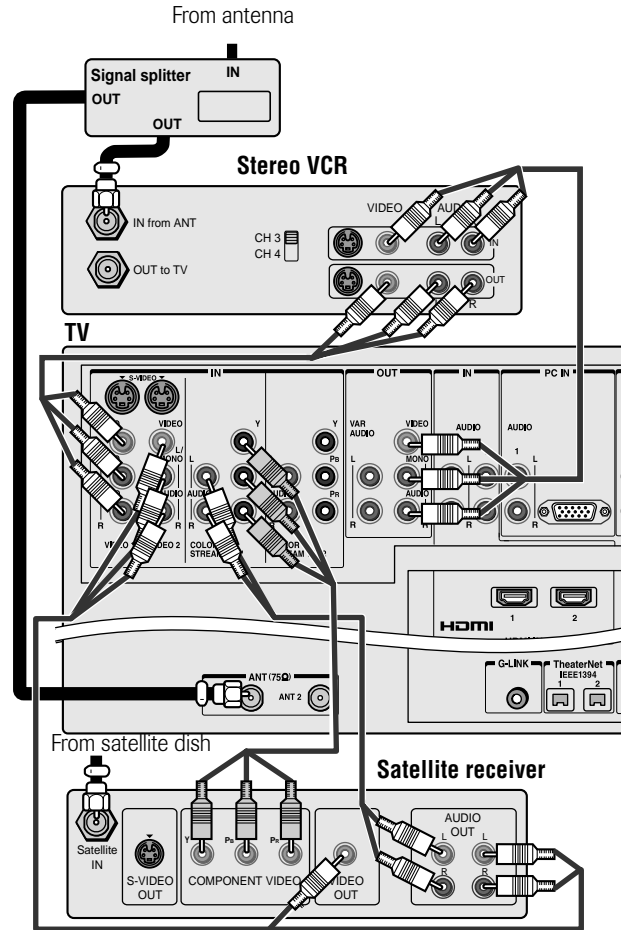

Note: The VIDEO/AUDIO OUT terminals output signals from the ANT 1, ANT 2, VIDEO 1, VIDEO 2, and VIDEO 3 terminals when the appropriate input mode is selected.

To use the TV Guide On Screen™ recording features:

1. Connect the G-LINK™ cable according to the instructions on page 25.
2. Make sure the VCR is connected to the A/V OUT terminals on the TV (see illustration).
3. Set the VCR to the appropriate line input (refer to your VCR owner's manual for details), and then turn OFF the VCR.
4. See Chapter 5 for details on setting up the TV Guide On Screen™ system.
5. See Chapter 7 for details on using the TV Guide On Screen™ system.

Note: The TV Guide On Screen™ system does not receive program listings from or for any satellite service.

Connecting a DVD player with S-video, a VCR, and a Cable box

You will need:

- ▶ one signal splitter
- ▶ five coaxial cables
- ▶ two sets of standard A/V cables

Note: If you have a mono VCR, connect L/MONO on the TV (VIDEO 1) to your VCR's audio out terminal using the white audio cable only.

- ▶ one S-video cable
- ▶ one pair of standard audio cables

Note:

- If your DVD player does not have S-video, use a standard video cable instead. Do not connect an S-video cable and a standard video cable to VIDEO 1 (or VIDEO 2) at the same time or the picture performance will be unacceptable.
- If your DVD player has component video, see page 17.
- Do not connect the DVD player and VCR to the same set of A/V inputs on the TV. (See the illustration, which shows the VCR connected to VIDEO 1 on the TV, and the DVD player connected to VIDEO 2.)

To view basic channels and access the TV's features:

Select the ANT 1 video input source.* Use the TV controls to change channels and access the TV's features.

To view premium Cable channels:

Turn OFF the VCR. Select the ANT 2 video input source on the TV.* Tune the TV to channel 3 or 4 (whichever channel the Cable box output is set to). Use the Cable box controls to change channels.

Note: When you use a Cable box, you may not be able to use the remote control to program or access certain features on the TV.

To view the DVD player:

Turn ON the DVD player. Select the VIDEO 2 video input source on the TV.*

To view the VCR:

Turn ON the VCR. Select the VIDEO 1 video input source on the TV.*

* To select the video input source, press INPUT on the remote control (see page 67). To program the TV remote control to operate other devices, see Chapter 3.

The unauthorized recording, use, distribution, or revision of television programs, videotapes, DVDs, and other materials is prohibited under the Copyright Laws of the United States and other countries, and may subject you to civil and criminal liability.

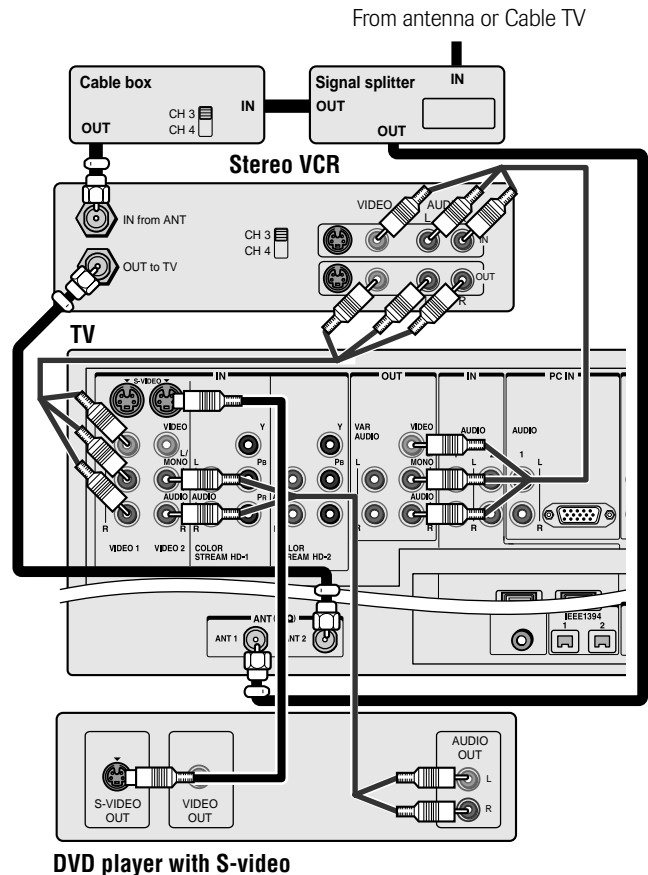

Note: The VIDEO/AUDIO OUT terminals output signals from the ANT 1, ANT 2, VIDEO 1, VIDEO 2, and VIDEO 3 terminals when the appropriate input mode is selected.

To enable the TV Guide On Screen™ system to work with your cable box and to use the TV Guide On Screen™ recording features:

1. Connect the G-LINK™ cable according to the instructions on page 25.
2. Make sure the VCR is connected to the A/V OUT terminals on the TV (see illustration).
3. Set the VCR to the appropriate line input (refer to your VCR owner's manual for details), and then turn OFF the VCR.
4. See Chapter 5 for details on setting up the TV Guide On Screen™ system.
5. See Chapter 7 for details on using the TV Guide On Screen™ system.

Connecting a DVD player with ColorStream® (component video) and a VCR

Your TV has ColorStream® (component video) inputs.

You will need:

- ▶ one signal splitter
- ▶ three coaxial cables
- ▶ two sets of standard A/V cables
 - For better picture performance, if your VCR has S-video, use an S-video cable (plus the audio cables) instead of the standard video cable. However, do not connect both types of video cable to VIDEO 1 (or VIDEO 2) at the same time or the picture performance will be unacceptable.
 - If you have a mono VCR, connect L/MONO on the TV (VIDEO 1) to your VCR's audio out terminal using the white audio cable only.
- ▶ one pair of standard audio cables
- ▶ one set of component video cables
 - You can connect the component video cables (plus audio cables) from the DVD player to either set of ColorStream terminals on the TV (HD-1 or HD-2). The ColorStream HD-1 and HD-2 terminals can be used with Progressive (480p, 720p) and Interlaced (480i, 1080i) scan systems. A 1080i signal will provide the best picture performance.
 - If your DVD player does not have component video, see page 16. If your DVD player has HDMI video, see page 19.

To view antenna or Cable channels:

Select the ANT 1 video input source on the TV.*

To view the DVD player:

Turn ON the DVD player. Select the ColorStream HD-1 video input source on the TV.*

To view the VCR:

Turn ON the VCR. Select the VIDEO 1 video input source on the TV.*

To record a TV program while watching a DVD:

Turn ON the VCR. Tune the VCR to the channel to record. Select the ColorStream HD-1 video input source on the TV* to view the DVD.

* To select the video input source, press INPUT on the remote control (see page 67). To program the TV remote control to operate other devices, see Chapter 3.

The unauthorized recording, use, distribution, or revision of television programs, videotapes, DVDs, and other materials is prohibited under the Copyright Laws of the United States and other countries, and may subject you to civil and criminal liability.

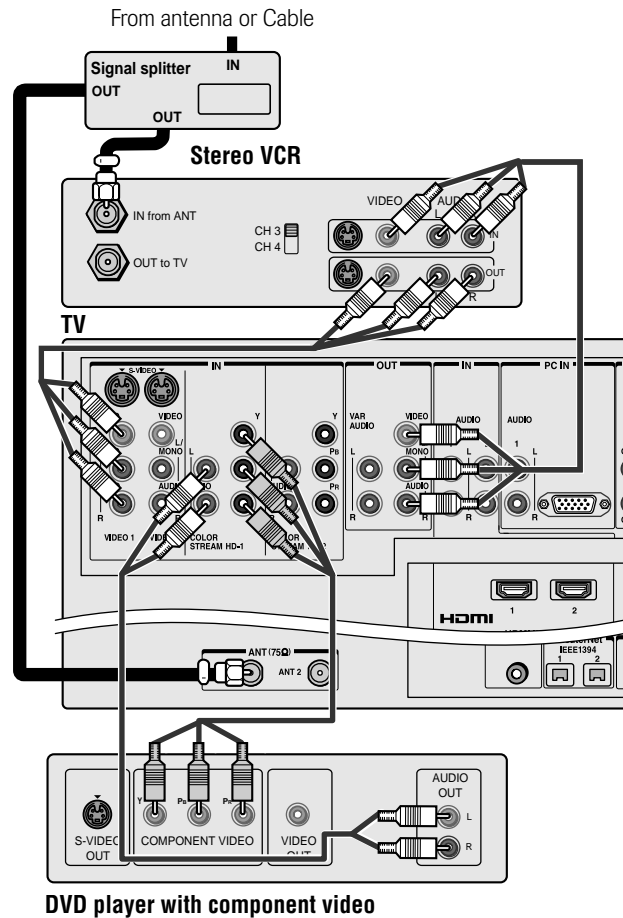

Note: The VIDEO/AUDIO OUT terminals output signals from the ANT 1, ANT 2, VIDEO 1, VIDEO 2, and VIDEO 3 terminals when the appropriate input mode is selected.

To use the TV Guide On Screen™ recording features:

1. Connect the G-LINK™ cable according to the instructions on page 25.
2. Make sure the VCR is connected to the A/V OUT terminals on the TV (see illustration).
3. Set the VCR to the appropriate line input (refer to your VCR owner's manual for details), and then turn OFF the VCR.
4. See Chapter 5 for details on setting up the TV Guide On Screen™ system.
5. See Chapter 7 for details on using the TV Guide On Screen™ system.

Connecting two VCRs

You will need:

- ▶ one signal splitter
- ▶ three coaxial cables
- ▶ two sets of standard A/V cables
 - For better picture performance, if VCR 1 has S-video, use an S-video cable (plus the audio cables) instead of the standard video cable. However, do not connect both types of video cable to VIDEO 1 (or VIDEO 2) at the same time or the picture performance will be unacceptable.
 - If VCR 1 has mono audio, connect L/MONO on the TV (VIDEO 1) to the audio out terminal on VCR 1 using the white audio cable only.
 - Do not connect the same VCR to the output and input terminals on the TV at the same time.

To view the antenna or Cable signal:

Select the ANT-1 video input source on the TV.*

To view VCR 1:

Turn ON VCR 1. Select the VIDEO 1 video input source on the TV.*

To dub or edit from VCR 1 to VCR 2:

Turn ON both VCRs. Set VCR 2 to the appropriate line input (refer to your VCR owner's manual for details). Select the VIDEO 1 video input source on the TV.*

Note:

- If you have a Cable box, connect the Cable box and splitter to VCR1 as shown on page 14.
- The VIDEO OUT signal incorporates Macrovision® copyright protection technology, which may prevent you from recording certain copy-restricted video materials.***

* To select the video input source, press INPUT on the remote control (see page 67). To program the TV remote control to operate other devices, see Chapter 3.

** Do not connect the unit through a VCR. Video signals fed through VCRs may be affected by copyright protection systems and the picture will be distorted on the TV.

*** This product incorporates copyright protection technology that is protected by U.S. patents and other intellectual property rights. Use of this copyright protection technology must be authorized by Macrovision and is intended for home and other limited pay-per-view uses only, unless otherwise authorized by Macrovision. Reverse engineering or disassembly is prohibited. Macrovision is a registered trademark of Macrovision Corporation.

The unauthorized recording, use, distribution, or revision of television programs, videotapes, DVDs, and other materials is prohibited under the Copyright Laws of the United States and other countries, and may subject you to civil and criminal liability.

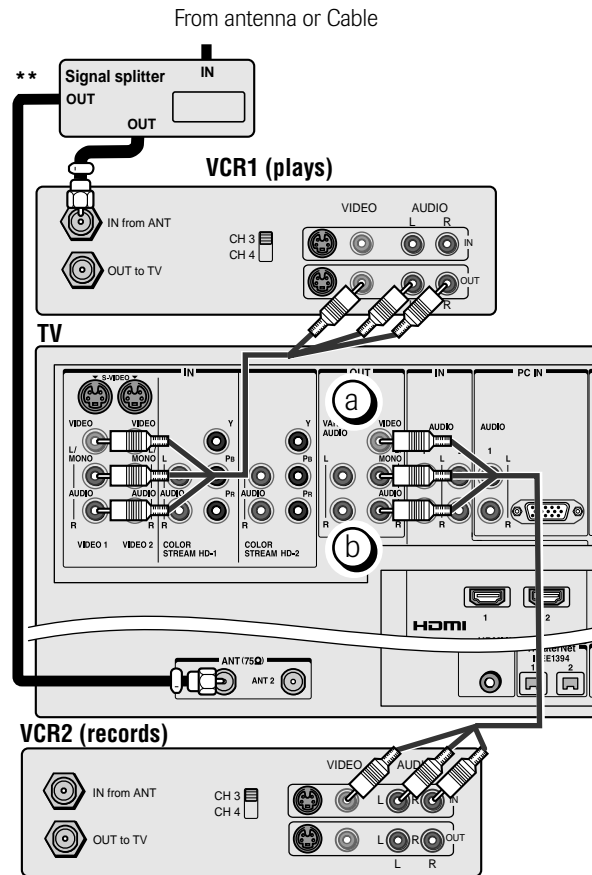

(a) The VIDEO OUT terminal does not output the POP picture.

(b) When POP mode is active, the AUDIO OUT terminals output the sound of the active window (main or POP). For additional information, see "Notes about recording" on page 76.

Note: The VIDEO/AUDIO OUT terminals output signals from the ANT 1, ANT 2, VIDEO 1, VIDEO 2, and VIDEO 3 terminals when the appropriate input mode is selected.

To use the TV Guide On Screen™ recording features:

1. Connect the G-LINK™ cable according to the instructions on page 25.
2. Make sure the VCR is connected to the A/V OUT terminals on the TV (see illustration).
3. Set the VCR to the appropriate line input (refer to your VCR owner's manual for details), and then turn OFF the VCR.
4. See Chapter 5 for details on setting up the TV Guide On Screen™ system.
5. See Chapter 7 for details on using the TV Guide On Screen™ system.

Connecting an HDMI™ or a DVI device to the HDMI input

The HDMI^[1] input on your TV receives digital audio and uncompressed digital video from an HDMI device or uncompressed digital video from a DVI^[2] device.

This input is designed to accept HDCP^[3] program material in digital form from EIA/CEA-861/861B-compliant^[4] consumer electronic devices (such as a set-top box or DVD player with HDMI or DVI output).

The HDMI input is designed for best performance with 720p signals but will also accept and display 1080i, 480i, and 480p signals.



NOTE: NEVER CONNECT THIS TV TO A PERSONAL COMPUTER (PC). THIS TV IS NOT INTENDED FOR USE WITH A PC.

To connect an HDMI device, you will need:

- one HDMI cable (type A connector) per HDMI device

For proper operation, it is recommended that you use as short an HDMI cable as possible. You should not encounter difficulty if you use an HDMI cable shorter than 16.4 ft (5m).

HDMI cable transfers both video and audio. Separate analog audio cables are not required (see illustration below). Some CDVs (video CDs) may not output digital audio signals. In that case, you may hear sound by connecting analog audio cables.

See "Setting the HDMI audio mode" on page 50.

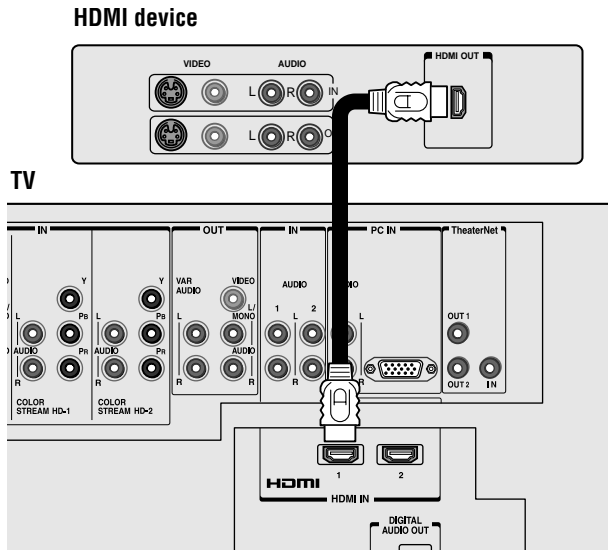

[1] HDMI = High-Definition Multimedia Interface.

[2] DVI = Digital Video Interface.

[3] HDCP = High-bandwidth Digital Content Protection.

[4] EIA/CEA-861/861B compliance covers the transmission of uncompressed digital video with high-bandwidth digital content protection, which is being standardized for reception of high-definition video signals. Because this is an evolving technology, it is possible that some devices may not operate properly with the TV.

Note: To ensure that the HDMI or DVI device is reset properly, it is recommended that you follow these procedures:

- When turning on your electronic components, **turn on the TV first**, and then the HDMI or DVI device.
- When turning off your electronic components, **turn off the HDMI or DVI device first**, and then the TV.

To connect a DVI device, you will need:

- one HDMI-to-DVI adapter cable (HDMI type A connector) per DVI device

For proper operation, the length of an HDMI-to-DVI adapter cable should not exceed 9.8 ft (3m). The recommended length is 6.6 ft (2m).

- one pair of standard analog audio cables per DVI device

An HDMI-to-DVI adapter cable transfers video only. Separate analog audio cables are required (see illustration below).

See "Setting the HDMI audio mode" on page 50.

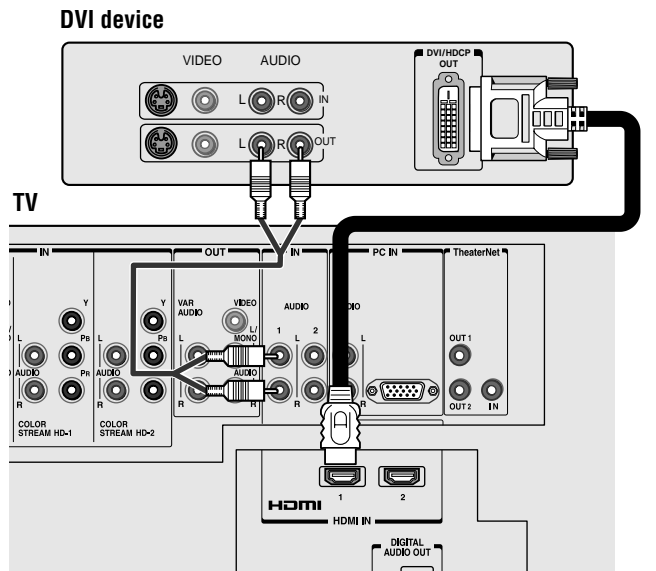

HDMI, the HDMI logo and High-Definition Multimedia Interface are trademarks or registered trademarks of HDMI Licensing LLC.

Connecting a digital audio system

The TV's DIGITAL AUDIO OUT terminal outputs a Dolby Digital  or 2-channel down-mixed PCM (pulse-code modulation) signal for use with an external Dolby Digital decoder or other external audio system with optical audio input.

You will need:

- ▶ one optical audio cable (Use an optical audio cable that has the larger "TosLink" connector and not the smaller "mini-optical" connector.)

To control the audio:

Turn on the TV and the digital audio device.

Press MENU on the TV's remote control and open the AUDIO menu.

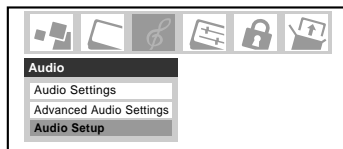

Highlight Audio Setup and press ENTER.

In the Optical Output Format field, select either Dolby Digital or PCM, depending on your device (see "Selecting the optical audio output format" on page 86).

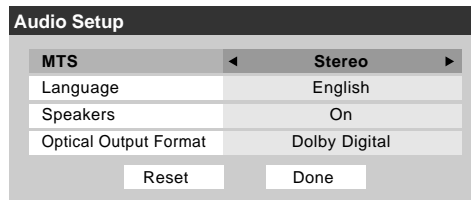

Turn off the TV's built-in speakers in the same Audio Setup menu (above). Also see "Turning off the built-in speakers" on page 86.

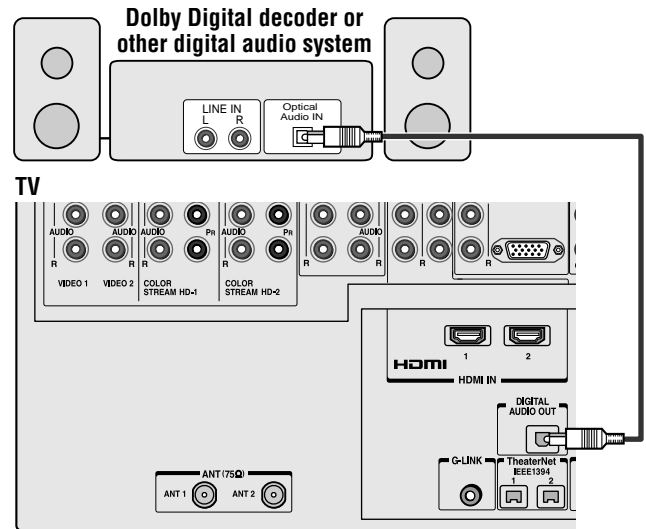

Note:

- Some audio systems may not be compatible with Dolby Digital bitstream signals. Older audio systems that are not compatible with standard optical out signals may not work properly, creating a high noise level that may damage speakers or headphones. **THIS DAMAGE IS NOT COVERED BY YOUR WARRANTY.**
- The DIGITAL AUDIO OUT terminal outputs signals only when receiving digital broadcasts with the TV in single-window mode.
- The DIGITAL AUDIO OUT terminal may not output some digital audio sources because of copy restrictions.

Connecting an analog audio system

This connection allows you to use external speakers with an external audio amplifier to adjust the sound level.

You will need:

- ▶ one pair of standard audio cables

To control the audio:

Turn on the TV and the stereo amplifier.

Turn off the TV's built-in speakers (see "Turning off the built-in speakers" on page 86).

Note: To hear sound when using an external audio amplifier, the volume of both the TV and the amplifier must be set to a reasonable listening level.

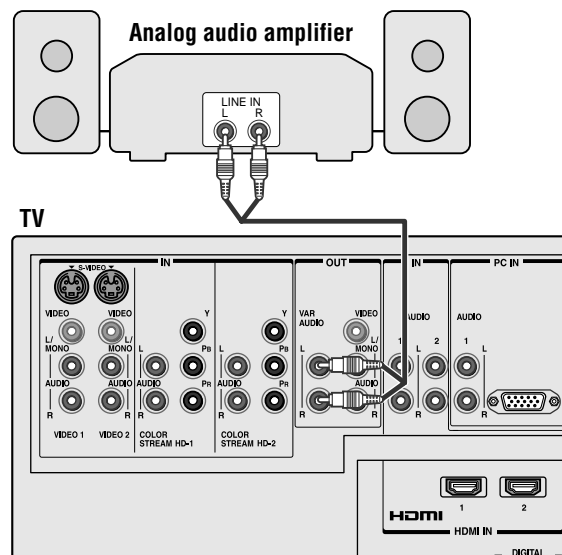

Controlling infrared remote-controlled devices through the TV (IR pass-through)

You can use the TV's IR OUT terminal (infrared pass-through) to remotely operate (through the TV) many infrared remote-controlled devices (such as a Toshiba infrared remote-controlled VCR or DVD player) enclosed within an entertainment center or similar cabinet. Without the IR OUT connection, the device typically would need to be visible to operate it remotely.

You will need:

- ▶ one dual-wand IR blaster cable (included with your TV)
- ▶ other audio/video cables as required to connect the device(s) to the TV (see pages 13–20)

To connect the IR blaster cable:

1. Locate the infrared sensor on the front of your device. This sensor is marked on some devices.*
2. Align one of the IR blaster cable's wands about 1 inch away from the infrared sensor on the front of the device and attach it using double-sided mounting tape. If you have a second device, attach the second wand in a similar manner. (See illustration at right.)

Note: If you do not have a second device, coil the second wand with a rubber band and leave it behind the TV.

3. Plug the IR blaster cable's plug into one of the TV's TheaterNet OUT terminals.

To control the device(s):

Point the TV remote control (programmed to operate the device; see Chapter 3) or the device's remote control at the front of the TV and press the button for the desired function. The signal passes from the remote control through the TV to the device via the IR blaster cable.

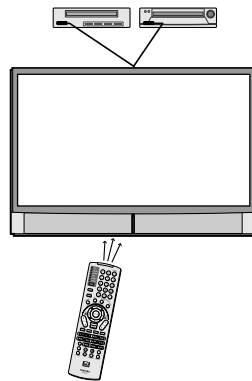

Note:

- If you use the device's remote control to operate the device, you also will need to use the TV's remote control to operate the TV.
- For additional control options, see "TheaterNet on-screen device control" at right.

*If you cannot locate the device's infrared sensor:

1. Turn OFF the device.
2. Starting at the lower left corner of the device, place the end of the device's remote control (with the infrared emitter) so it touches the front of the device and press POWER. (Do not use the TV's remote control for this step.)
3. If the device turns on, the point at which the remote control touched the device is the location of the sensor.
4. If the device does not turn on, move the remote control slightly to the right and press POWER again.
5. Repeat step 4 until you locate the device's infrared sensor.

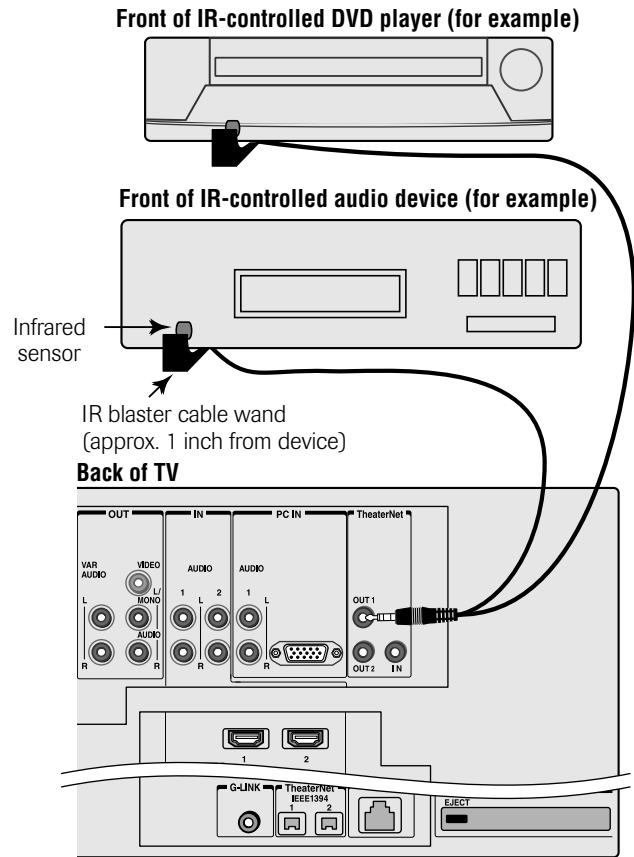

Using the TheaterNet IN:

Connect a device (DVD, etc) to TheaterNet IN on the back of the TV to allow IR signals to control the TV. See the instructions of the device for details.

TheaterNet™ on-screen device control

For additional control options for your home theater system, set up the TheaterNet on-screen device control feature. You can use this feature to control many IR remote-controlled devices and IEEE1394 devices using the on-screen control icons.

See pages 45–49 for details on setting up and using TheaterNet.

See pages 22–24 for details on connecting IEEE1394 devices.

Note: The TheaterNet on-screen icons are the only device functions available when the icons are on-screen. To access other device functions, close the TheaterNet icon window.

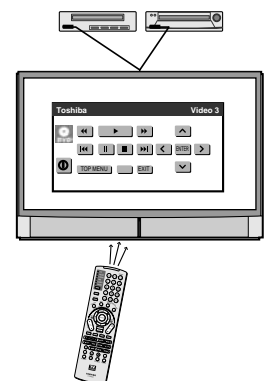

Connecting IEEE1394 video devices

You can use the two bi-directional IEEE1394 ports on the back of your TV to connect digital video devices that meet CEA specifications for IEEE1394.

Because these ports are bi-directional, they can be used for both playback and recording.

- Because IEEE1394 is an evolving technology, it is possible that some or all of the connectivity features of a device you connect to the TV through the IEEE1394 ports may not operate. You should confirm that the devices you want to use with the IEEE1394 ports will operate with those ports.
- This TV does not support all possible IEEE1394 signal types. For information on signals supported by the IEEE1394 ports, see “Supported signals” at right.
- IEEE1394 cable carries both audio and video information; separate audio cables are not required.

You will need:

- ▶ one (or two) IEEE1394 cables
 - Note:** The transmission capability of IEEE1394 cable used with this TV must be S400 (400 Mbps maximum).
- ▶ additional A/V cables if your device is analog-compatible (see “Using analog-compatible IEEE1394 devices” below).

TV back panel

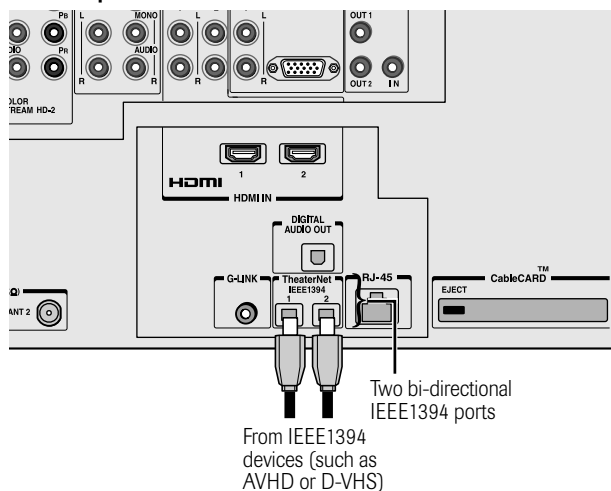

Using analog-compatible IEEE1394 devices

Some digital IEEE1394 devices are compatible with analog signals. For example, some D-VHS VCRs can record and play VHS or S-VHS format videos. Such devices allow you to play analog tapes that you rented or recorded, or record analog programs from antenna or Cable TV systems. To use the IEEE1394 device's analog features, you need to connect the device to the TV using standard A/V cables (or S-video plus audio cables) in addition to connecting the IEEE1394 cable.

Note: If you have an IEEE1394 device connected to both digital and analog inputs on the TV, the TV automatically switches between digital and analog modes, as needed, when the initial device access is initiated using the TheaterNet button.

See page 45 for details on using the TheaterNet feature.

Supported signals

The IEEE1394 ports support only the signals listed below. Even though incompatible video, audio, and digital control signals cannot be decoded by the TV, these signals may be passed through the IEEE1394 cable to other compatible devices. Incompatible devices may not appear in the TheaterNet™ menu.

• MPEG-2 digital video signals

Other digital video signals—such as DV video—are incompatible and must be decoded by the source device and sent to the TV as analog video (composite or S-video).

• Dolby Digital and MPEG digital audio signals

Other digital audio signals (such as DPM, MP3, and DTS) are incompatible and cannot be decoded by the TV.

• EIA-775 and AV/C digital control

Your TV can serve as the control center for many devices that are compatible with EIA-775 or AV/C IEEE1394 control standards (described below).

The TV cannot control IEEE1394 devices that use any other control standards.

- **EIA-775 digital control** allows tuning devices (such as Cable boxes) to send simple graphics; however, this standard does not allow the TV to control the Cable box through IEEE1394.
- **AV/C (audio/video control)** provides basic control (such as power, play, stop, rewind, fast-forward, pause, and record), as applicable to the specific device.

Using TheaterNet™ on-screen device control

You can use the TheaterNet feature to control some IEEE1394 devices using on-screen control icons. See page 45 for details on setting up and using the TheaterNet feature.

Note: If the TheaterNet feature does not control your IEEE1394 device, you can either use the device's remote control or try using IR pass-through with the TV's remote control (page 21).

Connecting IEEE1394 video devices (continued)

Connecting an AVHD (external hard drive) or D-VHS digital recorder

You can connect an IEEE1394 compatible D-VHS or AVHD (audio/video hard drive) digital recorder (such as Toshiba's Symbio™ AVHD Recorder) to record high definition and standard definition material from either tuner and control live TV (pause, rewind, etc.).

When you connect a D-VHS or AVHD device to the TV:

- The remote control keys (LIVE, REW, PAUSE, PLAY, FF, etc.) are automatically activated to allow control of live TV.
- The TV Guide On Screen™ system is automatically configured to allow recording to the device.* See Chapters 5 and 7 for details. Also see page 50 for details on setting the AVHD device skip time.
- Some programs may not be recorded due to copy protection restrictions.

This TV is compatible with the new Toshiba

Symbio™

Audio/Video Hard Drive Recorder!

Toshiba's Symbio™ AVHD Recorder is designed specifically for high definition television (HDTV) and offers control over digital video recording and playback.

Think of it as a "tapeless VCR" for digital television. You can pause, rewind, or use instant replay, so you'll never miss a thing!

Symbio also offers one-touch recording of both standard and High Definition programs through the no-fee TV Guide On Screen™ interactive program guide built in to this TV.*

The unauthorized recording, use, distribution, or revision of television programs, videotapes, DVDs, and other materials is prohibited under the Copyright Laws of the United States and other countries, and may subject you to civil and criminal liability.

***Note:** To enjoy the full benefits of your Symbio AVHD Recorder, you must first set up the TV Guide On Screen™ system (see Chapter 5). Full Symbio AVHD Recorder benefits, including Intelligent One Touch recording, will not be available unless the TV Guide On Screen™ system is fully operational. Even if the TV Guide On Screen™ system is not fully operational, however, manual recording is available as long as the TV Guide On Screen™ system has acquired the necessary date and time data. If you experience any issues with your Symbio AVHD Recorder, please contact the following:

- **In the U.S.,** call TACP Consumer Solutions at (800) 631-3811 or visit <http://www.tacp.com/customer-support/contact.asp>.
- **In Canada,** call TCL Customer Service at 1-800-268-3404.

IEEE1394 device initialization

When you connect a new IEEE1394 device to the TV and turn it on, the device immediately announces its presence to the TV (and other networked IEEE1394 devices, if any), and the following device initialization screen automatically appears.

Note: With some devices, it may take up to one minute for this screen to appear.

1. If you also connected your IEEE1394 device to an analog input, use the ▲▼◀▶ buttons to select the input in the ANALOG INPUT USED field; otherwise, leave it set to "None." (See "Using analog-compatible IEEE1394 devices" on page 22.)
2. If you want to label the device, highlight Edit Label and press ENTER.

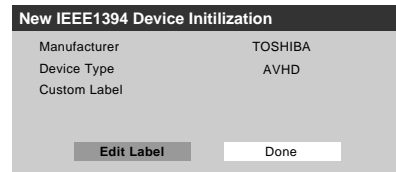

3. Press the ▲▼◀▶ buttons to select a character for the first space and then press ENTER.
4. Repeat step 3 to enter the rest of the characters.
5. Highlight Done and press ENTER to save the information.

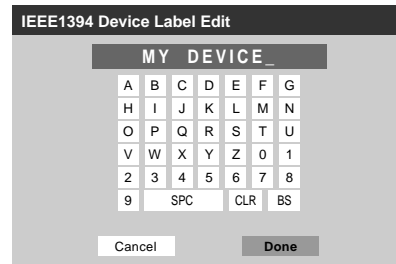

Note:

- The TV may not recognize incompatible or non-A/V IEEE1394 devices; however, these devices may still be available to other compatible IEEE1394 devices on the network.
- You may be able to use the TV's remote control to operate some compatible IEEE1394 devices. You must first program the remote control to recognize the device (see Chapter 3). If you have an IEEE1394 Cable box or satellite receiver, you may need to use the remote control that came with the device.
- Toshiba is not liable for the operation of any IEEE1394 device other than the Toshiba Symbio AVHD recorder.

Connecting IEEE1394 video devices (continued)

IEEE1394 device management

The IEEE1394 device information is saved in the TV's memory. You can edit this device information (for example, edit the device name, change the analog input information, or delete the device information from the TV's memory if you no longer use that device).

To edit the IEEE1394 device information:

1. Press MENU and open the Setup menu.
2. Highlight Installation and press ENTER. (A new set of Installation menu icons will appear on-screen, as shown in step 3 below).

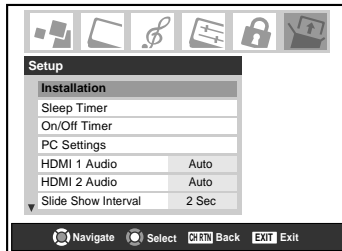

3. Open the Devices menu, highlight IEEE1394 Devices, and press ENTER.

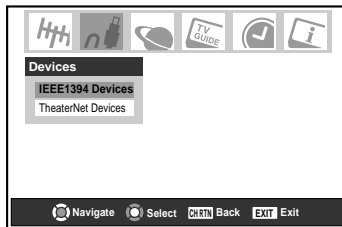

4. Highlight the device you want to edit and press ENTER.

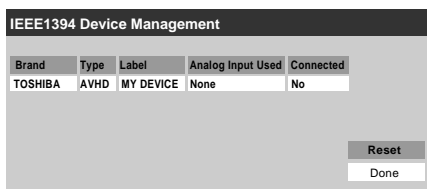

5. Follow the on-screen prompts to modify the device information.

Important information regarding IEEE1394 device interconnection

- **Never loop the last device in the chain back to the TV.**
If the device chain is looped, the TV may not work properly with the other devices in the chain.
- **Always place devices with the slowest communication speed at the end of each chain.** *If a device with a slower communication speed is placed ahead of a faster device in the chain, the signal from the slower device will interfere with the signal from the faster device. To determine the communication speed of an IEEE1394 device, look for an "S" number near the device's IEEE1394 connector. The higher the "S" number, the faster the device. If your device is not marked with an "S" number, look in the device's user manual or call the device manufacturer's technical support number.*
- **If your IEEE1394 device has a two-position power switch, always place the device at the end of the chain and turn ON the power switch when any device is used.** *If the power switch is OFF, it will interfere with signals from devices behind it in the chain.*
- **The maximum length for an IEEE1394 cable between each device is 15 feet.**
- *This TV is an IEEE1394A device. The IEEE1394B protocol is faster and intended to allow for longer distances between devices and multi-room systems. IEEE1394A-to-IEEE1394B converters (available at some electronics suppliers) may allow compatibility of IEEE1394B devices with your existing IEEE1394A devices.*
- *The transmission capability of IEEE1394 cable used with this TV must be S400 (400 Mbps maximum).*

G-LINK™ connection

- **This connection is necessary for the TV Guide On Screen™ system to work with your cable box to receive program listings and to enable the TV Guide On Screen™ recording features with your VCR.**
- **This connection is not necessary for AVHD or D-VHS recording devices. See pages 23 and 50 for further details.**

After you connect your devices to the TV, you will need to connect the G-LINK™ cable (either of the dual-wand IR blaster cables included with your TV) from your VCR and Cable box (if applicable) to the G-LINK™ terminal on the TV.

Note: TV Guide On Screen™ program data is available through the ANT-1 and ANT-2 antenna inputs and also through the VIDEO 1 inputs if you have a cable box connected to VIDEO 1. TV Guide On Screen™ program data is not available through any other inputs on this TV. See the connection information on pages 13–25.

The G-LINK™ connection is necessary to enable the following features of your TV Guide On Screen™ system:

- If you have a Cable box, you need to connect the G-LINK™ cable from the Cable box to the G-LINK™ terminal to receive the TV Guide On Screen™ program listings for your Cable service.
- If you have a VCR, you need to connect the G-LINK™ cable from the VCR to the G-LINK™ terminal to use the TV Guide On Screen™ recording features.

To connect to the G-LINK™ terminal:

1. Locate the infrared sensor on the front of your VCR or Cable box. The sensor is marked on some devices.*
2. Align one of the G-LINK™ (IR blaster) cable's wands about 1 inch away from the infrared sensor on the front of the VCR and attach it using double-sided mounting tape.

If you have a Cable box, attach the other wand in a similar manner. (See illustration at right.)

Note: If you do not have a Cable box, coil the second wand with a rubber band and leave it behind the TV.

3. Plug the G-LINK™ (IR blaster) cable's plug into the TV's G-LINK™ terminal.

For details on setting up the TV Guide On Screen™ system:

See Chapter 5.

For details on using the TV Guide On Screen™ interactive program guide:

See Chapter 7.

* If you cannot locate the device's infrared sensor:

1. Turn OFF the device.
2. Starting at the lower left corner of the device, place the end of the device's remote control (with the infrared emitter) so it touches the front of the device and press POWER. (Do not use the TV's remote control for this step.)
3. If the device turns on, the point at which the remote control touched the device is the location of the sensor.
4. If the device does not turn on, move the remote control slightly to the right and press POWER again.
5. Repeat step 4 until you locate the device's infrared sensor.

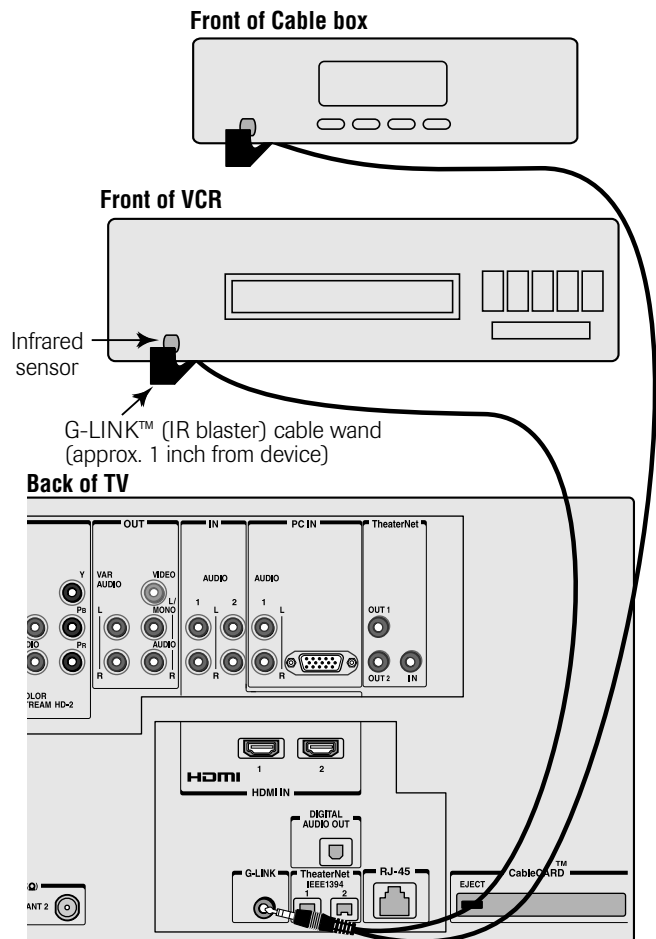

Connecting a personal computer (PC)

This connection allows you to view the image of a personal computer (PC) on the TV screen. When connecting a PC to the TV, use an analog RGB (15-pin) computer cable and a PC audio cable.

– To use a PC, set the monitor output resolution on the PC before connecting it to the TV. The following signals can be displayed.

- VGA: 640 × 480 @ 60Hz
- SVGA: 800 × 600 @ 60Hz
- XGA: 1024 × 768 @ 60Hz

Other formats or non-standard signals may not be displayed correctly.

– To display the optimum picture, use the PC setting feature. (see “Using the PC setting feature” on page 95).

Signal names for mini D-sub 15 pin connector

Pin No.	Signal name
1	R
2	G
3	B
4	NC (not connected)
5	NC
6	Ground
7	Ground
8	Ground
9	NC
10	Ground
11	NC
12	NC
13	H-sync
14	V-sync
15	NC

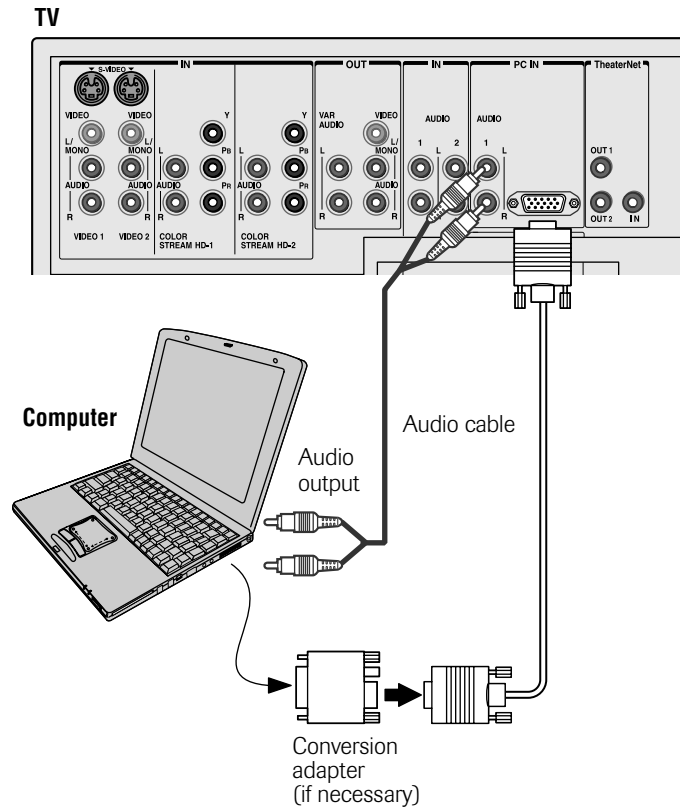

Note:

- Some PC models cannot be connected to this TV.
- An adapter is not needed for computers with a DOS/IV compatible mini D-sub 15-pin terminal.
- Depending on the DVD's title and the specifications of the PC on which you are playing the DVD-Video, some scenes may be skipped or you may not be able to pause during multi-angle scenes.

Connecting a home network

Networking the TV with your home Internet e-mail service to enable remote scheduling of recordings and reminders

You can network the TV with your home Internet service to remotely schedule recordings and reminders by sending an e-mail to the TV.

To use this feature, you must have Internet e-mail service in your home and two separate e-mail addresses (your personal e-mail address and a second e-mail address for use solely by the TV). Contact your ISP (Internet Service Provider) for these services.

Note:

- This feature is only for remotely scheduling recordings and reminders. You will not be able to access the Internet through the TV.
- To configure your TV for remote scheduling, see Chapter 11

Example #1: Networking via DSL modem service

You will need:

- ▶ three telephone cables
- ▶ three RJ-45 cables
- ▶ one telephone cable splitter
- ▶ one RJ-45 router
- ▶ one DSL modem

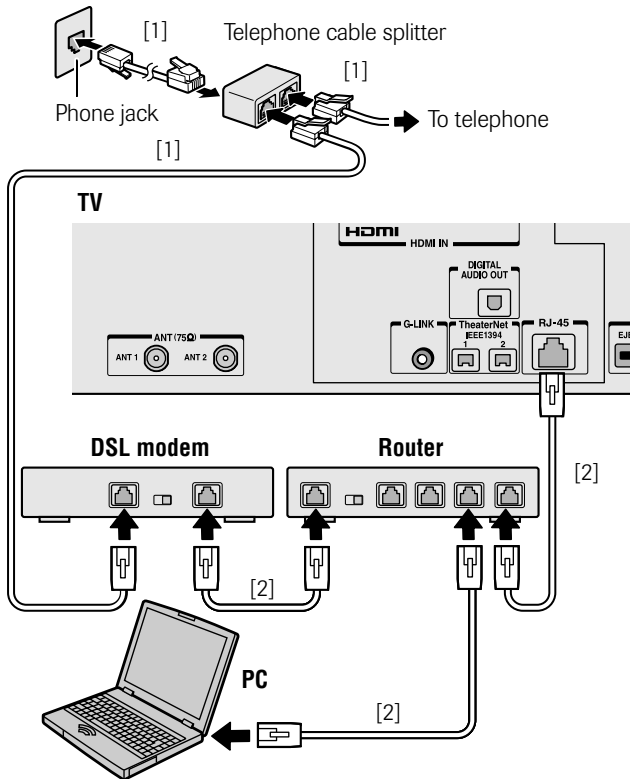

- [1] Telephone cable
- [2] RJ-45 cable
- [3] Coaxial cable

Example #2: Networking via cable modem service

You will need:

- ▶ three coaxial cables
- ▶ three RJ-45 cables
- ▶ one coaxial cable splitter
- ▶ one RJ-45 router
- ▶ one cable modem

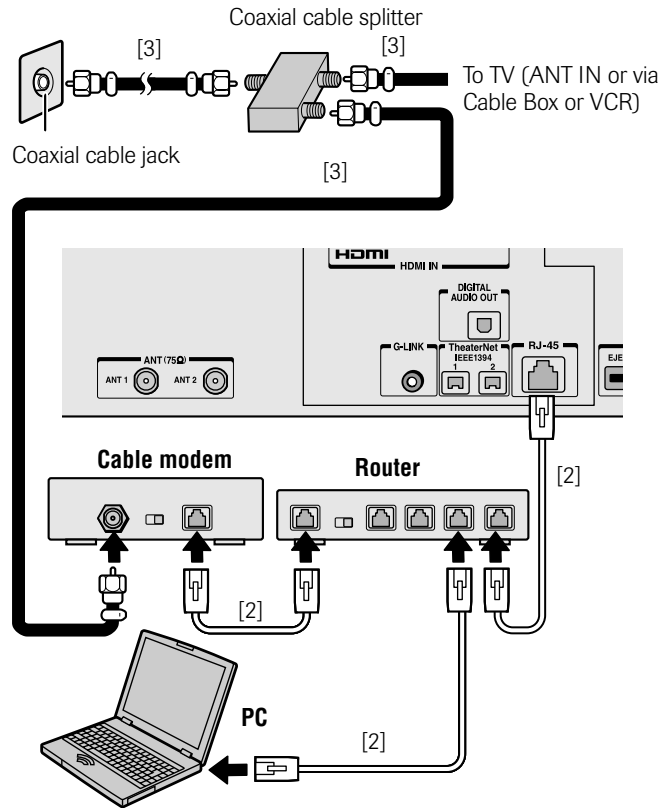

3 Using the remote control

Learning about the remote control

The buttons used for operating the TV only are described here. For a complete list of the remote control's functions, see the remote control functional key chart on pages 29–30.

For a list of the buttons that operate the TV Guide On Screen™ system, see page 54.

POWER turns the TV on and off. Press POWER to turn on the TV. The blue LED indicator on the TV front will be illuminated. Press POWER again to turn off the TV.

Note: The Quick Restart setting will affect the amount of time it takes for the picture to appear when you turn on the TV. See page 51 for details.

SLEEP accesses the sleep timer (page 94).

LIGHT The first press of the LIGHT button lights the keypad and turns on the Illumination mode. With the Illumination mode on, pressing any key lights the keypad for 5 seconds (10 seconds if you're in programming mode). Subsequent presses of the LIGHT button toggle between turning the Illumination mode on and off.

Channel Numbers (0–9, –/100) directly tune channels. The “–” button is used to tune digital channels (page 71) or to display the favorite channel list (page 44).

INPUT selects the video input source (page 67).

MODE cycles through the six remote control device modes: TV, CBL/SAT, VCR/PVR, DVD, AUDIO1, and AUDIO2. The mode indicator light will remain lit for a few seconds (page 28).

PIC SIZE cycles through the five picture sizes: Natural, TheaterWide 1/2/3, and Full (page 72).

TheaterNet™ DEVICE displays a list of available TheaterNet devices (page 45).



TheaterNet™ CTRL accesses the on-screen IR device control icons (page 46).

MENU accesses the main TV menu system (pages 35 and 36) or opens a menu in the TV Guide On Screen™ system (Chapter 7).

TV GUIDE opens the TV Guide On Screen™ system (Chapter 7).

INFO provides detailed information on highlighted items in the TV Guide On Screen™ system (Chapter 7).

ENTER activates highlighted items in the main menu system and the TV Guide On Screen™ system.

Arrow buttons (▲▼◀▶) When a menu is on-screen, these buttons select or adjust programming menus. (Also see   on the next page.)

CH ▲▼ cycles through programmed channels when no menu is on-screen (42) and functions as page up/down when a menu is on-screen or when the TV Guide On Screen™ system is open (Chapter 7).

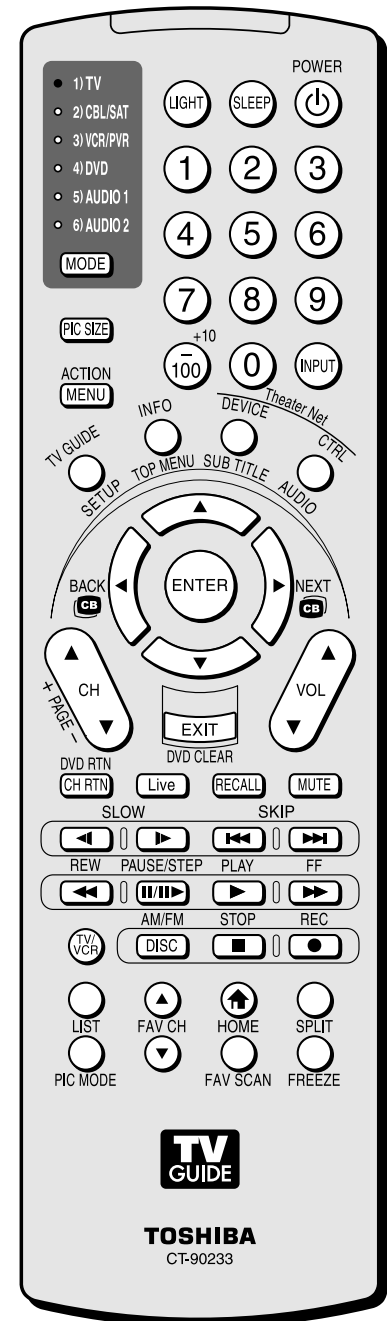

Note: The error message “Not Available” will appear if you press a key for a function that is not available

(Continued on next page)

Learning about the remote control (continued)

VOL ▲▼ adjusts the volume level.

EXIT closes on-screen menus and the TV Guide On Screen® system.

CH RTN returns to the last viewed channel (page 71), or stops the picture viewer slide show (page 88).

Live returns viewing of the TV back to the live program, while continuing to record to the Toshiba Symbio™ AVHD recorder (pages 23 and 50).

RECALL displays TV setting information on-screen (page 92).

MUTE reduces or turns off the sound (page 84).

TV/VCR selects TV mode to view one program while recording another.

SKIP ►► and **◄◄** jump forward and backward one day in the TV Guide On Screen™ listings (Chapter 7).

LIST displays the Toshiba Symbio™ AVHD recorder play list (if available) (page 23).

FAV CH ▲▼ tunes to the next higher/lower favorite channel (page 44).

HOME (↑) accesses the home function of the channel browser feature (page 69)

BACK (CB) ◀ / ▶ (CB) NEXT While watching TV, these buttons open the channel browser banner and tune to the previous/next channel in the channel history (page 69). (Also see “Arrow buttons” on previous page.)

SPLIT turns the POP feature on and off (page 76) or locks/unlocks the TV Guide On Screen™ video window.

PIC MODE selects the picture mode (page 79).

FAV SCAN accesses the favorite channel search function (page 78).

FREEZE accesses the freeze feature (page 78).

Remote control effective range

For optimum performance, aim the remote control directly at the TV and make sure there is no obstruction between the remote control and the TV.

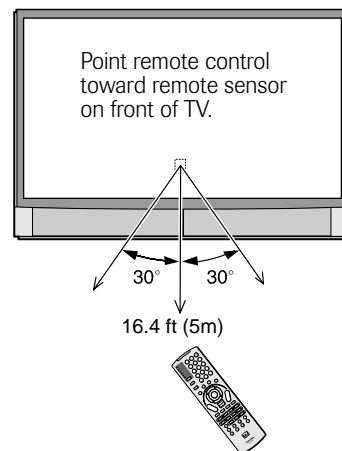

Installing the remote control batteries

To install the remote control batteries:

Caution: Always dispose of batteries in a designated disposal location. Never throw batteries into a fire.

1. Slide the battery cover off the back of the remote control.

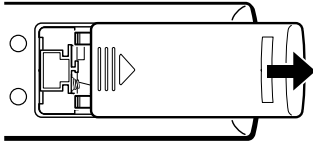

2. Install two "AA" size alkaline batteries. Match the + and – symbols on the batteries to the symbols on the battery compartment.

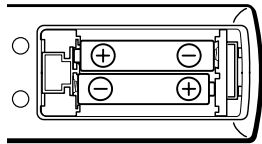

3. Slide the battery cover on to the remote control until the lock snaps.

Caution:

Never throw batteries into a fire.

Note:

- Be sure to use AA size batteries.
- Dispose of batteries in a designated disposal area.
- Batteries should always be disposed of with the environment in mind. Always dispose of batteries in accordance with applicable laws and regulations.
- If the remote control does not operate correctly, or if the operating range becomes reduced, replace batteries with new ones.
- When necessary to replace batteries in the remote control, always replace both batteries with new ones. Never mix battery types or use new and used batteries in combination.
- Always remove batteries from remote control if they are dead or if the remote control is not to be used for an extended period of time. This will prevent battery acid from leaking into the battery compartment.

Using the remote control MODE button to control your other devices

Your TV remote control has one dedicated TV mode and five programmable multi-brand modes: CBL/SAT, VCR/PVR, DVD, AUDIO 1, and AUDIO 2. The default device modes and programmable device modes are listed below.

Note: The TV remote control is preprogrammed to operate most Toshiba devices. If you own a non-Toshiba device or a Toshiba device that the remote control is not preprogrammed to operate, you will need to program the remote control. See "Programming the remote control to operate your other devices" on page 31.

MODE	Default device mode control (before programming)
1) TV	Toshiba TV
2) CBL/SAT	Toshiba Satellite receiver
3) VCR/PVR	Toshiba VCR
4) DVD	Toshiba DVD
5) AUDIO 1	Pioneer Audio receiver
6) AUDIO 2	Pioneer LD

MODE	Device mode control after programming
1) TV	Toshiba TV
2) CBL/SAT	Multi-brand video/audio devices
3) VCR/PVR	
4) DVD	
5) AUDIO 1	
6) AUDIO 2	

You can directly select the device mode by pressing the corresponding number button (1-6) while pressing the MODE button.

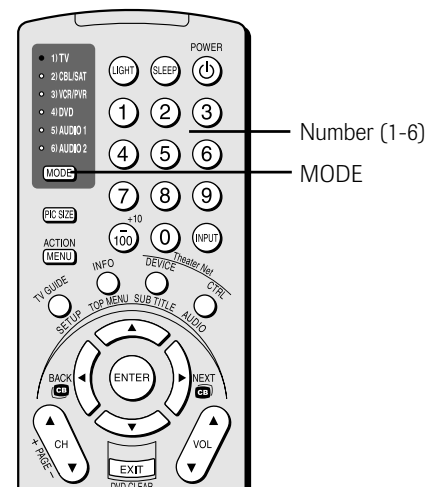

Note:

Although your new TV's remote control includes codes for many devices, it may not include codes for some or all of the features on certain devices you wish to control. If you are unable to program the TV's remote control to operate your device or some of the features on that device, use the device's remote control or the controls on the device.

Remote Control functional key chart

Key Label	Toshiba TV (TV)	Cable (CBL/SAT)	Satellite (CBL/SAT)	VCR	DVD/LD	Receiver (AUDIO)	CD (AUDIO)	PVR (VCR)
MODE	Remote control device mode selection							
LIGHT	Lights the remote key, and toggles between enabled and disabled Illumination mode.*1							
SLEEP	Sleep timer	---	---	---	---	---	---	---
POWER	Power	Power	Power	Power	Power	Power	Power	Power
1	Digit 1	Digit 1	Digit 1	Digit 1	Digit 1	AV input 1	Digit 1	Digit 1
2	Digit 2	Digit 2	Digit 2	Digit 2	Digit 2	AV input 2	Digit 2	Digit 2
3	Digit 3	Digit 3	Digit 3	Digit 3	Digit 3	AV input 3	Digit 3	Digit 3
4	Digit 4	Digit 4	Digit 4	Digit 4	Digit 4	AV input 4	Digit 4	Digit 4
5	Digit 5	Digit 5	Digit 5	Digit 5	Digit 5	CD	Digit 5	Digit 5
6	Digit 6	Digit 6	Digit 6	Digit 6	Digit 6	Tuner	Digit 6	Digit 6
7	Digit 7	Digit 7	Digit 7	Digit 7	Digit 7	Phono	Digit 7	Digit 7
8	Digit 8	Digit 8	Digit 8	Digit 8	Digit 8	Cassette	Digit 8	Digit 8
9	Digit 9	Digit 9	Digit 9	Digit 9	Digit 9	Aux	Digit 9	Digit 9
0	Digit 0	Digit 0	Digit 0	Digit 0	Digit 0	---	Digit 0, 10	Digit 0
100/-	- (digital separator)	---	- (sub channel)	100	+10	---	---	---
INPUT	TV/Video select	← TV	← TV	← TV	← TV	← TV	← TV	← TV
PIC SIZE	Selects the image shape.	← TV	← TV	← TV	← TV	← TV	← TV	← TV
MENU/ ACTION	Menu/ Guide Menu	---	Action, Menu	---	Menu	---	---	Menu
TV GUIDE/SETUP	TV Guide	---	Guide	---	DVD setup	---	---	Guide
INFO/TITLE	Guide Info	---	INFO	---	TITLE= Top menu	---	---	INFO
TheaterNet DEVICE/SUBTITLE	TheaterNet Device	---	---	---	Subtitle	---	---	ADVANCE
TheaterNet CTRL/AUDIO	TheaterNet Control	---	---	---	Audio	---	---	---
ENTER	Enter	---	Enter, Select	---	Enter	---	---	Enter
▲	Menu select up	---	Menu select up	---	Menu select up	---	---	Menu select up
▼	Menu select down	---	Menu select down	---	Menu select down	---	---	Menu select down
◀▶	Menu select left/right	---	Menu select left/right	---	Menu select left/right	---	---	Menu select left/right
EXIT/ DVD CLEAR	Exit	---	Exit	---	DVD clear	---	---	EXIT
CH ▲▼ PAGE +/-	Channel up/down, Page up/down	Channel up/down	Channel up/down	Channel up/down	---	Channel up/down	---	Channel up/down
VOL ▲▼	Volume up/down*2	Volume up/down*2	Volume up/down*2	Volume up/down*2	Volume up/down*2	Volume up/down*2	Volume up/down*2	Volume up/down*2
CH RTN/ DVD RTN	Previous channel	Previous channel	Previous channel	---	DVD return	---	---	---
Live	Live	---	---	---	---	---	---	Live TV
RECALL	On-screen display	---	---	---	On-screen display	---	---	---

Remote Control functional key chart (continued)

Key Label	Toshiba TV (TV)	Cable (CBL/SAT)	Satellite (CBL/SAT)	VCR	DVD/LD	Receiver (AUDIO)	CD (AUDIO)	PVR (VCR)
MUTE	Sound mute*2	Sound mute*2	Sound mute*2	Sound mute*2	Sound mute*2	Sound mute*2	Sound mute*2	Sound mute*2
SLOW ◀ ▶	-----	-----	-----	Slow FWD ---	Slow FWD Slow REW	-----	-----	Slow FWD ---
SKIP ◀ ▶	Skip FWD Skip REW	-----	-----	-----	Skip FWD Skip REW	-----	Skip FWD Skip REW	-----
REW	Rewind	---	---	Rewind	Rewind	---	Rewind	Rewind
PAUSE/STEP	Pause	---	---	Pause	Pause	---	Pause	Pause
PLAY	Play	---	---	Play	Play	---	Play	Play
FF	Fast FWD	---	---	Fast FWD	Fast FWD	---	Fast FWD	Fast FWD
TV/VCR	---	---	TV/SAT	TV/VCR	---	---	---	Reverse
DISC/AM/FM	---	---	---	---	Disc shift	AM/FM	Disc shift	Replay
STOP	Stop	---	---	Stop	Stop	---	Stop	Stop
REC	REC Menu (Single Click)	---	---	Record (Double Click)	---	---	---	Record (Double Click)
LIST	LIST	---	---	---	---	---	---	---
FAV CH ▲▼	FAV channel up/down	---	---	---	---	---	---	---
HOME	HOME	---	---	---	---	---	---	---
SPLIT	Split	← TV	← TV	← TV	← TV	← TV	← TV	← TV
PIC MODE	PIC MODE	← TV	← TV	← TV	← TV	← TV	← TV	← TV
FAV SCAN	FAV SCAN	---	---	---	---	---	---	---
FREEZE	Freeze	← TV	← TV	← TV	← TV	← TV	← TV	← TV

Notes:

• “---” = key does not send a signal.

• “← TV” = key will operate the TV.

*1 Backlight key is toggle. Does not send IR signal.

*2 Volume will punch through to TV by default. When the volume is unlocked, all the devices will have their own volume if their ID has volume data. The AUDIO modes (receiver, CD) will have their own volume if volume lock is done to TV, CBL/SAT, VCR/PVR, or DVD mode. See “Using the volume lock feature” on page 32.

Programming the remote control to operate your other devices (continued)

Using the volume lock feature (8000)

For the TV, CABLE/SAT, VCR, and DVD modes, the volume controls (VOL ▲▼ and MUTE) can be locked to the selected device mode. This feature does not apply to the AUDIO 1 and AUDIO 2 modes.

To lock the volume controls to always control the CABLE/SAT device volume (for example):

1. Repeatedly press MODE to select CABLE/SAT mode.
2. While holding down the RECALL button, press 8 – 0 – 0 – 0.
3. Press VOL ▲.

The CABLE/SAT mode light will blink two times (locked).

To reset the volume controls to the original device mode:

1. While holding down RECALL, press 8 – 0 – 0 – 0.
2. Press VOL ▼.

The mode light will blink four times (unlocked).

Operational feature reset (8900)

This feature clears all programmed features not related to “Device code setup” and resets the Volume Lock to “TV.”

To reset the features:

While holding down the RECALL button, press 8 – 9 – 0 – 0.
The Mode indicator will blink two times, and then pause and blink two more times.

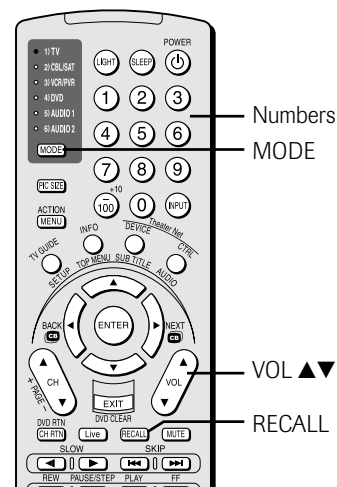

Multi-brand remote control device codes

VCRs/PVRs		VCRs/PVRs (cont.)		Cable boxes	
Brand	Code	Brand	Code	Brand	Code
ADMIRAL	0135	PHILCO	0131, 0124, 0127, 0123, 0126, 0120, 0143	ABC	1124
AIWA	0127, 0132, 0181	PHILIPS	0131, 0123, 0124, 0173	ARCHER	1132, 1125
AKAI	0129, 0114, 0115, 0116	PIONEER	0123	CABLEVIEW	1105, 1132
AUDIO DYNAMIC	0139, 0111	PROSCAN	0145, 0100, 0123, 0124, 0131, 0146, 0101, 0102, 0133	CITIZEN	1122, 1105
BELL&HOWELL	0105, 0113	QUASAR	0121, 0122, 0123, 0124	CURTIS	1112, 1113
BROKSONIC	0120, 0126, 0180	RADIO SHACK	0133, 0124, 0105, 0136, 0109, 0140, 0127	DIAMOND	1124, 1132, 1125
CANON	0123, 0125	RCA	0133, 0145, 0100, 0123, 0124, 0131, 0146, 0101, 0102, 0170, 0172, 0174, 0176, 0183	EAGLE	1129
CCE	0143	REALISTIC	0124, 0105, 0136, 0109, 0140, 0127	EASTERN	1134
CITIZEN	0106	Replay TV	7102	GCBRAND	1132, 1105
CRAIG	0105, 0129, 0106	SAMSUNG	0137, 0102, 0104, 0133	GEMINI	1122, 1143
CURTIS MATHES	0145, 0124, 0127	SAMTRON	0163	G.I./JERROLD	1119, 1124, 1125, 1126, 1127, 1120, 1121, 1122, 1111, 1123, 1152
DAEWOO	0143, 0101, 0124, 0175	SANSUI	0139, 0126, 0120, 0152	HAMLIN	1140, 1141, 1142, 1145, 1118, 1112
DBX	0139, 0110, 0111	SANYO	0105, 0109, 0113	HITACHI	1103, 1124
DIMENSIA	0145	SCOTT	0101, 0102, 0104, 0109, 0138, 0140, 0147, 0148, 0126	MACOM	1103, 1104, 1105, 1108
EMERSON	0143, 0126, 0119, 0103, 0125, 0142, 0120, 0118	SEARS	0105, 0106, 0107, 0108, 0100	MAGNAVOX	1133
FISHER	0105, 0108, 0109, 0107, 0113, 0165	SHARP	0135, 0136, 0167, 0162	MEMOREX	1130
FUNAI	0127, 0126, 0120, 0134	SHINTOM	0117	MOVIETIME	1132, 1105
GE	0133, 0145, 0124	SIGNATURE 2000	0127, 0135	OAK	1139, 1137, 1102
GO VIDEO	0137, 0151, 0163, 0149, 0150, 0182	SINGER	0117	PANASONIC	1109, 1110, 1114, 1151, 1153
GOLDSTAR	0106	SONY	0128, 0129, 0130, 0153, 0154, 0155, 7101	PHILIPS	1128, 1129, 1130, 1106, 1107, 1150, 1131
GRADIENTE	0170, 0171, 0168, 0134, 0156	SV2000	0127	PIONEER	1101, 1116
HITACHI	0123, 0145, 0100, 0127, 0168	SYLVANIA	0131, 0123, 0124, 0127, 0178	PULSAR	1105, 1132
INSTANT REPLAY	0124, 0123	SYMPHONIC	0127, 0168, 0177	PUSER	1132
JENSEN	0139	TASHIRO	0106	RCA	1115
JVC	0139, 0110, 0111, 0134, 0157, 0158, 0184, 0185, 7104	TATUNG	0139, 0110, 0111	REALISTIC	1132
KENWOOD	0139, 0110, 0106, 0111	TEAC	0139, 0110, 0127, 0111	REGAL	1112, 1118, 1140, 1141, 1142, 1145, 1149
LG	0159	TECHNICS	0121, 0122, 0123, 0124	REGENCY	1134
LXI	0127, 0106, 0100, 0107, 0108, 0105, 0109	TEKNICA	0124, 0127, 0112	REMBRANT	1137, 1132, 1105, 1138
MAGNAVOX	0131, 0123, 0124, 0173	THOMSON	0179, 0183	SAMSUNG	1105
MARANTZ	0139, 0110, 0111	Tivo	7100, 7101	S.A.	1111, 1112, 1113
MARTA	0106	TOSHIBA	0101, 0146, 0166, 0160	SLMARK	1105, 1101
MEMOREX	0124, 0109	VECTOR RESEARCH	0111	SPRUCER	1105, 1110
MGA	0138, 0140, 0147, 0148, 0141, 0142	WARDS	0135, 0136, 0109, 0144, 0106	STARGATE	1132, 1105
MINOLTA	0100, 0145	YAMAHA	0105, 0139, 0110, 0111	TELECAPTION	1148
MITSUBISHI	0138, 0140, 0147, 0148, 0141, 0142, 0161, 0164	ZENITH	0144, 0106, 0169, 0180	TELEVIEW	1101, 1105
MULTITECH	0147, 0127, 0104			TEXSCAN	1144
NEC	0139, 0110, 0111, 0134			TOCOM	1135, 1136, 1147
OLYMPIC	0124, 0123			TOSHIBA	1104, 1146
OPTIMUS	0128, 0121, 0135, 0106			UNIKA	1132, 1125
ORION	0126, 0120, 0132			UNIVERSAL	1122, 1132
PANASONIC	0123, 0124, 0121, 0122			VIDEOWAY	1106
PENNEY	0124, 0100, 0145, 0105, 0139, 0110, 0111			VIEWSTAR	1129, 1130
PENTAX	0100, 0111, 0145			ZENITH	1117, 1100
				ZENITH/DRAKE SATELLITE	1100

Multi-brand remote control device codes (continued)

CD players		Receivers (cont.)		DVD players	
Brand	Code	Brand	Code	Brand	Code
ADMIRAL	6126	PIONEER	4105, 4107, 4150	AIWA	3123
AIWA	6133, 6135	QUASAR	4119, 4118, 4121	APEX	3120
CARVER	6129	RCA	4103, 4105, 4127, 4131, 4130, 4149	DENON	3100, 3117
DENON	6142, 6151	SANSUI	4103, 4111, 4139	FERGUSON	3101
EMERSON	6139	SHARP	4134, 4137	HITACHI	3111
FISHER	6105, 6106	SONY	4122	JVC	3109
GARRARD	6117	SOUNDE-SIGH	4138	KENWOOD	3115, 3129
HARMAN/KARDON	6120, 6121, 6123, 6119	TEAC	4112, 4113, 4111, 4110	KONKA	3119
HITACHI	6107	TECHNICS	4121, 4118, 4119	MITSUBISHI	3105
JENSEN	6134	VICTOR	4132, 4133	NORDMENDE	3101
JVC	6140, 6141, 6145, 6148, 6151	YAMAHA	4101, 4102	ONKYO	3121
KENWOOD	6100, 6101, 6111, 6145	Laser disks		ORITRON	3124
LXI	6136	Brand	Code	PANASONIC	3100
MAGNAVOX	6129, 6132	DENON	5114	PHILIPS	3103, 3116
MARANTZ	6129	HITACHI	5100	PIONEER	3102
MACINTOSH	6121	KENWOOD	5102, 5103	RAITE	3113
NAKAMICHI	6110	MAGNAVOX	5101	RCA	3101, 3106
ONKYO	6114, 6115	MARANTZ	5114	SABA	3101
OPTIMUS	6108, 6118, 6120, 6122	MITSUBISHI	5114, 5118, 5119	SAMPO	3114
PANASONIC	6124, 6125, 6127, 6150	NEC	5114	SAMSUNG	3110
PHILIPS	6129, 6130, 6149	PANASONIC	5104, 5105, 5106, 5115	SHARP	3108
PIONEER	6108	PHILIPS	5111	SYLVANIA	3132, 3118
QUASAR	6125, 6127, 6124	PIONEER	5114	SMC	3125
RCA	6147, 6137, 6138, 6131, 6152	PROSCAN	5114	SONY	3104, 3126, 3127, 3128
SANSUI	6110, 6146, 6113	QUASAR	5104, 5105, 5106, 5115	TECHNICS	3100
SANYO	6105	RCA	5114	THOMSON	3101
SCOTT	6110, 6146	SAMSUNG	5112	TOSHIBA	3103
SHARP	6142, 6143	SANYO	5114, 5117	WAVE	3122
SHERWOOD	6120	SHARP	5113, 5116	YAMAHA	3100, 3130
SONY	6128	SONY	5107, 5108, 5109, 5110	ZENITH	3107, 3112
SOUNDE-SIGH	6144	TEAC	5114	VIALTA	3131
TEAC	6112, 6116, 6118	TOSHIBA	5114	FUNAI	3132, 3118
TECHNICS	6127, 6124, 6125	YAMAHA	5101		
VICTOR	6140, 6141, 6145			Satellite receivers	
YAMAHA	6102, 6103, 6104			Brand	Code
Receivers				DISH NETWORK	2105, 2115, 2116,
Brand	Code			(Echostar)	2117
ADMIRAL	4120			ECHOSTAR	2105
AIWA	4125, 4126, 4146			EXPRESS VU	2105, 2115
DENON	4134, 4135, 4136, 4143			G.E.	2106
FISHER	4104			G.I.(GENERAL INSTRUMENT)	2108
GARRARD	4113			GRADIENTE	2114
HARMAN KARDON	4115, 4123, 4145			HITACHI	2103, 2111, 2112
JENSEN	4129			HNS(Hughes)	2103
JVC	4132, 4133, 4140, 4144			MAGNAVOX	2101, 2102
KENWOOD	4100, 4108, 4141, 4142, 4147			PANASONIC	2104
MAGNAVOX	4127, 4128			PHILIPS	2101, 2102, 2118
MARANTZ	4124			PRIMESTAR	2108
MCNTOSH	4116			PROSCAN	2106, 2109, 2110, 2113
MITSUBISHI	4148			RCA	2106, 2109, 2110, 2113
NAKAMICHI	4106, 4117			SONY	2107
ONKYO	4109, 4114			STAR CHOICE	2103, 2108
OPTIMUS	4103, 4127, 4131, 4130			TOSHIBA	2100, 2103, 2119, 2120, 2121, 2122, 2123, 2124, 2125
PANASONIC	4119, 4118, 4121			UNIDEN	2101, 2102
PHILIPS	4123				

4 Menu layout and navigation

The illustrations below and on the next page provide a quick overview of your TV's menu system.

Main menu layout

To open the main menus (illustrated below), press MENU on the remote control or TV control panel.

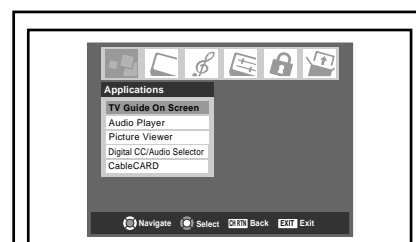
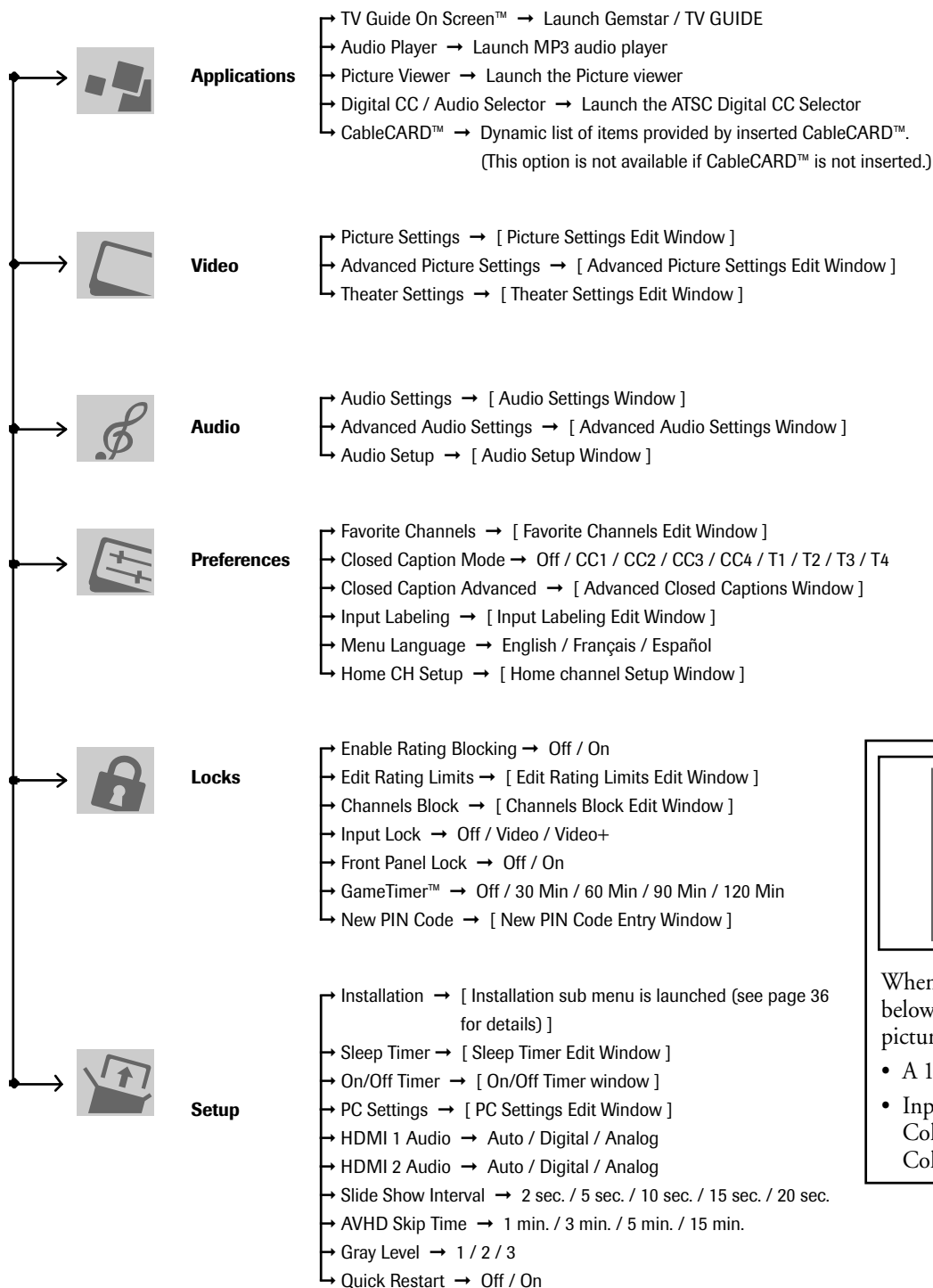

When the TV is in these conditions below, the background of the menu picture will appear black.

- A 1080 signal is received.
- Input source is selected in ColorStream HD1 or ColorStream HD2.

5 TV Guide On Screen™ setup

Setting up the TV Guide On Screen™ system

The TV Guide On Screen™ system in your TV is a no-fee interactive program guide that uses the information you enter during the following setup process to provide you with a channel lineup and program listings for your area. The listings are automatically updated several times a day.

Note:

- You must first set up your TV according to the applicable connection instructions in Chapter 2.
- If you connected a Toshiba *Symbio*™ AVHD Recorder, you must perform the following TV Guide On Screen™ system setup in order to use the Symbio's full functionality. See pages 23 and 50 for further details about AVHD digital recorders.

To set up the TV Guide On Screen™ system:

1. Press MENU and open the Setup menu.
2. Highlight Installation and press ENTER.

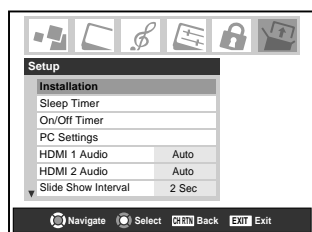

3. A new set of Installation menu icons appears on-screen (see illustration at right). Open the TV Guide On Screen™ Setup menu, highlight Start, and press ENTER.

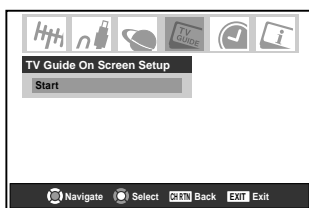

4. The following screen appears. Highlight “Set up TV Guide On Screen™ now” and press ENTER to continue.

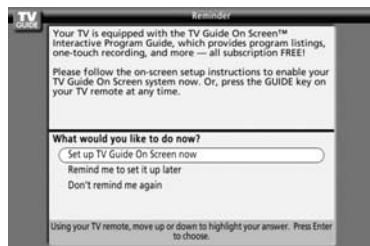

5. The following screen appears. Press ENTER to continue.



Configuring the location of your TV

Screen 1: Select the TV location (USA or Canada), and then press ENTER.



Screen 2: Enter the ZIP code (U.S.A.) or postal code (Canada) for your location (use the Number buttons on the remote control for numbers and the ▲▼ buttons for letters), and then press ENTER. Screen 3 appears.

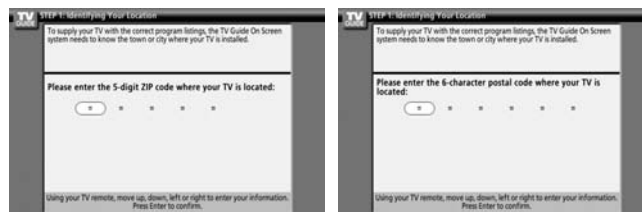

Screen 3: Do you have Cable service connected? If you select Yes (and press ENTER), screen 4 appears. If you select No (and press ENTER), screen 12 appears.

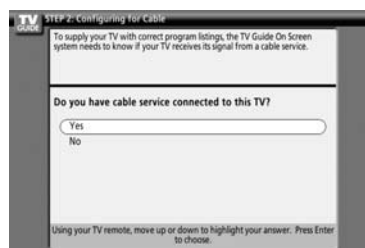

Screen 4: Do you have a Cable box connected? If you select Yes (and press ENTER), screen 5 appears. If you select No (and press ENTER), screen 13 appears.

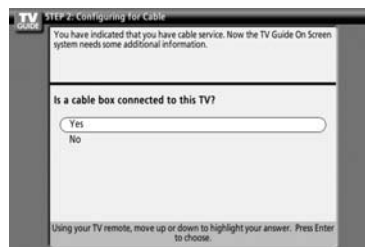

Setting up the TV Guide On Screen™ system (continued)

Screen 5: Which TV input is your cable box plugged into?
If you select ANT 1, screen 6 appears.
If you select Video 1, screen 7 appears.

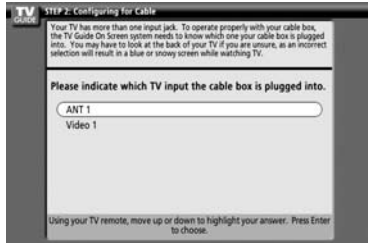

Screen 6: Select the channel your TV is tuned to when using your cable box, and then press ENTER. Screen 7 appears.

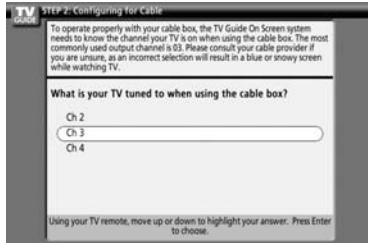

Screen 7: The on-screen diagram shows the correct way to connect your Cable box to the G-LINK™ terminal on the TV. **Make sure the G-LINK™ cable is installed properly. For additional details, see page 25.**
Press ENTER to display screen 8.

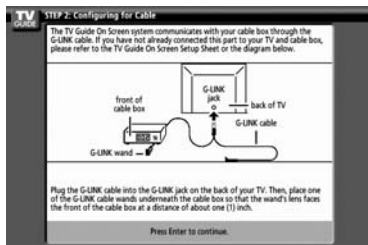

Screen 8: Highlight your Cable box brand, and then press ENTER to display screen 9.

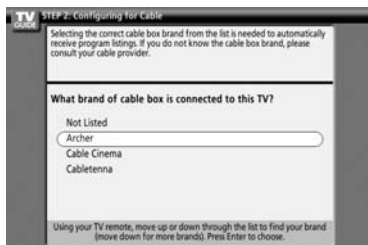

Screen 9: To allow the TV Guide On Screen™ system to find the correct code for your brand of Cable box, tune your Cable box to channel 02, leave the Cable box and TV ON, and then press ENTER. Screen 10 appears.

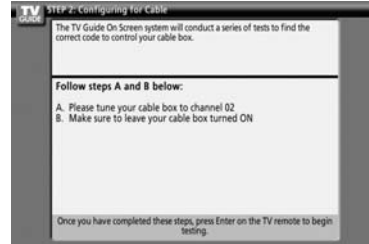

Screen 10: The TV Guide On Screen™ system will test the code for the brand of Cable box you selected. Do not press any keys on the TV, remote control, or Cable box until the testing process is completed. When testing is completed, screen 11 appears.

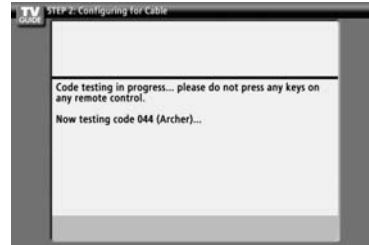

Screen 11: If your Cable box tuned itself to channel 09 after testing, select Yes and press ENTER. If you selected ANT 1 in screen 5, screen 13 appears. If you selected Video 1 in screen 5, screen 12 appears.

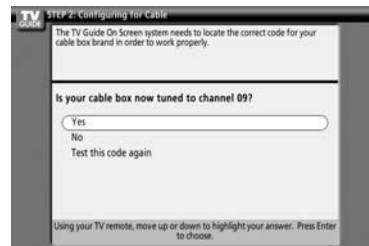

If your Cable box did not tune itself to channel 09 after testing and you want to test the same code again, select “Test this code again” and press ENTER.

If you want to test a different code, select No and press ENTER. Screen 10 appears.

Note: Many cable boxes require testing more than one code.

(Continued on next page)

Setting up the TV Guide On Screen™ system (continued)

Screen 12: Do you have an antenna connected?
Select either Yes or No, and then press ENTER. Screen 13 appears.

Note: If you selected NO in screen 3, you must select YES in this screen to receive a channel lineup and program listings.

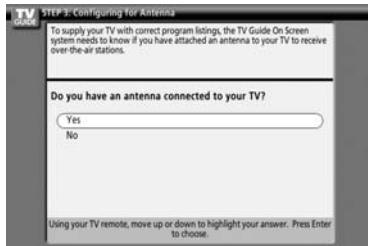

Screen 13: Are the settings correct?
If you select Yes, screen 14 appears.
If you select No, screen 1 appears.

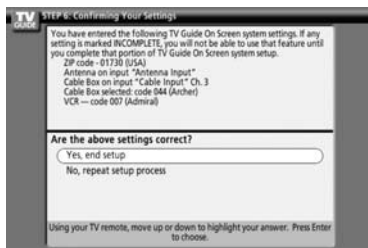

Screen 14: Congratulations! You have completed basic TV Guide On Screen™ system setup.

Note: Read the on-screen information regarding the amount of time it may take for listing information to download from the TV Guide On Screen™ service.

Press ENTER to display screen 15.



Screen 15: Is a VCR connected?
If you select Yes, screen 16 appears.
If you select No, screen 21 appears.

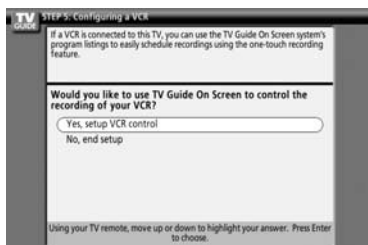

Screen 16: The on-screen diagram shows the correct way to connect your VCR to the G-LINK™ terminal on the TV. **Make sure the G-LINK™ cable is installed properly. For additional details, see page 25.**
Press ENTER to display screen 17.

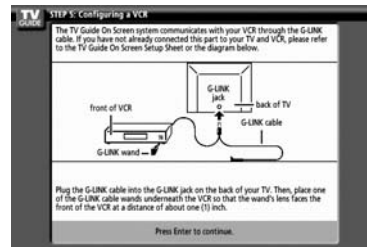

Screen 17: Select your VCR brand, and then press ENTER. Screen 18 appears.

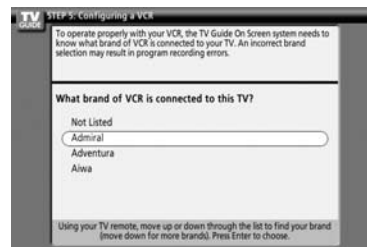

Screen 18: Turn on your VCR, insert a tape (either blank or previously recorded), and then press PLAY. Screen 19 appears.

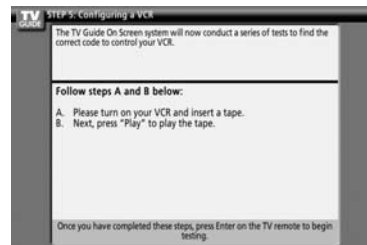

Screen 19: The TV Guide On Screen™ system will test the code for the brand of VCR you selected. Do not press any keys on the TV, remote control, or VCR until the testing process is completed. When testing is completed, screen 20 appears.

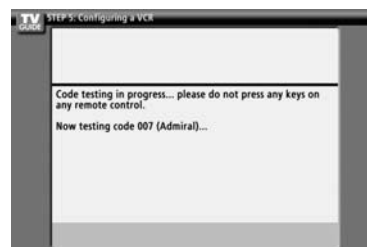

Setting up the TV Guide On Screen™ system (continued)

Screen 20: If your VCR stopped playing the tape after testing, select Yes and press ENTER. Screen 21 appears.

If your VCR did not stop playing the tape after testing and you want to test the same code again, select “Test this code again” and press ENTER.

If you want to test a different code, select No and press ENTER. Screen 19 appears.

Note: Many VCRs require testing more than one code.

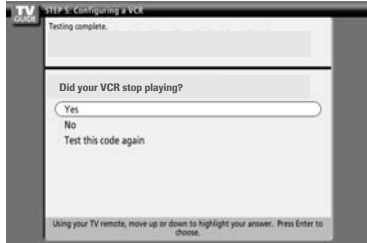

Screen 21: Review the setup information displayed on your TV screen (an example is shown below).

If the information on your TV screen is correct for your setup, select “Yes, end setup” and press ENTER. Screen 22 appears.

If the information is incorrect, select “No, repeat setup process” and press ENTER. Screen 1 appears.

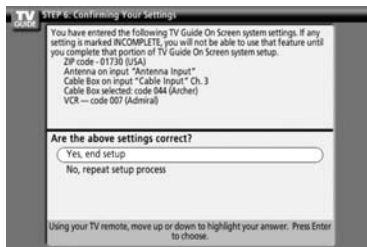

Screen 22: Congratulations! You have successfully completed TV Guide On Screen™ system setup.

Press ENTER to display screen 23.



Screen 23: This screen provides helpful information on using your TV Guide On Screen™ system.

Press ENTER to exit the TV Guide On Screen™ setup and watch TV.



TV Guide On Screen™ Reminder

The TV Guide On Screen™ system receives program listing data through your Cable or over-the-air video signal. In order to receive regular program listing updates, remember to do the following:

1. Leave the TV in standby mode when it is not in use by turning it OFF but leaving the power cord plugged in.
2. If you have a Cable box connected, leave it ON.
3. If you have a VCR connected, turn it OFF when not in use. (Do not unplug the power cord.) See page 13 for VCR connection instructions.
4. If you have more than one Cable system in your area, you may be prompted to select which Cable system's program data to download. If so prompted, follow the on-screen instructions.

Note: If the TV power cord is unplugged for an extended period of time, it may take up to 24 hours with the TV in standby mode (power cord plugged in and power OFF) to download the TV Guide On Screen™ program schedule. It may take up to a week before an entire program schedule is available.

Turning off the TV Guide On Screen™ automatic display feature

After you set up the TV Guide On Screen™ system, the program guide will display automatically (by default) when you turn on the TV. To turn off the automatic program guide:

1. Press TV GUIDE on the remote control to open the TV Guide On Screen™ system (if it is not already open).
2. Use the ◀▶ buttons to select the Setup menu.
3. Use the ▲▼ buttons to select “Change Default Options,” and then press ENTER.
4. Use the ▲▼ buttons to select “General Defaults,” and then press ENTER.
5. Set the “Auto Guide” option to Off.
6. Use the ▲▼ buttons to select Done, and then press ENTER.

6 Setting up your TV

For menu navigation instructions, see Chapter 4.

Selecting the menu language

You can choose from three different languages (English, French and Spanish) for the on-screen display of menus and messages. (The TV Guide On Screen™ menus are in English, regardless of the language selected in this menu.)

To select the menu language:

1. Press MENU and open the Preferences menu.
2. Highlight Menu Language and press ►.
3. Press ▲ or ▼ to select your preferred menu language and press ENTER.



4. Press EXIT to close the Preferences menu.

Configuring the antenna input sources

To configure the ANT 1 and ANT 2 input sources:

1. Press MENU and open the Setup menu.
2. Highlight Installation and press ENTER. (A new set of Installation menu icons will appear on-screen, as shown in step 3 below.)

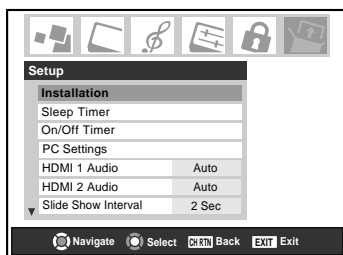

3. Open the Terrestrial menu, highlight Input Configuration, and press ENTER.

Note: The Terrestrial menu may not be accessible (items will be “grayed out”) in some instances (for example, if a cable box is connected to the ANT 1 input or if one of the VIDEO modes is the current input during TV Guide On Screen™ setup).

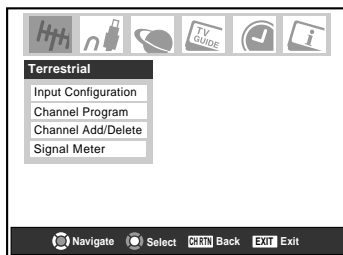

4. Press ◀ or ▶ to select the input source (Cable or Antenna) for the ANT 1 input on the TV.

Note: If a cable box is connected to the ANT 1 input during TV Guide On Screen™ setup, the entire Terrestrial menu will not be accessible, including the input source for ANT 1, which will automatically display “Cable Box.”

5. Press ▼ and then ◀ or ▶ to select the input source (Cable or antenna) for the ANT 2 input on the TV, if applicable. If you have not connected anything to ANT 2, skip this step.

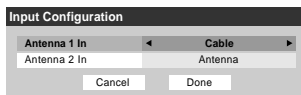

6. To save your new settings, highlight Done and press ENTER. To revert to your original settings, highlight Cancel and press ENTER.

Programming channels into the TV's channel memory

When you press CHANNEL ▲ or ▼ on the remote control or TV control panel, your TV will stop only on the channels stored in the TV's channel memory.

Follow the steps below to program channels into the TV's channel memory.

Programming channels automatically

Your TV can automatically detect all active channels in your area and store them in its memory. After the channels are programmed automatically, you can manually add or erase individual channels.

Note:

- You must configure the antenna input sources before programming channels (see page 41).
- If the input signal type is set to CABLE for an antenna input, the automatic channel programming process erases channels that were previously programmed into the TV's memory.
- If the input signal type is set to ANTENNA, the automatic channel programming process does NOT erase channels that were previously programmed into the TV's memory, but adds newly found channels to the existing set of programmed channels. To remove a channel from the memory, you must manually delete it (see next page).
- To tune the TV to a channel not programmed in the channel memory, you must use the Channel Number buttons on the remote control.
- Programming channels for an antenna input configured for CABLE will take substantially longer than for an antenna input configured for ANTENNA. This is normal; however, once channel programming is completed, you should not have to repeat the programming process again unless your Cable TV service lineup changes significantly.
- If you have a CableCARD™ inserted (page 12), channel programming for ANT 1 is disabled because the CableCARD™ automatically loads the Cable channel list into the TV's channel memory.

To program channels automatically:

1. Make sure you have configured the antenna input sources. See page 41 for details.
2. Press MENU and open the Setup menu.
3. Highlight Installation and press ENTER. (A new set of Installation menu icons will appear on-screen).

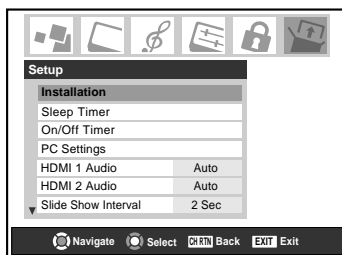

4. Open the Terrestrial menu, highlight Channel Program, and press ENTER.
5. Highlight ANT 1 or ANT 2, depending on which antenna input you want to program channels for, and then press ENTER to start automatic channel programming.

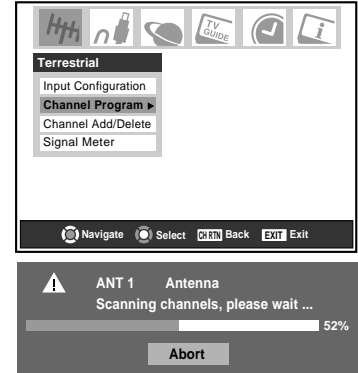

The TV will automatically cycle through all the channels for the antenna input you selected, and store all active channels in the channel memory. While the TV is cycling through the channels, the message “Scanning channels, please wait” appears (as shown above).

6. To cancel channel programming, either press EXIT or highlight Abort in the on-screen display and press ENTER. When channel programming is done, press CHANNEL ▲ or ▼ to view the programmed channels.

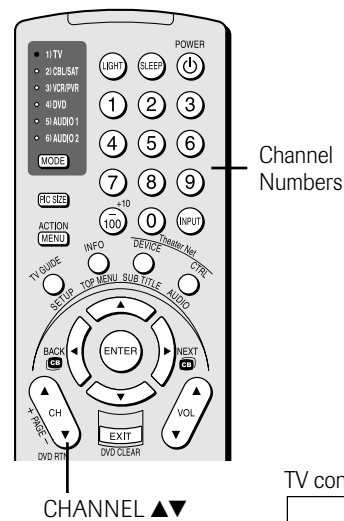

TV control panel

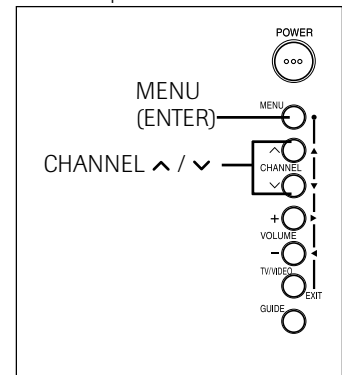

Programming channels into the TV's channel memory (continued)

Manually adding and deleting channels in the channel memory

After automatically programming channels into the channel memory, you can manually add or delete individual channels.

To add or delete channels in the channel memory:

1. Press MENU and open the Setup menu.
2. Highlight Installation and press ENTER. (A new set of Installation menu icons will appear on-screen, as shown in step 3).

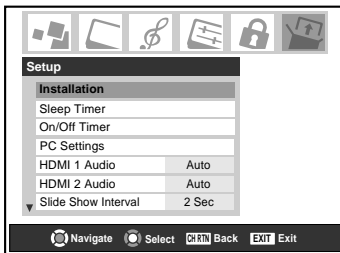

3. Open the Terrestrial menu, highlight Channel Add/Delete, and then press ENTER.

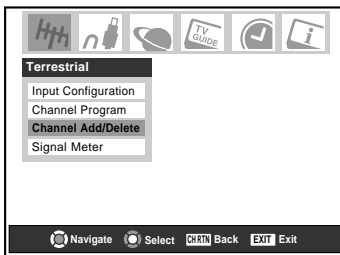

4. The illustration below left shows channels programmed for the ANT 1 antenna input. To view the list of channels programmed for the ANT 2 or Cable box antenna input, press the ▲ ▼ buttons to highlight either "ANT 2" or "Cable Box" and press ENTER.

Note: "Cable Box" will appear only if you connected a cable box to your TV.

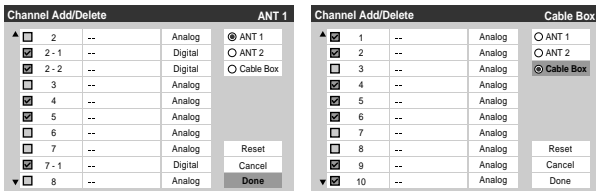

To add a channel to the channel memory:

Highlight the unchecked box next to the channel number you want to add, and then press ENTER to check the box.

To manually add digital subchannels on a physical channel:

Use the Channel Numbers and the Dash (–/100) on the remote control to enter the channel number (for example, 56–1).

If the channel is found, the number will be added to the list and the box will be checked.

If the channel is not found, a message will appear.

To remove a channel from the channel memory:

Highlight the checked box next to the channel number you want to remove, and then press ENTER to uncheck the box.

To save your new settings:

Highlight Done and press ENTER.

To revert to your original settings:

Highlight Cancel and press ENTER before saving.

To remove all channels from the channel memory:

Highlight Reset and press ENTER, and then highlight Done and press ENTER.

Note:

- This action applies to the current antenna input only. To delete/add channels on the other input, highlight the input you want (ANT1 or ANT 2) and press ENTER.
- This action cannot be cancelled unless you highlight Cancel and press ENTER before saving your changes.

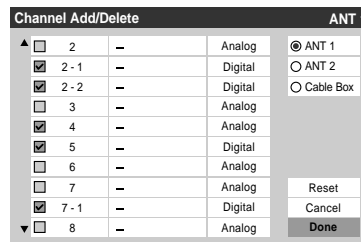

Programming your favorite channels

You can program up to 27 channels as favorite channels into three Favorite Channel sets (nine channels from the ANT 1 input, nine from the ANT 2 input, and nine from the Cable box input). You can then scan through your favorite channels only, skipping other channels you do not normally watch.

To add and delete channels in the Favorite Channels sets:

1. Press MENU and open the Preferences menu.
2. Highlight Favorite Channels and press ENTER.
3. Use the ▲▼ buttons to select either ANT 1, ANT 2, or Cable box and press ENTER.
4. Highlight Edit and press ENTER.

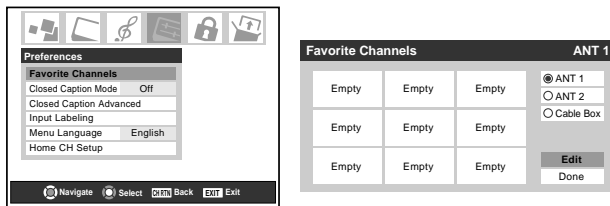

To add a channel to the selected Favorite Channel set: Use the ▲▼ buttons to highlight an unchecked box next to a channel you want to set as a favorite, and then press ENTER to check the box.

To delete the channel from the selected Favorite Channels set: Highlight a checked box and press ENTER to uncheck it.

Note: If you try to add more than nine favorite channels per input, an error message will appear. You will need to delete (uncheck) a channel before you can add another.

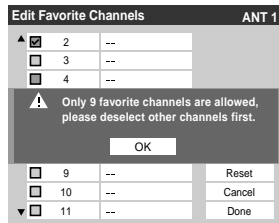

When done, highlight Done and press ENTER.

To program favorite channels for another input:

Either... Highlight ANT 1, ANT 2, or Cable Box, which will change the favorite channel settings in the selected input. (This will not change the TV's current input.)

Or... Press INPUT to select ANT 1, ANT 2, or Cable Box and then repeat steps 1–4.

“Cable Box” will appear only if you connected a cable box to your TV.

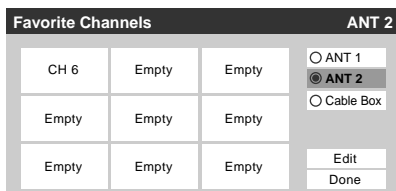

To clear your favorite channel lists:

1. Press MENU and open the Preferences menu.
2. Highlight Favorite Channels and press ENTER.
3. Highlight Edit and press ENTER.
4. Highlight Reset and press ENTER.
5. Highlight Done and press ENTER.

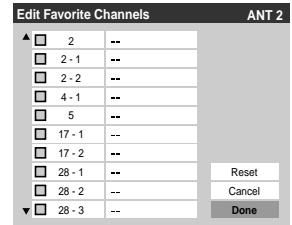

To tune your favorite channels for the current ANT input:

Press FAV CH ▲▼.

To tune your favorite channels using the favorite channel list:

1. Press 100 to display the favorite channel list.
2. Press the corresponding number button (1-9) to select your desired channel.

Note: To tune your favorite channels for another input, you will need to change the Input Selection first.

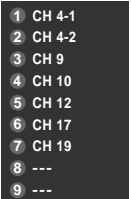

To quickly scan through your favorite channels in a nine picture multi-window (for the current ANT input):

Press FAV SCAN. See page 78 for details.

Note:

- To tune to a channel from the FAV SCAN mode, highlight a window and press ENTER.
- To scan your favorite channels for another input, you will need to change the Input Selection first.

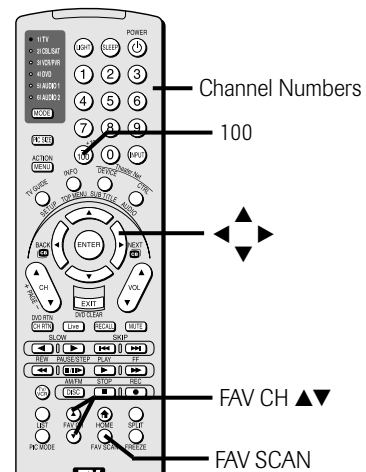

Setting up and using TheaterNet™ on-screen device control

The TheaterNet feature allows you to control many brands of IEEE1394 and/or infrared remote-controlled A/V devices through your TV using on-screen control icons and the TV's remote control.

Note:

- Although the TheaterNet on-screen device control feature includes codes for many devices, it may not include codes for some or all of the features on certain devices you wish to control. If you are unable to program the TheaterNet feature to operate your device or some of the features on that device, use the device's remote control or the controls on the device.
- For IR pass-through device control information, see "Controlling infrared remote-controlled devices through the TV (IR pass-through)" on page 21.

Setting up TheaterNet

All device types except IEEE1394 require the following setup process before you can control them using the TheaterNet on-screen icons.

All compatible IEEE1394 devices are automatically recognized by the TheaterNet feature and do not require setup.

Note: See page 22 for details about the IEEE1394 ports. If your IEEE1394 device is not recognized through the IEEE1394 port or through the TheaterNet feature, it may be possible to set it up for IR pass-through control as an infrared device (see page 21).

To set up TheaterNet device control:

1. Make sure you have properly connected your infrared remote-controlled device(s). See page 21 for details.
2. Press MENU and open the Setup menu.
3. Highlight Installation and press ENTER. (A new set of Installation menu icons will appear on-screen, as shown in step 4).

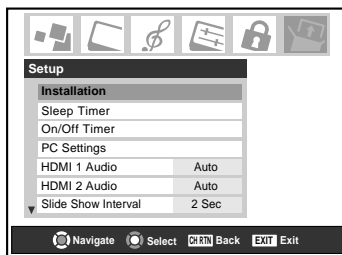

4. Open the Devices menu, highlight TheaterNet Devices, and then press ENTER.

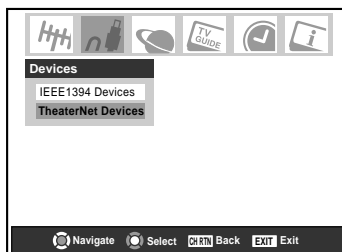

5. The TheaterNet Setup menu opens.

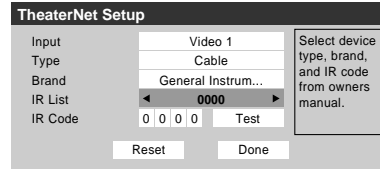

Using the ◀▶ buttons, select the Input the device is connected to.

Note: When the input is changed, all unsaved settings will be lost.

6. Press ▼ and then ◀▶ to select the device Type.
7. Press ▼ and then ◀▶ to select the device Brand.

Note: When selecting a new brand, the IR code will be set to 0.

8. Press ▼ and then ◀▶ to select the device's IR code.
9. If the desired IR code is found, skip to step 10.

If the desired IR code is not in the list, press ▼ and use the Channel Number buttons to enter the device IR code.

Note: You can find the IR code for your device in the on-screen list or in the TheaterNet device code table on pages 47–49.

10. Highlight Test and press ENTER to test whether the device responds to the code. If the device does not respond to the code, repeat steps 8 and 9 using another code for the same device.

When done, highlight Done and press ENTER or choose a different Input for which to setup TheaterNet device control.

To remove a device from TheaterNet:

1. Follow steps 1–5 above.
2. Highlight Reset and press ENTER.

Setting up and using TheaterNet™ on-screen device control (continued)

Using the TheaterNet control icons

1. Set up your infrared devices in TheaterNet, if you have not already done so (see page 45).

Note: IEEE1394 devices do not need to be set up in TheaterNet because they appear automatically in the TheaterNet menu.

2. Press DEVICE on the remote control to display the device control selection screen.

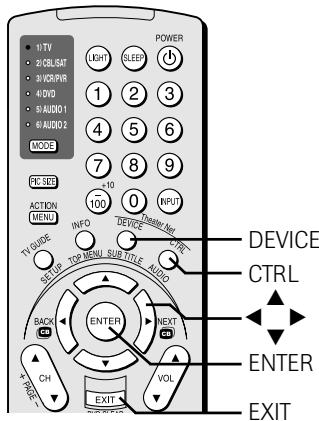

3. Using the ▲▼◀▶ buttons, highlight the device you want to control and press ENTER.

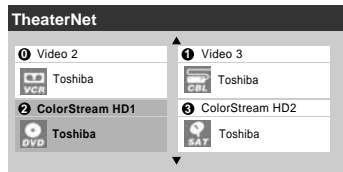

4. The input automatically changes to the input for the selected device, and the device's control icons display on-screen.

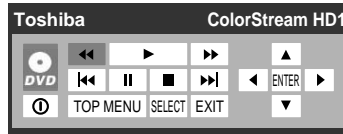

Highlight the icon for the function you want to control and press ENTER.

To select the device's control icons directly:

Press CTRL.

To close the on-screen control icons:

Press EXIT.

To view another source:

Press DEVICE and select the input source you want to view.

The following are examples of the TheaterNet on-screen control icons for various devices.

Toshiba Symbio™ AVHD Recorder control*

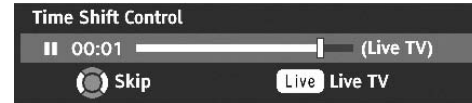

* If you connected a Toshiba *Symbio*™ AVHD Recorder, you must set up the TV Guide On Screen™ system in order to use the Symbio's full functionality. See Chapter 5 for details on setting up the TV Guide On Screen™ system. See pages 23 and 50 for further details about AVHD digital recorders.

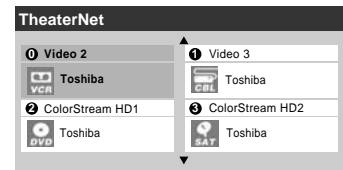

TheaterNet™ IR device codes (continued)

Video accessory (HDTV decoder)		Receivers (cont.)		VCRs	
Brand	Code	Brand	Code	Brand	Code
Panasonic	1120	Proscan	1254	Admiral	0048, 0209
Pioneer	1010	Quasar	0039	Adventura	0000
Princeton	0113, 0295	RCA	1023, 1254, 0080, 0531, 1390, 1609	Aiko	0278
Samsung	1190	Realistic	0181, 0195	Aiwa	0037, 0000
Sensory Science	1126	Samsung	1295	Akai	0041
Sharp	1010	Sansui	1089, 0189	America Action	0278
Receivers		Sanyo	0801, 1251	American High	0035
Brand	Code	Sharp	0186, 1286	Asha	0240
ADC	0531	Sherwood	0491, 0502, 1653	Audiovox	0037, 0278
Aiwa	1089, 1405, 0121, 0158, 0189, 0405, 1388, 1641	Sony	1058, 1258, 1158, 0158, 0474, 1367, 1558, 1658, 1758	Beaumarck	0240
Alco	1390	Soundesign	0670	Bell & Howell	0104
Anam	1609	Stereophonics	1023	Broksonic	0184, 0121, 0209, 0002, 0479, 1479
Apex Digital	1257	Sunfire	1313	CCE	0072, 0278
Arcam	1120	Teac	0463	Calix	0037
Audiotronic	1189	Technics	1308, 1309, 1518, 0039, 0309	Canon	0035
Audiovox	1390	Thorens	1189	Carver	0081
Bose	1229	Venturer	1390	Cineral	0278
Cambridge Soundworks	1370	Victor	0074	Citizen	0037, 0278, 1278
Capetronic	0531	Wards	0014, 0080, 0158, 0189	Colt	0072
Carver	1089, 1189, 0042, 0189	Yamaha	0176, 0186, 1176	Craig	0037, 0047, 0240, 0072
Casio	0195	Yorx	0195	Curtis Mathes	0060, 0035, 0162, 0041, 0760, 1035
Clarinette	0195	Zenith	0857	Cybernex	0240
Compaq	1136	Satellite receivers		Daewoo	0045, 0278, 1278
Curtis Mathes	0080	Brand	Code	Denon	0042
Daewoo	1250	AlphaStar	0772	Dynatech	0000
Denon	1104, 1160, 0004, 1360	Chaparral	0216	Electrohome	0037
Fisher	0042, 1801	Crossdigital	1109	Electrohome	0037
Garrard	0463	DishPro	1005, 0775	Emerex	0032
Harman/Kardon	0110, 0189, 0891	Echostar	1005, 0775	Emerson	0037, 0184, 0000, 0121, 0043, 0209, 0002, 0278, 0479, 1278, 1479
Hewlett Packard	1181	Expressvu	0775	Fisher	0047, 0104
JBL	0110, 1306	GE	0566	Fuji	0035, 0033
JVC	0074, 1374	GOI	0775	Funai	0000
KLH	1390	General Instrument	0869	GE	0060, 0035, 0240, 0760, 0807, 1035, 1060
Kenwood	1313, 1027, 1570, 1569, 0027, 0042, 0186	HTS	0775	Garrard	0000
Koss	1366	Hitachi	0819	Go Video	0432
LXI	0181	Hughes Network Systems	1142, 0749, 1749	GoldStar	0037, 0038, 1237
Lasonic	1798	JVC	0775	Gradiente	0000
Linn	0189	Magnavox	0724, 0722	HI-Q	0047
Lloyd's	0195	Memorex	0724	Harley Davidson	0000
MCS	0039	Mitsubishi	0749	Harman/Kardon	0081, 0038
Magnavox	1089, 1189, 0189, 0195, 0391, 0531	Motorola	0869	Harwood	0072
Marantz	1089, 1189, 0039, 0189	Next Level	0869	Headquarter	0046
Modulaire	0195	Panasonic	0247, 0701	Hitachi	0000, 0042, 0041
Musicmagic	1089	Paysat	0724	Hughes Network Systems	0042
Nakamichi	0097	Philips	1142, 0749, 0724, 1076, 0722, 1749	JVC	0067, 0041
Onkyo	0135, 0842, 1298	Proscan	0392	Jensen	0041
Optimus	1023, 0042, 0080, 0181, 0186, 0531, 0670, 0738, 0801	RCA	0392, 0566, 0855, 0143	KEC	0037, 0278
Panasonic	1518, 0039, 0309, 0367	RadioShack	0869	KLH	0072
Penney	0195	SKY	0856	Keen	0693
Philips	1089, 1189, 1269, 0189, 0391, 1120	Samsung	1109	Kenwood	0067, 0041, 0038
Pioneer	1023, 0014, 0080, 0150, 0244, 0531, 0630, 1384	Sony	0639	Kodak	0035, 0037
Polk Audio	0189	Star Choice	0869	LXI	0037
		Toshiba	0749, 0790, 1052, 1053, 1054, 1285, 1286, 1287, 1289, 1749	Lloyd's	0000
		Uniden	0724, 0722	Logik	0072
		Zenith	0856, 1856	MEI	0035
				MGA	0240, 0043
				MGN Technology	0240
				MTC	0240, 0000
				Magnasonic	1278

TheaterNet™ IR device codes (continued)

VCRs (cont.)		VCRs (cont.)		DVD players (cont.)	
Brand	Code	Brand	Code	Brand	Code
Magnavox	0035, 0039, 0081, 0000, 0149, 0563, 1781	Scott	0184, 0045, 0121, 0043	Hitachi	0573, 0664
Magnin	0240	Sears	0035, 0037, 0047, 0000, 0042, 0104, 0046, 1237	Hiteker	0672
Marantz	0035, 0081	Semp	0045	JBL	0702
Marta	0037	Sharp	0048, 0807, 0848	JVC	0558, 0623, 0867
Matsushita	0035, 0162, 0454	Shintom	0072	KLH	0717
Memorex	0035, 0162, 0037, 0048, 0039, 0047, 0240, 0000, 0104, 0209, 0046, 0454, 0479, 1037, 1162, 1237, 1262	Shogun	0240	Kenwood	0490, 0534, 0682, 0737
Minolta	0042	Singer	0072	Konka	0711, 0719, 0720, 0721
Mitsubishi	0067, 0043, 0807	Sonic Blue	0614, 0616	Koss	0651
Motorola	0035, 0048	Sony	0035, 0032, 0000, 0033, 0636, 1032, 1232	Lasonic	0798
Multitech	0000, 0072	Sylvania	0035, 0081, 0000, 0043, 1781	Magnavox	0503, 0675
NEC	0104, 0067, 0041, 0038	Symphonic	0000	Malata	0782
Nikko	0037	TMK	0240	Marantz	0539
Noblex	0240	Tatung	0041	Microsoft	0522
Olympus	0035	Teac	0000, 0041	Mintek	0717
Optimus	1062, 0162, 0037, 0048, 0104, 0432, 0454, 1048, 1162, 1262	Technics	0035, 0162	Mitsubishi	0521
Orion	0184, 0209, 0002, 0479, 1479	Teknika	0035, 0037, 0000	Nesa	0717
Panasonic	1062, 0035, 0162, 0225, 0454, 0616, 1035, 1162, 1262	Thomas	0000	Next Base	0826
Penney	0035, 0037, 0240, 0042, 0038, 1035, 1237	Tivo	0618, 0636	Norcent	0872
Pentax	0042	Toshiba	0045, 0043, 0845	Onkyo	0503, 0627
Philco	0035, 0209, 0479	Totevision	0037, 0240	Oritron	0651
Philips	0035, 0081, 0618, 1081, 1181	Unitech	0240	Panasonic	0490, 0632, 1362, 1462, 1490
Pilot	0037	Vector	0045	Philips	0503, 0539, 0646, 0854
Pioneer	0067	Vector Research	0038	Pioneer	0525, 0571, 0632
Polk Audio	0081	Video Concepts	0045	Polk Audio	0539
Profitronic	0240	Videomagic	0037	Princeton	0674
Proscan	0060, 0760, 1060	Videosonic	0240	Proscan	0522
Protec	0072	Villain	0000	RCA	0522, 0571, 0717, 0822
Pulsar	0039	Wards	0060, 0035, 0048, 0047, 0081, 0240, 0000, 0042, 0072, 0149, 0760	Rotel	0623
Quarter	0046	White Westinghouse	0209, 0072, 1278	Rowa	0823
Quartz	0046	XR-1000	0035, 0000, 0072	Sampo	0698
Quasar	0035, 0162, 0454, 1035, 1162	Yamaha	0038	Samsung	0573, 0820
RCA	0060, 0240, 0042, 0149, 0760, 0807, 1035, 1060	Zenith	0039, 0000, 0209, 0033, 0479, 1479	Sansui	0695
RadioShack	0000, 1037			Sanyo	0670
Radix	0037	DVD players		Sharp	0630
Randex	0037	Brand	Code	Sherwood	0633
Realistic	0035, 0037, 0048, 0047, 0000, 0104, 0046	Aiwa	0641	Shinsonic	0533
ReplayTV	0614, 0616	Apex Digital	0672, 0717, 0755, 0794, 0796, 0797, 0830, 0856, 1100	Sony	0533, 0864, 1533
Runco	0039	Audiologic	0736	Sylvania	0675, 0821
STS	0042	B & K	0655, 0662	Technics	0490
Samsung	0240, 0045	Blue Parade	0571	Techwood	0692
Sanky	0048, 0039	Broksonic	0695	Theta Digital	0571
Sansui	0000, 0067, 0209, 0041, 0479, 1479	DVD2000	0521	Toshiba	0503, 0695, 1045
Sanyo	0047, 0240, 0104, 0046	Daewoo	0784	Tredex	0800
		Denon	0490, 0634	Urban Concepts	0503
		Emerson	0591	XBox	0522
		Enterprise	0591		
		Fisher	0670		
		GE	0522, 0717		
		GPX	0699, 0769		
		Go Video	0715		
		Gradiente	0651		
		Greenhill	0717		
		Harman/Kardon	0582, 0702		

Setting the AVHD device skip time

When you connect an external AVHD (audio/video hard drive) device—such as the Toshiba Symbio™ AVHD Recorder—to one of the TV's IEEE1394 ports, you can use the AVHD device skip time feature to set the number of minutes the device will skip forward or backward when you press the SKIP buttons.

Note:

- This TV will work best with the Toshiba *Symbio*™ AVHD Recorder for recording high definition and standard definition material from either tuner and for controlling live TV (pause/rewind/etc.). When the Symbio AVHD Recorder is connected to the TV, the remote control keys (LIVE, STOP, REW, PAUSE, PLAY, etc.) are automatically activated to allow pausing of live TV.
- When you connect an AVHD (or D-VHS) device, the TV Guide On Screen™ system is automatically configured to allow recording. See page 23 for device connection information. See Chapters 5 and 7 for details about setting up and using the TV Guide On screen™ system.

To set the AVHD device skip time:

1. Press MENU and open the Setup menu.
2. Highlight AVHD Skip Time and press ►.
3. Press ▲ or ▼ to select the AVHD skip time (1, 3, 5, or 15 minutes) and press ENTER.

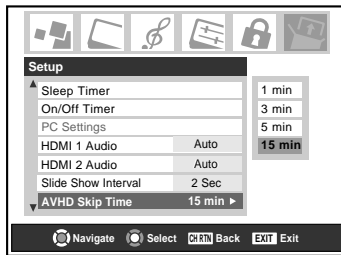

Setting the HDMI™ audio mode

To select the HDMI audio mode:

1. Press MENU and open the Setup menu.
2. Highlight HDMI 1 (or 2) Audio and press ►.
3. Press ▼ or ▲ to select the HDMI audio mode (Auto, Digital, or Analog) and press ENTER. (Auto is the recommended mode). See “Connecting an HDMI or a DVI device to the HDMI input” on page 19.

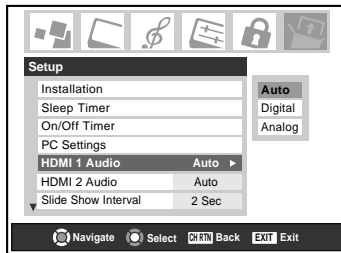

Setting the time and date

Note: If you already set up the TV Guide On Screen™ system, the time and date were set automatically and you can skip this step.

To set the time and date:

1. Press MENU and open the Setup menu.
2. Highlight Installation and press ENTER. (A new set of Installation menu icons will appear on-screen, as shown in step 3 below.)
3. Open the Time And Date menu, highlight Start Setup, and press ENTER.

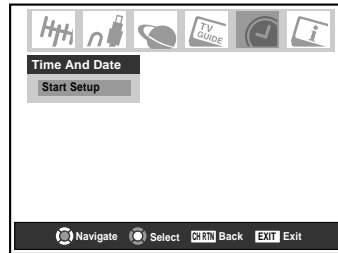

If you have not set up the TV Guide On Screen™ system, or if you have not set up the time, the following screen will appear. To set the time, highlight TV Guide On Screen™ and press ENTER. The TV Guide On Screen™ setup sequence will start, and the time and date will be set automatically.

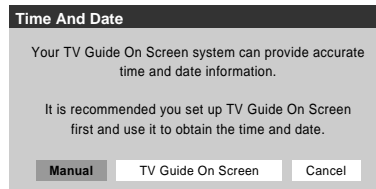

If you have already set up the TV Guide On Screen™ system, the time and date setting screen will appear and you will need to manually set the time and date.

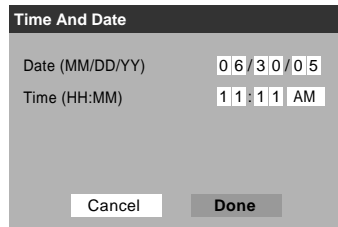

Note:

- If you highlight TV Guide On Screen™ (above) to set the time and date through the TV Guide On Screen™ system and a power outage occurs, the time and date will be updated automatically when the power is restored.
- If you highlight Manual (above) to set the time and date manually and a power outage occurs, you will lose the time and date settings when the power is restored.
- If you manually set the time and date and then perform TV Guide On Screen™ setup, the manual time and date settings will be overridden by the TV Guide On Screen™ settings.

Viewing the CableCARD™ menu

A CableCARD™ enables you to view encrypted digital channels. See page 12 for connection and subscription information. After the CableCARD™ is inserted, a CableCARD™ option appears in the Applications menu, with informational screens provided by your digital CableCARD™ service (see illustrations below).

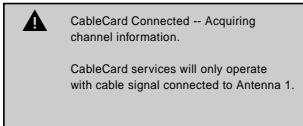

To view the CableCARD™ menu:

1. Press MENU and open the Applications menu.
2. Highlight CableCARD™ and press ►.
3. Press ▼ or ▲ to select one of the side menu items and press ENTER to display the information.

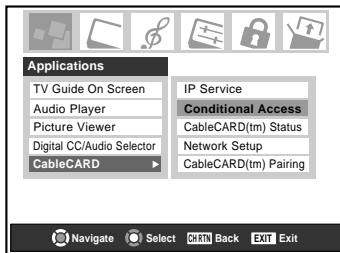

Note: The CableCARD™ menu is for informational purposes only and has no user-adjustable options.

Setting the Quick Restart Feature

With the Quick Restart feature set to ON, the TV will stay in Low Power Shutdown mode for several minutes after the TV is turned off (see Notes below).

If the TV is turned on from Low Power Shutdown mode, the full picture appears immediately.

To set the Quick Restart feature:

1. Press MENU, and then press ◀ or ▶ until the Setup menu appears.
2. Highlight Quick Restart and press ►.
3. Press ▼ or ▲ to select either On or Off.

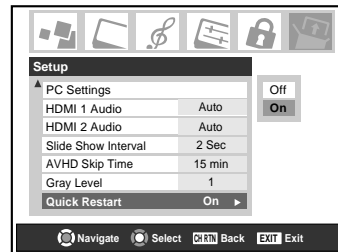

Note:

If Quick Restart is set to Off and you turn off the TV, it can take several seconds for the picture to appear when you turn on the TV again.

If Quick Restart is set to On and you turn off the TV, the following will occur for a few minutes:

- The screen (lamp) lights dimly.
- The fans continue to run.

This is a function of the Quick Restart Low Power Shutdown mode and is not a TV malfunction. If you do not prefer this, set the Quick Restart feature to Off.

When the Quick Restart feature is set to Off, if you repeatedly turn the TV on and off in a short period of time, the useful service life of the lamp may be shorter than the average useful service life. See page 103.

Viewing the digital signal meter

You can view the digital signal meter for ANT 1 and ANT 2 digital TV input sources only.

To view the digital signal meter:

1. Press MENU and open the Setup menu.
2. Highlight Installation and press ENTER. (A new set of Installation menu icons will appear on-screen, as shown in step 3 below.)

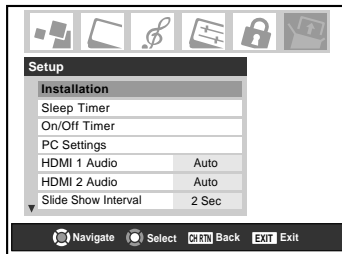

3. Open the Terrestrial menu, highlight Signal Meter, and press ENTER.

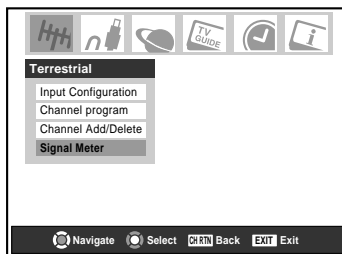

4. Use the ▲▼◀▶ to select the antenna input and digital channel whose signal you want to check.

Note: The physical digital channel number listed in the Signal Meter screen may not correspond to a virtual TV channel number. Contact your local broadcasters to obtain the RF channel numbers for your local digital stations.

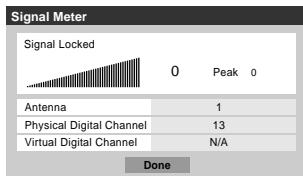

To close the screen and return to the Terrestrial menu:

Highlight DONE and press ENTER.

To return to normal viewing:

Press EXIT.

Viewing the system status

To check the system status:

1. Press MENU and open the Setup menu.
2. Highlight Installation and press ENTER. (A new set of Installation menu icons will appear on-screen, as shown below right).

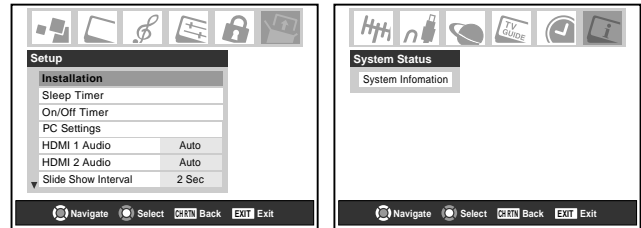

3. Open the System Status menu, highlight System Information, and then press ENTER.
4. Use the ◀▶ to scroll through the menu bar to check the Product Information and Software Version.

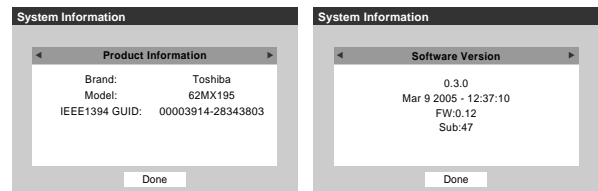

To close the screen and return to the Installation menu:

Highlight DONE and press ENTER.

To return to normal viewing:

Press EXIT.

Restore Factory Defaults

To restore all settings and channels to their factory default values:

1. Follow steps 1–3 above.
2. Use the ◀▶ to scroll through the menu bar to select Factory Defaults.
3. Enter your PIN code (or 0000 if no PIN code has been set).
4. Highlight Yes and press ENTER. The TV will turn off automatically after a few seconds. After the TV turns off, unplug the TV power cord and then plug it in again to complete the restore process.

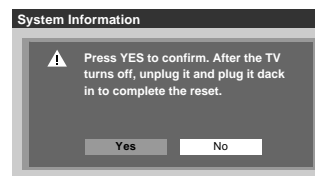

To cancel the reset:

Highlight No and press ENTER.

7 Using the TV Guide On Screen™ interactive program guide

The TV Guide On Screen™ system is a free, interactive, on-screen program guide built in to your Toshiba TV that lists schedules and information for TV programs in your area.

Note: Over-the-air or cable access to stations carrying TV Guide On Screen™ data is required for the TV Guide On Screen™ system to operate. TV Guide On Screen™ system does not work with satellite programming. Toshiba does not provide the TV Guide On Screen™ data; rather, such data is provided by a third party, which is responsible for its accuracy and availability. Additionally, occasional compatibility issues may exist between the TV Guide On Screen™ system contained in your TV and the data provided by the third party. If you experience any performance issues with your TV Guide On Screen™ system, please contact the following:

- **In the U.S.,** call TACP Consumer Solutions at (800) 631-3811 or visit <http://www.tacp.com/customersupport/contact.asp>.
- **In Canada,** call TCL Customer Service at 1-800-268-3404

The TV Guide On Screen™ system includes the following features:

- **Streamlined on-screen assisted setup**—Quickly and easily set up your TV Guide On Screen™ system using the on-screen prompts (see “Setting up the TV Guide On Screen™ system” below).
- **Program listings and INFO windows**—Scroll through eight days of TV listings and view program information such as rating, stereo, HDTV, new episode.
- **Watch TV and display TV Guide On Screen™ information simultaneously.**
- **Channel lineup customization**—Customize your channel lineup so your favorite stations are listed first.

- **Direct tuning**—Directly tune the TV to a current program you want to watch by selecting it in the program guide.
- **Reminders**—Schedule show reminders that will either display an on-screen notification banner or automatically tune the TV to the channel of the show for which you set the reminder.
- **Recording**—Easily schedule recording of one or more programs.
Note: A VCR or IEEE1394 recording device is required for recording. It is recommended that you connect your devices according to the instructions in Chapter 2.
- **Search**—Search for shows by category, keyword, or alphabetically.
- **On-screen help**—The TV Guide On Screen™ system contains on-screen feature definitions and navigation instructions.

To open the TV Guide On Screen™ system:

- While watching TV, press the TV GUIDE button on the remote control; —or—
- Press MENU, open the Applications menu, highlight TV Guide On Screen™, and press ENTER.



Note: After setting up the TV Guide On Screen™ system, the program guide opens automatically by default when you turn on the TV. To turn off this feature, see page 40.

Setting up the TV Guide On Screen™ system

Follow these instructions to set up the TV Guide On Screen™ system so it can receive current program data for your area.

Note: If you move the TV to a different ZIP/postal code, you will need to perform the TV Guide On Screen™ Setup process to reconfigure your TV Guide On Screen™ system.

If you have not already connected your antenna, cable box, and/or recording device, see Chapter 2 for connection instructions.

Note: You must connect a VCR or an IEEE1394 compatible recording device to use the TV Guide On Screen™ system's one-touch recording feature. It is recommended that you connect your devices according to the connection instructions in Chapter 2.

The unauthorized recording, use, distribution, or revision of television programs, videotapes, DVDs, and other materials is prohibited under the Copyright Laws of the United States and other countries, and may subject you to civil and criminal liability.

1. Press MENU and open the Setup menu.
2. Highlight Installation and then press ENTER to open the Installation menus. (A new set of menu icons will appear on-screen, as shown in step 3 below.)
3. Open the TV Guide On Screen™ Setup menu, highlight Start, and then press ENTER.

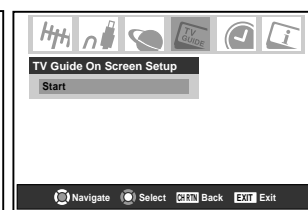
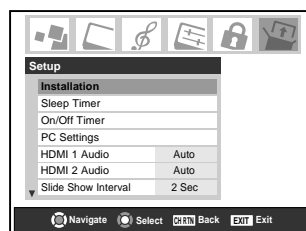

4. Go to Chapter 5 for instructions on completing the setup. Read this chapter for details on using the TV Guide On Screen™ interactive program guide.

Navigating the TV Guide On Screen™ system

- While watching TV, press the TV GUIDE button to enter the TV Guide On Screen™ system. The LISTINGS screen will appear with the current show highlighted.
- When in the TV Guide On Screen™ system, if you press the TV GUIDE button from any screen, the TV will tune to the show displayed in the Video Window.
- Use the arrow keys on the remote control (▲▼◀▶) to highlight any show, and then press ENTER to tune to that show.
- Scroll left or right (◀▶) to view eight days of listings.
- Press MENU to display a panel menu with options for the currently highlighted program or tile, including setting recordings and reminders.
- To access another Service screen:
 1. Press ▲ to highlight the Service Bar.
 2. Press ◀ or ▶ to highlight a different Service (LISTINGS, SEARCH, SETUP, SCHEDULE, or RECORDINGS).
 3. Press ▼ to use that Service.

Note: Helpful information about each Service appears in the Info Box.

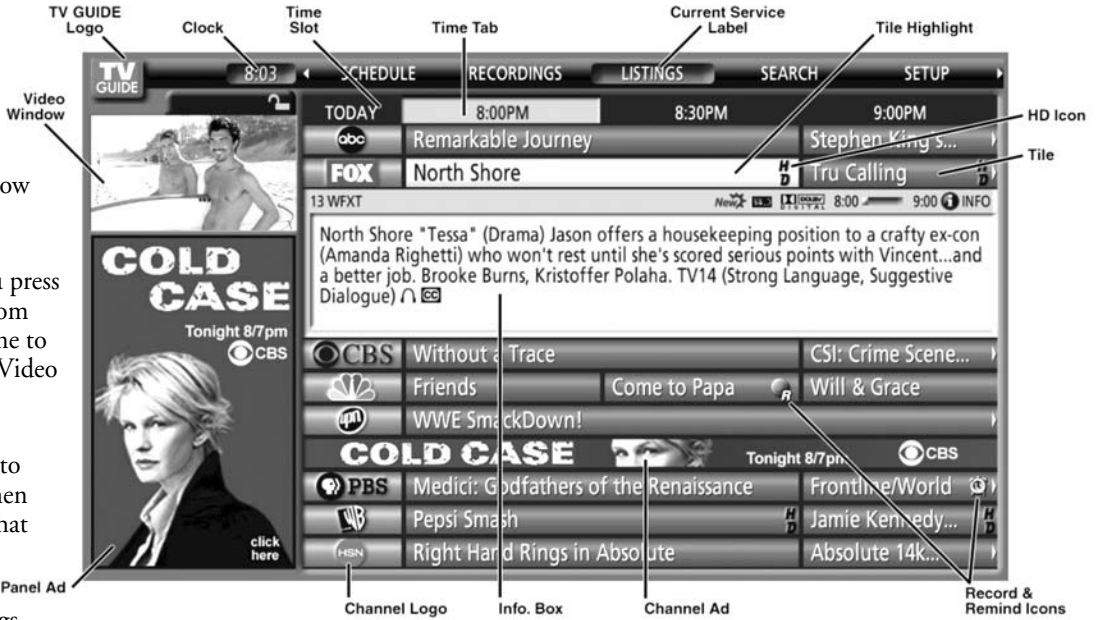

Note:

- The TV Guide On Screen™ menus shown in this manual are for illustration purposes only. The channels, programs, and TV Guide On Screen™ information as illustrated may not be available in your area. The options and features as illustrated are subject to change when updates are downloaded from the TV Guide On Screen™ service to your TV.
- The TV Guide On Screen™ interactive program guide supports cable-ready, cable box, and digital cable services, as well as over-the-air broadcasts. It does not provide listings for satellite services.

TV Guide On Screen™ remote control functions

BUTTON	FUNCTION
TV GUIDE	<ul style="list-style-type: none"> • When watching TV, enters the TV Guide On Screen™ system and highlights the current show listing. • When in the TV Guide On Screen™ system, returns to watching TV and displays the show in the Video Window.
Numbers	• For direct channel tuning, priority ordering, and channel editing.
– (digital separator)	• For entering digital channel numbers.
MENU	• Displays the panel menu, in which you can choose options (for example, record, remind, keyword).
INFO	• Cycles between levels of information, as available, in a Service screen or other type of screen.
ENTER	<ul style="list-style-type: none"> • Makes a selection or executes an action. • With a currently airing show listing highlighted, returns to watching TV and tunes to the show channel. • With a future airing show listing highlighted, displays a panel menu with viewing options.
▲▼◀▶	<ul style="list-style-type: none"> • Provide directional control. • When watching TV, ▲ and ▼ provide surfing through channels turned ON in the LISTINGS screen.
PAGE UP/DOWN	• When in the TV Guide On Screen™ system, moves from one set of screen information to the next, when applicable.
REC	• When in the TV Guide On Screen™ system or watching TV, initiates the recording process.
SPLIT	• When in the TV Guide On Screen™ system, toggles between locking and unlocking the Video Window.
▶▶ and ◀◀	• Jump forward and backward one day in the LISTINGS screen.

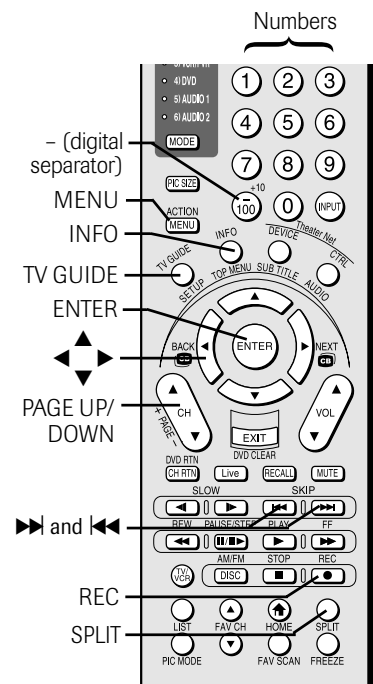

Navigating the TV Guide On Screen™ system (continued)

Video Window

- When you open the TV Guide On Screen™ system, the current program appears in the Video Window.
- As you scroll through the listings, the Video Window will change to display the selected program.
- The lock/unlock icon indicates the status of the Video Window.
- You can set the Video Window to remain on a single channel (locked) or to change channels (unlocked) as you navigate through listings.



Info Box

To lock/unlock the Video Window:

Press the SPLIT button on the remote control to toggle between locking and unlocking the Video Window.

—or—

Highlight a channel logo or the LISTINGS Service Bar Label and press MENU to display the option to lock/unlock the Video Window.

Panel Menus

- A panel menu appears:
 - when you press MENU on a highlighted tile (if additional options are available); or
 - when you press ENTER on a show starting in the future.
- When a panel menu appears, the highlighted tile changes color to indicate that the panel menu relates to the tile.
- Press INFO to display help for the current panel menu.
- Press ▲ and ▼ to move among the options.
- Press ◀ and ▶ to move to adjacent options or, if the highlight is on a odometer, to change the odometer choice.
- To move the highlight to the default command button, press ENTER from an odometer or entry box.
- To execute the action and close the panel menu, highlight the command button and press ENTER.
- To cancel any changes and close the panel menu:
 - press MENU; or
 - highlight Cancel and press ENTER.
- If a panel menu contains more options than can be displayed in one panel, the word “more” appears at the bottom of the menu. To access the additional options, either scroll down using the ▼ button or the PAGE UP/DOWN (CH ▲▼) button.

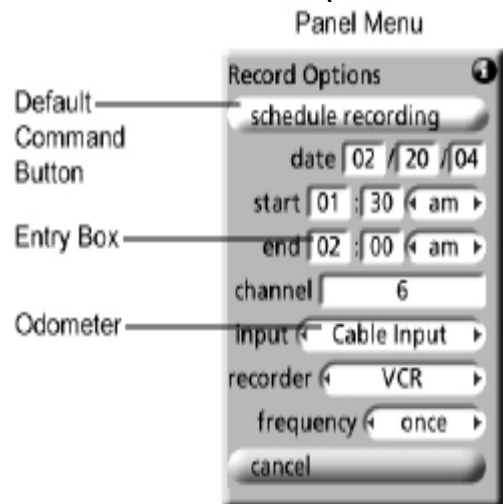

Panel Menu

Navigating the TV Guide On Screen™ system (continued)

Info Box

- An Info Box contains information about a show, Service, or Panel Ad, or provides general help (for example, for a panel menu).
- An Info Box for a program in the LISTINGS screen can have up to three sizes: Small, Large, or “No.”
 - Press INFO on the remote control to cycle among the sizes.
 - The default Info Box size is Small. To change the default size, open the SETUP Service screen (see page 66).
- The Info Button icon ( INFO) appears on the Info Action Bar if the Info Box size can change and/or if there are additional Info screens. Press the INFO key on the remote control to change the size and/or to display additional Info screens.
- In some instances, the INFO button on the remote control is used to page forward (for example, if there are additional pages of information in a Panel Ad, a Channel Ad, or help text).

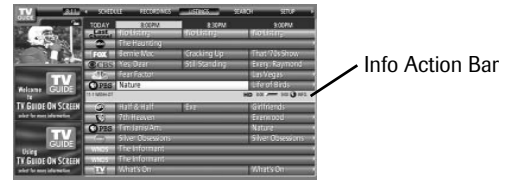

Info Action Bar

















Small Info Box



Large Info Box

TV Guide On Screen™ Icons

ICON	NAME	DESCRIPTION
 INFO	Info Button	• Additional Info Box information is available, or the Info Box has additional sizes.
	Progress Bar	• Elapsed time in current show. • Progress bar appears in LISTINGS and SEARCH and when the Info Button is pressed while watching TV.
	HDTV	• Show is presented in high-definition TV, if available.
	New	• Show is new (not a repeat).
	Stereo	• Show is available in stereo.
	Dolby Digital	• Show is available with Dolby Digital 5.1 audio (digital channels only).
	CC	• Closed captioning is available for the show.
	TV Rating	• TV rating for the show.
	Record Once	• Show is set to Record Once. • Other frequencies are Daily (manual recording only), Regularly, and Weekly.
	Record Off	• Show is set to Record but is currently Off (show remains in Schedule).
	Record Suspended	• Show is Suspended due to a schedule conflict (show remains in Schedule). • Recording resumes when the conflict no longer exists.
	Remind Once	• Show is set to Remind Once. • Other frequencies are Daily (manual reminding only), Regularly, and Weekly.
	Remind Off	• Show is set to Remind but is currently Off (show remains in Schedule).
	Remind Suspended	• Show is Suspended due to a schedule conflict (show remains in Schedule). • Remind resumes when the conflict no longer exists.



TV Guide On Screen™ Services

The TV Guide On Screen™ system consists of five main services: LISTINGS, SEARCH, RECORDINGS, SCHEDULE, and SETUP.

Note:

- For the RECORDINGS service to display, an IEEE1394 recording device must be connected to the television (see Chapter 2); otherwise, only four services display. Recording to other devices, such as a VCR, are possible from within the LISTINGS service.
- When using the TV Guide On Screen™ system to record a program for the first time, it is recommended that you perform a test recording to make sure your system is set up properly.
- If the power is cut or the plug becomes disconnected during timer recording, any recorded contents will be lost.
- If the TV power cord is unplugged for an extended period of time, it may take up to 24 hours with the TV in standby mode (power cord plugged in and power OFF) to download the entire TV Guide On Screen™ program schedule. It may take up to a week before an entire program schedule is available. Be sure to follow the instructions under “TV Guide On Screen™ Reminder” on page 40.

LISTINGS screen

- When you open the TV Guide On Screen™ system, LISTINGS is always the first service displayed.



- With LISTINGS highlighted in the Service Bar, press INFO to display a help screen. Press INFO again to close the screen.

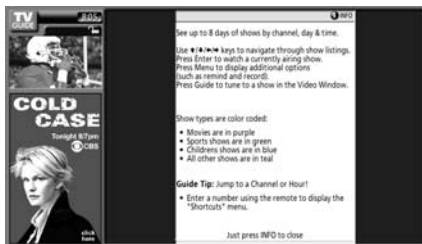

- Use the arrow keys to move the highlight within LISTINGS to do the following:
 - View eight days of show listings
 - Read show descriptions



- Tune directly to a show currently airing
- Set a show to Remind (e.g., start time, frequency, automatic power ON, auto-tune TV)
- Set a show to Record (e.g., start/end time, frequency)
- Lock and unlock the Video Window
- Access panel ads and channel ads

- Use the Number keys on the remote control to jump to a specific channel's listings.
- To watch a show (if on now), highlight the show and press ENTER.
- To display the Episode Options panel menu for a particular show, highlight a show and press MENU.



Episode Options panel menu

From the Episode Options panel menu, you can choose to set a recording, set a reminder, or tune to the channel. The following are descriptions of the buttons.

GO TO SERVICE BAR: Closes the menu, changes no information, and returns to the Service Bar.

TUNE TO CHANNEL / WATCH NOW: Exits the TV Guide On Screen™ system and tunes to the channel of the highlighted show (if the show airs in the future) or tunes to the show (if the show is currently airing). The button label changes according to whether the show is currently airing or not.

SET RECORDING: Displays the Record Options panel menu, from which you can set the show to record. For additional information, see “SCHEDULE screen” and “Record features” on page 61.

SET REMINDER: Displays the Remind Options panel menu, from which you can set a reminder for the show. For additional information, see “SCHEDULE screen” on page 61 and “Remind features” on page 63.

CANCEL: Closes the menu, changes no information, and returns to the highlighted show.

TV Guide On Screen™ Services (continued)

SEARCH screen

- SEARCH allows you to find shows by keyword, alphabetically, or by category (HDTV, Movies, Sports, Children, Educational, News, Variety, Series).



- With SEARCH highlighted in the Service Bar, press INFO to display a help screen. Press INFO again to close the screen.



- Use the arrow keys to move the highlight within SEARCH.

Example: Category search

- From the SEARCH screen, press ▼ to highlight a category (in this example, MOVIES).



- Press ▼ to highlight a subcategory (in this example, ALL).



- Press ENTER to display a list of all movies, organized by date and time.



- Highlight a show and press ENTER to watch (if on now) or press MENU to display the Episode Options panel menu. (See "Episode Options panel menu" on page 57.)



TV Guide On Screen™ Services (continued)

SEARCH screen (continued)

Example: Keyword search

Keyword search lets you enter a word(s) to find a particular show by category or for every show title that matches.

1. From the SEARCH screen, highlight KEYWORD, and then press ENTER.
2. Highlight NEW SEARCH in the panel menu, and then press ENTER.



3. The Search Options panel menu opens. Highlight CATEGORY, and then use the arrow keys to highlight a category to search (All, HDTV, Children, Sports, etc.).
4. After highlighting a category, press ▼ to highlight ENTER KEYWORD, and then press ENTER.



5. The keyboard is displayed. Use the arrow keys to highlight a character and then press ENTER to display it. When finished entering all characters, highlight DONE and press ENTER.



6. A list of all matching shows for that keyword is displayed.



7. Highlight a show and press ENTER to display all airings. Then highlight a specific listing and press ENTER to watch (if on now) or press MENU to display the Episode Options panel menu. From the Episode Options menu, you can choose to set a recording or reminder, or tune to the channel (see “Episode Options panel menu” on page 57.)



The TV Guide On Screen™ system stores all the keywords you create.

To edit or delete a keyword:

From the SEARCH/KEYWORD screen, highlight the keyword you want to edit or delete, and then press MENU to display the Search Options panel menu, with the following options:

- GO TO SERVICE BAR: Closes the menu, changes no information, and returns to the Service Bar.
- EDIT SEARCH: Displays the keyboard, from which you can change the keyword.



- DELETE SEARCH: Displays the Confirmation panel menu. Select YES to delete the search or NO to close the panel menu.
- CANCEL: Closes the panel menu, changes no information, and returns to the highlighted show.

TV Guide On Screen™ Services (continued)

RECORDINGS screen

The RECORDINGS service screen displays a list of previously recorded or currently recording shows on an IEEE1394 recording device connected to the TV (see Chapter 2).

Note: RECORDINGS will not appear in the Service Bar unless you have an IEEE1394 video recording device connected to one of the IEEE1394 ports on the TV. See Chapter 2 for details.

For additional details, see “Record features” on page 61.

- With RECORDINGS highlighted in the Service Bar, press INFO to display a help screen. Press INFO again to close the screen.



To choose the way recordings are displayed:

1. Highlight RECORDINGS on the Service Bar, and press MENU to display the Recording Options panel menu.
2. Press ▲▼ to choose between View As and Sort By, as described below.

View As: Press ◀▶ to choose between the following:

- **List**—Displays every recorded episode for a show (see example in Screen B, at right).

Note: In List view, highlight an episode to display an Info Box with show information. Press MENU to display the Episode Options panel menu (see “Episode Options panel menu” on page 57).

- **Group**—Displays recorded shows without listing every recorded episode (see example in Screen A, at right).

Note: In Group view, highlight a show and press ENTER to view all recorded episodes. Press ENTER again to collapse the episode list.



Sort By: Press ◀ and ▶ to choose between the following:

- **Title**—Displays recorded shows in alphabetical order (see example in Screen A, at right).
- **Date**—Displays recorded shows by date and time, with most recent first (see example in Screen B, at right).

3. When finished, press ENTER to highlight DONE, and then press ENTER again to close the panel menu and display the recordings with the selected options.

To view a recording, you can do one of the following:

- Highlight an episode and press ENTER to view it now. The episode either starts from the beginning or from where it was last stopped (if viewed previously).
- Highlight an episode and press MENU to display the Episode Options panel menu, with the following options:
 - GO TO SERVICE BAR: Closes the menu, changes no information, and returns to the Service Bar.
 - RESUME: Starts from the beginning or from where it was last stopped (if viewed previously).
 - PLAY FROM BEGINNING: Starts from the beginning, even if stopped previously.
 - DELETE EPISODE: Deletes the episode from the RECORDINGS list and deletes the recording from the IEEE1394 recording device. A Confirm panel menu displays. Press YES to delete the episode or NO to close the panel menu.
 - CANCEL: Closes the panel menu, changes no information, and returns to the highlighted show.



Screen A



Screen B



The unauthorized recording, use, distribution, or revision of television programs, videotapes, DVDs, and other materials is prohibited under the Copyright Laws of the United States and other countries, and may subject you to civil and criminal liability.

TV Guide On Screen™ Services (continued)

SCHEDULE screen

The SCHEDULE service screen allows you to review, edit, or delete Record and Remind events you set previously.



- With SCHEDULE highlighted in the Service Bar, press INFO to display a help screen. Press INFO again to close the screen.



- Highlight an event and press MENU to display the Schedule Options panel menu, with the following options:
 - GO TO SERVICE BAR: Closes the menu, changes no information, and returns to the Service Bar.
 - WATCH NOW: Exits the TV Guide On Screen™ system and tunes to the highlighted show.
 - DELETE RECORDING: Removes the recording from the schedule. A Confirm panel menu displays. Press YES to delete the recording or NO to close the panel menu.
 - EDIT RECORDING: Opens a menu in which you can change existing recording information.
 - SET REMINDER: Opens a menu in which you can set a reminder for the show (Record is not cancelled).
 - CANCEL: Closes the panel menu, changes no information, and returns to the highlighted show.

An icon identifies the event type. For more details, see “Record features,” at right, and “Remind features” on page 63.



Record features

You can set a show to Record, or edit the record settings for a show, in LISTINGS, SEARCH, and SCHEDULE. There are three ways to set a show to Record, as described below.

1) Set a show to Record using the REC key on the remote control

Press the REC key on the remote control to record the show Once with current default settings (start and end recording on time). Each time you press REC, you change the Record frequency (but not the default settings) among Once (default), Regularly, Weekly, and Cancel.

Note: The related Record icon appears on the show tile each time you press REC. See “Record icons,” on page 62.

2) Set a show to Record from a panel menu

1. Highlight a show and press MENU to display the Episode Options panel menu.
2. Highlight SET RECORDING and press ENTER to display the Record Options panel menu.



3. Highlight the FREQUENCY field, and press ◀ or ▶ to choose among Once, Regularly, Weekly, or Off.
4. Highlight the START field, and press ◀ or ▶ to choose in the range from 120 minutes early to 120 minutes late or On Time (default = On Time).
5. Repeat step 4 for the END field.
6. Highlight the RECORDER field and press ◀ or ▶ to choose the recording device.

Note: For connected IEEE1394 recording devices only.
7. Highlight the KEEP UNTIL field and press ◀ or ▶ to choose how long you want to keep the Record event.

Note: For connected IEEE1394 recording devices only.
8. Press ENTER to highlight SCHEDULE RECORDING, and press ENTER again to close the menu.

A Record icon for the selected frequency appears on the show tile. See “Record icons” on page 62.

Note: For connected IEEE1394 recording devices only.

Or highlight CANCEL and press ENTER to close the menu, change no information, and return to the highlighted show.

Note: You can change the default values of the Record Options panel menu fields. See “Change default options” on page 66.

TV Guide On Screen™ Services (continued)

Record features (continued)

3) Manually set a show to Record

1. Highlight SCHEDULE in the Service Bar, and press MENU to display the Schedule Options panel menu.
2. Highlight NEW MANUAL RECORDING and press ENTER to display the Record Options panel menu. Press ▲▼◀▶ to move through the options. Press the Number keys or ▲▼◀▶ to change the information, as necessary.
3. Enter the information in the panel menu fields. You will need to set the start and end time for the recording. For details, see “Set a show to Record from a panel menu” on the previous page.

Note: When setting a Manual Recording, the frequency option “Daily” is available instead of “Regularly.” See “Record icons,” below right, for a description of Record icons.

4. When finished entering the information in the fields, press ENTER to highlight SCHEDULE RECORDING, and press ENTER again to close the menu.

A Record icon for the selected frequency appears on the show tile. See “Record Icons,” below right.

Note: Manual recording is listed by channel number.

Or highlight CANCEL and press ENTER to close the menu, change no information, and return to the highlighted show.

When using the TV Guide On Screen™ system to record a program for the first time, it is recommended that you perform a test recording to make sure your system is set up properly.

Recording notification banner

- If the TV is not on, the recording occurs as scheduled.
- If the TV is on and you are watching the channel that is set to record, the recording occurs as scheduled.
- If the TV is on and you are watching a channel other than the one that is set to record, a notification banner (illustrated below) appears on-screen before recording starts. At that time you can choose to start or cancel recording.

The default highlighted item in the notification banner is “Change channel; start recording.” If no change is made within 3 minutes, the notification banner will close automatically, the channel will change to the one set to record, and the recording will occur as scheduled. If you want to cancel the recording, select “Don’t change; cancel recording” in the notification banner and press ENTER.



Record conflict

A conflict message appears for the following reasons:

- A show set to Record overlaps with any part of another show previously set to Record.
- A show set to Record overlaps with a show previously set to auto-tune. (For auto-tune details, see “Remind features” on page 63.)

Select one of these options:

- Record Anyway—This show will override an existing show set to Record or auto-tune.
- Don’t Record This Show—Cancels the Recording.



Record icons

Following is a description of the Record icons that will appear on the tile for a show set to Record.

- Record Once —Records the show one time.
- Record Regularly —Records the show every time the show airs on the same channel and starts at the same time.
- Record Weekly —Records the show every time the show airs on the same day of the week and on the same channel, and starts at the same time.
- Record Daily —Records on the same channel and at the same start time every weekday (Monday through Friday).

Note: This icon displays for manual recordings only.

- Record Suspend —Recording is Suspended due to a schedule conflict (show remains in Schedule).
- Record Off —Keeps the Recording in the Schedule list but will not record this show until the frequency is changed.

The unauthorized recording, use, distribution, or revision of television programs, videotapes, DVDs, and other materials is prohibited under the Copyright Laws of the United States and other countries, and may subject you to civil and criminal liability.

TV Guide On Screen™ Services (continued)

Remind features

You can set a Reminder to perform the following functions:

- Automatically turn on the TV (if off) at the scheduled reminder time, and tune the TV to the channel of the show for which you set the reminder.
- Automatically tune the TV, at the scheduled reminder time, to the channel of the show for which you set the reminder.
- Display an on-screen notification banner (reminding you that the show is about to start), from which you can choose to tune the TV to the show's channel or cancel the reminder.

You can set a show reminder, or edit the reminder settings for a show, in LISTINGS, SEARCH, and SCHEDULE. There are two ways to set a show reminder, as described below.

1) Set a show Reminder from a panel menu

1. Highlight a show and press MENU to display the Episode Options panel menu.
2. Highlight SET REMINDER and press ENTER to display the Remind Options panel menu.



3. Highlight the FREQUENCY field, and press ◀ or ▶ to choose among Once, Regularly, Weekly, or Off.
4. Highlight the POWER ON TV field, and press ◀ or ▶ to choose either Yes (to turn on the TV automatically, if off, at the scheduled Reminder time) or No (default).
5. Highlight the AUTO TUNE TV field, and press ◀ or ▶ to choose either Yes (to automatically tune the TV to the channel you are setting the Reminder for at the scheduled Reminder time; the TV must be on at the time) or No (default).

Note: You can change the default values of the Remind Options panel menu fields. See “Change default options” on page 66 for details.

6. Highlight the WHEN field (to set a time for displaying the reminder screen), and press ◀ or ▶ to choose in the range from 15 minutes early to 15 minutes late or On Time (default = 1 minute early).
7. Press ENTER to highlight SCHEDULE REMINDER, and press ENTER again to close the menu. A Remind icon for the selected frequency appears on the show tile. See “Remind icons” on page 64.

Or highlight CANCEL and press ENTER to close the menu, change no information, and return to the highlighted show.

2) Manually set a show Reminder

1. Highlight SCHEDULE in the Service Bar, and press MENU to display the Schedule Options panel menu.
2. Highlight NEW MANUAL REMINDER and press ENTER to display the Remind Options panel menu. Press ▲▼◀▶ to move through the options. Press the Number keys or ▲▼◀▶ to change the information, as necessary.



3. Enter the information in the panel menu fields. You will need to set the start and end time for the reminder. For details, see “Set a show reminder from a panel menu,” at left.

Note: When setting a Manual Reminder, the frequency option “Daily” is available instead of “Regularly.” See “Remind icons,” on the following page, for a description of Reminder icons.

4. When finished entering the information in the fields, press ENTER to highlight SCHEDULE REMINDER, and press ENTER again to close the menu.

A Remind icon for the selected frequency appears on the show tile. See “Remind icons” on the following page.

Note: Manual reminders are listed by channel number.

Or highlight CANCEL and press ENTER to close the menu, change no information, and return to the highlighted show.

TV Guide On Screen™ Services (continued)

Remind features (continued)

Reminder notification banner

Based on your option settings, a notification banner will appear on-screen, if your TV is on at the scheduled Reminder time.

At that time you can either press ENTER to hide the Reminder banner, or highlight the show and press ENTER to tune to the show.

If no choice is made within 3 minutes, the notification banner closes automatically and completes the highlighted item (default is HIDE REMINDERS).

Note: If more than two reminders are set for the same time, arrows appear on the Reminder notification banner. Press ▲▼ to highlight the shows.



Remind conflict

A conflict message appears for the following reasons:

- A show set with an auto-tune Reminder has the same start time as an existing auto-tune Reminder.
- A show set with an auto-tune Reminder overlaps with a scheduled Recording.

Select one of these options:

- Auto-Tune Anyway—This show will override an existing show set to auto-tune.
- Proceed, No Auto-Tune—Set the show as a Reminder but do not auto-tune.
- Don't Set This Reminder—Cancels the Reminder.

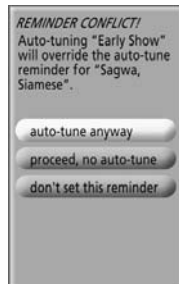

Remind icons

Following is a description of the Remind icons that will appear on the tile for a show set to Remind.

- Remind Once —Displays a show reminder one time.
- Remind Regularly —Displays a show reminder every time the show airs on the same channel and starts at the same time.
- Remind Daily —Displays a show Reminder every weekday (Monday through Friday) for the same channel and start time.

Note: This icon displays for manual reminders only.

- Remind Suspend —Reminder is Suspended due to a schedule conflict (show remains in Schedule).
- Remind Off —Keeps the Reminder in the Schedule list but will not display a reminder until you change the frequency.

TV Guide On Screen™ Services (continued)

SETUP screen

After you complete the initial TV Guide On Screen™ setup (as described in Chapter 5), you can change the following settings:

- Change system settings
- Change channel display
- Change default options

Highlight a choice, press ENTER, and follow the on-screen instructions.



With SETUP highlighted in the Service Bar, press INFO to display a help screen. Press INFO again to close the screen.

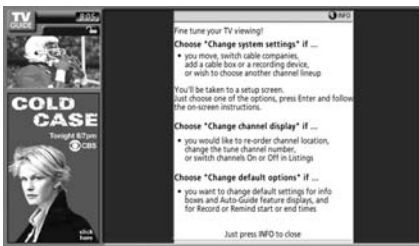

Change system settings

This option appears only after you have completed the initial TV Guide On Screen™ setup process (as described in Chapter 5).

1. From the SETUP screen, highlight CHANGE SYSTEM SETTINGS and press ENTER.



2. Press ENTER again to display the Confirming Your Settings screen.
3. Highlight one of the options, press ENTER, and follow the on-screen instructions.

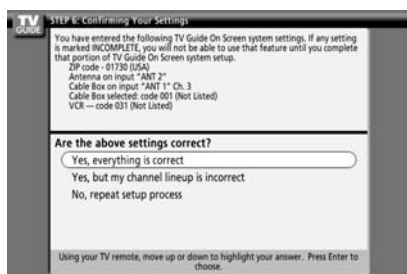

Change channel display

This option allows you to edit channel information that appears in LISTINGS, including the following:

- Reorder the position the channels appear in LISTINGS.
- Change the “tune channel” number.

Note: The “tune channel” is the channel on which you receive a station. For example, two viewers in the same zip code may receive the same station on different channel numbers, depending on whether they have Cable service or are using a cable box.

- Switch a channel to one of the following settings:
 - **On** (channel is always displayed in LISTINGS)
 - **Off** (channel is never displayed in LISTINGS)
 - **Auto-Hide** (channel is displayed in LISTINGS only when program information is available)

1. From the SETUP screen, highlight CHANGE CHANNEL DISPLAY and press ENTER.



2. Highlight the channel row you want to edit and press ENTER to display the Grid Options panel menu.



3. To edit the options, press INFO and follow the on-screen instructions.

TV Guide On Screen™ Services (continued)

SETUP screen (continued)

Change default options

This option allows you to change default settings in the following categories:

- General Defaults
- Record Defaults
- Remind Defaults

General defaults

1. From the SETUP screen, highlight CHANGE DEFAULT OPTIONS and press ENTER.



2. Highlight GENERAL DEFAULTS and press MENU to display the General defaults panel menu.



3. Enter the following information in the panel menu fields:
 - **BOX SIZE:** The initial Info Box size when you open the TV Guide On Screen™ system. Choices are No, Small (default), Large, and Last Used.
 - **BOX CYCLE:** The Info Box size rotation when you press INFO on the remote control when the TV Guide On Screen™ system is open. Choices are No Only, Small Only, Large Only, No & Small, No & Large, Small & Large, and All (default).
 - **AUTO GUIDE:** Automatic entry into the TV Guide On Screen™ system when the TV is powered on. Choices are On (default) and Off.

Note: Set the AUTO GUIDE to Off if you do not want the TV Guide On Screen™ system to open every time you turn on the TV.

4. When finished, press ENTER to highlight DONE, and press ENTER again to close the menu and accept the changes (or highlight CANCEL to close the menu with no changes).

Record defaults

1. From the SETUP screen, highlight CHANGE DEFAULT OPTIONS and press ENTER.
2. Highlight RECORD DEFAULTS and press MENU to display the Record Defaults panel menu.



3. Enter the required information in the panel menu fields (start time, end time, recorder choice, how long to keep a Record event, the quality of the recording). See “Record features” on page 61 for details on entering values in these fields.
4. When finished, press ENTER to highlight DONE, and press ENTER again to close the menu and accept the changes (or highlight CANCEL to close the menu with no changes).

Remind defaults

1. From the SETUP screen, highlight CHANGE DEFAULT OPTIONS and press ENTER.
2. Highlight REMIND DEFAULTS and press MENU to display the Remind Defaults panel menu.



3. Enter the required information in the panel menu fields (power On TV, auto-tune, when to display the Remind screen). See “Remind features” on page 63 for details on entering values in these fields.
4. When finished, press ENTER to highlight DONE, and press ENTER again to close the menu and accept the changes (or highlight CANCEL to close the menu with no changes).

8 Using the TV's features

Selecting the video input source to view

To select the video input source to view:

1. Press INPUT on the remote control or TV/VIDEO on the TV control panel.
2. Press 0–9 to select the input source you want to view, which will depend on the input terminals you used to connect your devices (see Chapter 2).

The current signal source displays in the top right corner of the Input Selection screen.

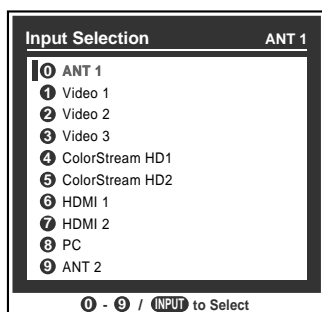

Note:

- When the Input Selection screen is open, you also can use the ▲▼ buttons on the remote control (or the Channel ▲▼ buttons on the control panel) to change the input.
- You can repeatedly press the INPUT button on the remote control or the TV/VIDEO button on the TV control panel to change the input.
- To select an IEEE1394 input source, press the TheaterNet DEVICE button on the remote control (see page 26 and 45).
- If an IEEE1394 device is the current input, it will appear at the bottom of the Input Selection list; however, it will not display in the list if you change the input source.
- You can label the video input sources according to the specific devices you have connected to the TV (see “Labeling the video input sources” on the next page).
- The source can be “hidden.” See page 68 for details.

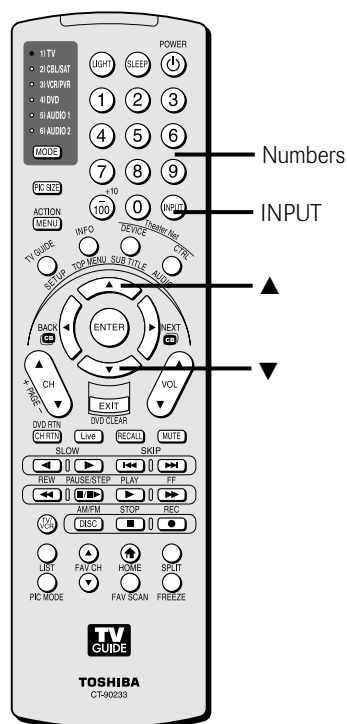

Remote control

TV control panel

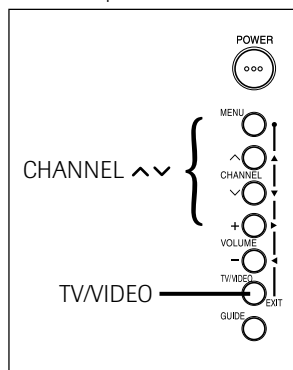

Labeling the video input sources

You can label each video input source according to the type of device you connected to each source, from the following preset list of labels:

-- (default label)

Hide (to hide an unused input in the Input Selection window)

Audio Receiver

VCR

Video Recorder

Laser Disk

Compact Disc

DVD

DTV

Satellite/DSS

Cable

Game Console

Note:

- If you set up devices in TheaterNet™ the associated inputs are automatically labeled and cannot be relabeled until you remove the device from TheaterNet (see page 45).
- If you set up a cable box in VIDEO 1, that input will be labeled automatically and cannot be relabeled until you remove the device from the TV Guide On Screen™ setup.
- You cannot select IEEE1394 devices through the Input Selection window; however, you can select and control IEEE1394 devices through TheaterNet (see page 45).

To label the video input sources:

- Press MENU and open the Preferences menu.
- Highlight Input Labeling and press ENTER.
- Press ▲ or ▼ to highlight the video source you want to label.

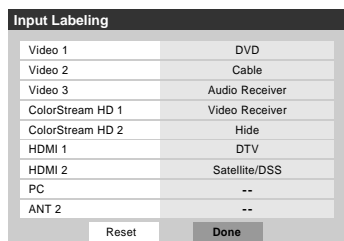
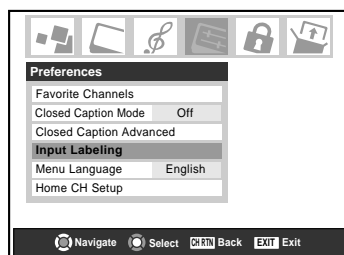

- Press ◀ or ▶ to select the desired label for that input source. If a particular input is not used, you can select “Hide” as the label, which will cause that input to be “grayed out” in the input list and skipped over when you press the INPUT button on the remote control.

Note: If you select “Hide” for all of the input labels, the POP feature will be disabled. If you then attempt to access the POP feature, the message “Not available” will appear on-screen.

- To save the new input labels, highlight Done and press ENTER. To revert to the factory default labels, highlight Reset and press ENTER.

Input labeling example:

The screen below left shows the default Input Selection screen (with none of the inputs labeled). The screen below right is an example of how you could label the inputs if you had connected a DVD player to VIDEO 1, Cable TV to VIDEO 2, an audio receiver to VIDEO 3, a video recorder to ColorStream HD1, a DTV set-top box to HDMI 1, and a satellite/DSS set-top box to HDMI 2. Also note that the ColorStream HD2 input is labeled “Hidden,” which means that the input will be skipped over when INPUT or TV/VIDEO is pressed.

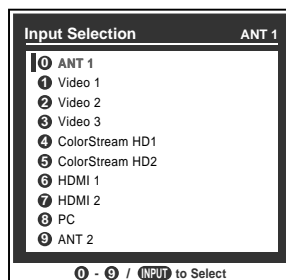

Input Selection screen with no inputs labeled

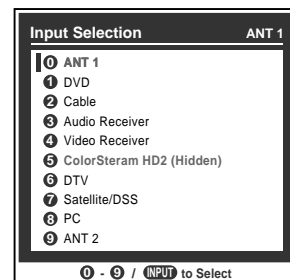

Input Selection screen with all inputs labeled except input 5, which has been hidden.

To clear the input labels:

- Press MENU and open the Preferences menu.
- Highlight Input Labeling and press ENTER.
- Highlight Reset and press ENTER.

Note: If you set up a device in TheaterNet, its input label will not be cleared unless you remove the device from TheaterNet (see page 45).

Tuning channels

Using the ChannelBrowser™

The channel browser stores the most recently viewed channels (up to 32) in the channel history. This feature allows you to:

- Keep a separate, temporary* history of the last 32 channels tuned from each of three inputs: ANT 1, ANT 2, and Cable Box.
 - ***Note:** Turning off the TV will clear the channel history for all three inputs.
- Quickly surf and tune your recently viewed channels from the channel browser banner (illustrated below).
- Surf via Browse mode (to immediately tune channels as you highlight them in the channel browser banner) or Select mode (to surf over channels in the browser banner before you select one to tune).
- Set a "HOME" channel for the ANT 1, ANT 2, and Cable Box inputs.

To open the channel browser banner: Press ◀ (BACK CB), ▶ (NEXT CB), or ENTER on the remote control.

- Press ◀ (BACK CB) to surf back from the most recently viewed channel through the last 32 channels that were tuned from the current input, which are automatically stored in the channel history for the current input (ANT 1, ANT 2, or Cable Box only).
- Press ▶ (NEXT CB) to surf forward from the previous channels in the channel history up to the most recently viewed channel.

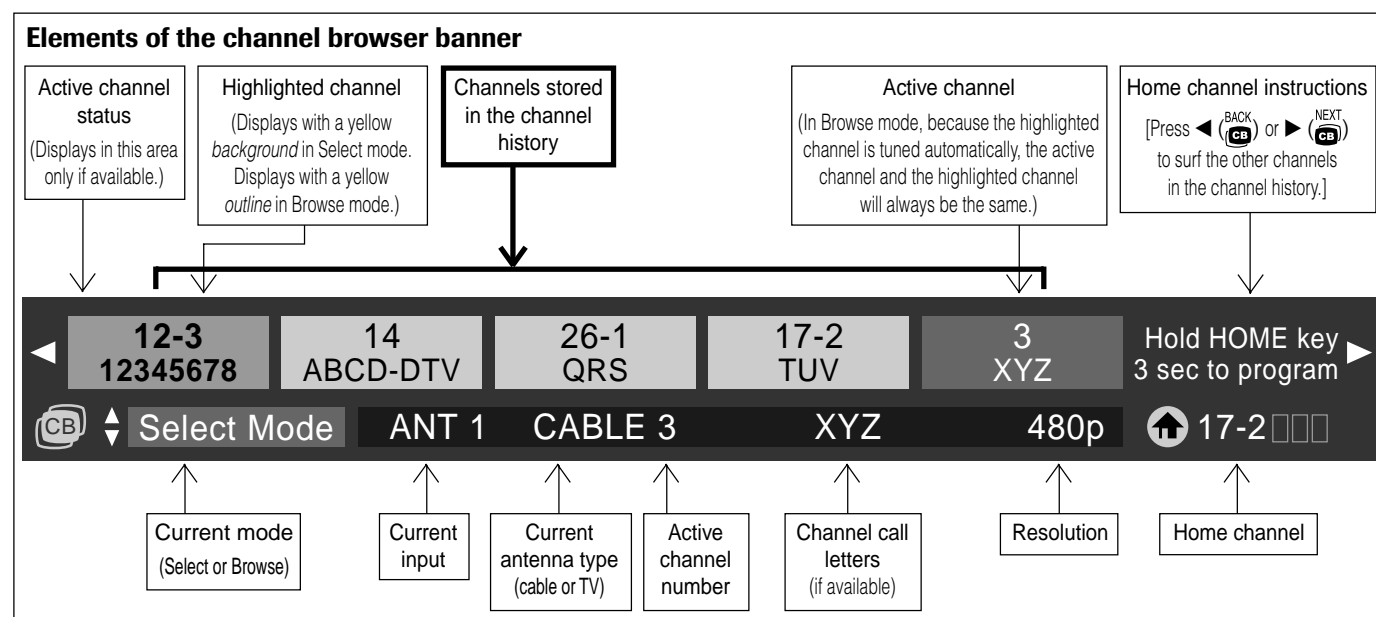

To toggle between Browse mode and Select mode:

After opening the channel browser banner, press ▲ or ▼ to toggle between Browse mode and Select mode. The "Current mode" field on the channel browser banner will flash green. **Note:** The channel browser banner opens in Browse mode by default.

To tune to a channel in Browse mode:

1. While watching TV, press ◀ (BACK CB) or ▶ (NEXT CB) to open the channel browser banner and surf back to a previous channel or forward to the next channel in the channel history. In Browse mode, when you stop on a channel number in the browser banner, it will be highlighted with a *yellow outline* and the TV will automatically tune to the channel.
2. Press EXIT to close the channel browser banner.



In Browse mode, the highlighted channel number is outlined in yellow and the channel will be tuned to automatically.

Note: The channel browser close automatically if you do not make a selection within 60 seconds.

To tune to a channel in Select mode:

1. While watching TV, press ◀ (BACK CB) or ▶ (NEXT CB) to open the channel browser banner and surf back to a previous channel or forward to the next channel in the channel history. In Select mode, when you stop on a channel number in the browser banner, it will be highlighted with a *yellow background* but the TV will not automatically tune to the channel.
2. Press ENTER to tune the TV to the highlighted channel.
3. Press EXIT to close the channel browser banner.



In Select mode, the highlighted channel number has a yellow background. Press ENTER to tune to the channel.

Tuning channels (continued)

Using the Channel Browser™ (continued)

Adding and clearing channels in the channel history

Adding channels to the channel history

The channel browser automatically creates a history of the last 32 channels that were tuned in the current input (ANT 1, ANT 2, and Cable Box inputs only). A separate history will be stored for each of these inputs.

If you change the input you are viewing:

- you will begin a channel history for that input if one did not exist; or
- you will return to the existing channel history for that input if one had already been started.

The channel browser will store the following channels:

- All channels that are tuned using the numeric buttons on the remote control.
- All channels that are tuned for at least 7 seconds using the CH ▲▼ buttons or the FAV CH ▲▼ buttons on the remote control.

Note:

- The channel browser banner will not appear when the POP double window is open; however, channels tuned while the POP double window is open will be added to the channel browser history for the current input.
- The channel browser banner will not appear in the FAV SCAN (favorite scan) multi-window. Channels that appear in the FAV SCAN multi-window will not be added to the channel browser history; however, channels that are tuned from the FAV SCAN multi-window for at least 7 seconds will be added to the channel history.

Clearing channels from the channel history

- Turning off the TV will clear all three channel histories (ANT 1, ANT 2, and Cable Box).
- Removing the CableCARD™ will clear the channel history for the ANT 1 input.
- Reconfiguring the ANT 1, ANT 2, or Cable Box input will clear the channel history for the newly configured input(s).

Note: See page 41 for details on configuring the antenna inputs.

Setting a channel as the “Home” channel for an input

To set a channel as Home using the remote control:

- Tune the TV to the channel you would like to set as the Home channel for the current antenna input.
- Press and hold the HOME (🏠) button on the remote control for 3 seconds. When the Home channel is saved, the channel browser banner will appear at the bottom of the screen with the home icon flashing green.

Note: You can set a different Home channel for each input (ANT 1, ANT 2, and Cable Box inputs only).

To set a channel as Home using the menus:

- Press MENU and open the Preferences menu.
- Highlight Home CH Setup and press ENTER. The Home CH Setup window will display.

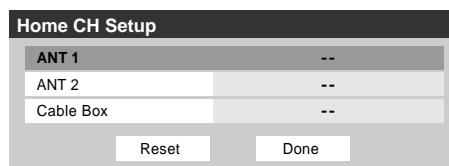

Note: "Cable Box" will appear in the Home CH Setup window only if you connected a cable box to your TV.

- Use the ▲▼ buttons to select the input for which you want to set the Home channel.
- Use the numeric and dash (–) buttons on the remote control to enter the desired Home channel for each input.
- To save your entries, highlight Done and press ENTER. To clear your entries, highlight Reset and press ENTER.

To tune to the Home channel:

While an input that has a set Home channel is active, press the HOME (🏠) button on the remote control.

Note: If you press the HOME button while an input other than an antenna or Cable Box input is selected, the TV will tune to the most recently tuned Home channel and input.

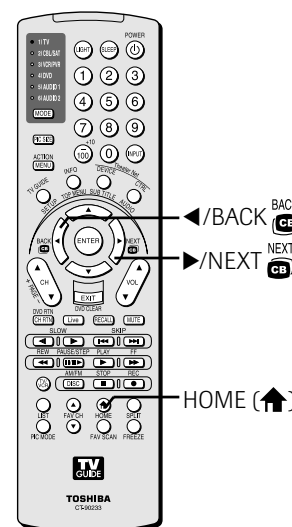

Tuning channels (continued)

Tuning your favorite channels

To tune to the channels you programmed as Favorite Channels, see page 44.

Tuning to the next programmed channel

To tune to the next programmed channel:

Press CHANNEL ▲ or ▼ on the remote control or TV control panel.

Note:

- This feature will not work unless you program channels into the TV's channel memory (see page 42).
- If you are recording a digital channel, you will only be able to change analog channels while the recording is in progress. If you are recording an analog channel, you will only be able to change digital channels while the recording is in progress. This is because the TV tuner that is being recorded (digital or analog) will be locked on the channel that is currently recording.

Tuning to a specific channel (programmed or unprogrammed)

Tuning analog channels:

Press the Channel Number buttons (0–9) on the remote control. For example, to select channel 125, press 1, 2, 5.

Tuning digital channels:

Press the Channel Number buttons (0–9) on the remote control, followed by the – (dash) button and then the sub-channel number. For example, to select digital channel 125-1, press 1, 2, 5, –, 1.

Note: If a digital channel is not programmed—either through the automatic channel scan (page 42) or the channel add/delete function (page 43)—you will have to tune the RF channel using the Channel Number and Dash buttons on the remote control.

Switching between two channels using Channel Return

The Channel Return feature allows you to switch between two channels without entering an actual channel number each time.

1. Select the first channel you want to view.
2. Select a second channel using the Channel Number buttons (and the dash (–) button if selecting a digital channel).
3. Press CH RTN on the remote control. The previous channel will display. Each time you press CH RTN, the TV will switch back and forth between the last two channels that were selected.

Note: If you press CH RTN from a non-antenna input, the TV will return to the last-viewed ANT input and channel. If you are currently recording a program, this feature will not be available.

Switching between two channels using SurfLock™

The SurfLock™ feature temporarily “memorizes” one channel in the CH RTN button, so you can return to that channel quickly from any other channel by pressing CH RTN. To memorize a channel in the CH RTN button:

1. Select the channel you want to program into the CH RTN button.
2. Press and hold CH RTN for about 2 seconds until the message “Channel Memorized” appears on the screen. The channel has been programmed into the CH RTN button.
3. You can then change channels repeatedly, and when you press CH RTN, the memorized channel will be selected.

The TV will return to the memorized channel one time only. Once you press CH RTN and then change channels again, the CH RTN memory will be cleared and the button will function as Channel Return, by switching back and forth between the last two channels that were selected.

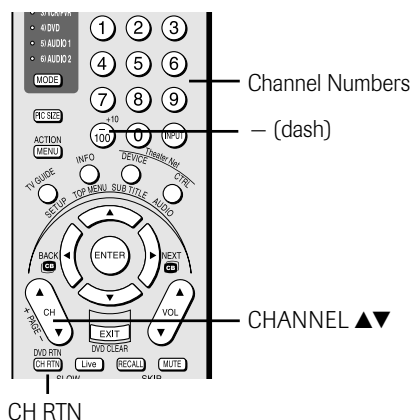

Selecting the picture size

You can view many program formats in a variety of picture sizes—Natural, TheaterWide 1, TheaterWide 2, TheaterWide 3, and Full—as described below and on the next page.

The way the image displays in any of the picture sizes will vary depending on the format of the program you are viewing. Select the picture size that displays the current program the way that looks best to you.

Your picture size preferences can be saved for each input on your TV.

To select the picture size:

1. Press PIC SIZE on the remote control.
2. While the Picture Size menu is on-screen, press the corresponding number button (0–4) to select the desired picture size.

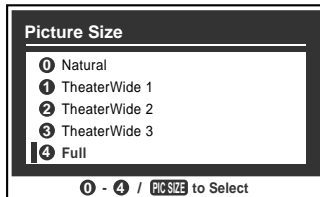

Note:

- You also can repeatedly press PIC SIZE to select the desired picture size (or press the ▲▼ buttons on the remote control while the Picture Size screen is open).
- “Full” may not be available for some program formats (it will be “grayed out” in the Picture Size screen).

Natural picture size

- The image is displayed close to its originally formatted proportion. Some program formats will display with sidebars and/or bars at the top and bottom.

Natural picture size example: The way the image displays will vary depending on the format of the program you are currently watching.

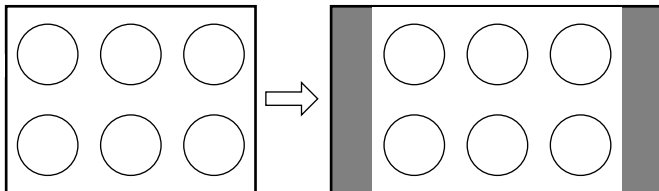

Conventional picture on a conventional TV screen

Conventional picture in Natural size on your wide-screen TV

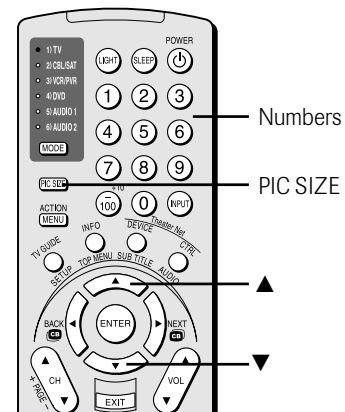

Note:

You also can select the picture size using the menu system. Select Picture Size in the Video/Theater Settings menu. Select the input you wish to save your picture size settings for. To save your settings, highlight Done and press ENTER.

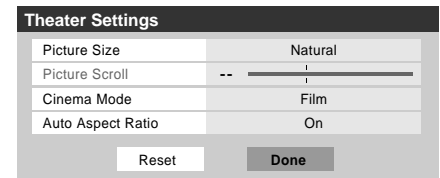

Selecting the picture size (continued)

TheaterWide 1 picture size (For 4:3 format program)

- The center of the picture remains close to its original proportion, but the left and right edges are stretched wider to fill the screen.

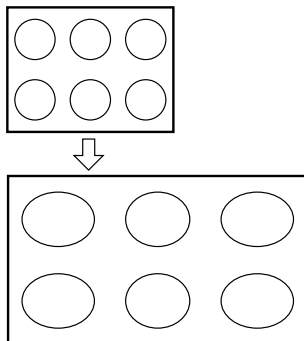

TheaterWide 1 picture size example

TheaterWide 2 picture size (for letter box programs)

- The picture is stretched wider to fill the width of the screen, but only slightly stretched taller.
- The top and bottom edges of the picture are hidden. To view the hidden areas, see "Scrolling the TheaterWide® picture" on page 74.

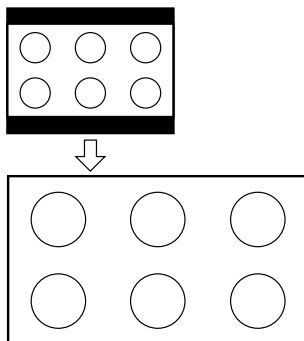

TheaterWide 2 picture size example

TheaterWide 3 picture size (for letter box programs with subtitles)

- The picture is stretched wider to fill the width of the screen, but only slightly stretched taller.
- The top and bottom edges are hidden. To view the hidden areas (such as subtitles or captions), see "Scrolling the TheaterWide® picture" on page 74.

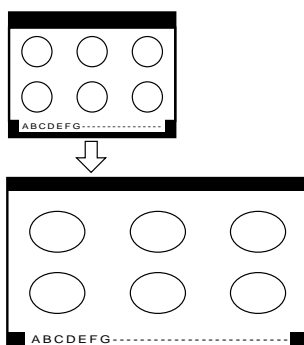

TheaterWide 3 picture size example

Full picture size (for 16:9 [480i, 480p] source programs only)

- If receiving a squeezed 4:3 format program, the picture is stretched wider to fill the width of the screen, but not stretched taller.
- None of the picture is hidden.

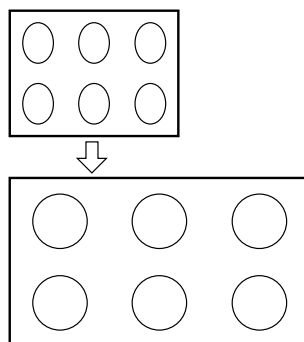

Full picture size example

Note:

- If you select one of the TheaterWide® picture sizes, the top and bottom edges of the picture (including subtitles or captions) may be hidden. To view the hidden edges, either scroll the picture (TheaterWide 2 and 3 only) or try viewing the program in Full or Natural picture size.
- When selecting the picture size, the way the image displays will vary depending on the format of the program you are currently watching.

Using these functions to change the picture size (i.e., changing the height/width ratio) for any purpose other than your private viewing may be prohibited under the Copyright Laws of the United States and other countries, and may subject you to civil and criminal liability.

Scrolling the TheaterWide® picture (TheaterWide 2 and 3 only)

You can set separate scroll settings for TheaterWide 2 and TheaterWide 3 modes for each input.

To set the scroll settings:

1. Press INPUT on the remote control or TV/VIDEO on the TV to select the input for which you want to set the picture size and scroll settings.
2. Press MENU and open the Video menu.
3. Highlight Theater Settings and press ENTER.

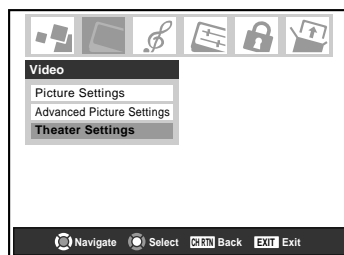

4. In the Picture Size field, select either TheaterWide 2 or TheaterWide 3 (you cannot scroll in any other mode).
5. Press ▼ to highlight the Picture Scroll field.
6. Press ◀ or ▶ to scroll the picture up and down as needed, from -10 to +20.

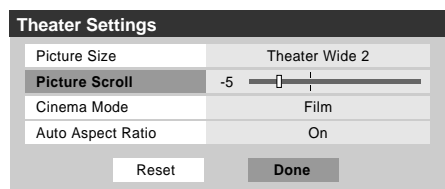

7. To save the new settings, highlight Done and press ENTER. To revert to the factory defaults, highlight Reset and press ENTER.

Using the auto aspect ratio feature

When the auto aspect ratio feature is set to On, the picture size is automatically selected when one of the following input sources is received:

- A 480i signal from the VIDEO 1, VIDEO 2, VIDEO 3, ColorStream HD-1, or ColorStream HD-2 input.
- A 1080i, 480i, 480p, or 720p signal from the HDMI input.

Aspect ratio of signal source	Automatic aspect size (automatically selected when Auto Aspect is On)
4:3 normal	Natural (with sidebars)
4:3 letter box	TheaterWide 2
16:9 full	Full
Not defined (no ID-1 data or) HDMI aspect data)	User-selected picture size (see pages 72-73)

Note:

- The auto aspect ratio feature is not applicable to antenna or Cable input sources.
- The auto aspect ratio feature is not available when the POP double-window is open, the Freeze mode is active, or the TV Guide On Screen™ system is open.

To turn on the auto aspect ratio feature:

1. Press MENU and open the Video menu.
2. Highlight Theater Settings and press ENTER.

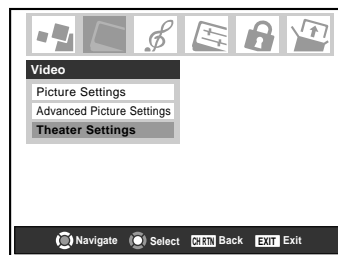

3. In the Auto Aspect Ratio field, select On.

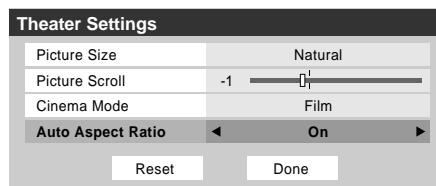

4. To save the new settings, highlight Done and press ENTER. To revert to the factory defaults, highlight Reset and press ENTER.

To turn off the auto aspect ratio feature:

Select Off in step 3 above.

Selecting the cinema mode (480i signals only)

When you view a DVD (480i signal; 3:2 pulldown processed) from a DVD player connected to the VIDEO 1, VIDEO 2, ColorStream HD1/HD2 (component video), or HDMI inputs on the TV, smoother motion can be obtained by setting the Cinema Mode to Film.

To set the Cinema Mode to Film:

1. Press MENU and open the Video menu.
2. Highlight Theater Settings and press ENTER.

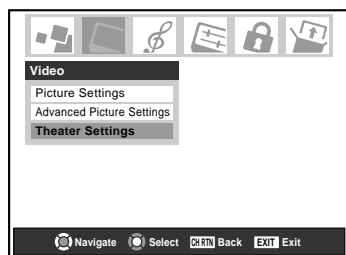

3. In the Cinema Mode field, select Film.

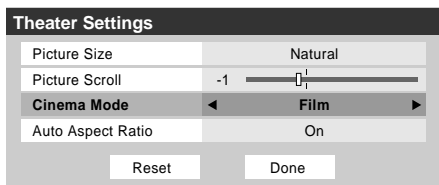

4. To save the new settings, highlight Done and press ENTER. To revert to the factory defaults, highlight Reset and press ENTER.

To set the Cinema Mode to Video:

Select Video in step 3 above.

Selecting the lamp mode

You can select either the High Bright or Low Power lamp mode.

- The High Bright mode is useful when additional picture brightness is desired (such as in a bright room).
- The Low Power mode reduces wear on the projection lamp. Using this mode should result in longer lamp life.

See “Lamp unit replacement” on page 103–105.

To select the lamp mode:

1. Press MENU and open the Video menu.
2. Highlight Advanced Picture Settings and press ENTER.

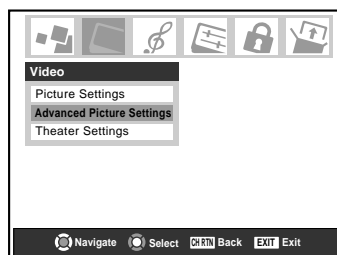

3. In the Lamp Mode field, select High Bright or Low Power, whichever you prefer.

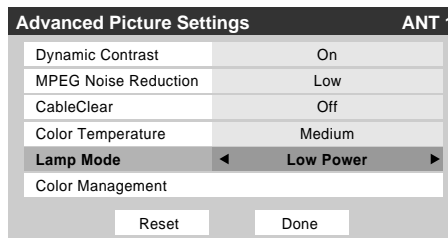

4. To save the new settings, highlight Done and press ENTER. To revert to the factory defaults, highlight Reset and press ENTER.

Note:

If you set the lamp mode to Low Power, each time you turn on the TV, the lamp will start out in High Bright mode but will switch to Low Power mode in approximately 1 minute. You will notice a change in screen brightness when this happens. This is normal and is not a sign of malfunction.

Using the POP features

Using the POP double-window feature

The POP (picture-out-picture) double-window feature splits the screen into two windows so you can watch two programs at the same time.

To display a program in the POP window:

1. Select the program you want to watch in the main window.
2. Press SPLIT to open the POP double-window.

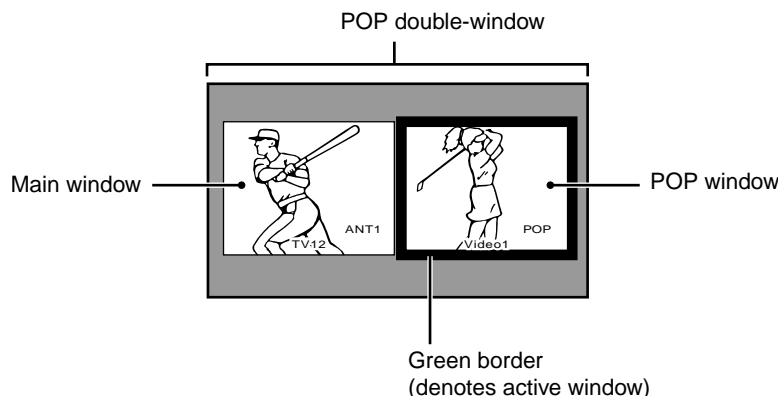

3. Press **▶** to highlight the POP (right) window. When highlighted, the window will have a green border.
4. Press INPUT to open the POP Input Selection window. Select the input source for the POP window by pressing the corresponding Number button (0–9). The current source displays in purple in the POP Input Selection window.

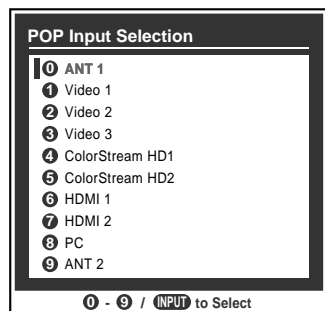

To close the POP window and tune to the highlighted window:

Press ENTER after highlighting the window you want to view as a normal picture.

To close the POP window:

Press SPLIT or EXIT.

Notes about recording:

- If the POP window is open and you attempt to start recording, the POP window will close and recording will start.
- If you use the TV's remote control to start recording, you will not be able to open the POP window and the message "Not Available" will appear on-screen.
- It is recommended that you use the TV's remote control to start recording. If you use a device other than the TV's remote control to start recording, you may be able to open the POP window during the recording process. If this happens, the recorded audio will reflect the audio of the active window (main or POP), which may not be the audio you intended to record.

Note:

- When the main window is in the ANT1 or ANT2 mode, the ANT1 and ANT2 inputs cannot be selected for the POP window.
- When the main window is in Video 1/2/3, ColorStream HD1/HD2, HDMI 1, or HDMI 2 mode, those inputs cannot be selected for the POP window.
- You cannot view IEEE1394 source programs in the POP window.
- You cannot view two video or two antenna sources in both the main and POP windows simultaneously. (You can view a video source in one window and an antenna source in the other.)
- The FREEZE feature is not available when the POP double-window is open. If you press FREEZE when the double-window is open, the message "Not available" will appear.

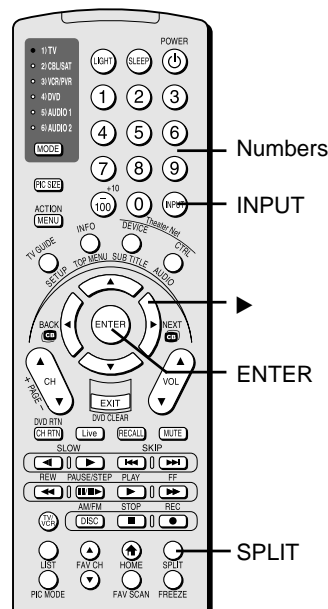

Using the POP features (continued)

Switching the speaker audio (main or POP)

While the POP window is open, press ◀ or ▶ to switch the sound (main or POP) that is output from the TV speakers (and from the VARIABLE AUDIO OUT terminals).

The window with the active sound is outlined with a green border.

Example: Press ◀

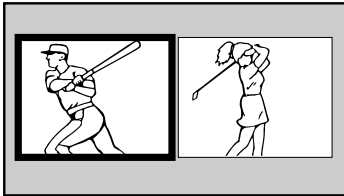

Example: Press ▶

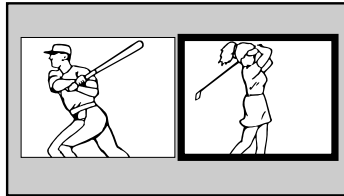

POP double-window aspect ratio

The POP double-window feature displays each picture according to its input signal aspect ratio, as illustrated in the examples below.

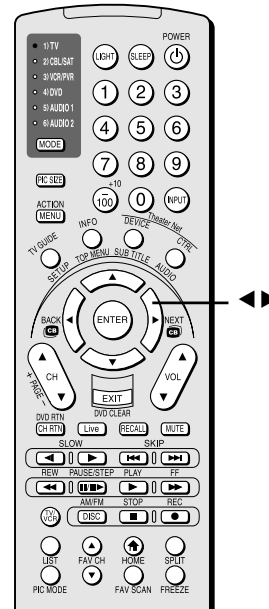
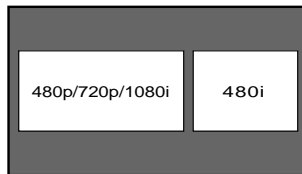

Note:

- The auto aspect ratio feature (page xx) does not operate in POP double-window mode.
- Aspect ratio is the ratio of width to height of the picture.

Using the FREEZE feature

1. When viewing the TV, press FREEZE to make the picture a still picture.
2. To return to the moving picture, either press FREEZE again, press EXIT, or press any other button.

Note:

- The FREEZE feature is not available when the POP double-window or FAV SCAN multi-window is open. If you press FREEZE when either window is open, the message "Not available" will appear.
- If the TV is left in FREEZE mode, after 15 minutes it will automatically release the FREEZE mode and return to the moving picture.

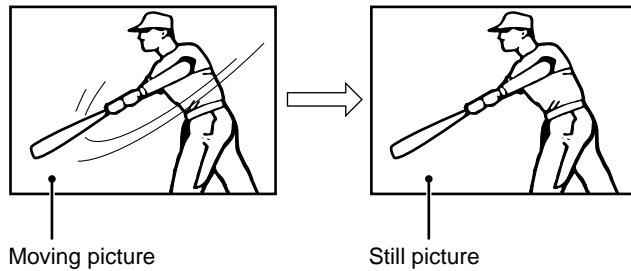

Using the FREEZE function for any purpose other than your private viewing may be prohibited under the Copyright Laws of the United States and other countries, and may subject you to civil and criminal liability.

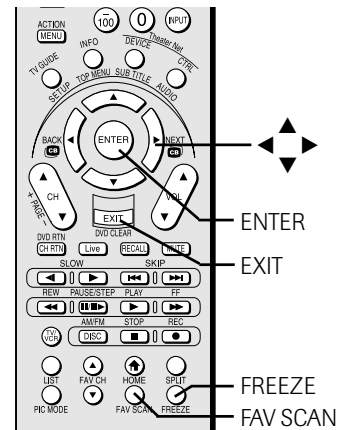

Using the favorite channel scan feature

You can use this feature to quickly scan and tune the channels you programmed as favorite channels from a nine-picture multi-window.

Note: To use the favorite channel scan feature, you must first program channels into the favorite channel memory. See "Programming your favorite channels" on page 44.

To scan and tune your favorite channels:

1. Press FAV SCAN. The TV will display the channels you programmed as favorite channels for the current ANT input in a nine-picture multi-window.
(To display the channels you programmed as favorite channels for the other input, you must change antenna inputs first (page 67), and then press FAV SCAN.)

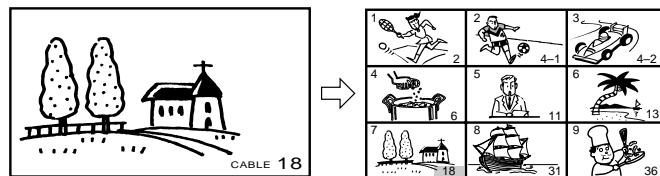

2. Highlight the window for the channel you want to view:
 - Either... press the channel's multi-window position number (1-9, as illustrated above, and not the actual channel number) to highlight the window;
 - or... use the ▲▼◀▶ buttons to highlight the window.
The highlighted window will display as a moving picture.
3. Press ENTER to tune the TV to the highlighted channel and close the multi-window.

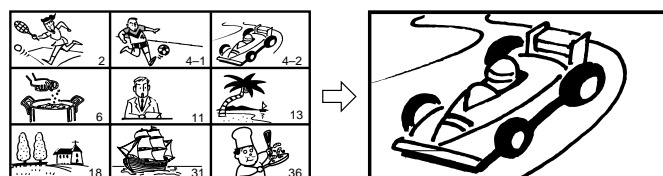

Adjusting the picture

Selecting the picture mode

You can select your desired picture settings from four picture modes, as described below.

Mode	Picture Quality
Sports	Bright and dynamic picture (factory setting)
Standard	Standard picture settings (factory setting)
Movie	Lower contrast for darkened room (factory setting)
Preference	Your personal preferences

To select the picture mode:

Press PIC MODE on the remote control. The following popup menu appears on-screen.



Repeatedly press PIC MODE to cycle among the modes or use ◀ or ▶ to select the modes.

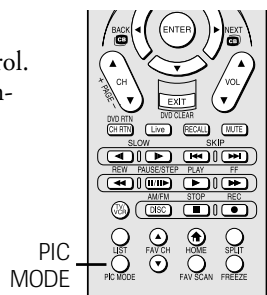

To select the picture mode using the menu system:

1. Press MENU and open the Video menu.
2. Highlight Picture Settings and press ENTER.

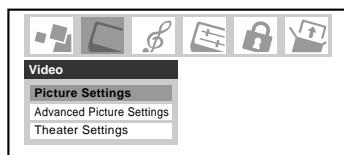

3. In the Mode field, select the mode you prefer.

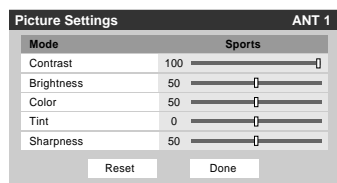

4. To save the new settings, highlight Done and press ENTER. To revert to the factory defaults, highlight Reset and press ENTER.

Note:

- The picture mode you selected is for the current input selection only (ANT 1 in the example above). You can select a different picture mode for each input selection.
- If you select one of the factory-set picture modes (Sports, Standard, or Movie) and then change a picture quality setting (for example, increase the contrast or change the color temperature), the picture mode automatically changes to Preference in the Picture Settings menu.

Adjusting the picture quality

You can adjust the picture quality (contrast, brightness, color, tint, and sharpness) to your personal preferences.

Selection	◀ Pressing ▶	
contrast	lower	higher
brightness	darker	lighter
color	paler	deeper
tint	reddish	greenish
sharpness	softer	sharper

To adjust the picture quality:

1. Press MENU and open the Video menu.
2. Highlight Picture Settings and press ENTER.

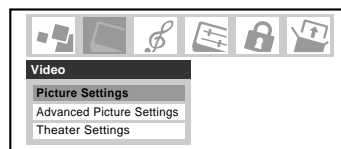

3. Press ▲ or ▼ to select the picture quality you want to adjust (Contrast, Brightness, Color, Tint, or Sharpness), and then ◀ and ▶ to adjust the setting, as described in the table above.

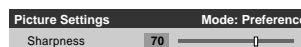
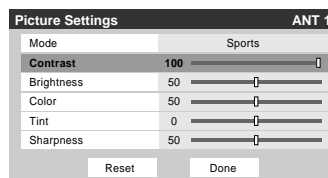

4. To save the new settings, highlight Done and press ENTER. To revert to the factory defaults, highlight Reset and press ENTER.

The picture qualities you adjusted are automatically saved in the Preference mode (see “Selecting the picture mode,” above left).

Adjusting the picture (continued)

Using the Color Management feature

The Color management feature allows you to adjust the hue and saturation of 6 colors: red, green, blue, yellow, magenta, and cyan.

To select Color Management preferences:

1. Press Menu and open the Video menu.
2. Highlight Advanced Picture Settings and press ENTER.

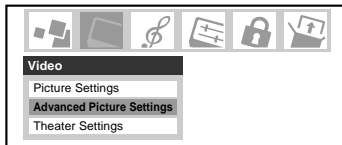

3. In the Color Management field, and press ENTER.

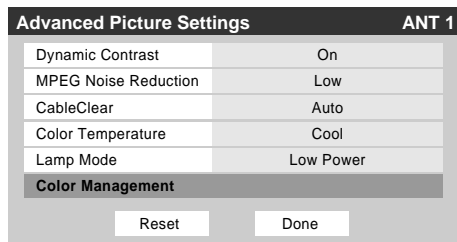

4. Highlight Color Management, and then press ◀ or ▶ to select On.

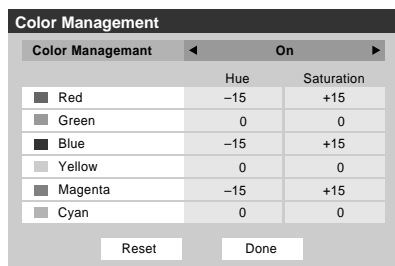

5. Press ▲ or ▼ to highlight the color you want to adjust, then press ENTER.
6. Press ◀ or ▶ to adjust the Hue or Saturation setting.



Note: Pressing ▲ or ▼ will switch between the Hue and Saturation adjusting windows.

7. Press Enter to return to the Color Management Window.
8. To save the new settings, highlight Done and press ENTER. To revert to the factory defaults, highlight Reset and press ENTER.

Note:

- If you select Off in step 4 above, you cannot adjust the Hue or Saturation.
- If you select one of the factory-set picture modes (Sports, Standard, or Movie) and then change the Color Management to "On", the picture mode automatically changes to Preference in the Picture Settings menu.

Adjusting the picture (continued)

Using CableClear® /DNR (digital noise reduction)

The CableClear® digital noise reduction feature allows you to reduce visible interference in your TV picture. This may be useful when receiving a broadcast with a weak signal (especially a Cable channel) or playing a noisy video cassette or disc. This feature is enabled for 480i signals only.

Note: The CableClear DNR feature does not function in ColorStream, HDMI (DVI), ATSC, IEEE1394, and digital Cable modes.

To select CableClear/DNR preferences:

1. Press MENU and open the Video menu.
2. Highlight Advanced Picture Settings and press ENTER.

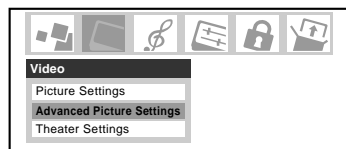

3. In the CableClear/DNR field, select your desired setting.

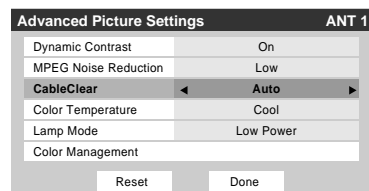

Note:

- If the current input is Antenna, Video 1, Video 2, or Video 3, the menu will display the text *CableClear*. The available selections are *Off*, *Low*, *Middle*, *High*, and *Auto*.
 - If the current input is ColorStream HD1, ColorStream HD2, or HDMI, and the video resolution is 480i, the menu will display the text *"DNR"*. The available selections are *Off*, *Low*, *Middle*, *High*, and *Auto*. *Auto* will react proportionally to the strength of the noise. *Low*, *Middle*, and *High*, will reduce the noise in varying degrees from lowest to highest, respectively.
 - If the current input is ColorStream HD1, ColorStream HD2, or HDMI, and the video resolution is not 480i, the menu will display the text *"DNR"*.
4. To save the new settings, highlight Done and press ENTER. To revert to the factory defaults, highlight Reset and press ENTER.

Selecting the color temperature

You can change the quality of the picture by selecting from three preset color temperatures (cool, medium, and warm), as described below.

Mode	Picture Quality
cool	blueish
medium	neutral
warm	reddish

To select the color temperature:

1. Press MENU and open the Video menu.
2. Highlight Advanced Picture Settings and press ENTER.

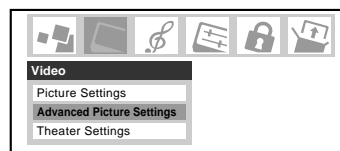

3. In the Color Temperature field, select the mode you prefer (Cool, Medium, or Warm).

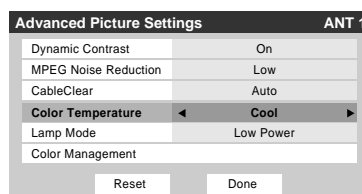

4. To save the new settings, highlight Done and press ENTER. To revert to the factory defaults, highlight Reset and press ENTER.

Note:

If you select one of the factory-set picture modes (*Sports*, *Standard*, or *Movie*) and then change the color temperature mode, the picture mode automatically changes to *Preference* in the *Picture Settings* menu.

Adjusting the picture (continued)

Using MPEG noise reduction

The MPEG noise reduction feature allows you to reduce visible interference caused by MPEG compression. Choices for MPEG noise reduction are High, Medium, Low and Off. Off is automatically selected when this feature is disabled (“grayed out”). This feature is not available in the PC input mode.

To select MPEG Noise Reduction preferences:

1. Press MENU and open the Video menu.
2. Highlight Advanced Picture Settings and press ENTER.

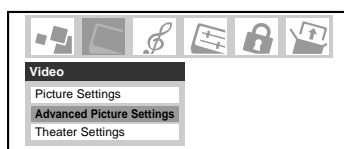

3. In the MPEG Noise Reduction field, select your desired setting.

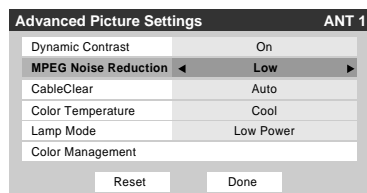

4. To save the new settings, highlight Done and press ENTER. To revert to the factory defaults, highlight Reset and press ENTER.

Using dynamic contrast

When dynamic contrast is set to “On,” the TV will detect changes in the picture quality that affect the appearance of your contrast settings and automatically adjust the video. When dynamic contrast is set to “Off,” the settings selected in the Contrast field in Picture Settings will be used.

To select dynamic contrast preferences:

1. Press MENU and open the Video menu.
2. Highlight Advanced Picture Settings and press ENTER.

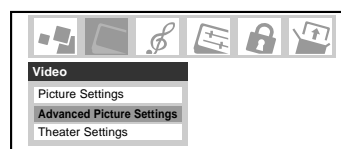

3. In the Dynamic Contrast field, select either On or Off.

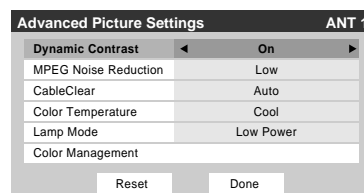

4. To save the new settings, highlight Done and press ENTER. To revert to the factory defaults, highlight Reset and press ENTER.

Note:

If you select one of the factory-set picture modes (Sports, Standard, or Movie) and then change the dynamic contrast to “On,” the picture mode automatically changes to Preference in the Picture Settings menu.

Using the closed caption mode

The closed caption mode has two options:

- Captions—An on-screen display of the dialogue, narration, and sound effects of TV programs and videos that are closed captioned (usually marked “CC” in program guides).
- Text—An on-screen display of information not related to the current program, such as weather or stock data (when provided by individual stations).

To view captions or text:

1. Press MENU and open the Preferences menu.
2. Highlight Closed Caption Mode and then press ►.
3. Press ▼ or ▲ to select the desired closed caption mode and press ENTER.

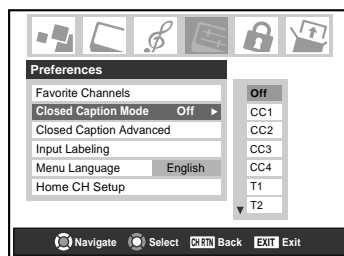

• To view captions:

Highlight CC1, CC2, CC3, or CC4. (CC1 displays translation of the primary language in your area.)



Note: If the program or video you selected is not closed captioned, no captions will display on-screen.

• To view text:

Highlight T1, T2, T3, or T4.

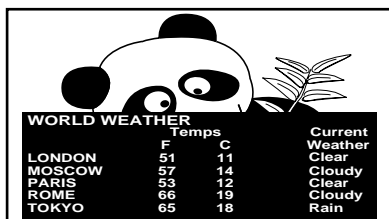

Note: If text is not available in your area, a black rectangle may appear on your screen. If this happens, turn the Closed Caption Mode Off.

• To turn off the Closed Caption mode:

Select Off in step 3 above.

Note: A closed caption signal may not display in the following situations:

- When a videotape has been dubbed
- When the signal reception is weak
- When the signal reception is non-standard

Advanced closed captions

You can customize the closed caption display characteristics by changing the text size, type, edge, color, and the background color.

Note:

- This feature is available for digital channels only.
- You cannot set the Caption Text and Background as the same color.

To customize the closed captions:

1. Press MENU and open the Preferences menu.
2. Highlight Closed Caption Advanced and press ENTER.
3. Press ▲ or ▼ to highlight the characteristic you want to change, and then press ◀ or ▶ to select the format for that characteristic.

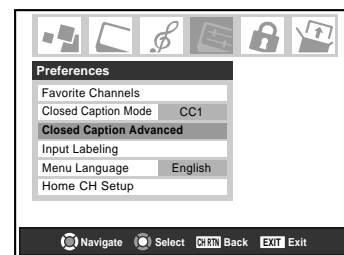

4. To save the new settings, highlight Done and press ENTER. To revert to the factory defaults, highlight Reset and press ENTER.

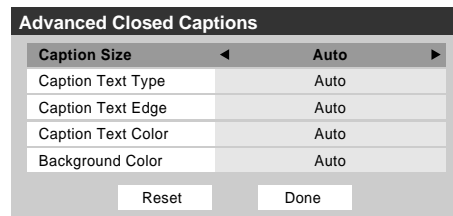

Caption Size	Auto, Small, Standard, Large
Caption Text Type	Auto, Default, Mono w. Serif, Prof. w. Serif, Mono w/o Serif, Prop w/o Serif, Casual, Cursive, Small Capitals
Caption Text Edge	Auto, None, Raised, Depressed, Uniform, Left Drop Shadow, Right Drop shadow
Caption Text Color	Auto, Black, White, Red, Green, Blue, Yellow, Magenta, Cyan
Background Color	Auto, Black, White, Red, Green, Blue, Yellow, Magenta, Cyan

Note: You cannot set the Caption Text and Background as the same color.

Using the closed caption mode (continued)

Digital closed captions

You can use the Digital CC/Audio selector to select digital closed caption services (if available), which will temporarily override closed captions for digital channels only.

When such services are not available, the Digital CC/Audio selector presents a default list of services. If the selected service is not available, the next best service will be used instead.

To select digital closed captions:

1. Press MENU and open the Applications menu.
2. Highlight Digital CC/Audio Selector and press ENTER.

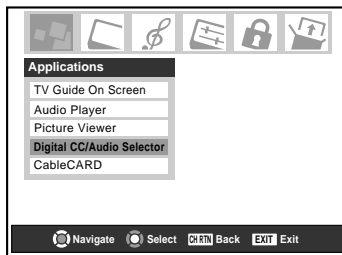

3. Press ▲ or ▼ to select Closed Caption, and then press ◀ or ▶ to select the desired service.



Adjusting the audio

Muting the sound

Press MUTE to partially reduce (1/2 Mute) or turn off (Mute) the sound. Each time you press MUTE, the mute mode will change in the following order.

→ 1/2 Mute → Mute → Volume →

If the closed caption mode is set to Off when you select "MUTE" mode, the closed caption feature is automatically activated. To mute the audio without automatically activating the closed caption feature, use the VOL ▼ button to set the volume to 0. See "Using the closed caption mode" on page 82 for more information on closed caption modes.

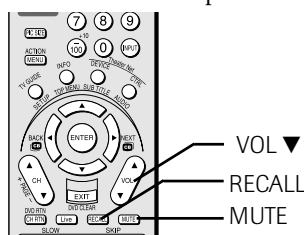

Using the digital audio selector

You can use the Digital CC/Audio selector to conveniently switch between audio tracks on a digital channel (for those channels that have multiple audio tracks). This temporarily overrides the audio track chosen by the language option under Audio Setup.

1. Press MENU and open the Applications menu.
2. Highlight Digital CC/ Audio Selector and press ENTER.
3. Press ▲ or ▼ to select Audio, and then press ◀ or ▶ to select the desired service.

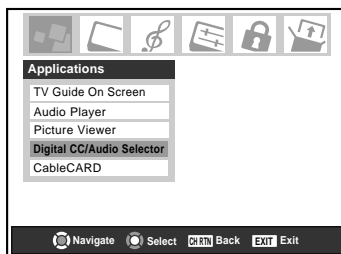

Selecting stereo/SAP broadcasts

The multi-channel TV sound (MTS) feature allows you to output high-fidelity stereo sound. MTS also can transmit a second audio program (SAP) containing a second language, music, or other audio information (when provided by individual stations).

The MTS feature is not available when the TV is in VIDEO mode. When the TV receives a stereo or SAP broadcast, the word "STEREO" or "SAP" appears on-screen when RECALL is pressed.

To listen to stereo sound:

1. Press MENU and open the Audio menu.
2. Highlight Audio Setup and press ENTER.
3. In the MTS field, select Stereo.

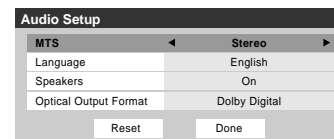
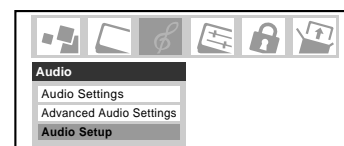

4. To save the new settings, highlight Done and press ENTER. To reset the settings to the factory defaults, highlight Reset and press ENTER.

Note:

- You can leave the TV in Stereo mode because it automatically outputs the type of sound being broadcast (stereo or monaural).
- If the stereo sound is noisy, select MONO to reduce the noise.

To listen to an alternate language on an ATSC digital station (if available):

Highlight the Language field in step 3 above, and then press ◀ or ▶ to select the language you prefer.

To listen to a second audio program on an analog station (if available):

Select SAP in step 3 above.

Note:

- A second audio program (SAP) can be heard only on those TV stations that offer it. For example, a station might broadcast another language as a second audio program. If you have SAP on, you will see the current program on the screen but hear the other language instead of the program's normal audio.
- If you have SAP on and the station you are watching is not broadcasting a second audio program, the station's normal audio will be output. However, occasionally there is no sound at all in SAP mode. If this happens, set the MTS feature to Stereo mode.

Adjusting the audio (continued)

Adjusting the audio quality

You can adjust the audio quality by adjusting the bass, treble, and balance.

To adjust the audio quality:

1. Press MENU and open the Audio menu.
2. Highlight Audio Settings and press ENTER.

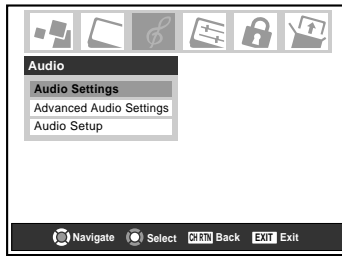

3. Press ▼ or ▲ to highlight the item you want to adjust (Bass, Treble, or Balance).

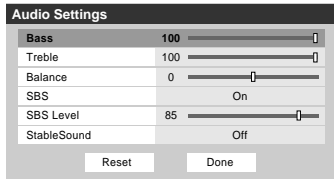

4. Press ◀ or ▶ to adjust the level.
 - ◀ makes the bass or treble weaker or increases the balance in the left channel (depending on the item selected).
 - ▶ makes the bass or treble stronger or increases the balance in the right channel (depending on the item selected).
5. To save the new settings, highlight Done and press ENTER. To reset the settings to the factory defaults, highlight Reset and press ENTER.

Using the sub-bass system (SBS)

The sub-bass system allows you to enhance bass performance, even when the volume is low.

To turn on the SBS and adjust the level:

1. Press MENU and open the Audio menu.
2. Highlight Audio settings and press ENTER.
3. In the SBS field, select On.
4. Press ▲ or ▼ to highlight SBS Level, and then press ◀ or ▶ to adjust the sub-bass system.

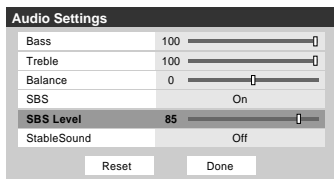

5. To save the new settings, highlight Done and press ENTER. To reset the settings to the factory defaults, highlight Reset and press ENTER.

To turn off the SBS:

Select Off in step 3.

Using the StableSound® feature

The StableSound® feature limits the highest volume level to prevent extreme changes in volume when the signal source changes (for example, to prevent the sudden increase in volume that often happens when a TV program switches to a commercial).

To turn on the StableSound® feature:

1. Press MENU and open the Audio menu.
2. Highlight Audio Settings and press ENTER.

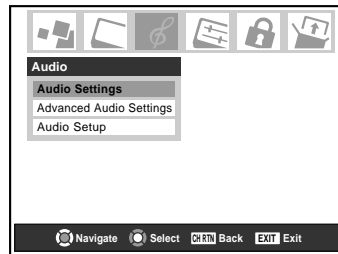

3. In the StableSound field, select On.

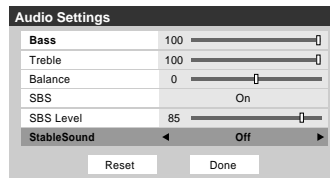

4. To save the new settings, highlight Done and press ENTER. To reset the settings to the factory defaults, highlight Reset and press ENTER.

Note: The RESET function returns your audio adjustments to the following factory settings:

Bass center (50)
 Treble center (50)
 Balance center (0)
 StableSound... Off

To turn off the StableSound feature:

Select Off in step 3 above.

Adjusting the audio (continued)

Using the SRS WOW™ surround sound feature

WOW™ is a special combination of SRS Labs audio technologies (SRS 3D, FOCUS, and TruBass) that creates a thrilling surround sound experience with deep, rich bass from stereo sound sources. Your TV's audio will sound fuller, richer, and wider.

To adjust the WOW™ settings:

1. Put the TV in STEREO mode (see "Selecting stereo/SAP broadcasts" on page 84).
2. Press MENU and open the Audio menu.
3. Highlight Advanced Audio Settings and press ENTER.

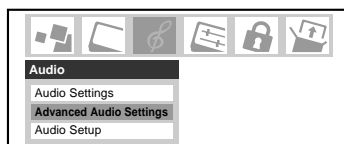

4. Press ▼ or ▲ to highlight the WOW feature you want to adjust, and then press ◀ or ▶ to adjust the item.

Advanced Audio Settings	
WOW: SRS 3D	Off
WOW: FOCUS	Off
WOW: TruBass	Low
Dolby Virtual TruSurround	On
<input type="button" value="Reset"/> <input type="button" value="Done"/>	

- WOW: SRS 3D — To turn the surround sound effect On or Off.



Note: If the broadcast is monaural, the 3D effect does not work.

- WOW: Focus — To turn the vocal emphasis effect On or Off.
- WOW: TruBass — To select the desired bass expansion level (High, Low, or Off).

5. To save the new settings, highlight Done and press ENTER. To revert to the factory defaults, highlight Reset and press ENTER.

Using the Dolby Virtual with SRS TruSurround sound feature

The Dolby® Virtual surround sound feature allows you to enjoy virtual surround sound from the TV's speakers.

- If you connect a device (a game console, a DVD player or a DTV receiver, etc.) with analog audio output to the standard (analog) audio terminals on the TV, and the input source is encoded with Dolby Surround  sound or Dolby Digital  sound, the Dolby Virtual feature operates as Virtual Dolby Surround  (VDS). VDS simulates Dolby Surround sound from the TV's speakers.

To turn on the Dolby Virtual surround sound feature:

1. Press MENU and open the Audio menu.
2. Highlight Advanced Audio Settings and press ENTER.

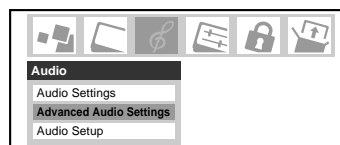

3. Press ▲ or ▼ to highlight the Dolby Virtual TruSurround, and then press ◀ or ▶ to select On.

Advanced Audio Settings	
WOW: SRS 3D	Off
WOW: FOCUS	Off
WOW: TruBass	Low
Dolby Virtual TruSurround	◀ On ▶
<input type="button" value="Reset"/> <input type="button" value="Done"/>	

4. To save the new settings, highlight Done and press ENTER. To revert to the factory defaults, highlight Reset and press ENTER.

To turn off the Dolby Virtual surround sound feature:

Select Off in step 3 above.

Note:

- The Dolby Virtual TruSurround and WOW SRS 3D features cannot be on at the same time. If you set one to On, the other will automatically be set to Off.
- The Dolby Virtual TruSurround feature is enabled only when receiving digital broadcasts.

• WOW, TruSurround, SRS and  symbol are trademarks of SRS Labs, Inc. WOW technology is incorporated under license from SRS Labs, Inc.

Adjusting the audio (continued)

Turning off the built-in speakers

Use this feature to turn off the TV speakers when you connect an audio system to your TV (see “Connecting a digital audio system” and “Connecting an analog audio system” on page 20).

To turn off the built-in speakers:

1. Press MENU and open the Audio menu.
2. Highlight Audio Setup and press ENTER.
3. In the Speakers field, select Off.

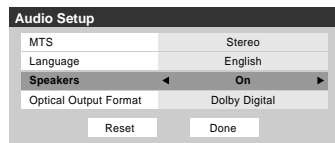
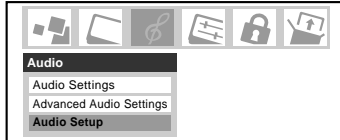

4. To save the new settings, highlight Done and press ENTER. To revert to the factory defaults, highlight Reset and press ENTER.

To turn on the built-in speakers:

Select On in step 3 above.

Selecting the optical audio output format

Use this feature to select the optical audio output format when you connect a Dolby Digital decoder or other digital audio system to the Optical Audio Out terminal on the TV (see “Connecting a digital audio system” on page 20).

To select the optical audio output format:

1. Press MENU and open the Audio menu.
2. Highlight Audio Setup and press ENTER.
3. In the Optical Output Format field, select either Dolby Digital or PCM, depending on your device.

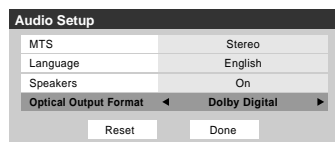
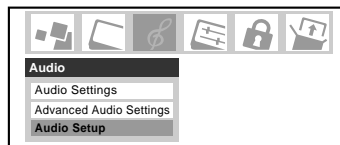

4. To save the new settings, highlight Done and press ENTER. To revert to the factory defaults, highlight Reset and press ENTER.

Setting the On/Off Timer

You can use the On/Off Timer to turn the TV on and off at a preset time on a recurring basis.

Note: You must first set the time (see page 50).

To set the On/Off Timer:

1. Press MENU and open the Setup menu.
2. Highlight On/Off Timer and press ENTER.

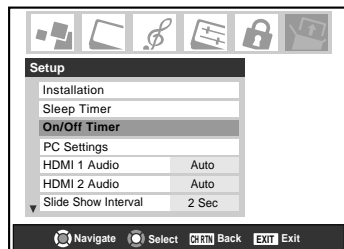

3. In the DAY field, press ◀ or ▶ to select the recurrence (weekends, weekdays, Every day, etc).

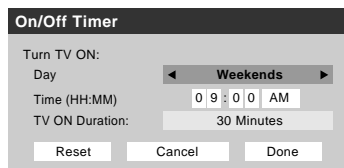

4. Press ▼ to highlight the Time field, and then use the Number buttons to enter the time you want the TV to turn on.
5. When the AM/PM field is highlighted, press ▶ to select AM or PM.
6. Press ▼ to highlight the TV ON Duration field, and then press ◀ or ▶ to select the length of time until the TV turns off.
7. Highlight Done and press ENTER.
8. Turn off the TV. The TV will turn on automatically on the day(s) and at the time you set. The TV will then turn off automatically after the length of time you set in the TV ON Duration field.

Note:

- When a power failure occurs, the On/Off Timer settings may be cleared.
- To display the On Timer setting, press RECALL.

To turn off the On/Off Timer:

Select Not Set in step 3 above.

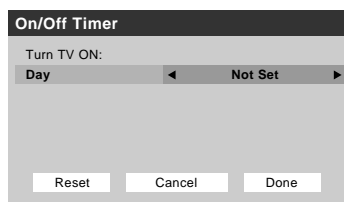

Setting the sleep timer

You can set the sleep timer to turn off the TV after a set length of time (maximum of 3 hours). The sleep timer turns off the TV one time only, as opposed to the On/Off Timer, which turns off the TV on a recurring basis.

To set the sleep timer:

Press SLEEP on the remote control to set the length of time until the TV turns off. Repeatedly press SLEEP to increase the time in 10-minute increments or press ▲ or ▼ to increase or decrease the time in 10-minute increments, to a maximum of 3 hours and 00 minutes.

To cancel the sleep timer:

Press SLEEP until it is set to 0.



To set the sleep timer using the on-screen menus:

1. Press MENU and open the Setup menu.
2. Highlight Sleep Timer and press ENTER.

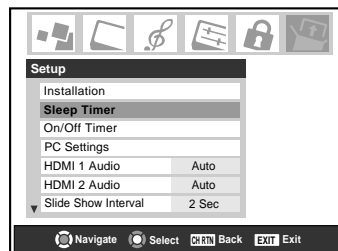

3. Press the Number buttons to enter the length of time in 10-minute increments.

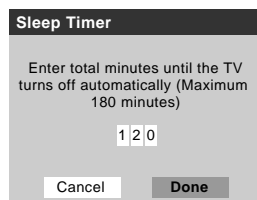

4. Highlight Done and press ENTER.

Note:

- When a power failure occurs, the sleep timer setting may be cleared.
- To display the amount of time left on the sleep timer, press RECALL.

To display the remaining sleep time:

Press SLEEP.

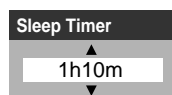

Note:

A message will display on-screen when there is one minute remaining on the sleep timer.

Using the PC setting feature

You can adjust the horizontal position/size, vertical position/size, clock phase, and sampling clock. This feature will be grayed out on the menu unless there is a PC connected to the TV (See “Connecting a personal computer (PC)” on page 29.)

To set the PC setting:

1. Confirm a PC is connected (see “Connecting a personal computer (PC)” on page 29).
2. Repeatedly press INPUT to select PC input mode. (See “Selecting the video input source to view” on page 72.)
3. Press MENU and open the Setup menu.
4. Highlight PC Settings and press ENTER.

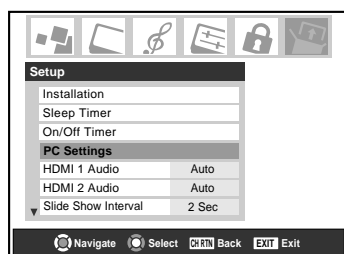

5. Press ▲ or ▼ to highlight the item you want to adjust.
6. Press ◀ or ▶ to make the appropriate adjustments.

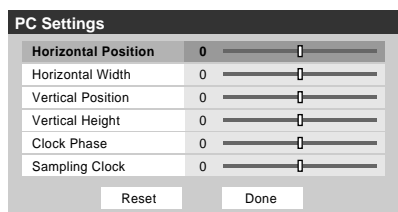

• Horizontal Position/Vertical Position:

Adjusts picture left/right and up/down. The adjustment range is within ± 5 from center.

(The adjustable range may vary depending on the input mode.)

• Horizontal Width/Vertical Height:

Adjusts picture width of Horizontal and picture height of Vertical.

The adjustment range is within ± 5 from center.

• Clock Phase:

This function is to reduce noise and sharpen the picture.

The adjustment range is within ± 15 from center.

• Sampling Clock:

This function is to minimize periodic vertical stripes on the screen.

The adjustment range is within ± 15 from center.

Displaying the Channel Banner

To display the channel banner:

Press **RECALL** on the remote control.

The following information will display in the channel banner (if applicable):

- Current input (ANT 1, ANT 2, VIDEO 1, etc.)
- If ANT 1 or ANT 2 is the current input, whether it is Cable TV ("CABLE") or off-air ("TV")
- Channel number (if in ANT 1 or ANT 2 mode)
- Signal strength indicator (bar graph in lower right corner of banner; for ATSC signal only)

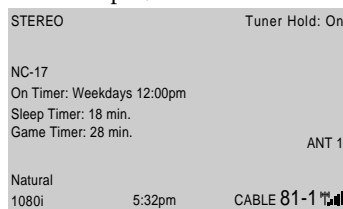

Sample channel banner screen

Note: The signal strength indicator will react to fading and increasing signals and could display longer than the normal channel banner screen.

- Time (if set)
 - On/Off timer settings (if set)
 - Remaining time on sleep timer (if set)
 - Remaining time on game timer (if set)
 - Stereo or SAP audio status
 - V-Chip rating status
 - Picture size
 - Tuner hold* (if applicable)
- *If you are recording on one tuner (for example, the digital tuner), you will be able to change channels on the other tuner only (the analog tuner in this example). The tuner from which you are recording is "on hold" (i.e., locked) so your recordings will not be affected by channel changes.*
- Aspect ratio
 - Lamp mode (appears only if the TV is in Hi Bright mode)

To close the channel banner:

Press **RECALL** again.

Understanding the auto power off feature

The TV will automatically turn itself off after approximately 15 minutes if it is tuned to a vacant channel or a station that completes its broadcast for the day. This feature functions in ANT 1 and ANT 2 modes only.

Understanding the last mode memory feature

If the power is cut off while you are viewing the TV, the Last Mode Memory feature automatically turns on the TV when the power is resupplied.

Note: You should unplug the TV's power cord if it is possible that you will be away from the TV for an extended period of time after the power is restored.

Using the Gray Level feature

The gray level feature will set the sidebars to three different levels of darkness. Sidebars are the blank spaces on either side of a 4:3 viewing area.

To set the gray level of the sidebars:

1. Press **MENU** and open the Setup menu.
2. Highlight Gray Level and press **▶**.
3. Press **▲** or **▼** to select your desired level of darkness (1 – Black, 2 – Dark Gray or 3 – Gray).

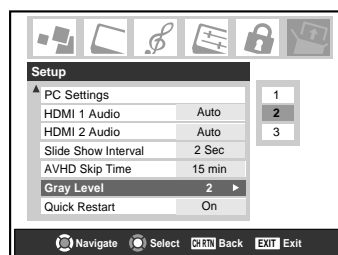

Note:

- The gray level feature does not affect video being viewed in 16:9 aspect ratio.
- When receiving a signal that has sidebars (e.g., 4:3 aspect ratio video over a 1080i or 720p signal), the gray level feature will not be applied to the sidebars.

9 Using the Locks menu

The Locks menu includes the Enable Rating Blocking, Edit Rating Limits, Channels Block, Input Lock, Panel Lock, Game Timer, and New PIN Code features. You can use these features after entering the correct PIN code.

Entering the PIN code

1. Press MENU and highlight the Locks menu icon.

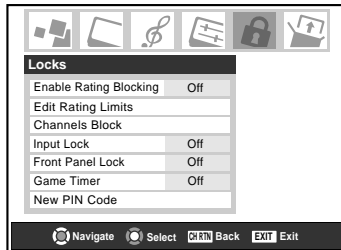

2. Press ▼, which displays the PIN code entry screen.
 - The Lock System screen (below) appears if a PIN code has not been stored. Press the Channel Number buttons to enter a new four-digit code, enter the code a second time to confirm, and press ENTER.

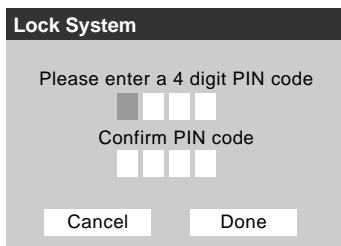

- The Locks/Active screen (below) appears if the PIN code is already stored. Press the Channel Number buttons to enter your four-digit code and press ENTER.

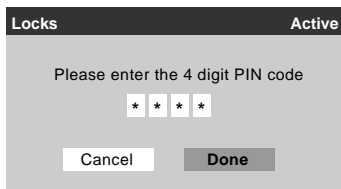

If the wrong PIN code is entered, the message “Incorrect PIN code, please try again!” appears. Highlight Retry and press ENTER. Enter the code again and press ENTER.

When the correct PIN code is entered, the Locks menu opens.

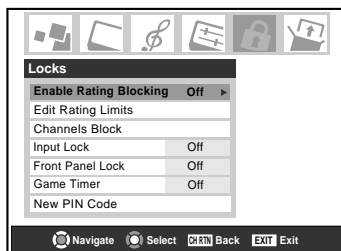

If you cannot remember your PIN code

While the PIN code entering screen is displayed, press RECALL four times within five seconds. The PIN code will be cleared and you can enter a new PIN code.

Changing your PIN code

1. Press MENU and highlight the Locks menu icon.
2. Press ▼ to display the PIN code entering screen.
3. Enter your four-digit PIN code and press ENTER.
4. Press ▼ to highlight New PIN Code and press ENTER.

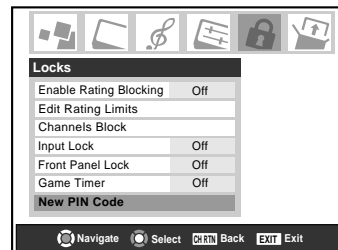

5. Press the Number buttons to enter a new four-digit code. Retype the numbers to confirm the PIN code you entered.
6. Press ENTER. The new PIN code is now active.

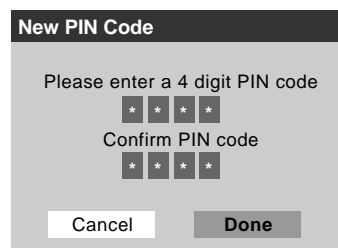

Blocking TV programs and movies by rating (V-Chip)

Some TV programs and movies include signals that classify the content of the program (violence, sex, dialog, language). The V-Chip feature in this TV detects the signals and blocks the programs according to the ratings you select. (See the tables at right for rating descriptions.)

Note: Rating blocking is a function of the V-Chip feature in this TV, which supports the U.S. V-Chip system only.

To block and unblock TV programs and movies:

1. Press MENU and highlight the Locks menu icon.
2. Press ▼ to display the PIN code entering screen.
3. Enter your four-digit PIN code and press ENTER.
4. Press ▼ to highlight Enable Rating Blocking.
5. Press ► and then ▼ to select On, and then press ENTER.

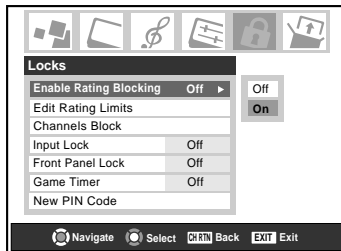

6. Press ▼ to highlight Edit Rating Limits and press ENTER.

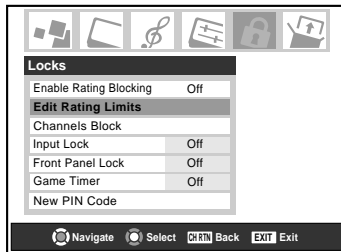

The Edit Rating Limits screen (below) appears.

7. Press ▲▼◀▶ and then press ENTER to select the level of blocking you prefer. A box with an "x" is a rating that will be blocked. As you highlight a rating, a definition for the rating appears at the bottom of the screen. See notes at right.
8. When done selecting the ratings you want to block, highlight Done and press ENTER.

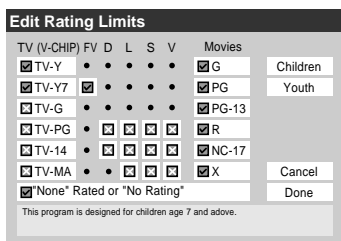

Independent rating system for broadcasters	
Ratings	Description and Content themes
TV-MA	Mature Audience Only (This program is specifically designed to be viewed by adults and therefore may be unsuitable for children under 17.) L) Crude or indecent language S) Explicit sexual activity V) Graphic violence
TV-14	Parents Strongly Cautioned (This program contains some material that many parents would find unsuitable for children under 14 years of age.) D) Intensely suggestive dialog L) Strong, coarse language S) Intense sexual situations V) Intense violence
TV-PG	Parental Guidance Suggested (This program contains material parents may find unsuitable for younger children.) D) Some suggestive dialog L) Infrequent coarse language S) Some sexual situations V) Moderate violence
TV-G	General Audience (Most parents would find this program suitable for all ages.)
TV-Y7, TV-Y7FV	Directed to Older Children (This program is designed for children age 7 and above. Note: Programs in which fantasy violence may be more intense or more combative than other programs in this category are designated Y7FV.)
TV-Y	All Children (This program is designed to be appropriate for all children.)

Independent rating system for movies	
Rating	Description and content themes
X	X-rated (For adults only)
NC-17	Not intended for anyone 17 and under
R	Restricted (Under 17 requires accompanying parent or adult)
PG-13	Parents Strongly Cautioned (Some material may be inappropriate for children under 13)
PG	Parental Guidance Suggested (Some material may not be suitable for children)
G	General Audience (Appropriate for all ages)

Note:

- If you place an "x" in the box next to "None" Rated or "No Rating," programs rated "None" or "No Rating" will be blocked. However, if the program does not provide any rating information, nothing will be displayed in the banner and ratings blocking will not take effect.
- To display the rating of the program you are watching, press RECALL on the remote control. If it is not rated, the word "NONE" appears.

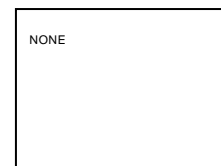
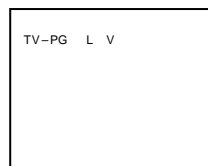

Blocking channels

With the Channels Block feature, you can block specific channels. You will not be able to tune blocked channels unless you clear the setting first.

To block channels:

1. Press MENU and highlight the Locks menu icon.
2. Press ▼ to display the PIN code entering screen.
3. Enter your four-digit PIN code and press ENTER (see page 93 for details).
4. Press ▼ to highlight Channels Block and then press ENTER.
5. Using the ▲▼◀▶ buttons, select the input for which you want to change the rating limits (ANT1, ANT2, or Cable Box, if connected) and press ENTER.

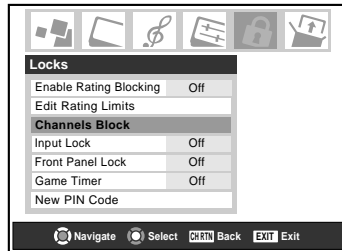

A list of the channels available for that input will be displayed along with the call letters for each channel, if available.

6. Press ▲▼ to highlight the channel you want to block, then press ENTER, which puts an "X" in the box next to that channel.
7. Repeat step 6 for other channels you want to block.

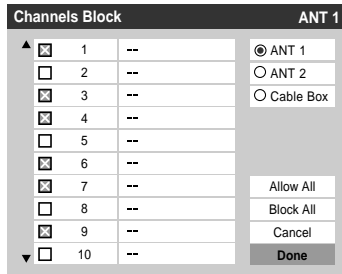

8. Highlight Done and press ENTER.

To unblock individual channels:

In step 6 above, press ▲▼ to highlight the channel you want to unblock, and then press ENTER to remove the "X" from the box, and highlight Done, and then press ENTER.

To block all channels at once:

Highlight Block All in step 6 above, and then highlight Done, and press ENTER.

To unblock all locked channels at once:

Highlight Allow All in step 6 above, and then highlight Done, and press ENTER.

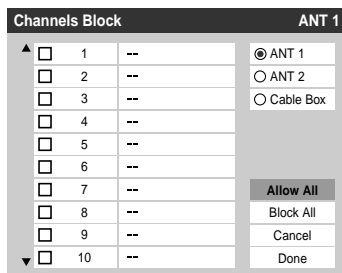

Note: Channel blocking may not take effect if you have a cable box connected and use the cable box controls to change channels.

Unlocking programs temporarily

If you try to watch a TV program that exceeds the rating limits you set, the TV enters program lock mode. You can either unlock the program temporarily or select a non-locked program to watch.

This program exceeds the rating limit you set.
Push 'mute' to enter PIN.

To temporarily unlock the program:

1. Press MUTE.
2. Enter your four-digit PIN code and press ENTER. If the correct code is entered, the program lock mode is released and the normal picture appears. All locking is disabled until the TV is turned off, and will be enabled when the TV is turned on again.

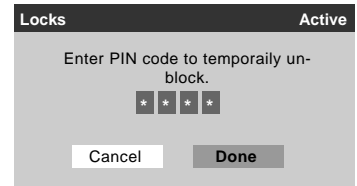

Locking video inputs

You can use the Input Lock feature to lock the video input sources (VIDEO 1, VIDEO 2, VIDEO 3, ColorStream HD-1, ColorStream HD-2, HDMI 1/HDMI 2, PC) and channels 3 and 4. You will not be able to view the input sources or channels until you turn off the input lock.

To lock the video inputs:

1. Press MENU and highlight the Locks menu icon.
2. Press ▼ to display the PIN code entering screen.
3. Enter your four-digit PIN code and press ENTER.
4. Press ▼ to highlight Input Lock and press ▶.
5. Press ▲ or ▼ to select the level of video input locking you prefer, as described below:

Video: Locks VIDEO 1, VIDEO 2, VIDEO 3, ColorStream HD1/HD2, HDMI 1/HDMI 2, and PC.

Video+: Locks VIDEO 1, VIDEO 2, VIDEO 3, ColorStream HD1/HD2, HDMI 1/HDMI 2, PC and channels 3 and 4. Select Video+ if you use the antenna terminal to play a video tape.

Note: Make sure the POP is not on channel 3 or 4.

Off: Unlocks all video input sources.

6. Press ENTER.

Note: When a CableCARD™ is inserted, Video+ will behave the same as Video lock.

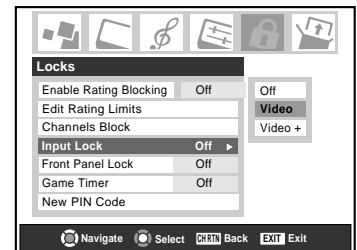

Using the GameTimer™

You can use the GameTimer to set a time limit for playing a video game (30–120 minutes). When the GameTimer is activated, the TV enters VIDEO LOCK mode and locks out the input source for the video game device.

To set the GameTimer™:

1. Press MENU and highlight the Locks menu icon.
2. Press ▼ to display the PIN code entering screen.
3. Enter your four-digit PIN code and press ENTER.
4. Press ▼ to highlight Game Timer and press ►.
5. Press ▲ or ▼ to select the length of time until the Video Lock is activated (30, 60, 90, or 120 minutes) and press ENTER.

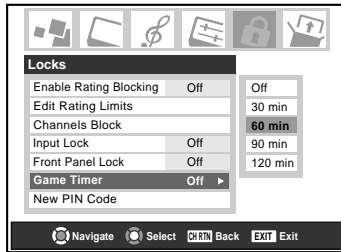

To cancel the GameTimer™:

Select Off in step 5 above.

To deactivate the video lock once the GameTimer has activated it:

Set the VIDEO LOCK to Off (see “Locking video inputs” on page 95).

Note:

- A message will appear on-screen when 10 minutes, 3 minutes, and 1 minute remain on the GameTimer.
- If the TV loses power with time remaining on the GameTimer, when power is restored the TV will enter VIDEO LOCK mode (as if the GameTimer had expired) and you will have to deactivate the video lock (as described above).

Using the control panel lock feature

You can lock the control panel buttons to prevent your settings from being changed accidentally (by children, for example). When the control panel lock is On, none of the controls on the TV control panel will operate except POWER.

To lock the front panel:

1. Press MENU and highlight the Locks menu icon.
2. Press ▼ to display the PIN code entering screen.
3. Enter your four-digit PIN code and press ENTER.
4. Press ▼ to highlight Front Panel Lock.
5. Press ► to highlight On and press ENTER. When the control panel is locked and a button on the control panel except POWER button is pressed, the message “Not Available” appears.

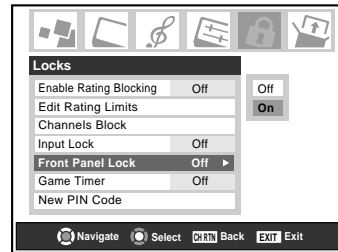

To unlock the front panel:

Highlight Off in step 5 above, or press and hold the VOLUME – button on the TV control panel for about 10 seconds until the volume icon appears on-screen.

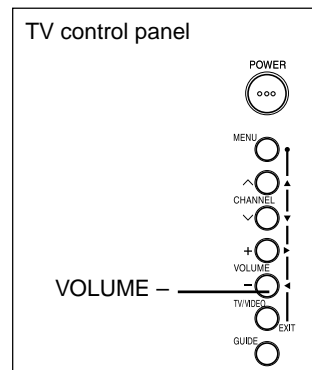

10 Using the memory card JPEG picture viewer/MP3 audio player

You can use the memory card slots on the TV side panel to view compatible JPEG files or play compatible MP3 files stored on a memory card (see “Memory card specifications” below and at right). You can display JPEG files in thumbnail mode or view them as a slide show.

Note:

- **Never remove the memory card or turn off the TV while using the memory card.** Doing so may result in loss of data and/or damage to the memory card and/or TV. SUCH DAMAGE IS NOT COVERED BY YOUR TOSHIBA WARRANTY.
- It is recommended that you back up your memory card data. Toshiba is not liable for any damage caused by the use of any memory card with this TV. Toshiba will not compensate for any lost data or recording(s) caused by the use of such cards.
- For instructions on using your digital camera, refer to the owner's manual for your camera.
- For instructions on using your memory card, refer to the owner's manual for your memory card.
- Failure to take proper care of a memory card may prevent display of pictures or playback of MP3 files from the card or result in damage to the memory card and/or TV. SUCH DAMAGE IS NOT COVERED BY YOUR TOSHIBA WARRANTY. See “Memory card care and handling” on page 90.
- The technical criteria set out in this owner's manual are meant as a guide only.
- Please be advised that you must obtain permission from the applicable copyright owners to download copyrighted content, including music files, in any format, including the MP3 format, prior to the downloading thereof. Toshiba has no right to grant and does not grant permission to download any copyrighted content.

Memory card specifications

Supported memory card types:

-  Memory Card (ver. 1.0)
- MMC (MultiMediaCard™)
- Memory Stick™ (Pro)
- xD-Picture Card™ (16MB-512MB)
- CompactFlash® memory card (Type1)

Note: The picture viewer and audio player support FAT16 formatted cards only. Other memory card formats (including, but not limited to, FAT32 and NTFS) are not supported.

-  is a trademark.
- MMC and MultiMediaCard are trademarks of Infineon Technologies AG and licensed to MMCA (MultiMediaCard Association).
- Memory Stick is a trademark of Sony Corporation.
- xD-Picture Card is a trademark.
- Toshiba is an authorized licensee of the CompactFlash® and CF logo® registered trademarks.

- **Maximum memory card capacity:** 512 MB.
- **Maximum displayable JPEG image size:** 8 MB.
 - JPEG files larger than 8 MB will not display.
- **Maximum MP3 file size:**
 - MP3 files have no size limit other than the maximum capacity of the memory card.
- **Maximum displayable JPEG image resolution:** 6000x4000 pixels.
- **Maximum number of files per directory:** 370.
 - All files over the 370th in a single directory will not display/play.
 - Files in directories more than 10 levels down from the top level directory will not display/play.
- **Maximum number of files per memory card:** JPEG = 1,000; MP3 = 200.
 - All JPEG files over the 1,000th on a single memory card will not display.
 - All MP3 files over the 200th on a single memory card will not play.
- **File name restrictions:**
 - File names cannot contain the following characters: \ / : ? “ < > | .
 - File names must contain US-ASCII characters only.
 - The maximum file name length is 255 characters.
 - The memory card reader recognizes only “.mp3” and “.jpg” file extensions.
 - The MP3 player supports only ISO-8859-1 (US-ASCII/Western European) character sets for MP3 meta-data (e.g. artist name, album name, song title, etc.)
- **JPEG picture viewer:**
 - The picture viewer supports JPEG format images only.
 - The files on your memory card must be in a file and directory format compatible with the TV or they will not display on the TV.
 - Images processed and/or edited on a personal computer (PC) may not display properly or at all. Some digital cameras may store images in a format that is not compatible with the TV.
- **MP3 audio player:**
 - The audio player supports MP3 format files only.
 - The files on your memory card must be in a file and directory format compatible with the TV or they will not play.
 - Files processed and/or edited on a personal computer (PC) may not play properly or at all. Some MP3 files may be in a format that is not compatible with the TV.
- **MP3 files must have the following format:**
 - MPEG1 (ISO/IEC 11172-3) Layer3.
 - Sampling frequency—MPEG1: 32 kHz, 44.1 kHz, 48 kHz.
 - Bitrate—MPEG1: 32–320 kbps.
 - Channels—Stereo, Joint stereo, Dual channel, Single channel.
 - ID3 Ver. 1, Ver. 2.

Using the memory card JPEG picture viewer/MP3 audio player (continued)

Using the JPEG picture viewer

Note: If you stored both JPEG and MP3 files on the same memory card, the JPEG picture viewer will start automatically when you insert the memory card in the TV. To start the audio player, you must first press EXIT to close the picture viewer and then start the audio player while the memory card is still inserted. See "To start the MP3 audio player when a memory card is already inserted," on page 90. **You cannot use the picture viewer and audio player at the same time.**

To view digital photos on your TV:

1. Insert a memory card into the appropriate memory card slot on the side of your TV.

Note:

- **Never insert more than one memory card at a time.**
- **Be sure to insert the card correctly**—label side facing left and the end with the notched corner (if applicable) inserted into the memory card slot.
- When a CompactFlash memory card is inserted correctly, the ejector button pops out (see illustration below).

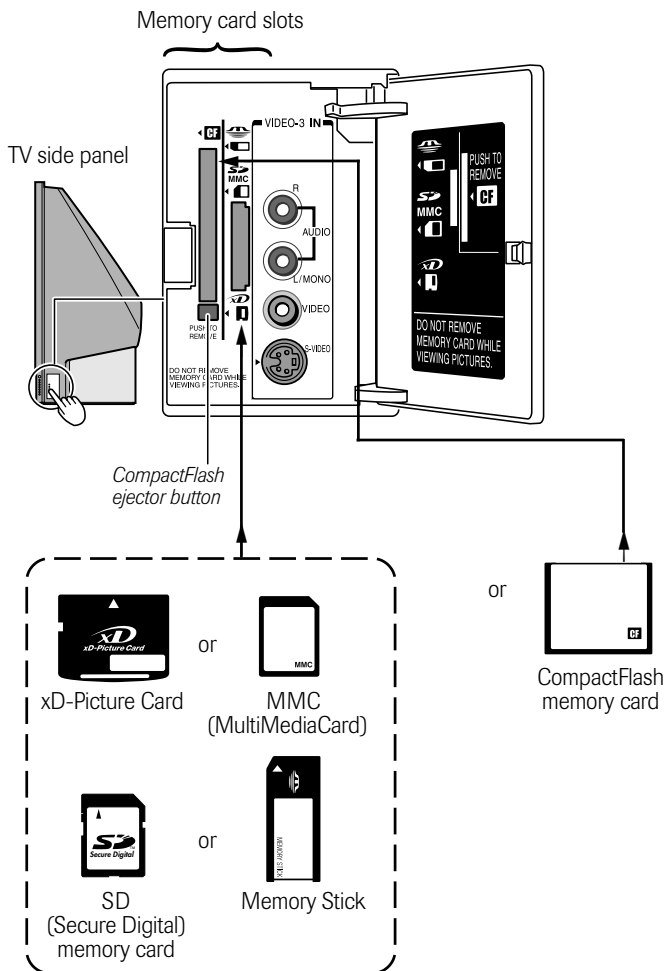

2. In a few seconds, the images automatically display on-screen, with one as a large picture and six in thumbnail format.



3. Press ◀ to rotate the large picture 90° counterclockwise.



4. Press ▶ to rotate the large picture 90° clockwise.

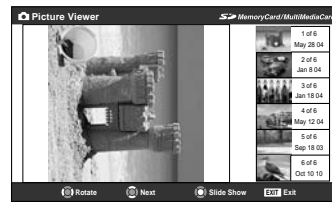

5. Press ▲ or ▼ to select another picture as the large picture.
6. Press ENTER to view your pictures in a slide show.



During the slide show:

- To stop on an image during the slide show, press ENTER. To resume the slide show, press ENTER again.
- To rotate the picture, press ◀ or ▶, and then press ENTER.
- To select another image, press ▲ or ▼, and then press ENTER.
- To stop the slide show and return to the picture viewer, press CH RTN.
- To stop the slide show and return to the regular TV screen, press EXIT.

Using the memory card JPEG picture viewer/MP3 audio player (continued)

To set the slide show interval:

Note: The picture viewer must be closed before you can set the slide show interval.

1. Press MENU and open the Setup menu.
2. Highlight Slide Show Interval and press ENTER. Select the interval from the menu sidebar (2, 5, 10, 15, or 20 seconds).

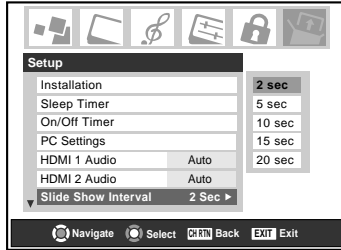

To close the picture viewer:

Press EXIT to close the picture viewer and return to the regular TV screen.

To restart the picture viewer while the memory card is still inserted:

1. Press MENU and open the Applications menu.
2. Highlight Picture Viewer and press ENTER.

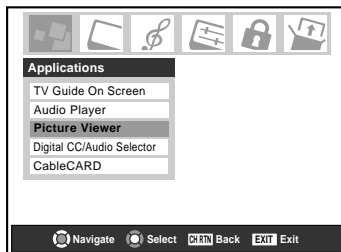

3. Follow the steps under “To view digital photos on your TV” on the previous page.

To close the picture viewer and remove the memory card:

1. Press EXIT to close the picture viewer and return to the regular TV screen.



NOTE: ALWAYS CLOSE THE PICTURE VIEWER BEFORE REMOVING THE MEMORY CARD.

If you remove the memory card while viewing pictures, the card and/or saved data may be damaged. THIS TYPE OF DAMAGE IS NOT COVERED UNDER YOUR TOSHIBA WARRANTY.

2. For a CompactFlash memory card, press the ejector button and then pull the card straight out from the TV. For all other memory cards, pull the card straight out from the TV.

Using the MP3 audio player

Note:

- If you stored both JPEG and MP3 files on the same memory card, the JPEG picture viewer will start automatically when you insert the memory card in the TV. To start the audio player, you must first press EXIT to close the picture viewer and then start the audio player while the memory card is still inserted. See “To start the MP3 audio player when a memory card is already inserted,” next page. **You cannot use the picture viewer and audio player at the same time.**
- Make all desired adjustments to the surround, bass, treble, and balance before starting the MP3 audio player.
- Permission is required in order to download MP3 files and music from the Internet. Toshiba has no right to grant such permission. Permission should always be sought from the copyright owner.

To start the MP3 audio player when a memory card is not already inserted:

1. Insert a memory card into the appropriate memory card slot on the side of your TV (see page 88 for details).

Note:

- **Never insert more than one memory card at a time.**
 - **Be sure to insert the card correctly**—label side facing left and the end with the notched corner (if applicable) inserted into the memory card slot.
 - When a CompactFlash memory card is inserted correctly, the ejector button pops out (see page 88).
2. If you have only MP3 files on the memory card, the audio player will launch within a few seconds after being inserted and begin playing the first MP3 file on the memory card.



3. Press ▲▼◀▶ to navigate to the rewind, pause, fast forward, skip backward, skip forward, volume, and mute buttons, or to select another MP3, and then press ENTER.

To use the mute function

Press ▲▼◀▶ to select the  (mute) button, and then press ENTER. See page 89 for details on muting the sound.

Using the memory card JPEG picture viewer/MP3 audio player (continued)

Using the MP3 audio player (continued)

To start the MP3 audio player when a memory card is already inserted:

1. Press MENU and open the Applications menu.
2. Highlight Audio Player and press ENTER.
3. Press ▲▼◀▶ to navigate to the rewind, pause, fast forward, skip backward, skip forward, volume, and mute buttons, and then press ENTER.

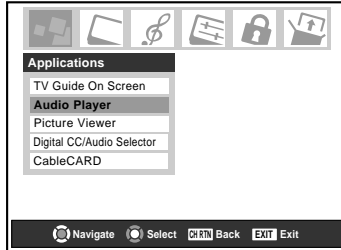

Note: After 30 seconds a screen saver will appear. To access the screen saver immediately, press any button on the remote control.

To close the MP3 audio player:

Press EXIT to close the audio player and return to the regular TV screen.

To close the MP3 audio player and remove the memory card:

1. Press EXIT to close the audio player and return to the regular TV screen.
2. For a CompactFlash memory card, press the ejector button and then pull the card straight out from the TV. For all other memory cards, pull the card straight out from the TV.

Memory card care and handling



NOTE: ALWAYS CLOSE THE AUDIO PLAYER BEFORE REMOVING THE MEMORY CARD.

If you remove the memory card while playing MP3 files, the card and/or saved data may be damaged. THIS TYPE OF DAMAGE IS NOT COVERED UNDER YOUR TOSHIBA WARRANTY.

- Use index labels made exclusively for your specific brand of memory card. Do not use commercially sold labels, which can cause a malfunction when the card is inserted or ejected.
- If the image does not appear correctly or the audio file does not play correctly, clean the metallic area of the memory card using a soft, dry, lint-free, anti-static cloth and then reinsert the card.
- Prevent the metallic area on the memory card from coming in contact with dust, dirt, or other foreign particles. Do not touch the metallic area of the memory card with your hands or otherwise handle it with anything other than a soft, dry, lint-free, anti-static cloth.

Note: Toshiba is not liable for any damage caused by the use of any memory card with this TV. Toshiba will not compensate for any lost data or recordings caused by the use of such cards.

11 Connecting your TV to the Network

You can network the TV with your home Internet service to remotely schedule recordings and reminders by sending an email to the TV. To use this feature, you must have Internet e-mail service in your home and two separate e-mail addresses (your personal e-mail and a second email address for use solely by the TV). Contact your ISP (Internet Service Provider) for these services.

Setting up the Network connection

Setting up the Network address

The following explains how to manually input settings such as the IP address, etc.

Note:

- You must first set up THINC™ to connect to a home network, see page 30.
- This feature is only for remotely scheduling recordings and reminders. You will not be able to access the Internet through the TV.

1. Press MENU and open the Setup menu.
2. Highlight Installation and press ENTER. The Network menu will appear.

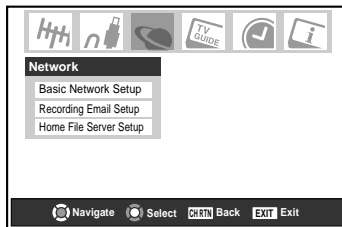

3. Highlight Basic Network Setup, and press ENTER. The screen to confirm automatically obtaining the Network address appears. Highlight No, and then press ENTER.

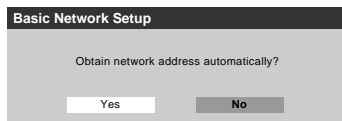

Note: If the network address is automatically obtained, see "To obtain the Network address automatically" at right.

4. Basic Network Setup menu appears.

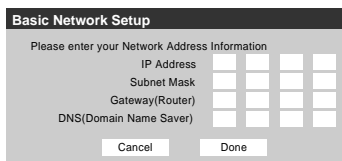

Use ▲▼◀▶ or the number buttons to enter your network address (IP address, Subnet Mask, Gateway (Router), and DNS) provided by the internet service provider.

When finished, highlight Done and press ENTER.

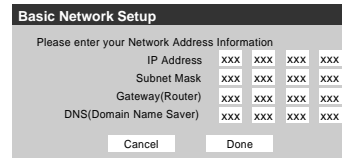

Network address set up is finished, and the Network menu returns.

To obtain the Network address automatically

1. Follow steps 1-2 above.
2. Highlight Basic Network Setup, and press ENTER.

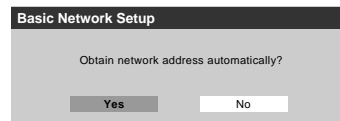

3. Highlight Yes, and then press ENTER.

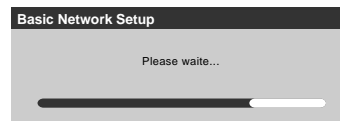

The Completion screen will appear after the address is assigned from the DHCP server. Press ENTER to return to the Network menu.

If obtaining the address from the DHCP server fails, the Error screen will appear. Make sure the the cable is connected to the RJ-45 port terminal securely, and highlight Yes, press ENTER, and set it up again.

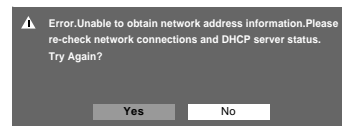

Setting up the Network connection (continued)

To reset the Network address

1. Follow steps 1-2 of “Setting up the Network address”.
2. Highlight Basic Network Setup, and press ENTER. The screen to confirm resetting appears. Highlight Yes and press ENTER.

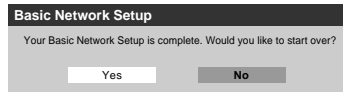

Next, follow step 4 on “Setting up the Network address”.

Set up the Email account

To set up the Email account for timer recording by Email, set the Recording Email setup screen as follows.

Note:

- If you set up the TV address with the same name as another address, large Emails or Email with attached files will be deleted automatically. You must have an Email address for sole use by the TV.

1. Press MENU and open the Setup menu.
2. Highlight Installation and press ENTER. The Network menu appears.

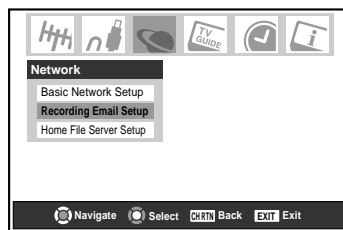

3. Highlight Recording Email Setup, and press ENTER. The Recording Email Setup menu appears.

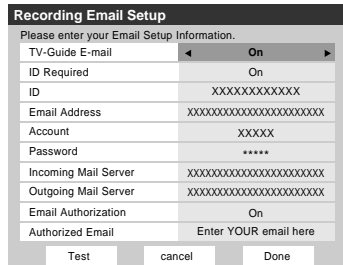

4. Set up the contents below using ▲▼◀▶ and ENTER;
 - TV-Guide Email: Select On or Off. When you select On, it is available to timer record by Email through the TV-Guide Email function.
 - ID required: Select On or Off.

- ID: An ID number is required to add or cancel the timer recording. Press ENTER, and then the keyboard will appear on the screen. Press ▲▼◀▶ to select a character for the first space and then press ENTER. Repeat to enter the rest of the characters.

Note:

Enter a mail verification ID containing 6 or more characters. After you have entered your ID number, then highlight Enter and press ENTER.

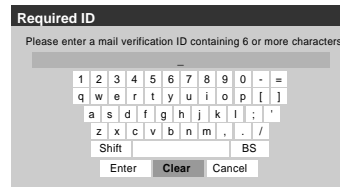

- Email address: Press ENTER to display the keyboard on the screen, and then enter your Email address for your TV.
- Account: Press ENTER to display the keyboard on the screen, and then enter your Email account for your TV.
- Password: Press ENTER to display the keyboard on the screen, and then enter your Email password for your TV.
- Incoming Mail Server (POP3): Press ENTER to display the keyboard on the screen, and then enter your Incoming mail server name of your TV Email.
- Outgoing Mail Server (SMTP): Press ENTER to display the keyboard on the screen, and then enter your Outgoing mail server name of your TV Email.
- Email Authorization: Select On or Off. When you select ON, the TV accepts timer recordings only from an address selected in “Authorized Email” below. When you select Off, the TV accepts timer recordings from multiple addresses.
- Authorized E-mail: Press ENTER to display the keyboard on the screen, and then enter your desired address. the TV accepts timer recordings only from the desired address. You can not input this field when you set the Email Authorization to Off.

When finished, test the setting to make sure the account is set up accurately.

Highlight Test and press ENTER

If the account is set up accurately, highlight “Done” and press ENTER.

Set up the Email account (continued)

Note:

- If you set the Email Authorization to Off, the TV will accept timer recordings from each address. For multiple users, set to Off so that each user can use the timer recording function by Email. Note that if your TV address becomes known to outside parties, you may receive junk Email, so please be careful with your mail address.
- It is better to set up your ID using a different address from the POP address. If the ID address is the same as the POP address, your POP address may become known to outside parties.

Timer recording via Email

You can timer record or delete the programs you set by sending an Email to the TV. With the Email Recording feature, the following commands are available: Add, Delete, Get, or Help. When you send an Email to the TV, make sure to follow the form below.

Note:

- Text or Rich Text (HTML style) is accepted.
- Emails over 16K are automatically deleted.
- Emails with attached files are automatically deleted.



■ Add:

The ADD command schedules a new recording or reminder. The INPUT, CHANNEL, DATE, TIME, and DURATION

```
Subject: add
_____
id myID1234
command add
input ant-1
chan 102-1
date 06/10/2005
time 7 pm
duration 1hr
record
```

must be specified. Sample ADD command email contents (adding a Reminder):

■ Delete:

The DELETE command removes an already scheduled reminder or recording. The INPUT, CHANNEL, DATE, TIME, DURATION, and TYPE must be specified. Sample DELETE command email contents (deleting a Recording):

```
Subject: delete
_____
Id myID1234 Delete ANTENNA-1 102-1 6/10/2005
19:00 1:00 RECORD
```

■ Get:

The GET command retrieves a list of currently scheduled reminders or recordings. Sample GET command email contents:

```
Subject: get
_____
get
```

■ Help:

The HELP command retrieves information on the syntax and purpose of commands and fields. Sample HELP command email contents:

```
Subject: help
_____
help
```

After receiving and processing the email, the TV will reply to the email. The reply email contains one of the following messages:

- ADD SUCCESS
- DELETE SUCCESS
- GET SUCCESS
- HELP SUCCESS

Using the audio player/picture viewer via network

You can enjoy the MP3 files or JPEG files which are stored on a PC, using only the TV remote via network. First, set up the folders which for storing MP3 files or JPEG files to share with the PC, then set up the Home File Server on the TV.

■ Picture viewer

- Picture viewer supports JPG or JPEG format images (96-128 kbps) only.
- Maximum number of files: 1,000 files
- Maximum file size: 8,192,000 Bytes per file
- Maximum directory folder depth is 10
- Compatible with Windows NetBios

■ Audio Player

- Audio Player supports MP3 format files (96-128 kbps) only.
- Maximum numbers of files: 200 files
- Maximum file size: 51,200,000 Bytes per file
- Maximum directory folder depth is 10
- Compatible with Windows NetBios

Procedure for setting up mp3 sharing on Windows XP machine running service pack 2

1. On the PC hosting the folders and files to be shared, right click the folder.
2. From the pop-up menu select "Sharing and Security..."

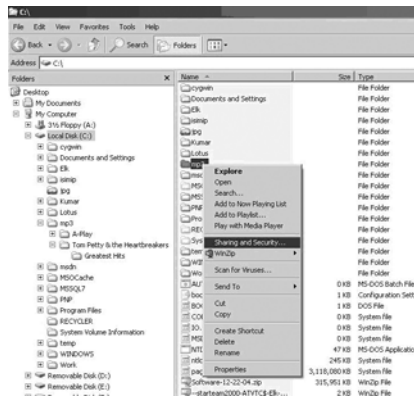

3. In the folder properties dialog, select "Share this folder".



4. To allow anonymous logins (logins without passwords), select the "Security" tab.



5. Click on "Add..."



6. In the "Enter the object names to select" box, type the user name and click on "Check Names".
7. Ensure that the user name shows up as a recognized type. Click "OK".



8. Click on OK all the way through.

Using the audio player/picture viewer via network (continued)

Procedure for Windows XP with service pack 1

1. On the PC hosting the folders and files to be shared, right click the folder.
2. From the pop-up menu select “Sharing and Security...”

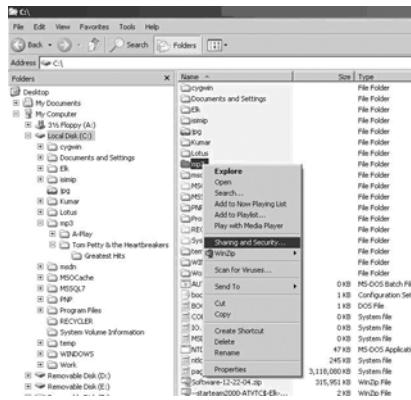

3. In the folder properties dialog box, select “Share this folder on the network”.



4. Click “OK”.

How do I check if my machine is running service pack 1 or 2?

1. Click “Start” button
2. Click “Settings | Control Panel”.
3. In the Control Panel, double-click on “System”.
4. Select the “General” tab to check what operating system and service pack is currently being used.

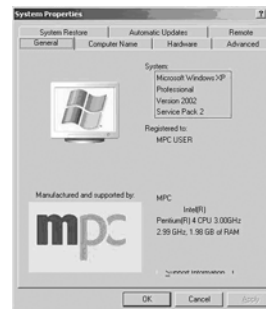

Using the audio player/picture viewer via network (continued)

Set up the Home File server

1. Press MENU and open the Setup menu.
2. Highlight Installation and press ENTER. The Network menu will appear.

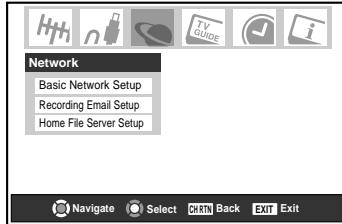

3. Highlight Home File server setup, and press ENTER. The Home File Server Setup menu will appear.

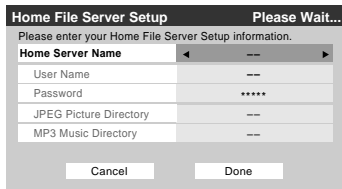

4. Press ◀ or ▶ to select the desired Home Server Name.

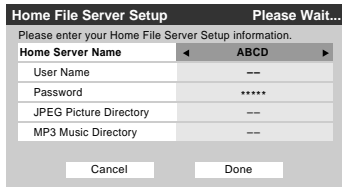

5. Select the User Name or Password field using ▲ or ▼, and then press ENTER to display the keyboard on the screen. Enter the User Name or Password on this screen.

Note: To enter the Home Server Name or Password, see “Set up the Email account” (on page 106).

6. When you highlight the JPEG Picture Directory, the shared folder name will be displayed on the screen. Press ◀ or ▶ to select your desired folder.

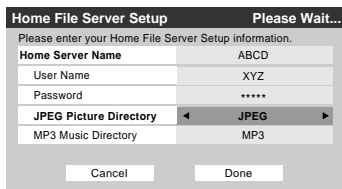

7. When you highlight the MP3 Music Directory, the shared folder will be displayed on the screen. Press ◀ or ▶ to select your desired folder.
8. Highlight “Done” and press ENTER.

To start the Picture viewer/Audio player

1. Press MENU and open the Applications menu.
2. Highlight Picture Viewer or Audio Player, and press ENTER.

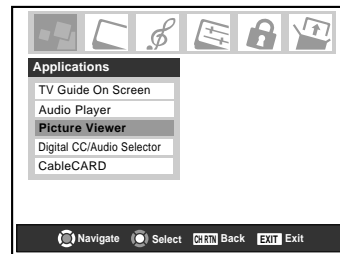

3. The picture viewer or audio player will launch.

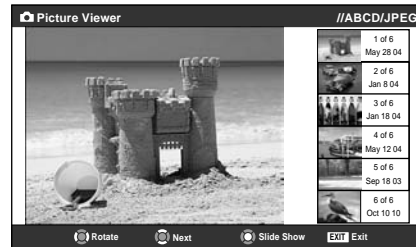

4. Follow the steps under “To view digital photos on your TV” on page 102, or “Using the MP3 audio player” on page 103.

12 Troubleshooting

Before calling a service technician, please check the following table for a possible cause of the symptom and some solutions.

Symptom	Solution
TV will not turn on	<ul style="list-style-type: none">• Make sure the power cord is plugged in, and then press POWER.• The remote control batteries may be dead. Replace the batteries or try the control panel buttons.• If you have recently replaced the lamp unit, make sure the lamp unit and lamp unit door are installed properly (pages 103–105).• The lamp unit may need to be replaced (pages 103–105). Also see “LED indications” on page 99.
Picture problems	<ul style="list-style-type: none">• Check the antenna/cable connections (Chapter 2).• Press INPUT on the remote control or TV/VIDEO on the TV control panel and select a valid video input source (page 67). If no device is connected to any of the inputs on the TV, no picture will display when you select that particular input source. For device connection details, see Chapter 2.• Antenna reception may be poor. Use a highly directional outdoor antenna (if applicable).• The station may have broadcast difficulties. Try another channel.• Adjust the picture qualities (page 79).• If you are using a VCR, make sure the TV/VCR button on the remote control is set correctly (page 26).• If you have two VCRs connected to your TV, do not connect the same VCR to the TV's output and input connections at the same time (page 18).• Do not connect a standard video cable and an S-video cable to VIDEO-1 or VIDEO-2 on the TV back (or VIDEO-3 on the TV side) at the same time (Chapter 2).
Noisy picture	<ul style="list-style-type: none">• If you are watching a tuned analog channel (off-air broadcast or Cable TV), set the CableClear®/DNR feature to AUTO to reduce visible interference in the TV picture (page 80).
Video Input Selection problems	<ul style="list-style-type: none">• If the Input Selection window does not appear when you press INPUT on the remote control or TV/VIDEO on the TV control panel, press INPUT or TV/VIDEO a second time, which will change to the next video input source and display the Input Selection window.
Cannot view external signals or channel 3 or 4	<ul style="list-style-type: none">• If you cannot view signals from external devices connected to VIDEO 1, VIDEO 2, VIDEO 3, or ColorStream®, or from channels 3 or 4, make sure the Input Lock is set to Off (page 95).
Black box on screen	<ul style="list-style-type: none">• Set the Closed Caption feature to Off (page 82).
Poor color or no color	<ul style="list-style-type: none">• The station may have broadcast difficulties. Try another channel.• Adjust the Tint and/or Color (page 79).• When the ColorStream® signal source is active, the VIDEO OUT terminal outputs blank video. To receive video from the VIDEO OUT signal, a standard video or S-video IN terminal must be used instead of the ColorStream® connections.
POP problems	<ul style="list-style-type: none">• The VIDEO OUT terminal will not output the POP picture (pages 18 and 76).• If you label all of the inputs as “Hide,” the POP feature will be disabled. If you then attempt to access the POP feature, the message “Not available” will appear on-screen (page XX).
Picture brightness changes soon after turning on TV	<ul style="list-style-type: none">• If you set the lamp mode to Low Power, each time you turn on the TV, the lamp will start out in High Bright mode but will switch to Low Power mode in approximately 1 minute. You will notice a change in screen brightness when this happens. This is normal and is not a sign of malfunction. (See page XX.)
Picture and sound are out of sync	<ul style="list-style-type: none">• As with all products that contain a digital display, in rare instances, when viewing certain content (e.g., television broadcasts, video games, DVD), you may notice that the sound and picture are slightly out of sync. This phenomenon can be caused by various factors including, without limitation, video processing within the TV, video processing in an attached gaming system, and video processing/different compression rates used by broadcasters in their programming. You may want to try one or more of the following suggestions, which may help to reduce the effect of this phenomenon:<ul style="list-style-type: none">- If the TV is connected to an A/V receiver that has a programmable audio delay feature, use this feature to help synchronize the sound to the picture.- If you notice this phenomenon only on certain TV channels, please contact your local broadcast, cable, or satellite provider to inform them of this issue.

Chapter 12: Troubleshooting

Symptom	Solution
Memory card problems	<ul style="list-style-type: none">• Make sure you are using a supported or valid memory card format (page 87).• Make sure you have saved the picture files in the correct file format (page 87).• The card may be inserted improperly. Remove the card and reinsert it (page 88).• The memory card may be empty.• The memory card may be damaged.
“Now Booting” message appears on-screen	<ul style="list-style-type: none">• If you unplug the power cord while the TV is on, when you plug the power cord in again, the message “Now Booting...” will display on-screen until the picture appears. This is normal and is not a sign of malfunction.
Sound problems	<ul style="list-style-type: none">• Check the antenna/cable connections (see Chapter 2).• The station may have broadcast difficulties. Try another channel.• The sound may be muted. Press VOLUME.• If you hear no sound, try setting the MTS feature to STEREO mode (page 84).• Make sure the Speakers function in the Audio Setup menu is set correctly (page 86).• If you are not receiving a second audio program from a known SAP source, make sure the MTS feature is set to SAP mode (page 84).• If you hear audio that seems “incorrect” for the program you are watching (such as music or a foreign language), the SAP mode may be on. Set the MTS feature to STEREO mode (page 84).• When using an external audio amplifier, if you connect the amplifier to the VAR. AUDIO OUT terminals, the volume of the TV and amplifier must be set above 0 or you will not hear any sound (page 20).
Remote control problems	<ul style="list-style-type: none">• Make sure the remote control is set to the correct device mode (page 28).• Remove all obstructions between the remote control and the TV.• The remote control batteries may be dead. Replace the batteries (page 28).• Your TV remote control may not operate certain features on your external device. Refer to the owner’s manual for your other device to determine its available features. If your TV remote control does not operate a specific feature on another device, use the remote control that came with the device (page 28).• If the TV still does not act as expected, use the Restore Factory Defaults procedure as described on page 52.
Channel tuning problems	<ul style="list-style-type: none">• Make sure the remote control is set to the correct device mode (page 28).• The channel may have been erased from the channel memory by the Channel Add/Delete feature. Add the channel to the channel memory (page 43).• The channel may be blocked by the Channels Block feature. Unblock the channel (page 95).• If you are unable to tune digital channels, check the antenna configuration (page 41). If you are still unable to tune digital channels, clear all channels from the channel list (page 43) and reprogram channels into the channel memory (page 42). If you are still unable to tune digital channels, use the Restore Factory Defaults procedure as described on page 52. Also see “Other problems,” on the next page.
Closed caption problems	<ul style="list-style-type: none">• If the program or video you selected is not closed-captioned, no captions will display on-screen (page 82).• If text is not available, a black rectangle may appear on-screen. If this happens, turn off the closed caption feature (page 82).• A closed caption signal may not display correctly in the following situations: a) when a videotape has been dubbed; b) when the signal reception is weak; or c) when the signal reception is nonstandard (page 82).
Rating Blocking (V-Chip) problems	<ul style="list-style-type: none">• If you forget your PIN code: While the PIN code entering screen is displayed, press RECALL four times within 5 seconds. The PIN code you previously stored will be cleared (page 93).• The V-Chip feature is available for the U.S. V-Chip system only (page 94).

Chapter 12: Troubleshooting

Symptom	Solution
Recording problems	<ul style="list-style-type: none">• If you use the TV's remote control to start recording, you will not be able to change inputs (page 67), open the POP window (page 76), or open the FAV SCAN multi-window (page 78). If you attempt to do so, the message "Not Available While Recording" will appear on-screen.• If you are recording a digital channel, you will only be able to change analog channels while the recording is in progress. If you are recording an analog channel, you will only be able to change digital channels while the recording is in progress. This is because the TV tuner that is being recorded (digital or analog) will be locked on the channel that is currently recording.• It is recommended that you use the TV's remote control to start recording. If you use a device other than the TV's remote control to start recording and then attempt to access a feature that is normally denied during recording (POP mode, FAV SCAN mode, changing inputs,) the recorded audio and/or video may not be what you intended to record. See pages 67 and 71.• If you connected a Symbio™ AVHD recorder, in order to use its full functionality, you must first set up the TV Guide On Screen™ system (page 23 and Chapter 5).
Other problems	<ul style="list-style-type: none">• If your TV's problem has not been addressed in this Troubleshooting section or the recommended solution has not worked, use the Restore Factory Defaults procedure as described on page 52.
TV stops responding to controls	<ul style="list-style-type: none">• If the TV stops responding to the controls on the remote control or TV side panel buttons and you cannot turn off the TV, press and hold the POWER button on the TV front panel for 5 or more seconds to reset the TV.
Cannot connect to network.	<ul style="list-style-type: none">• Check modem and splitter connections.• Make sure the splitter is connected to the modem or TEL.• Confirm modem's operation with this manual.• Make sure your network address or E-mail account are set correctly (page xx).
Disable network connection	<ul style="list-style-type: none">• Check the LAN cable connection.• Check that the modem's power cord is plugged in.• Make sure your network address or E-mail account are set correctly (page xx).
Unstable network connection.	<ul style="list-style-type: none">• Unplug the LAN cable from an outlet, and then connect again.
Cannot set recording timer by E-mail.	<ul style="list-style-type: none">• Select "Test" to confirm the setup(page xx).• Select "Done" after setting up(page xx).• See Chapter 11 in this manual.

LED indications

The yellow and blue LED lights on the TV (at the bottom center of the TV) indicate the TV's status, as described below:

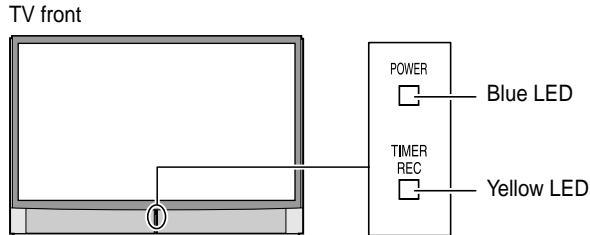

LED Indication	Condition	Solution
1) Yellow blinks continuously at 3-second intervals. Blue blinks continuously at 0.5-second intervals.	The lamp unit door is not seated properly.	Turn OFF the TV and unplug the power cord. Review "How to replace the lamp unit" on pages 104–105 to ensure that the lamp door is installed securely. If the problem persists, contact a Toshiba Authorized Service Center.
2) Yellow blinks continuously at 0.5-second intervals; Blue is ON (solid).	The lamp is not working properly.	The TV will automatically try to restart itself eight times (see item #3).
3) Yellow and Blue blink continuously at 1-second intervals.	The lamp is not working properly after the eighth automatic restart (see item #2).	Turn the TV OFF and then ON again. If the problem persists, replace the lamp unit (see pages 103–105). If the problem still exists, contact a Toshiba Authorized Service Center.
4) Yellow is OFF ; Blue blinks at 0.2-second intervals 4 times (repeat).	An abnormal temperature increase has occurred.	Turn OFF the TV. Check to make sure all slots and openings in the TV cabinet are not covered, blocked, or dusty. Turn ON the TV again. If the problem persists, contact a Toshiba Authorized Service Center.
5) Yellow is OFF ; Blue blinks continuously at 0.5-second intervals.	Abnormal operation (including cooling fan stop).	Turn OFF the TV and unplug the power cord. Plug the power cord in again and turn ON the TV. If the problem persists, contact a Toshiba Authorized Service Center.
6) Yellow is OFF ; Blue blinks continuously at 1-second intervals.	Abnormal operation of BUS line.	Turn OFF the TV and unplug the power cord. Plug the power cord in again and turn ON the TV. If the problem persists, contact a Toshiba Authorized Service Center.
7) Yellow is OFF ; Blue blinks at 0.2-second intervals 3 times (repeat).	The color wheel has stopped.	Turn OFF the TV and unplug the power cord. Plug the power cord in again and turn ON the TV. If the problem persists, contact a Toshiba Authorized Service Center.

TV Guide On Screen™ FAQs

The following are frequently asked questions about the TV Guide On Screen™ system. The answers represent the most likely solutions to the problem.

After you set up the TV Guide On Screen™ system (Chapter 5), the program guide opens automatically by default when you turn on the TV. You can turn off the automatic program guide (see page 40) and instead press the TV GUIDE button on the remote control to manually open the TV Guide On Screen™ program guide.

SETUP

1. **Q: What if I move and my ZIP code or postal code changes?**

A: Highlight Setup in the Service Bar. Press ▼ to highlight Change System Settings (page 65), and then press ENTER. Follow the on-screen prompts to enter new information (see Chapter 3 for details). It can take up to 24 hours to receive new data.

2. **Q: What if I change my cable hook-up to antenna or vice versa?**

A: Highlight Setup in the Service Bar. Press ▼ to highlight Change System Settings (page 65), and then press ENTER. Follow the on-screen prompts to enter new input information and rescan channels for the new input (see Chapter 3 for details).

3. **Q: What if I change cable boxes?**

A: Highlight Setup in the Service Bar. Press ▼ to highlight Change System Settings (page 65), and then press ENTER. Follow the on-screen prompts to enter new input information and rescan channels for the new input (see Chapter 3 for details).

4. **Q: I used to have a cable box, but now I get direct cable. What do I do?**

A: Highlight Setup in the Service Bar. Press ▼ to highlight Change System Settings (page 65), and then press ENTER. Follow the on-screen prompts to enter new input information and rescan channels for the new input (see Chapter 3 for details).

5. **Q: If I add a recorder or change my cable service, how do I change my Setup information?**

A: Highlight Setup in the Service Bar. Press ▼ to highlight Change System Settings (page 65), and then press ENTER. Follow the on-screen prompts to enter new information (see Chapter 3 for details). It can take up to 24 hours to receive new data.

6. **Q: Why does it take up to 24 hours for the TV Guide On Screen™ system to be ready for use?**

A: The initial setup process consists of finding the stations in your area that carry the TV Guide On Screen™ system data and tuning to those stations to receive the setup and listings data.

7. **Q: I had a power outage. Do I need to go through initial setup of the TV Guide On Screen™ system again?**

A: No. The information you entered is stored in the TV Guide On Screen™ system memory.

Note: For Cable box users, the TV must be OFF and the Cable box must be left ON for the TV Guide On Screen™ system to receive channel line-up information.

8. **Q: How do I connect the G-LINK™ (IR blaster) cable to the G-LINK™ input on the TV?**

A: See Chapter 2: Connecting your TV in this manual. You also can refer to the TV Guide On Screen™ prompts during VCR or Cable box setup.

9. **Q: When will I be able to view my TV program listings and use other TV Guide On Screen™ system features?**

A: You will be able to use initial program listings within 24 hours of initial setup. It may take up to one week to receive the full eight days of program listings.

10. **Q: What should I do if I cannot complete initial setup?**

A: If you are unable to complete initial setup using the owner's manual and the on-screen prompts, please call Toshiba's National Service Division at 1-800-631-3811.

11. **Q: If I make a mistake during setup, how do I go back to the previous step?**

A: Complete the remaining setup steps. When "Confirming Your Settings" appears, select "No, repeat setup process." Follow the on-screen prompts and input the correct information.

12. **Q: What if the channel number is not visible on my cable box?**

A: Your cable box may be defaulting to a clock or time display once the channel changes. Watch the box carefully when testing the cable box brand code to see if the channel changes to 09.

13. **Q: Why won't my VCR turn on?**

A: There are several possibilities:

- a) An incorrect or "no VCR" code was entered during the TV Guide On Screen™ initial setup. Press the GUIDE button on the remote control, and then press ► to highlight SETUP. Press ▼ to highlight "Change system settings," and then press ENTER. Follow the on-screen prompts to select the correct VCR information.
- b) Make sure the G-LINK™ (IR blaster) cable is connected correctly (see page 25).
- c) The VCR record timer is on. Turn off the timer.
- d) The wired remote VCR is incompatible.

TV Guide On Screen™ FAQs (continued)

CHANNEL LINEUPS & LISTINGS

14. Q: **Why aren't all my channels initially displayed?**
 A: After initial setup, approximately 120 channels are automatically displayed. The user may use the "Change channel display" feature to turn ON or OFF additional channels.
Note: Even though you have the option of enabling many more channels, the system may not have the memory capacity to hold detailed program descriptions for all of them.
15. Q: **When I opened the TV Guide On Screen™ system, I was asked to choose from more than one channel lineup. What should I do?**
 A: Select the lineup that most closely matches the one for your area. If after you choose the lineup, you want to make changes to it, highlight Setup in the Service Bar. Press ▼ to select Change Channel Display. Follow the on-screen instructions.
16. Q: **Why do all my channels display "No Listing?"**
 A: The TV Guide On Screen™ system has not yet received its data download. The phrase "No Listing" will be replaced with program information during the next download cycle, which will occur within the next 24-hour period.
17. Q: **Why do some of my channels display "No Listing?"**
 A: There are several possibilities:
 a) The channels in question were recently turned ON (in Change channel display) and TV Guide On Screen™ has yet to receive its next data download.
 b) After completing the initial setup, the first data download of the day was interrupted by a VCR recording.
 c) The TV power cord was left unplugged for an extended period of time and the TV Guide On Screen™ system was unable to receive program listings during the scheduled download cycle.
 d) Poor reception caused some of the data to be missed.
 e) The cable box was turned OFF. The TV power cord must be plugged in and the cable box must be ON.
 g) A/V Cable: The VCR was turned OFF. If the connection includes stereo cables with cable box to VCR and stereo connection from VCR to television, the VCR must be ON.
18. Q: **A show entry in the TV Guide On Screen™ system reads "No Listing." What does that mean?**
 A: Show information for that entry was not available during the last TV Guide On Screen™ system information update (download). Show information is updated on a daily basis.
19. Q: **I have seen the word "download" in reference to the TV Guide On Screen™ system. What does that mean?**
 A: "Download" refers to the times throughout the day when the TV Guide On Screen™ system is *receiving* channel and listings information from your Cable or over-the-air antenna transmission.
20. Q: **After some show titles, I have noticed from 1 to 4 stars (****). What does that mean?**
 A: These stars are a broadcast-industry ratings system used to inform you of a show's quality. The more stars, the better the rating.
21. Q: **What do the colors for shows in the Listings and Search screens indicate?**
 A: Green = Sports; Dark Blue = Children's; Purple = Movies; Teal = Other Show.
22. Q: **How do I add, delete, or change the assigned number of channels on the TV Guide On Screen™ system?**
 A: See the "Change channel display" section in the TV Guide On Screen™ owner's manual (see page 65).
23. Q: **Why are some of my channels listed on the wrong number?**
 A: There are several possibilities (see page 65 for details):
 a) Incorrect channel lineup was selected. Access "Change system settings" and choose "Yes, but my channel lineup is incorrect," and then reselect the correct lineup.
 b) Channel lineup changes have not yet been processed. Use the "Change channel display" feature to make adjustments.
 c) Initial setup was done incorrectly (that is, the wrong ZIP/postal code was entered.) Redo the initial setup.
24. Q: **Why doesn't the program highlighted match up with the video window on my TV screen?**
 A: There are several possibilities (see page 65 for details):
 a) The station in question made a late change to its scheduled program listing and the TV Guide On Screen™ system has not yet been updated.
 b) The TV is receiving broadcasts through a modified or boosted antenna system or a satellite dish (not supported by the TV Guide On Screen™ system).
 c) Initial setup was done incorrectly. (i.e., the wrong ZIP/postal code was entered.) Redo the initial setup.
 d) Incorrect channel lineup was selected. Access "Change system settings" and choose "Yes, but my channel lineup is incorrect," and then reselect the correct lineup.
 e) The video window may be locked. Press SPLIT to unlock.
25. Q: **Can I move my favorite stations to the top of the TV Guide On Screen™ display screen?**
 A: Yes. Use the "Change channel display" feature to make adjustments (see page 65). Highlight the station call letters to be moved, then use the BLUE, GREEN, and/or Number buttons to reassign the position of the station.

TV Guide On Screen™ FAQs (continued)

OPERATIONS

26. Q: **How can I look for a specific show in the TV Guide On Screen™ system?**

A: SEARCH lets you find shows by keyword, alphabetically, or by category (HDTV, Movies, Sports, Children, Educational, News, Variety, Series).

27. Q: **My cable box will not change channels with the TV Guide On Screen™ system. What's wrong?**

A: There are several possibilities:

- The incorrect cable box code was entered during TV Guide On Screen™ initial setup. Redo initial setup.
- The G-LINK™ (IR blaster) cable may not be connected properly (see page 25).
- The cable box has no remote capability and is incompatible.

28. Q: **How do I resize or close the Info window?**

A: Press the INFO button on the remote control to resize the Info window. Press the INFO button again to close the Info window.

29. Q: **Is there a way to go directly to the next day's listings without scrolling through each time slot?**

A: Yes. In LISTINGS, highlight the station for which you want to look ahead and use the Channel Number buttons on the remote control to enter "24." In the resulting menu, press ▼ two times to scroll down to select the HOURS AHEAD option, and then press ENTER. You also can use the SKIP button on the remote control.

30. Q: **Why can't I record a show? All I get is snow or a blue screen.**

A: There are several possibilities (without a cable box):

- The recording unit was not connected or set up correctly.
- The incorrect channel lineup was selected. Press GUIDE and then ► to highlight SETUP. Press ▼ to highlight "Change system settings," and then press ENTER. Follow the on-screen prompts to select the correct channel lineup.

31. Q: **Why won't my VCR change channels and why does it change to the wrong channel?**

A: There are two possibilities (with a cable box):

- The VCR is not set on the correct output channel. Set the VCR to 03, 04, or whichever output channel is set by your cable system.
- The VCR and/or cable box are hooked up incorrectly. Refer to your VCR owner's manual or contact your Cable TV company for proper wiring procedures.

32. Q: **Is Help available in the TV Guide On Screen™ system? If so, how do I find it?**

A: Yes. Highlight any of the five main Services (Listings, Schedule, Recordings, Setup, Search) and press the INFO key on the remote control. An expanded Info Box displays additional help information. Press INFO again to close the box.

Help is also available in a panel menu. Press INFO to display an expanded Info Box. Press INFO again to close the box.

RECORD/REMIND

33. Q: **Can I tune to a different channel while recording a program?**

A: No.

34. Q: **How many programs can be scheduled for RECORD in the GUIDE?**

A: There is no limit to the number of shows that can be programmed into the schedule memory.

35. Q: **If a program is scheduled to RECORD on a Regular basis, does it count as five?**

A: No, whether a program is scheduled ONCE, REGULARLY, or WEEKLY, it only counts as one show in the RECORD stack memory.

36. Q: **If I have a power failure, will I need to reset the recorded shows I have already programmed?**

A: The start times and channel numbers of shows that have been programmed will be retained in the memory of the TV Guide On Screen™ system. Titles will appear once listings are restored.

37. Q: **Can I set a Record or Remind event without highlighting a show title in the TV Guide On Screen™ system?**

A: Yes. TV Guide On Screen™ has a Manual Record and Remind feature. Highlight SCHEDULE in the Service Bar, and press MENU. Choose the event type, press ENTER, and then enter the date, start and stop time, channel number, and so forth.

38. Q: **What do the frequencies for Record and Remind mean?**

A: Once—records/reminds the show one time.

Daily (manual only)—records the time, channel, input, recorder combination Monday through Friday.

Regularly— records/reminds the show every time the show airs on the same channel and starts at the same time.

Weekly— records/reminds the show each time the show airs on the same day of the week, on the same channel and starts at the same time.

Off (not cancel)—keeps the show in the Schedule list but will not record/remind the show until the frequency is changed.

Lamp unit replacement and care

Replacing the lamp unit (User-replaceable component)

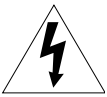

**WARNING: RISK OF
ELECTRIC SHOCK!**



TO REDUCE THE RISK OF ELECTRIC SHOCK, **NEVER REMOVE TV COVERS, EXCEPT AS SPECIFIED HEREIN.** REFER ALL SERVICING NOT SPECIFIED IN THIS MANUAL TO QUALIFIED SERVICE PERSONNEL. Failure to follow this WARNING may result in death or serious injury.

The light source for this TV is a mercury lamp with internal atmospheric pressure that increases during use. The lamp has a limited service life that varies depending on product use and user settings.

As is generally the case with all projection TVs that use projection lamps as a light source, the brightness of the lamp in this TV may vary somewhat over the expected service life and will generally decrease over time. The average useful service life for the lamp is approximately 8,000 hours in Low Power mode or 6,000 hours in High Bright mode. See "Selecting the Lamp mode" on page 75 for information on switching the lamp mode. Because these are averages, some lamps will require earlier replacement.

Note : *The lamp is warranted only for the periods and to the extent set forth in the Limited Warranty applicable to this set, which is a substantially shorter period of time than the average useful service period. See "Limited United States Warranty" on page 121 or "Limited Canada Warranty" on page 122, as applicable.*

If you use the lamp beyond its service life:

- you may notice a reduction in the colors and/or brightness of the picture; and
- the strength of the quartz glass in the lamp will be reduced and the lamp may rupture (often making a loud noise when this happens). If the lamp ruptures, the TV will not operate until the lamp unit is replaced.



CAUTION: Always handle the lamp unit with care.

The lamp unit in this TV was designed for safe replacement by consumers; however, if the lamp unit is subjected to intentional abuse (such as excessive mechanical abuse or handling by children or pets), the unit may break, exposing sharp edges or pinch points.

When to replace the lamp unit

You should replace the lamp unit:

- if the picture darkens and/or colors fade;
- if the screen (lamp) does not light (**LED indication #3, page 99**); or
- if you hear a loud noise and the picture goes black, which may indicate a lamp rupture (**LED indication #3, page 99**).

To obtain a replacement lamp unit:

• In the U.S.:

	Web	Contact
In warranty	www.tacp.toshiba.com/service	Call toll-free 1-800-631-3811.
Out of warranty	www.ceaccessories.toshiba.com	Consult your consumer electronics dealer for availability.

• In Canada:

Contact a Toshiba parts distributor by directing your web browser to www.toshiba.ca. Click "Home Entertainment," and then click "Support."

Use the replacement lamp unit model listed below only. Using any other lamp may cause damage to the TV and/or lamp.



CAUTION: Always replace with same type lamp unit: Model No. D95-LMP (Stock no. 23311153)

Lamp unit replacement and care (continued)

How to replace the lamp unit

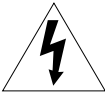

WARNING: RISK OF ELECTRIC SHOCK!



TO REDUCE THE RISK OF ELECTRIC SHOCK, **NEVER REMOVE TV COVERS, EXCEPT AS SPECIFIED HEREIN.** REFER ALL SERVICING NOT SPECIFIED IN THIS MANUAL TO QUALIFIED SERVICE PERSONNEL. Failure to follow this WARNING may result in death or serious injury.

Required tools: Lint-free gloves; manual screwdrivers (Phillips and slotted).

Optional tool: 5/32" or 4mm Allen

1. Turn off the TV and unplug the power cord.



WARNING: Eye damage may result from directly viewing the light produced by this lamp. Always turn off the TV and unplug the power cord before opening the lamp unit door.

2. **STOP!** Allow the lamp to cool for at least one (1) hour before replacing it.



CAUTION: HOT SURFACE!
The temperature of the lamp immediately after use exceeds 392°F (200°C).



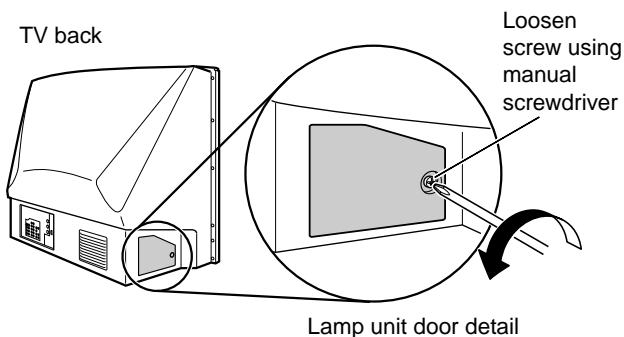

Touching the lamp before it has cooled will result in severe burns. **ALLOW THE LAMP TO COOL FOR AT LEAST ONE (1) HOUR BEFORE REPLACING IT.**

3. On the lamp unit door on the side of the TV, loosen the screw using a manual screwdriver, and then remove the lamp unit door.

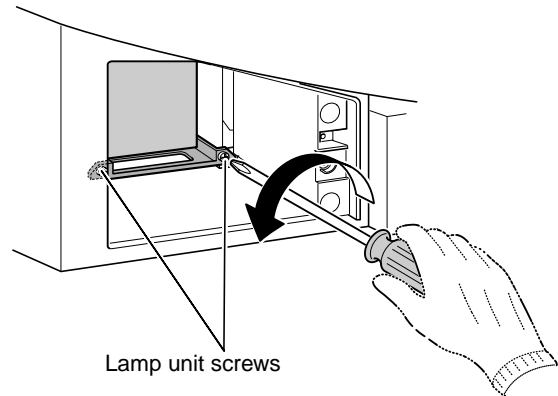

4. Using a manual screwdriver, loosen the two screws on the lamp unit.







WARNING: RISK OF ELECTRIC SHOCK!

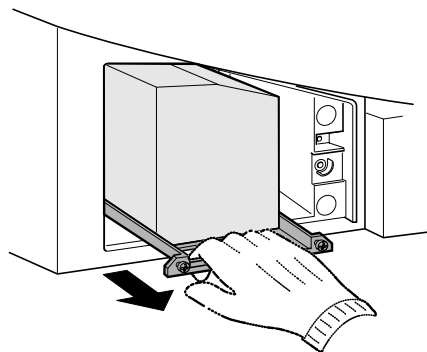

The lamp unit door is provided with an interlock to reduce the risk of electric shock and excessive ultraviolet radiation. **Never defeat its purpose or attempt to service without removing the lamp unit door completely.** Failure to follow this WARNING may result in death or serious injury.

5. Grasp the lamp unit handle and gently pull the lamp unit straight out of the TV. Set the old lamp unit aside (see "Disposing of the used lamp unit" on page 105).



 **Note: Wear soft, lint-free gloves when replacing the lamp unit.**

(continued on next page)

Lamp unit replacement and care (continued)

How to replace the lamp unit (continued)

6. Carefully insert the new lamp unit straight into the TV until it is fully seated.

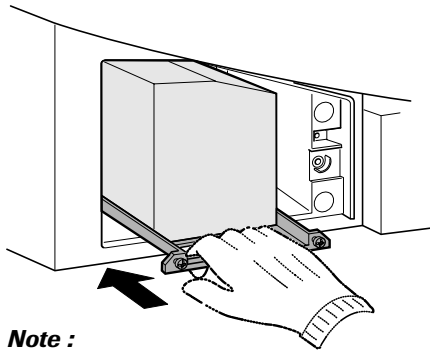

Note :

- Never subject the lamp unit to excessive shock.
- Never touch the lamp unit glass or otherwise get it dirty. Doing so may affect the image quality and reduce the service life of the lamp. See "Cleaning the lamp unit glass" below.

CLEANING THE LAMP UNIT GLASS

If you accidentally touch the lamp unit glass or otherwise get it dirty, wipe it with a lint-free lens cleaning cloth (such as a cloth for cleaning camera lenses or eyeglasses).



CAUTION: NEVER clean a hot lamp with any type of flammable liquid or aerosol cleaning agent. Many ordinary cleaning agents

(such as glass cleaners) contain chemicals that may be flammable at certain temperatures. If the lamp unit is not allowed to cool for at least one (1) hour, such chemicals may ignite.

7. Using a manual screwdriver, tighten the two lamp unit screws.

Note: Hand-tighten only. Do not use an electric screwdriver.

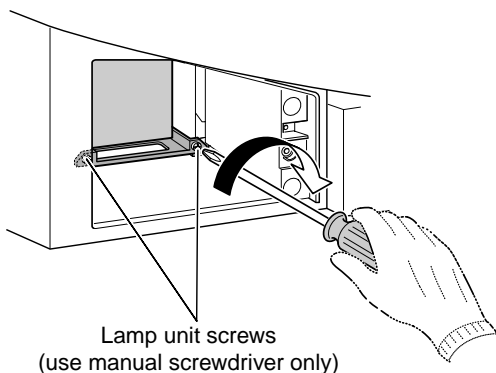

NOTE : Make sure the lamp unit and screws are installed securely; otherwise, the TV may not turn on and the lamp life may be shortened.

8. Reattach the lamp unit door, making sure to insert the hooks on the left side of the lamp unit door inside the opening in the TV cabinet.

Insert the hooks inside the TV cabinet opening.

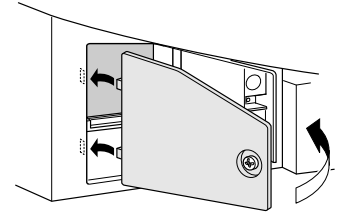

Lamp unit door

9. Replace the screw and hand-tighten using a manual screwdriver.

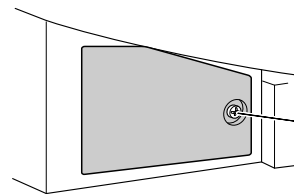

Lamp unit door

Hand tighten using manual screwdriver



NOTE : Make sure the lamp unit door is installed securely; otherwise, the TV may not turn on.

10. Plug in the power cord and turn on the TV. After the initial warmup period (which may take several seconds for full picture brightness), the TV should operate normally. If any of the following conditions exist, turn off the TV, unplug the power cord, and repeat steps 1–9 to ensure that the lamp unit and lamp unit door are installed correctly:

- No picture • Dark picture • TV will not turn on

If, after repeating steps 1–9, the problem still exists:

- In the U.S., call TACP consumer solutions at 1-800-631-3811.
- In Canada, locate the nearest Toshiba authorized service depot by directing your web browser to www.toshiba.ca; click "Home Entertainment," and then click "Support."

Disposing of the used lamp unit

- Place the used lamp unit in the empty box from the new unit.
- Keep the lamp unit out of reach of children and pets.



CAUTION: Always handle the lamp unit with care.

The lamp unit in this TV was designed for safe replacement by consumers; however, if the lamp unit is subjected to intentional or accidental abuse (such as excessive mechanical abuse or handling by children or pets), the unit may break, exposing sharp edges or pinch points.

- Dispose of the used lamp unit by the approved method for your area.



NOTE : The lamp unit contains mercury. Disposal of mercury may be regulated due to environmental considerations. For disposal or recycling information, contact your local authorities or the Electronic Industries Alliance (www.eiae.org).

Specifications

NOTE:

- **This model complies with the specifications listed below.**
- **Designs and specifications are subject to change without notice.**
- **This model may not be compatible with features and/or specifications that may be added in the future.**

Television System

NTSC standard
 ATSC standard (8VSB)
 Digital Cable (64 QAM, 256 QAM; in-the-clear, unencrypted*)
**Encrypted channels can be viewed on this TV using a CableCARD.™ See page 12 for details.*

Channel Coverage

VHF: 2 through 13
 UHF: 14 through 69
 Cable TV: Mid band (A-8 through A-1, A through I)
 Super band (J through W)
 Hyper band (AA through ZZ, AAA, BBB)
 Ultra band (65 through 94, 100 through 135)

Power Source

120 V AC, 60 Hz

Power Consumption

XX W (average)
 XX W in standby mode (using a CableCARD™)
 XX W in standby mode (without a CableCARD™)

Audio Power

XXX W + XXX W

Speaker Type

Main: Two XXX-inch (XXXcm) round
 Tweeter: Two XXX-inch (XXXcm) round

Video/Audio Terminals

S-VIDEO INPUT:

Y : 1 V(p-p), 75 ohm, negative sync.
 C : 0.286 V(p-p) (burst signal), 75 ohm

VIDEO/AUDIO INPUT:

VIDEO: 1 V(p-p), 75 ohm, negative sync.
 AUDIO: 150 mV(rms) (30% modulation equivalent, 22 k ohm or greater)

ColorStream® (component video) HD INPUT:

Y : 1V(p-p), 75 ohm
 PR: 0.7 V(p-p), 75 ohm
 PB: 0.7 V(p-p), 75 ohm
 AUDIO: 150 mV(rms), 22 k ohm or greater
 Suggested formats: 1080i, 480p, 480i, 720p

NOTE: This TV does not provide ColorStream HD OUTPUT.

Video/Audio Terminals (continued)

HDMI™ INPUT:

HDMI compliant (type A connector)
 HDCP compliant
 E-EDID** compliant
 Suggested formats: 1080i, 480p, 480i, 720p
 HDMI Audio: 2-channel PCM; 32/44.1/48 kHz sampling frequency; 16/20/24 bits per sample

NOTE: This TV does not provide HDMI OUTPUT.

VIDEO/AUDIO OUTPUT (also for recording):

VIDEO: 1 V(p-p), 75 ohm, negative sync.
 AUDIO: 150 mV(rms) (30% modulation equivalent, 2.2 k ohm or less)

VARIABLE AUDIO OUTPUT:

0–300 mV(rms) (30% modulation equivalent, 2.2 k ohm or less)

G-LINK™ and IR OUTPUT:

3 V(p-p), 3.5 mm mono socket (IR blaster cables supplied)

IEEE1394 INPUT/OUTPUT:

IEEE1394 compliant 4-pin

DIGITAL AUDIO OUTPUT:

Optical type

PC IN:

Mini D-sub 15 pin Analog RGB

PC AUDIO IN: 3.5 mm stereo mini jack

RJ-45 port:

Dimensions

56MX195: Width: XXX inches (XXX mm)
 Height: XXX inches (XXX mm)
 Depth: XXX inches (XXX mm)
 62MX195: Width: XXX inches (XXX mm)
 Height: XXX inches (XXX mm)
 Depth: XXX inches (XXX mm)
 72MX195: Width: XXX inches (XXX mm)
 Height: XXX inches (XXX mm)
 Depth: XXX inches (XXX mm)

Weight

56MX195: XXX lbs (XXX kg)
 62MX195: XXX lbs (XXX kg)
 72MX195: XXX lbs (XXX kg)

Supplied Accessories

- Two dual-wand IR blaster cables
- Remote control with two size “AA” alkaline batteries
- Owner’s Manual (this book)

Optional Stands:

56MX195: STxxxx
 62MX195: STxxxx
 72MX195: STxxxx

** E-EDID = Enhanced-Extended Display Identification

Limited United States Warranty for DLP™ Television Models

Toshiba America Consumer Products, L.L.C. ("TACP") makes the following limited warranties to original consumers in the United States.

THESE LIMITED WARRANTIES EXTEND TO THE ORIGINAL CONSUMER PURCHASER OR ANY PERSON RECEIVING THIS DLP™ TELEVISION AS A GIFT FROM THE ORIGINAL CONSUMER PURCHASER AND TO NO OTHER PURCHASER OR TRANSFEREE.

DLP™ TELEVISIONS PURCHASED IN THE U.S.A. AND USED ANYWHERE OUTSIDE OF THE U.S.A., INCLUDING, WITHOUT LIMITATION, CANADA AND MEXICO, ARE NOT COVERED BY THESE WARRANTIES.

DLP™ TELEVISIONS PURCHASED ANYWHERE OUTSIDE OF THE U.S.A., INCLUDING, WITHOUT LIMITATION, CANADA AND MEXICO, AND USED IN THE U.S.A., ARE NOT COVERED BY THESE WARRANTIES.

Limited One (1) Year Warranty on Parts and Labor

TACP warrants this DLP™ Television and its parts against defects in materials or workmanship for a period of one (1) year after the date of original retail purchase. DURING THIS PERIOD, TACP WILL, AT TACP'S OPTION, REPAIR OR REPLACE A DEFECTIVE PART WITH A NEW OR REFURBISHED PART WITHOUT CHARGE TO YOU FOR PARTS OR LABOR. During this period, TACP Authorized Service Station personnel will come to your home when warranty service is required. Depending on the type of repair required, the service will either be performed in your home or the DLP™ Television will be taken to a TACP Authorized Service Station for repair and returned to your home at no cost to you.

Limited One (1) Year Warranty on Lamp Unit

TACP warrants the original lamp unit contained in this DLP™ Television against defects in materials or workmanship for a period of one (1) year after the date of original retail purchase. DURING THIS PERIOD, TACP WILL, AT TACP'S OPTION, EXCHANGE A DEFECTIVE LAMP UNIT WITH A NEW OR REFURBISHED LAMP UNIT WITHOUT CHARGE TO YOU. LABOR CHARGES FOR LAMP UNIT REPLACEMENT ARE YOUR RESPONSIBILITY AND ARE NOT COVERED UNDER THIS WARRANTY. The lamp unit is a user-replaceable component.

Rental Units

The warranty for DLP™ Television rental units begins on the date of the first rental or thirty (30) days after the date of shipment to the rental firm, whichever comes first.

Limited Warranty for Commercial Units

TACP warrants DLP™ Televisions, including the lamp units contained therein, that are sold and used for commercial purposes as follows: all parts are warranted against defects in materials or workmanship for a period of ninety (90) days after the date of original retail purchase. DURING THIS PERIOD, TACP WILL, AT TACP'S OPTION, REPAIR OR REPLACE A DEFECTIVE PART WITH A NEW OR REFURBISHED PART WITHOUT CHARGE TO YOU.

Owner's Manual and Product Registration

Read this owner's manual thoroughly before operating this DLP™ television.

Complete and mail the enclosed product registration card or register your DLP™ Television online at www.tacp.toshiba.com/service as soon as possible. By registering your DLP™ Television you will enable TACP to bring you new products specifically designed to meet your needs and help us to contact you in the unlikely event a safety notification is required under the Consumer Product Safety Act. Failure to register your product does not diminish your warranty rights.

Your Responsibility

THE ABOVE WARRANTIES ARE SUBJECT TO THE FOLLOWING CONDITIONS:

- (1) You must retain your original bill of sale or provide other proof of purchase..
- (2) All warranty servicing of this DLP™ Television must be performed by an Authorized TACP Service Station.
- (3) The warranties from TACP are effective only if this DLP™ Television is purchased and operated in the Continental U.S.A. or Puerto Rico.
- (4) Labor service charges for set installation, setup, adjustment of customer controls, and installation or repair of antenna systems are not covered by this warranty. Reception problems caused by inadequate antenna systems, misaligned satellite dishes, cable television distribution, VCRs, DVD players/recorders, personal computer level IEEE1394 devices, and any other connected signal source device are your responsibility..
- (5) Warranties extend only to defects in materials or workmanship as limited above, and do not extend to any DLP™ Television or parts that have been lost or discarded by you or to damage to the DLP™ Television or parts caused by fires, misuse, accident, Acts of God (such as lightning or fluctuations in electric power), improper installation, improper maintenance, or use in violation of instructions furnished by TACP; use or malfunction through simultaneous use of this DLP™ Television and connected equipment; or to units that have been modified or had the serial number removed, altered, defaced, or rendered illegible.

How to Obtain Warranty Service

If, after following all of the operating instructions in this manual and reviewing the section titled "Troubleshooting," you find that service is needed:

- (1) To find the nearest TACP Authorized Service Station, visit TACP's website at www.tacp.toshiba.com/service or contact TACP's Consumer Solution Center toll free at 1-800-631-3811.
- (2) You must present your original bill of sale or other proof of purchase to the TACP Authorized Service Station.

**For additional information, visit TACP's web site:
www.tacp.toshiba.com.**

ALL WARRANTIES IMPLIED BY THE LAW OF ANY STATE OF THE U.S.A., INCLUDING THE IMPLIED WARRANTIES OF MERCHANTABILITY AND FITNESS FOR A PARTICULAR PURPOSE, ARE EXPRESSLY LIMITED TO THE DURATION OF THE LIMITED WARRANTIES SET FORTH ABOVE. WITH THE EXCEPTION OF ANY WARRANTIES IMPLIED BY THE LAW OF ANY STATE OF THE U.S.A. AS HEREBY LIMITED, THE FOREGOING WARRANTY IS EXCLUSIVE AND IN LIEU OF ALL OTHER WARRANTIES, GUARANTEES, AGREEMENTS, AND SIMILAR OBLIGATIONS OF TACP WITH RESPECT TO THE REPAIR OR REPLACEMENT OF ANY PARTS. IN NO EVENT SHALL TACP BE LIABLE FOR CONSEQUENTIAL OR INCIDENTAL DAMAGES (INCLUDING, BUT NOT LIMITED TO, LOST PROFITS, BUSINESS INTERRUPTION, OR MODIFICATION OR ERASURE OF RECORDED DATA CAUSED BY USE, MISUSE OR INABILITY TO USE THIS DLP™ TELEVISION).

No person, agent, distributor, dealer, or company is authorized to change, modify, or extend the terms of these warranties in any manner whatsoever. The time within which an action must be commenced to enforce any obligation of TACP arising under the warranty or under any statute or law of the United States or any state thereof is hereby limited to ninety (90) days from the date you discover, or should have discovered, the defect. This limitation does not apply to implied warranties arising under the law of any state of the U.S.A.

THIS WARRANTY GIVES YOU SPECIFIC LEGAL RIGHTS AND YOU MAY ALSO HAVE OTHER RIGHTS WHICH MAY VARY FROM STATE TO STATE IN THE U.S.A. SOME STATES OF THE U.S.A. DO NOT ALLOW LIMITATIONS ON THE DURATION OF AN IMPLIED WARRANTY, WHEN AN ACTION MAY BE BROUGHT, OR THE EXCLUSION OR LIMITATION OF INCIDENTAL OR CONSEQUENTIAL DAMAGES. THEREFORE, THE ABOVE PROVISIONS MAY NOT APPLY TO YOU UNDER SUCH CIRCUMSTANCES.

Limited Canada Warranty for DLP™ Television Models

Toshiba of Canada Limited ("TCL") makes the following limited warranties to original consumers in Canada.

THESE LIMITED WARRANTIES EXTEND TO THE ORIGINAL CONSUMER PURCHASER OR ANY PERSON RECEIVING THIS DLP™ TELEVISION AS A GIFT FROM THE ORIGINAL CONSUMER PURCHASER AND TO NO OTHER PURCHASER OR TRANSFEREE.

PRODUCTS PURCHASED IN THE U.S.A. AND USED IN CANADA ARE NOT COVERED BY THESE WARRANTIES.

PRODUCTS PURCHASED IN CANADA AND USED IN THE U.S.A. ARE NOT COVERED BY THESE WARRANTIES.

Limited One (1) Year Warranty on Parts and Labor*

TCL warrants this DLP™ television and its parts against defects in materials or workmanship for a period of one (1) year after the date of original retail purchase. DURING THIS PERIOD, TCL WILL, AT TCL'S OPTION, REPAIR OR REPLACE A DEFECTIVE PART WITH A NEW OR REFURBISHED PART WITHOUT CHARGE TO YOU FOR PARTS OR LABOR. TCL Authorized Service Depot personnel will come to your home when warranty service is required. Depending on the type of repair required, either the service will be performed in your home or the set will be taken to the TCL Authorized Service Depot for repair and returned to your home at no cost to you. IN-HOME SERVICE ONLY APPLIES WITHIN 100 KILOMETERS OF AN AUTHORIZED TCL SERVICE DEPOT.

Limited One (1) Year Warranty on Lamp Unit*

TCL warrants the lamp unit in this DLP™ television against defects in materials or workmanship for a period of one (1) year after the date of original retail purchase. DURING THIS PERIOD, TCL WILL, AT TCL'S OPTION, EXCHANGE A DEFECTIVE LAMP UNIT WITH A NEW OR REFURBISHED LAMP UNIT WITHOUT CHARGE TO YOU. LABOR CHARGES FOR LAMP UNIT REPLACEMENT ARE NOT COVERED UNDER WARRANTY. The lamp unit is a user-replaceable component.

Rental Units

The warranty for rental units, including the lamp units contained therein, begins with the date of first rental or thirty (30) days from the date of shipment to the rental firm, whichever comes first.

*Limited Warranty for Commercial Units

TCL warrants DLP™ televisions, including the lamp units contained therein, sold and used for commercial purposes as follows: all parts are warranted against defects in materials or workmanship for a period of ninety (90) days after the date of original purchase. DURING THIS PERIOD, TCL WILL, AT TCL'S OPTION, REPAIR OR REPLACE A DEFECTIVE PART WITH A NEW OR REFURBISHED PART WITHOUT CHARGE TO YOU. ON-SITE SERVICE ONLY APPLIES WITHIN 100 KILOMETERS OF AN AUTHORIZED TCL SERVICE DEPOT.

Owner's Manual and Product Registration

Read this owner's manual thoroughly before operating this DLP™ television.

Register your product online at www.toshiba.ca as soon as possible. By registering your product you will enable TCL bring you new products specifically designed to meet your needs and help us to contact you in the unlikely event a safety notification is required under the Consumer Product Safety Act. Failure to register your product does not diminish your warranty rights.

Your Responsibility

THE ABOVE WARRANTIES ARE SUBJECT TO THE FOLLOWING CONDITIONS:

- (1) You must provide your bill of sale or other proof of purchase.
- (2) All warranty servicing of this DLP™ television must be performed by an Authorized TCL Service Depot.
- (3) These warranties from TCL are effective only if the DLP™ television is purchased in Canada from an authorized TCL dealer and operated in Canada.
- (4) Labor charges for installation, setup, adjustment of customer controls, and installation or repair of antenna systems are not covered by these warranties. Reception problems caused by inadequate antenna systems are your responsibility.
- (5) Warranties extend only to defects in materials or workmanship as limited above, and do not extend to any DLP™ television or parts that have been lost or discarded by you or to damage to the television or parts caused by fires, misuse, accident, Acts of God (such as lightning or fluctuations in electric power), improper installation, improper maintenance, or use in violation of instructions furnished by TCL; use or malfunction through simultaneous use of this product and connected equipment; or to units that have been modified or had the serial number removed, altered, defaced, or rendered illegible.

How to Obtain Warranty Services

If, after following all of the operating instructions in this manual and checking the "Troubleshooting" section, you find that service is needed:

- (1) To find the nearest TCL Authorized Service Depot, visit TCL's web site at www.toshiba.ca.
- (2) Present your bill of sale or other proof of purchase to the Authorized Service Depot.

**For additional information, visit TCL's web site:
www.toshiba.ca**

ALL WARRANTIES IMPLIED BY THE LAW OF ANY PROVINCE OF CANADA, INCLUDING THE IMPLIED WARRANTIES OF MERCHANTABILITY AND FITNESS FOR A PARTICULAR PURPOSE, ARE EXPRESSLY LIMITED TO THE DURATION OF THE LIMITED WARRANTIES SET FORTH ABOVE. WITH THE EXCEPTION OF ANY WARRANTIES IMPLIED BY THE LAW OF ANY PROVINCE OF CANADA AS HEREBY LIMITED, THE FOREGOING WARRANTY IS EXCLUSIVE AND IN LIEU OF ALL OTHER WARRANTIES, GUARANTEES, AGREEMENTS, AND SIMILAR OBLIGATIONS OF TCL WITH RESPECT TO THE REPAIR OR REPLACEMENT OF ANY PARTS. IN NO EVENT SHALL TCL BE LIABLE FOR CONSEQUENTIAL OR INCIDENTAL DAMAGES (INCLUDING, BUT NOT LIMITED TO, LOST PROFITS, BUSINESS INTERRUPTION, OR MODIFICATION OR ERASURE OF RECORDED DATA CAUSED BY USE, MISUSE, OR INABILITY TO USE THIS PRODUCT).

No person, agent, distributor, dealer, or company is authorized to change, modify, or extend the terms of these warranties in any manner whatsoever. The time within which action must be commenced to enforce any obligation of TCL arising under this warranty or under any law of Canada or of any province thereof is hereby limited to 90 days from the date you discover, or should have discovered, the defect. This limitation does not apply to implied warranties arising under the law of any province of Canada.

THIS WARRANTY GIVES YOU SPECIFIC LEGAL RIGHTS, AND YOU MAY ALSO HAVE OTHER RIGHTS, WHICH MAY VARY FROM PROVINCE TO PROVINCE IN CANADA. SOME PROVINCES OF CANADA DO NOT ALLOW LIMITATIONS ON THE DURATION OF AN IMPLIED WARRANTY, LIMITATIONS ON THE TIME WITHIN WHICH AN ACTION MAY BE BROUGHT, OR THE EXCLUSION OR LIMITATION OF INCIDENTAL OR CONSEQUENTIAL DAMAGES; THEREFORE, THE ABOVE LIMITATIONS OR EXCLUSIONS MAY NOT APPLY TO YOU UNDER SUCH CIRCUMSTANCES.

A copy of the GPL source code in this product may be obtained by contacting Toshiba Consumer Solutions at (800)631-3811. There will be a charge to cover the costs of providing the source code.

A copy of the LGPL source code in this product may be obtained by contacting Toshiba Consumer Solutions at (800)631-3811. There will be a charge to cover the costs of providing the source code.

USB Protocol Copyright © 2005 The NetBSD Foundation, Inc. All rights reserved.

Redistribution and use in source and binary forms, with or without modification, are permitted provided that the following conditions are met:

1. Redistributions of source code must retain the above copyright notice, this list of conditions and the following disclaimer.
2. Redistributions in binary form must reproduce the above copyright notice, this list of conditions and the following disclaimer in the documentation and/or other materials provided with the distribution.
3. Neither the name of The NetBSD Foundation nor the names of its contributors may be used to endorse or promote products derived from this software without specified prior written permission.

THIS SOFTWARE IS PROVIDED BY THE NETBSD FOUNDATION, INC. AND CONTRIBUTORS "AS IS" AND ANY EXPRESS OR IMPLIED WARRANTIES, INCLUDING, BUT NOT LIMITED TO, THE IMPLIED WARRANTIES OF MERCHANTABILITY AND FITNESS FOR A PARTICULAR PURPOSE ARE DISCLAIMED. IN NO EVENT SHALL THE FOUNDATION OR CONTRIBUTORS BE LIABLE FOR ANY DIRECT, INDIRECT, INCIDENTAL, SPECIAL, EXEMPLARY, OR CONSEQUENTIAL DAMAGES (INCLUDING, BUT NOT LIMITED TO, PROCUREMENT OF SUBSTITUTE GOODS OR SERVICES; LOSS OF USE, DATA, OR PROFITS; OR BUSINESS INTERRUPTION) HOWEVER CAUSED AND ON ANY THEORY OF LIABILITY, WHETHER IN CONTRACT, STRICT LIABILITY, OR TORT (INCLUDING NEGLIGENCE OR OTHERWISE) ARISING IN ANY WAY OUT OF THE USE OF THIS SOFTWARE, EVEN IF ADVISED OF THE POSSIBILITY OF SUCH DAMAGE.

This product includes software developed by the OpenSSL Project for use in the OpenSSL Toolkit (<http://www.openssl.org>).

This product includes cryptographic software written by Eric Young (ey@cryptsoft.com).

OpenSSL 0.9.7d Copyright © 1998-2000 the OpenSSL Project. All Rights reserved. Redistribution and use in source and binary forms, with or without modification, are permitted provided that the following conditions are met:

1. Redistributions of source code must retain the above copyright notice, this list of conditions and the following disclaimer.
2. Redistributions in binary form must reproduce the above copyright notice, this list of conditions and the following disclaimer in the documentation and/or other materials provided with the distribution.
3. All advertising materials mentioning features or use of this software must display the following acknowledgement: This product includes software developed by the OpenSSL Project for use in the OpenSSL Toolkit (<http://openssl.org>).
4. The names "OpenSSL Toolkit" and "Open SSL Project" must not be used to endorse or promote products derived from this software without prior written permission. For written permission, please contact openssl-core@openssl.org.
5. Products derived from this software may not be called "OpenSSL" nor may "Open SSL" appear in their names without prior written permission of the OpenSSL Project.
6. Redistributions of any form whatsoever must retain the following acknowledgement: "This product includes software developed by the OpenSSL Project for use in the OpenSSL Toolkit (<http://www.openssl.org>)."

THIS SOFTWARE IS PROVIDED BY THE OpenSSL PROJECT "AS IS" AND ANY EXPRESSED OR IMPLIED WARRANTIES, INCLUDING, BUT NOT LIMITED TO, THE IMPLIED WARRANTIES OF MERCHANTABILITY AND FITNESS FOR A PARTICULAR PURPOSE ARE DISCLAIMED. IN NO EVENT SHALL THE OpenSSL PROJECT OR CONTRIBUTORS BE LIABLE FOR ANY DIRECT, INDIRECT, INCIDENTAL, SPECIAL, EXEMPLARY, OR CONSEQUENTIAL DAMAGES (INCLUDING, BUT NOT LIMITED TO, PROCUREMENT OF SUBSTITUTE GOODS OR SERVICES; LOSS OF USE, DATA, OR PROFITS; OR BUSINESS INTERRUPTION) HOWEVER CAUSED AND ON ANY THEORY OF LIABILITY, WHETHER IN CONTRACT, STRICT LIABILITY, OR TORT (INCLUDING NEGLIGENCE OR OTHERWISE) ARISING IN ANY WAY OUT OF THE USE OF THIS SOFTWARE, EVEN IF ADVISED OF THE POSSIBILITY OF SUCH DAMAGE. This product includes cryptographic software written by Eric Young (ey@cryptsoft.com). This product includes software written by Tim Hudson (tjh@cryptsoft.com).

Copyright © 1995-1998 Eric Young (ey@cryptsoft.com). All Rights reserved. This package is an SSL implementation written by Eric Young (ey@cryptsoft.com). The implementation was written so as to conform with Netscapes SSL. This library is free for commercial and non-commercial use so long as the following conditions are adhered to. The following conditions apply to all code found in this distribution, be it the RC4, RSA, lhash, DES, etc., code; not just the SSL code. The SSL documentation included with this distribution is covered by the same copyright terms except that the holder is Tim Hudson (tjh@cryptsoft.com).

Copyright remains Eric Young's, and as such any Copyright notices in the code are not to be removed. If this package is used in a product, Eric Young should be given attribution as the author of the parts of the library used. This can be in the form of a textual message at program startup or in documentation (online or textual) provided with the package.

Redistribution and use in source and binary forms, with or without modification, are permitted provided that the following conditions are met:

1. Redistributions of source code must retain the copyright notice, this list of conditions and the following disclaimer.
2. Redistributions in binary form must reproduce the above copyright notice, this list of conditions and the following disclaimer in the documentation and/or other materials provided with the distribution.
3. All advertising materials mentioning features or use of this software must display the following acknowledgement: "This product includes cryptographic software written by Eric Young (ey@cryptsoft.com)." The word 'cryptographic' can be left out if the routines from the library being used are not cryptographic related.
4. If you include any Windows specific code (or derivative thereof) from the apps directory (application code) you must include an acknowledgement: "This product includes software written by Tim Hudson (tjh@cryptsoft.com)."

THIS SOFTWARE IS PROVIDED BY ERIC YOUNG "AS IS" AND ANY EXPRESS OR IMPLIED WARRANTIES, INCLUDING, BUT NOT LIMITED TO, THE IMPLIED WARRANTIES OF MERCHANTABILITY AND FITNESS FOR A PARTICULAR PURPOSE ARE DISCLAIMED. IN NO EVENT SHALL THE AUTHOR OR CONTRIBUTORS BE LIABLE FOR ANY DIRECT, INDIRECT, INCIDENTAL, SPECIAL, EXEMPLARY, OR CONSEQUENTIAL DAMAGES (INCLUDING, BUT NOT LIMITED TO, PROCUREMENT OF SUBSTITUTE GOODS OR SERVICES; LOSS OF USE, DATA, OR PROFITS; OR BUSINESS INTERRUPTION) HOWEVER CAUSED AND ON ANY THEORY OF LIABILITY, WHETHER IN CONTRACT, STRICT LIABILITY, OR TORT (INCLUDING NEGLIGENCE OR OTHERWISE) ARISING IN ANY WAY OUT OF THE USE OF THIS SOFTWARE, EVEN IF ADVISED OF THE POSSIBILITY OF SUCH DAMAGE. The license and distribution terms for any publicly available version or derivative of this code cannot be changed, i.e. this code cannot simply be copied and put under another distribution license (including the GNU Public License).

Index

A

Antenna cables	11
Audio player	87
Audio quality adjustments	85
Audio system connection	20
Auto aspect	74
Auto power off	92
AVHD	23, 50

B

Back of the TV	10
Blocking channels	95

C

Cable box connection	14, 16
CableCARD™	12
CableClear® DNR	80
Cables	11
Camcorder connection	13
CH ▲▼ buttons	42, 71
Channel Browser™	
CH RTN button	71
Channel Number buttons	42, 71
Channel programming:	
Automatic programming	42
Manually adding and deleting	43
Cinema mode	75
Closed captions	82
Color temperature	80
ColorStream®	10, 17
Connecting devices	12-25
Control panel lock	XX
CompactFlash® memory cards	87, 88
Component video cables	11
Component video (ColorStream®)	10, 17

D

Device connections	12-25
Defaults, restore TV factory	52
Digital Audio Out	20
Digital signal meter	52
DNR (Digital Noise Reduction)	80
Dolby Digital	20, 86
Double-window POP feature	76
DVD player connection	16, 17
D-VHS	23, 50
DVI connection	19
Dynamic Contrast	81

E F G H I J

EIA-775	22
FAV SCAN button	44, 78
Factory defaults, restore TV	52, 79
Favorite channels	44, 78
Features, TV	7
Focus	86
Front of the TV	9
GameTimer™	96
G-LINK™ connection	25
HDMI™ connection	19
IEEE1394	22
INPUT button	67
Input lock	95
Installation, care, and service	3, 4
Installation, setup	8
Integrated digital tuning	7
IR blaster	21
JPEG	87-90

L

Labeling video inputs	68
Lamp mode	75
Lamp unit replacement	103-105
Language selection	41
Last mode memory feature	92
LED indications	8, 9, 99
Locking video inputs	95
LOCKS menu	93
Channels, blocking	95
Enable rating blocking	94
GameTimer™	96
New PIN code	93
Unlocking programs temporarily	95
Video inputs, locking	95

M

Memory cards	87-90
--------------------	-------

Index *(continued)*

Memory Stick™ memory cards	87, 88
Menu system	35, 36
MMC memory cards	87, 88
MP3	87–90
MPEG-2 digital video signals	22
MPEG Noise Reduction	81
MTS feature	84
MUTE button	84

O P Q

ON/OFF timer	91
Optical audio cable	11
Picture adjustments:	
Color temperature	80
Picture mode	79
Picture quality	79
Picture-out-picture (POP):	
FAV SCAN button	78
SPLIT button	76
Picture scroll	74
Picture size selection	73
Picture viewer	87
Problems with TV	97, 98
Quick Restart	51

R

RECALL button	84
Remote control:	
Battery installation	28
Device code table	33, 34
Effective range	27
Functional key chart	29, 30
Learning about the buttons	26
Operational feature reset	32
Programming	31
Searching and sampling the code	31
Volume lock feature	32
Restart, Quick	51
Restore TV factory defaults	52

S

Safety, care, installation, and service	2–5
SAP sound	84
Satellite receiver connection	15
Scrolling the TheaterWide® picture	74
SD (Secure Digital™) memory cards	87, 88
Service	4
Setup, TV	36, 41
Setup, TV Guide On Screen™ system	37
Sleep timer	91
Speakers ON/OFF	86
Specifications	106
SRS 3D	86
SRS WOW™	86
StableSound®	85
Stereo sound	84
Sub-bass (SBS)	85
S-video cables	11
Symbio™ AVHD recorder	23, 50
System status	52

T

TheaterNet™ DEVICE and CONTROL buttons	46
TheaterNet™ control	21
TheaterNet™ setup	45
TheaterWide® picture size	73
Time and date setting	50
Troubleshooting	97, 98
TruBass	86
TV control panel	XX, XX
TV Guide On Screen™	8, 37, 53

V

V-Chip blocking (Locks menu)	93–95
VCR connection	13–18
Video cables	11
Video input labels	68
Video input lock	95

W, X

Warranty	121, 122
WOW™, SRS®	86
xD-Picture Card™	87, 88

TOSHIBA AMERICA CONSUMER PRODUCTS, L.L.C.

HEAD OFFICE: 82 TOTOWA ROAD, WAYNE, NJ 07470, U.S.A.

NATIONAL SERVICE DIVISION: 1420-B TOSHIBA DRIVE, LEBANON, TN 37087, U.S.A.

TOSHIBA OF CANADA LTD.

HEAD OFFICE: 191 McNABB STREET, MARKHAM, ONTARIO, L3R 8H2, CANADA – TEL: (905) 470-5400

SERVICE CENTERS:

TORONTO: 191 McNABB STREET, MARKHAM, ONTARIO L3R 8H2, CANADA – TEL: (905) 470-5400

MONTREAL: 18050 TRANS CANADA, KIRKLAND, QUEBEC, H9J 4A1, CANADA – TEL: (514) 390-7766

VANCOUVER: 22171 FRASERWOOD WAY, RICHMOND, B.C., V6W 1J5, CANADA – TEL: (604) 303-2500

MANUFACTURED BY

TOSHIBA AMERICA CONSUMER PRODUCTS, L.L.C.

CableClear, CinemaSeries, ColorStream, StableSound, and TheaterWide are registered trademarks of Toshiba America Consumer Products, L.L.C.

ChannelBrowser, GameTimer, SurfLock, Symbio, and TheaterNet are trademarks of Toshiba America Consumer Products, L.L.C.

Digital Light Processing, DLP™ and the DLP medallion are trademarks of Texas Instruments.

PRINTED IN USA
(05-08)

Copyright © 2005 TOSHIBA CORPORATION. All rights reserved.

TOSHIBA

YC/N 23566730

Free Manuals Download Website

<http://myh66.com>

<http://usermanuals.us>

<http://www.somanuals.com>

<http://www.4manuals.cc>

<http://www.manual-lib.com>

<http://www.404manual.com>

<http://www.luxmanual.com>

<http://aubethermostatmanual.com>

Golf course search by state

<http://golfingnear.com>

Email search by domain

<http://emailbydomain.com>

Auto manuals search

<http://auto.somanuals.com>

TV manuals search

<http://tv.somanuals.com>