

TOSHIBA

Projection Television

OWNER'S MANUAL

TP50H60/TP55H60/TP61H60

ColorStream™

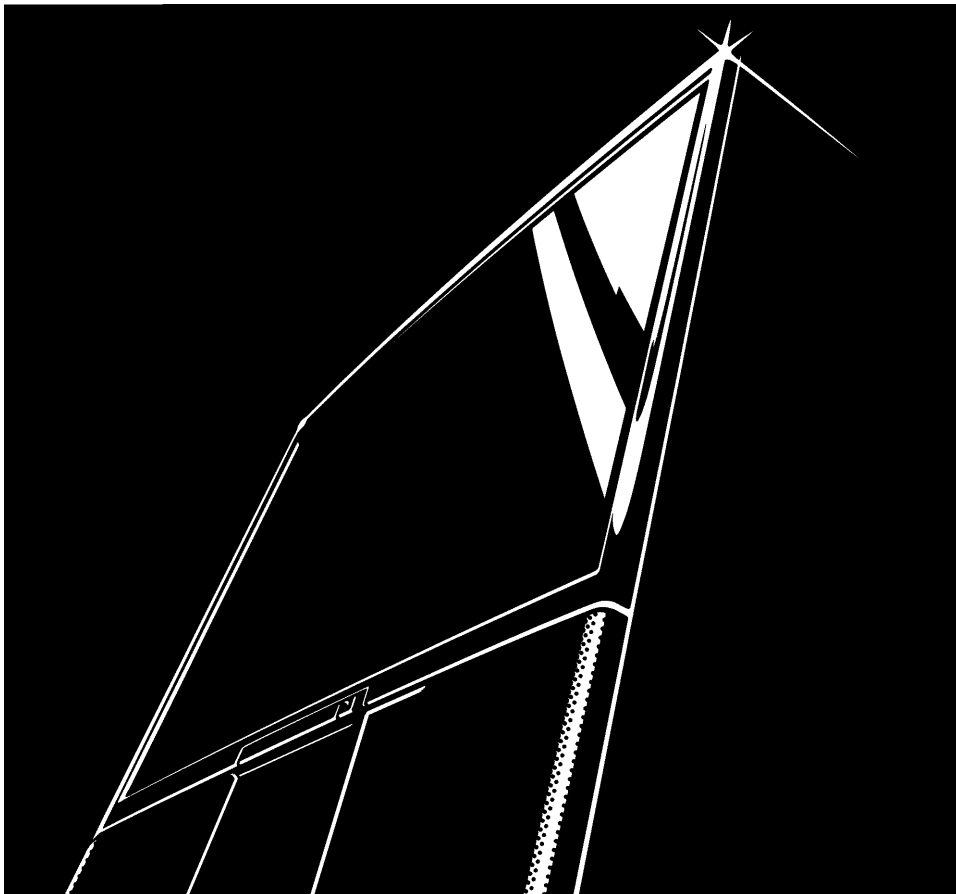

Dear Customer

Welcome to the high quality picture world created by the TOSHIBA Projection Color Television.

This manual will help you use the TV's many exciting and useful features.

Before operating the TV, please read all the safety and operating instructions in this manual thoroughly, and keep the manual for future reference.

Customer's Record

You will find the model number and serial number on the back of the TV.

Record these numbers in the spaces provided below.

Refer to them whenever you call upon your TOSHIBA dealer regarding this product.

Model Number _____

Serial Number _____

Safety Precautions

WARNING:

TO REDUCE THE RISK OF FIRE OR ELECTRIC SHOCK, DO NOT EXPOSE THIS APPLIANCE TO RAIN OR MOISTURE.

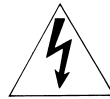
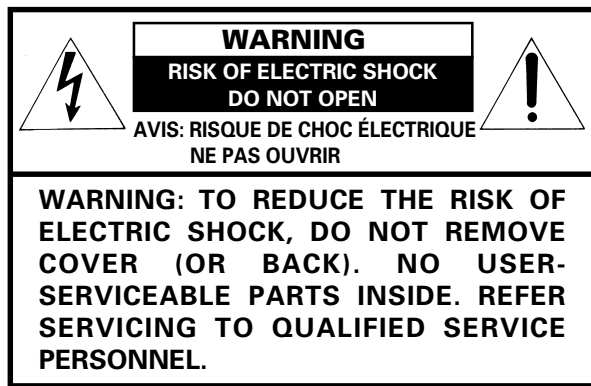

The lightning symbol in the triangle tells you that the voltage inside this product may be strong enough to cause an electric shock. **DO NOT TRY TO SERVICE THIS PRODUCT YOURSELF.**



The exclamation point in the triangle tells you that important operating and maintenance instructions follow this symbol.

CAUTION:

As a safety feature, the AC plug has one prong wider than the other.

It will fit only one way into a standard electrical outlet.

If the plug will not fit into the outlet, try turning it around.

If the plug will not fit either way, the outlet is probably old and non-standard. You will need to have a new outlet installed by an electrician.

DO NOT CHANGE THE SAFETY FEATURE OF THE PLUG.

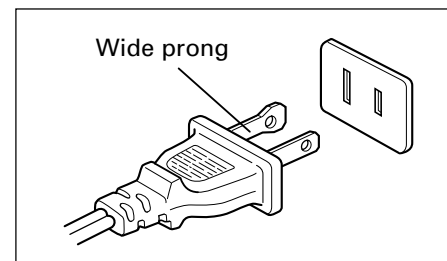

CAUTION:

TO PREVENT ELECTRIC SHOCK, DO NOT USE THIS POLARIZED PLUG WITH AN EXTENSION CORD RECEPTACLE OR OTHER OUTLET UNLESS THE PRONGS CAN BE FULLY INSERTED INTO THE OUTLET TO PREVENT ANY EXPOSURE OF THE PRONGS OF THE POLARIZED PLUG.

NOTE TO CATV SYSTEM INSTALLERS IN THE USA:

This reminder is provided to call the CATV system installer's attention to Article 820-40 of the NEC that provides guidelines for proper grounding and, in particular, specifies that the cable ground shall be connected to the grounding system of the building, as close to the point of cable entry as practical.

Table of Contents

CHAPTER 1 INTRODUCTION

Care and Cleaning	4
Installation	5
To install the TV	5
Antenna/Cable TV Connections	6
To connect a home antenna	7
To connect a Cable TV	8
To connect an Antenna/Cable TV and VCR	9
Location of Controls	11
TV front	11
Remote Control	12
Before Using the Remote Control	13
Introduction and battery installation	13
Using the Remote with VCR or	
Cable TV Converter	14
VCR and CABLE function buttons	14
Programming the Remote Control	15
To program the Remote Control	15
Quick Reference Menu Guide	18
Menus and functions	18

CHAPTER 2 GETTING STARTED

Turning the TV On/Off	20
To turn the TV on/off	20
Selecting the Antenna Input	21
To select the antenna input	21
Programming Channel Memory	22
TV/CABLE and CH PROGRAM functions	22
ADD/ERASE function	23
Aligning the colors	24
To align the colors	24

CHAPTER 3 BASIC OPERATION

Watching TV Programs	26
To watch a TV program	26
Convenient Remote Functions	27
To use On-screen displays/Sound muting/ Channel return	27
Controlling the Picture	28
To adjust the picture	28
Controlling the Sound	30
To adjust the sound	30
Selecting Stereo and SAP Broadcasts	31
To listen to Stereo/SAP broadcasts	31

CHAPTER 4 ADVANCED OPERATION

Enhancing the Surround Sound Effect	32
To activate the Surround sound function	32
Operating the Sub-Bass System	33
To operate the Sub-Bass System	33
Setting the OFF Timer and the Clock	34
To set the OFF timer	34
To set the clock	35
Watching Picture-in-Picture	36
To display a small picture	36
To use advanced functions	37
Multi-Window Function	38
To use the PREVIEW/FAVORITE/STROBE functions	38
Locking Channels	40
To lock out channels	40
Labeling Channels	42
To program channel labels	42
Programming Your Favorite Channels	44
To program your favorite channels	44
Flesh Tone/Noise Reduction	46
To activate the Flesh Tone and Noise Reduction Functions	46
Displaying XDS Information	47
To display XDS information	47
Operating the Closed Captioning Feature	48
To display Closed Captioning	48
To display text information	49
Changing the On-screen Display Language	50
To select a language for the on-screen displays	50

CHAPTER 5 CONNECTING OTHER EQUIPMENT

Connecting External Equipment	51
To connect video/audio equipment	51
Monitor panel	52
To connect a standard VCR	53
To connect a VCR with an S-video jack	54
To dub/edit video tapes using two VCRs	55
To connect a DVD video player	56
To connect a video camera	57
To connect an audio amplifier	58
To connect an A/V receiver	59

CHAPTER 6 ADDITIONAL REFERENCE

Specifications	60
Before Calling Service Personnel	61
Limited United States Warranty	62

Care and Cleaning



Care

Do not stand or climb on the TV.

- The TV is dangerous if broken or if it has fallen over.
- Be careful when children are present.



Do not remove the back cover and never remodel the cabinet or components.

- Let only qualified technicians check and adjust your TV.

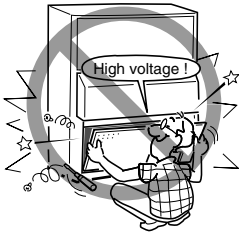

Do not place containers with liquids such as drinks or cosmetics on the TV.

If any foreign material or water leaks into the TV, unplug the AC cord and contact your dealer.

Keep magnets, toys with magnets, electric clocks, speakers, etc. away from the TV.

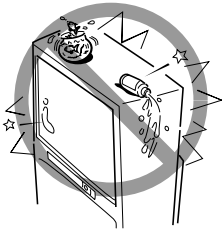

Cleaning

Do not use solvents such as benzine or thinner to clean the TV.

- These solvents may distort the cabinet or damage its finish.
- If rubber or vinyl products remain in contact with the TV for a long time, a stain may result.

When the cabinet becomes dirty, clean it with a soft, dry cloth.

When the cabinet is very dirty,

- ① Use a damp cloth to wipe the cabinet clean.
- ② Finish with a dry cloth.



When cleaning the screen:

- ① Turn off the TV.
- ② Clean the screen with a soft, dry cloth.

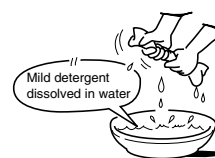
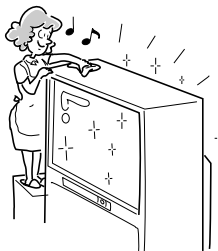
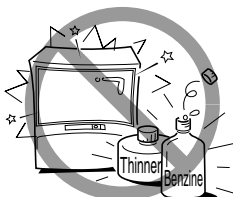

Installation

To install the TV

Downward spot lights or fluorescent lights in an overhead "Honeycomb" prevent direct illumination of the screen.

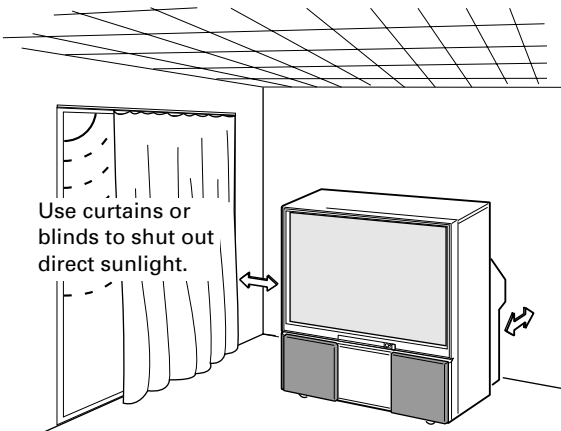

Use curtains or blinds to shut out direct sunlight.

Cover shiny surfaces (floor and walls) with non-reflective materials (carpet, rugs, wallpaper, etc.).

Where to install

Place the TV on the floor or on a sturdy platform. The mounting surface should be flat and steady. If you install the TV on a soft floor, make sure that the floor is not damaged by the weight of the TV.

Air Circulation

Place the TV far enough away from the walls to allow proper ventilation. This will prevent the TV from overheating and avoid possible damage to the TV. Avoid dusty places too.

Heat Damage

Damage may occur if you leave the TV in direct sunlight or near a heater. Avoid places subject to extremely high temperatures or humidity, and temperatures of 41°F (5°C) or lower.

Power Supply

Plug the TV into an electrical outlet with standard household power (120 volt AC, 60 Hz). Do not change the plug's safety prong.

See page 2.

Moisture Condensation

If the room temperature suddenly rises (or if the TV is moved from a cool place to a hot place), condensation may occur on the lenses resulting in picture distortion or color fading. In such a case, simply wait a while (with the power on) and the condensation will evaporate.

Best Viewing

Sit approximately 10-25 feet away from the TV. Sitting too far to the left or right of the screen will cause the picture to appear dull as will direct sunlight and room lights. Turn the TV off to check for reflections on the screen. Then remove the source of any reflections while viewing.

VERTICAL VIEWING ANGLE [SIDE VIEW]

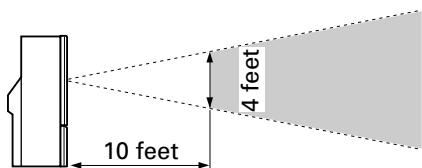

■ Viewing Range

HORIZONTAL VIEWING ANGLE [TOP VIEW]

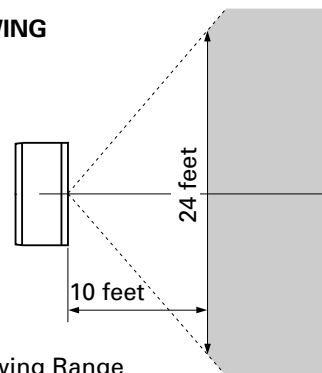

■ Viewing Range

Antenna/Cable TV Connections

- You can use either an indoor or outdoor antenna to receive VHF and UHF channels.
- Channels 2-13 are VHF channels, and channels 14-69 are UHF channels.
- We recommend using an outdoor antenna for better picture quality.
- You can receive Cable TV by connecting the cable supplied by your local cable company.

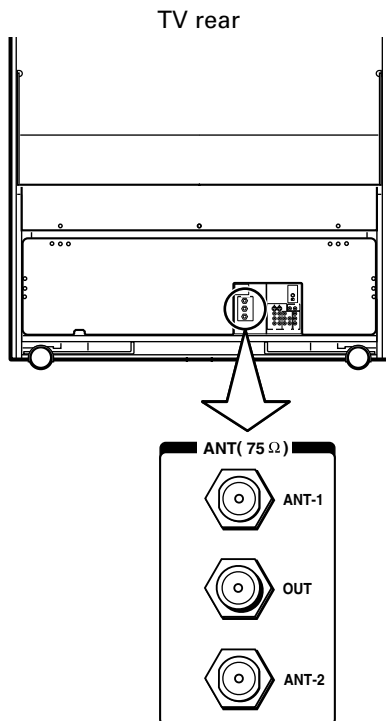

Types of antenna cables

Shown below are two basic types of antenna cables. Signals from a home antenna may be conveyed by either type. Cable TV signals are conveyed by a 75 ohm coaxial cable.

- ① A 75 ohm coaxial cable is generally a round cable with F-type connectors that can easily be attached to a terminal without tools.

F-type connector (Not supplied)



- ② A 300 ohm cable is a flat "twin-lead" cable that can be attached to a terminal using the supplied antenna adapter.

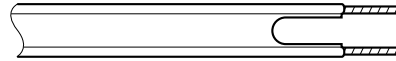

Antenna connection panel

There are two separate 75 ohm F-type connector input terminals and a converter output terminal as shown at the left. The ANT-1 and ANT-2 terminals are for connecting a VHF/UHF antenna or cable TV system. The signal input through ANT-1 is output from the OUT terminal whenever the RF switch on the TV is in the ANT-2 position. You can switch between the ANT-1 and ANT-2 inputs in the ANT 1/2 menu or with the **ANT/VIDEO** button on the TV. See page 21.

To connect a home antenna

Single antenna cable

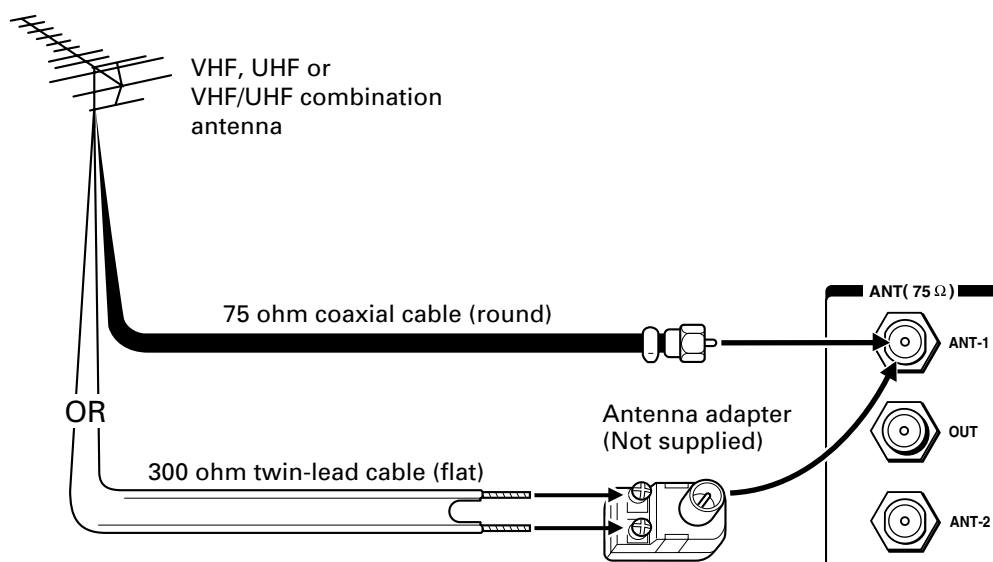

Note:

You can connect another signal source such as a cable TV system or video game to the ANT-2 terminal.

Separate VHF and UHF antenna cables

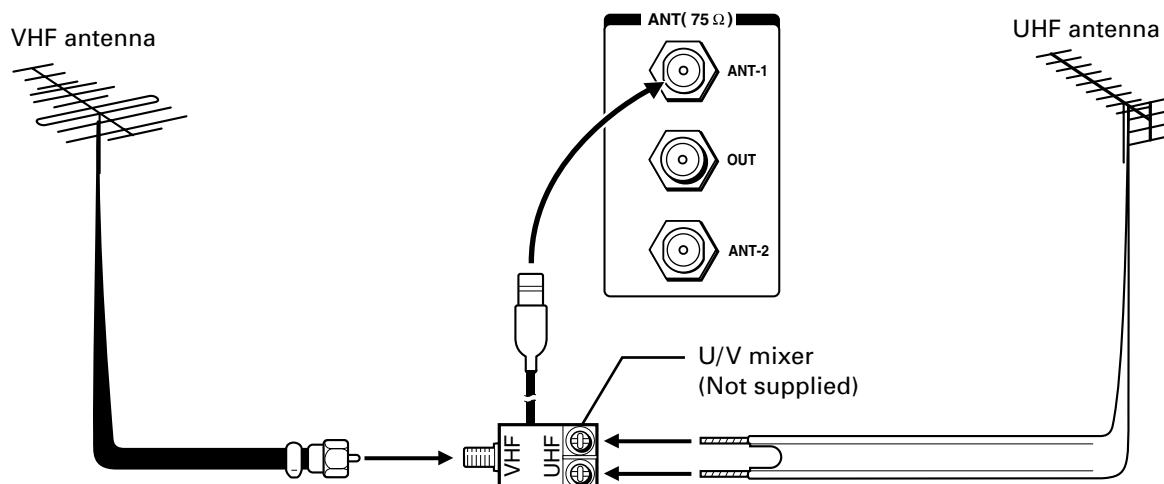

Note:

You can connect another signal source such as a cable TV system or video game to the ANT-2 terminal.

Antenna/Cable TV Connections (continued)

To connect a Cable TV

Generally, the cable TV system can be connected directly to the TV's antenna terminal just like a home antenna. **(A-1)**

Some cable companies, however, offer premium pay channels. Since premium pay channel signals are scrambled, a cable TV converter/decoder is generally provided to subscribers by the cable TV company. This decoder box is necessary for normal viewing of the scrambled channels. We recommend that you consult your cable TV company for more specific instructions on installing cable TV. **(A-2)**

(A-1) Cable without a decoder box (Unscrambled channels)



Note:

You can connect another signal source such as an antenna or video game to the ANT-2 terminal.

(A-2) Cable with a decoder box (Scrambled and Unscrambled channels)

- The unscrambled channels are input through the ANT-1 terminal whenever the ANT1/2 menu, or the **ANT/VIDEO** button on the TV, is in "ANT 1" mode. See page 21.
- The scrambled channels from the decoding device are input through the ANT-2 terminal whenever the ANT 1/2 menu, or the **ANT/VIDEO** button, is in "ANT 2" mode. Set the TV to channel 3 or 4 to match the output channel of the decoding device.

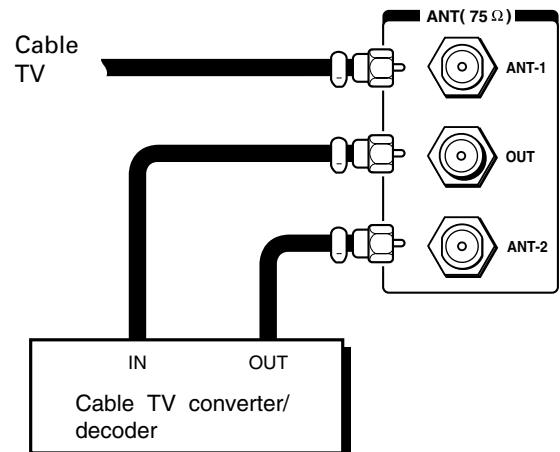

Note:

The decoding device may or may not be a part of the cable converter.

To connect an Antenna/Cable TV and VCR

Antenna/Cable TV connection via VCR (Simplified method)

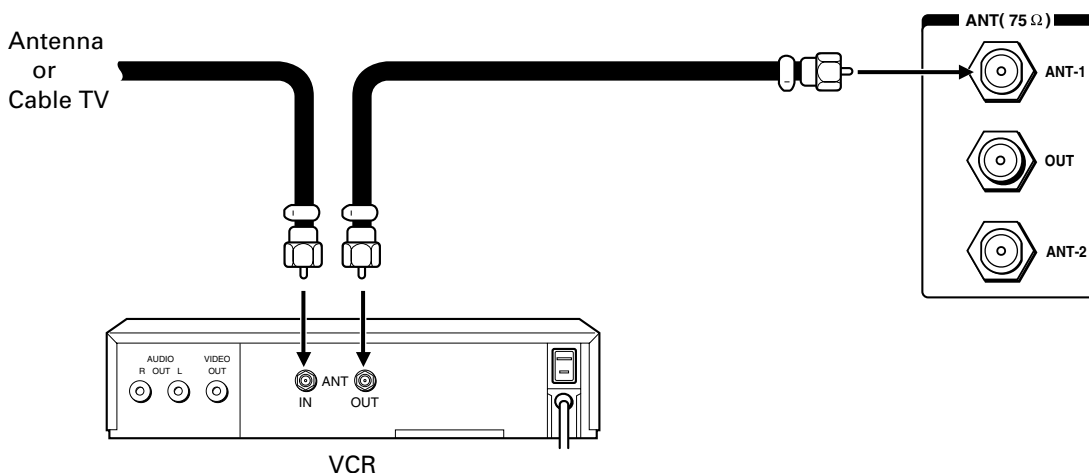

Notes:

- Tape playback may often cause the VCR to interrupt the antenna signal to the TV. If you cannot select a certain channel, try pressing the TV/VCR button on the Remote Control.
- VIDEO/AUDIO connections from the VCR to the TV are required for stereo tape playback from stereo VCRs. See page 51.

Using a 2-way signal splitter

You can view either TV programs or VCR tapes regardless of the position of the VCR's TV/VCR switch.

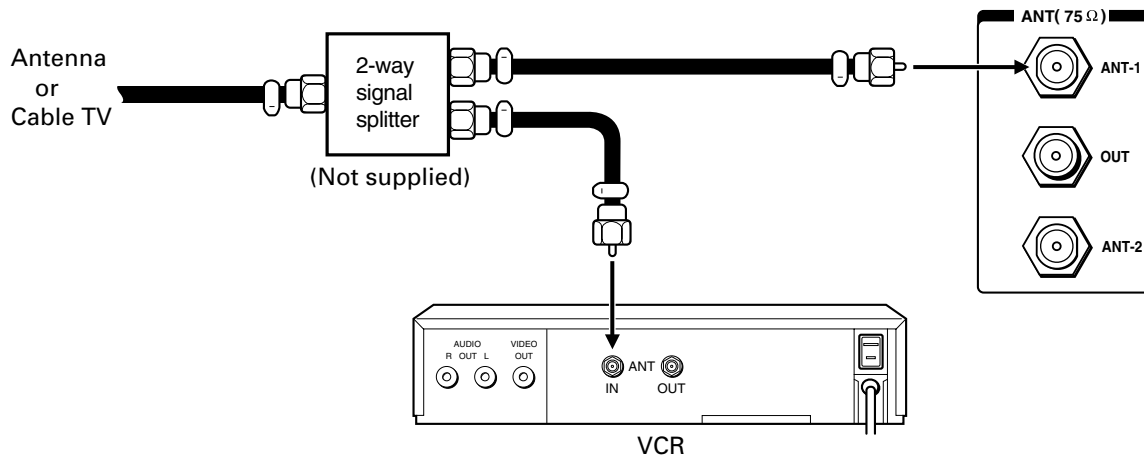

Note:

VIDEO/AUDIO connections from the VCR to the TV are required for playback. See page 51.

Antenna/Cable TV Connections (continued)

To connect an Antenna/Cable TV and VCR (continued)

Cable with a decoder box

- The unscrambled channels are input through the ANT 1 terminal whenever the ANT1/2 menu , or the **ANT/VIDEO** button on the TV, is in the "ANT 1" position. See page 21.
- The scrambled channels from the decoder box are input through the VCR and the ANT 2 terminal whenever the ANT1/2 menu, or the **ANT/VIDEO** button, is in the "ANT 2" position. Set the TV and the VCR to channel 3 or 4 to match the output channel of the decoding device.

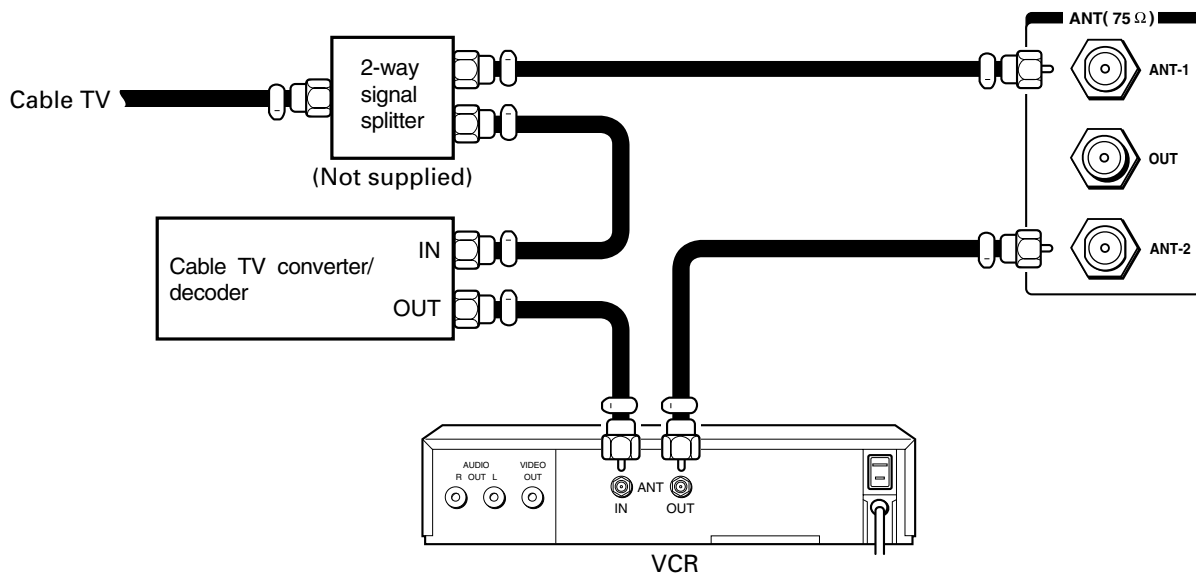

Notes:

- VIDEO/AUDIO connections from the VCR to the TV are required for stereo tape playback from stereo VCRs. See page 51.
- The decoding device may or may not be a part of the cable converter.

Location of Controls

- The following describes the functions of each part of the TV and the Remote Control. For details on the use of each control, refer to the page numbers in brackets.

TV front

Illustrations represent TP55H60.

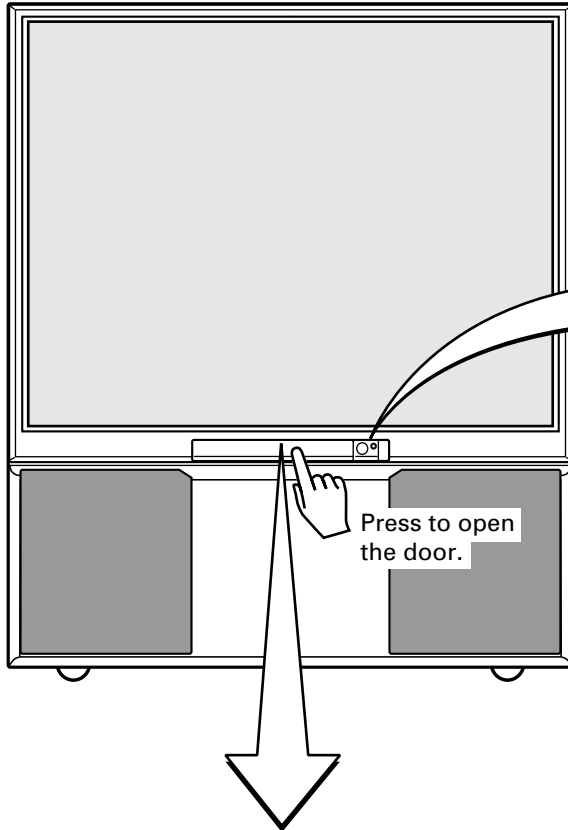

Behind the door

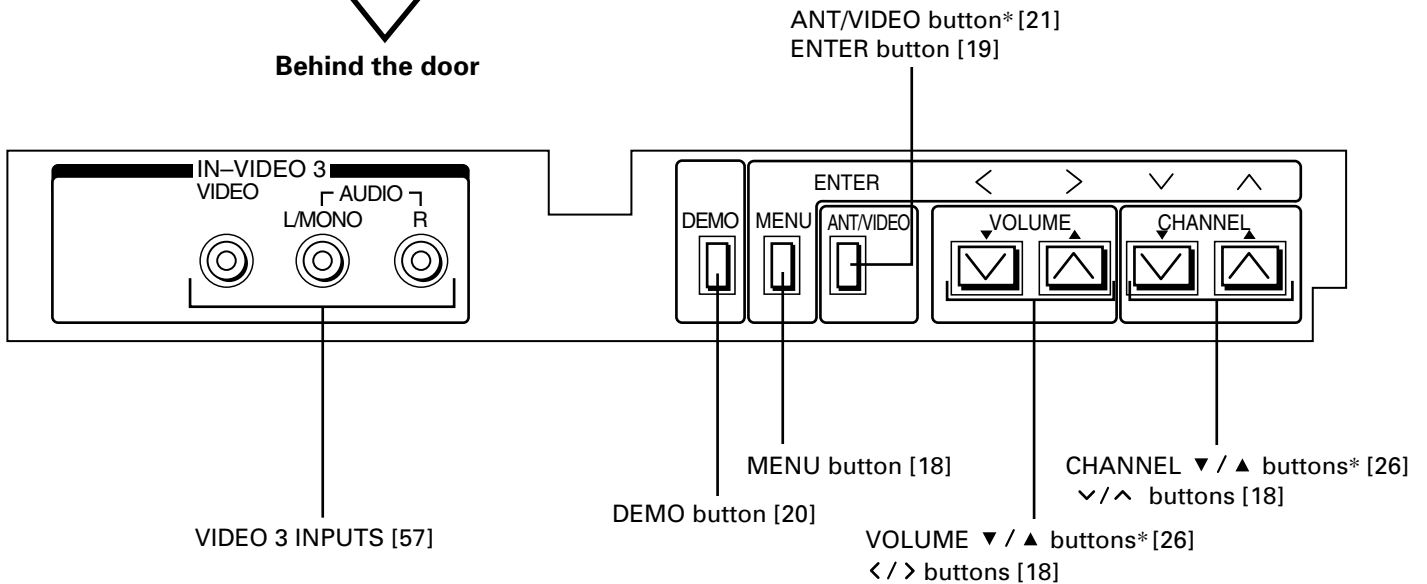
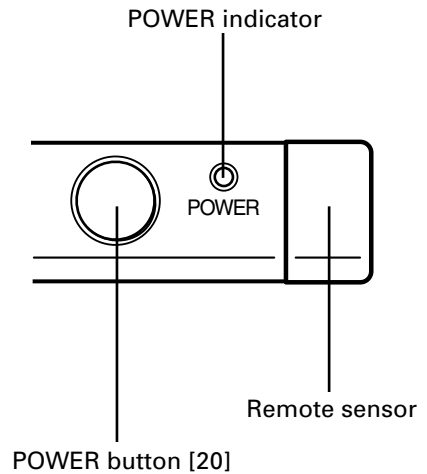

* Dual function buttons

Location of Controls (continued)

Remote Control

Only the buttons used to operate the TV are described here.
For details on the use of each control, refer to the pages in brackets.

Aim at the remote sensor on the TV

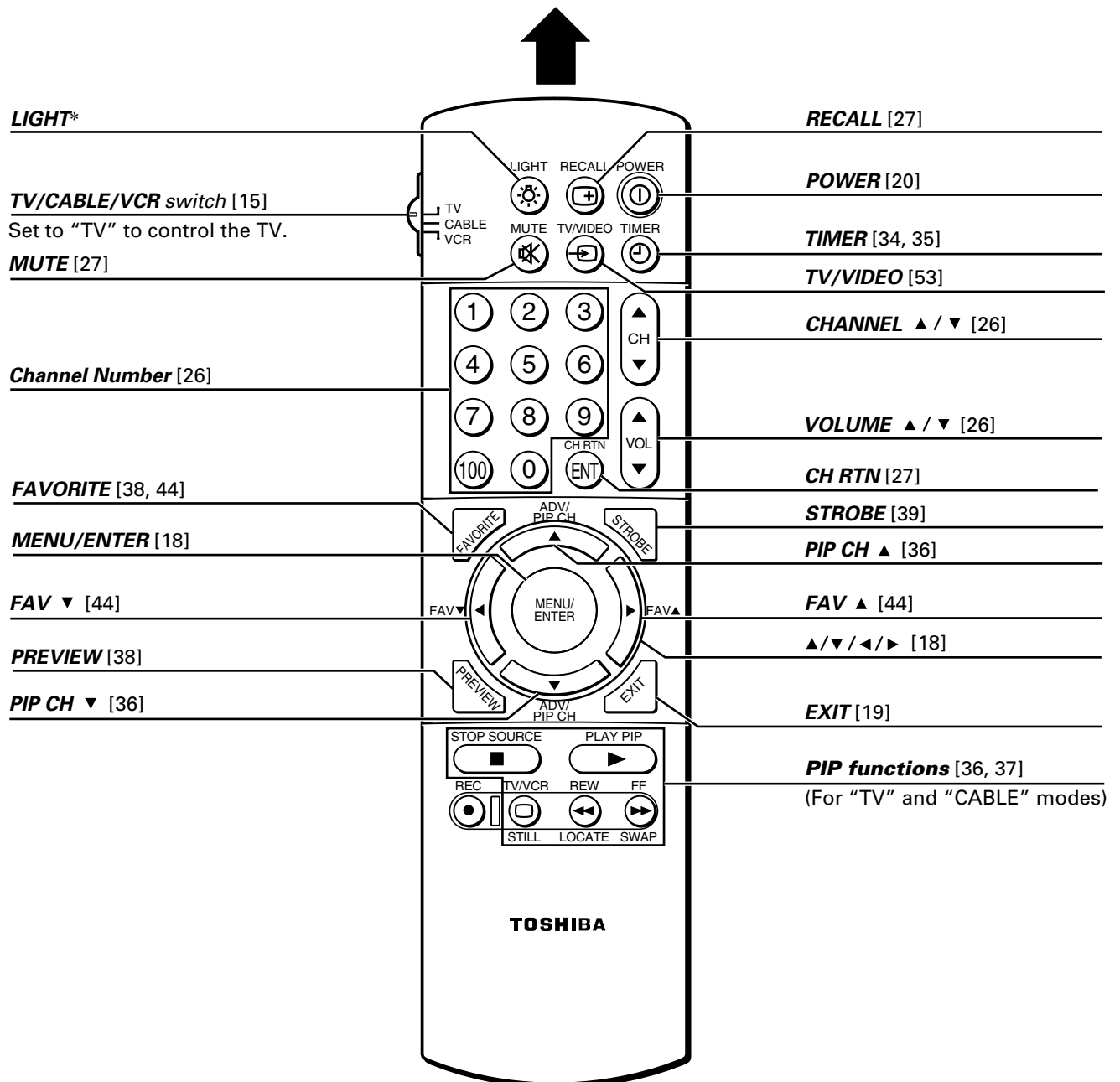

* You can light up these buttons by pushing **LIGHT**.

Before Using the Remote Control

Introduction and battery installation

With this Remote Control, you can operate your TV and most VCR and cable box models regardless of the manufacturer. However, this Remote Control must first be programmed to control other VCR and cable box brands. See page 15.

If you have a TOSHIBA VCR, your Remote Control has already been programmed for you.

Before attempting to operate your Remote Control, install the batteries according to "To install the batteries" below.

Notes:

- After installing new batteries, the Remote Control will set itself to the codes for TOSHIBA TVs and VCRs. If you are using the Remote Control to operate other manufacturer's equipment, you will have to reprogram those codes.
- This Remote Control may have functions not available on your VCR and cable box remote controllers. These functions may or may not operate your VCR or cable box. Refer to the owner's manuals supplied with the equipment to see which functions are available.
- The remote controller supplied with your VCR or cable box may have keys not duplicated on this Remote Control. If you want to use these functions, please use the original remote controller.

To install the batteries

- 1 Place the Remote Control face down and remove the battery cover.

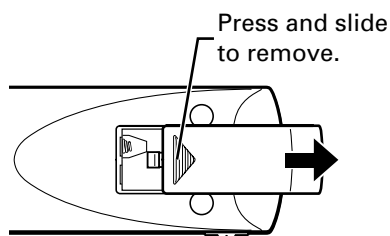

- 2 Insert two "AA" size alkaline batteries, matching the + and - signs on each battery with the + and - signs in the battery compartment.

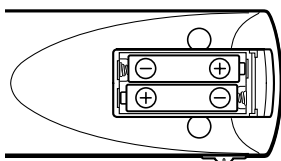

- 3 Slide the battery cover shut until the lock clicks.

CAUTIONS

- Do not throw your batteries into a fire. Dispose of your batteries in a designated disposal area.
- Do not combine used batteries with new ones.
- Do not mix battery types.

Tips for best operation

- For optimum performance, aim the Remote Control directly at the TV from a distance within 16 feet (5 m), and be sure there is no obstruction between the Remote Control and the TV.
- If your Remote Control does not always operate the TV as you wish, you probably need to replace the batteries. Use alkaline batteries for longer use.
- If the Remote Control will not be used for a long period of time or when the batteries are worn out, remove the batteries to prevent leakage.
- Do not drop, dampen or disassemble the Remote Control.

Using the Remote with VCR or Cable TV Converter

VCR and CABLE function buttons

- To control a TOSHIBA VCR, first set the TV/CABLE/VCR switch to "VCR." The buttons shown below will then control the VCR. The rest of the buttons operate the TV as usual.
If you have another brand of VCR, you can probably program the Remote Control to control it. Details are on page 15.
- To control a cable TV converter, this Remote Control must be programmed to recognize the brand of your converter. See page 15. The shaded buttons can be used to control the cable TV converter.
Set the TV/CABLE/VCR switch to "CABLE" whenever you want to control the cable TV converter.

Aim at the VCR or cable TV converter

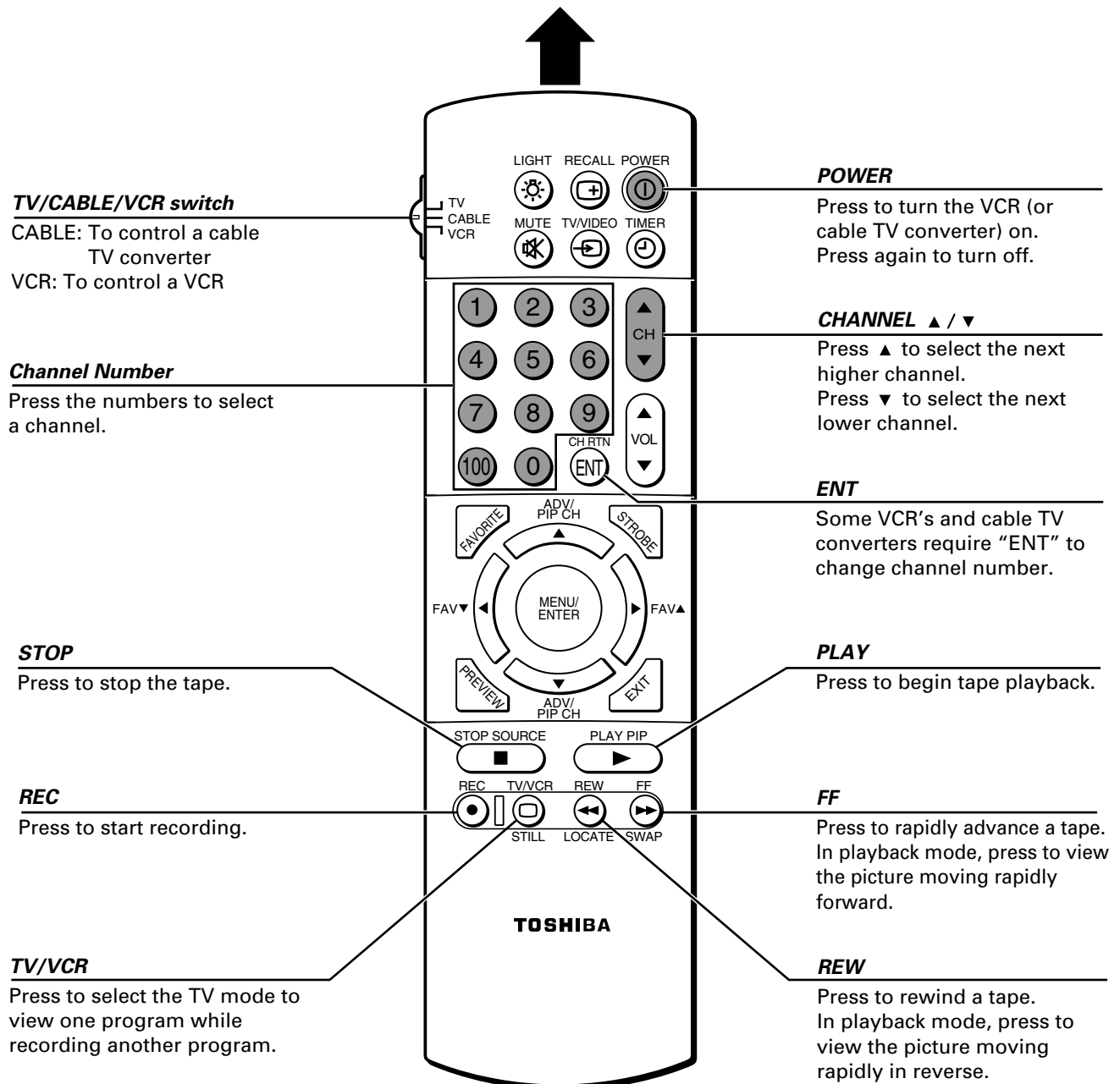

Programming the Remote Control

To program the Remote Control

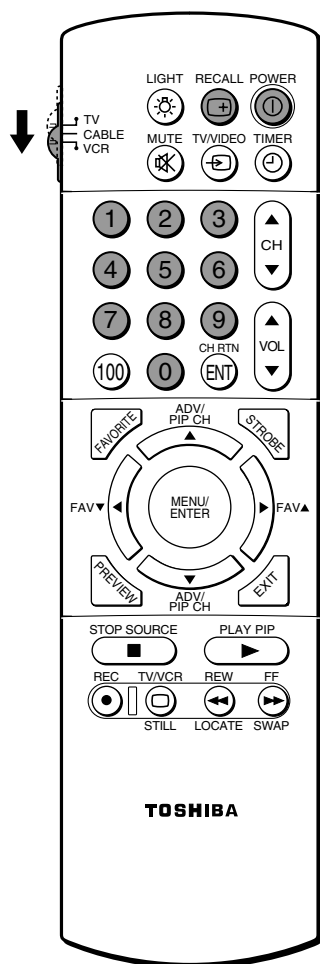

- This Remote Control is programmed to operate TOSHIBA VCRs.
- To operate VCRs (or Cable converters) other than TOSHIBA models, perform the following procedures before operating.

1 Refer to the “*VCR code table*” (or “*Cable TV converter code table*”) on pages 16 and 17 to find the code number that corresponds to the brand name of your VCR (or your converter).

If more than one number is listed, try each one separately until you find the one that works.

2 Set the TV/CABLE/VCR switch to “VCR” (or “CABLE”).

3 While holding down **RECALL**, press the **Number** buttons to enter the three digit code number for your brand of VCR (or converter).

4 Point the Remote Control at the VCR (or at the converter) and press **POWER** to test the code number.

—If the number is correct, the VCR should turn on.

—If the VCR does not respond to the Remote Control, repeat steps 1 through 4 with another code number.

5 Reset the TV/CABLE/VCR switch to “TV” to control the TV.

Notes:

- Some newer VCRs are capable of working on either of two remote codes. These VCRs have a switch labeled “VCR 1/VCR 2.” If your VCR has this kind of switch, and does not respond to any of the code numbers for your VCR brand name, set the switch to the other position (“VCR 1” or “VCR 2”) and reprogram the Remote Control.
- In some rare cases, you may not be able to operate your non-TOSHIBA equipment with the supplied Remote Control. This is because your equipment may use a code that is not provided with this Remote Control. In this case, please use the equipment’s own remote control.

For future reference, write the code number you set.

VCR CODE: _____

CABLE CODE: _____

Note:

You have to reprogram the Remote Control when you change its batteries.

Programming the Remote Control (continued)

- The code numbers listed below were the most recent ones available at the time of printing. New code numbers may or may not have been added since printing.

VCR code table

BRAND NAME	CODE NUMBER	BRAND NAME	CODE NUMBER	BRAND NAME	CODE NUMBER
Adventura	019	Fisher	065, 066, 073, 085,	MGN Technology	259
Aiko	297	123	Minolta	061, 124
Aiwa	019	Frontech	039	Mitsubishi	062, 080, 086, 094,
Akai	060, 068, 080, 125,	Fuji	052, 054	100, 192, 233, 261
.....	261	Fnai	019	Motorola	054, 067
Akiba	091	Garrard	019	MTC	019, 259
Alba	039, 228, 297, 314	GE	054, 079, 084, 221	Multitech	019, 091
American High	054	GEC	100	Murphy	019
Amstrad	019	General	071	NEC	057, 059, 060, 069,
Anam	181	Go Video	251, 298	086
Anitech	091	Goldstar	037, 056, 057	Neckermann	100
ASA	056, 100	Goodmans	019, 039, 056, 081,	Nesco	091
Asha	259	091, 297	Nikko	056
Asuka	056	Gradiente	019	Noblex	259
Audiovox	056	Graetz	060, 123	Nokia	060, 065, 123, 125,
Baird	019, 123	Granada	065, 100, 123	259
Basic Line	039, 091, 297	Grandin	019, 056, 091	Nordmende	060
Beaumarck	259	Grundig	100	Oceanic	019
Bell & Howell	123	Harley Davidson	019	Olympus	054
Blaupunkt	053, 181	Harman/Kardon	057, 094	Optimus	056, 067
Brandt	206	Harwood	087, 091	Optonica	067, 081
Broksonic	140, 203, 230, 380	HCM	091	Orion	140, 227, 228, 314
Bush	091, 228, 297	Headquarter	065	Osaki	019, 056, 091
Calix	056	HI-Q	066	Otto Versand	100
Canon	054	Hinari	091, 227	Palladium	056, 091
Capehart	039	Hitachi	019, 060, 061, 084,	Panasonic	054, 096, 115, 181,
Carver	100	124, 254	244
CCE	091, 297	Hypson	091	Penney	054, 056, 057, 059,
CGE	019	Imperial	019	061, 073, 259
Cimline	091	Interfunk	100	Pentax	061, 084, 124
Citizen	056, 297	ITT	060, 065, 123, 125	Perdio	019
Clatronic	039	ITV	056, 297	Philco	054
Colt	091	JCL	054	Philips	054, 081, 100, 129
Condor	039	Jensen	060	Phonola	100
Craig	056, 066, 091, 259	JVC	027, 060, 086	Pilot	056
Crown	091, 297	Kaisui	091	Pioneer	086, 100
Curtis Mathes	054, 079	Kendo	125, 228	Portland	039
Cybernex	259	Kenwood	057, 060, 065, 086	Profitronic	259
Daewoo	039, 064, 065, 297	KLH	091	Proline	019
Dansai	091	Kodak	054, 056	protec	091
Daytron	039	Korpel	091	Pulsar	058
De Graff	061	Leyco	091	Pye	100
Decca	019, 100	Lloyd	019	Quarter	065
Dual	060	Loewe	056	Quartz	065
Dumont	019, 100, 123, 124	Loewe opta	100	Quasar	054, 096, 115
Dynatech	019	logik	091, 259	Quelle	100
Elcotech	091	Luxor	062, 065, 123, 125	Radio Shack	019, 056
Electrohome	056	LXI	056	Radiola	100
Electronic	019	M-Electronic	019	Radix	056
Electroponic	056	Magnavox	019, 054, 058, 100,	Randex	056
Emerex	051	129, 168	RCA	054, 061, 079, 084,
Emerson	019, 021, 056, 062,	Magnin	259	096, 115, 124, 125,
.....	080, 087, 140, 203,	Manesth	064, 091	168, 221
.....	227, 228, 230, 231,	Narantz	054, 057, 081, 100	RCA Unified	079
.....	313, 314, 380	Marta	056	Realistic	019, 054, 056, 065,
ESC	297	Masushita	054	066, 067, 081, 085,
Ferguson	060	Matsui	227, 228, 314	123, 259
Fidelity	019	MEI	054	Rex	060
Finlandia	100, 123, 129	Memorex	019, 054, 056, 058,	Ricoh	053
Finlux	019, 061, 100, 123,	065, 066, 067, 123,	Roadstar	056, 091, 259, 297
.....	124	259	Runco	058
Firstline	056, 062, 064, 091,	Memphis	091	Saba	060
.....	228	Metz	181	Saisho	227, 228
		MGA	062, 080	Salora	062, 065, 125

Cable TV converter code table**BRAND NAME CODE NUMBER**

Samsung	064, 259
Sanky	058, 067
Sansui	060, 086
Sanyo	065, 066, 123, 259
SBR	100
Schaub Lorenz	019, 060
Schneider	019, 091, 100, 129
Scott	062, 064, 140, 203,
	229, 230, 231
Sears	054, 056, 061, 065,
	066, 073, 085, 123,
	124
SEG	259
SEI	100
Seleco	060
Sentra	039
Sharp	067, 081
Shintom	091
Shgun	259
Siemens	056, 123
Silva	056
Singer	091
Sindyne	100
Sontec	056
Sony	051, 052, 053, 054
STS	061
Sunstar	019
Sylvania	019, 054, 062, 100,
	129
Symphonic	019
Tandy	019, 123
Tashiko	019
Tatung	019, 060, 100
Teac	019, 060
Technics	054, 181
Teknika	019, 054, 056, 071
Teleavia	060
Telefunken	060, 206
Tenosal	091
Tensai	019
Thomson	060
Thorn	060, 123
TMK	227, 259
Toshiba	060, 062, 064, 085,
	229, 231, 385
Totevision	056, 259
Triumph	227
Untech	259
Universum	019, 056, 068, 100,
	125
Vector	064
Vector research	057, 059
Victor	027, 060, 086
Video Concepts	059, 064, 080
Videosonic	259
Wards	019, 054, 061, 066,
	067, 081, 091, 168,
	231, 259
XR-1000	019, 054, 091
Yamaha	057, 060
Yamishi	091
Yokan	091
Yoko	039, 259
Zenith	052, 053, 058

BRAND NAME CODE NUMBER

ABC	020, 022, 026, 030,
	032, 033, 036, 066
Antronix	041
Archer	041, 058, 172
Belcor	075
Cable Star	075
Cabletenna	041
Cableview	041
Century	172
Citizun	172
Color Voice	044, 050
Comtronics	059, 079
Contec	038
Eastern	021
Garrard	172
GC Electronics	035, 075
Gemini	034, 089
General Instrument	030
Hamlin	028, 039, 053, 278,
	292
Hitachi	030
Hytex	026
Jasco	172
Jerrold	022, 030, 031, 033,
	034, 043, 045, 066,
	295
Macom	052
Magnavox	046
Memorex	019
Movie Time	175
NSC	089, 175
Oak	026, 038, 267
Panasonic	040, 126
Paragon	019
Philips	044, 046, 047, 048,
	049, 050, 079, 172
Pioneer	042, 163
Popular Mechanics	419
Pulsar	019
PVP Stereo Visual Matrix	022
RCA	040
Regal	039, 278, 292
Regency	021
Rembrandt	030, 089
Runco	019
Samsung	059, 163
Scientific Atlanta	025, 027, 036, 296,
	346
Signal	034, 059
Signature	030
SL Marx	059
Sprucer	040
Standard Components	174
Starcom	022, 034, 066
Stargate	034, 059
Starquest	034
STS	175
Sylvania	020
Teleview	059
Texcan	020

BRAND NAME CODE NUMBER

Tocom	031, 032, 078
Toshiba	019
Tusa	034
Unika	041, 172
United Artists	026
United Cable	022
Universal	041, 058, 075, 096,
	172, 210
Viewstar	046, 079, 230
Zenith	019

Quick Reference Menu Guide

- We recommend that you familiarize yourself with these procedures for using the Menu function.

Menus and functions

1

Press **MENU** to call up an on-screen menu.

2

Press **◀** or **▶** to select the menu.



3

Press **▲** or **▼** to select an item.

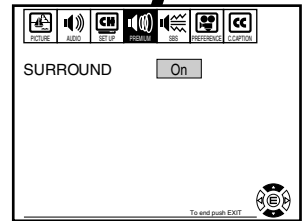
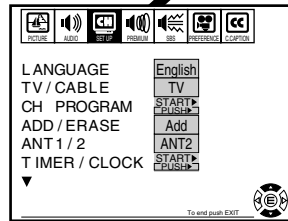
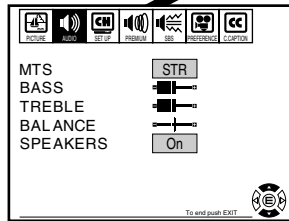
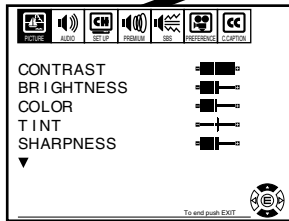

4

Press **◀** or **▶** to select or adjust a setting.

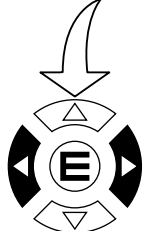
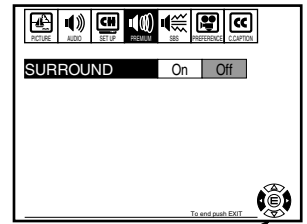
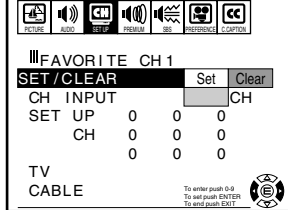
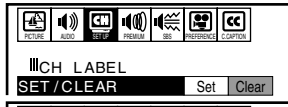
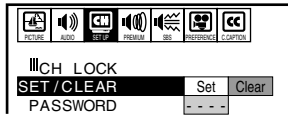
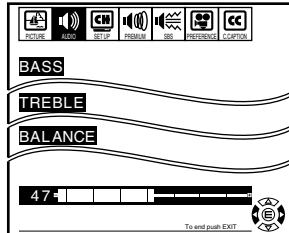
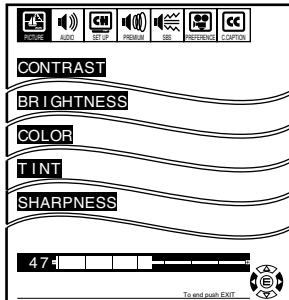
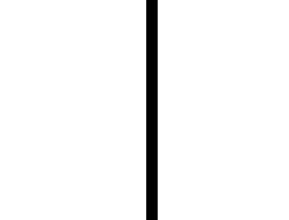
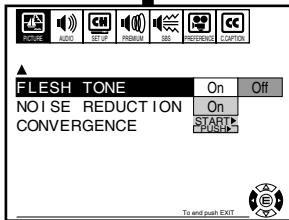

This mark indicates which button you should press next.

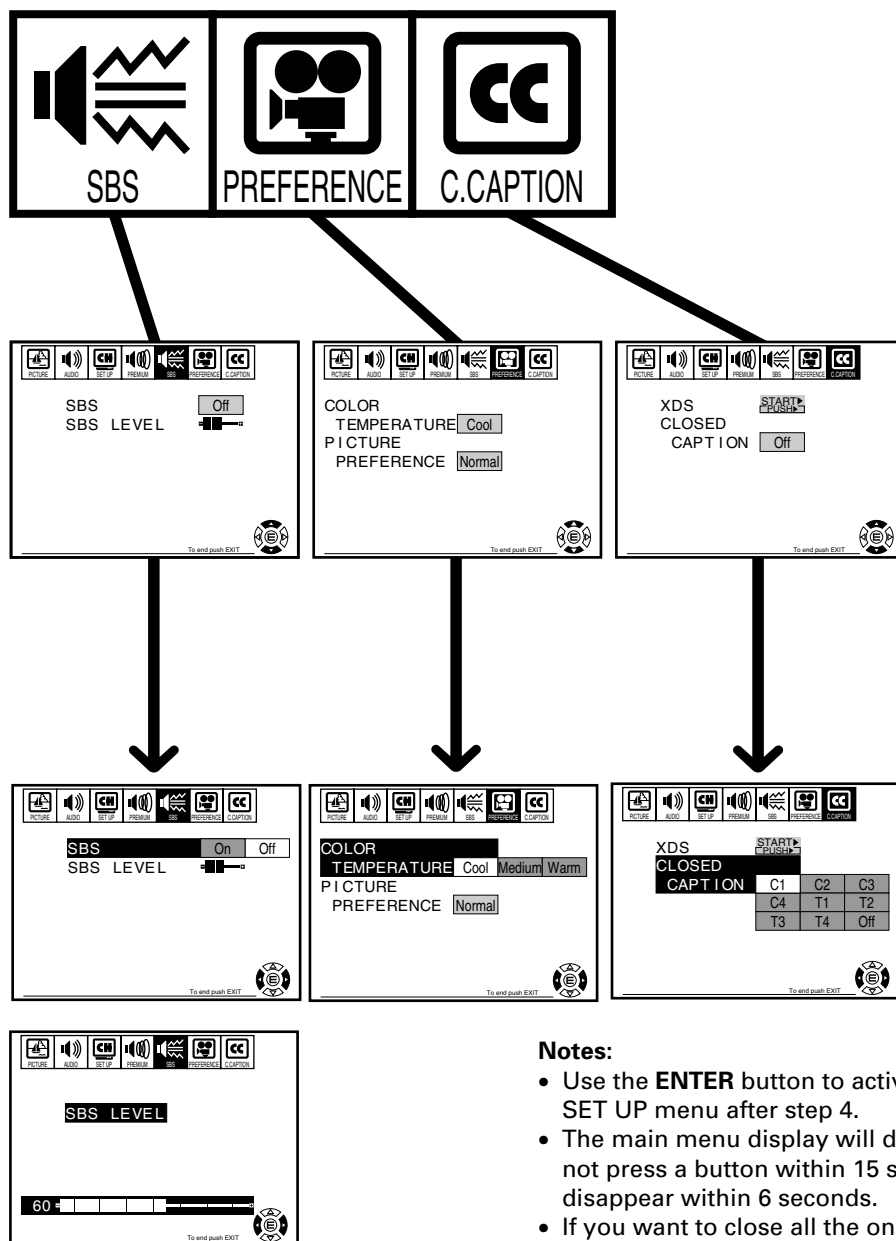

Notes:

- Use the **ENTER** button to activate the function settings in the SET UP menu after step 4.
- The main menu display will disappear automatically if you do not press a button within 15 seconds, and the other displays will disappear within 6 seconds.
- If you want to close all the on-screen displays instantly, press the **EXIT** button on the Remote Control.
- The ∇/\wedge buttons on the TV function as the **CHANNEL** ∇/\wedge buttons when no menu display is on the screen.
- The \langle/\rangle buttons on the TV function as the **VOLUME** ∇/\wedge buttons when no menu display is on the screen.
- The $\blacktriangle/\blacktriangleright$ buttons on the Remote Control function as the **FAV** ∇ and \blacktriangle buttons when no menu display is on the screen.

Turning the TV On/Off

To turn the TV on/off

First set the TV/CABLE/VCR switch on the Remote Control to "TV."

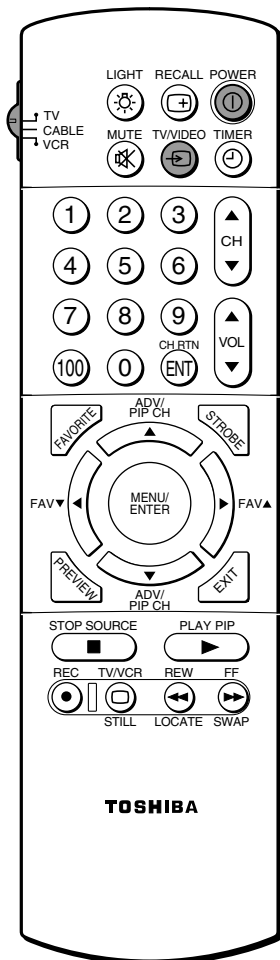
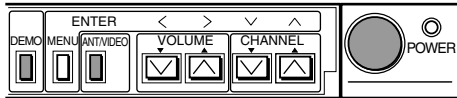

Note:
The **TV/VIDEO** button or **ANT/VIDEO** button is used to input signals from other sources such as VCRs or Laser Disc Players connected to this TV. See page 53 for details.

1 Press **POWER** on the Remote Control or the TV.
The picture will appear in a few seconds.

2 The following on-screen information will be displayed for a few seconds.

- Antenna input (when in TV mode)
- Channel label (if previously preset)
- Channel number or VIDEO mode selected
- STEREO or SAP audio status

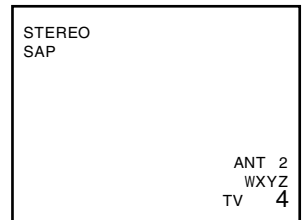

3 To turn the TV off, press **POWER** again.

Auto-Power-Off

If an empty channel is selected, or the TV broadcast for the day is finished, the TV will automatically turn off after about 15 minutes. This **Auto-Power-Off** feature does not operate in the VIDEO mode.

Last Mode Memory

If the power supply is cut off while you are watching the TV, the **Last Mode Memory** feature automatically turns on the TV when the power is restored. If you know the power is going to be cut off, or you are leaving home for a long time, remove the power plug from the wall outlet to prevent the TV from turning on in your absence.

Demonstration mode

When you press **DEMO**, the TV will automatically display a variety of its on-screen menus and special features. This function is provided for demonstration purposes only. Press **DEMO**.

The on-screen demonstration will start after about 4 seconds.

- While in TV or VIDEO mode, the Multi-Window features demonstrate.
- While in "COLOR STREAM" mode, other menus and features demonstrate.

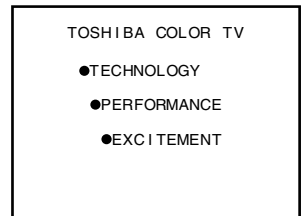

To stop the on-screen demonstration
Press **Exit, Recall on Remote** or **DEMO**.

Selecting the Antenna Input

- Your TV has two separate antenna inputs (ANT 1 and ANT 2) that allow you to connect two different signal sources, if desired.

To select the antenna input

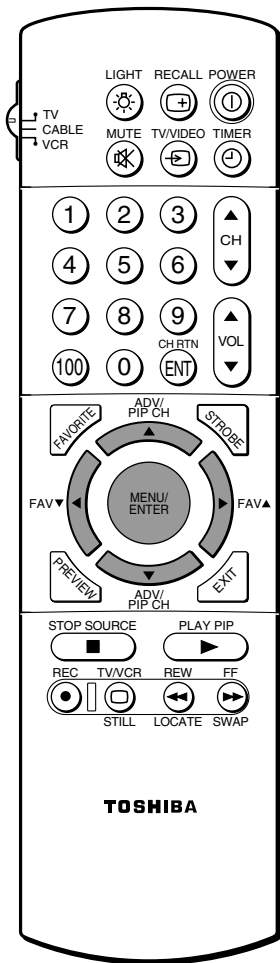
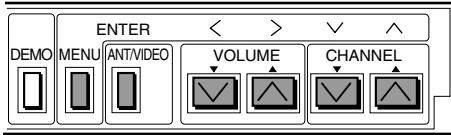

Using the SET UP menu

1 Press **MENU**, then press ◀ or ▶ until the SET UP menu appears.

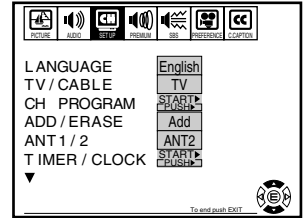

2 Press ▼ (or ▲) until "ANT 1/2" is highlighted.

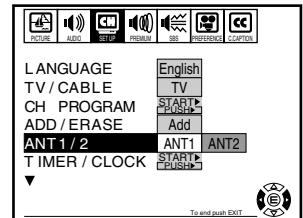

3 Press ◀ or ▶ to select "ANT 1" or "ANT 2."

Using the ANT/VIDEO button (on the TV)

Each time you press this button, the ANT 1, VIDEO 1, VIDEO 2, VIDEO 3, COLOR STREAM or ANT 2 mode will be selected in this order. The selected mode will be displayed in purple to show which signal source you are watching.

Press the button until "ANT 1" or "ANT 2" is displayed in purple to match the antenna terminal you want to use.

VIDEO 1	ANT 1
VIDEO 2	ANT 2
VIDEO 3	COLOR STREAM
TO SELECT PUSH ANT / VIDEO	

Note:

This button functions as the **ENTER** button while the menu is on the screen.

Programming Channel Memory

- The channel memory is a list of TV channel numbers the TV tunes in when you press the **CHANNEL ▲/▼** button. **First, use the TV/CABLE and CH PROGRAM functions to preset all active channels in your area automatically.** If necessary, arrange the preset channels with the ADD/ERASE function so you tune into only the desired channels.

TV/CABLE and CH PROGRAM functions

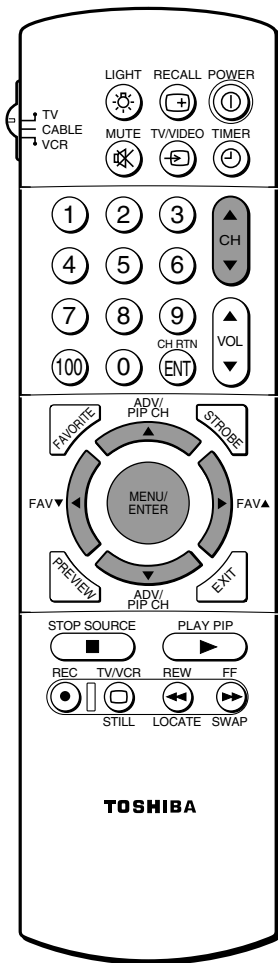
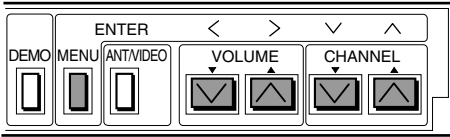

TV/CABLE function

- Press **MENU**, then press **◀** or **▶** until the SET UP menu appears.
- Press **▼** (or **▲**) until "TV/CABLE" is highlighted.
- Press **◀** or **▶** to select "TV" or "Cable" whichever you use.

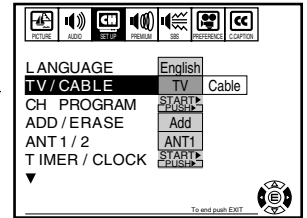
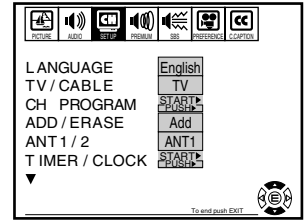

CH PROGRAM function

- Select "CH PROGRAM" following steps 1 and 2 above.
- Press **◀** or **▶** to start channel programming. The TV automatically cycles through all TV or CABLE channels depending on the mode selected, storing received channels in the channel memory.
- When channel programming is complete, the message at the right appears.

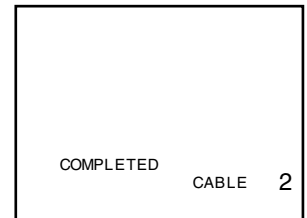
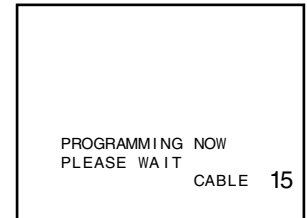
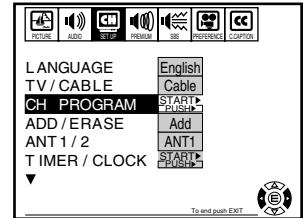

- Press **CHANNEL ▲/▼** to make sure channel programming has been done properly.

ADD/ERASE function

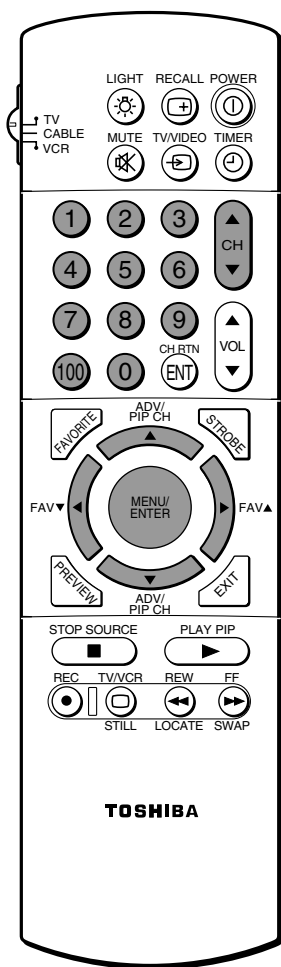
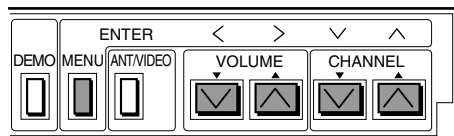

After performing the CH PROGRAM function, you can add or erase specific channels.

- 1 Select the channel to erase using the **CHANNEL** ▲ or ▼ button, or select the channel to add with the **Channel Number** buttons.
See page 26 on how to select channels.

- 2 Press **MENU**, then press ◀ or ▶ until the SET UP menu appears.

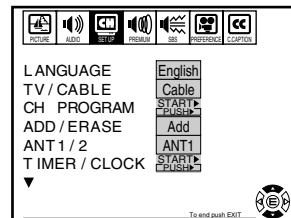

- 3 Press ▼ (or ▲) until "ADD/ERASE" is highlighted.

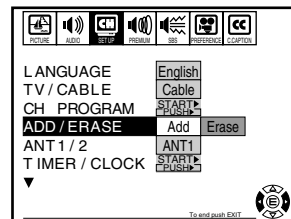

- 4 Press ◀ or ▶.

To erase the channel

Press ◀ or ▶ to select "Erase". The channel will be erased from the memory.

To add the channel

Press ◀ or ▶ to select "Add". The channel will be memorized.

- 5 Repeat steps 1 through 4 for other channels.

Aligning the colors

- This projection TV uses three separate TV tubes: a red one, a green one, and a blue one. The red, green, and blue images are projected onto the screen where they converge to form a full color picture. You can see a clear picture only when they converge correctly.
- Convergence may drift over time or if you move the TV. If you can see clear images on the screen, skip this procedure.

To align the colors

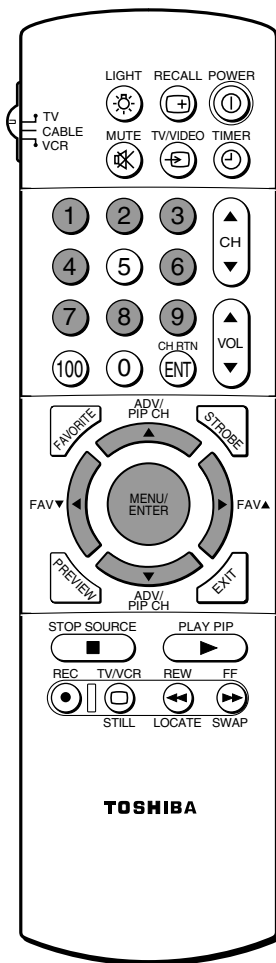
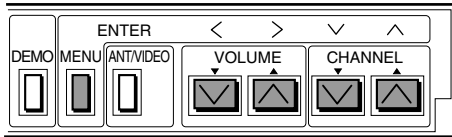

This adjustment should be made after the TV has been on for at least 30 minutes.

To check and align the colors

1 Press **MENU**, then press **◀** or **▶** until the PICTURE menu appears.

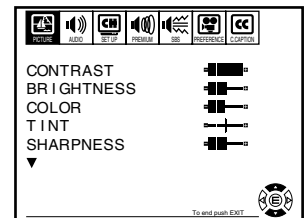

2 Press **▲** (or **▼**) until "CONVERGENCE" is highlighted.

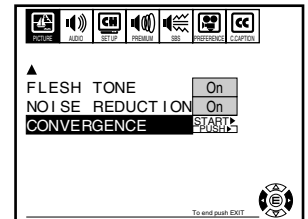

3 Press **◀** or **▶** to display the center CONVERGENCE menu. If alignment is correct, there will be one vertical and one horizontal white line.

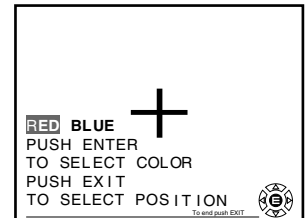

4 If you see separate colored lines, you have to align the colors. Press **ENTER** to select "RED" or "BLUE." The selected color is highlighted.

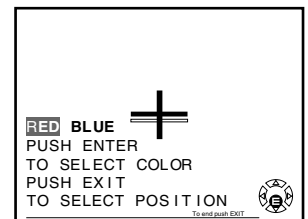

5 Press the "**▲** (up)", "**▼** (down)", "**◀** (left)" or "**▶** (right)" button to converge the red or blue line into the green line. When color convergence is correctly adjusted, you will see two single white lines.

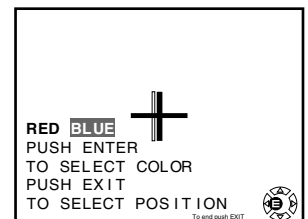

To align the colors (continued)

- 6** Press **EXIT** to display the circumference CONVERGENCE menu.

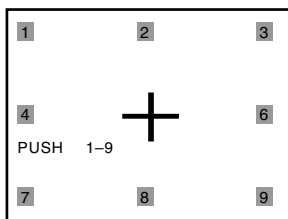

- 7** Press the corresponding **Number button** (1-9) to select the place you want to adjust.

Example: Number 1

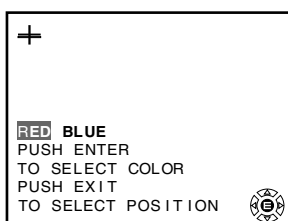

- 8** Press **ENTER** to select "RED" or "BLUE". The selected color is highlighted.

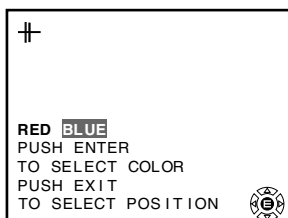

- 9** Press **▲**, **▼**, **◀**, or **▶** to converge the red or blue line into the green line. Repeat steps 8 and 9 until you see two single white lines.

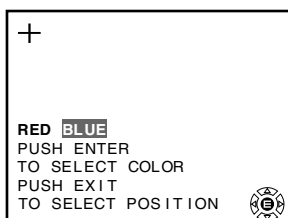

- 10** Press **EXIT** once to select any other place you want to adjust, then repeat steps 7 through 9.

Example: Number 6

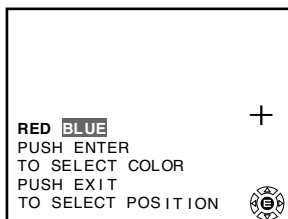

- 11** Press **EXIT** twice to close the CONVERGENCE menu.

Watching TV Programs

To watch a TV program

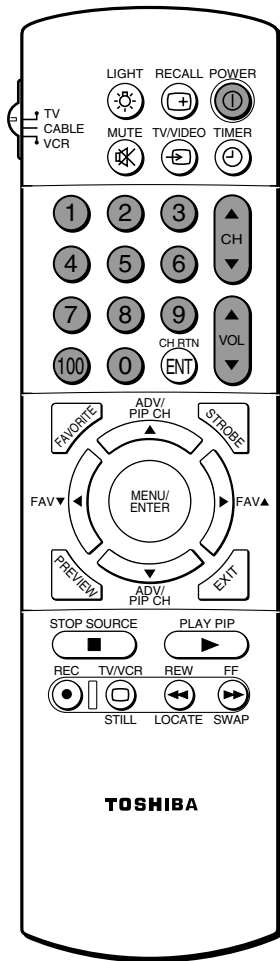
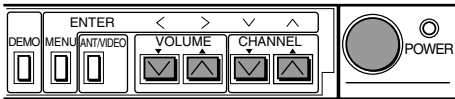

1 Press **POWER** on the Remote Control or the TV.

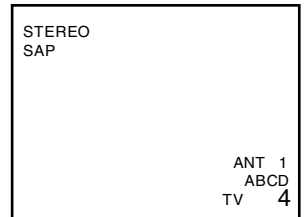

2 Select the desired program in one of the following two ways.

To scan the memorized channels in numerical sequence

Press **CHANNEL ▲** to select the next higher channel.

Press **CHANNEL ▼** to select the next lower channel.

Press the button again to select the next memorized channel.

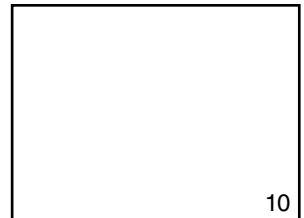

To select a channel directly

Press the **Channel Number** buttons (0 – 9 and 100).

To select channel 4, press "4" (or press "0" and "4" in order).

To select channel 38, press "3" and "8" in order.

To select channel 125, press "100," "2," and "5" in order.

3 Adjust the sound volume with the **VOLUME ▼ / ▲** on the Remote Control or the TV.

Press **▲** to increase the volume; **▼** to decrease the volume.

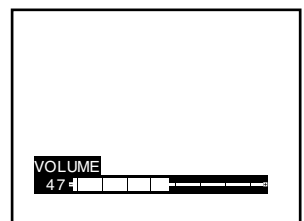

4 To turn off the TV, press **POWER** again.

If you cannot select certain channels (either TV broadcast or CABLE channels)

Check to see if the TV/CABLE function is properly set. See page 22.

Notes:

- The **CHANNEL ▼ / ▲** on the TV function as the menu **▼ / ▲** buttons while a menu is on the screen.
- The **VOLUME ▼ / ▲** on the TV function as the menu **< / >** buttons while a menu is on the screen.

Convenient Remote Functions

To use On-screen displays/Sound muting/Channel return

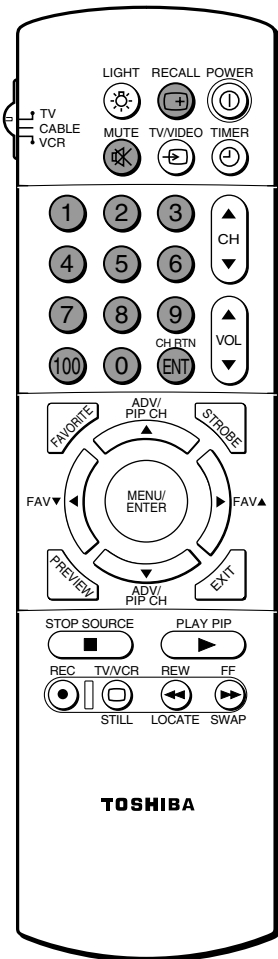

To display on-screen information

Press **RECALL** to display the following on-screen information.

- Antenna input (when in TV mode)
- Channel label (if previously preset)
- Channel number or VIDEO mode selected
- Time (if the clock has been set)
- STEREO or SAP audio status

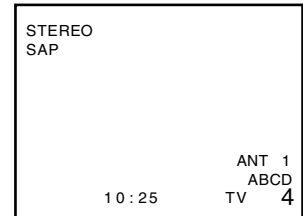

To mute the sound

- 1 Press **MUTE** to mute the sound immediately without affecting the picture.



- 2 To restore the sound, press **MUTE** again.

Note:

When the **MUTE** button is pressed, the Closed Captioned feature "C1" is activated. To deactivate it, press the **MUTE** button again. This feature only functions when the Closed Caption mode is set to "Off." (See page 48.)

To return to the previously viewed channel

Using this function, you can watch two channels alternately.

- 1 Select the first channel you want to watch.

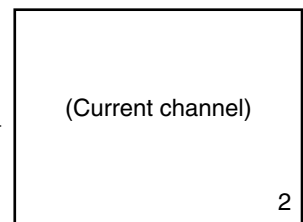

- 2 Select the other channel with the **Channel Number** buttons.

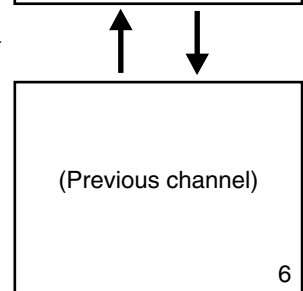

- 3 Press **CH RTN**.
The previous channel returns.

Each time you press **CH RTN**, the TV will switch back and forth between the two channels.

Controlling the Picture

To adjust the picture

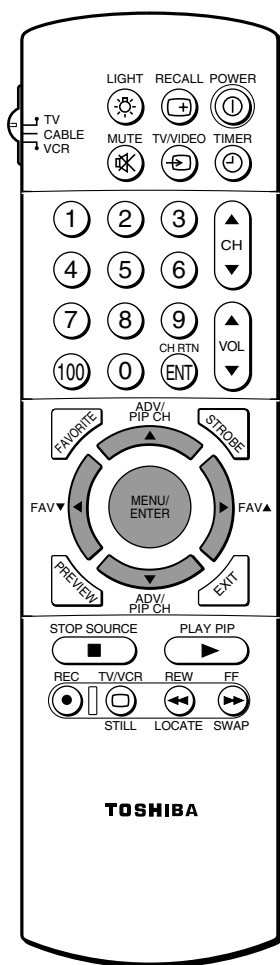
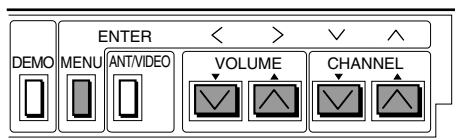

To adjust the picture quality

You can adjust the picture quality (CONTRAST, BRIGHTNESS, COLOR, TINT, and SHARPNESS) to suit your personal preference.

1 Press **MENU**, then press ◀ or ▶ until the PICTURE menu appears.

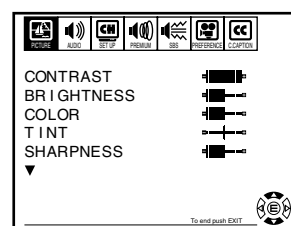

2 Press ▼ (or ▲) until the item you want to adjust is highlighted.

Example: CONTRAST adjustment mode display

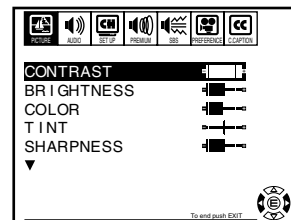

3 Press ◀ or ▶ to adjust the level.

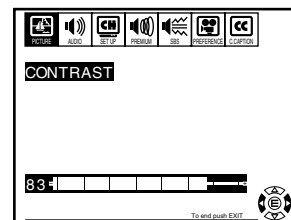

Item	Pressing	
	◀	▶
CONTRAST	lower	higher
BRIGHTNESS	darker	lighter
COLOR	weaker	stronger
TINT	reddish	greenish
SHARPNESS	softer	sharper

When you adjust any of the five PICTURE items, the new setting will be stored in the "MEMORY." (See page 29.)

Note:

You can reset the PICTURE setting to the factory preset status by using the RESET function. (See page 30.) When you turn on the RESET function, the TV will return to the NORMAL mode. (The settings you have adjusted remain in the MEMORY mode.)

To adjust the picture (continued)

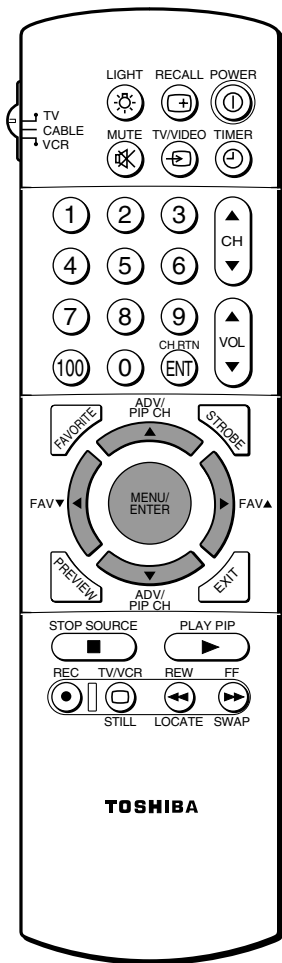
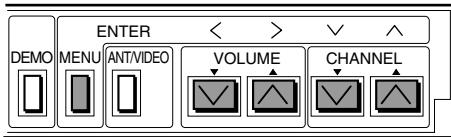

To select the color temperature

These selections change the appearance of gray and white tones of the picture.

- 1 Press **MENU**, then press ◀ or ▶ until the PREFERENCE menu appears.

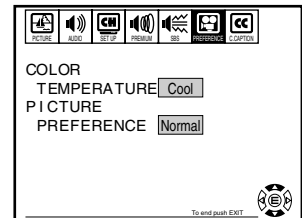

- 2 Press ▲ or ▼ until "COLOR TEMPERATURE" is highlighted.

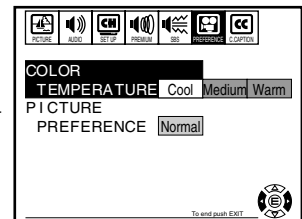

- 3 Press ◀ or ▶ to select the temperature you want.

Cool: Bluish
Medium: Neutral
Warm: Redish

To select the picture preference

You can select the type of picture you want from three preset picture modes (Normal, Theater, and Memory).

- 1 Select the PREFERENCE menu.

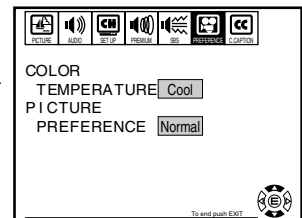

- 2 Press ▲ or ▼ until "PICTURE PREFERENCE" is highlighted.

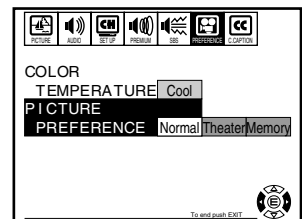

- 3 Press ◀ or ▶ to select the mode you want.

Mode	Picture quality
Normal	the picture quality preset at the factory
Theater	movie-like picture setting
Memory	the picture quality you set (See page 28.)

Controlling the Sound

- You can adjust the sound quality (BASS, TREBLE and BALANCE) to suit your personal preference.

To adjust the sound

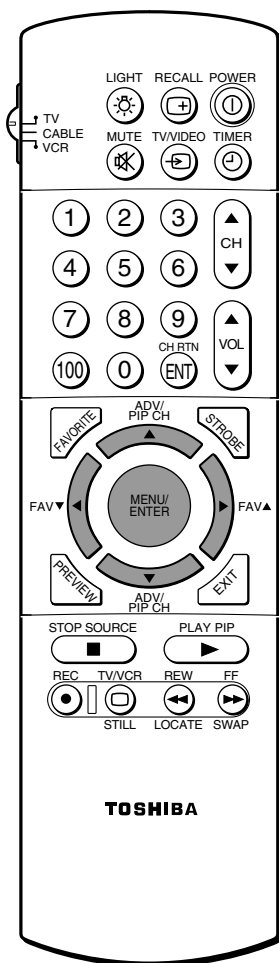
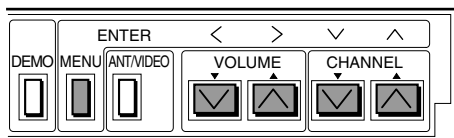

1 Press **MENU**, then press ◀ or ▶ until the **AUDIO** menu appears.

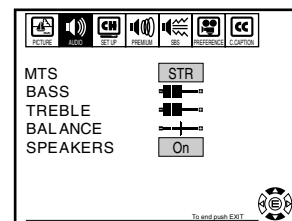

2 Press ▼ (or ▲) until the item you want to adjust is highlighted.

Example: Adjusting "BASS."

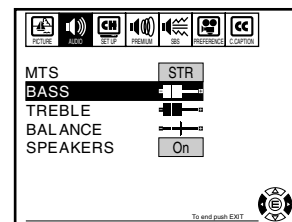

3 Press ◀ or ▶ to adjust the level.

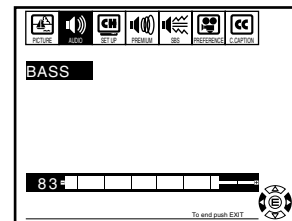

Item	Pressing	
	◀	▶
BASS	weaker	stronger
TREBLE	weaker	stronger
BALANCE	decreases the right channel	decreases the left channel

RESET function

To reset the **PICTURE** and **AUDIO** adjustments to the factory preset level (maximum CONTRAST and all other adjustments centered)
 Select **RESET** in the **SET UP** menu with ▲ or ▼, then press ◀ or ▶.
 (See page 18.)

The **RESET** function also performs the following adjustments.

- **COLOR TEMPERATURE** Cool
- **PICTURE PREFERENCE** Normal
- **NOISE REDUCTION** Off

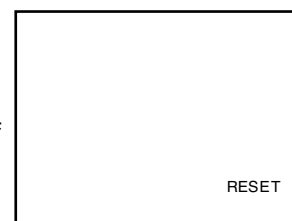

Selecting Stereo and SAP Broadcasts

- The MTS (Multi-channel TV Sound) feature allows you to improve your TV viewing with high fidelity stereo sound. MTS also provides for an extra audio channel, SAP (Second Audio Program), used to transmit a second language or other audio information.

To listen to Stereo/SAP broadcasts

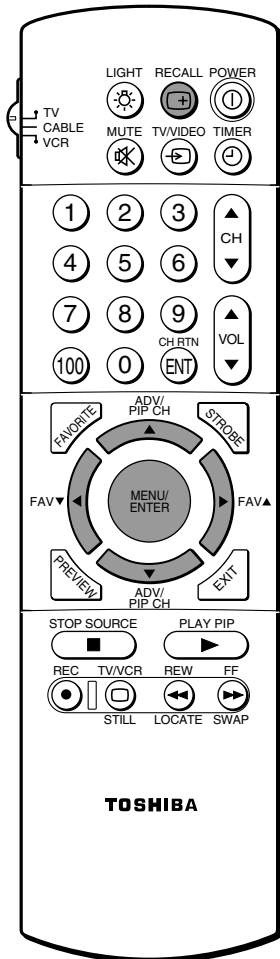
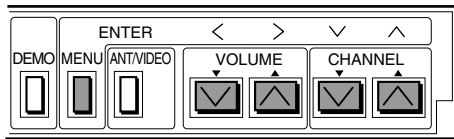

If the stereo sound is noisy

If a broadcast signal is not strong enough, and noise-free stereo sound is not available, select "MONO" in the MTS menu.

The noise should be reduced.

To listen to stereo sound

When the TV receives a stereo broadcast, the word "STEREO" (or "SAP") is displayed on the screen. It is also displayed whenever the TV is turned on, a channel is selected, or the **RECALL** button is pressed.

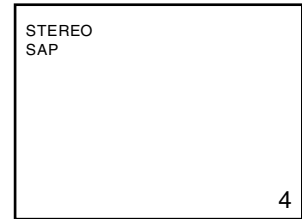

- 1 Press **MENU**, then press ◀ or ▶ until the **AUDIO** menu appears.

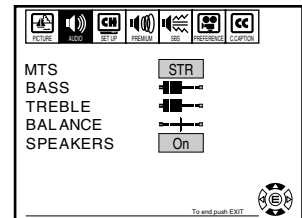

- 2 Press ▼ (or ▲) until "MTS" is highlighted.

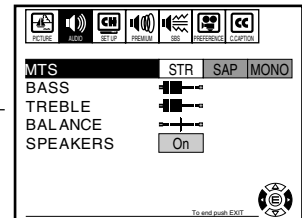

- 3 Press ◀ or ▶ to select "STR." If a stereo broadcast is received, "STR" will be displayed in yellow.

Normally this function can be left in the stereo mode ("STR"). Your TV will then automatically reproduce either stereo or monaural sound, whichever is broadcast.

To listen to a second language

- 1 Follow steps 1 and 2 above.
- 2 Press ◀ or ▶ to select "SAP." You will hear only the second language from the left and right speakers.

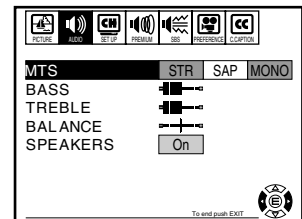

Notes:

- Be sure to select the "STR" mode if the broadcast is in stereo.
- The MTS function is not available while in VIDEO mode.

Enhancing the Surround Sound Effect

- This TV allows you to activate or deactivate the stereo surround effect.

To activate the Surround sound function

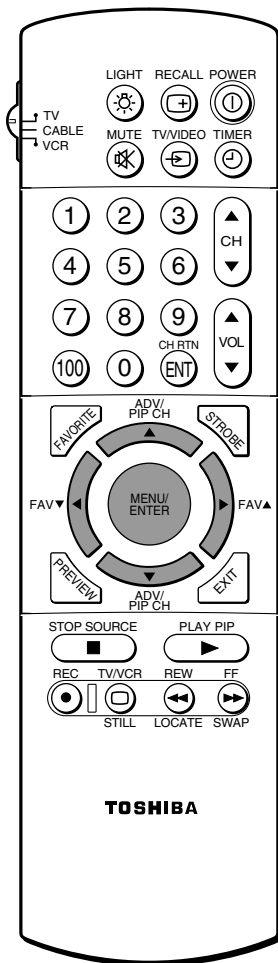
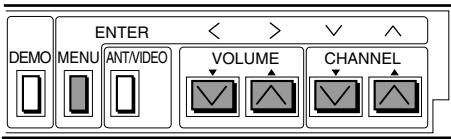

1 Select the "STR" (stereo) mode following steps 1 through 3 on the previous page.

2 Press **MENU**, then press ◀ or ▶ until the PREMIUM menu appears.

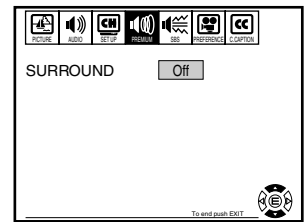

3 Press ▲ or ▼ to select "SURROUND."

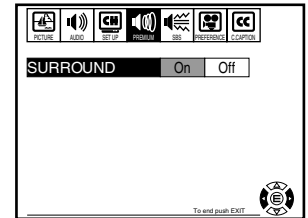

4 Press ◀ or ▶ to highlight "On."

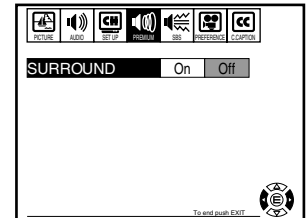

To deactivate the Surround sound function

Select "Off" in step 4 above.

Note:

Normally you can leave the MTS function set to "STR" and the SURROUND sound function set to "On". The TV will automatically produce either Surround, stereo or monaural, whichever is broadcast.

Operating the Sub-Bass System

- The Sub-Bass System allows you to improve bass performance (even when the sound volume is low).

To operate the Sub-Bass System

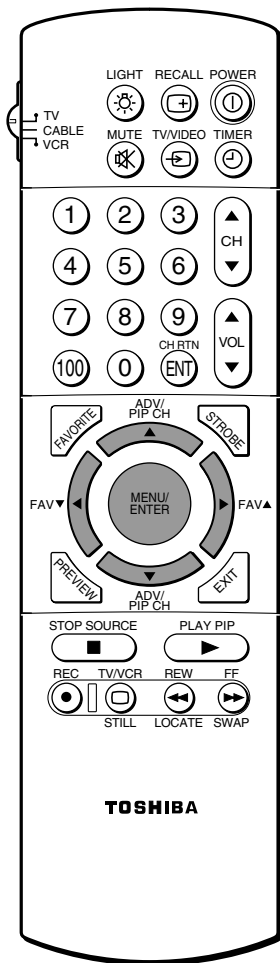
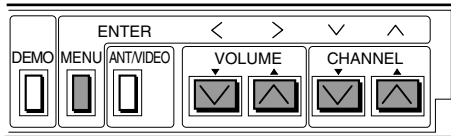

To activate the Sub-Bass System

1 Press **MENU**, then press ◀ or ▶ until the SBS menu appears.

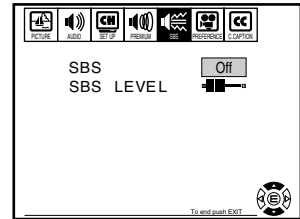

2 Press ▲ or ▼ until "SBS" is highlighted.

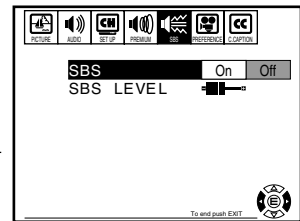

3 Press ◀ or ▶ to select "On."

To adjust the SBS level

1 Select "SBS LEVEL" in the SBS menu.

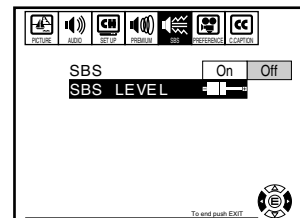

2 Press ◀ or ▶ to adjust the SBS level.

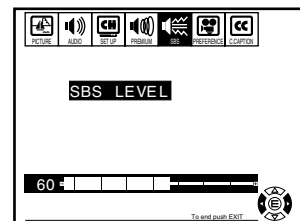

To deactivate the Sub-Bass System function

Select "Off" in step 3 above.

Note:

The Sub-Bass System signal does not pass through the "VARIABLE AUDIO OUTPUT" jacks. (See page 58.) However, the above on-screen displays will appear when the buttons are pressed.

Setting the OFF Timer and the Clock

- With the OFF timer, you can set the TV to turn off automatically after a pre-determined period of time (in 10 minute increments, up to 180 minutes).

To set the OFF timer

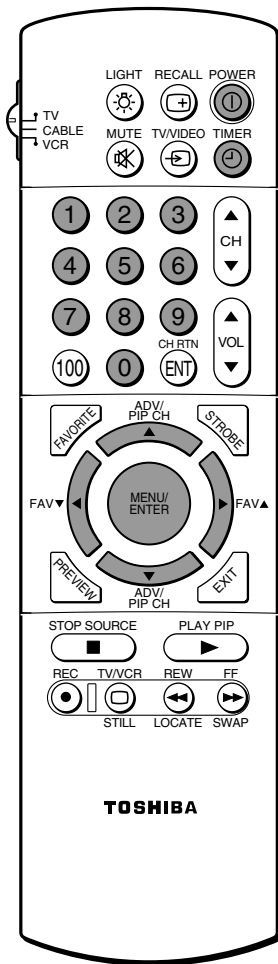

1 Press **TIMER** to select the TIMER mode. The first digit will flash.

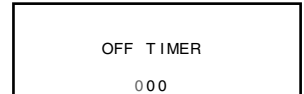

2 Press any two **Number buttons** to enter the length of time you want the TV to stay on. The remaining number(s) to be adjusted will flash continuously.

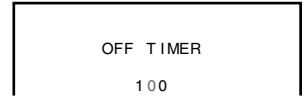

Example: 120 minutes
Press 1, then 2.

3 Press **TIMER** again to start the timer. The display color will change from purple to blue, then the display will disappear.

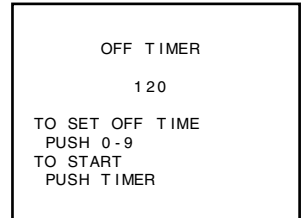

You can also set the OFF timer using the on-screen menu.

1 Select the SETUP menu, then press **▼** (or **▲**) until "TIMER/CLOCK" is highlighted.

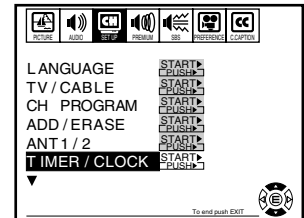

2 Press **◀** or **▶** until the TIMER mode is displayed. Then press two **Number buttons** to enter the length of time you want the TV to stay on.

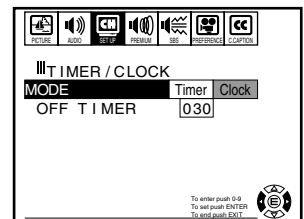

Example: 30 minutes
Press 0, then 3.

3 Press **ENTER** to start the timer.

To cancel the OFF timer

Press **POWER** twice, once to turn the TV off and once to turn it on again.

To set the clock

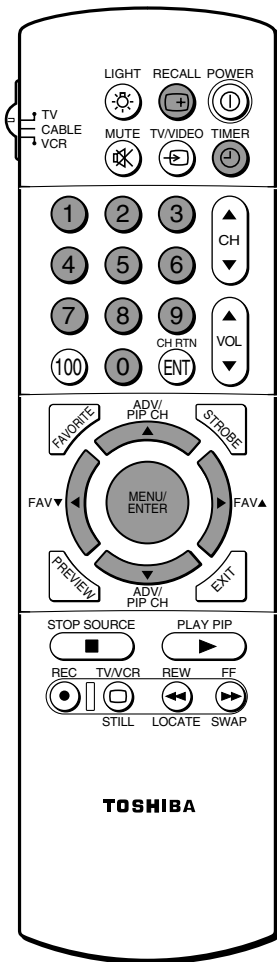

To monitor the time
Press **RECALL**.

Note:

If the power source for the TV is interrupted (i.e., AC cord unplugged or power failure), the clock will have to be reset. (The time display will show "00:00.")

1 Press **TIMER** twice to select the **CLOCK** mode.
The first digit will flash.

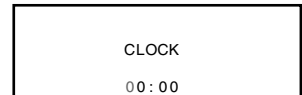

2 Press four **Number buttons** to enter the correct time.
The remaining number(s) to be adjusted will flash continuously.

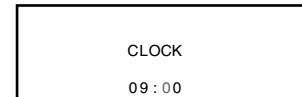

Example: To set 9:25 a.m.
Press 0, 9, 2 and 5.

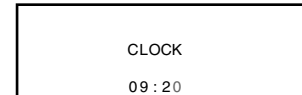

- The clock operates on a 12 hour-cycle.



3 Press **TIMER** to start the clock.
The display color will change from purple to blue, then the display will disappear.

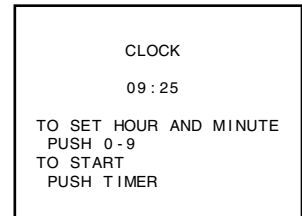

You can also set the clock using the on-screen menu.

1 Select the **SETUP** menu, then press **▼** (or **▲**) until "TIMER/CLOCK" is highlighted.

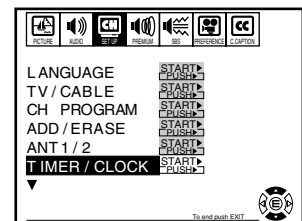

2 Press **◀** or **▶** until the **CLOCK** mode is displayed. Then press four **Number buttons** to enter the correct time.

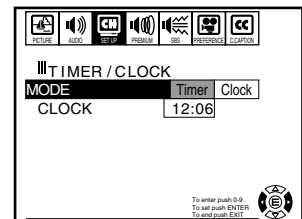

Example: To set 12:06 p.m.
Press 1, 2, 0, and 6.

3 Press **ENTER** to start the clock.

Watching Picture-in-Picture

- This TV is capable of displaying two pictures simultaneously. This is called the Picture-in-Picture function. A TV broadcast picture, or a picture from an external source such as a VCR, can be displayed as a small picture.

To display a small picture

Note:
Signal sources input through the ANT-2 and COLOR STREAM terminals cannot be displayed as a small picture. Also, when the main picture source is "COLOR STREAM", PIP is not available.

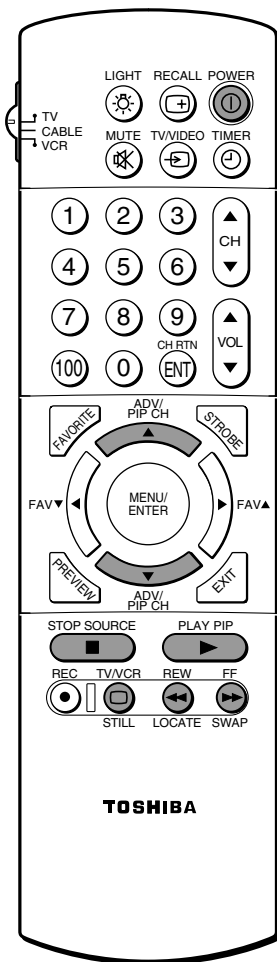

To display a TV broadcast picture as a small picture

- 1 Turn on the TV and select the desired program.
- 2 Press **PIP** once to display a small picture. The 1/9 size window picture will appear. If you press **PIP** again, the 1/16 size window picture will appear.

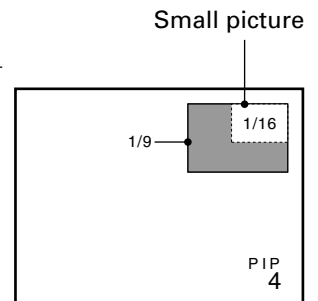

- 3 Press **PIP CH** ▲ or ▼ to select the desired program for the small picture.
- 4 To turn off the small picture, press **PIP** again.

To display a picture from an external source as a small picture

Connect the external source equipment for the small picture. (For connections, see pages 53 – 57.)

- 1 Turn on the TV, and select the desired program.
- 2 Press **PIP** to display a small picture.
- 3 Press **SOURCE** repeatedly to select the input source (TV, VIDEO 1, VIDEO 2, or VIDEO 3) for the small picture. The selected mode will be displayed in purple.

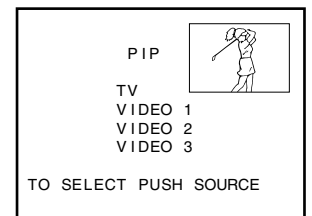

To use advanced functions

To change the position of the small picture

Press **LOCATE** repeatedly while the small picture is displayed. The display position of the small picture will change in order.

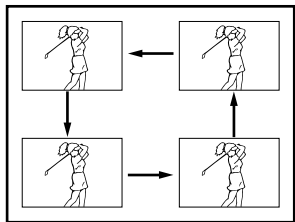

To switch the main and small pictures

Press **SWAP** while the small picture is displayed. The main and small pictures will switch. To switch them again, press **SWAP** again.

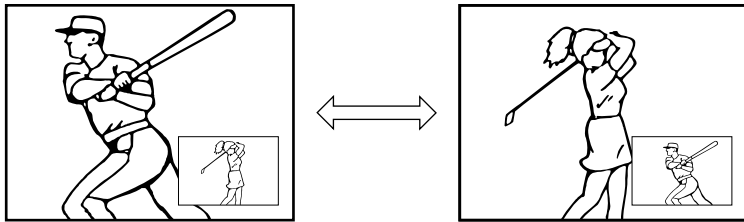

To freeze the small picture

Press **STILL** while the small picture is displayed. The small picture will become a still picture. To return it to a moving picture, press **STILL** again.

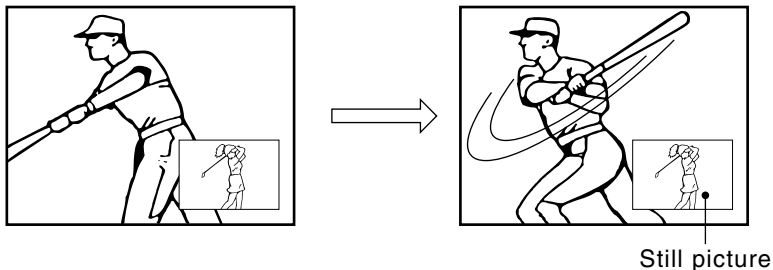

CAUTION:
 Avoid displaying stationary images on your TV screen for an extended period of time. Stationary patterns generated by the PIP display, Multi-Window display, computer displays, videogames, stock market reports etc. can become permanently ingrained on the picture tube. This damage is not protected by your warranty as it is the result of misuse. If you use your TOSHIBA Television to display still images, it is always advisable to reduce the brightness and contrast settings. Never leave a PIP display, Multi-Window display, computer display or videogame unattended.

Multi-Window Function

- The Multi-Window function provides two channel search modes. One is the "PREVIEW" that scans the channels programmed in the TV memory by the CH PROGRAM function(6-picture multi-search), and the other is the "FAVORITE" that scans the channels programmed in the TV memory by the FAVORITE CH function(9-picture multi-search).
- The STROBE function is convenient when watching a scene at an instant of quickly moving picture such as a sport program.

To use the PREVIEW/FAVORITE/STROBE functions

Notes:

- When the main picture source is "COLOR STREAM", the PREVIEW, FAVORITE and STROBE buttons are not available.
- The FAVORITE button activates only after you have programmed your favorite channels. See page 44 for details.

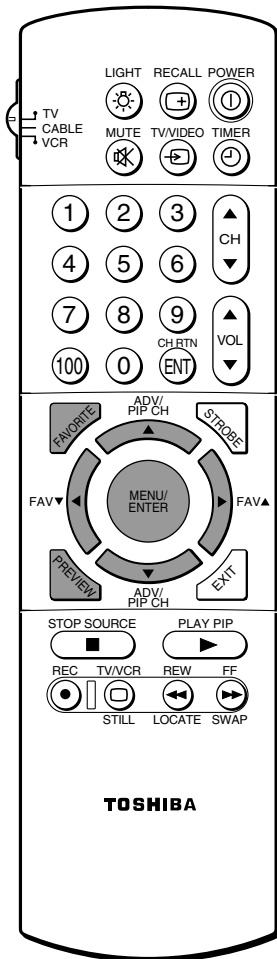

To use PREVIEW function

Press **PREVIEW** to scan the channels of "ANT-1" programmed in the TV memory by the CH PROGRAM function. The 6-picture multi-search will start.

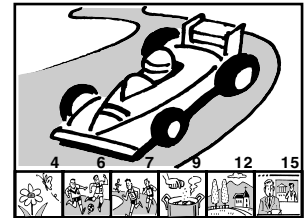

To cancel the PREVIEW function
Press **PREVIEW** again.

To use FAVORITE function

1 Press **FAVORITE** to scan the channels programmed in the TV memory by the FAVORITE CH1 function. The 9-picture multi-search will start. The first window will be displayed with a moving picture. Each time you press **FAVORITE**, the display will change in the following order.
FAVORITE CH1 → FAVORITE CH2 → OFF



2 Press **▲/▼/◀/▶** to select a channel you want to see with a moving picture.

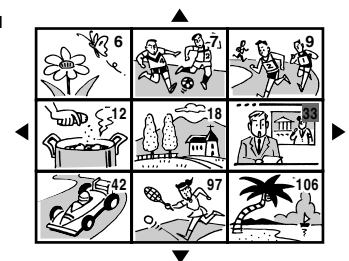

3 Press **ENTER** to display your desired channel you have selected at step 2 with a normal picture.



To cancel the FAVORITE function
Press **FAVORITE** again.

To use the PREVIEW/FAVORITE/STROBE functions (continued)

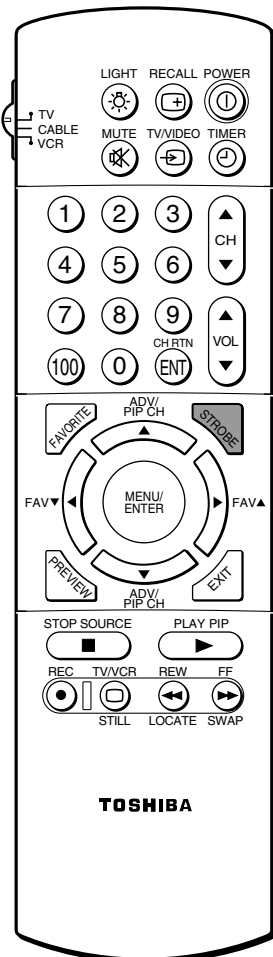

To use the STROBE function

Press **STROBE** to start the STROBE function.
9-picture multi-strobe starts for the present main picture.

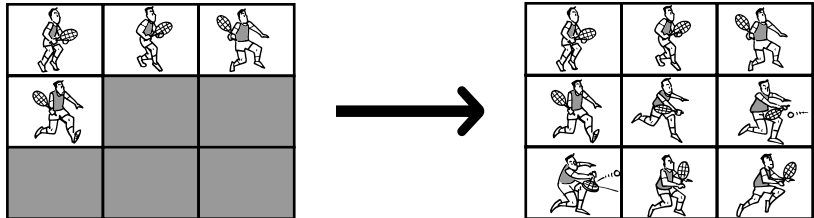

For example, you can watch a decisive moment of a sport program that has been recorded previously.

To cancel the STROBE function

Press **STROBE** again.

Locking Channels

- With this function, you can lock out specific channels by entering your own 4-digit code. The TV will not be able to tune to those channels for the next 24 hours, unless you enter the code. This TV has 8 memory spaces total — 4 for TV mode and 4 for CABLE mode.

To lock out channels

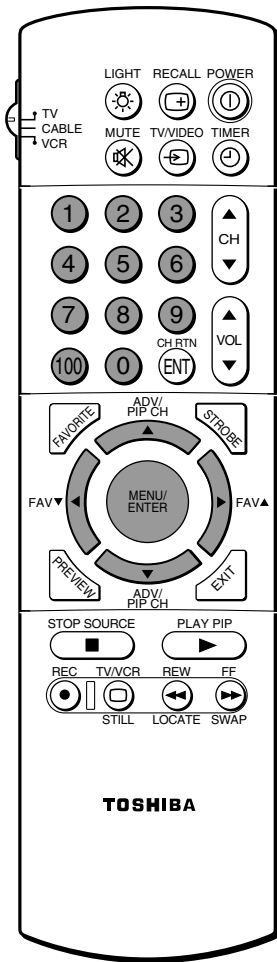

ADVANCED OPERATION

Note: If a different code number is used to lock out a channel, the last one has priority over the preceding ones.

1 Press **MENU**, then press ◀ or ▶ until the **SET UP** menu appears.

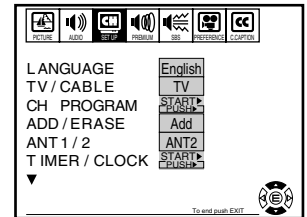

2 Press ▲ (or ▼) until **“CH LOCK”** is highlighted.

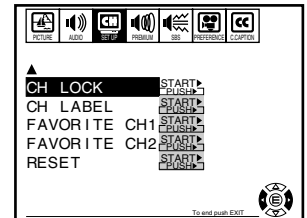

3 Press ◀ or ▶ to display the **CH LOCK** menu. **“SET/CLEAR”** will be highlighted. Press ◀ or ▶ to select **“Set.”**

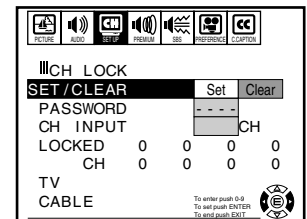

4 Press ▼ until **“PASSWORD”** is highlighted.

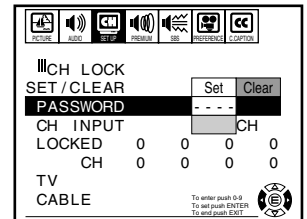

5 Press the **Number buttons** (0-9) to enter a 4-digit code. The numbers you enter will replace the dashes in the display. **Pick a number that is easy to remember.**

Example: To enter **“1234”**.
Press 1, 2, 3, and 4 in order.
1 ----> 12 ----> 123 ----> 1234

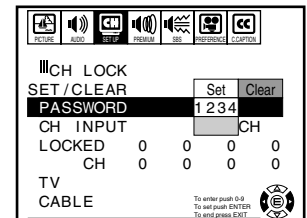

6 Press ▼ until **“CH INPUT”** is highlighted, then press the **Number buttons** (0-9, 100) to enter the channel number.

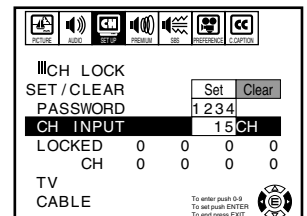

To lock out channels (continued)

7 Press **ENTER**.

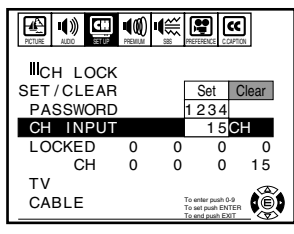

8 Repeat steps 6 and 7 for other channels.

To unlock channels

1 Select CH LOCK in the SET UP menu, then press **◀** or **▶** to select "Clear."

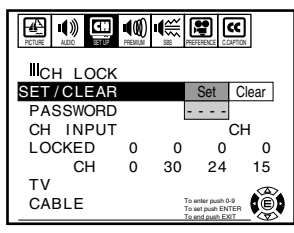

2 Press **▼** until "PASSWORD" is highlighted, and enter the 4-digit code used to lock out the channels with the **Number buttons (0-9)**.

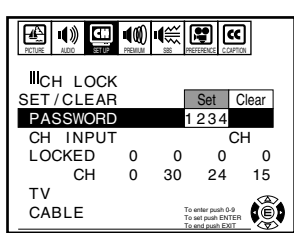

3 Press **ENTER**.

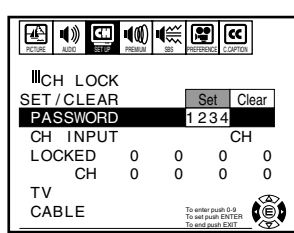

If a wrong code has been entered
These messages appear. Try to enter the correct code again.

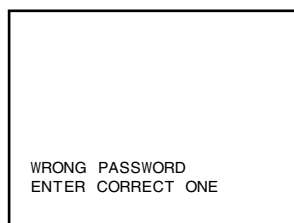

If you want to know the channels you have locked out
Call up the CH LOCK menu.

Labeling Channels

- This feature allows you to enter a 4 letter channel identifier of your choice that will appear over the channel number display. The label can be anything you want (for example the station call letters).
- The label you set will appear when you turn the TV on, select a channel, or press the **RECALL** button.

To program channel labels

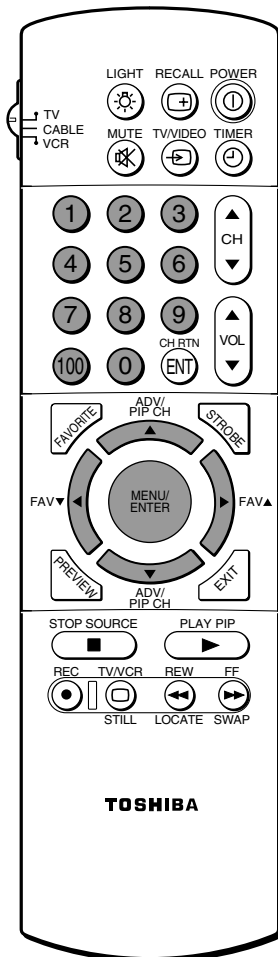

1 Press **MENU**, then press ◀ or ▶ until the SET UP menu appears.

Example: To assign "ABCD" to channel 4.

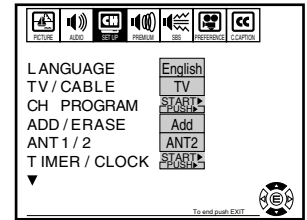

2 Press ▲ (or ▼) until "CH LABEL" is highlighted.

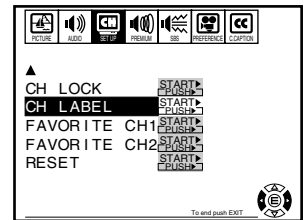

3 Press ◀ or ▶ to display the CH LABEL menu. "SET/CLEAR" will be highlighted.

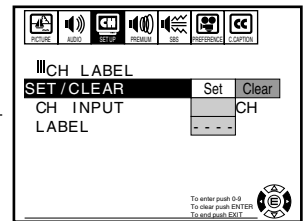

4 Press ◀ or ▶ to select "Set."

5 Press ▼ until "CH INPUT" is highlighted, and select the channel you want to label with the **Channel Number** buttons.

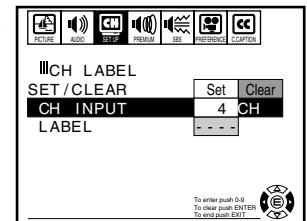

6 Press ▼ until "LABEL" is highlighted.

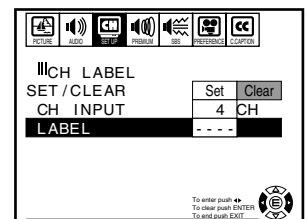

To program channel labels (continued)

7 Press ◀ or ▶ to select the first character for the label, then press **ENTER**.

Letters of the alphabet, numbers and other graphic symbols are available for labeling.
Each time you press the ◀ or ▶ button, the displayed character will change in the following order.

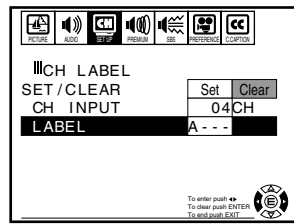
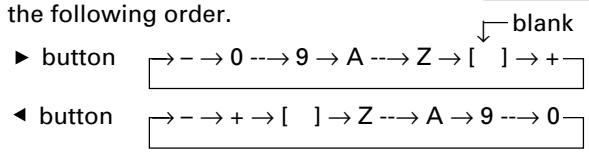

8 Repeat step 7 to enter the second, third and fourth characters.

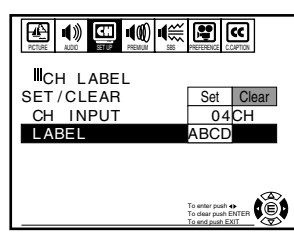

9 To label another channel, repeat steps 5 through 8. You can label 32 channels.

To clear the channel label

1 Select CH LABEL in the SET UP menu.

2 Press ◀ or ▶ to select "Clear."

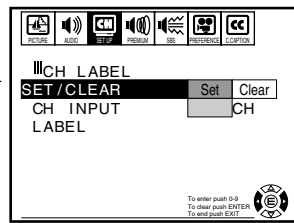

3 Press ▼ until "CH INPUT" is highlighted, then select the channel you want to clear with the **Channel Number** buttons.

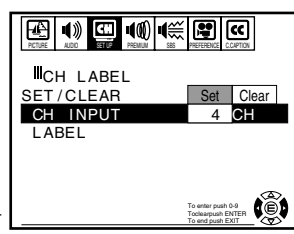

4 Press **ENTER**.

5 Repeat steps 3 and 4 for other channels.

Programming Your Favorite Channels

- The Favorite Channel Programming feature allows you to program up to 9 of your favorite channels each for "FAVORITE CH 1" and "FAVORITE CH 2" mode. Program your favorite channels for these modes separately.

To program your favorite channels

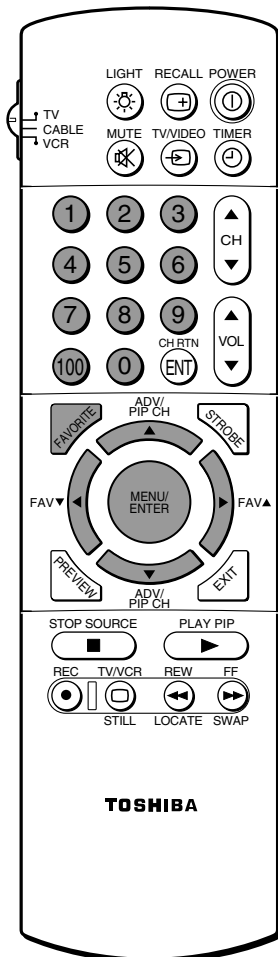

1 Press **MENU**, then press ◀ or ▶ until the SET UP menu appears.

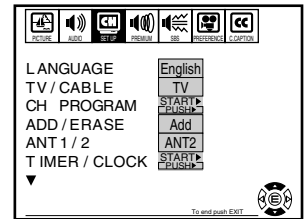

2 Press ▲ (or ▼) until "FAVORITE CH1" or "FAVORITE CH2" is highlighted.

FAVORITE CH1



FAVORITE CH2

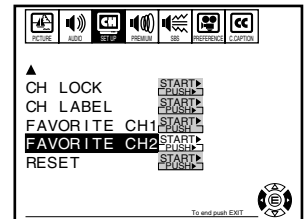

3 Press ◀ or ▶ to display the FAVORITE CH1 menu for example. "SET/CLEAR" will be highlighted.

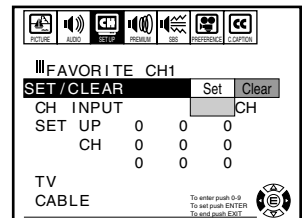

4 Press ◀ or ▶ to select "Set."

5 Press ▼ until "CH INPUT" is highlighted, then press the **Channel Number** buttons to enter the channel number.

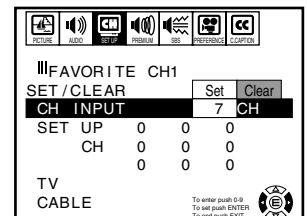

To program your favorite channels (continued)

6 Press **ENTER**.

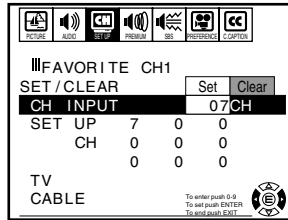

Note:

The **FAV** ▼ / ▲ and **FAVORITE** buttons will activate only after you have programmed your favorite channels.

7 Repeat steps 5 and 6 for other channels.

To scan your favorite channels in order one by one
Press **FAV** ▼ / ▲.

To scan your favorite channels with a 9-picture multi-window
Press **FAVORITE**. (See page 38 for details.)

To clear the channels you have programmed

1 Select "FAVORITE CH1" or "FAVORITE CH2" in the SET UP menu.

Example: FAVORITE CH2

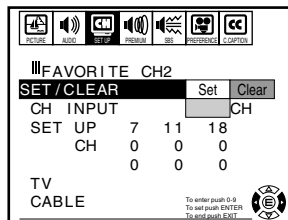

2 Press ◀ or ▶ to select "Clear."

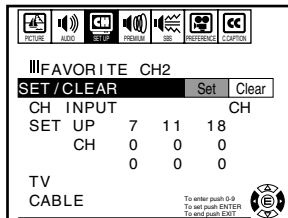

3 Press **ENTER**.
All the favorite channels you have programmed are cleared.

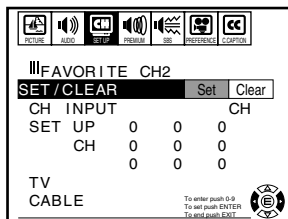

Flesh Tone/Noise Reduction

To activate the Flesh Tone and Noise Reduction Functions

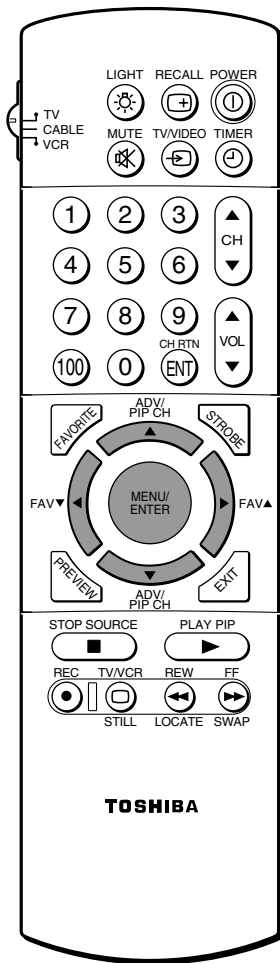
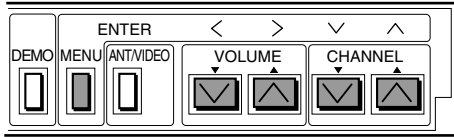

ADVANCED OPERATION

Flesh Tone Function

This function allows you to obtain natural flesh tones by correcting the difference of tint between TV stations.

- 1 Press **MENU**, then press ◀ or ▶ until the PICTURE menu appears.

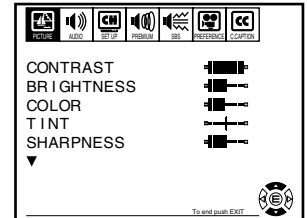

- 2 Press ▲ (or ▼) until "FLESH TONE" is highlighted.

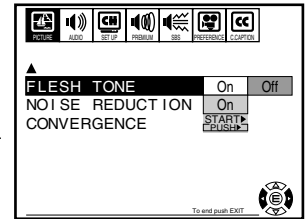

- 3 Press ◀ or ▶ to select "On."

Noise Reduction Function

This function allows you to reduce visible interference in your TV picture. This is useful when receiving a broadcast with a weak signal or playing back a video cassette or disc damaged by repeated use.

- 1 Press **MENU**, then press ◀ or ▶ until the PICTURE menu appears.

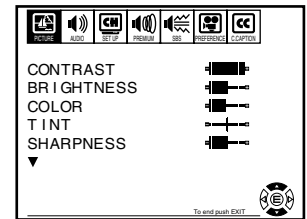

- 2 Press ▲ (or ▼) until "NOISE REDUCTION" is highlighted.

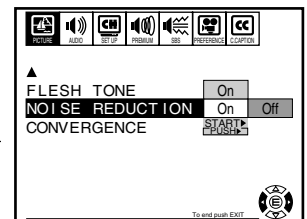

- 3 Press ◀ or ▶ to select "On."

To deactivate these functions
Select "Off" in step 3 above.

Displaying XDS Information

To display XDS information

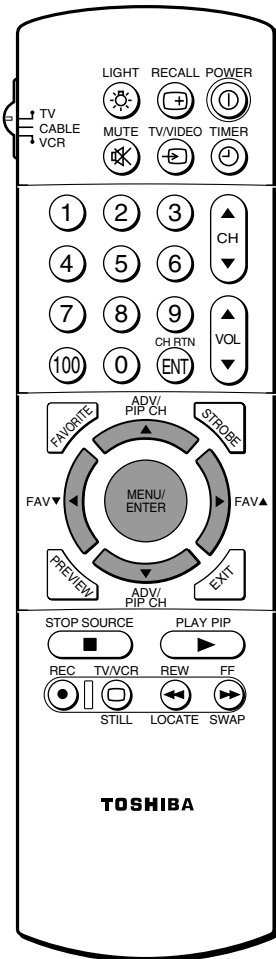
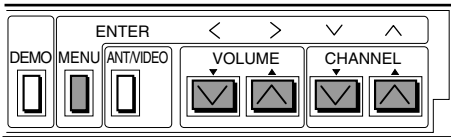

1 Select the desired program.

2 Press **MENU**, then press **◀** or **▶** until the **CLOSED CAPTION** menu appears.

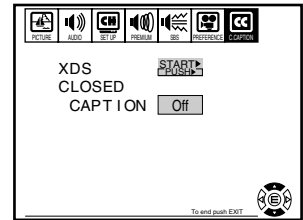

3 Press **▲** or **▼** until "XDS" is highlighted.

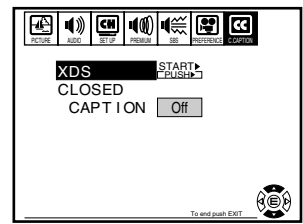

4 Press **◀** or **▶** to display the following XDS (eXtended Data Service) information for about 30 seconds.

- Network name ①
- Call letters ②
- Program name ③
- Program type ④
- Program length ⑤
- Elapsed time in show ⑥
- Program description ⑦

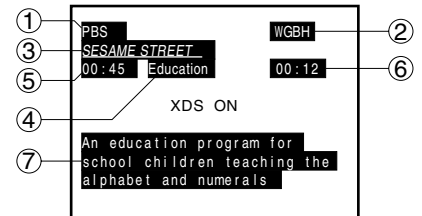

Some of the above information may not be displayed.

If the TV program you are watching does not include XDS information

Only "XDS ON" will be displayed for about 4 seconds when you select the XDS mode.

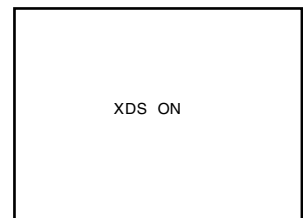

To close the XDS display
Press **EXIT**.

Operating the Closed Captioning Feature

To display Closed Captioning

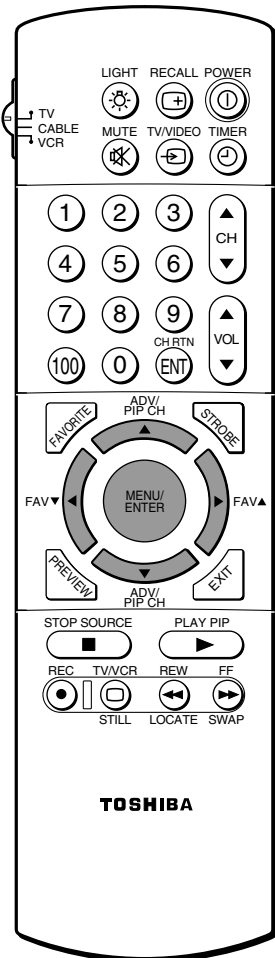
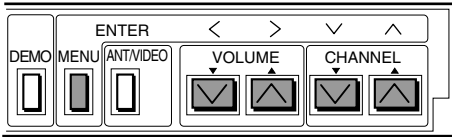

To view captions

Closed captioning is a printed version of the dialogue, narration, and/or sound effects of a TV program. Captions will appear at either the top or bottom of the screen during captioned broadcasts as shown. Captioning is especially helpful for hearing impaired individuals.

1 Select the desired program.

2 Press **MENU**, then press ◀ or ▶ until the **CLOSED CAPTION** menu appears.

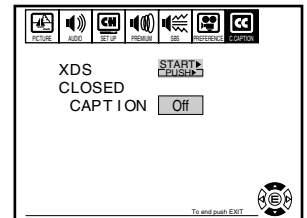

3 Press ▲ or ▼ until "**CLOSED CAPTION**" is highlighted.

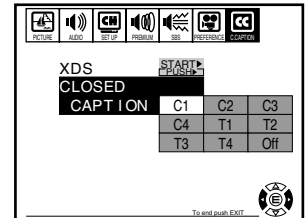

4 Press ◀ or ▶ to select the caption you want — C1 (Caption 1), C2 (Caption 2), C3 (Caption 3), or C4 (Caption 4).

Select "C1" for a transcription of the primary language in your area.

To deactivate this function

Select "Off" in step 4 above.

Note:

A closed-captioned signal may not be decoded in the following situations.

- When a video tape has been dubbed.
- When the signal reception is weak.
- When the signal reception is non-standard.

To display text information

WORLD WEATHER			
	Temps		Current Weather
	F	C	
LONDON	51	11	Clear
MOSCOW	57	14	Cloudy
PARIS	53	12	Clear
ROME	66	19	Cloudy
TOKYO	65	18	Rain

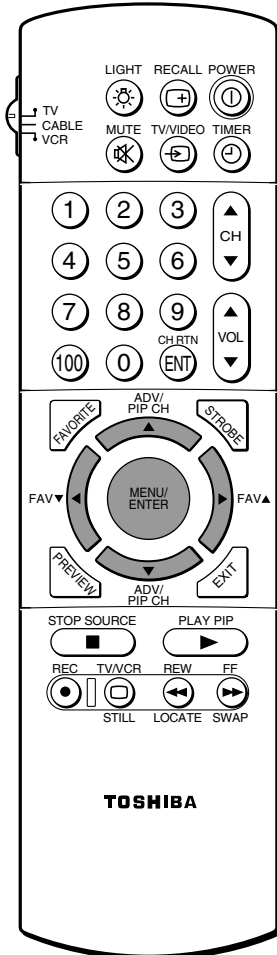
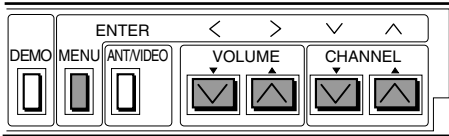

To view text

Text is information presented using all of the television screen. It is usually not related to the current program. For example, it could be a listing of closed captioned programs, news, weather information, or stock market reports.

1 Select the desired program.

2 Press **MENU**, then press **◀** or **▶** until the **CLOSED CAPTION** menu appears.

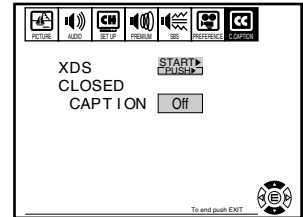

3 Press **▲** or **▼** until **"CLOSED CAPTION"** is highlighted.

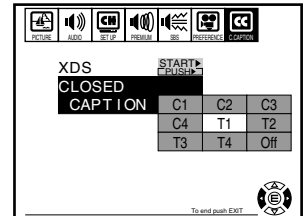

4 Press **◀** or **▶** to select the text you want T1 (Text 1), T2 (Text 2), T3 (Text 3), or T4 (Text 4).

To deactivate this function

Select **"Off"** in step 4 above.

Note:

When you select a caption format channel and the Text mode, the Text screen will always be displayed. However, if Text character signals are not transmitted, the characters will not be displayed.

Changing the On-screen Display Language

- You can choose from three different languages (English, French and Spanish) for the on-screen displays (adjustment menus and messages).

To select a language for the on-screen displays

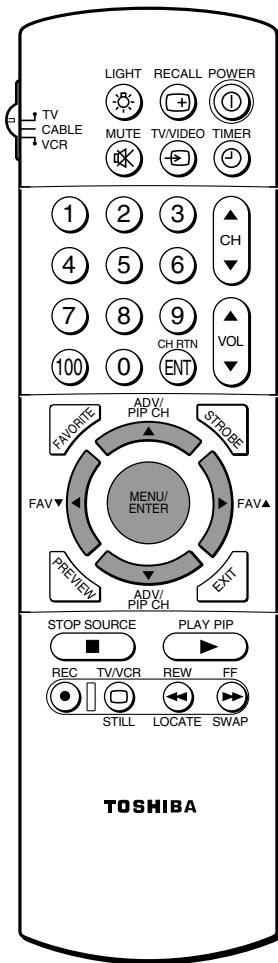
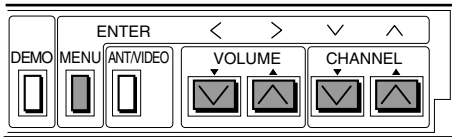

1 Press **MENU**, then press ◀ or ▶ until the SET UP menu appears.

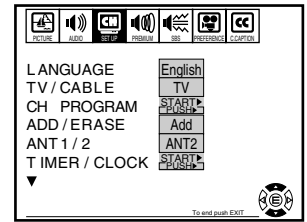

2 Press ▲ (or ▼) until "LANGUAGE" is highlighted.

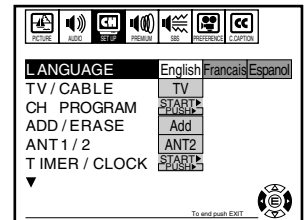

3 Press ◀ or ▶ to select the language you want.

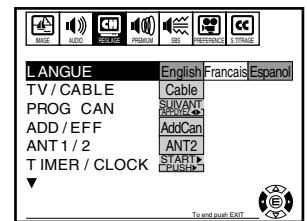

"English"

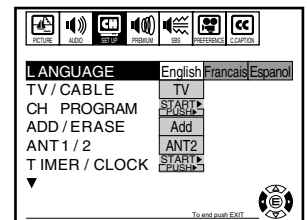

"French"

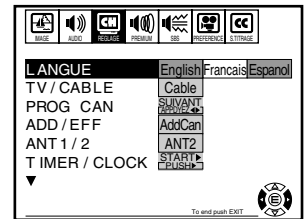

"Spanish"

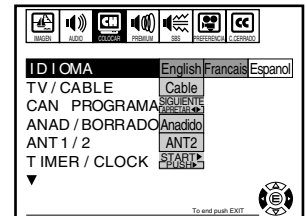

Connecting External Equipment

To connect video/audio equipment

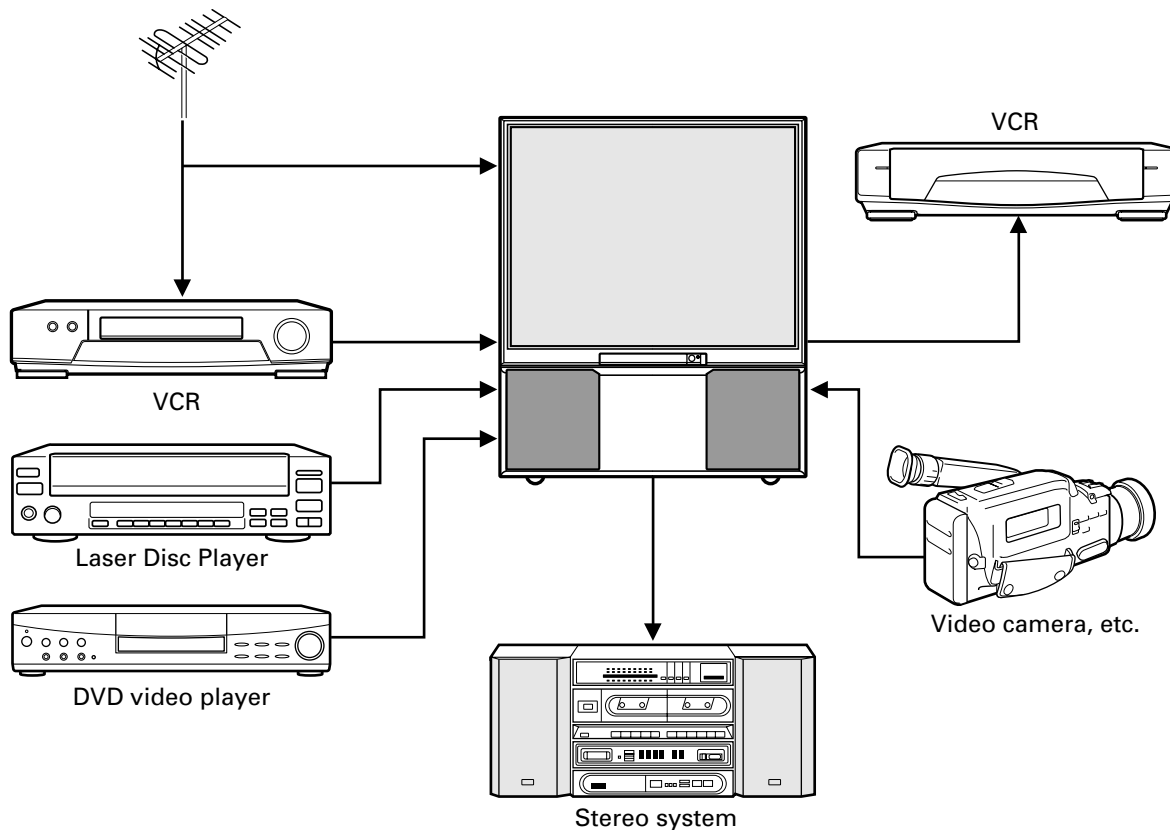

Notes:

- Refer also to the owner's manual of the equipment to be connected.
- When connecting other equipment to the TV, first turn off all main power switches.

Connecting External Equipment (continued)

Monitor panel

Illustrations represent TP55H60.

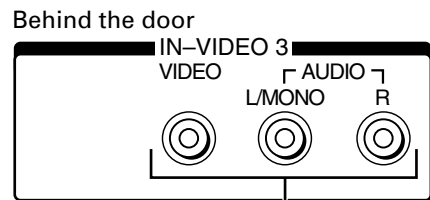
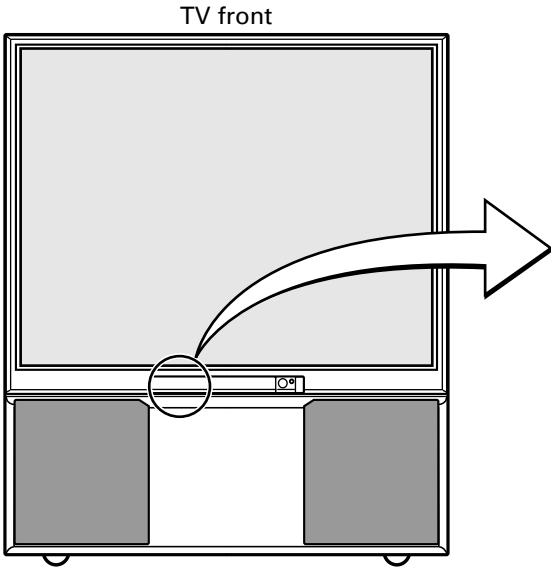

VIDEO/AUDIO INPUT jacks (VIDEO 3)

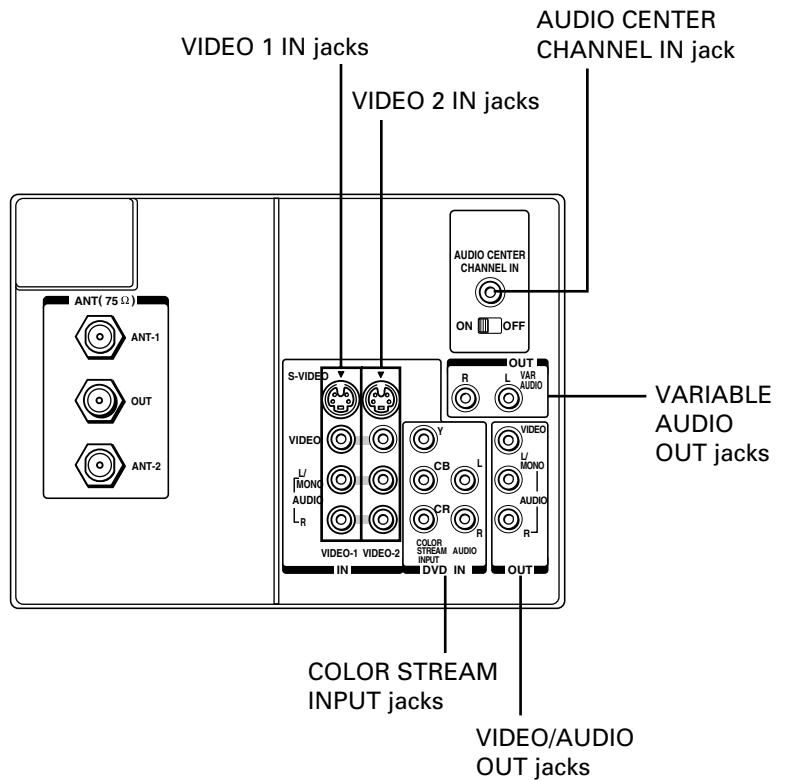
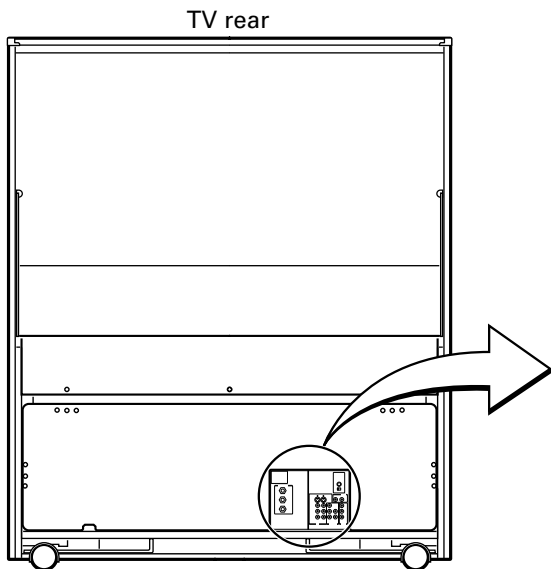

To connect a standard VCR

Connect the VIDEO 1 or VIDEO 2 IN jacks on the rear panel of the TV to the video/audio output jacks of the VCR, Laser Disc Player, etc. for playback of video recordings.

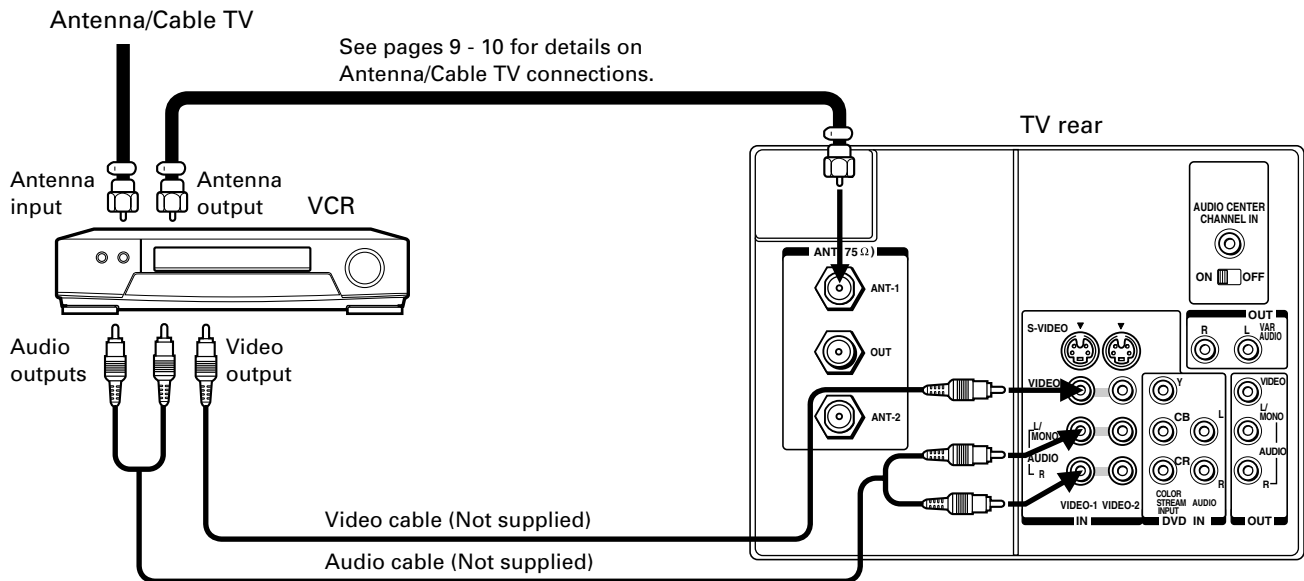

To select the video input source

Press **TV/VIDEO** on the Remote Control (or **ANT/VIDEO** on the TV) repeatedly to select the appropriate source. Each time you press the button, the TV, VIDEO 1, VIDEO 2, VIDEO 3, or COLOR STREAM source will be selected in order.

Select "VIDEO 1" in this example.

The selected source will be displayed in purple.

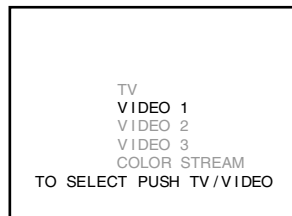

Note on the VIDEO 2 IN jacks

The VIDEO 2 IN jacks can also be used for connecting a second piece of video equipment with video/audio outputs.

To view signals from equipment connected to the VIDEO 2 IN jacks, select "VIDEO 2."

Note on the VIDEO 3 INPUT jacks

The VIDEO 3 INPUT jacks on the TV front panel are convenient for connecting portable video/audio equipment.

To view signals from equipment connected to the VIDEO 3 INPUT jacks, select "VIDEO 3."

Note:

If you connect a monaural VCR, connect the audio output of the VCR to the L/MONO jack.

Connecting External Equipment (continued)

To connect a VCR with an S-video jack

If you connect a VCR with an S-video jack to the "S-VIDEO" jack on the back of the TV, you must also connect the audio cables to the "VIDEO 1 IN" AUDIO jacks. The S-video cable supplies video signals only.

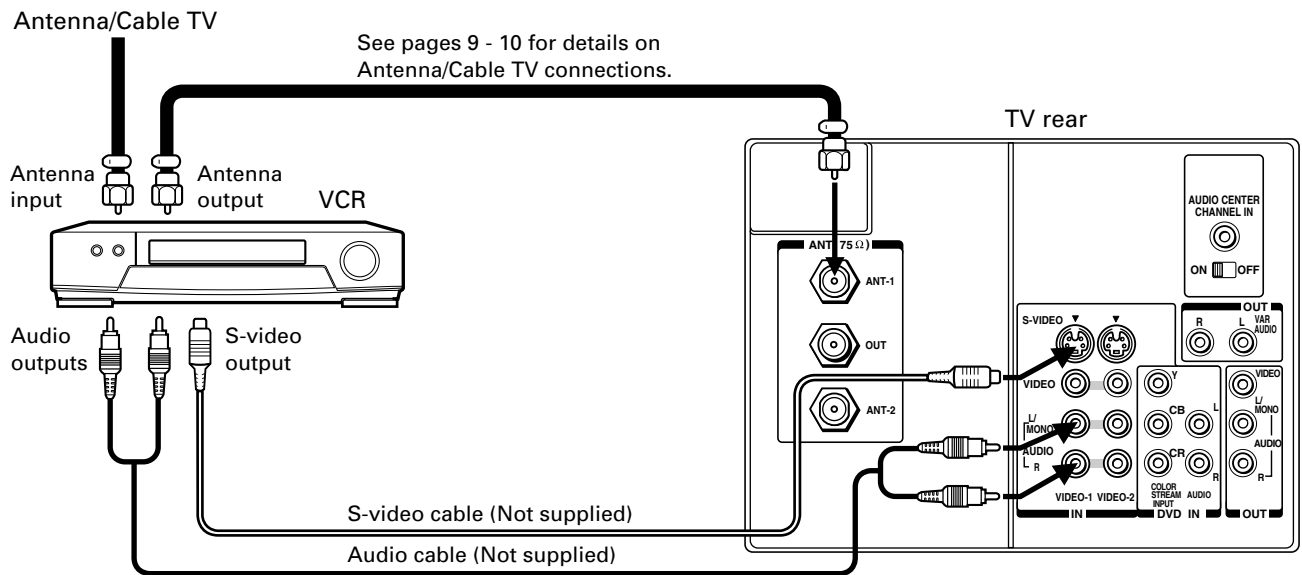

To select the video input source

- 1 Turn on the TV and the VCR.
- 2 Press **TV/VIDEO** on the Remote Control (or **ANT/VIDEO** on the TV) to select "VIDEO 1" in this example.

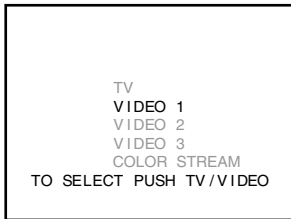

- 3 Operate your VCR normally.

Notes on the VIDEO 2 IN jacks

The VIDEO 2 IN jacks can also be used for connecting a second piece of video equipment with S-video out. To view signals from equipment connected to the VIDEO 2 IN jacks, select "VIDEO 2".

Notes:

- When the S-video cable is connected to the S-VIDEO IN jack, the video cable (phono-type) should not be connected.
- The S-VIDEO jack accepts SEPARATED Luminance/Chrominance (Y/C) signals conforming to the NTSC standard.

To dub/edit video tapes using two VCRs

To connect equipment for dubbing/editing

- 1 Connect the output jacks of the playback VCR to the input jacks (VIDEO 1, VIDEO 2 or VIDEO 3) on the TV.
- 2 Connect the output jacks (VIDEO/AUDIO OUT) on the TV to the input jacks of the recording VCR.

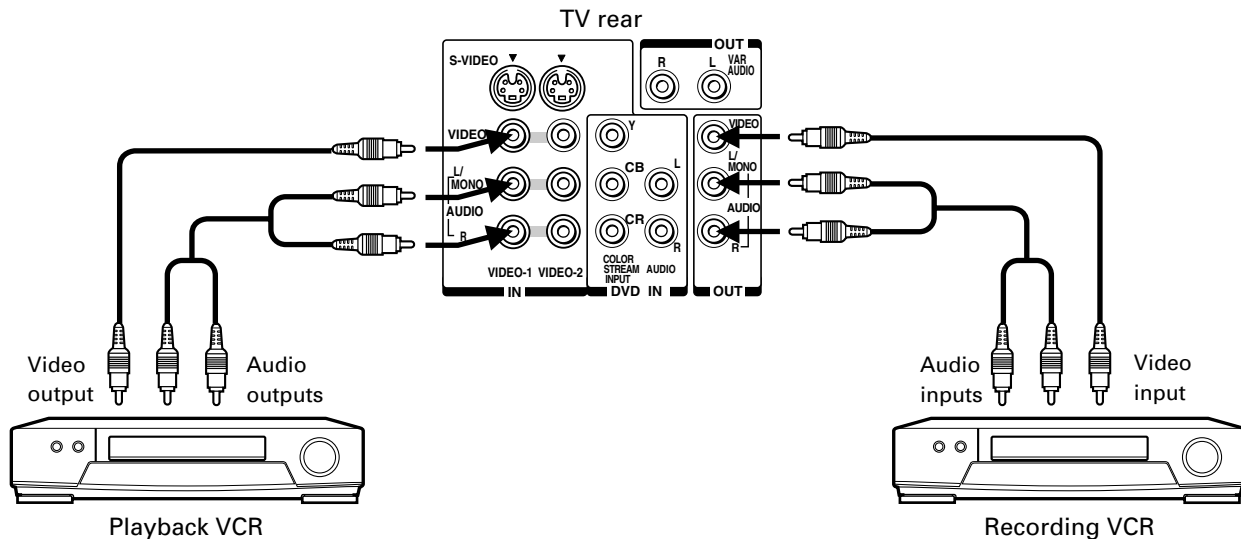

Note:

Do not connect one VCR to the output and input jacks on the TV at the same time.

To monitor dubbing/editing

- 1 Turn on the TV and both VCRs.
- 2 Press **TV/VIDEO** on the Remote Control (or **ANT/VIDEO** on the TV) to select the input source of the playback VCR.
- 3 Set the recording VCR to record mode and the playback VCR to play.
- 4 You can view the video signal from the playback VCR on the TV screen while dubbing it onto the recording VCR.

CAUTION:

The unauthorized recording of television programs, video tapes and other materials may infringe upon the provisions of the copyright laws.

Notes:

- The input switch of the VCR is normally in the TV position. Change the switch of the recording VCR to the LINE or CAMERA position when using the video/audio inputs of the VCR as above. Some VCRs automatically switch when cables are plugged into the video/audio inputs.
- The PIP picture cannot be output through the VIDEO OUTPUT.

Connecting External Equipment (continued)

To connect a DVD video player with ColorStream™ (Color Difference) VIDEO OUTPUT

This connection allows you to view pictures from a DVD video player, an advanced video/audio device.

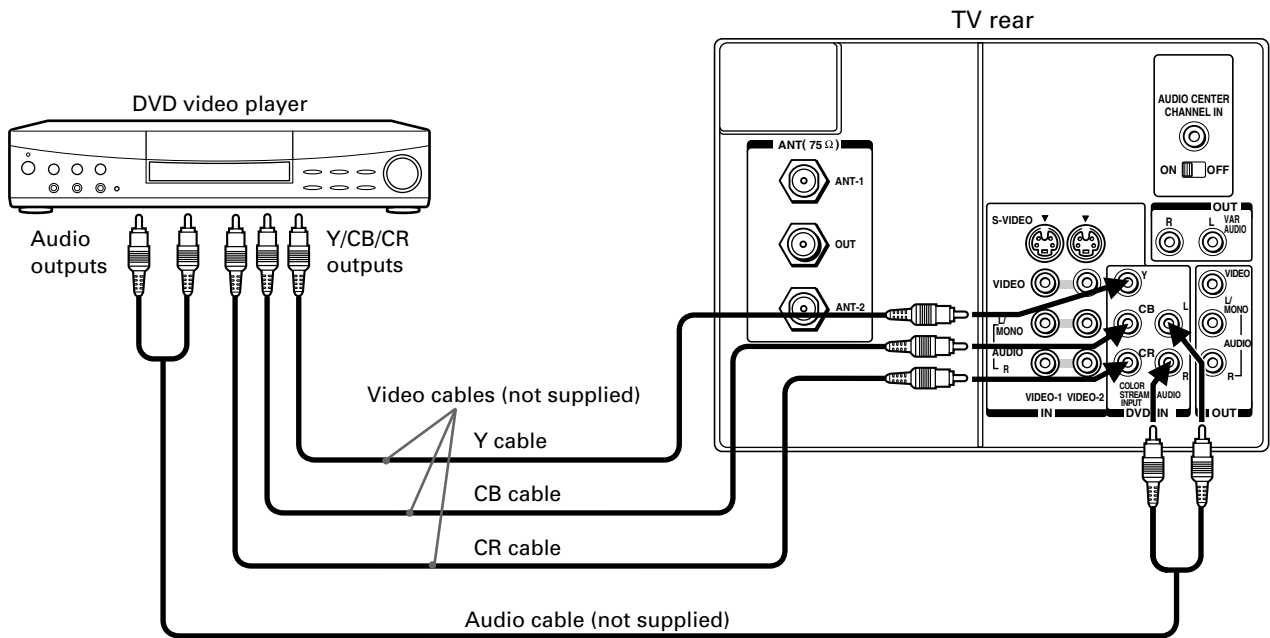

To select the video input source

- 1 Turn on the TV and the DVD video player.
- 2 Press **TV/VIDEO** on the Remote Control (or **ANT/VIDEO** on the TV) to select "COLOR STREAM".

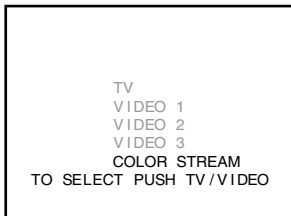

- 3 Operate your DVD video player normally.

Note:

While the PIP or Multi-Window is on the screen, "COLOR STREAM" will be skipped.

When the Color Stream input is selected, the VIDEO OUT signal will not have color. To receive a color VIDEO OUT signal, A VIDEO or S-VIDEO input must be used instead of the Color Stream connection.

To connect a video camera

This connection allows you to view pictures from a video camera. Connect the audio/video cable to the IN-VIDEO 3 jacks.

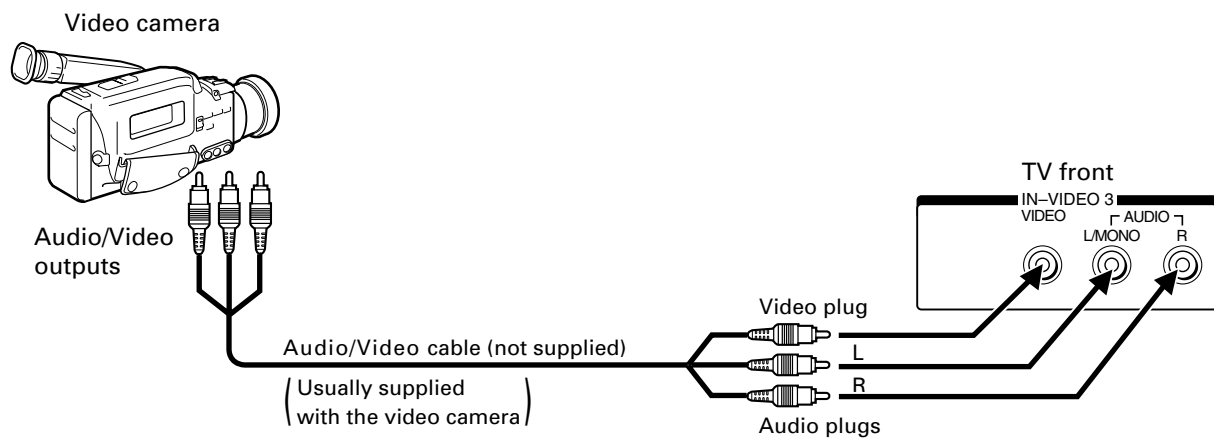

To select the video input source

To operate your video camera properly, see the instructions supplied with the connected video camera.

- 1 Turn on the TV and the video camera.
- 2 Press **TV/VIDEO** on the Remote Control (or **ANT/VIDEO** on the TV) to select "VIDEO 3."

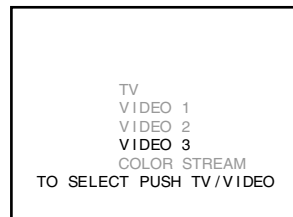

- 3 Operate your video camera normally.

Notes:

- If you connect a monaural video camera, connect the audio output to the L/MONO jack.
- If you have a video camera with an S-video jack, the VIDEO 1 or VIDEO 2 IN jacks at the rear of the TV can also be used.

Connecting External Equipment (continued)

To connect an audio amplifier

Connect the VARIABLE AUDIO OUT jacks to the auxiliary input jacks on the stereo amplifier. You can control the audio signal going to the audio equipment using the Remote Control for this TV.

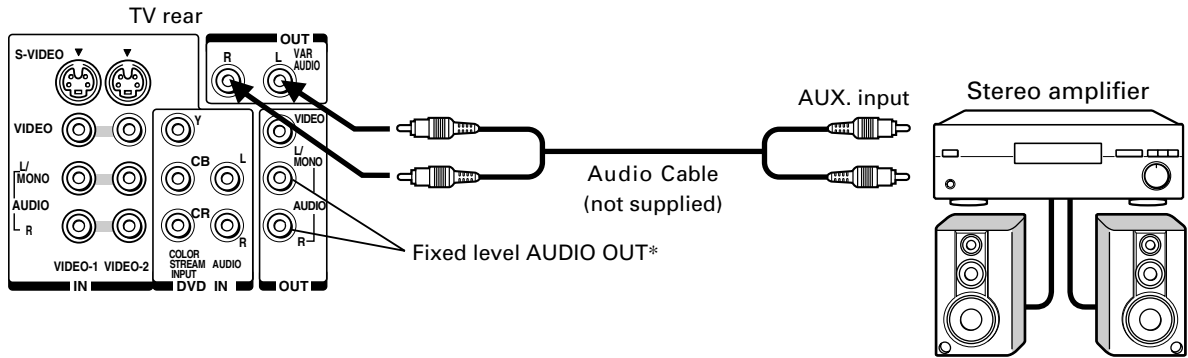

* The "fixed level" AUDIO OUT jacks are also available for connecting to an audio cassette recorder (or amplifier) to record audio from the TV. This constant audio signal is not affected by pressing the VOLUME buttons on the TV or the TV's Remote Control.

To turn off the built-in speakers

- 1 Press **MENU**, then press **◀** or **▶** until the AUDIO menu appears.

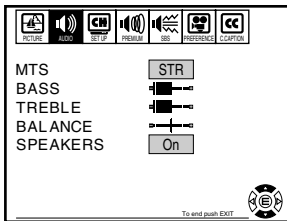

- 2 Press **▲** or **▼** until "SPEAKERS" is highlighted.

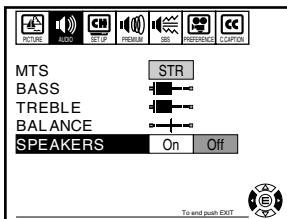

- 3 Press **◀** or **▶** to select "Off."

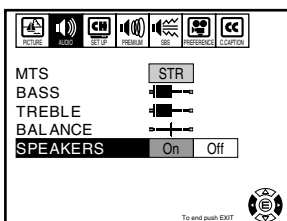

To turn on the built-in speakers
Select "On" in step 3.

Note:
Make sure the volume control of your stereo amplifier is set to a moderate listening level.

- If you use a system that delivers Dolby Pro Logic* surround sound, you will probably want to use the TV speakers as center channel speakers. A center channel speaker adds to the realism of a surround sound system such as Dolby Pro Logic.

To connect an A/V receiver

CAUTION

Make sure the TV is turned off before connecting or disconnecting an audio cable to the AUDIO CENTER CHANNEL IN jack.

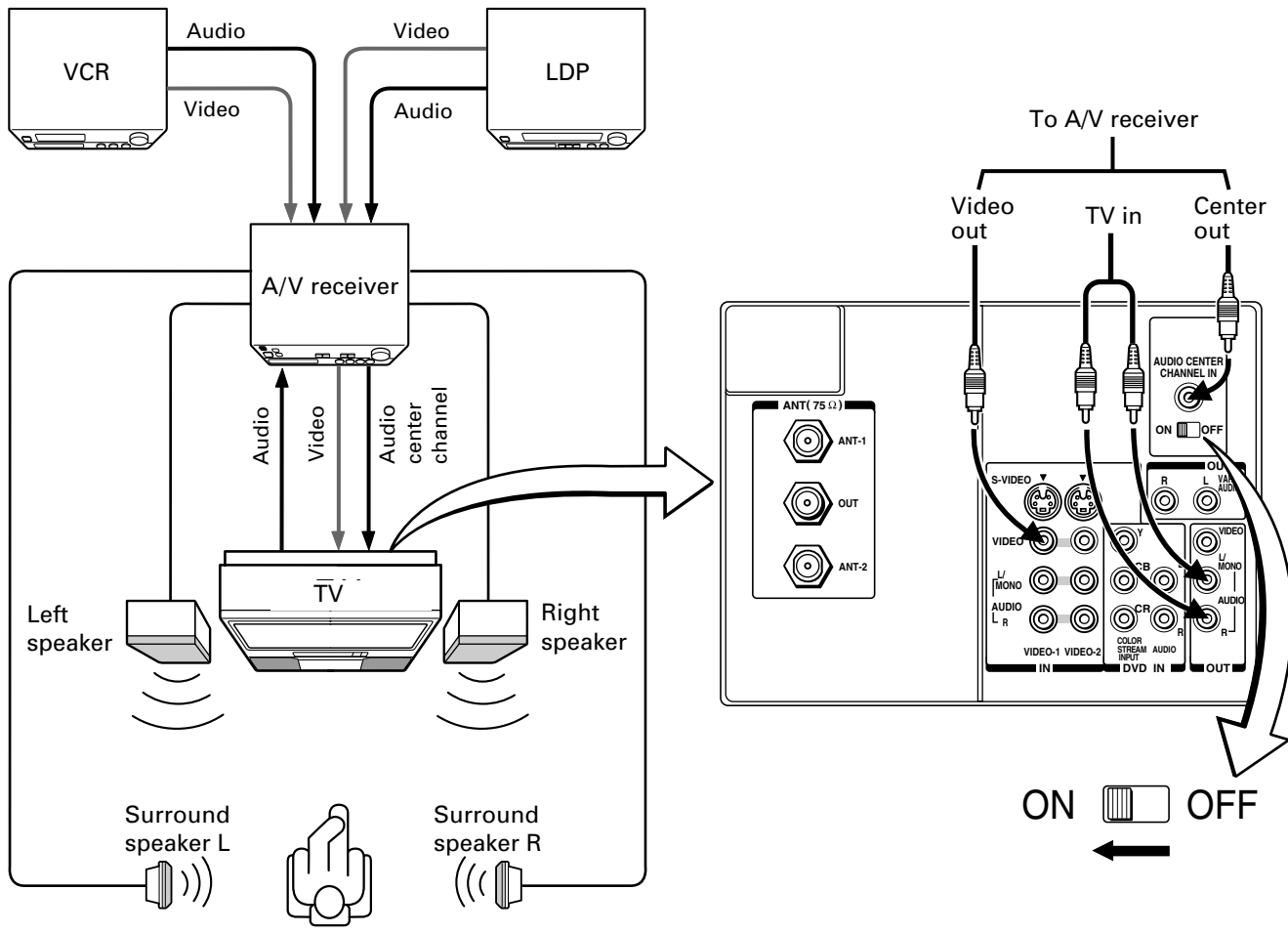

Notes:

- Refer to the instructions furnished with the connected equipment.
- When the AUDIO CENTER CHANNEL ON/OFF switch is in the "ON" position, the TV speakers will function only as the center channel speakers.
- Adjust the volume for center channel speakers with the center level control on the A/V receiver.
- If you use the TV speakers as normal speakers, set the AUDIO CENTER CHANNEL ON/OFF switch to the "OFF" position.
- * "Dolby Pro Logic" is a trademark of Dolby Laboratories Licensing Corporation.

Specifications

TELEVISION SYSTEM	NTSC standard
CHANNEL COVERAGE	VHF: 2 through 13 UHF: 14 through 69 Cable TV: Mid band (A-8 through A-1, A through I) Super band (J through W) Hyper band (AA through ZZ, AAA, BBB) Ultra band (65 through 94, 100 through 125)
POWER SOURCE	120 V AC, 60 Hz
POWER CONSUMPTION	TP50H60: 178 W TP55H60: 180 W TP61H60: 180 W
AUDIO POWER	14 W + 14 W
SPEAKER TYPE	Two 6-1/4 inches (16 cm) round
VIDEO/AUDIO TERMINALS	S-VIDEO INPUT (VIDEO 1/VIDEO 2) Y-INPUT: 1 V(p-p), 75 ohm, negative sync. C-INPUT: 0.286 V(p-p) (burst signal), 75 ohm VIDEO 1/VIDEO 2/VIDEO 3 INPUT VIDEO: 1 V(p-p), 75 ohm, negative sync. AUDIO: 150 mV(rms) (30% modulation equivalent, 47 kohm) ColorStream™ (Color Difference) VIDEO/AUDIO INPUT Y-INPUT: 1V(p-p), 75 ohm Cr-INPUT: 0.7 V(p-p), 75 ohm Cb-INPUT: 0.7 V(p-p), 75 ohm AUDIO: 150 mV(rms), 47 kohm VIDEO/AUDIO OUTPUT VIDEO: 1 V(p-p), 75 ohm, negative sync. AUDIO: 150 mV(rms) (30% modulation equivalent, 4.7 kohm) VARIABLE AUDIO OUTPUT 0–350 mV(rms) (30% modulation equivalent, 4.7 kohm) AUDIO CENTER CHANNEL INPUT 1 V(rms) (30% modulation equivalent, 10 kohm)

DIMENSIONS/MASS

	Dimension (W/H/D)	Mass
TP50H60	42-3/4 × 50-1/4 × 20-13/16 inches (1,086 × 1,276 × 529 mm)	217 lbs (98.4 kg)
TP55H60	46-3/4 × 53-9/16 × 22-7/16 inches (1,188 × 1,360 × 570 mm)	250 lbs (113 kg)
TP61H60	51-9/16 × 57-3/16 × 25-1/4 inches (1,310 × 1,452 × 641 mm)	288 lbs (131 kg)

SUPPLIED ACCESSORIES Remote Control with 2 size “AA” alkaline batteries

Design and specifications are subject to change without notice.

Before Calling Service Personnel

- Before calling service personnel, please check the following chart for the possible cause of the problem you are experiencing.

Symptom	Solutions	Pages
The TV does not turn on.	<ul style="list-style-type: none"> • Make sure power cord is plugged in, then press POWER. • Check the batteries in the Remote Control. If the batteries are dead, replace them with new ones. 	20 13
No picture, no sound	<ul style="list-style-type: none"> • Check the antenna/cable connections. 	7
No sound, picture OK	<ul style="list-style-type: none"> • Maybe the sound is muted. Press VOLUME ▲. • Maybe there is station trouble. Try another channel. • Check that the SPEAKERS function in AUDIO menu is properly set. 	26 58
Poor sound, picture OK	<ul style="list-style-type: none"> • Maybe there is station trouble or local interference from an appliance. Try another channel. 	
Poor picture, sound OK	<ul style="list-style-type: none"> • Check the antenna/cable connections. • Maybe there is station trouble or local interference. Try another channel. • Adjust the picture quality. 	28
Poor reception of broadcast channels	<ul style="list-style-type: none"> • Try another channel. • Check the antenna/cable connections. • If using a VCR, check the TV/VCR switch. 	14
Cannot receive UHF channels, VHF OK	<ul style="list-style-type: none"> • Make sure the TV/CABLE function is in "TV" mode. 	22
Black box appears on the screen.	<ul style="list-style-type: none"> • Captioning may be turned on. 	48
Cannot select a certain channel	<ul style="list-style-type: none"> • That channel may be locked out with the CH LOCK function, or erased with the ADD/ERASE function. 	40 23
Multiple images (ghosts)	<ul style="list-style-type: none"> • Maybe there is station trouble. Try another channel. • Use a highly directional outdoor antenna. 	
Poor color or no color	<ul style="list-style-type: none"> • Maybe there is station trouble or local interference. Try another channel. • Adjust TINT and/or COLOR in the PICTURE menu. 	28
No stereo or SAP sound from an MTS broadcast	<ul style="list-style-type: none"> • Check that the MTS function is properly set. 	31
The Remote Control does not operate.	<ul style="list-style-type: none"> • Check that the TV/CABLE/VCR switch is properly set. • Maybe something is between the Remote Control and the sensor. • Maybe batteries are dead. Try replacing batteries with new ones. 	12, 14 13

Limited United States Warranty

Toshiba America Consumer Products, Inc. ("TACP") and Toshiba Hawaii Inc. ("THI") make the following limited warranties. These limited warranties extend to the original consumer purchaser or any person receiving this set as a gift from the original consumer purchaser and to no other purchaser or transferee.

Limited One (1) Year Warranty

TACP and THI warrant this product and its parts against defects in materials or workmanship for a period of one (1) year after the date of original retail purchase. During this period, TACP and THI will repair a defective product or part, without charge to you. "Authorized TACP/THI service station personnel will come to your home when warranty service is required. Depending on the type of repair required, the service will either be performed in your home or the set will be taken to the authorized TACP/THI service station for repair and returned to your home at no cost to you."

Limited Two (2) Year Warranty of Picture Tube

TACP and THI further warrant the picture tube in this product against defects in materials or workmanship for a period of two (2) years after the date of original retail purchase. During this period, TACP and THI will replace a defective picture tube without charge (1) year from the date of the original retail purchase, you pay labor charges involved in the replacement.

Rental Units

The warranty for rental units begins with the first rental or thirty (30) days from the date of shipment to the rental firm, whichever comes first.

Commercial Units

Products sold and used for commercial use have a limited ninety (90) day warranty for all parts, labor and picture tube.

Owner's Manual and Demographic Card

You should read this owner's manual thoroughly before operating this product. You should complete and mail the enclosed Demographic card within ten days after you., or the person who has given you this product as a gift, purchased this product. This is one way to enable TACP/THI to provide you with better customer service and improved products. Failure to return the Demographic card will not affect your rights under this warranty.

Your Responsibility

The above warranties are subject to the following conditions;

- (1) You must retain your bill of sale or provide other proof of purchase.
- (2) All warranty servicing of this product must be made by an Authorized TACP/THI Service Station.
- (3) **These warranties are effective only if the product is purchased and operated in the U.S.A. or Puerto Rico.**
- (4) Labor service charges for set installation, set up, adjustment of customer controls and installation or repair of antenna systems are not covered by this warranty. Reception problems caused by inadequate antenna systems are your responsibility.
- (5) Warrant extend only to defects in materials or workmanship as limited above and do not extend to any product or parts which have been lost or discarded by you or to damage to products or parts caused by misuse, accident, damage caused by Acts of God, such as lightning or fluctuations in electric power, improper installation, improper maintenance or use in violation of instructions furnished by us; or to units which have had the serial number removed, altered, defaced or rendered illegible.

How to Obtain Warranty Service

If after following all of the operating instructions in this manual and checking the section "BEFORE CALLING SERVICE PERSONNEL," you find that service is needed;

- (1) Call the TACP toll free number 1-800-631-3811 after you find a defective product or part to find the nearest TOSHIBA Authorized Service Station.
- (2) Please present your bill of sale or other proof to the Authorized Service Station. "Authorized TACP/THI service station personnel will come to your home when warranty service is required. Depending on the type of repair required, the service will either be performed in your home or the set will be taken to the TACP/THI Authorized service station for repair and returned to your home at no cost to you."

In the Continental United States call:



HAWAII

327 Kamakee Street, Honolulu, HI 96814 (808) 521-5377

All warranties implied by state law, including the implied warranties of merchantability and fitness for a particular purpose, are expressly limited to the duration of the limited warranties set forth above. With the exception of any warranties implied by state law as hereby limited, the foregoing warranty is exclusive and in lieu of all other warranties, guarantees, agreements and similar obligations of manufacturer or seller with respect to the repair or replacement of any parts. In no event shall TACP or THI be liable for consequential or incidental damages.

No person, agent, distributor, dealer or company is authorized to change, modify or extend the terms of these warranties in any manner whatsoever. The time within which action must be commenced to enforce any obligation of TACP or THI arising under this warranty or under any state, or law of the United States or any state thereof, is hereby limited to 90 days from the date you discover or should have discovered, the defect. This limitation does not apply to implied warranties arising under state law.

This warranty gives you specific legal rights and you may also have other rights which may vary from state to state. Some states do not allow limitation on how long an implied warranty lasts, when an action may be brought, or the exclusion or limitation of incidental or consequential damages, so the above provisions may not apply to you.



ATTENTION CANADIAN CONSUMERS:

Canadian consumers are requested to complete the special Canadian "Warranty Registration Form" enclosed, and forward this completed form with a copy of bill of sale to TOSHIBA OF CANADA to "Register and Validate" their warranty.

Products purchased in the U.S.A. and used in Canada are not covered by these warranties.
Products Purchased in Canada and used in the U.S.A. are not covered by these warranties.

TOSHIBA AMERICA CONSUMER PRODUCTS, INC.

HEAD OFFICE/82 TOTOWA ROAD, WAYNE, NEW JERSEY 07470

FACTORY SERVICE CENTERS/NORTHEAST: 82 TOTOWA ROAD, WAYNE, NEW JERSEY 07470

MIDWEST: 1010 JOHNSON DRIVE, BUFFALO GROVE, ILLINOIS 60089-6900

WEST: 5490 E. FRANCIS ST., ONTARIO, CA 91761

SOUTHWEST: 1421 CHAMPION DRIVE, SUITE 304 CARROLLTON, TEXAS 75006

SOUTHEAST: 6115 JIMMY CARTER BLVD., SUITE C2, NORCROSS, GA 30071-4607

TOSHIBA HAWAII, INC.

HEAD OFFICE/327 KAMAKEE STREET, HONOLULU, HAWAII 96814, U.S.A. TEL: (808) 521-5377

TOSHIBA OF CANADA LTD.

HEAD OFFICE/191 McNABB STREET MARKHAM, ONTARIO L3R 8H2, CANADA TEL: (905) 470-5400

SERVICE CENTERS/TORONTO: 191 McNABB STREET MARKHAM, ONTARIO L3R 8H2, CANADA TEL: (905) 470-5400

MONTREAL: 1643, NORTH SERVICE RD., TRANS-CANADA HIGHWAY, DORVAL QUEBEC, H9P 1J1, CANADA

TEL: (514) 856-4100

VANCOUVER: 22171 FRASERWOOD WAY, RICHMOND, B.C. V6W 1J5, CANADA TEL: (604) 303-2500

MANUFACTURED BY

TOSHIBA AMERICA CONSUMER PRODUCTS, INC.

PRINTED IN USA
(98-05)

TOSHIBA

23563344

Free Manuals Download Website

<http://myh66.com>

<http://usermanuals.us>

<http://www.somanuals.com>

<http://www.4manuals.cc>

<http://www.manual-lib.com>

<http://www.404manual.com>

<http://www.luxmanual.com>

<http://aubethermostatmanual.com>

Golf course search by state

<http://golfingnear.com>

Email search by domain

<http://emailbydomain.com>

Auto manuals search

<http://auto.somanuals.com>

TV manuals search

<http://tv.somanuals.com>