

TOSHIBA

MULTIFUNCTIONAL DIGITAL COLOR SYSTEMS

Scanning Guide

e-STUDIO281c/351c/451c

SOFTWARE LICENSE AGREEMENT

INSTALLING OR OTHERWISE USING THIS SOFTWARE PRODUCT CONSTITUTES YOUR ACCEPTANCE OF THE FOLLOWING TERMS AND CONDITIONS (UNLESS A SEPARATE LICENSE IS PROVIDED BY THE SUPPLIER OF APPLICABLE SOFTWARE IN WHICH CASE SUCH SEPARATE LICENSE SHALL APPLY). IF YOU DO NOT ACCEPT THESE TERMS, YOU MAY NOT INSTALL OR USE THIS SOFTWARE, AND YOU MUST PROMPTLY RETURN THE SOFTWARE TO THE LOCATION WHERE YOU OBTAINED IT.

THE SOFTWARE INSTALLED ON THIS PRODUCT INCLUDES NUMEROUS INDIVIDUAL SOFTWARE COMPONENTS, EACH HAVING ITS OWN APPLICABLE END USER LICENSE AGREEMENT ("EULA"). INFORMATION RELATING TO THE EULAS MAY BE FOUND IN AN ELECTRONIC FILE INCLUDED ON THE USER DOCUMENTATION CD-ROM INCLUDED HEREWITH; HOWEVER, ALL SOFTWARE AND DOCUMENTATION DEVELOPED OR CREATED BY OR FOR TOSHIBA TEC CORPORATION ("TTEC") ARE PROPRIETARY PRODUCTS OF TTEC AND ARE PROTECTED BY COPYRIGHT LAWS, INTERNATIONAL TREATY PROVISIONS, AND OTHER APPLICABLE LAWS.

Grant of License

This is a legal agreement between you, the end-user ("You"), and TTEC and its suppliers. This software, fonts (including their typefaces) and related documentation ("Software") is licensed for use with the system CPU on which it was installed ("System") in accordance with the terms contained in this Agreement. This Software is proprietary to TTEC and/or its suppliers.

TTEC and its suppliers disclaim responsibility for the installation and/or use of this Software, and for the results obtained by using this Software. You may use one copy of the Software as installed on a single System, and may not copy the Software for any reason except as necessary to use the Software on a single System. Any copies of the Software shall be subject to the conditions of this Agreement.

You may not, nor cause or permit any third party to, modify, adapt, merge, translate, reverse compile, reverse assemble, or reverse engineer the Software. You may not use the Software, except in accordance with this license. No title to the intellectual property in the Software is transferred to you and full ownership is retained by TTEC or its suppliers. Source code of the Software is not licensed to you. You will be held legally responsible for any copyright infringement, unauthorized transfer, reproduction or use of the Software or its documentation.

Term

This license is effective until terminated by TTEC or upon your failure to comply with any term of this Agreement. Upon termination, you agree to destroy all copies of the Software and its documentation.

You may terminate this license at any time by destroying the Software and its documentation and all copies.

Disclaimer of Warranty

THIS SOFTWARE IS PROVIDED "AS IS" WITHOUT WARRANTY OF ANY KIND, EITHER EXPRESS OR IMPLIED, INCLUDING, BUT NOT LIMITED TO, THE IMPLIED WARRANTIES OF MERCHANTABILITY, FITNESS FOR A PARTICULAR PURPOSE, TITLE, AND NON-INFRINGEMENT. TTEC AND ITS SUPPLIERS DISCLAIM ANY WARRANTY RELATING TO THE QUALITY AND PERFORMANCE OF THE SOFTWARE. IF THE SOFTWARE PROVES DEFECTIVE, YOU (AND NOT TTEC OR ITS SUPPLIERS) SHALL BE RESPONSIBLE FOR THE ENTIRE COST OF ALL NECESSARY SERVICING, REPAIR OR CORRECTION. TTEC AND ITS SUPPLIERS DO NOT WARRANT THAT THE FUNCTIONS CONTAINED IN THE SOFTWARE WILL MEET YOUR REQUIREMENTS OR THAT THE OPERATION OF THE SOFTWARE WILL BE UNINTERRUPTED OR ERROR FREE.

ALL INFORMATION CONTAINED HEREIN THAT IS PROVIDED BY TTEC AND ITS AFFILIATES PURSUANT TO A EULA IS PROVIDED "AS IS" WITHOUT WARRANTY OF ANY KIND, EITHER EXPRESS OR IMPLIED.

Limitation of Liability

IN NO EVENT WILL TTEC OR ITS SUPPLIERS BE LIABLE TO YOU FOR ANY DAMAGES, WHETHER IN CONTRACT, TORT, OR OTHERWISE (EXCEPT PERSONAL INJURY OR DEATH RESULTING FROM NEGLIGENCE ON THE PART OF TTEC OR ITS SUPPLIERS), INCLUDING WITHOUT LIMITATION ANY LOST PROFITS, LOST DATA, LOST SAVINGS OR OTHER INCIDENTAL, SPECIAL OR CONSEQUENTIAL DAMAGES ARISING OUT OF THE USE OR INABILITY TO USE THE SOFTWARE, EVEN IF TTEC OR ITS SUPPLIERS HAVE BEEN ADVISED OF THE POSSIBILITY OF SUCH DAMAGES, NOR FOR THIRD PARTY CLAIMS.

U.S. Government Restricted Rights

The Software is provided with RESTRICTED RIGHTS. Use, duplication or disclosure by the U.S. Government is subject to restrictions set forth in subdivision (b) (3) (ii) or (c) (i) (ii) of the Rights in Technical Data and Computer Software Clause set forth in 252.227-7013, or 52.227-19 (c) (2) of the DOD FAR, as appropriate. Contractor/Manufacturer is TOSHIBA TEC Corporation, 6-78, Minami-cho, Mishima-shi, Shizuoka-ken, 411-8520, Japan.

General

You may not sublicense, lease, rent, assign or transfer this license or the Software. Any attempt to sublicense, lease, rent, assign or transfer any of the rights, duties or obligations hereunder is void. You agree that you do not intend to, and will not ship, transmit (directly or indirectly) the Software, including any copies of the Software, or any technical data contained in the Software or its media, or any direct product thereof, to any country or destination prohibited by the United States Government. This license shall be governed by the laws of Japan or, at the election of a Supplier of TTEC concerned with a dispute arising from or relating to this Agreement, the laws of the Country designated from time to time by the relevant Supplier of TTEC. If any provision or portion of this Agreement shall be found to be illegal, invalid or unenforceable, the remaining provisions or portions shall remain in full force and effect.

YOU ACKNOWLEDGE THAT YOU HAVE READ THIS LICENSE AGREEMENT AND THAT YOU UNDERSTAND ITS PROVISIONS. YOU AGREE TO BE BOUND BY ITS TERMS AND CONDITIONS. YOU FURTHER AGREE THAT THIS LICENSE AGREEMENT CONTAINS THE COMPLETE AND EXCLUSIVE AGREEMENT BETWEEN YOU AND TTEC AND ITS SUPPLIERS AND SUPERSEDES ANY PROPOSAL OR PRIOR AGREEMENT, ORAL OR WRITTEN, OR ANY OTHER COMMUNICATION RELATING TO THE SUBJECT MATTER OF THIS LICENSE AGREEMENT.

TOSHIBA TEC Corporation, 6-78, Minami-cho, Mishima-shi, Shizuoka-ken, 411-8520, Japan.

TRADEMARKS AND COPYRIGHT

Trademarks

- The official name of Windows 98 is Microsoft Windows 98 Operating System.
- The official name of Windows Me is Microsoft Windows Me Operating System.
- The official name of Windows 2000 is Microsoft Windows 2000 Operating System.
- The official name of Windows XP is Microsoft Windows XP Operating System.
- The official name of Windows Server 2003 is Microsoft Windows Server 2003 Operating System.
- Microsoft, Windows, Windows NT, and the brand names and product names of other Microsoft products are trademarks of Microsoft Corporation in the US and other countries.
- Apple, AppleTalk, Macintosh, Mac, TrueType, and LaserWriter are trademarks of Apple Computer, Inc. in the US and other countries.
- Postscript is a trademark of Adobe Systems Incorporated.
- Netscape is a trademark of Netscape Communications Corporation.
- IBM, AT and AIX are trademarks of International Business Machines Corporation.
- NOVELL, NetWare, and NDS are trademarks of Novell, Inc.
- Other company names and product names in this manual are the trademarks of their respective companies.

Copyright

© 2005 TOSHIBA TEC CORPORATION All rights reserved

Under the copyright laws, this manual cannot be reproduced in any form without prior written permission of TTEC. No patent liability is assumed, however, with respect to the use of the information contained herein.

Preface

Thank you for purchasing e-STUDIO451c Series Multifunctional Digital Color Systems. This guide provides instructions on how to scan the originals using the equipment. Read this guide before scanning on your e-STUDIO451c Series. Keep this guide within easy reach, and use it to configure an environment that makes best of the e-STUDIO's functions.

About This Guide

This manual describes how to scan the originals using the equipment.

Conventions

- The term “this equipment” in this manual refers to the e-STUDIO451c Series.
- The term “e-Filing” in this manual is an abbreviation of “electronic filing”.

About Other Manuals

Other guides are included in the User Documentation CD-ROM provided with this system:

Printing Guide—explains how to install user software for the printer functions, including how to set up and manage print jobs from Microsoft Windows, Apple Mac OS, and UNIX computers.

TopAccess Guide—explains how to set up and manage network functions using the TopAccess user functions — such as network job management and template registration — from client computers via a network.

Network Administration Guide— explains the basic configuration and administration of the equipment in supported platform and network environments. It also includes guidelines for setting up network servers to provide various network services.

e-Filing Guide—explains how to operate the e-Filing features by using the TWAIN driver, File Downloader and e-Filing web utility.

Network Fax Guide—explains how to use the network fax features that enable users to operate fax and internet fax sending from a client computer via network.

Table of Contents

SOFTWARE LICENSE AGREEMENT	2
TRADEMARKS AND COPYRIGHT	4
Preface	5
About This Guide.....	5
Conventions	5
About Other Manuals.....	5
Table of Contents	7
1. Overview.....	9
About Scan Mode	10
Scan to e-Filing Mode.....	10
Scan to File Mode.....	10
Scan to E-mail Mode	11
How to Perform Scan Operations.....	12
Confirming the Scan Job Status	18
Confirming the Scan Log	19
2. Scan to e-Filing	21
How to Perform Scan to e-Filing.....	22
How to Use Scanned Data Stored in e-Filing	28
Using Scanned Data in e-Filing from Touch Panel Display.....	28
Using Scanned Data in e-Filing from e-Filing Web Utility.....	28
3. Scan to File.....	29
How to Perform Scan to File.....	30
How to Use Scanned Data Stored as Files	37
When Scanned Data Is Stored in MFP LOCAL.....	37
When Scanned Data Is Stored in REMOTE 1 or 2.....	37
4. Scan to E-mail	39
How to Perform Scan to E-mail	40
Specifying Destinations	46
5. Using Template	59
Scanning Using Template	60
Registering Scan Template	68
6. Copy & File	77
How to Perform Copy & File	78
7. Internet Fax	83
About Internet Fax.....	84
Precaution for Internet Transmission.....	84
Internet Fax Transmission Overview	84
How to Perform Internet Fax	86
Specifying Destinations	88
Advanced Function.....	98
Sending 2-sided Originals	98
Priority Transmission.....	100
Receiving Internet Fax.....	101
INDEX	103

1

OVERVIEW

This section describes the overview of the scan functions.

- **About Scan Mode**..... 10
- **How to Perform Scan Operations**..... 12
- **Confirming the Scan Job Status**..... 18
- **Confirming the Scan Log** 19

About Scan Mode

If the scanning function is used, originals set on the reversing automatic document feeder or on the original glass can easily be scanned as image data. Then this equipment can save scanned images into e-Filing or shared folder in the equipment. This equipment also can send scanned images to e-mail addresses. This equipment supports three scan modes, Scan to e-Filing, Scan to -File, and Scan to E-mail.

Scan to e-Filing Mode

Scan to e-Filing mode allows users to store scanned images as e-Filing documents in the equipment. Once users store the scanned images as e-Filing documents, the documents can be managed by creating boxes and folders. Users can work with e-Filing documents such as printing them, merging them to create a new document, and so on, using the e-Filing web utility. The e-Filing documents also can be retrieved into user's computer using TWAIN driver or File Downloader. In the e-Filing boxes, up to 10 GB of data can be stored.

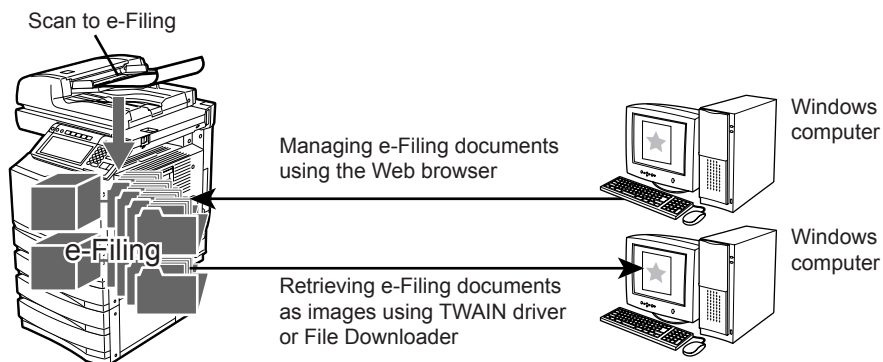

For instructions on how to perform Scan to e-Filing, see the following section.
 P.21 "Scan to e-Filing"

SUPPLEMENT: For more information about e-Filing, please see **e-Filing Guide**.

Scan to File Mode

Scan to File mode allows users to save scanned images as PDF, TIFF, or JPEG files either the shared folder in the equipment, or network folder in another computer. Users can use saved files by copying them from the folder where users save the scanned images. In the shared folder in the equipment, up to 5 GB of data can be stored.

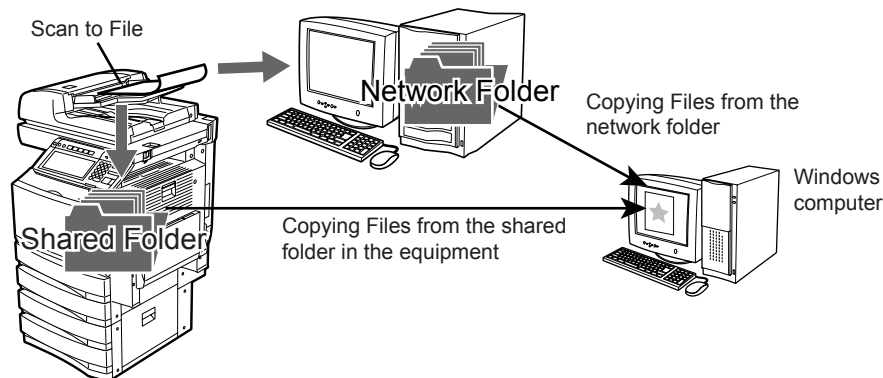

For instructions on how to perform Scan to File, see the following section.

📖 P.29 "Scan to File"

SUPPLEMENT: The Copy & File function, which enables users to copy and store as file at the same time, also will be available. For instruction on how to perform Copy & File, see the following section.

📖 P.77 "Copy & File"

Scan to E-mail Mode

Scan to E-mail mode allows users to send scanned images to specified e-mail addresses. When users perform Scan to E-mail, the scanned image will be converted to a PDF, TIFF, or JPEG file and send them as an attached file of the E-mail message.

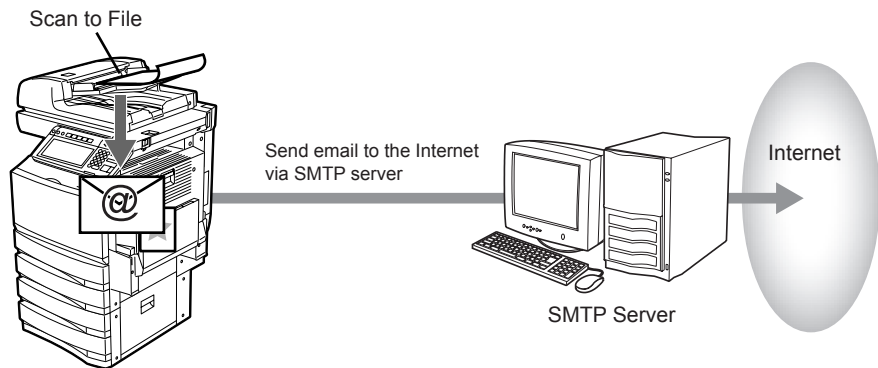

For instructions on how to perform Scan to E-mail, see the following section.

📖 P.39 "Scan to E-mail"

How to Perform Scan Operations

Users can scan originals not only by selecting one of the scan modes, but also by combining two scan modes at a single operation.

The following procedures describe about the basic instructions on how to perform the scan operations.

📖 P.12 "Scanning Procedure for Single Agent"

📖 P.14 "Scanning Procedure for Multiple Agents"

- SUPPLEMENTS:
- Users can use a template to perform a scan operation as well. For more information about a template, see the following section.
 - 📖 P.59 "Using Template"
 - Users can perform Copy & File, which enables users to copy the originals as well as storing the originals as a file. For more information about Copy & File, see the following section.
 - 📖 P.77 "Copy & File"

Scanning Procedure for Single Agent

1. Place the original(s).

- For instruction about placing the originals, see *Operator's Manual for Basic Function*.

2. Press the [SCAN] button on the control panel to enter the scan menu.

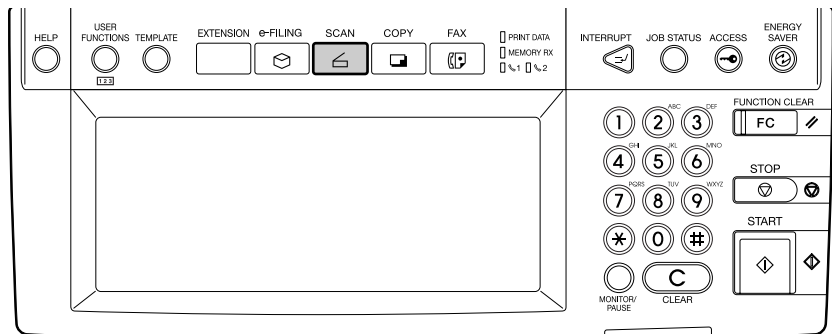

- The basic scan menu is displayed.

3. Select a button of the desired scan mode.

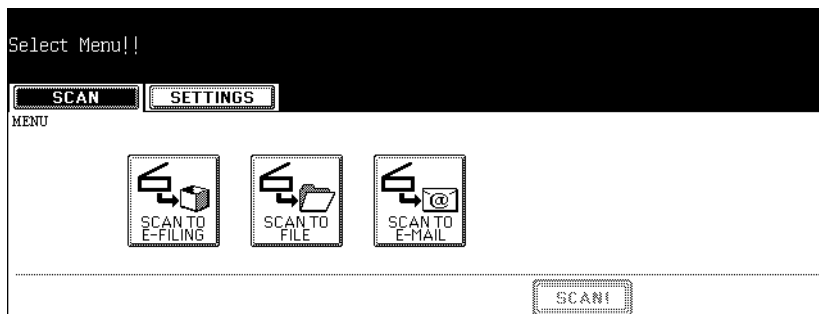

[SCAN TO E-FILING] — Press this to store the scanned images to e-Filing. When you store the scanned images to e-Filing, you can manage them using the e-Filing web utility. You can also retrieve them into your computer using TWAIN driver application or File Downloader.

[SCAN TO FILE] — Press this to save the scanned images into the shared folder in the equipment or network folder as files.

[SCAN TO E-MAIL] — Press this to send the scanned images to specified E-mail addresses.

4. Set the scanning conditions using the buttons on the touch panel and digital keys, and press the [ENTER] button to save the settings.

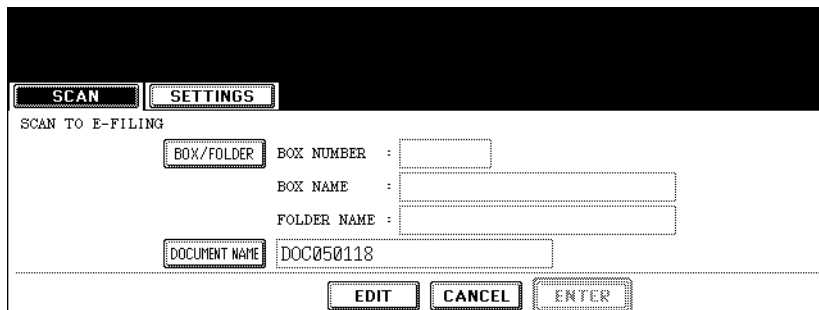

- The above screen shows the example of the SCAN TO E-FILING screen. The setting options vary depending on the scan mode that you selected. For instructions on how to set them, see the instructions for each scan mode.
 - 📖 P.22 "How to Perform Scan to e-Filing"
 - 📖 P.30 "How to Perform Scan to File"
 - 📖 P.40 "How to Perform Scan to E-mail"
- When you press the [ENTER] button, the screen returns to the basic scan menu, and the button that you set will be grayed out.

5. Press the [SCAN!] button.

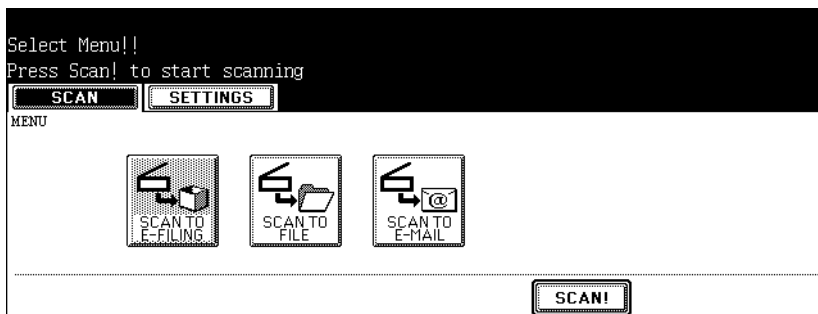

6. If the “To continue, place document on glass. And press Scan!” message is displayed, place another original on glass and press [SCAN!] to scan another original, or press the [JOB FINISH] button to finish scanning.



- When the original is set on the reversing automatic document feeder, this screen is not displayed. However, this screen is displayed when you press the [CONTINUE] button during scanning the originals.
- If you want to cancel the storage of the scanned data, press the [JOB CANCEL] button.
- You can change the setting of the original type and scanning conditions, using the [EDIT] button before pressing the [SCAN!] button.

Scanning Procedure for Multiple Agents

1. Place the original(s).

- For instruction about placing the originals, see *Operator's Manual for Basic Function*.

2. Press the [SCAN] button on the control panel to enter the scan menu.

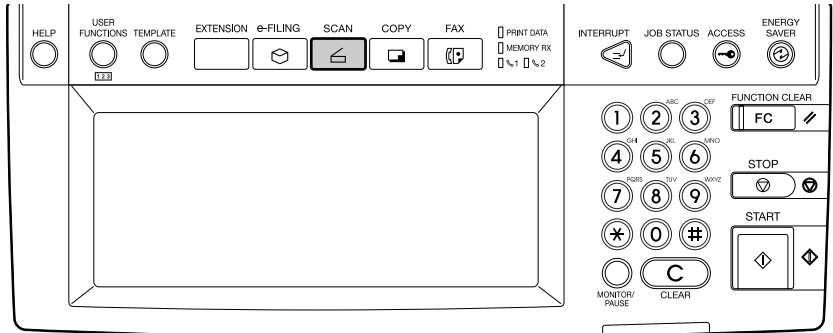

- The basic scan menu is displayed.

3. Select a button of the desired scan mode.

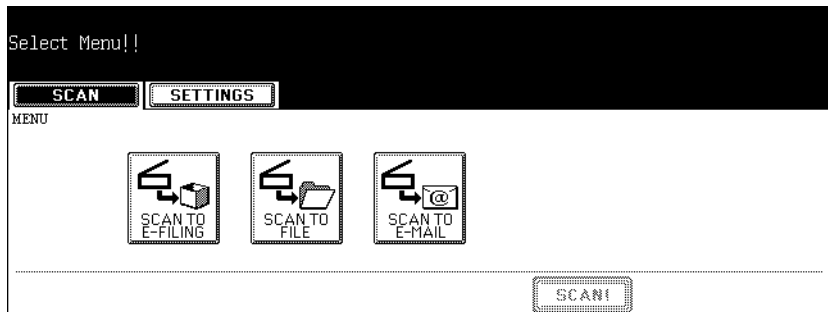

[SCAN TO E-FILING] — Press this to store the scanned images to e-Filing. When you store the scanned images to e-Filing, you can manage them using the e-Filing web utility. You can also retrieve them into your computer using TWAIN driver application or File Downloader.

[SCAN TO FILE] — Press this to save the scanned images into the shared folder in the equipment or network folder as files.

[SCAN TO E-MAIL] — Press this to send the scanned images to specified E-mail addresses.

4. Set the scanning conditions using the buttons on the touch panel and digital keys, and press the [ENTER] button to save the settings.

- The above screen shows the example of the SCAN TO E-FILING screen. The setting options vary depending on the scan mode that you selected. For instructions on how to set them, see the instructions for each scan mode.
 - 📖 P.21 "Scan to e-Filing"
 - 📖 P.29 "Scan to File"
 - 📖 P.39 "Scan to E-mail"
- When you press the [ENTER] button, the screen returns to the basic scan menu, and the button that you set will be grayed out.

5. Select the other button of the desired scan mode.

NOTE: You can set two scan modes at a single operation. You cannot set all three scan modes at a same time.

SUPPLEMENT: If you want to cancel a scan mode that you set, press the button the scan mode that you want to cancel and press the [CANCEL] button in the screen. The screen returns to the basic scan menu and the button will be unselected (not grayed out).

6. Press the [SCAN!] button.

7. If the “To continue, place document on glass. And press Scan!” message is displayed, place another original on glass and press [SCAN!] to scan another original, or press the [JOB FINISH] button to finish scanning.



- When the original is set on the reversing automatic document feeder, this screen is not displayed. However, this screen is displayed when you press the [CONTINUE] button during scanning the originals.
- If you want to cancel the storage of the scanned data, press the [JOB CANCEL] button.
- You can change the setting of the original type and scanning conditions, using the [EDIT] button before pressing the [SCAN!] button.

Confirming the Scan Job Status

SCAN JOB displays its status and enables to delete the job. 4 jobs are listed on each screen. The jobs for 250 pages (1,000 jobs) are available to display. Press the [Next] button to display the 5th job or later, and press the [Prev] button to display the previous page.

To display the scan job status screen, press the [JOB STATUS] button on the control panel and press the [SCAN] button.

SENDING E-MAIL

PRINT FAX SCAN LOG STATUS

SCAN JOB

To	Agent	Date, Time	Pages	Status
user01@ifax.com	E-mail	19,00:43	1	Process

RETURN DELETE 1/1

- Items of table**
 - To:** Display the name of the file created or the e-mail address of the recipient.
 - Agent:** Display the function used for the scan job.
 - Date, Time:** Display the date and time of the scan job.
 - Pages:** Display the number of pages scanned or sent via E-mail.
 - Status:** Display the status of jobs.
- Buttons**
 - [Delete]:** The button becomes active when the deletable job is selected. When this button is pressed, the job is deleted.

Confirming the Scan Log

SCAN LOG allows you to list the jobs that have finished being scanned to confirm the results.

To display the scan log screen, press the [JOB STATUS] button on the control panel and press the [LOG] button in the JOB STATUS screen. Then press the [SCAN] button. When pressing the [SCAN] button on the log menu, the scanning status of the following items is displayed.

- Storing status in e-Filing by copying
- Storing status in Share folder (SAVE AS FILE) by copying
- Storing status in e-Filing or Share folder (SCAN TO FILE) by scanning
- Sending status of E-mail (SCAN TO E-MAIL) by scanning
- Storing status in Share folder (SAVE AS FILE) by faxing
- Storing status in e-Filing or Share folder by Fax Received Forward
- Storing status in e-Filing or Share folder by Internet Fax Received Forward

To	Agent	Date,Time	Pages	Status
user01-0001	Store to e-Filing	18,23:58	1	OK
DOC050118	Store to e-Filing	18,23:50	1	OK
DOC050118-001.pdf	Save as File	18,04:54	10	OK
file0001-001.pdf	Save as File	18,04:50	10	OK

- **Items of list**
 - To:** Display the storing location of the scanned data or E-mail address of the recipient.
 - Agent:** Display the scanned job in the scan menu.
 - Date, Time:** Display the date and time at the time of scanning.
 - Pages:** Display the number of pages scanned or sent E-mail.
 - Status:** Display the status of job displayed with 'OK' or 'Error code'
- **Buttons**
 - [ENTRY]:** To register the E-mail address in the scanning status to the address book, press this button.
 - [RETURN]:** To return to the log menu, press this button.

SUPPLEMENT: For more information about the error code that is displayed in the Status section, see *Operator's Manual for Basic Function*.

2

SCAN TO E-FILING

This section describes the instructions on how to perform Scan to e-Filing and how to use the stored data in e-Filing.

- **How to Perform Scan to e-Filing.....22**
- **How to Use Scanned Data Stored in e-Filing.....28**

How to Perform Scan to e-Filing

In this function, the scanned original data can be stored in the e-Filing. You can scan up to 200 pages per 1 job.

In the e-Filing boxes, up to 10 GB of data can be stored.

After storing the original data, you can print it at any time from the touch panel. Also you can manage stored documents using the e-Filing web utility. Using the e-Filing web utility, you can manage stored documents by creating user boxes and folders, printing documents, and merging several documents to create a new document.

To store the original data, you can specify the public box or one of user boxes. The public box is a pre-set box since the installation of the equipment, and it will be used to store documents that any user may need to work with. The user box is the one created by the user, and, if password is set, you need to enter the password correctly.

Before storing the original data in e-Filing, you need to set up the user boxes using the touch panel or e-Filing web utility. For setting up the user boxes and printing the stored documents from the touch panel or e-Filing web utility, see ***e-Filing Guide***. (The instruction on how to set up the user boxes using the touch panel also describes in ***Operator's Manual for Basic Function***.)

NOTE: It is recommended to back up the data on the equipment's hard disk to prevent loss of data. You can back it up with the client PC using the File Downloader or e-Filing Backup/Restore Utility. See ***e-Filing Guide*** for details.

SUPPLEMENT: You can also store the copied original data in the e-Filing using the copy operation. However, when you use the original data with the client PC via network, it is recommended to store the original data using the scanning operation explained here, rather than using the copy operation because the data stored by the copy operation is proper for output, but not for importing as an image into your computer.

Scanning Procedure for Scan to e-Filing

1. Place the original(s).

- For instruction about placing the originals, see ***Operator's Manual for Basic Function***.

2. Press the [SCAN] button on the control panel to enter the scan menu.

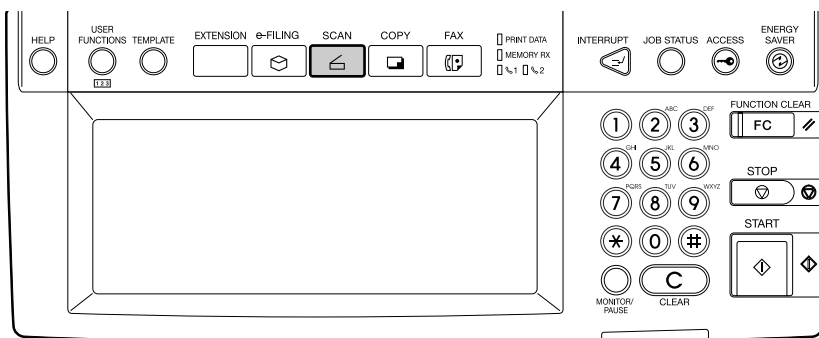

- The basic scan menu is displayed.

3. Press the [SCAN TO E-FILING] button.

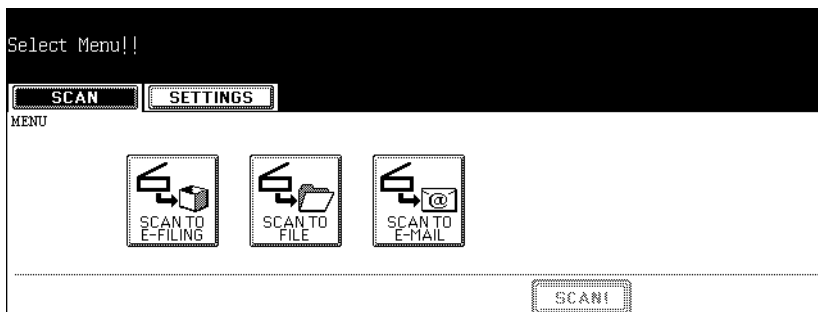

- The SCAN TO E-FILING screen is displayed.

4. Press the [BOX/FOLDER] button.

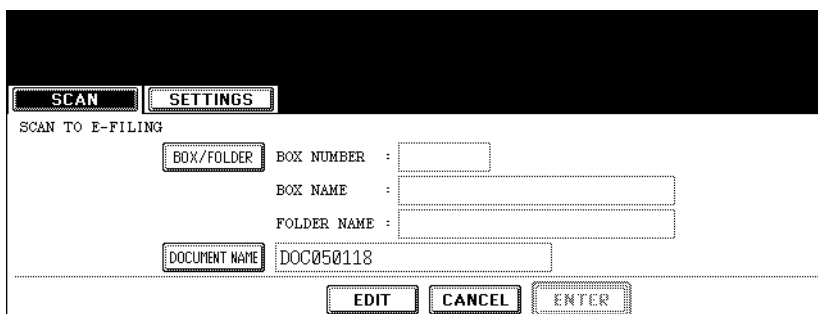

- The box list screen is displayed.

5. Select the box in which you want to store the data and press the [ENTER] button.

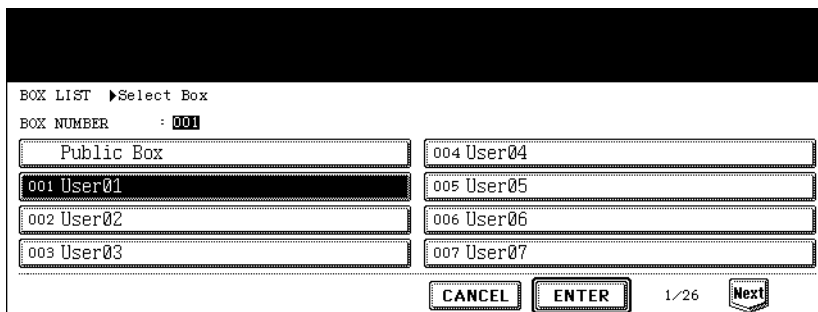

- Select either the “Public Box” button or desired user box button.
- If the user box that you want to store the data is not shown in the list, press the [Next] or [Prev] buttons to change the list on the screen.

SUPPLEMENT: If the user box that you want to store the data has not been registered, you must register the user box first. For setting up the user boxes, see *e-Filing Guide*. (The instruction on how to set up the user boxes using the touch panel also describes in *Operator’s Manual for Basic Function*.)

6. If you select a user box that a password is set, the password entry screen may be displayed. If the password entry screen is displayed, enter the password using the digital keys and press the [ENTER] button.

PASSWORD ▶ Enter Box Password
(5-digit)

BOX NUMBER : 001
BOX NAME : User01

Password : *****

CANCEL ENTER

- The list of the documents and folders for the selected box is displayed.

7. When you want to store the original(s) in an existing folder, select the folder and press the [OPEN FOLDER] button to display the list in the folder, and then press the [ENTER] button.

If you want to store the original(s) in the selected box, press the [ENTER] button.

STORE TO E-FILING ▶ Select Storage Location

Document/Folder Name	Date, Time	Paper	Pages
Folder	14.03.00		

OPEN FOLDER CANCEL ENTER 1/1

- The screen returns to the SCAN TO E-FILING screen.

8. Press the [DOCUMENT NAME] button if you want rename the document name of the scanned data.

SCAN SETTINGS

SCAN TO E-FILING

BOX/FOLDER BOX NUMBER : 001
BOX NAME : User01
FOLDER NAME : Folder
DOCUMENT NAME : DOC050118

EDIT CANCEL ENTER

- The letter entry screen is displayed. Enter the value using the keyboard and digital keys, and press the [ENTER] button to set the entry.

9. Press the [EDIT] button to set the scanning conditions.
 - The screen to set the scan conditions is displayed.
10. Specify the following items as you require, and press the [Next] button.

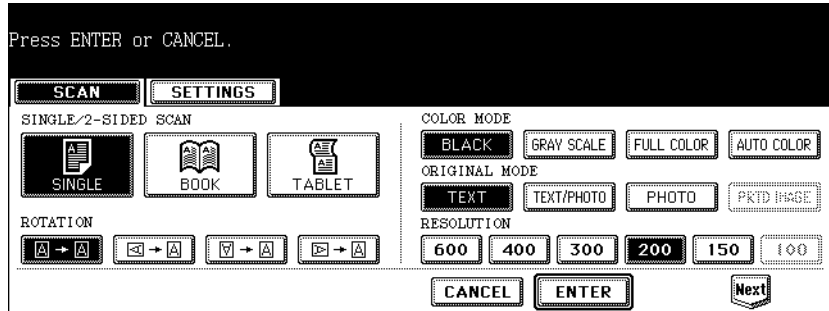

- **SINGLE/2-SIDED SCAN**
 - [SINGLE]** — Press this when scanning only the front page of originals.
 - [BOOK]** — Press this when scanning both side of originals in the same direction.
 - [TABLET]** — Press this when scanning front page in the general direction, and scanning back page rotated 180 degree.
- **ROTATION**
 - [0 degree]** — Press this not to rotate the scanned image.
 - [90 degree right]** — Press this to rotate the scanned image 90 degree on the right.
 - [180 degree]** — Press this to rotate the scanned image 180 degree.
 - [90 degree left]** — Press this to rotate the scanned image 90 degrees on the left.
- **COLOR MODE**
 - Select the button of the color mode for scanning.
- **ORIGINAL MODE**
 - [TEXT]** — Press this when scanning the originals that contain texts.
 - [TEXT/PHOTO]** — Press this when scanning originals that contain texts and photos.
 - [PHOTO]** — Press this when scanning originals that contain photos printed on photographic paper.
 - [PRTD IMAGE]** — Press this when scanning originals as printed images. This can be set only when [FULL COLOR] or [AUTO COLOR] is selected in the “COLOR MODE” option.

NOTE: The “ORIGINAL MODE” option cannot be set when [GRAY SCALE] is selected in the “COLOR MODE” option.

- **RESOLUTION**

[600] — Press this when scanning originals in 600 dpi. This can be set only when [BLACK] is selected in the “COLOR MODE” option. When the optional expansion memory is installed, this can be set even if other than [BLACK] is selected in the “COLOR MODE” option (However, only A4/LT originals can be scanned).

[400] — Press this when scanning originals in 400 dpi.

[300] — Press this when scanning originals in 300 dpi.

[200] — Press this when scanning originals in 200 dpi.

[150] — Press this when scanning originals in 150 dpi.

[100] — Press this when scanning originals in 100 dpi. This cannot be set when [BLACK] is selected in the “COLOR MODE” option.

11. Specify the following items as you require, and press the [ENTER] button.

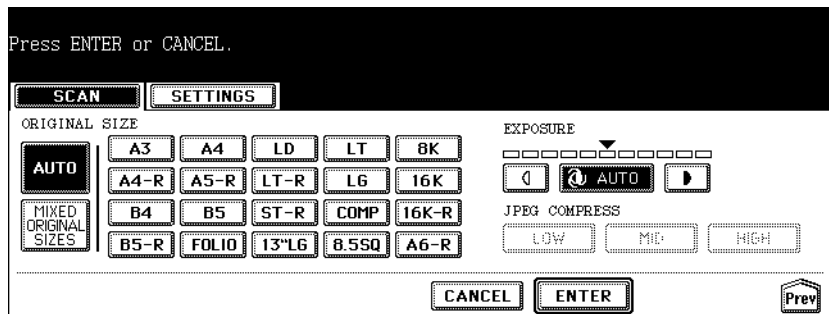

- **ORIGINAL SIZE**

Select the button of the original size, or select the [AUTO] button to automatically detects the original size.

When placing the different size originals on the reversing automatic document feeder, select the [MIXED ORIGINAL SIZE] button.

- **EXPOSURE**

Press light or dark buttons to specify the exposure for scanning manually, or press the [AUTO] button to select auto mode for the exposure mode for scanning. This can be set only when the [BLACK] button is selected at the “COLOR MODE” option. When other than the [BLACK] button is selected at the “COLOR MODE” option, the setting will be changed to “BACKGROUND ADJUSTMENT”.

- **BACKGROUND ADJUSTMENT**

Press light or dark buttons to specify the background for scanning manually. This can be set only when other than the [BLACK] button is selected at the “COLOR MODE” option. When the [BLACK] button is selected at the “COLOR MODE” option, the setting will be changed to “EXPOSURE”.

- **JPEG COMPRESS**

Select the JPEG compression for scan data. This cannot be set when the [BLACK] button is selected at the “COLOR MODE” option.

12. Press the [ENTER] button.

SCAN TO E-FILING

BOX/FOLDER BOX NUMBER : 001

BOX NAME : User01

FOLDER NAME : Folder

DOCUMENT NAME : user01-0001

EDIT CANCEL ENTER

- The screen returns to the basic scan menu.

13. Press the [SCAN!] button.

Select Menu!!
Press Scan! to start scanning

SCAN TO E-FILING

SCAN TO FILE

SCAN TO E-MAIL

SCAN!

SUPPLEMENT: You can also set another scan agent, by pressing either the [SCAN TO FILE] button or [SCAN TO E-MAIL] button to set the scanning conditions.

📖 P.30 "How to Perform Scan to File"

📖 P.40 "How to Perform Scan to E-mail"

14. If the "To continue, place document on glass. And press Scan!" message is displayed, place another original on glass and press [SCAN!] to scan another original, or press the [JOB FINISH] button to finish scanning.

To continue, place document on glass.
And press Scan!

SCAN PAGE : 1

JOB CANCEL EDIT JOB FINISH SCAN!

- When the original is set on the reversing automatic document feeder, this screen is not displayed. However, this screen is displayed when you press the [CONTINUE] button during scanning the originals.
- If you want to cancel the storage of the scanned data, press the [JOB CANCEL] button.
- You can change the setting of the original type and scanning conditions, using the [EDIT] button before pressing the [SCAN!] button.

How to Use Scanned Data Stored in e-Filing

Scanned data that is stored in e-Filing can be listed from the touch panel or e-Filing web utility.

Using Scanned Data in e-Filing from Touch Panel Display

The scanned data that is stored in e-Filing can be printed or deleted from the touch panel. For instructions on how to print or delete scanned data in e-Filing from the touch panel, see *Operator's Manual for Basic Function* or *e-Filing Guide*.

Using Scanned Data in e-Filing from e-Filing Web Utility

The scanned data that is stored in e-Filing can be printed, deleted, copied to another boxes or folders, and merged with other scanned data in e-Filing using the e-Filing web utility. For instructions on how to print, delete, copy, or merge scanned data, see *e-Filing Guide*.

3

SCAN TO FILE

This section describes the instructions on how to perform Scan to File and how to use the stored files.

- **How to Perform Scan to File**30
- **How to Use Scanned Data Stored as Files**37

How to Perform Scan to File

In this SCAN TO FILE function, the scanned original data can be sent and stored to the Share folder of the hard disk in the equipment or the specified PC. You can scan up to 1000 pages per 1 job. You can access the data stored in the Share folder directly from the client PC via network.

In the shared folder in the equipment, up to 5 GB of data can be stored.

- NOTES:
- The network administrator has to make settings for storing the original data to the PCs. For details, see **Network Administrator's Guide**.
 - It is recommended to back up the data stored in the Share folder of the hard disk with the client PC via network.

Scanning Procedure for Scan to File

1. **Place the original(s).**
 - For instruction about placing the originals, see **Operator's Manual for Basic Function**.
2. **Press the [SCAN] button on the control panel to enter the scan menu.**

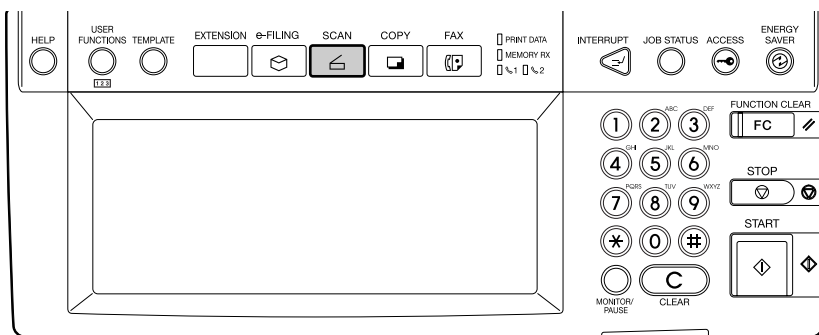

- The basic scan menu is displayed.

3. **Press the [SCAN TO FILE] button.**

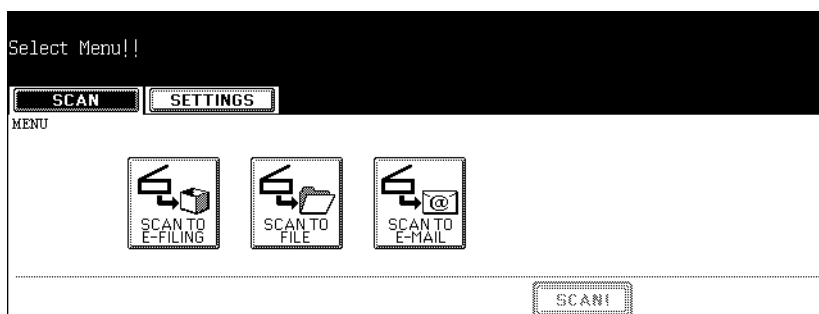

- The SCAN TO FILE screen is displayed.

4. Press the [FILE NAME] button if you want rename the document name of the scanned data.

- The letter entry screen is displayed. Enter the value using the keyboard and digital keys, and press the [ENTER] button to set the entry.

5. If you want to store the scanned data in the shared folder of the equipment, make sure the [MFP LOCAL] button is selected (displayed as reversed button).

NOTE: You can set up to two destinations for Scan to File. If you select the [MFP LOCAL] button, you can specify only one more remote destination. If you want to specify the two remote destinations, press the [MFP LOCAL] button to disable it (displayed as normal button).

6. If you want to store the scanned data in network folder, press the [REMOTE 1] or [REMOTE 2] buttons.

- If the selected remote destination (REMOTE 1 or REMOTE 2) is configured to save the scanned data in specified network folder by the administrator, the button will be the reversed button when you press it. In this case, users cannot change the destination.
- If the selected remote destination (REMOTE 1 or REMOTE 2) is configured for users to specify the desired network folder, the screen to set up the remote destination is displayed.

7. If the screen to set up the remote destination is displayed by pressing the [REMOTE 1] or [REMOTE 2] button, specify the remote destination. You can specify the remote destination using FTP or SMB.

When you want to store the data using FTP, select the [FTP] button and specify the following items as you require. Then press the [ENTER] button.

The screenshot shows a menu interface for setting a remote destination. At the top, there are two tabs: 'SCAN' and 'SETTINGS'. Below the tabs, the text 'REMOTE2' is displayed. Underneath, the 'PROTOCOL' section has two buttons: 'FTP' and 'SMB'. Below the protocol buttons are two input fields: 'SERVER NAME' containing '10.10.70.101' and 'NETWORK PATH' containing 'user01\scan'. To the right of these fields are three more input fields: 'LOGIN USER NAME' containing 'take', 'PASSWORD' containing a series of asterisks, and 'COMMAND PORT' containing '-'. At the bottom of the screen are two buttons: 'CANCEL' and 'ENTER'.

- **[SERVER NAME]**
Press this to enter the IP address of the FTP server. For example, if you want to store the data into “ftp://10.10.70.101/user01/scan/”, enter “10.10.70.101” here.
- **[NETWORK PATH]**
Press this to enter the folder path to the folder where you want to store the data in the FTP server. For example, if you want to store the data into “ftp://10.10.70.101/user01/scan/”, enter “user01\scan” here. Make sure to use “\” instead of “/” to specify the path.
- **[LOGIN USER NAME]**
Press this to enter the user name to login the FTP server if required.
- **[PASSWORD]**
Press this to enter the password to login the FTP server if required.
- **[COMMAND PORT]**
Press this to enter the port number to be used for command. Generally “-” is entered for the command port. When “-” is entered, the port number that is set by the administrator will be used. Change this option only when you want to use another port number.

SUPPLEMENT: When you press each button, the letter entry screen is displayed. Enter the value using the keyboard and digital keys, and press the [ENTER] button to set the entry.

When you want to store the data using SMB, select the **[SMB]** button and specify the following items as you require. Then press the **[ENTER]** button.

- **[NETWORK PATH]**
Press this to enter the network path to the folder where you want to store the data.
- **[LOGIN USER NAME]**
Press this to enter the user name to access the network folder if required.
- **[PASSWORD]**
Press this to enter the password to access the network folder if required.

SUPPLEMENT: When you press each button, the letter entry screen is displayed. Enter the value using the keyboard and digital keys, and press the **[ENTER]** button to set the entry.

NOTE: **[SERVER NAME]** and **[COMMAND PORT]** are not required to set when selecting the **[SMB]** button for protocol.

8. Select the file format in “FILE FORMAT” option.

[JPEG] — Press this to store the scanned data as a JPEG file. This can be selected only when **[GRAY SCALE]** or **[FULL COLOR]** is selected in the “COLOR MODE” option.

[PDF] — Press this to store the scanned data as a PDF file.

[TIFF (SINGLE)] — Press this to store the scanned data as a Single TIFF file. When scanning several pages, this equipment will store each page as separate TIFF file.

[TIFF (MULTI)] — Press this to store the scanned data as a Multiple page TIFF file. When scanning several pages, this equipment will store all pages as one TIFF file. This cannot be set when **[AUTO COLOR]** is selected in the “COLOR MODE” option.

9. Press the **[EDIT]** button to set the scanning conditions.

- The screen to set the scan conditions is displayed.

10. Specify the following items as you require, and press the [Next] button.

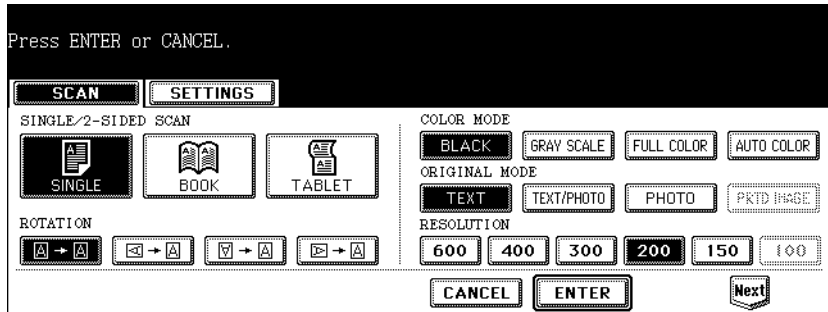

- **SINGLE/2-SIDED SCAN**
 - [SINGLE]** — Press this when scanning only the front page of originals.
 - [BOOK]** — Press this when scanning both side of originals in the same direction.
 - [TABLET]** — Press this when scanning front page in the general direction, and scanning back page rotated 180 degree.
- **ROTATION**
 - [0 degree]** — Press this not to rotate the scanned image.
 - [90 degree right]** — Press this to rotate the scanned image 90 degree on the right.
 - [180 degree]** — Press this to rotate the scanned image 180 degree.
 - [90 degree left]** — Press this to rotate the scanned image 90 degrees on the left.
- **COLOR MODE**

Select the button of the color mode for scanning.
- **ORIGINAL MODE**
 - [TEXT]** — Press this when scanning the originals that contain texts.
 - [TEXT/PHOTO]** — Press this when scanning originals that contain texts and photos.
 - [PHOTO]** — Press this when scanning originals that contain photos printed on photographic paper.
 - [PRTD IMAGE]** — Press this when scanning originals as printed images. This can be set only when [FULL COLOR] or [AUTO COLOR] is selected in the “COLOR MODE” option.

NOTE: The “ORIGINAL MODE” option cannot be set when [GRAY SCALE] is selected in the “COLOR MODE” option.

- **RESOLUTION**
 - [600]** — Press this when scanning originals in 600 dpi. This can be set only when [BLACK] is selected in the “COLOR MODE” option. When the optional expansion memory is installed, this can be set even if other than [BLACK] is selected in the “COLOR MODE” option (However, only A4/LT originals can be scanned).
 - [400]** — Press this when scanning originals in 400 dpi.
 - [300]** — Press this when scanning originals in 300 dpi.
 - [200]** — Press this when scanning originals in 200 dpi.
 - [150]** — Press this when scanning originals in 150 dpi.
 - [100]** — Press this when scanning originals in 100 dpi. This cannot be set when [BLACK] is selected in the “COLOR MODE” option.

11. Specify the following items as you require, and press the [ENTER] button.

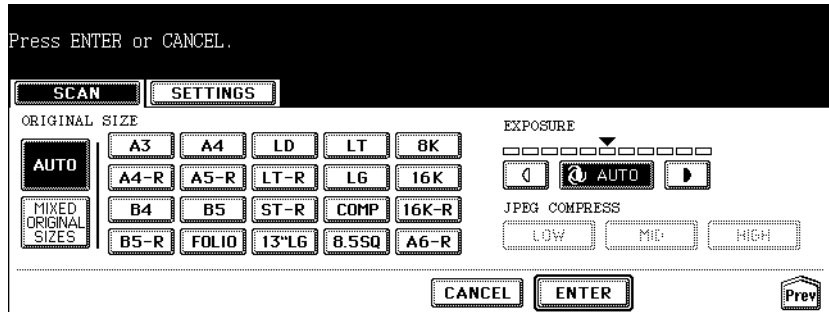

- ORIGINAL SIZE**
 Select the button of the original size, or select the [AUTO] button to automatically detects the original size.
 When placing the different size originals on the reversing automatic document feeder, select the [MIXED ORIGINAL SIZE] button.
- EXPOSURE**
 Press light or dark buttons to specify the exposure for scanning manually, or press the [AUTO] button to select auto mode for the exposure mode for scanning. This can be set only when the [BLACK] button is selected at the "COLOR MODE" option. When other than the [BLACK] button is selected at the "COLOR MODE" option, the setting will be changed to "BACKGROUND ADJUSTMENT".
- BACKGROUND ADJUSTMENT**
 Press light or dark buttons to specify the background for scanning manually. This can be set only when other than the [BLACK] button is selected at the "COLOR MODE" option. When the [BLACK] button is selected at the "COLOR MODE" option, the setting will be changed to "EXPOSURE".
- JPEG COMPRESS**
 Select the JPEG compression for scan data. This cannot be set when the [BLACK] button is selected at the "COLOR MODE" option.

12. Press the [ENTER] button.

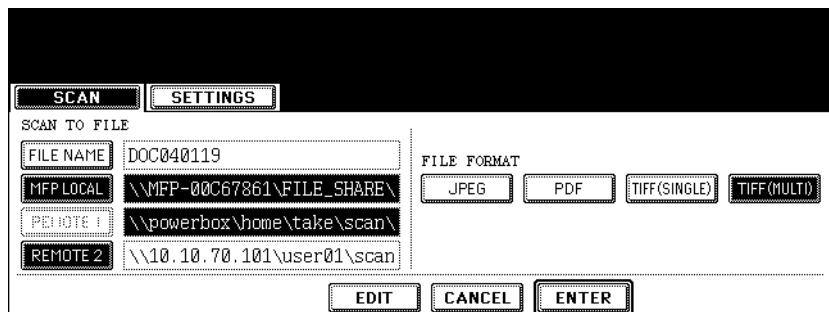

- The screen returns to the basic scan menu.

13. Press the [SCAN!] button.

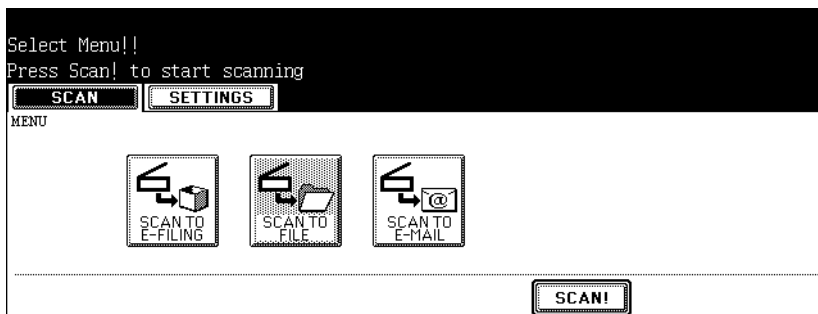

SUPPLEMENT: You can also set another scan agent, by pressing either the [SCAN TO E-FILING] button or [SCAN TO E-MAIL] button to set the scanning conditions.

📖 P.22 "How to Perform Scan to e-Filing"

📖 P.40 "How to Perform Scan to E-mail"

14. If the “To continue, place document on glass. And press Scan!” message is displayed, place another original on glass and press [SCAN!] to scan another original, or press the [JOB FINISH] button to finish scanning.



- When the original is set on the reversing automatic document feeder, this screen is not displayed. However, this screen is displayed when you press the [CONTINUE] button during scanning the originals.
- If you want to cancel the storage of the scanned data, press the [JOB CANCEL] button.
- You can change the setting of the original type and scanning conditions, using the [EDIT] button before pressing the [SCAN!] button.

How to Use Scanned Data Stored as Files

Once the scanned data is stored in the shared folder in the equipment, or network folder that you specify, you can access the files using Windows Explorer.

When Scanned Data Is Stored in MFP LOCAL

When selecting the [MFP LOCAL] button for the destination, the scanned data is stored in the shared folder, whose name is “FILE_SHARE”, in the equipment.

You can access to the shared folder in the equipment from the Windows computers or Mac OS X 10.2.x or later to use scanned data for any uses.

NOTE: You cannot access to the shared folder in the equipment earlier than Mac OS X 10.2.x because these versions of Mac OS computers does not support SMB.

How scanned data is stored in the shared folder varies depending on the Local Storage Path setting, which can be set in the Save as file Setup page in TopAccess.

When the Local Storage Path is set to send scanned data to a sub folder in the storage path, the equipment creates a sub folder. The name of the sub folders varies depending on how you operate Scan to File.

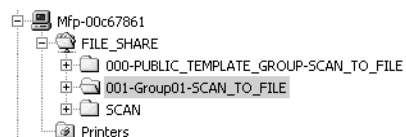

- **“SCAN” folder** — This sub folder contains the files that are stored by pressing the [SCAN TO FILE] button in the basic scan menu.
- **“000-PUBLIC_TEMPLATE_GROUP-[Template Name]” folder** — This sub folder contains the files that are stored by pressing the template button in the Public Template Group.
- **“[Group No.]-[Group Name]-[Template Name]” folder** — This sub folder contains the files that are stored by pressing the template button in the User Template Group.

When the Local Storage Path is set to send scanned data directly to the storage path, they are stored in the “FILE_SHARE” folder in the equipment.

When Scanned Data Is Stored in REMOTE 1 or 2

When selecting the [REMOTE 1] or [REMOTE 2] button for the destination, the scanned data is stored in the specified network folder.

You can access to the network folder using Windows Explorer to use scanned data for any uses.

4

SCAN TO E-MAIL

This section describes the instructions on how to perform Scan to E-mail.

- **How to Perform Scan to E-mail.....40**

How to Perform Scan to E-mail

In this function, the scanned data can be sent to the specified E-mail address as an attached file.

NOTE: To use SCAN TO E-MAIL, the configuration of the equipment needs to be set by the network administrator.

Scanning Procedure for Scan to E-mail

1. **Place the original(s).**
 - For instruction about placing the originals, see *Operator's Manual for Basic Function*.
2. **Press the [SCAN] button on the control panel to enter the scan menu.**

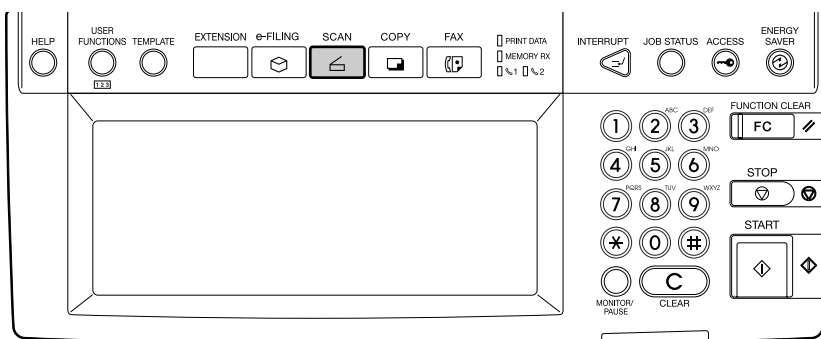

- The basic scan menu is displayed.

3. **Press the [SCAN TO E-MAIL] button.**

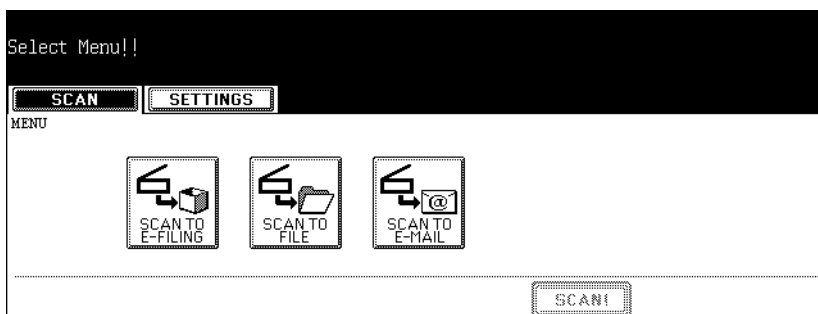

- When the SMTP Authentication is enabled by the administrator, the AUTHENTICATION screen displayed. If the AUTHENTICATION screen is displayed, continue to next step.
- When the SMTP Authentication is disabled by the administrator, the SCAN TO E-MAIL screen is displayed. If the ADDRESS BOOK screen is displayed, skip to Step 5.

- When the AUTHENTICATION screen is displayed, enter the user name and password by pressing the [USER NAME] and [PASSWORD] buttons, and press the [ENTER] button.

AUTHENTICATION PASSWORD ▶ Key in the user name and password. Press ENTER

USER NAME

PASSWORD

CANCEL ENTER

- When pressing each button, the letter entry screen is displayed. Enter the value using the keyboard and digital keys, and press the [ENTER] button to set the entry.

NOTE: This screen is displayed only when the SMTP Authentication is enabled. When this screen is displayed, you must enter your user name and password to login the SCAN TO E-MAIL screen. For user name and password, ask your network administrator.

- Specify the E-mail addresses that you want to send, and press the [SETTINGS] button.

DESTINATION:0004

Press [START] to start scanning
user04@ifax.com

ADDRESS DESTINATION

ADDRESS BOOK

001User01 User	FAX	E-MAIL	005User05 User	FAX	E-MAIL	KNOWN ID
002User02 User	FAX	E-MAIL	006User06 User	FAX	E-MAIL	SEARCH ADDRESS
003User03 User	FAX	E-MAIL	007User07 User	FAX	E-MAIL	GROUP
004User04 User	FAX	E-MAIL	008User08 User	FAX	E-MAIL	

SETTINGS ALL CLEAR E-MAIL ADDRESS 1/125 Next

- You can specify the E-mail address by various ways. See the following procedures for each instruction.
 - P.46 "Specifying Destinations"

SUPPLEMENT: You can press the [START] button to start sending the E-mail at this screen if you specify an E-mail address and the From Address has been set in TopAccess E-mail setting page or set by the SMTP Authentication setting.

6. Press the [SUBJECT], [BODY], and [FILE NAME] buttons to enter each item.

- When pressing each button, the letter entry screen is displayed. Enter the value using the keyboard and digital keys, and press the [ENTER] button to set the entry.

SUPPLEMENT: You can also specify the CC destinations for Scan to E-mail by pressing the [E-MAIL CC] button.

7. Select the file format in “FILE FORMAT” option, and press the [Next] button.

[JPEG] — Press this to attach the scanned data as a JPEG file. This can be selected only when [GRAY SCALE] or [FULL COLOR] is selected in the “COLOR MODE” option.

[PDF] — Press this to attach the scanned data as a PDF file.

[TIFF (MULTI)] — Press this to attach the scanned data as a Multiple page TIFF file. When scanning several pages, this equipment will store all pages as one TIFF file. This cannot be set when [AUTO COLOR] is selected in the “COLOR MODE” option.

NOTE: [TIFF (SINGLE)] cannot be selected for Scan to E-mail.

8. Specify the following items as you require.

- **FRAGMENT MESSAGE SIZE**

Select the size of the message fragmentation. If the size of attached file exceeds the selected size, this equipment divides the data into some small blocks.

- **[FROM ADDRESS]**

Press this button to edit the From Address for E-mail. When the administrator enable the SMTP Authentication and set that From Address cannot be edited, you cannot edit the From Address.

- **[FROM NAME]**

Press this button to edit the From Name for E-mail.

SUPPLEMENT: When you press the [FROM ADDRESS] or [FROM NAME] button, the letter entry screen is displayed. Enter the value using the keyboard and digital keys, and press the [ENTER] button to set the entry.

9. Press the [EDIT] button to set the scanning conditions.

- The screen to set the scan conditions is displayed.

10. Specify the following items as you require, and press the [Next] button.

- **SINGLE/2-SIDED SCAN**

[SINGLE] — Press this when scanning only the front page of originals.

[BOOK] — Press this when scanning both side of originals in the same direction.

[TABLET] — Press this when scanning front page in the general direction, and scanning back page rotated 180 degree.

- **ROTATION**

[0 degree] — Press this not to rotate the scanned image.

[90 degree right] — Press this to rotate the scanned image 90 degree on the right.

[180 degree] — Press this to rotate the scanned image 180 degree.

[90 degree left] — Press this to rotate the scanned image 90 degrees on the left.

- **COLOR MODE**

Select the button of the color mode for scanning.

- **ORIGINAL MODE**

[TEXT] — Press this when scanning the originals that contain texts.

[TEXT/PHOTO] — Press this when scanning originals that contain texts and photos.

[PHOTO] — Press this when scanning originals that contain photos printed on photographic paper.

[PRTD IMAGE] — Press this when scanning originals as printed images. This can be set only when [FULL COLOR] or [AUTO COLOR] is selected in the "COLOR MODE" option.

NOTE: The "ORIGINAL MODE" option cannot be set when [GRAY SCALE] is selected in the "COLOR MODE" option.

- **RESOLUTION**

[600] — Press this when scanning originals in 600 dpi. This can be set only when [BLACK] is selected in the "COLOR MODE" option. When the optional expansion memory is installed, this can be set even if other than [BLACK] is selected in the "COLOR MODE" option (However, only A4/LT originals can be scanned).

[400] — Press this when scanning originals in 400 dpi.

[300] — Press this when scanning originals in 300 dpi.

[200] — Press this when scanning originals in 200 dpi.

[150] — Press this when scanning originals in 150 dpi.

[100] — Press this when scanning originals in 100 dpi. This cannot be set when [BLACK] is selected in the "COLOR MODE" option.

11. Specify the following items as you require, and press the [ENTER] button.

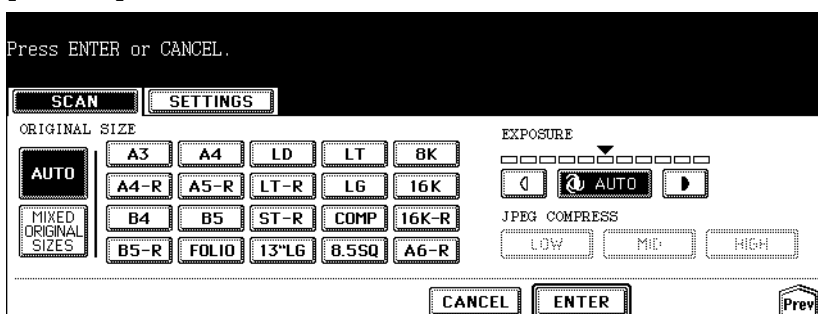

- **ORIGINAL SIZE**

Select the button of the original size, or select the [AUTO] button to automatically detects the original size.

When placing the different size originals on the reversing automatic document feeder, select the [MIXED ORIGINAL SIZE] button.

- **EXPOSURE**

Press light or dark buttons to specify the exposure for scanning manually, or press the [AUTO] button to select auto mode for the exposure mode for scanning. This can be set only when the [BLACK] button is selected at the "COLOR MODE" option. When other than the [BLACK] button is selected at the "COLOR MODE" option, the setting will be changed to "BACKGROUND ADJUSTMENT".

- **BACKGROUND ADJUSTMENT**

Press light or dark buttons to specify the background for scanning manually. This can be set only when other than the [BLACK] button is selected at the "COLOR MODE" option. When the [BLACK] button is selected at the "COLOR MODE" option, the setting will be changed to "EXPOSURE".

- **JPEG COMPRESS**

Select the JPEG compression for scan data. This cannot be set when the [BLACK] button is selected at the "COLOR MODE" option.

12. Press the [ENTER] button.

SCAN TO E-MAIL

FRAGMENT MESSAGE SIZE (KB)

NONE 64 128 256 512 1024 2048

FROM ADDRESS user01@ifax.com

FROM NAME user01

EDIT CANCEL ENTER Prev

- The screen returns to the basic scan menu.

SUPPLEMENT: You can press the [START] button to start sending the E-mail at this screen without pressing the [ENTER] button.

13. Press the [SCAN!] button.

Select Menu!!

Press Scan! to start scanning

SCAN TO E-FILING SCAN TO FILE SCAN TO E-MAIL

SCAN!

SUPPLEMENT: You can also set another scan agent, by pressing either the [SCAN TO E-FILING] button or [SCAN TO FILE] button to set the scanning conditions.

📖 P.22 "How to Perform Scan to e-Filing"

📖 P.30 "How to Perform Scan to File"

- 14. If the “To continue, place document on glass. And press Scan!” message is displayed, place another original on glass and press [SCAN!] to scan another original, or press the [JOB FINISH] button to finish scanning.**



- When the original is set on the reversing automatic document feeder, this screen is not displayed. However, this screen is displayed when you press the [CONTINUE] button during scanning the originals.
- If you want to cancel the storage of the scanned data, press the [JOB CANCEL] button.
- You can change the setting of the original type and scanning conditions, using the [EDIT] button before pressing the [SCAN!] button.

Specifying Destinations

When pressing the [E-MAIL TO] button in the SCAN TO E-MAIL screen, the ADDRESS BOOK screen is displayed.

You can specify E-mail addresses for Scan to E-mail by following methods:

- 📖 P.46 "Entering an E-mail address manually"
- 📖 P.47 "Selecting from address book"
- 📖 P.48 "Searching with ID number for a contact"
- 📖 P.49 "Searching with search strings from address book"
- 📖 P.51 "Searching with search strings from LDAP server"
- 📖 P.53 "Selecting from groups"
- 📖 P.54 "Searching with ID number of a group"
- 📖 P.55 "Searching with group name"

Entering an E-mail address manually

- 1. Press the [E-MAIL ADDRESS] button.**

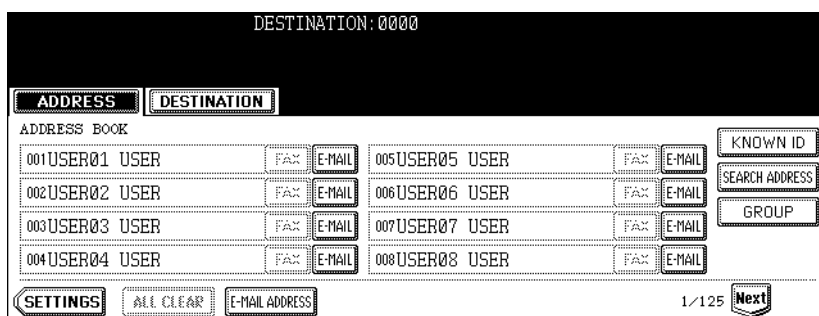

- The letter entry screen is displayed.

2. Enter the E-mail address that you want to send using the keyboard and digital keys, and press the [ENTER] button to set the entry.

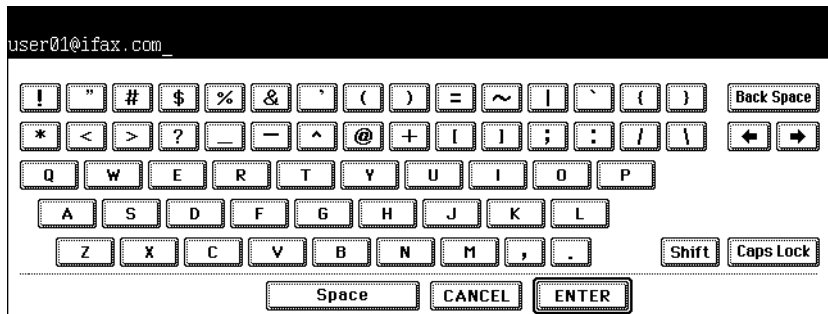

3. Press the [SETTINGS] button.

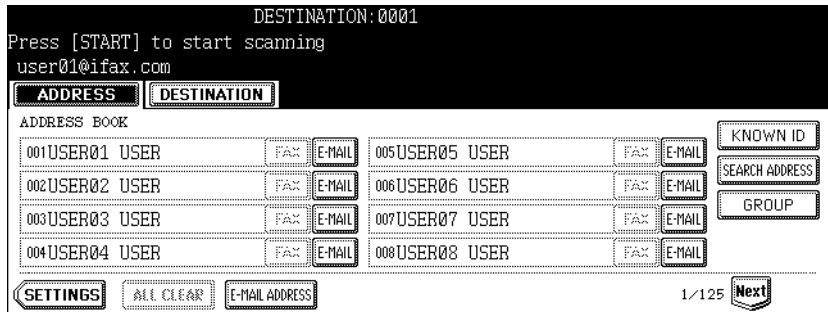

- The screen returns to the SCAN TO E-MAIL screen.

- SUPPLEMENTS:
- Before pressing the [SETTINGS] button, you can specify other E-mail addresses as you require.
 - You can confirm or remove the E-mail addresses that you specified in the DESTINATION screen which can be displayed by pressing the [DESTINATION] button.
 P.57 "Confirming or removing E-mail addresses from destination"

Selecting from address book

1. Press the contacts that you want to send.

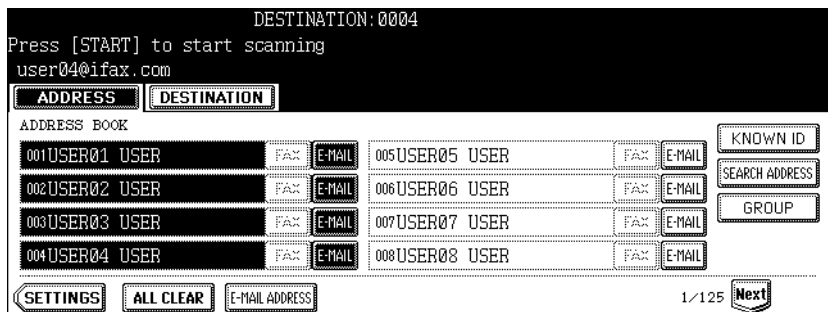

- The selected contacts are displayed as reversed buttons. To cancel the selection, press the contact again, then the button will be a normal button.

2. Press the [SETTINGS] button.

- The screen returns to the SCAN TO E-MAIL screen.

- SUPPLEMENTS:
- Before pressing the [SETTINGS] button, you can specify other E-mail addresses as you require.
 - You can confirm or remove the E-mail addresses that you specified in the DESTINATION screen which can be displayed by pressing the [DESTINATION] button.
 P.57 "Confirming or removing E-mail addresses from destination"

Searching with ID number for a contact

1. Press the [KNOWN ID] button.

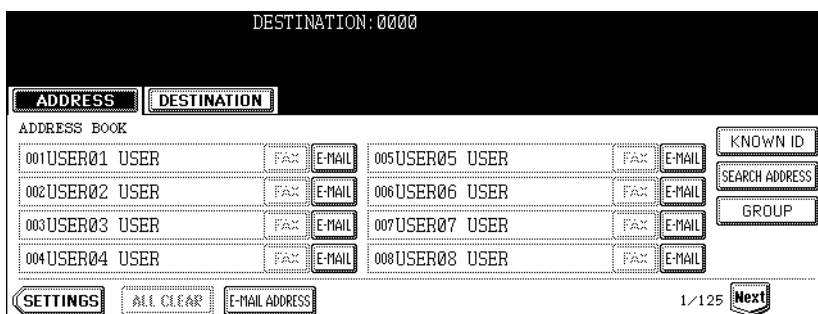

- The KNOWN ID screen is displayed.

2. Enter the ID number of the contact that you want to search using the digital keys, and press the [ENTER] button.



- The ADDRESS BOOK screen that contains the contact of the specified ID is displayed.

3. Press the contact that you want to send, and press the [SETTINGS] button.

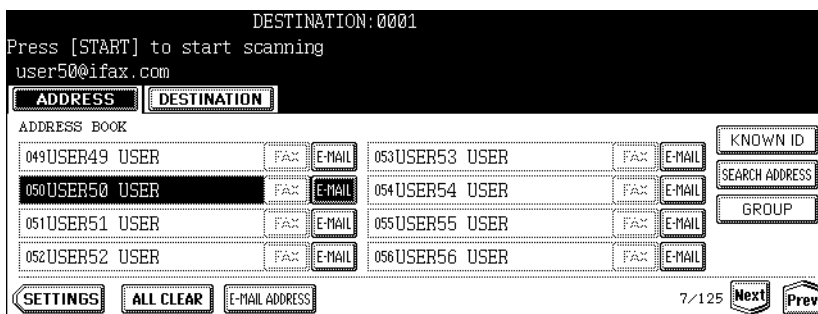

- The screen returns to the SCAN TO E-MAIL screen.

- SUPPLEMENTS:
- Before pressing the [SETTINGS] button, you can specify other E-mail addresses as you require.
 - You can confirm or remove the E-mail addresses that you specified in the DESTINATION screen which can be displayed by pressing the [DESTINATION] button.
 P.57 "Confirming or removing E-mail addresses from destination"

Searching with search strings from address book

1. Press the [SEARCH ADDRESS] button.

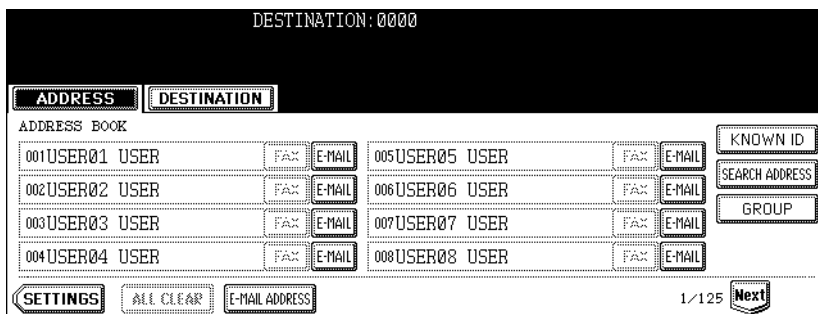

- The ADDRESS SEARCH screen is displayed.

2. Press the buttons to enter the search strings that you want to specify, and then enter the [SEARCH] button.

DESTINATION: 0000

ADDRESS DESTINATION

ADDRESS SEARCH

FIRST NAME		CORP.	
LAST NAME		DEPT.	Dept01
FAX NO.		KEYWORD	
E-MAIL			

DIR SERVICE CLEAR CANCEL SEARCH

- When pressing each button, the letter entry screen is displayed. Enter the value using the keyboard and digital keys, and press the [ENTER] button to set the entry.

SUPPLEMENT: It will search for the contacts that contain the search text in the specified items.

NOTE: If the [DIR SERVICE] button is displayed a selected button, this equipment will search for contacts in the LDAP server. In that case, press the [DIR SERVICE] button to display the Directory Service Name screen and clear the selection of a directory service. Then press the [ENTER] button to return the ADDRESS SEARCH screen.

3. Press the contact that you want to send, and press the [ENTER] button.

DESTINATION: 0004

user04@ifax.com

ADDRESS DESTINATION

ADDRESS SEARCH

001USER01 USER	FAX	E-MAIL	005USER05 USER	FAX	E-MAIL
002USER02 USER	FAX	E-MAIL	006USER06 USER	FAX	E-MAIL
003USER03 USER	FAX	E-MAIL	007USER07 USER	FAX	E-MAIL
004USER04 USER	FAX	E-MAIL	008USER08 USER	FAX	E-MAIL

ENTER 1/2 Next

- The screen returns to the ADDRESS BOOK screen.

4. Press the [SETTINGS] button.

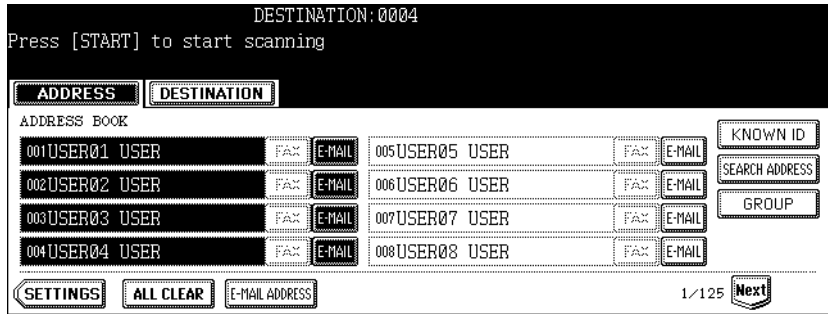

- The screen returns to the SCAN TO E-MAIL screen.

- SUPPLEMENTS:
- Before pressing the [SETTINGS] button, you can specify other E-mail addresses as you require.
 - You can confirm or remove the E-mail addresses that you specified in the DESTINATION screen which can be displayed by pressing the [DESTINATION] button.
 P.57 "Confirming or removing E-mail addresses from destination"

Searching with search strings from LDAP server

NOTE: To search contacts in the LDAP server, the directory service must be registered using TopAccess by the network administrator.

1. Press the [SEARCH ADDRESS] button.

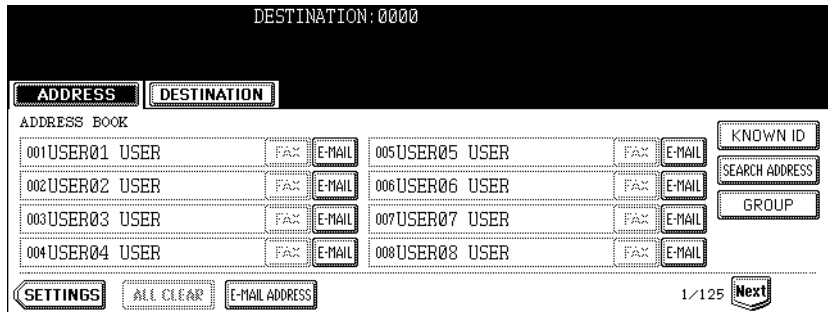

- The ADDRESS SEARCH screen is displayed.

2. Press the [DIR SERVICE] button.

- The Directory Search Name screen is displayed.

SUPPLEMENT: When the [DIR SERVICE] button is displayed as a selected button, this equipment is currently configured to search a default directory service.

3. Select the directory service name that you want to search from, and press the [ENTER] button.

- The screen returns to the ADDRESS SEARCH screen.

4. Press the buttons to enter the search strings that you want to specify, and then enter the [SEARCH] button.

- When pressing each button, the letter entry screen is displayed. Enter the value using the keyboard and digital keys, and press the [ENTER] button to set the entry.

SUPPLEMENT: It will search for the contacts that contain the search text in the specified items.

5. Press the contact that you want to send, and press the [ENTER] button.

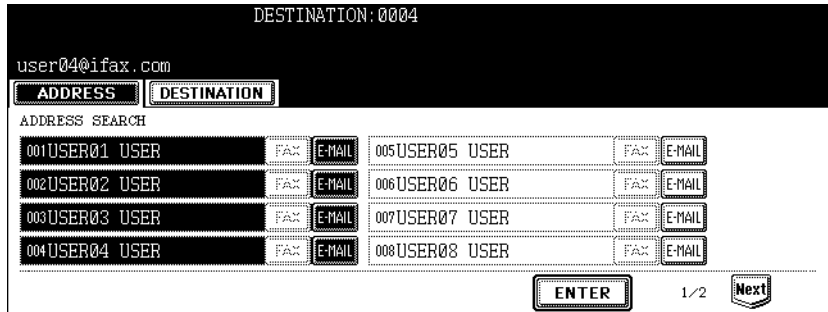

- The screen returns to the ADDRESS BOOK screen.

6. Press the [SETTINGS] button.

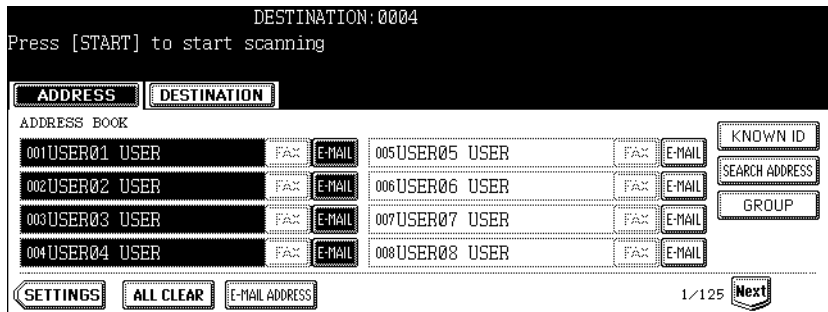

- The screen returns to the SCAN TO E-MAIL screen.

- SUPPLEMENTS:
- Before pressing the [SETTINGS] button, you can specify other E-mail addresses as you require.
 - You can confirm or remove the E-mail addresses that you specified in the DESTINATION screen which can be displayed by pressing the [DESTINATION] button.
- P.57 "Confirming or removing E-mail addresses from destination"

Selecting from groups

1. Press the [GROUP] button.

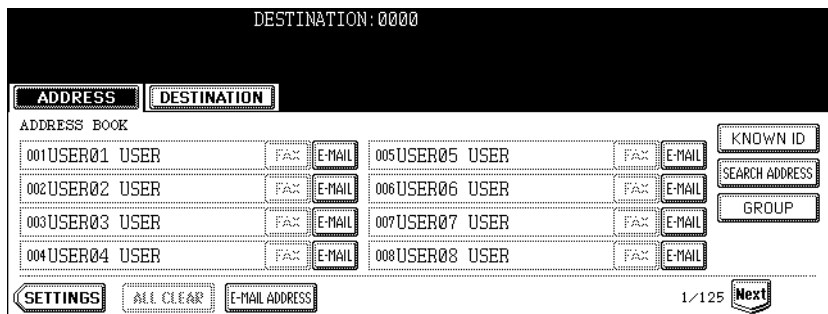

- The GROUP screen is displayed.

2. Press the group buttons that you want to select as the destination, and press the [SETTINGS] button.

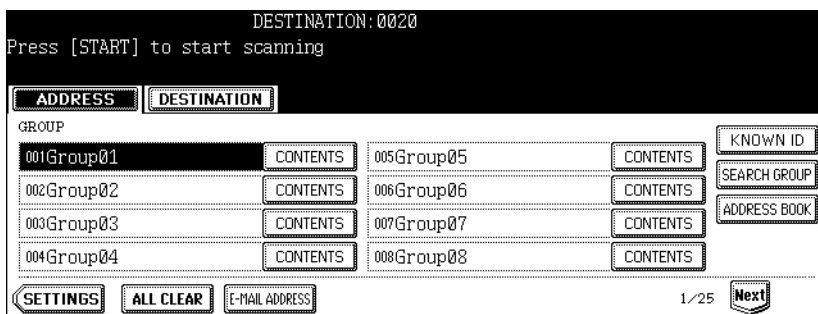

- The screen returns to the SCAN TO E-MAIL screen.

- SUPPLEMENTS:
- You can confirm the E-mail addresses that registered in the group by pressing the [CONTENTS] button.
 - Before pressing the [SETTINGS] button, you can specify other E-mail addresses as you require.
 - You can confirm or remove the E-mail addresses that you specified in the DESTINATION screen which can be displayed by pressing the [DESTINATION] button.
 P.57 "Confirming or removing E-mail addresses from destination"

Searching with ID number of a group

1. Press the [GROUP] button.

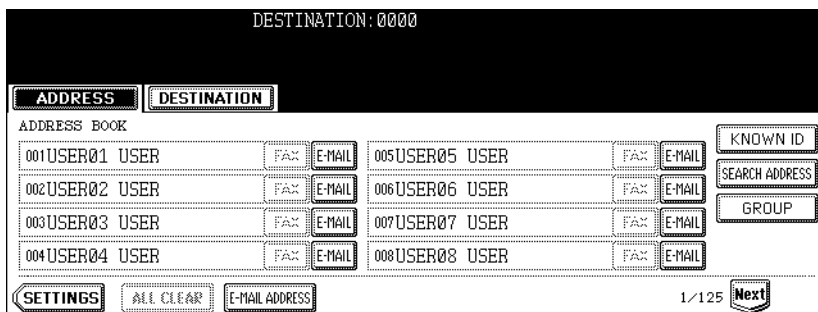

- The GROUP screen is displayed.

2. Press the [KNOWN ID] button.

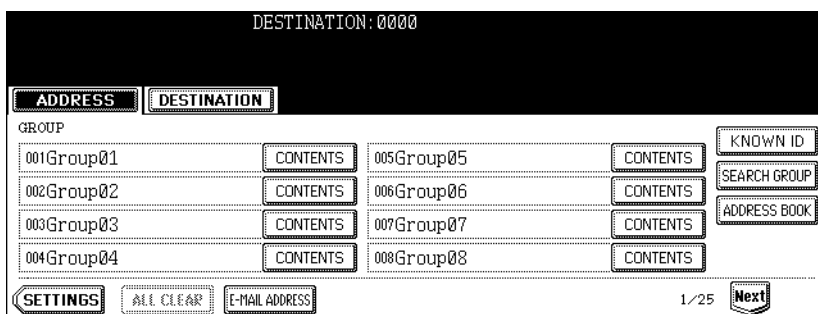

- The KNOWN ID screen is displayed.

3. Enter the ID number of the group that you want to search using the digital keys, and press the [ENTER] button.

DESTINATION: 0002

ADDRESS DESTINATION

KNOWN ID Enter ID Number

KNOWN ID : 9

CANCEL ENTER

- The GROUP screen that contains the group of the specified ID is displayed.

4. Press the group buttons that you want to select as the destination, and press the [SETTINGS] button.

DESTINATION: 0002

Press [START] to start scanning

ADDRESS DESTINATION

GROUP

009Group09	CONTENTS	013
010		014
011		015
012		016

KNOWN ID
SEARCH GROUP
ADDRESS BOOK

SETTINGS ALL CLEAR E-MAIL ADDRESS 2/25 Next Prev

- The screen returns to the SCAN TO E-MAIL screen.

- SUPPLEMENTS:
- You can confirm the E-mail addresses that registered in the group by pressing the [CONTENTS] button.
 - Before pressing the [SETTINGS] button, you can specify other E-mail addresses as you require.
 - You can confirm or remove the E-mail addresses that you specified in the DESTINATION screen which can be displayed by pressing the [DESTINATION] button.
- 📖 P.57 "Confirming or removing E-mail addresses from destination"

Searching with group name

1. Press the [GROUP] button.

DESTINATION: 0000

ADDRESS DESTINATION

ADDRESS BOOK

001USER01 USER	FAX	E-MAIL	005USER05 USER	FAX	E-MAIL
002USER02 USER	FAX	E-MAIL	006USER06 USER	FAX	E-MAIL
003USER03 USER	FAX	E-MAIL	007USER07 USER	FAX	E-MAIL
004USER04 USER	FAX	E-MAIL	008USER08 USER	FAX	E-MAIL

KNOWN ID
SEARCH ADDRESS
GROUP

SETTINGS ALL CLEAR E-MAIL ADDRESS 1/125 Next

- The GROUP screen is displayed.

2. Press the [SEARCH GROUP] button.

DESTINATION: 0000

ADDRESS DESTINATION

GROUP

001Group01	CONTENTS	005Group05	CONTENTS	KNOWN ID
002Group02	CONTENTS	006Group06	CONTENTS	SEARCH GROUP
003Group03	CONTENTS	007Group07	CONTENTS	ADDRESS BOOK
004Group04	CONTENTS	008Group08	CONTENTS	

SETTINGS ALL CLEAR E-MAIL ADDRESS 1/25 Next

- The KNOWN ID screen is displayed.

3. Press the [GROUP NAME] button to enter the group name that you want to search, and then press the [SEARCH] button.

DESTINATION: 0000

ADDRESS DESTINATION

GROUP SEARCH

GROUP NAME Group09

CLEAR CANCEL SEARCH

- When pressing the [GROUP NAME] button, the letter entry screen is displayed. Enter the value using the keyboard and digital keys, and press the [ENTER] button to set the entry.

SUPPLEMENT: It will search for the groups that contain the search text in the group name.

4. Press the group buttons that you want to select as the destination, and press the [ENTER] button.

DESTINATION: 0002

ADDRESS DESTINATION

GROUP SEARCH

009Group09

ENTER 1/1

- The screen returns to the GROUP screen.

5. Press the [SETTINGS] button.

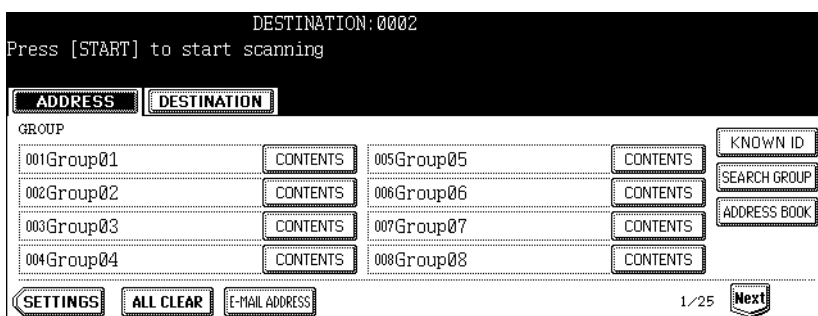

- The screen returns to the SCAN TO E-MAIL screen.

- SUPPLEMENTS:
- You can confirm the E-mail addresses that registered in the group by pressing the [CONTENTS] button.
 - Before pressing the [SETTINGS] button, you can specify other E-mail addresses as you require.
 - You can confirm or remove the E-mail addresses that you specified in the DESTINATION screen which can be displayed by pressing the [DESTINATION] button.
- P.57 "Confirming or removing E-mail addresses from destination"

Confirming or removing E-mail addresses from destination

When you want to remove the E-mail addresses, contacts, or groups that are added as the destination, operate the following procedure.

1. Press the [DESTINATION] button.

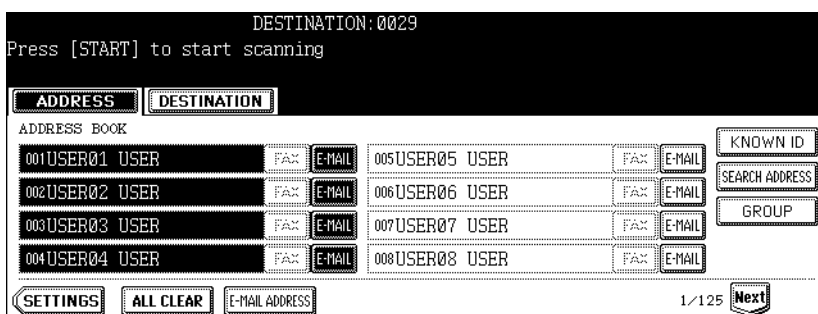

- The DESTINATION screen is displayed.

2. You can confirm the destinations that are currently specified. To remove E-mail addresses, contacts, or groups that you selected for destination, select the name that you want to remove, and press the [DELETE] button.

DESTINATION:0030
Press [START] to start scanning

ADDRESS	DESTINATION
DESTINATION	
user01@ifax.com <input type="button" value="E-MAIL"/>	USER04 USER <input type="button" value="E-MAIL"/>
USER01 USER <input type="button" value="E-MAIL"/>	Group01 <input type="button" value="GROUP"/>
USER02 USER <input type="button" value="E-MAIL"/>	Group02 <input type="button" value="GROUP"/>
USER03 USER <input type="button" value="E-MAIL"/>	

1/1

5

USING TEMPLATE

This section describes the instructions on how to use scan templates.

- **Scanning Using Template** 60
- **Registering Scan Template** 68

Scanning Using Template

Users can also use a template to operate scanning on this equipment.

It enables users to register templates for scanning operations.

Once registering a template, users can operate the scanning operation quickly without setting the scanning conditions.

NOTE: Before scanning using a template, users must register a template for scan operations. For instructions on how to register a template, see the following section.

📖 P.68 "Registering Scan Template"

SUPPLEMENT: The templates that the Scan to E-mail agent is set will be available after user authenticates the access rights for the Scan to E-mail operation. For instructions on how to operate scan using a template, see the following section.

📖 P.63 "Using Scan to E-mail template when SMTP Authentication is enabled"

Scan Procedure using a template

1. Place the original(s).

- For instruction about placing the originals, see *Operator's Manual for Basic Function*.

2. Press the [TEMPLATE] button on the control panel to enter the template menu.

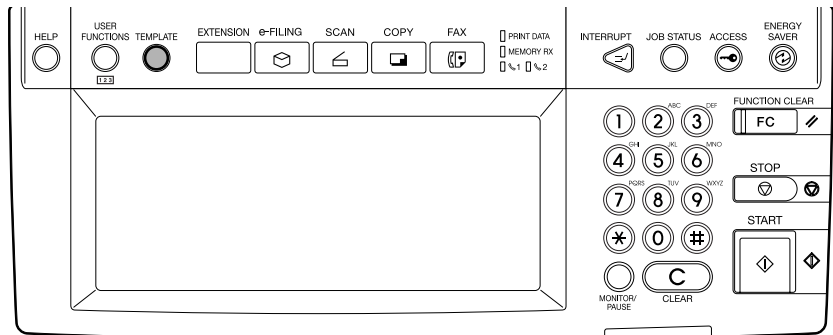

- The screen to select a template group is displayed.

3. Press the template group button that contains the template that you want to recall.

Select a GROUP

RECALL **REGISTRATION**

GROUP Number

PUBLIC TEMPLATE GROUP	004
001 User01	005
002	006
003	007

CANCEL 1/26 **Next**

- When you press the [PUBLIC TEMPLATE GROUP] button or user template group button that the password is not set, the screen to select a template is displayed. If the screen to select a template is displayed, skip to Step 5.
- If the password has been set to the selected user template group, the password input screen is displayed. If the password input screen is displayed, continue to next step.

SUPPLEMENT: If you cannot find the desired user template group button in the screen, press the [Next] button to switch the screen to find the desired user template group button.

4. If the password entry screen displayed, enter the password for the selected user template group using digital keys, and press the [ENTER] button.

PASSWORD
(5-digit)

NAME : User01
USER NAME : User01

Password : *****

CANCEL **ENTER**

- The screen to select a template is displayed.

5. Press the template button that you want to recall.

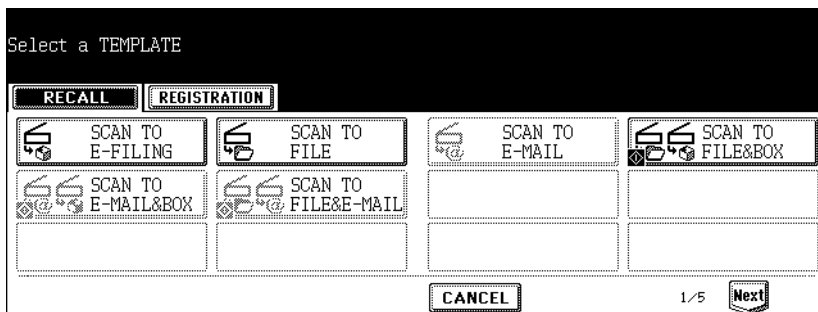

- If you select a template that the automatic start function is enabled (which the  icon is displayed in the lower left corner of the button) and the password is not set, the scanning operation is automatically started and finish the operation. If the password is set to the template, you must enter the password. In that case, continue to the next step.
- If you select a template that the automatic start function is disabled, the basic scan menu is displayed. In that case, continue the operation.

6. If the password is set to the selected template, the password entry screen is displayed. Enter the 5-digit password using the digital keys and press the [ENTER] button.



- If you select the template that the automatic start function is enabled, the scanning operation is automatically started and finish the operation.

7. Press the [SCAN!] button.

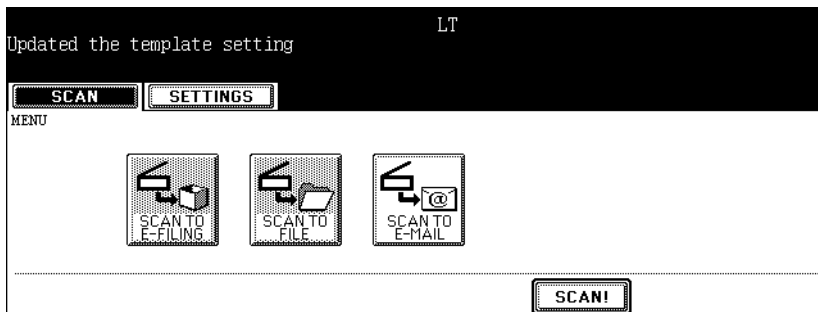

SUPPLEMENT: If you want to change the scan conditions, press the desired agent button and set the scan conditions as you require.

8. If the “To continue, place document on glass. And press Scan!” message is displayed, place another original on glass and press [SCAN!] to scan another original, or press the [JOB FINISH] button to finish scanning.



- When the original is set on the reversing automatic document feeder, this screen is not displayed. However, this screen is displayed when you press the [CONTINUE] button during scanning the originals.
- If you want to cancel the storage of the scanned data, press the [JOB CANCEL] button.
- You can change the setting of the original type and scanning conditions, using the [EDIT] button before pressing the [SCAN!] button.

Using Scan to E-mail template when SMTP Authentication is enabled

When the SMTP Authentication is enabled, operate the following procedure to use the template that is registered the Scan to E-mail agent.

1. Place the original(s).
 - For instruction about placing the originals, see *Operator's Manual for Basic Function*.
2. Press the [SCAN] button on the control panel to enter the scan menu.

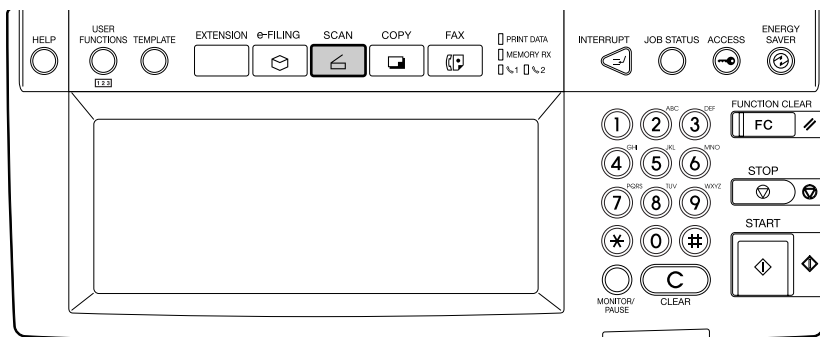

- The basic scan menu is displayed.

3. Press the [SCAN TO E-MAIL] button.

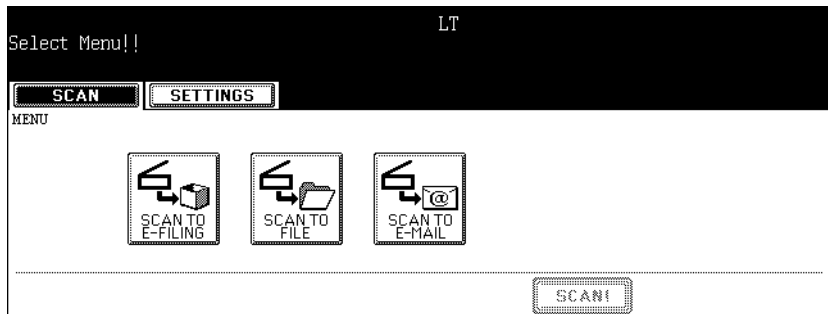

- The AUTHENTICATION screen is displayed.

4. Enter the user name and password by pressing the [USER NAME] and [PASSWORD] buttons, and press the [ENTER] button.

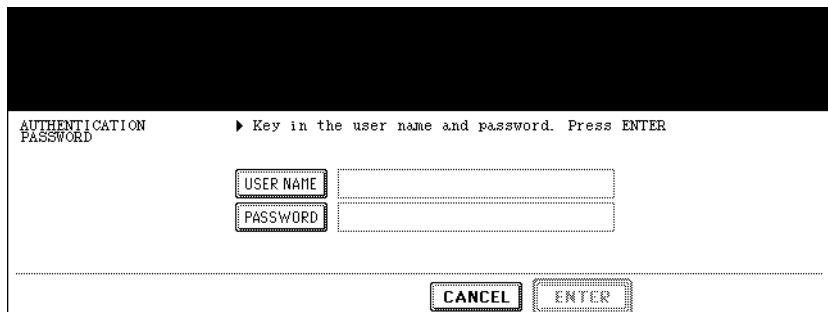

- When pressing each button, the letter entry screen is displayed. Enter the value using the keyboard and digital keys, and press the [ENTER] button to set the entry.

5. Press the [TEMPLATE] button on the control panel to enter the template menu.

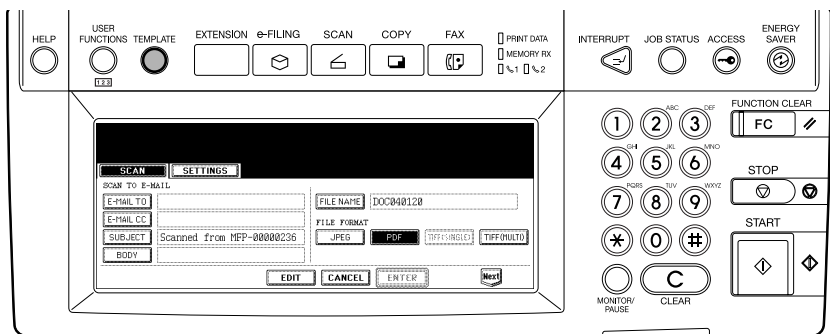

- The screen to select a template group is displayed.

6. Press the template group button that contains the template that you want to recall.

- When you press the [PUBLIC TEMPLATE GROUP] button or user template group button that the password is not set, the screen to select a template is displayed. If the screen to select a template is displayed, skip to Step 8.
- If the password has been set to the selected user template group, the password input screen is displayed. If the password input screen is displayed, continue to next step.

SUPPLEMENT: If you cannot find the desired user template group button in the screen, press the [Next] button to switch the screen to find the desired user template group button.

7. If the password entry screen displayed, enter the password for the selected user template group using digital keys, and press the [ENTER] button.

- The screen to select a template is displayed.

8. Press the Scan to E-mail template button that you want to recall.

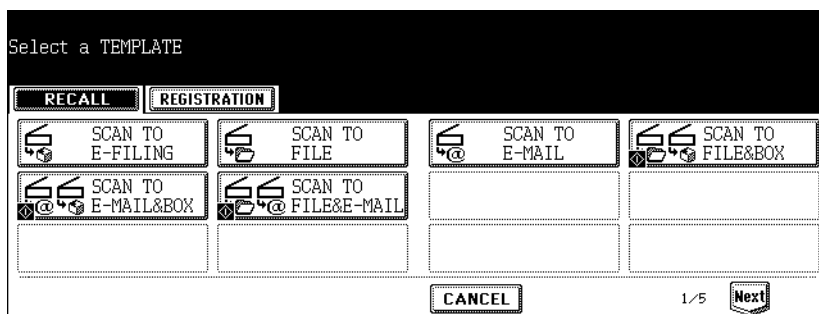

- If you select a template that the automatic start function is enabled (which the  icon is displayed in the lower left corner of the button), the scanning operation is automatically started. In that case, finish the operation.
- If you select a template that the automatic start function is disabled, the basic scan menu is displayed. In that case, continue the operation.

9. Press the [SCAN!] button.

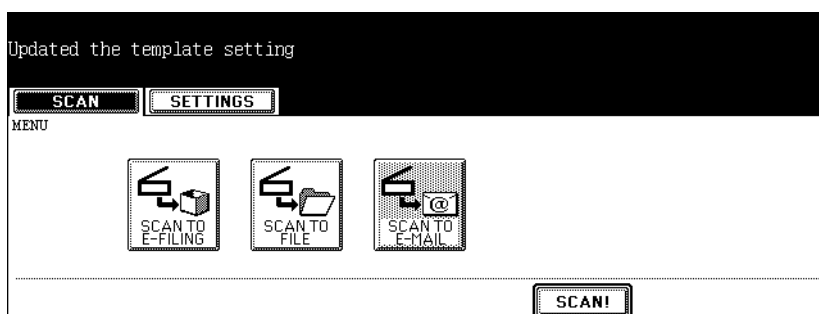

SUPPLEMENT: If you want to change the scan conditions, press the desired agent button and set the scan conditions as you require.

10. If the “To continue, place document on glass. And press Scan!” message is displayed, place another original on glass and press [SCAN!] to scan another original, or press the [JOB FINISH] button to finish scanning.



- When the original is set on the reversing automatic document feeder, this screen is not displayed. However, this screen is displayed when you press the [CONTINUE] button during scanning the originals.
- If you want to cancel the storage of the scanned data, press the [JOB CANCEL] button.
- You can change the setting of the original type and scanning conditions, using the [EDIT] button before pressing the [SCAN!] button.

Registering Scan Template

To recall the template, you need to first register the setting combination as a template. It enables users to register templates for scanning operations.

The template is registered either in "PUBLIC TEMPLATE GROUP" or "USER GROUP" depending on your purpose.

- **PUBLIC TEMPLATE GROUP**

Anyone can use the template when the setting combination of the functions frequently used throughout the company or organization have been registered in this group. Up to 60 combinations (templates) are available in this group. According to the purpose of use, you can restrict the use by entering the password.

 P.68 "Registering a scan template in public template group"

- **USER GROUP**

Each department, section or person controls one user group and registers it as a template. It is easier to control it if you set the password for group registration. Up to 200 groups can be set and up to 60 combinations (templates) are available in this group.

NOTE: When registering the template in the public template group, entering the administrator password is required.

Registering a scan template in public template group

1. Press the [SCAN] button on the control panel to enter the scan menu.

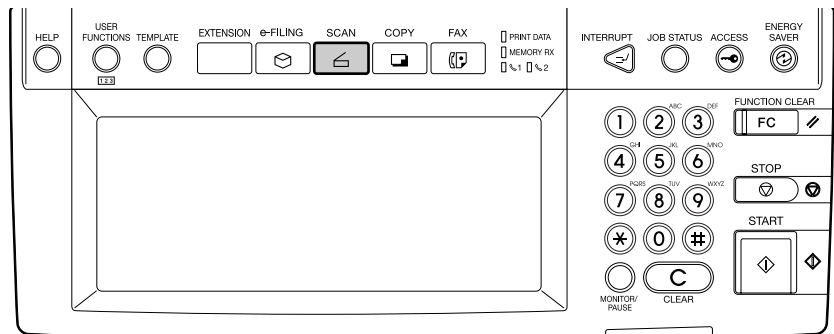

- The basic scan menu is displayed.

2. Press the buttons of the agent and set the scanning conditions.

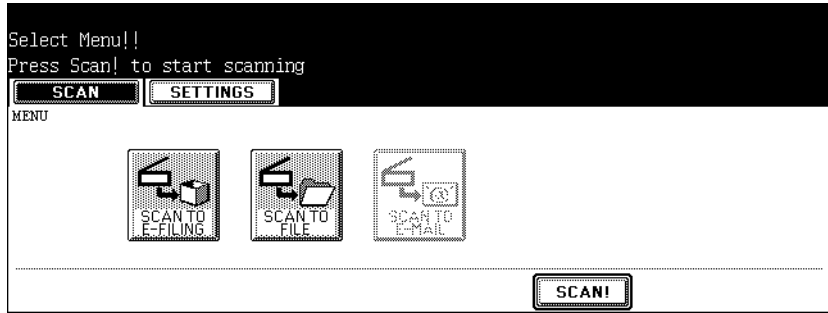

- For instructions on how to set each scan agent, see the instructions for each scan mode.
 - P.22 "How to Perform Scan to e-Filing"
 - P.30 "How to Perform Scan to File"
 - P.40 "How to Perform Scan to E-mail"

NOTE: Do not press the [ENTER] button at this time.

3. Press the [TEMPLATE] button on the control panel to enter the template menu.

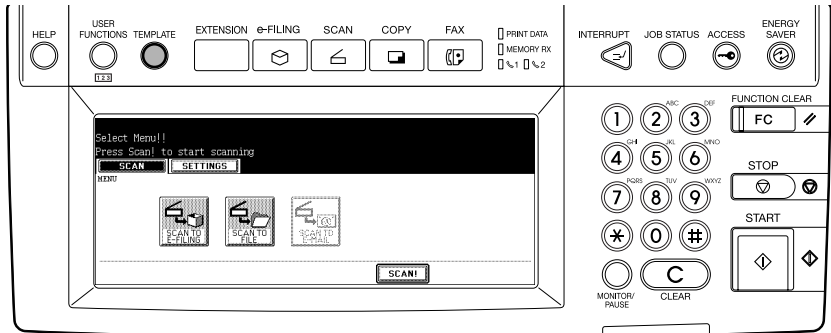

- The screen to select a template group is displayed.

4. Press the [REGISTRATION] button.

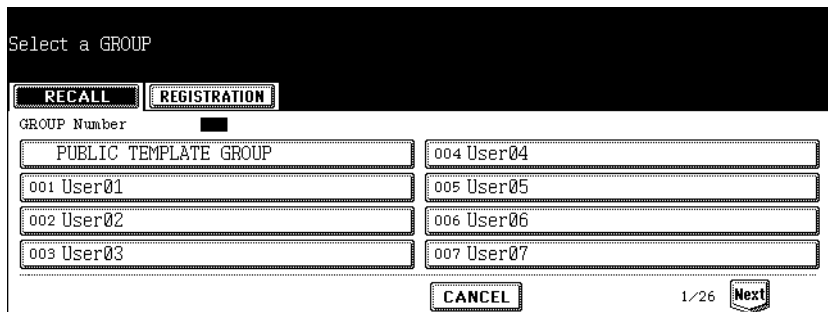

5. Select the “PUBLIC TEMPLATE GROUP” button, and press the [ENTER] button.

Select a GROUP

RECALL REGISTRATION

GROUP Number

PUBLIC TEMPLATE GROUP 004 User04

001 User01 005 User05

002 User02 006 User06

003 User03 007 User07

DELETE EDIT CANCEL ENTER 1/26 Next

- The ADMINISTRATOR PASSWORD screen is displayed.

6. Press the [PASSWORD] button.

ADMINISTRATOR PASSWORD

PASSWORD

CANCEL

- The letter entry screen is displayed.

7. Enter the administrator password using the keyboard and the digital keys, and press the [ENTER] button.

! " # \$ % & ' () = ~ | \ { } Back Space

* < > ? _ - ^ @ + I I ; : / \ ← →

Q W E R T Y U I O P

A S D F G H J K L

Z X C V B N M , . Shift Caps Lock

Space CANCEL ENTER

- The screen to select a template is displayed.

8. Select the blank template button and press the [SAVE] button.

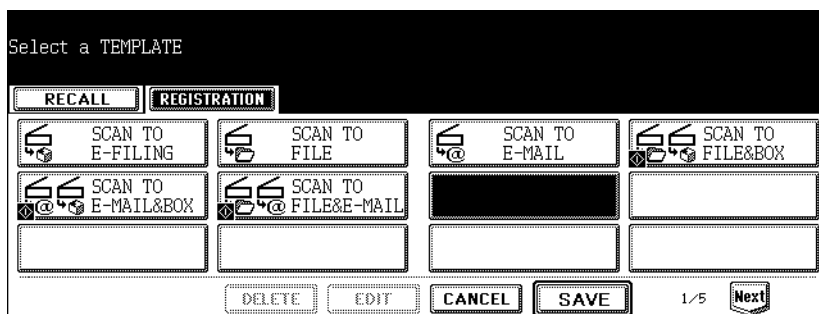

SUPPLEMENT: You can also select the existing template button to overwrite the template settings.

9. Specify the following items as you require and press the [SAVE] button.

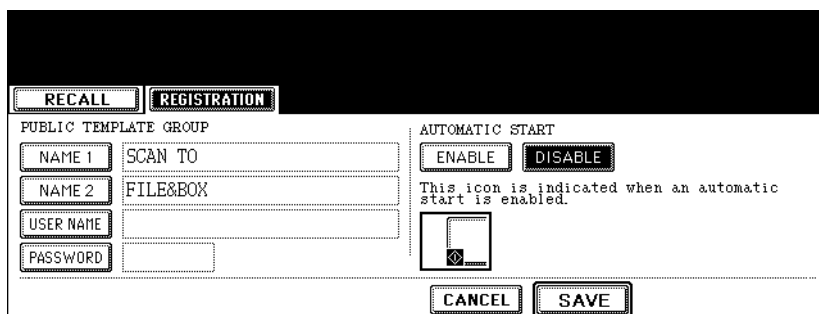

- **[NAME 1]**
Press this to enter the name that appears in the first line on the button.
- **[NAME 2]**
Press this to enter the name that appears in the second line on the button.
- **[USER NAME]**
Press this to enter the user name of the template.
- **[PASSWORD]**
Press this to enter the 5-digit password of the template. If the password is set, users must enter the password to apply the selected template.
- **AUTOMATIC START**
Select whether the automatic start function is enabled or disabled. If the automatic start function is enabled, the operation will be automatically start when user select the template button. The  icon will be displayed in the lower left corner of the template button if this function is enabled.

10. Press the [FUNCTION CLEAR] button on the control panel to clear the settings in the scan menu.

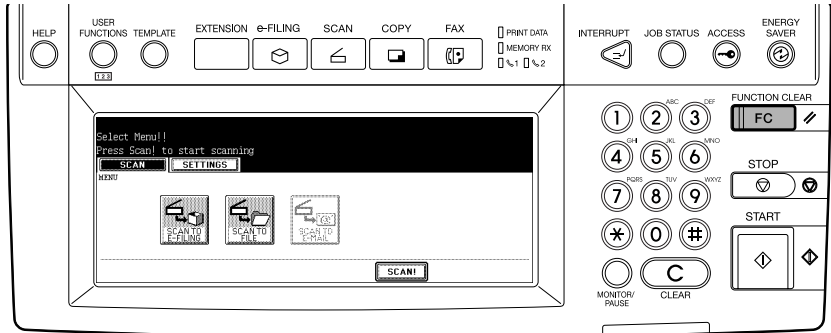

Registering a scan template in a user template group

1. Press the [SCAN] button on the control panel to enter the scan menu.

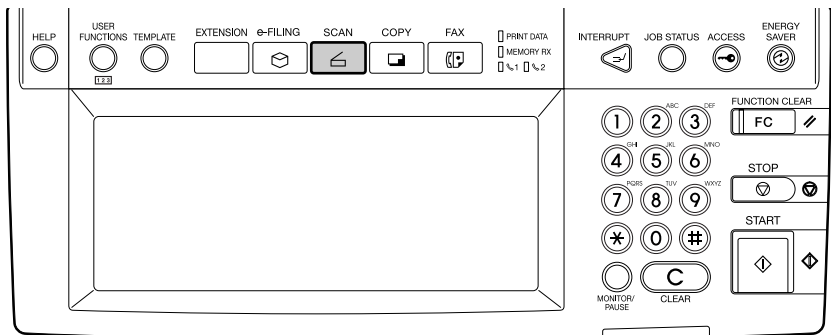

- The basic scan menu is displayed.

2. Press the buttons of the agent and set the scanning conditions.

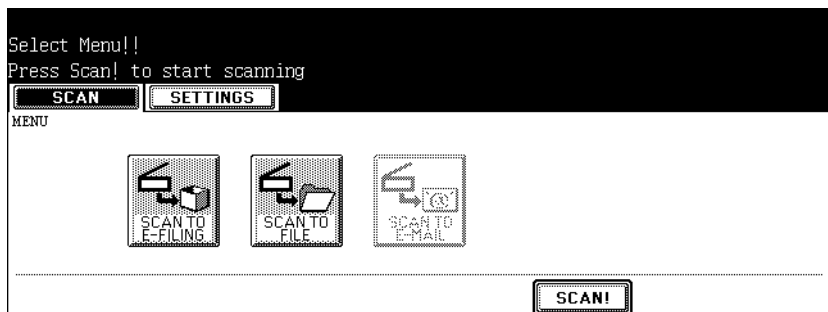

- For instructions on how to set each scan agent, see the instructions for each scan mode.
 - 📖 P.22 "How to Perform Scan to e-Filing"
 - 📖 P.30 "How to Perform Scan to File"
 - 📖 P.40 "How to Perform Scan to E-mail"

NOTE: Do not press the [ENTER] button at this time.

3. Press the [TEMPLATE] button on the control panel to enter the template menu.

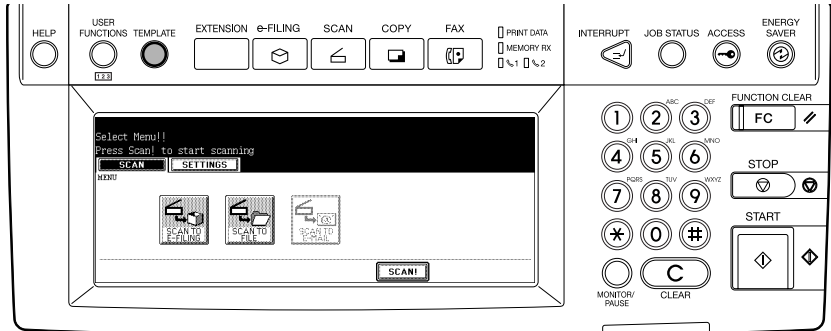

- The screen to select a template group is displayed.

4. Press the [REGISTRATION] button.

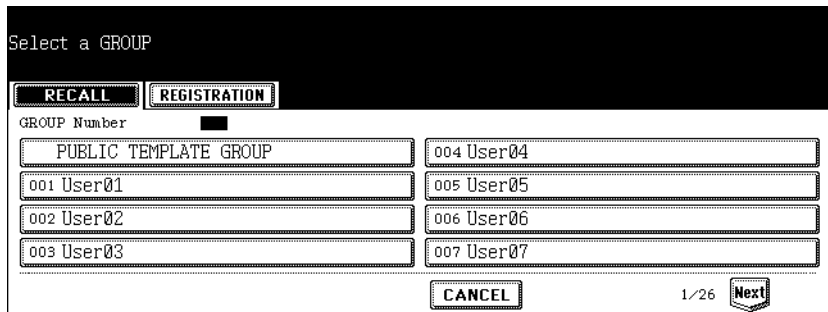

5. Select a user template group name where you want to register a new template, and press the [ENTER] button.

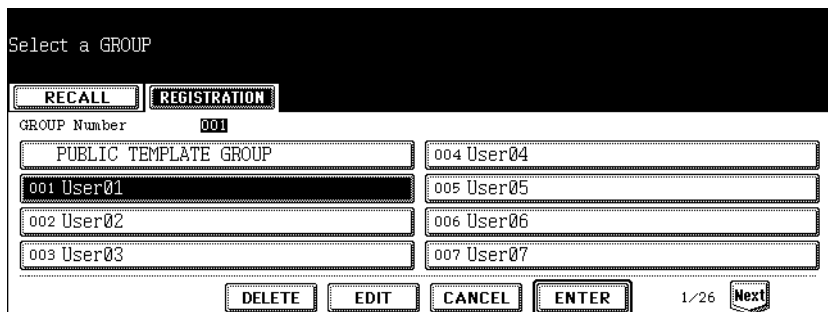

- When you press the user template group button that the password is not set, the screen to select a template is displayed. If the screen to select a template is displayed, skip to Step 7.
- If the password has been set to the selected user template group, the password input screen is displayed. If the password input screen is displayed, continue to next step.

SUPPLEMENT: If you cannot find the desired user template group button in the screen, press the [Next] button to switch the screen to find the desired user template group button.

- If the password entry screen displayed, enter the password for the selected user template group using digital keys, and press the [ENTER] button.

PASSWORD
(5-digit)

NAME : User01
USER NAME : User01

Password : *****

CANCEL ENTER

- The screen to select a template is displayed.

- Select the blank template button and press the [SAVE] button.

Select a TEMPLATE

RECALL REGISTRATION

SCAN TO E-FILING SCAN TO FILE SCAN TO E-MAIL SCAN TO FILE&BOX

SCAN TO E-MAIL&BOX SCAN TO FILE&E-MAIL

DELETE EDIT CANCEL SAVE 1/5 Next

SUPPLEMENT: You can also select the existing template button to overwrite the template settings.

- Specify the following items as you require and press the [SAVE] button.

RECALL REGISTRATION

TEMPLATE GROUP : User01

NAME 1 SCAN TO
NAME 2 FILE&BOX
USER NAME
PASSWORD

AUTOMATIC START
ENABLE DISABLE
This icon is indicated when an automatic start is enabled.

CANCEL SAVE

- [NAME 1]**
Press this to enter the name that appears in the first line on the button.
- [NAME 2]**
Press this to enter the name that appears in the second line on the button.
- [USER NAME]**
Press this to enter the user name of the template.

- **[PASSWORD]**
Press this to enter the 5-digit password of the template. If the password is set, users must enter the password to apply the selected template.
 - **AUTOMATIC START**
Select whether the automatic start function is enabled or disabled. If the automatic start function is enabled, the operation will be automatically start when user select the template button. The  icon will be displayed in the lower left corner of the template button if this function is enabled.
- 9. Press the [FUNCTION CLEAR] button on the control panel to clear the settings in the scan menu.**

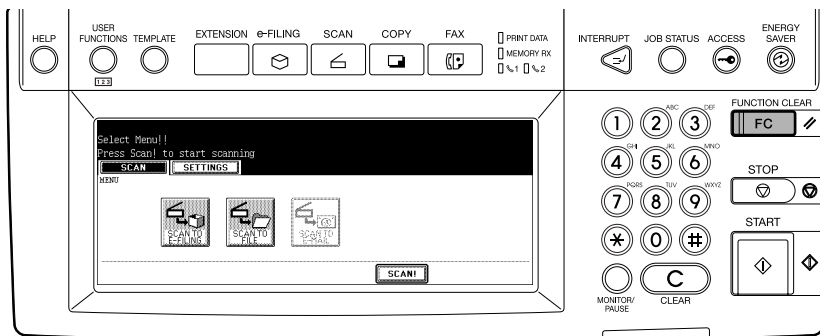

6

COPY & FILE

This section describes the instructions on how to perform Copy & File.

- **How to Perform Copy & File**.....78

How to Perform Copy & File

In this COPY & FILE function, the copied original data can be sent and stored to the Share folder of the hard disk in the equipment or the specified PC. You can access the data stored in the Share folder directly from the client PC via network.

- NOTES:
- The network administrator has to make settings for storing the original data to the PCs. For details, see **Network Administrator's Guide**.
 - It is recommended to back up the data stored in the Share folder of the hard disk with the client PC via network.
 - The Copy & File operation does not allow you to select the resolutions and JPEG file format. A document that is stored by Copy & File is proper for output, and not for importing as an image into your computer. To get the best image quality for importing an image into your computer, please store the document by "Scan to File".
 P.29 "Scan to File"

Scanning Procedure for Scan to File

1. **Place the original(s).**
 - For instruction about placing the originals, see *Operator's Manual for Basic Function*.
2. **Press the [E-FILING/FILE] button on the basic screen to enter the filing menu.**

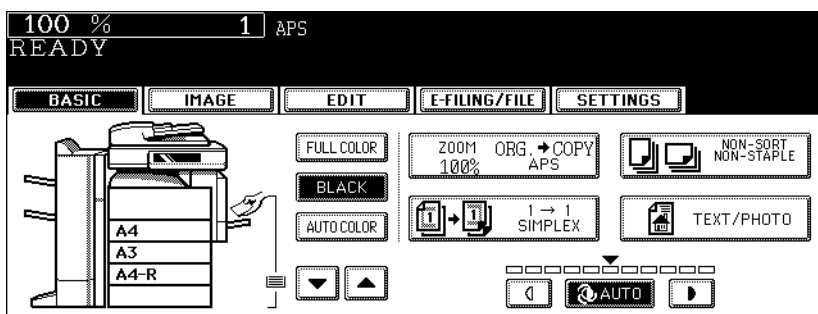

3. **Press the [COPY & FILE] button.**

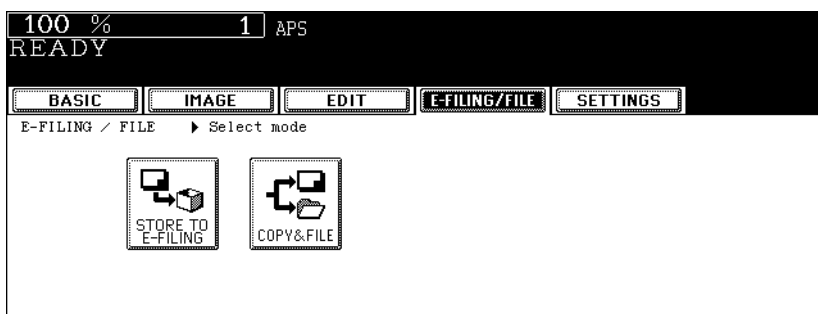

- The SAVE AS FILE screen is displayed.

4. Press the [FILE NAME] button if you want rename the document name of the scanned data.

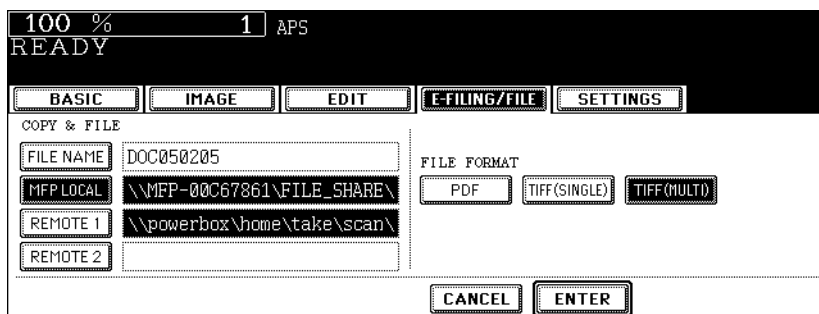

- The letter entry screen is displayed. Enter the value using the keyboard and digital keys, and press the [ENTER] button to set the entry.

5. If you want to store the scanned data in the shared folder of the equipment, make sure the [MFP LOCAL] button is selected (displayed as reversed button).

NOTE: You can set up to two destinations for Save as File. If you select the [MFP LOCAL] button, you can specify only one more remote destination. If you want to specify the two remote destinations, press the [MFP LOCAL] button to disable it (displayed as normal button).

6. If you want to store the scanned data in network folder, press the [REMOTE 1] or [REMOTE 2] buttons.

- If the selected remote destination (REMOTE 1 or REMOTE 2) is configured to save the scanned data in specified network folder by the administrator, the button will be the reversed button when you press it. In this case, users cannot change the destination.
- If the selected remote destination (REMOTE 1 or REMOTE 2) is configured for users to specify the desired network folder, the screen to set up the remote destination is displayed.

7. If the screen to set up the remote destination is displayed by pressing the [REMOTE 1] or [REMOTE 2] button, specify the remote destination. You can specify the remote destination using FTP or SMB.

When you want to store the data using FTP, select the [FTP] button and specify the following items as you require. Then press the [ENTER] button.

The screenshot shows a menu-driven interface for setting up a remote destination. At the top, it displays '100 %' and '1 &P;S'. Below that is a 'READY' status. A menu bar contains 'BASIC', 'IMAGE', 'EDIT', 'E-FILING/FILE', and 'SETTINGS'. The 'E-FILING/FILE' menu is selected, showing the 'REMOTE2' screen. Under 'PROTOCOL', 'FTP' is selected. The 'SERVER NAME' field contains '10.10.70.101' and the 'NETWORK PATH' field contains 'user01\scan'. On the right, the 'LOGIN USER NAME' field contains 'take' and the 'PASSWORD' field contains a series of asterisks. The 'COMMAND PORT' field contains a hyphen. At the bottom are 'CANCEL' and 'ENTER' buttons.

- **[SERVER NAME]**
Press this to enter the IP address of the FTP server. For example, if you want to store the data into “ftp://10.10.70.101/user01/scan/”, enter “10.10.70.101” here.
- **[NETWORK PATH]**
Press this to enter the folder path to the folder where you want to store the data in the FTP server. For example, if you want to store the data into “ftp://10.10.70.101/user01/scan/”, enter “user01\scan” here. Make sure to use “\” instead of “/” to specify the path.
- **[LOGIN USER NAME]**
Press this to enter the user name to login the FTP server if required.
- **[PASSWORD]**
Press this to enter the password to login the FTP server if required.
- **[COMMAND PORT]**
Press this to enter the port number to be used for command. Generally “-” is entered for the command port. When “-” is entered, the port number that is set by the administrator will be used. Change this option only when you want to use another port number.

SUPPLEMENT: When you press each button, the letter entry screen is displayed. Enter the value using the keyboard and digital keys, and press the [ENTER] button to set the entry.

When you want to store the data using SMB, select the **[SMB]** button and specify the following items as you require. Then press the **[ENTER]** button.

The screenshot shows the 'E-FILING/FILE' menu with the following fields and buttons:

- 100 %** | **1** | APS
- READY**
- Buttons: **BASIC**, **IMAGE**, **EDIT**, **E-FILING/FILE**, **SETTINGS**
- REMOTE2**
- PROTOCOL**: **FTP**, **SMB**
- LOGIN USER NAME**: take
- PASSWORD**: *****
- SERVER NAME**: [Empty]
- COMMAND PORT**: [Empty]
- NETWORK PATH**: \\powerbox\home\take\scan2
- Buttons: **CANCEL**, **ENTER**

- **[NETWORK PATH]**
Press this to enter the network path to the folder where you want to store the data.
- **[LOGIN USER NAME]**
Press this to enter the user name to access the network folder if required.
- **[PASSWORD]**
Press this to enter the password to access the network folder if required.

SUPPLEMENT: When you press each button, the letter entry screen is displayed. Enter the value using the keyboard and digital keys, and press the **[ENTER]** button to set the entry.

NOTE: **[SERVER NAME]** and **[COMMAND PORT]** are not required to set when selecting the **[SMB]** button for protocol.

8. Select the file format in “FILE FORMAT” option.

The screenshot shows the 'E-FILING/FILE' menu with the following fields and buttons:

- 100 %** | **1** | APS
- READY**
- Buttons: **BASIC**, **IMAGE**, **EDIT**, **E-FILING/FILE**, **SETTINGS**
- COPY & FILE**
- FILE NAME**: DOC050205
- MFP LOCAL**: \\MFP-00C67861\FILE_SHARE\
- REMOTE 1**: \\powerbox\home\take\scan\
- REMOTE 2**: \\10.10.70.101\user01\scan
- FILE FORMAT**: **PDF**, **TIFF(SINGLE)**, **TIFF(MULTI)**
- Buttons: **CANCEL**, **ENTER**

[PDF] — Press this to store the scanned data as a PDF file.

[TIFF (SINGLE)] — Press this to store the scanned data as a Single TIFF file. When scanning several pages, this equipment will store each page as separate TIFF file.

[TIFF (MULTI)] — Press this to store the scanned data as a Multiple page TIFF file. When scanning several pages, this equipment will store all pages as one TIFF file.

9. Press the **[ENTER]** button.

- The screen returns to the filing menu.

10. Press the [START] button.

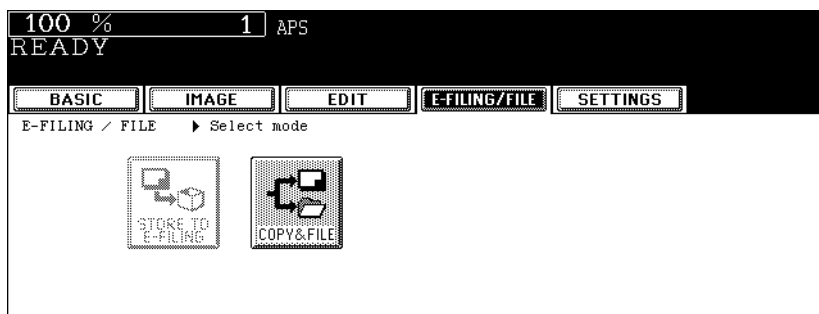

11. If the “NEXT ORIGINAL?” message is displayed, place another original on glass and press the [YES] button to copy another original, or press the [FINISHED] button to finish copying.

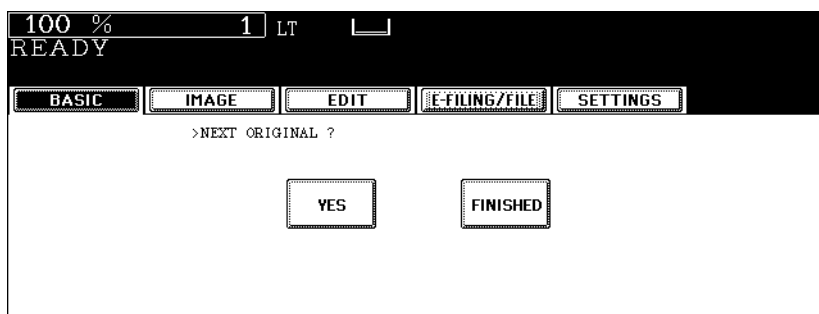

- When the original is set on the reversing automatic document feeder, this screen is not displayed.

7

INTERNET FAX

This section describes about the Internet Fax functions.

- **About Internet Fax** 84
- **How to Perform Internet Fax** 86
- **Receiving Internet Fax** 101

About Internet Fax

You can perform the Internet Fax function that provides the ability to transmit a scanned original as an E-mail, with an attached TIFF-FX (Profile S) file. Since an Internet line is used instead of a phone line, the communication cost can be reduced.

In this function, an E-mail address is specified in place of a phone number to transmit a scanned original to the Internet Fax equipment or the client computers.

When the Internet Fax is received, it is automatically output like regular Fax.

NOTE: The administrator needs to configure the network settings for Internet Fax to function. See the **Network Administration Guide**.

Precaution for Internet Transmission

Transmissions using the Internet Fax function are the same as E-mail transmissions. Before you start to use the Internet Fax function, it is recommended that you read this section and understand the precautions for Internet transmission.

- The Internet Fax sends a document to the E-mail server of Internet and it does not send via the PSTN* alike regular facsimile transmissions.
- Internet transmission has low security. It is recommended that you use regular facsimile transmission when confidential document is sent.
- It may take a considerable amount of time for the recipient to receive the document because of the line traffic in the Internet.
- If the document being transmitted has a large amount of data, it may not be successfully sent due to the configuration of the E-mail server.

* PSTN (Public Switched Telephone Network) is a global telephone system enables to communicate in worldwide using copper wires to transmit analog data.

Internet Fax Transmission Overview

The following is an overview of the various transmissions that can be performed using the Internet Fax function.

- **Internet Fax to Internet Fax**
The equipment can send a document to another Internet Fax equipment through the Internet or Intranet. The document is sent as an E-mail.

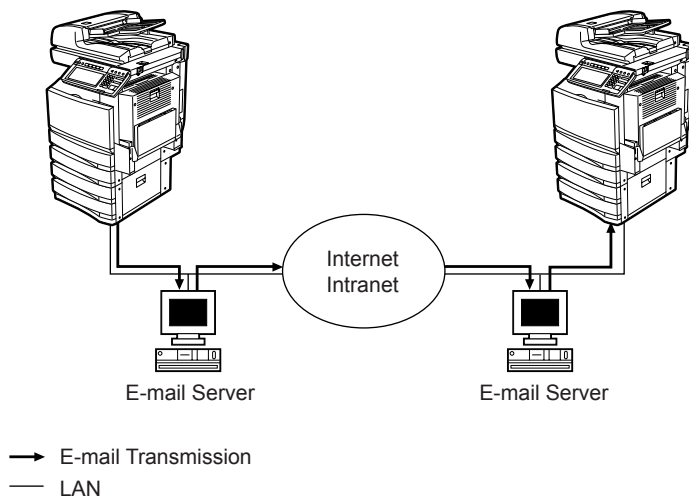

- **Internet Fax to/from Client Computers**

The equipment can send a document as an E-mail to client computers through the Internet or Intranet. The client computers can send an E-mail to the equipment as well.

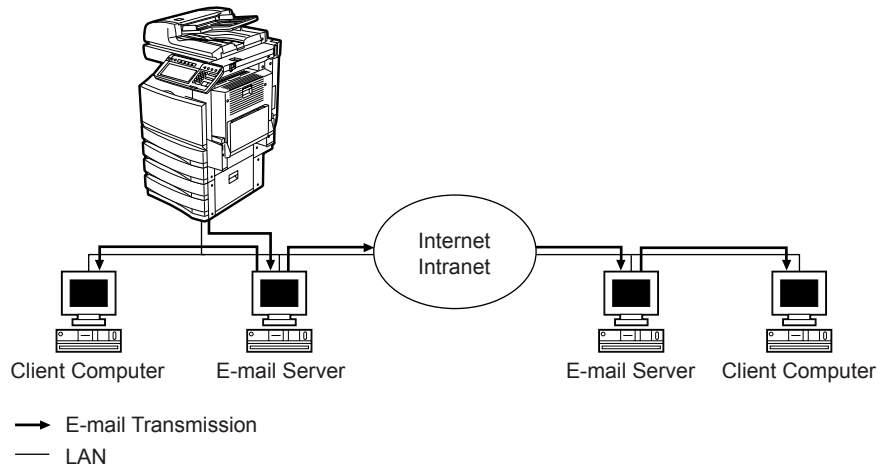

- NOTES:
- The client computer receives TIFF-FX (Profile S) images when the equipment sends a document using the Internet Fax function.
 - The equipment can only print out text files and TIFF images. When sending E-mail from the client computer to this equipment using the E-mail application, files other than text or TIFF images cannot be sent. For Available Format, see the following section.
- 📖 P.101 "Receiving Internet Fax".

How to Perform Internet Fax

In this function, the scanned data can be sent to the specified E-mail address as an attached file like Scan to E-mail function. However, the Internet Fax function allows to send originals as TIFF-FX (Profile S) file so that any Internet Fax compatible devices

NOTE: To use Internet Fax, the configuration of the equipment needs to be set by the network administrator.

Sending Procedure for Internet Fax

1. Press the [FAX] button on the control panel.

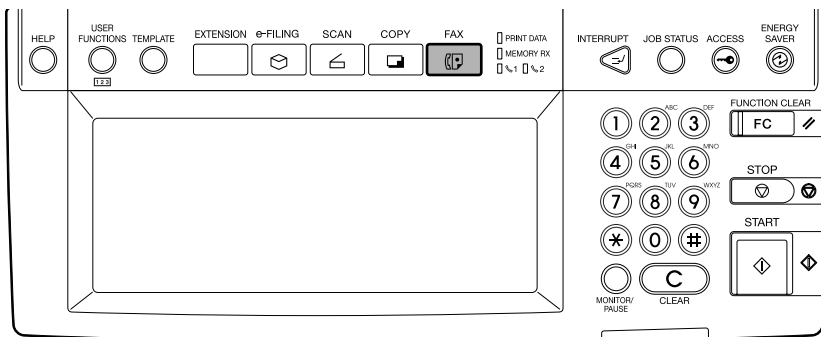

2. Press the [ADDRESS] button to display the address menu, and then press the [OPTION] button.

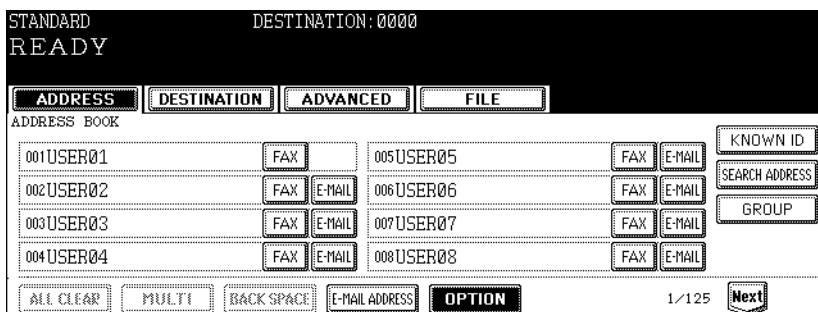

3. Specify the following items as you require and press the [Next] button.

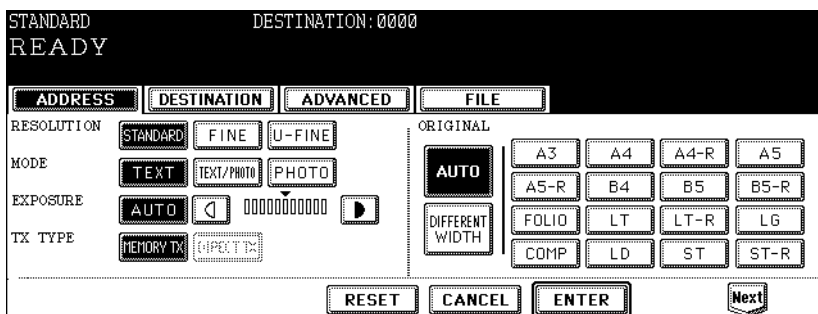

- **RESOLUTION**

Select the resolution before you scan the original to be sent.

- **MODE**

Set the image quality mode before you scan the original to be sent.

[TEXT] — Press this when scanning the originals that contain texts.

[TEXT/PHOTO] — Press this when scanning originals that contain texts and photos.

[PHOTO] — Press this when scanning originals that contain photos printed on photographic paper.

SUPPLEMENT: The transmission time may be longer than usual in case the PHOTO/TEXT or the PHOTO mode is selected.

- **EXPOSURE**

Set the image density according to the contrast of the original to be sent.

In the automatic exposure mode, the copier automatically judges the contrast of the original, and selects the optimum contrast.

In the manual exposure mode, you can adjust the contrast manually in 11 steps.

- **TX TYPE**

When sending Internet Fax, you can only select the [MEMORY TX] button.

- **ORIGINAL**

Select the button of the original size, or select the [AUTO] button to automatically detects the original size.

When placing the different width originals, select the [DIFFERENT WIDTH] button.

NOTE: For the Internet Fax, LT or LG size originals are sent in the same size as the originals. Originals larger than those sizes are reduced to LT to be sent. Originals smaller than those sizes are sent in LT without being enlarged.

4. Specify the following items as you require and press the [ENTER] button.

- **[SUBJECT]**

Press this to enter the subject of the Internet Fax to be sent.

- **[BODY]**

Press this to enter the body message of the Internet Fax to be sent.

SUPPLEMENT: When you press the [SUBJECT] or [BODY] button, the letter entry screen is displayed. Enter the value using the keyboard and digital keys, and press the [ENTER] button to set the entry.

NOTE: Other items such as "ECM", "QUALITY TX", "LINE SELECT", "[SUB/SEP]", "[SID/PWD]" are only applied to the fax transmission. When you only perform the Internet Fax transmission, you do not need to specify these items.

5. Specify the E-mail addresses that you want to send.

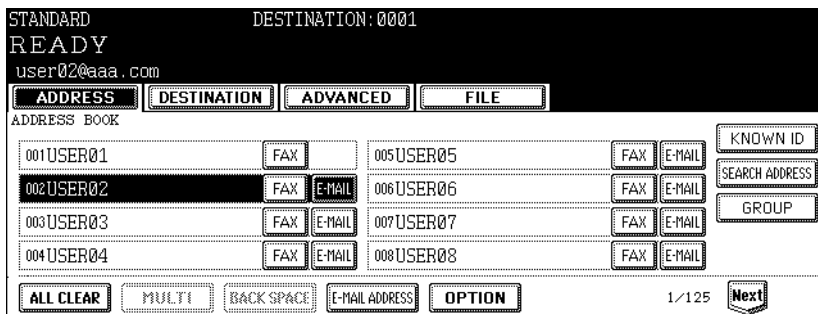

- You can specify the E-mail address by various ways. See the following procedures for each instruction.
 - 📖 P.88 "Specifying Destinations"

SUPPLEMENT: You can also set the advanced functions such as the 2-sided original transmission and priority transmission.

📖 P.98 "Advanced Function"

6. Press the [START] button.

- If the "To continue, place document on glass. And press [START]" message is displayed, place another original on glass and press [START] button to scan another original, or press the [JOB FINISH] button to finish scanning.

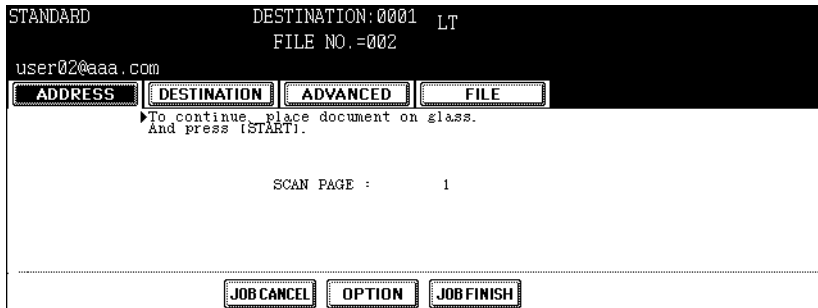

- When the original is set on the reversing automatic document feeder, this screen is not displayed.
- If you want to cancel the storage of the scanned data, press the [JOB CANCEL] button.
- You can change the setting of the transmission conditions, using the [OPTION] button before pressing the [START] button.

Specifying Destinations

You can specify E-mail addresses for Internet Fax by following methods:

- 📖 P.89 "Entering an E-mail address manually"
- 📖 P.90 "Selecting from address book"
- 📖 P.90 "Searching with ID number for a contact"
- 📖 P.91 "Searching with search strings from address book"
- 📖 P.92 "Searching with search strings from LDAP server"
- 📖 P.94 "Selecting from groups"
- 📖 P.95 "Searching with ID number of a group"

📖 P.96 "Searching with group name"

Entering an E-mail address manually

1. Press the [E-MAIL ADDRESS] button.

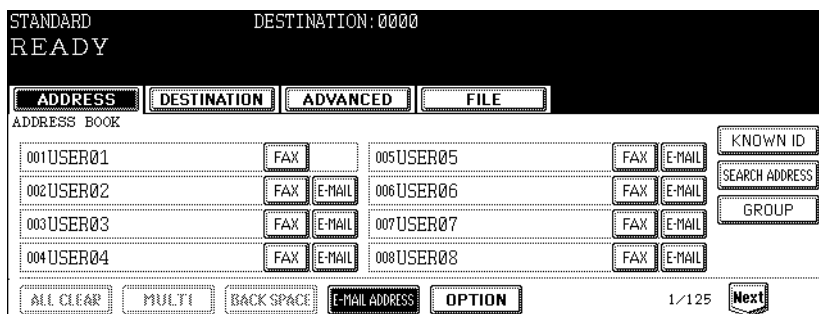

- The letter entry screen is displayed.

2. Enter the E-mail address that you want to send using the keyboard and digital keys, and press the [ENTER] button to set the entry.

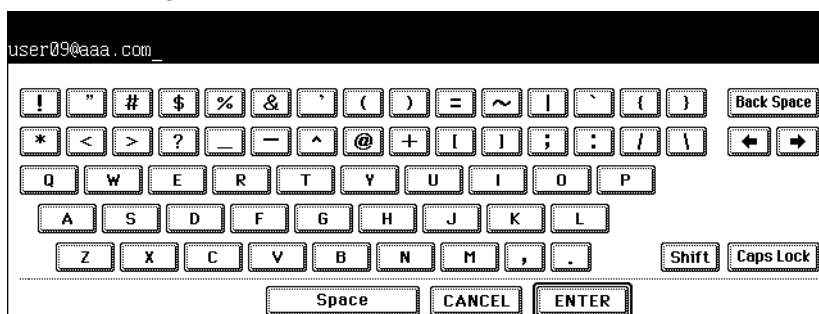

- The screen returns to the address menu.

3. Press the [MULTI] button and then press the [E-MAIL ADDRESS] button if you want to specify another E-mail address manually.

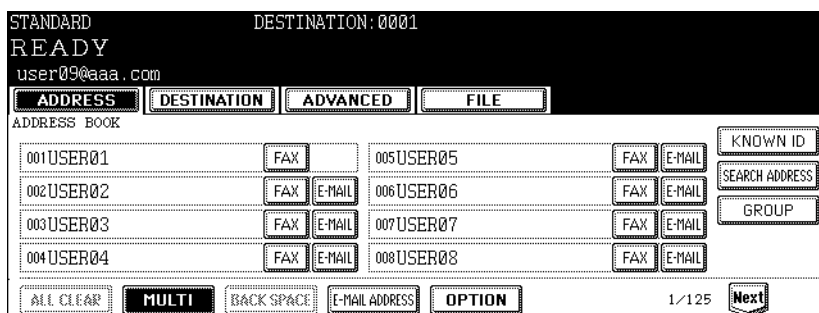

- If you press the [MULTI] button, the entered E-mail address is saved as the destination and you can enter another E-mail address using the [E-MAIL ADDRESS] button.
- If you press the [E-MAIL ADDRESS] button without pressing the [MULTI] button, you can edit the E-mail address that you entered.

- SUPPLEMENTS:
- You can specify other E-mail addresses as you require.
 - You can confirm or remove the E-mail addresses that you specified in the DESTINATION screen which can be displayed by pressing the [DESTINATION] button.
-  P.98 "Confirming or removing E-mail addresses from destination"

Selecting from address book

- Press the [E-MAIL] button of the contacts that you want to send.

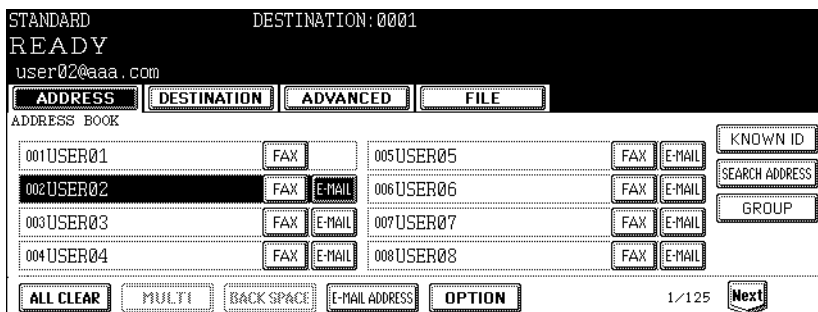

- The selected contacts are displayed as reversed buttons. To cancel the selection, press the contact again, then the button will be a normal button.

- SUPPLEMENTS:
- You can specify other E-mail addresses as you require.
 - You can confirm or remove the E-mail addresses that you specified in the DESTINATION screen which can be displayed by pressing the [DESTINATION] button.
-  P.98 "Confirming or removing E-mail addresses from destination"

Searching with ID number for a contact

- Press the [KNOWN ID] button.

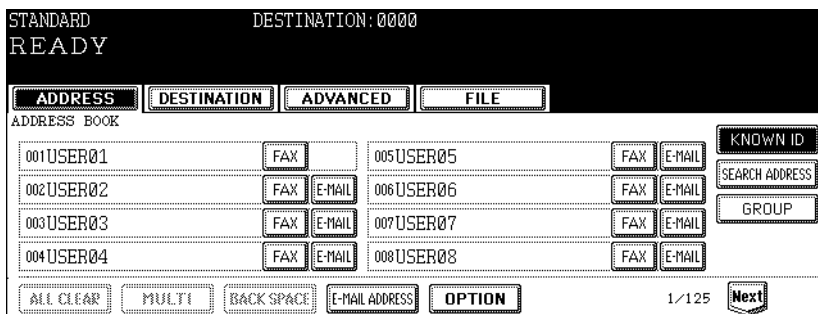

- The KNOWN ID screen is displayed.

2. Enter the ID number of the contact that you want to search using the digital keys, and press the [ENTER] button.

STANDARD DESTINATION: 0000
READY

ADDRESS DESTINATION ADVANCED FILE

KNOW N ID → Enter ID Number

KNOW N ID : 3

CANCEL ENTER

- The ADDRESS BOOK screen that contains the contact of the specified ID is displayed.

3. Press the [E-MIAL] button of the contact that you want to send.

STANDARD DESTINATION: 0001
READY
user03@aaa.com

ADDRESS DESTINATION ADVANCED FILE

ADDRESS BOOK

001 USER01	FAX	005 USER05	FAX	E-MAIL	KNOWN ID
002 USER02	FAX	E-MAIL	006 USER06	FAX	E-MAIL
003 USER03	FAX	E-MAIL	007 USER07	FAX	E-MAIL
004 USER04	FAX	E-MAIL	008 USER08	FAX	E-MAIL

SEARCH ADDRESS

GROUP

ALL CLEAR MULTI BACK SPACE E-MAIL ADDRESS OPTION

1/125 Next

- SUPPLEMENTS:
- You can specify other E-mail addresses as you require.
 - You can confirm or remove the E-mail addresses that you specified in the DESTINATION screen which can be displayed by pressing the [DESTINATION] button.
 P.98 "Confirming or removing E-mail addresses from destination"

Searching with search strings from address book

1. Press the [SEARCH ADDRESS] button.

STANDARD DESTINATION: 0000
READY

ADDRESS DESTINATION ADVANCED FILE

ADDRESS BOOK

001 USER01	FAX	005 USER05	FAX	E-MAIL	KNOWN ID
002 USER02	FAX	E-MAIL	006 USER06	FAX	E-MAIL
003 USER03	FAX	E-MAIL	007 USER07	FAX	E-MAIL
004 USER04	FAX	E-MAIL	008 USER08	FAX	E-MAIL

SEARCH ADDRESS

GROUP

ALL CLEAR MULTI BACK SPACE E-MAIL ADDRESS OPTION

1/125 Next

- The ADDRESS SEARCH screen is displayed.

2. Press the buttons to enter the search strings that you want to specify, and then enter the [SEARCH] button.

- When pressing each button, the letter entry screen is displayed. Enter the value using the keyboard and digital keys, and press the [ENTER] button to set the entry.

SUPPLEMENT: It will search for the contacts that contain the search text in the specified items.

NOTE: If the [DIR SERVICE] button is displayed a selected button, this equipment will search for contacts in the LDAP server. In that case, press the [DIR SERVICE] button to display the Directory Service Name screen and clear the selection of a directory service. Then press the [ENTER] button to return the ADDRESS SEARCH screen.

3. Press the contact that you want to send, and press the [ENTER] button.

- The screen returns to the ADDRESS BOOK screen.

SUPPLEMENTS:

- You can specify other E-mail addresses as you require.
- You can confirm or remove the E-mail addresses that you specified in the DESTINATION screen which can be displayed by pressing the [DESTINATION] button.
 P.98 "Confirming or removing E-mail addresses from destination"

Searching with search strings from LDAP server

NOTE: To search contacts in the LDAP server, the directory service must be registered using TopAccess by the network administrator.

1. Press the [SEARCH ADDRESS] button.

STANDARD DESTINATION: 0000
READY

ADDRESS DESTINATION ADVANCED FILE

ADDRESS BOOK

001USER01	FAX	005USER05	FAX	E-MAIL	KNOWN ID
002USER02	FAX	E-MAIL	006USER06	FAX	E-MAIL
003USER03	FAX	E-MAIL	007USER07	FAX	E-MAIL
004USER04	FAX	E-MAIL	008USER08	FAX	E-MAIL

ALL CLEAR MULTI BACK SPACE E-MAIL ADDRESS OPTION 1/125 Next

- The ADDRESS SEARCH screen is displayed.

2. Press the [DIR SERVICE] button.

DESTINATION: 0000

ADDRESS DESTINATION ADVANCED FILE

ADDRESS SEARCH

FIRST NAME [] CORP. []

LAST NAME [] DEPT. []

FAX NO. [] KEYWORD []

E-MAIL []

DIR SERVICE CLEAR CANCEL SEARCH

- The Directory Search Name screen is displayed.

SUPPLEMENT: When the [DIR SERVICE] button is displayed as a selected button, this equipment is currently configured to search a default directory service.

3. Select the directory service name that you want to search from, and press the [ENTER] button.

DESTINATION: 0000

ADDRESS DESTINATION ADVANCED FILE

Directory Search Name

dirserv1 []

dirserv2 []

dirserv3 []

CANCEL ENTER 1/1

- The screen returns to the ADDRESS SEARCH screen.

4. Press the buttons to enter the search strings that you want to specify, and then enter the [SEARCH] button.

DESTINATION: 0000

ADDRESS DESTINATION ADVANCED FILE

ADDRESS SEARCH

FIRST NAME	USER03	CORP.	
LAST NAME		DEPT.	
FAX NO.		KEYWORD	
E-MAIL			

DIR SERVICE CLEAR CANCEL SEARCH

- When pressing each button, the letter entry screen is displayed. Enter the value using the keyboard and digital keys, and press the [ENTER] button to set the entry.

SUPPLEMENT: It will search for the contacts that contain the search text in the specified items.

5. Press the [E-MAIL] button of the contact that you want to send, and press the [ENTER] button.

DESTINATION: 0001

user03@aaa.com

ADDRESS DESTINATION ADVANCED FILE

ADDRESS SEARCH

003USER03	FAX	E-MAIL	

ENTER 1/1

- The screen returns to the ADDRESS BOOK screen.

- SUPPLEMENTS:
- You can specify other E-mail addresses as you require.
 - You can confirm or remove the E-mail addresses that you specified in the DESTINATION screen which can be displayed by pressing the [DESTINATION] button.
-  P.98 "Confirming or removing E-mail addresses from destination"

Selecting from groups

1. Press the [GROUP] button.

STANDARD DESTINATION: 0000
READY

ADDRESS DESTINATION ADVANCED FILE

ADDRESS BOOK

001USER01	FAX		005USER05	FAX	E-MAIL	KNOWN ID
002USER02	FAX	E-MAIL	006USER06	FAX	E-MAIL	SEARCH ADDRESS
003USER03	FAX	E-MAIL	007USER07	FAX	E-MAIL	GROUP
004USER04	FAX	E-MAIL	008USER08	FAX	E-MAIL	

ALL CLEAR MULTI BACK SPACE E-MAIL ADDRESS OPTION 1/125 

- The GROUP screen is displayed.

2. Press the group buttons that you want to select as the destination.

STANDARD DESTINATION: 0003
READY

ADDRESS DESTINATION ADVANCED FILE

GROUP

001GROUP01	CONTENTS	005	KNOWN ID
002GROUP02	CONTENTS	006	SEARCH GROUP
003GROUP03	CONTENTS	007	ADDRESS BOOK
004		008	

ALL CLEAR MULTI BACK SPACE E-MAIL ADDRESS OPTION 1/25 Next

- SUPPLEMENTS:
- You can confirm the E-mail addresses that registered in the group by pressing the [CONTENTS] button.
 - You can specify other E-mail addresses as you require.
 - You can confirm or remove the E-mail addresses that you specified in the DESTINATION screen which can be displayed by pressing the [DESTINATION] button.
-  P.98 "Confirming or removing E-mail addresses from destination"

Searching with ID number of a group

1. Press the [GROUP] button.

STANDARD DESTINATION: 0000
READY

ADDRESS DESTINATION ADVANCED FILE

ADDRESS BOOK

001USER01	FAX	005USER05	FAX	E-MAIL	KNOWN ID
002USER02	FAX	006USER06	FAX	E-MAIL	SEARCH ADDRESS
003USER03	FAX	007USER07	FAX	E-MAIL	GROUP
004USER04	FAX	008USER08	FAX	E-MAIL	

ALL CLEAR MULTI BACK SPACE E-MAIL ADDRESS OPTION 1/125 Next

- The GROUP screen is displayed.

2. Press the [KNOWN ID] button.

STANDARD DESTINATION: 0000
READY

ADDRESS DESTINATION ADVANCED FILE

GROUP

001Group01	CONTENTS	005Group05	CONTENTS	KNOWN ID
002Group02	CONTENTS	006Group06	CONTENTS	SEARCH GROUP
003Group03	CONTENTS	007Group07	CONTENTS	ADDRESS BOOK
004Group04	CONTENTS	008Group08	CONTENTS	

ALL CLEAR MULTI BACK SPACE E-MAIL ADDRESS OPTION 1/25 Next

- The KNOWN ID screen is displayed.

- Enter the ID number of the group that you want to search using the digital keys, and press the [ENTER] button.

- The GROUP screen that contains the group of the specified ID is displayed.

- Press the group buttons that you want to select as the destination.

- SUPPLEMENTS:
- You can confirm the E-mail addresses that registered in the group by pressing the [CONTENTS] button.
 - You can specify other E-mail addresses as you require.
 - You can confirm or remove the E-mail addresses that you specified in the DESTINATION screen which can be displayed by pressing the [DESTINATION] button.
- P.98 "Confirming or removing E-mail addresses from destination"

Searching with group name

- Press the [GROUP] button.

- The GROUP screen is displayed.

2. Press the [SEARCH GROUP] button.

STANDARD DESTINATION: 0000
READY

ADDRESS DESTINATION ADVANCED FILE

GROUP

001Group01	CONTENTS	005Group05	CONTENTS	KNOWN ID
002Group02	CONTENTS	006Group06	CONTENTS	SEARCH GROUP
003Group03	CONTENTS	007Group07	CONTENTS	ADDRESS BOOK
004Group04	CONTENTS	008Group08	CONTENTS	

ALL CLEAR MULTI BACK SPACE E-MAIL ADDRESS OPTION 1/25 Next

- The KNOWN ID screen is displayed.

3. Press the [GROUP NAME] button to enter the group name that you want to search, and then press the [SEARCH] button.

DESTINATION: 0000

ADDRESS DESTINATION ADVANCED FILE

GROUP SEARCH

GROUP NAME Group09

CLEAR CANCEL SEARCH

- When pressing the [GROUP NAME] button, the letter entry screen is displayed. Enter the value using the keyboard and digital keys, and press the [ENTER] button to set the entry.

SUPPLEMENT: It will search for the groups that contain the search text in the group name.

4. Press the group buttons that you want to select as the destination, and press the [ENTER] button.

DESTINATION: 0004

ADDRESS DESTINATION ADVANCED FILE

GROUP SEARCH

009Group09	

ENTER 1/1

- The screen returns to the GROUP screen.

- SUPPLEMENTS:
- You can specify other E-mail addresses as you require.
 - You can confirm or remove the E-mail addresses that you specified in the DESTINATION screen which can be displayed by pressing the [DESTINATION] button.
- P.98 "Confirming or removing E-mail addresses from destination"

Confirming or removing E-mail addresses from destination

When you want to remove the E-mail addresses, contacts, or groups that are added as the destination, operate the following procedure.

1. Press the [DESTINATION] button.

DESTINATION: 0003

ADDRESS DESTINATION ADVANCED FILE

DESTINATION

USER02	E-MAIL	
USER05	E-MAIL	
USER07	E-MAIL	

DELETE 1/1

- The DESTINATION screen is displayed.

2. You can confirm the destinations that are currently specified. To remove E-mail addresses, contacts, or groups that you selected for destination, select the name that you want to remove, and press the [DELETE] button.

DESTINATION: 0003

ADDRESS DESTINATION ADVANCED FILE

DESTINATION

USER02	E-MAIL	
USER05	E-MAIL	
USER07	E-MAIL	

DELETE 1/1

Advanced Function

The following advanced function can be used.

- 2-sided original TX:** 2-sided originals can be sent using the reversing automatic document feeder.
- Priority TX:** You can send originals prior to the reserved transmissions.

Sending 2-sided Originals

You can scan and send 2-sided originals using the reversing automatic document feeder. Whenever a transmission is completed, the condition will automatically return to the default setting.

- Setting originals when sending LT/A4 2-sided originals
To set the originals on the reversing automatic document feeder, change the direction of original feeding depending on the bound position.

When sending 2-sided originals bound with open to left

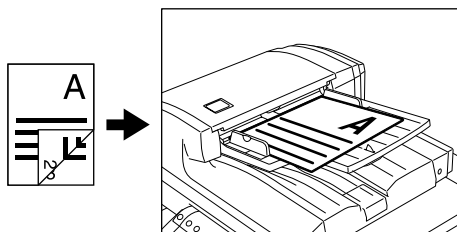

When sending 2-sided originals bound with open to top

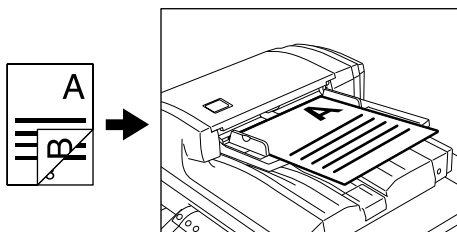

1. Press the [ADVANCED] button to display the advanced menu, and then press the [2-SIDED SCAN] button.

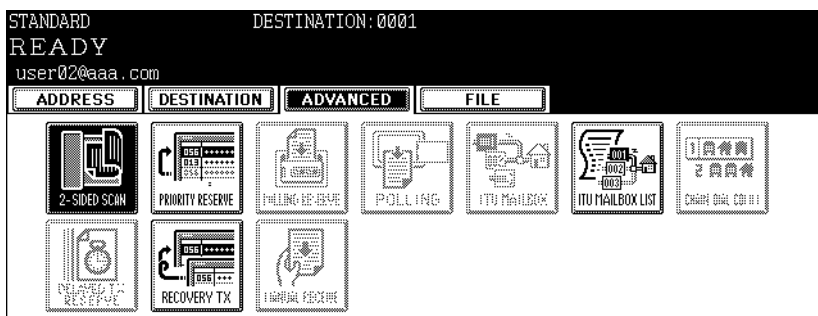

- The 2-SIDED SCAN screen is displayed.

2. Select the original type either the [BOOK] or [TABLET] button, and then press the [ENTER] button.

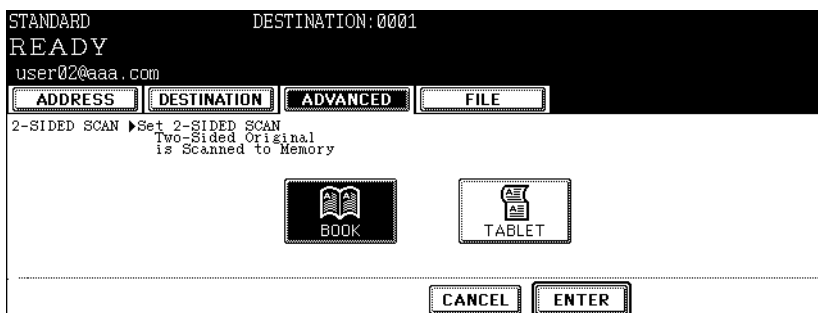

- The screen returns to the advanced menu.

3. Press the [ADDRESS] button to return to the address menu.

Priority Transmission

Priority TX allows you to execute a transmission prior to the other reserved transmissions.

- NOTES:
- You can use 'Direct Entry' and 'Address Dialing' to specify the recipients.
 - Priority TX can be performed only for 1 transmission.

1. Press the **[ADVANCED]** button to display the advanced menu, and then press the **[PRIORITY RESERVE]** button.

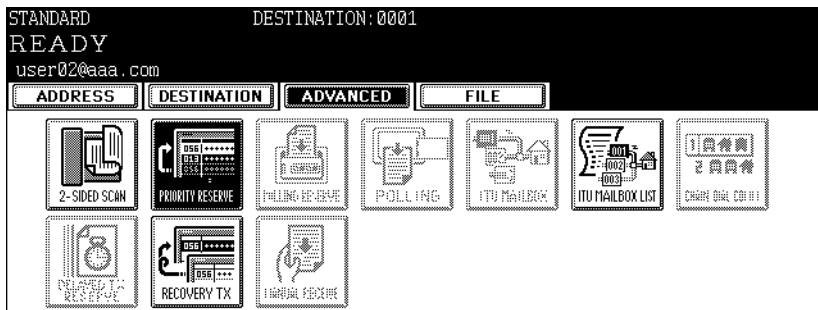

- The PRIORITY RESERVE screen is displayed.

2. Press the **[ENTER]** button.



- The screen returns to the advanced menu.

3. Press the **[ADDRESS]** button to return to the address menu.

Receiving Internet Fax

The equipment accesses the E-mail server at specified intervals to check whether any E-mail has been delivered. If an E-mail has been delivered, the equipment will automatically retrieve and print out the E-mail.

When the [CHECK E-MAIL] button is pressed, the equipment manually accesses the E-mail server to check whether any E-mail has been delivered. If an E-mail has been delivered, the equipment receives and prints out the E-mail.

Available Format:

The TIFF-FX images, TIFF images scanned by the scanner and the text data can be printed. In addition, the resolution of the TIFF-FX image must be 8 x 3.85, 8 x 7.7 or 8 x 15.4 (dot/mm). The resolution of the TIFF images scanned by the scanner must be 200 x 100, 200 x 200, 200 x 400, 400 x 400 or 600 x 600 (dpi). If the received E-mail contains files that are not the ones described above, an error message will be displayed in the receive log.

To avoid such a case, you can print the report when an error occurs for E-mail printing and also forwarding this E-mail to another E-mail address can be set.

If you want to print the report when an error occurs for E-mail printing, set up “Enable Print E-mail Error”.

If you want to forward the E-mail to another E-mail address when an error occurs, set up “Enable E-mail Error Forward” and “E-mail Error Transfer Address”.

See the “Setting up the E-mail Print” in the **TopAccess Guide**.

Receiving Automatically

To automatically receive the Internet Fax from the E-mail server, set up the “Scan Rate” in the POP3 Network Service setting using TopAccess.

Checking whether any E-mail has been delivered at specified intervals will be performed automatically. (Default setting: every 5 minutes)

For setting the “Scan Rate”, see **TopAccess Guide**.

Receiving Manually

1. Press the [USER FUNCTIONS] button on the control panel.

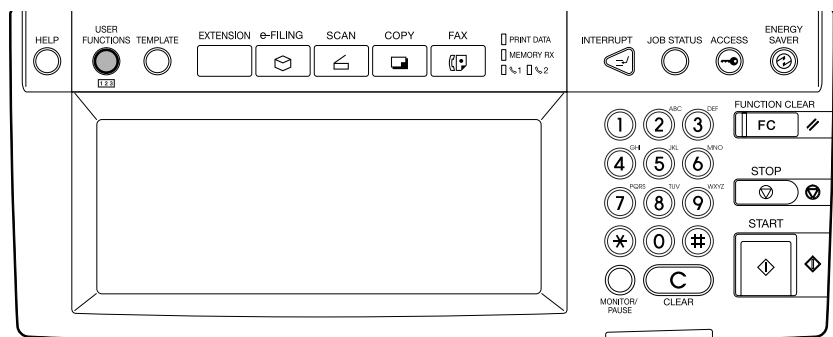

2. Press the [USER] button, and then press the [CHECK E-MAIL].

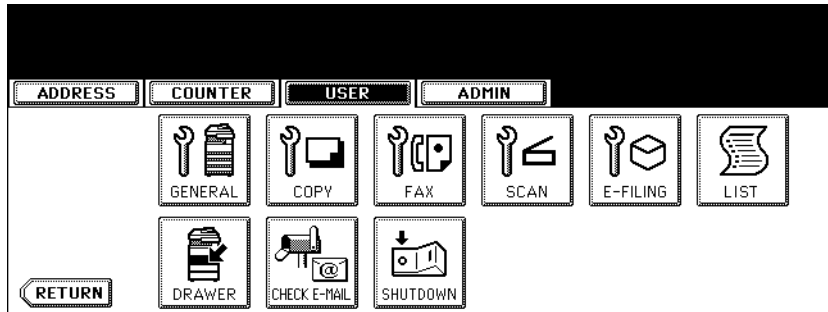

- Checking whether any E-mail has been delivered starts.

3. Checking completes.

- If the Internet Fax is received, “RECEIVING E-mail” appears on the screen upper right. Next, “NEW E-mail RECEIVED” appears for 2 seconds. Then, printing the Internet Fax starts.
- If no Internet Fax is received, “CURRENTLY NO E-mail” appears on the screen upper right for 2 seconds.

INDEX

INDEX

Numerics

2-SIDED SCAN 99

A

Advanced Function 98

AUTHENTICATION 41

AUTOMATIC START 71, 75

B

BACKGROUND ADJUSTMENT 26, 35, 45

BOX/FOLDER 23

C

COLOR MODE 25, 34, 44

COMMAND PORT 32, 80

COPY & FILE 78

D

DIFFERENT WIDTH 87

E

E-MAIL ADDRESS 46, 89

E-MAIL CC 42

EXPOSURE 26, 35, 45, 87

F

FILE FORMAT 33, 42, 81

FRAGMENT MESSAGE SIZE 43

FROM ADDRESS 43

FROM NAME 43

G

GROUP 53, 54, 55, 94, 95, 96

GROUP NAME 56, 97

I

Internet Fax 83

Internet Fax Transmission Overview 84

J

JPEG 33, 42

JPEG COMPRESS 26, 35, 45

K

KNOWN ID 48, 54, 90, 95

L

LOGIN USER NAME 32, 33, 80, 81

M

MFP LOCAL 31, 79

MIXED ORIGINAL SIZE 26, 35, 44

MODE 87

Multiple Agents 14

N

NAME 1 71, 74

NAME 2 71, 74

NETWORK PATH 32, 33, 80, 81

O

ORIGINAL 87

ORIGINAL MODE 25, 34, 44

ORIGINAL SIZE 26, 35, 44

P

PASSWORD 32, 33, 71, 75, 80, 81

PDF 33, 42, 81

Precaution for Internet Transmission 84

PRIORITY RESERVE 100

Priority Transmission 100

R

Receiving from POP3 Server 101

REMOTE 1 31, 79

REMOTE 2 31, 79

RESOLUTION 26, 34, 44, 86

ROTATION 25, 34, 44

S

Scan Mode 10

SCAN TO E-FILING 13, 15, 23

Scan to e-Filing mode 10

..... 13

SCAN TO E-MAIL 15, 40, 64

Scan to E-mail mode 11

SCAN TO FILE 13, 15, 30

Scan to File mode 10

SEARCH ADDRESS 49, 51, 91, 93

SEARCH GROUP 56, 97

Sending 2-sided Originals 98

SERVER NAME 32, 80

Single Agent 12

SINGLE/2-SIDED SCAN 25, 34, 43

T

TIFF (MULTI) 33, 42, 81

TIFF (SINGLE) 33, 42, 81

TX TYPE 87

U

USER NAME 71, 74

MULTIFUNCTIONAL DIGITAL COLOR SYSTEMS

Scanning Guide

e-STUDIO281c/351c/451c

TOSHIBA TEC CORPORATION

2-17-2, HIGASHIGOTANDA, SHINAGAWA-KU, TOKYO, 141-8664, JAPAN

Free Manuals Download Website

<http://myh66.com>

<http://usermanuals.us>

<http://www.somanuals.com>

<http://www.4manuals.cc>

<http://www.manual-lib.com>

<http://www.404manual.com>

<http://www.luxmanual.com>

<http://aubethermostatmanual.com>

Golf course search by state

<http://golfingnear.com>

Email search by domain

<http://emailbydomain.com>

Auto manuals search

<http://auto.somanuals.com>

TV manuals search

<http://tv.somanuals.com>