

TOSHIBA

MULTIFUNCTIONAL DIGITAL SYSTEMS

Scanning Guide

e-STUDIO352/452

e-STUDIO202L/232/282

SOFTWARE LICENSE AGREEMENT

INSTALLING OR OTHERWISE USING THIS SOFTWARE PRODUCT CONSTITUTES YOUR ACCEPTANCE OF THE FOLLOWING TERMS AND CONDITIONS (UNLESS A SEPARATE LICENSE IS PROVIDED BY THE SUPPLIER OF APPLICABLE SOFTWARE IN WHICH CASE SUCH SEPARATE LICENSE SHALL APPLY). IF YOU DO NOT ACCEPT THESE TERMS, YOU MAY NOT INSTALL OR USE THIS SOFTWARE, AND YOU MUST PROMPTLY RETURN THE SOFTWARE TO THE LOCATION WHERE YOU OBTAINED IT.

THE SOFTWARE INSTALLED ON THIS PRODUCT INCLUDES NUMEROUS INDIVIDUAL SOFTWARE COMPONENTS, EACH HAVING ITS OWN APPLICABLE END USER LICENSE AGREEMENT ("EULA"). INFORMATION RELATING TO THE EULAS MAY BE FOUND IN AN ELECTRONIC FILE INCLUDED ON THE USER DOCUMENTATION CD-ROM INCLUDED HEREWITH; HOWEVER, ALL SOFTWARE AND DOCUMENTATION DEVELOPED OR CREATED BY OR FOR TOSHIBA TEC CORPORATION ("TTEC") ARE PROPRIETARY PRODUCTS OF TTEC AND ARE PROTECTED BY COPYRIGHT LAWS, INTERNATIONAL TREATY PROVISIONS, AND OTHER APPLICABLE LAWS.

Grant of License

This is a legal agreement between you, the end-user ("You"), and TTEC and its suppliers. This software, fonts (including their typefaces) and related documentation ("Software") is licensed for use with the system CPU on which it was installed ("System") in accordance with the terms contained in this Agreement. This Software is proprietary to TTEC and/or its suppliers.

TTEC and its suppliers disclaim responsibility for the installation and/or use of this Software, and for the results obtained by using this Software. You may use one copy of the Software as installed on a single System, and may not copy the Software for any reason except as necessary to use the Software on a single System. Any copies of the Software shall be subject to the conditions of this Agreement.

You may not, nor cause or permit any third party to, modify, adapt, merge, translate, reverse compile, reverse assemble, or reverse engineer the Software. You may not use the Software, except in accordance with this license. No title to the intellectual property in the Software is transferred to you and full ownership is retained by TTEC or its suppliers. Source code of the Software is not licensed to you. You will be held legally responsible for any copyright infringement, unauthorized transfer, reproduction or use of the Software or its documentation.

Term

This license is effective until terminated by TTEC or upon your failure to comply with any term of this Agreement. Upon termination, you agree to destroy all copies of the Software and its documentation.

You may terminate this license at any time by destroying the Software and its documentation and all copies.

Disclaimer of Warranty

THIS SOFTWARE IS PROVIDED "AS IS" WITHOUT WARRANTY OF ANY KIND, EITHER EXPRESS OR IMPLIED, INCLUDING, BUT NOT LIMITED TO, THE IMPLIED WARRANTIES OF MERCHANTABILITY, FITNESS FOR A PARTICULAR PURPOSE, TITLE, AND NON-INFRINGEMENT. TTEC AND ITS SUPPLIERS DISCLAIM ANY WARRANTY RELATING TO THE QUALITY AND PERFORMANCE OF THE SOFTWARE. IF THE SOFTWARE PROVES DEFECTIVE, YOU (AND NOT TTEC OR ITS SUPPLIERS) SHALL BE RESPONSIBLE FOR THE ENTIRE COST OF ALL NECESSARY SERVICING, REPAIR OR CORRECTION. TTEC AND ITS SUPPLIERS DO NOT WARRANT THAT THE FUNCTIONS CONTAINED IN THE SOFTWARE WILL MEET YOUR REQUIREMENTS OR THAT THE OPERATION OF THE SOFTWARE WILL BE UNINTERRUPTED OR ERROR FREE.

ALL INFORMATION CONTAINED HEREIN THAT IS PROVIDED BY TTEC AND ITS AFFILIATES PURSUANT TO A EULA IS PROVIDED "AS IS" WITHOUT WARRANTY OF ANY KIND, EITHER EXPRESS OR IMPLIED.

Limitation of Liability

IN NO EVENT WILL TTEC OR ITS SUPPLIERS BE LIABLE TO YOU FOR ANY DAMAGES, WHETHER IN CONTRACT, TORT, OR OTHERWISE (EXCEPT PERSONAL INJURY OR DEATH RESULTING FROM NEGLIGENCE ON THE PART OF TTEC OR ITS SUPPLIERS), INCLUDING WITHOUT LIMITATION ANY LOST PROFITS, LOST DATA, LOST SAVINGS OR OTHER INCIDENTAL, SPECIAL OR CONSEQUENTIAL DAMAGES ARISING OUT OF THE USE OR INABILITY TO USE THE SOFTWARE, EVEN IF TTEC OR ITS SUPPLIERS HAVE BEEN ADVISED OF THE POSSIBILITY OF SUCH DAMAGES, NOR FOR THIRD PARTY CLAIMS.

U.S. Government Restricted Rights

The Software is provided with RESTRICTED RIGHTS. Use, duplication or disclosure by the U.S. Government is subject to restrictions set forth in subdivision (b) (3) (I) or (c) (i) (ii) of the Rights in Technical Data and Computer Software Clause set forth in 252.227-7013, or 52.227-19 (c) (2) of the DOD FAR, as appropriate. Contractor/Manufacturer is TOSHIBA TEC Corporation, 6-78, Minami-cho, Mishima-shi, Shizuoka-ken, 411-8520, Japan.

General

You may not sublicense, lease, rent, assign or transfer this license or the Software. Any attempt to sublicense, lease, rent, assign or transfer any of the rights, duties or obligations hereunder is void. You agree that you do not intend to, and will not ship, transmit (directly or indirectly) the Software, including any copies of the Software, or any technical data contained in the Software or its media, or any direct product thereof, to any country or destination prohibited by the United States Government. This license shall be governed by the laws of Japan or, at the election of a Supplier of TTEC concerned with a dispute arising from or relating to this Agreement, the laws of the Country designated from time to time by the relevant Supplier of TTEC. If any provision or portion of this Agreement shall be found to be illegal, invalid or unenforceable, the remaining provisions or portions shall remain in full force and effect.

YOU ACKNOWLEDGE THAT YOU HAVE READ THIS LICENSE AGREEMENT AND THAT YOU UNDERSTAND ITS PROVISIONS. YOU AGREE TO BE BOUND BY ITS TERMS AND CONDITIONS. YOU FURTHER AGREE THAT THIS LICENSE AGREEMENT CONTAINS THE COMPLETE AND EXCLUSIVE AGREEMENT BETWEEN YOU AND TTEC AND ITS SUPPLIERS AND SUPERSEDES ANY PROPOSAL OR PRIOR AGREEMENT, ORAL OR WRITTEN, OR ANY OTHER COMMUNICATION RELATING TO THE SUBJECT MATTER OF THIS LICENSE AGREEMENT.

TOSHIBA TEC Corporation, 6-78, Minami-cho, Mishima-shi, Shizuoka-ken, 411-8520, Japan.

TRADEMARKS AND COPYRIGHT

Trademarks

- The official name of Windows 98 is Microsoft Windows 98 Operating System.
- The official name of Windows Me is Microsoft Windows Me Operating System.
- The official name of Windows 2000 is Microsoft Windows 2000 Operating System.
- The official name of Windows XP is Microsoft Windows XP Operating System.
- The official name of Windows Vista is Microsoft Windows Vista Operating System.
- The official name of Windows Server 2003 is Microsoft Windows Server 2003 Operating System.
- Microsoft, Windows, Windows NT, and the brand names and product names of other Microsoft products are trademarks of Microsoft Corporation in the US and other countries.
- Apple, AppleTalk, Macintosh, Mac, TrueType, and LaserWriter are trademarks of Apple Computer, Inc. in the US and other countries.
- Postscript is a trademark of Adobe Systems Incorporated.
- Netscape is a trademark of Netscape Communications Corporation.
- IBM, AT and AIX are trademarks of International Business Machines Corporation.
- NOVELL, NetWare, and NDS are trademarks of Novell, Inc.
- Other company names and product names in this manual are the trademarks of their respective companies.

Copyright

© 2005 TOSHIBA TEC CORPORATION All rights reserved

Under the copyright laws, this manual cannot be reproduced in any form without prior written permission of TTEC. No patent liability is assumed, however, with respect to the use of the information contained herein.

Preface

Thank you for purchasing e-STUDIO452 Series or e-STUDIO282 Series Multifunctional Digital Systems. This guide provides instructions on how to scan the originals using the equipment. Read this guide before scanning on your e-STUDIO452 Series or e-STUDIO282 Series. Keep this guide within easy reach, and use it to configure an environment that makes best use of the e-STUDIO's functions.

About This Guide

This manual describes how to scan the originals using the equipment.

Conventions

- The term “this equipment” in this manual refers to the e-STUDIO452 Series or e-STUDIO282 Series.
- The term “e-Filing” in this manual is an abbreviation of “electronic filing”.

Lineup of Our Manuals

Thank you for purchasing the TOSHIBA multifunctional digital systems e-STUDIO452 Series or e-STUDIO282 Series.

We have provided you with these manuals for the operation of this equipment. Select and read the manual best suited to your needs.

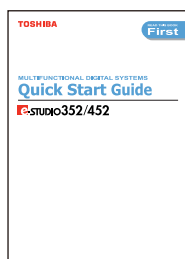

Quick Start Guide

This Quick Start Guide describes the initial setup method of this equipment and accessories of this product such as operator's manuals and CD-ROMs.

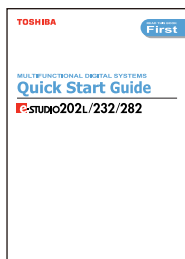

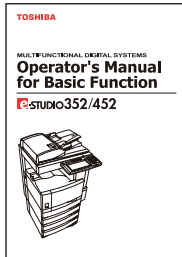

Operator's Manual Basic Functions

This Operator's Manual Basic Functions describes how to use the basic functions of this equipment mainly focusing on the copying function. Also this manual contains safety precautions for users to be observed. Be sure to read it first carefully.

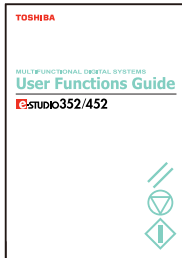

User Functions Guide

This User Functions Guide describes the functions and settings under the [USER FUNCTIONS] button on the control panel of this equipment.



Other guides are provided by the User Documentation CD-ROM in PDF files:

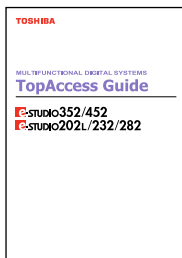

TopAccess Guide

This TopAccess Guide explains how to operate and set up the network functions such as the network scanning function and job management, using the TopAccess (Web-based utility) from client computers.

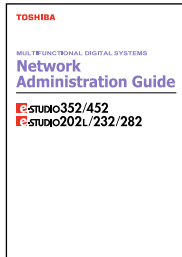

Network Administration Guide

This Network Administration Guide explains the guidelines for setting up network servers to provide various network services, and troubleshooting for network administrators.

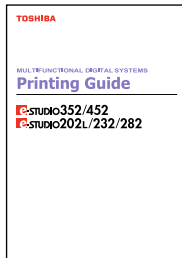

Printing Guide

This Printing Guide explains how to install the client software for printing from Microsoft Windows, Apple Mac OS, and UNIX computers, and print to the equipment.

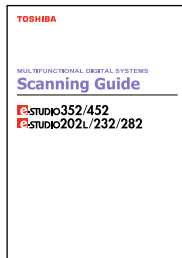

Scanning Guide

This Scanning Guide explains how to operate the scanning function of this equipment.

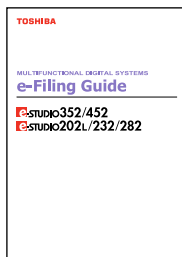

e-Filing Guide

This e-Filing Guide explains how to operate the e-Filing function using the TWAIN driver, File Downloader and e-Filing web utility.

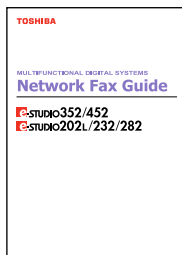

Network Fax Guide

This Network Fax Guide explains how to use the network fax function that enable users to operate fax and internet fax sending from a client computer via network.

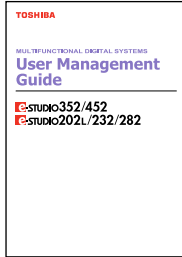

User Management Guide

This User Management Guide describes how to manage this equipment using the functions of “Department Management”, “User Management Setting” and “User Authentication for Scan to E-mail”.

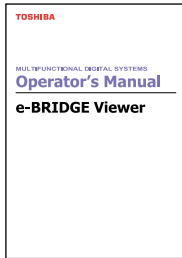

e-BRIDGE Viewer

The e-BRIDGE Viewer provides the functions to view and find the documents in e-Filing boxes on the TOSHIBA e-STUDIO MULTIFUNCTIONAL DIGITAL SYSTEMS from a client computer via TCP/IP network, and also it can view and find the files in your computer.

To read manuals in PDF (Portable Document Format) files

Viewing and printing this operator's manual in PDF files require that you install Adobe Reader or Adobe Acrobat Reader on your PC. If Adobe Reader or Adobe Acrobat Reader is not installed on your PC, download and install it from the website of Adobe Systems Incorporated.

Precautions in this manual

To ensure correct and safe use of this equipment, this operator's manual describes safety precautions according to the three levels shown below.

You should fully understand the meaning and importance of these items before reading this manual.

Warning

Indicates a potentially hazardous situation which, if not avoided, could result in death, serious injury, or serious damage, or fire in the equipment or surrounding assets.

Caution

Indicates a potentially hazardous situation which, if not avoided, may result in minor or moderate injury, partial damage of the equipment or surrounding assets, or loss of data.

Note

Indicates a procedure you should follow to ensure the optimal performance of the equipment and problem-free copying.

Other than the above, this manual also describes information that may be useful for the operation of this equipment with the following signage:

Tip

Describes handy information that is useful to know when operating the equipment.

Important

They provide important descriptions of the operation.



Pages describing items related to what you are currently doing. See these pages as required.

TABLE OF CONTENTS

SOFTWARE LICENSE AGREEMENT	3
TRADEMARKS AND COPYRIGHT	5
Preface.....	6
About This Guide.....	6
Conventions	6
Lineup of Our Manuals	6
To read manuals in PDF (Portable Document Format) files	9
Precautions in this manual	10

Chapter 1 Overview

About Scan Features.....	16
About Scan Mode.....	16
Scan to e-Filing Mode	16
Scan to File Mode	17
Scan to E-mail Mode.....	17
How to Perform Scan Operations	18
Confirming the Scan Job Status	24
Confirming the Scan Log.....	25

Chapter 2 Scan to e-Filing

How to Perform Scan to e-Filing	28
How to Use Scanned Data Stored in e-Filing.....	35
Using Scanned Data in e-Filing from Touch Panel Display.....	35
Using Scanned Data in e-Filing from e-Filing Web Utility.....	35

Chapter 3 Scan to File

How to Perform Scan to File.....	38
How to Use Scanned Data Stored as Files.....	47
When Scanned Data Is Stored in MFP LOCAL.....	47
When Scanned Data Is Stored in REMOTE 1 or 2.....	47

Chapter 4 Scan to E-mail

How to Perform Scan to E-mail	50
Specifying Destinations	56

Chapter 5 Using Template

Scanning Using Template.....	70
Registering Scan Template	78

Chapter 6 Copy & File

How to Perform Copy & File	88
----------------------------------	----

Chapter 7 Internet Fax

About Internet Fax.....	96
Precaution for Internet Transmission.....	96
Internet Fax Transmission Overview	96
How to Perform Internet Fax	98
Specifying Destinations	101
Advanced Function.....	112
Sending 2-sided Originals	112
Priority Transmission.....	113
Receiving Internet Fax	115

Chapter 8 Remote Scan

Installing Remote Scan Driver.....	118
Planning for Installation	118
Installing the Remote Scan Driver.....	118
Installing from Client Utilities CD-ROM	118
Installing from TopAccess	121
Scanning Remotely Using Remote Scan Driver	123
How to Scan	123
When You Are Running the First Time.....	124
Configuring Discovery Settings	126
How to Use Remote Scan Driver.....	127
Adding a New Device Using Network Discovery	130
Changing the Target Device.....	130
Remote Scan Driver Errors.....	132
Remote Scan Driver Error Conditions	132
Cannot Find the Device.....	132
Cannot Connect to the Device Found by Discovery.....	132
Cannot Acquire Document	133

Chapter 9 Web Service SCAN

Preparing “Web Service Scan”	136
Planning and preparation	136
Installing a Driver.....	136
How to Perform Web Service Scan Operations	137
INDEX	139

1

Overview

This section describes the overview of the scan functions.

About Scan Features	16
About Scan Mode.....	16
How to Perform Scan Operations.....	18
Confirming the Scan Job Status.....	24
Confirming the Scan Log	25

About Scan Features

This section describes about the scan features.

About Scan Mode

If the scanning function is used, originals set on the Automatic Document Feeder or on the original glass can easily be scanned as image data. This equipment can save scanned images into e-Filing or shared folder in the equipment. This equipment also can send scanned images to e-mail addresses.

The scanning function is available only when the Scanner Kit or Printer/Scanner Kit is installed.

This equipment supports four scan modes, Scan to e-Filing, Scan to File, Scan to E-mail and WS Scan.

Scan to e-Filing Mode

Scan to e-Filing mode allows users to store scanned images as e-Filing documents in the equipment. Once users store the scanned images as e-Filing documents, the documents can be managed by creating boxes and folders. Users can work with e-Filing documents such as printing them, merging them to create a new document, and so on, using the e-Filing web utility. The e-Filing documents also can be retrieved into user's computer using TWAIN driver or File Downloader.

In the e-Filing boxes, up to 5GB of data can be stored. The available size is displayed in the Device tab page in TopAccess.

Notes

- Delete the documents in e-Filing when they are no longer needed.
- You cannot access the e-Filing box in Mac OS.

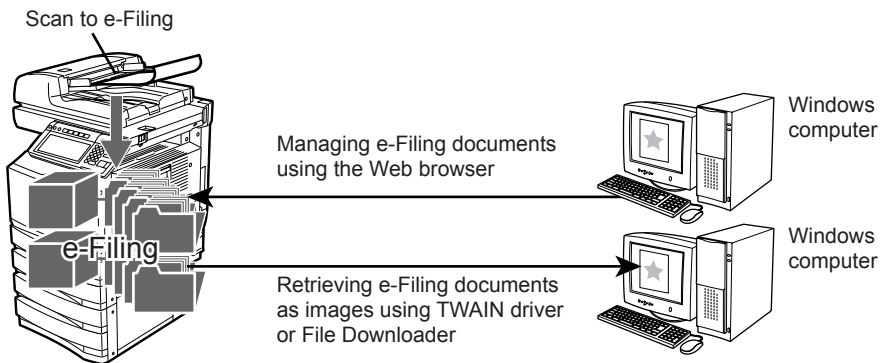

For instructions on how to perform Scan to e-Filing, see the following section.

 P.27 "Scan to e-Filing"

Tip

For more information about e-Filing, please see **e-Filing Guide**.

Scan to File Mode

Scan to File mode allows users to save scanned images as PDF, XPS or TIFF files either the shared folder in the equipment, or network folder in another computer. Users can use saved files by copying them from the folder where users save the scanned images.

In the shared folder in the equipment, up to 5 GB of data can be stored. The available size is displayed in the Device tab page in TopAccess.

Note

Delete the files in the shared folder when they are no longer needed.

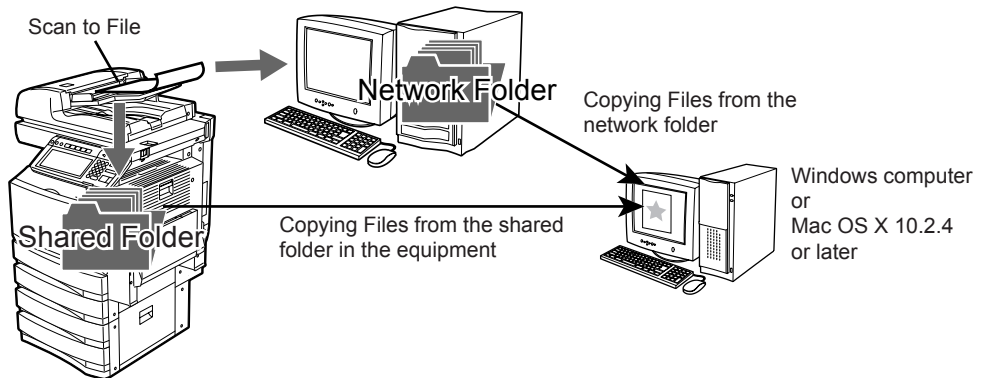

For instructions on how to perform Scan to File, see the following section.

P.37 "Scan to File"

Tip

The Copy & File function, which enables users to copy and store as file at the same time, also will be available. For instruction on how to perform Copy & File, see the following section.

P.87 "Copy & File"

Scan to E-mail Mode

Scan to E-mail mode allows users to send scanned images to specified e-mail addresses.

When users perform Scan to E-mail, the scanned image will be converted to a PDF, XPS, TIFF, or JPEG file and send them as an attached file of the E-mail message.

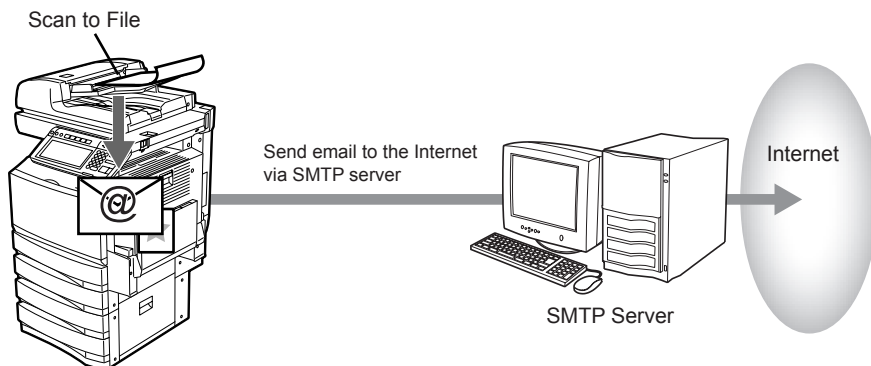

For instructions on how to perform Scan to E-mail, see the following section.

P.49 "Scan to E-mail"

How to Perform Scan Operations

Users can scan originals not only by selecting one of the scan modes, but also by combining two scan modes at a single operation.

The following procedures describe about the basic instructions on how to perform the scan operations.

📖 P.18 “Scanning Procedure for Single Agent”

📖 P.20 “Scanning Procedure for Dual Agents”

Tips

- Users can use a template to perform a scan operation as well. For more information about a template, see the following section.
📖 P.69 “Using Template”
- Users can perform Copy & File, which enables users to copy the originals as well as storing the originals as a file. For more information about Copy & File, see the following section.
📖 P.87 “Copy & File”

Scanning Procedure for Single Agent

1 Place the original(s).

- For instruction about placing the originals, see *Operator’s Manual for Basic Function*.

2 Press the [SCAN] button on the control panel to enter the scan menu.

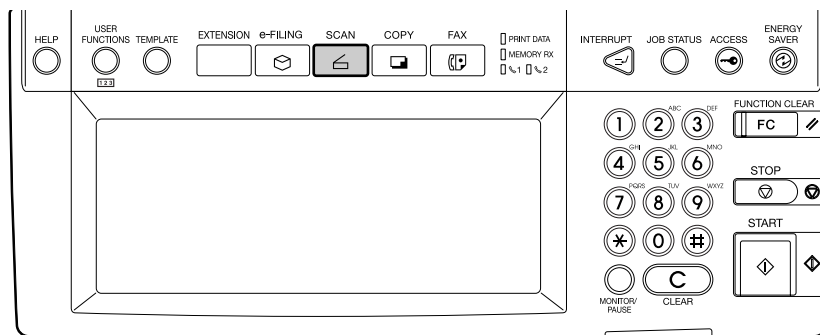

- The basic scan menu is displayed.

3 Select a button of the desired scan mode.

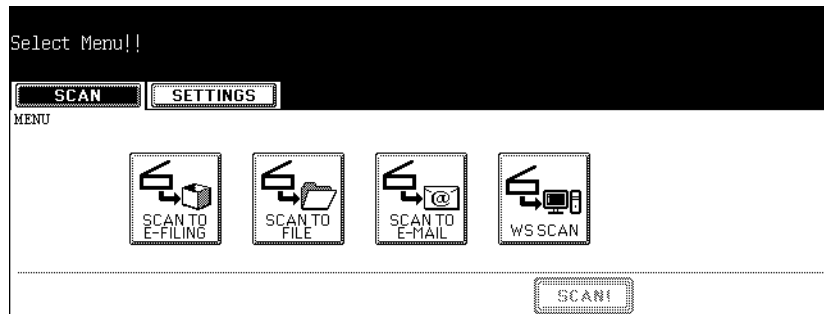

[SCAN TO E-FILING] — Press this to store the scanned images to e-Filing. When you store the scanned images to e-Filing, you can manage them using the e-Filing web utility. You can also retrieve them into your computer using TWAIN driver application or File Downloader.

[SCAN TO FILE] — Press this to save the scanned images into the shared folder in the equipment or network folder as files.

[SCAN TO E-MAIL] — Press this to send the scanned images to specified E-mail addresses.

[WS Scan] — Press this to save the scanned images into your client PC.

4 Set the scanning conditions using the buttons on the touch panel and digital keys, and press the [ENTER] button to save the settings.

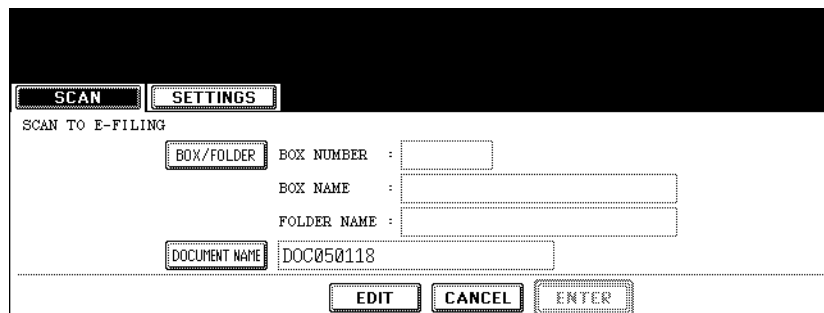

- The above screen shows the example of the SCAN TO E-FILING screen. The setting options vary depending on the scan mode that you selected. For instructions on how to set them, see the instructions for each scan mode.
 - 📖 P.28 “How to Perform Scan to e-Filing”
 - 📖 P.38 “How to Perform Scan to File”
 - 📖 P.50 “How to Perform Scan to E-mail”
 - 📖 P.135 “Web Service SCAN”
- When you press the [ENTER] button, the screen returns to the basic scan menu, and the button that you set will be grayed out.

5 Press the [SCAN!] button.

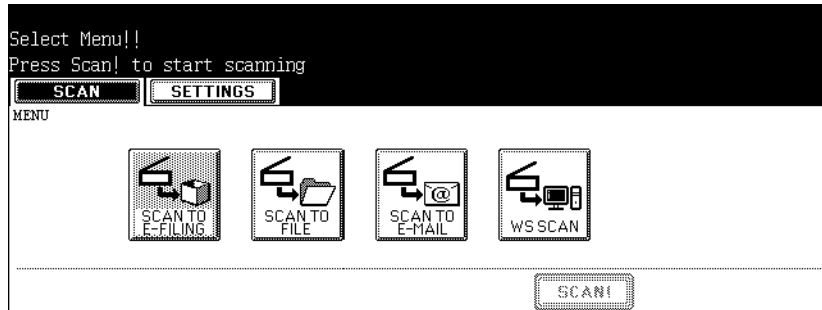

6 If the “To continue, place document on glass. And press Scan!” message is displayed, place another original on glass and press [SCAN!] to scan another original, or press the [JOB FINISH] button to finish scanning.



- When the original is set on the Automatic Document Feeder, this screen is not displayed. However, this screen is displayed when you press the [CONTINUE] button during scanning the originals.
- If you want to cancel the storage of the scanned data, press the [JOB CANCEL] button.
- You can change the setting of the original type and scanning conditions, using the [EDIT] button before pressing the [SCAN!] button.

Notes

- When you scan more than 1000 pages, the message “The number of originals exceeds the limits. Will you save stored originals?” is displayed. When you want to perform the scan operation with scanned originals that contains 1000 pages, press the [YES] button.
- When the temporary workspace of the HDD becomes full, “Not enough Work Space to store originals. Will you save original(s)?” is displayed. When you want to perform the scan operation with scanned originals, press the [YES] button. The amount of the temporary workspace can be confirmed in the Device tab page of TopAccess.

Scanning Procedure for Dual Agents

1 Place the original(s).

- For instruction about placing the originals, see *Operator's Manual for Basic Function*.

2 Press the [SCAN] button on the control panel to enter the scan menu.

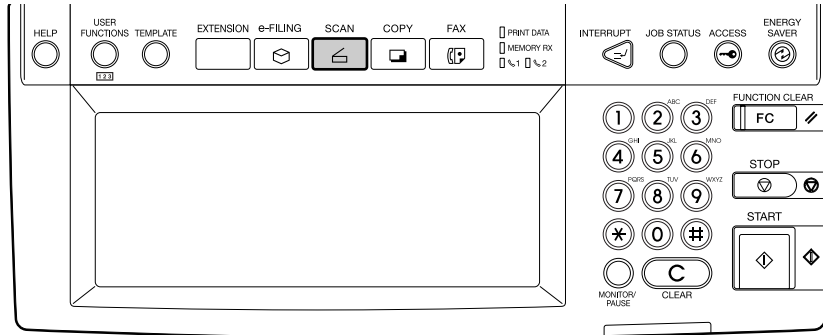

- The basic scan menu is displayed.

3 Select a button of the desired scan mode.

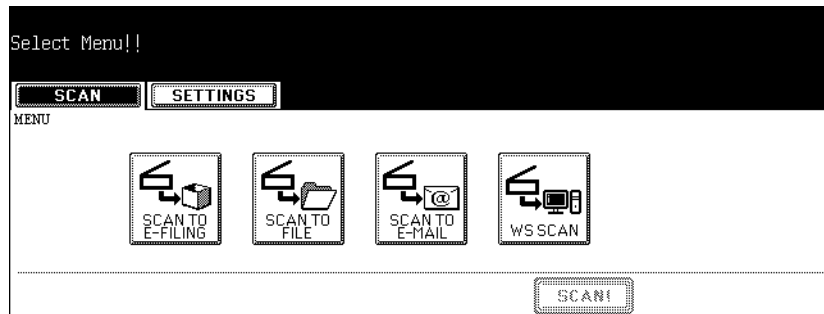

[SCAN TO E-FILING] — Press this to store the scanned images to e-Filing. When you store the scanned images to e-Filing, you can manage them using the e-Filing web utility. You can also retrieve them into your computer using TWAIN driver application or File Downloader.

[SCAN TO FILE] — Press this to save the scanned images into the shared folder in the equipment or network folder as files.

[SCAN TO E-MAIL] — Press this to send the scanned images to specified E-mail addresses.

[WS Scan] — Press this to save the scanned images into your client PC.

- 4** Set the scanning conditions using the buttons on the touch panel and digital keys, and press the [ENTER] button to save the settings.

- The above screen shows the example of the SCAN TO E-FILING screen. The setting options vary depending on the scan mode that you selected. For instructions on how to set them, see the instructions for each scan mode.
 - 📖 P.27 “Scan to e-Filing”
 - 📖 P.37 “Scan to File”
 - 📖 P.49 “Scan to E-mail”
 - 📖 P.135 “Web Service SCAN”
- When you press the [ENTER] button, the screen returns to the basic scan menu, and the button that you set will be grayed out.

- 5** Select the other button of the desired scan mode.

Notes

- You can set two scan modes at a single operation. You cannot set all three scan modes at the same time.
- When the "WS Scan" is selected, another scan mode cannot be set at the same time.

Tip

If you want to cancel a scan mode that you set, press the button for the scan mode that you want to cancel and press the [CANCEL] button in the screen. The screen returns to the basic scan menu and the button will be unselected (not grayed out).

6 Press the [SCAN!] button.

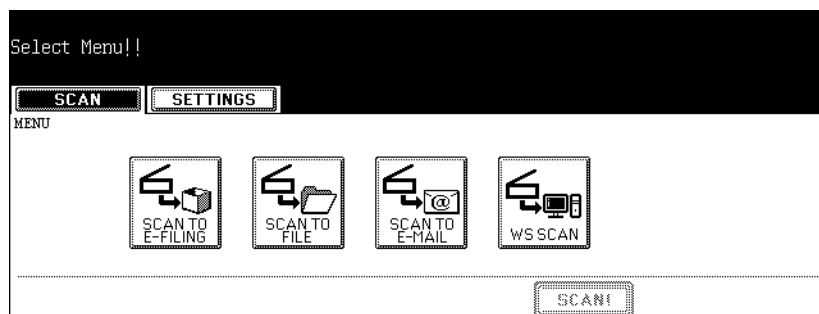

7 If the “To continue, place document on glass. And press Scan!” message is displayed, place another original on glass and press [SCAN!] to scan another original, or press the [JOB FINISH] button to finish scanning.



- When the original is set on the Automatic Document Feeder, this screen is not displayed. However, this screen is displayed when you press the [CONTINUE] button during scanning the originals.
- If you want to cancel the storage of the scanned data, press the [JOB CANCEL] button.
- You can change the setting of the original type and scanning conditions, using the [EDIT] button before pressing the [SCAN!] button.

Notes

- When you scan more than 1000 pages, the message “The number of originals exceeds the limits. Will you save stored originals?” is displayed. When you want to perform the scan operation with scanned originals that contains 1000 pages, press the [YES] button.
- When the temporary workspace of the HDD becomes full, “Not enough Work Space to store originals. Will you save original(s)?” is displayed. When you want to perform the scan operation with scanned originals, press the [YES] button. The amount of the temporary workspace can be confirmed in the Device tab page of TopAccess.

Confirming the Scan Job Status

SCAN JOB displays the status of a job and enables the deletion of job. 4 jobs are listed on each screen. The jobs for 250 pages (1,000 jobs) can be displayed. Press the [Next] button to display the 5th job or later, and press the [Prev] button to display the previous page.

To display the scan job status screen, press the [JOB STATUS] button on the control panel and press the [SCAN] button.

SENDING E-MAIL

PRINT FAX SCAN LOG STATUS

SCAN JOB

To/File Name	Agent	Date,Time	Pages	Status
user01@ifax.com	E-mail	19,00:43	1	Process

RETURN DELETE 1/1

- **Items of table**

Display the name of the file created or the e-mail address of the recipient.

Agent: Display the function used for the scan job.

Date, Time: Display the date and time of the scan job.

Pages: Display the number of pages scanned or sent via E-mail.

Status: Display the status of jobs.

- **Buttons**

[Delete]: The button becomes active when the deletable job is selected. When this button is pressed, the job is deleted.

Confirming the Scan Log

SCAN LOG allows you to list the jobs that have finished being scanned to confirm the results.

To display the scan log screen, press the [JOB STATUS] button on the control panel and press the [LOG] button in the JOB STATUS screen. Then press the [SCAN] button. When pressing the [SCAN] button on the log menu, the scanning status of the following items is displayed.

- Storing status in e-Filing by copying
- Storing status in Share folder (SAVE AS FILE) by copying
- Storing status in e-Filing or Share folder (SCAN TO FILE) by scanning
- Sending status of E-mail (SCAN TO E-MAIL) by scanning
- Storing status in Share folder (SAVE AS FILE) by faxing
- Storing status in e-Filing or Share folder by Fax Received Forward
- Storing status in e-Filing or Share folder by Internet Fax Received Forward

The screenshot shows a control panel with buttons for PRINT, FAX, SCAN, LOG, and STATUS. The LOG button is highlighted. Below the buttons is the SCAN LOG screen, which contains a table with the following data:

To/File Name	Agent	Date,Time	Pages	Status
user01-0001	Store to e-Filing	18,23:58	1	OK
DOC050118	Store to e-Filing	18,23:50	1	OK
DOC050118-001.pdf	Save as File	18,04:54	10	OK
file0001-001.pdf	Save as File	18,04:50	10	OK

At the bottom of the screen, there are buttons for RETURN, ENTRY, and Next, along with a page indicator 1/3.

- **Items of list**

Display the storing location of the scanned data or E-mail address of the recipient.

Agent: Display the scanned job in the scan menu.

Date, Time: Display the date and time at the time of scanning.

Pages: Display the number of pages scanned or sent E-mail.

Status: Display the status of job displayed with 'OK' or 'Error code'

- **Buttons**

[ENTRY]: To register the E-mail address in the scanning status to the address book, press this button.

[RETURN]: To return to the log menu, press this button.

Tip

For more information about the error code that is displayed in the Status section, see *Operator's Manual for Basic Function*.

2

Scan to e-Filing

This section describes the instructions on how to perform Scan to e-Filing and how to use the stored data in e-Filing.

How to Perform Scan to e-Filing28

How to Use Scanned Data Stored in e-Filing35

Using Scanned Data in e-Filing from Touch Panel Display35

Using Scanned Data in e-Filing from e-Filing Web Utility35

How to Perform Scan to e-Filing

In this function, the scanned original data can be stored in the e-Filing. You can scan up to 200 pages per 1 job.

In the e-Filing boxes, up to 5 GB of data can be stored.

After storing the original data, you can print it at any time from the touch panel. Also you can manage stored documents using the e-Filing web utility. Using the e-Filing web utility, you can manage stored documents by creating user boxes and folders, printing documents, and merging several documents to create a new document.

To store the original data, you can specify the public box or one of user boxes. The public box is a pre-set box since the installation of the equipment, and it will be used to store documents that any user may need to work with. The user box is the one created by the user, and, if password is set, you need to enter the password correctly.

Before storing the original data in e-Filing, you need to set up the user boxes using the touch panel or e-Filing web utility. For setting up the user boxes and printing the stored documents from the touch panel or e-Filing web utility, see **e-Filing Guide**. (The instruction on how to set up the user boxes using the touch panel also describes in **Operator's Manual for Basic Function**.)

Notes

- It is recommended to back up the data on the equipment's hard disk to prevent loss of data. You can back it up with the client PC using the File Downloader or e-Filing Backup/Restore Utility. See **e-Filing Guide** for details.
- Delete the documents in e-Filing when they are no longer needed.

The SCAN TO e-FILING function is available only when the Scanner Kit or Printer/Scanner Kit is installed.

Tip

You can also store the copied original data in the e-Filing using the copy operation. However, when you use the original data with the client PC via network, it is recommended to store the original data using the scanning operation explained here, rather than using the copy operation because the data stored by the copy operation is proper for output, but not for importing as an image into your computer.

Scanning Procedure for Scan to e-Filing

1 Place the original(s).

- For instruction about placing the originals, see **Operator's Manual for Basic Function**.

2 Press the [SCAN] button on the control panel to enter the scan menu.

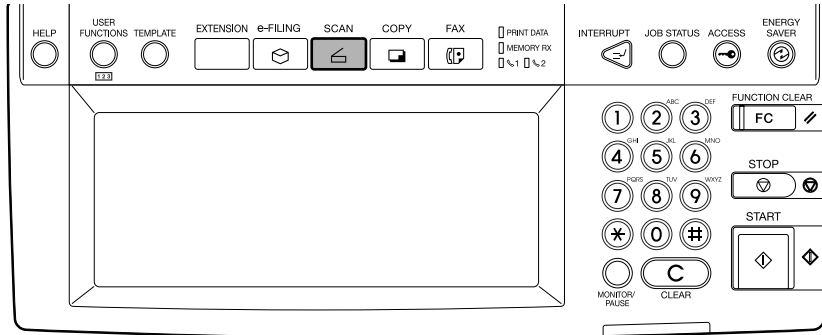

- The basic scan menu is displayed.

3 Press the [SCAN TO E-FILING] button.

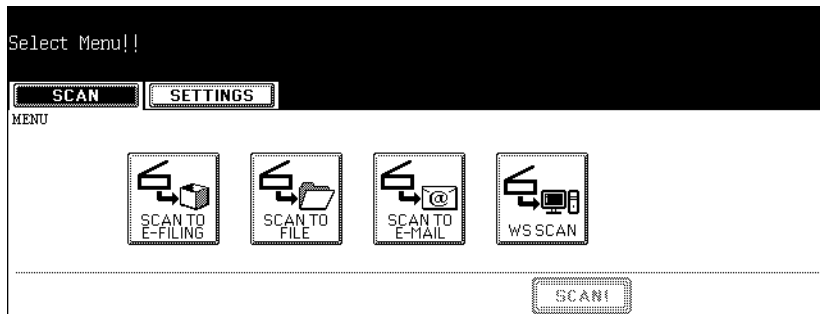

- The SCAN TO E-FILING screen is displayed.

4 Press the [BOX/FOLDER] button.

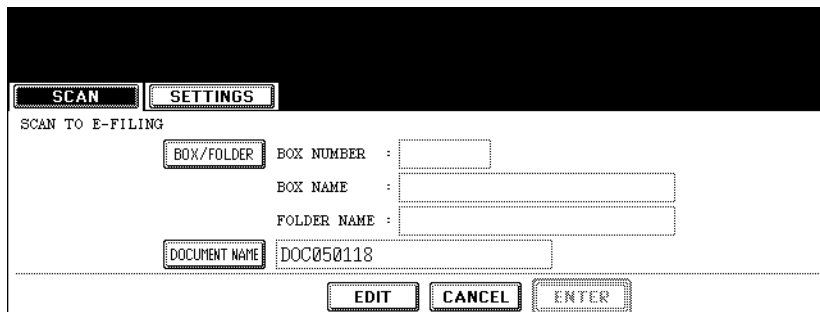

- The box list screen is displayed.

5 Select the box in which you want to store the data and press the [ENTER] button.

BOX LIST ▶Select Box

BOX NUMBER : 001

Public Box	004 User04
001 User01	005 User05
002 User02	006 User06
003 User03	007 User07

CANCEL ENTER 1/26 Next

- Select either the “Public Box” button or desired user box button.
- If the user box that you want to store the data is not shown in the list, press the [Next] or [Prev] buttons to change the list on the screen. You can also select the user box by entering the box number using the digital key.

Tip

If the user box that you want to store the data has not been registered, you must register the user box first. For setting up the user boxes, see *e-Filing Guide*. (The instruction on how to set up the user boxes using the touch panel also describes in *Operator's Manual for Basic Function*.)

6 If you select a user box that a password is set, the password entry screen may be displayed. If the password entry screen is displayed, enter the password using the digital keys and press the [ENTER] button.

PASSWORD ▶Enter Box Password
(5-digit)

BOX NUMBER : 001

BOX NAME : User01

Password : *****

CANCEL ENTER

- The list of the documents and folders for the selected box is displayed.

- 7** When you want to store the original(s) in an existing folder, select the folder and press the [OPEN FOLDER] button to display the list in the folder, and then press the [ENTER] button.
If you want to store the original(s) in the selected box, press the [ENTER] button.

STORE TO E-FILING ▶ Select Storage Location

Document/Folder Name	Date, Time	Paper	Pages
Folder	14, 03: 00		

1/1

- The screen returns to the SCAN TO E-FILING screen.

- 8** Press the [DOCUMENT NAME] button if you want rename the document name of the scanned data.

SCAN TO E-FILING

BOX NUMBER : 001
 BOX NAME : User01
 FOLDER NAME : Folder
 DOCUMENT NAME : DOC050118

- The letter entry screen is displayed. Enter the value using the keyboard and digital keys, and press the [ENTER] button to set the entry.
- 9** Press the [EDIT] button to set the scanning conditions.
- The screen to set the scan conditions is displayed.

10 Specify the following items as you require, and press the [Next] button.

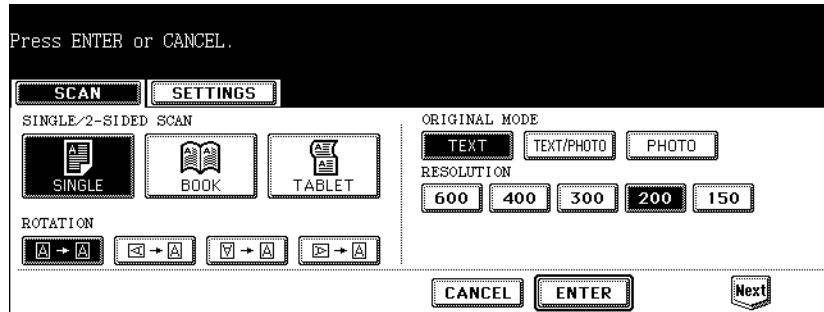

- **SINGLE/2-SIDED SCAN**
 - [SINGLE]** — Press this when scanning only the front page of originals.
 - [BOOK]** — Press this when scanning both side of originals in the same direction.
 - [TABLET]** — Press this when scanning front page in the general direction, and scanning back page rotated 180 degree.
- **ROTATION**
 - [0 degree]** — Press this not to rotate the scanned image.
 - [90 degree right]** — Press this to rotate the scanned image 90 degrees to the right.
 - [180 degree]** — Press this to rotate the scanned image 180 degree.
 - [90 degree left]** — Press this to rotate the scanned image 90 degrees to the left.
- **ORIGINAL MODE**
 - [TEXT]** — Press this when scanning the originals that contain texts
 - [TEXT/PHOTO]** — Press this when scanning originals that contain text and photos.
 - [PHOTO]** — Press this when scanning originals that contain photos printed on photographic paper.
- **RESOLUTION**
 - [600]** — Press this when scanning originals in 600 dpi.
 - [400]** — Press this when scanning originals in 400 dpi.
 - [300]** — Press this when scanning originals in 300 dpi.
 - [200]** — Press this when scanning originals in 200 dpi.
 - [150]** — Press this when scanning originals in 150 dpi.

11 Specify the following items as you require, and press the [Enter] button.

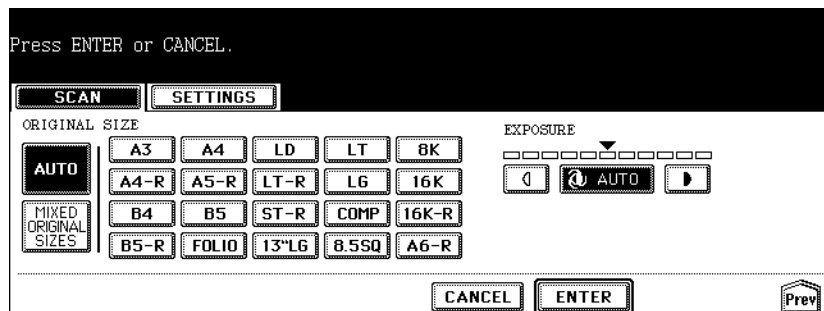

- **ORIGINAL SIZE**
 - Select the button corresponding to the original size, or select the [AUTO] button to automatically detect the original size.
 - When placing different size originals on the Automatic Document Feeder , select the [MIXED ORIGINAL SIZE] button.

- **EXPOSURE**

Press light or dark buttons to specify the exposure for scanning manually, or press the [AUTO] button to select auto mode for the exposure mode for scanning.

12 Press the [ENTER] button.

SCAN TO E-FILING

BOX/FOLDER BOX NUMBER : 001

BOX NAME : User01

FOLDER NAME : Folder

DOCUMENT NAME user01-0001

EDIT CANCEL ENTER

- The screen returns to the basic scan menu.

13 Press the [SCAN!] button.

Select Menu!
Press Scan! to start scanning

SCAN TO E-FILING

SCAN TO FILE

SCAN TO E-MAIL

WS SCAN

SCAN!

Tip

You can also set another scan agent, by pressing either the [SCAN TO FILE] button or [SCAN TO E-MAIL] button to set the scanning conditions.

📖 P.38 “How to Perform Scan to File”

📖 P.50 “How to Perform Scan to E-mail”

- 14** If the “To continue, place document on glass. And press Scan!” message is displayed, place another original on glass and press [SCAN!] to scan another original, or press the [JOB FINISH] button to finish scanning.



- When the original is set on the Automatic Document Feeder , this screen is not displayed. However, this screen is displayed when you press the [CONTINUE] button during scanning the originals.
- If you want to cancel the storage of the scanned data, press the [JOB CANCEL] button.
- You can change the setting of the original type and scanning conditions, using the [EDIT] button before pressing the [SCAN!] button.

How to Use Scanned Data Stored in e-Filing

Scanned data that is stored in e-Filing can be listed from the touch panel or e-Filing web utility.

Using Scanned Data in e-Filing from Touch Panel Display

The scanned data that is stored in e-Filing can be printed or deleted from the touch panel. For instructions on how to print or delete scanned data in e-Filing from the touch panel, see *Operator's Manual for Basic Function* or *e-Filing Guide*.

Using Scanned Data in e-Filing from e-Filing Web Utility

The scanned data that is stored in e-Filing can be printed, deleted, copied to another boxes or folders, and merged with other scanned data in e-Filing using the e-Filing web utility. For instructions on how to print, delete, copy, or merge scanned data, see *e-Filing Guide*.

3

Scan to File

This section describes the instructions on how to perform Scan to File and how to use the stored files.

How to Perform Scan to File	38
How to Use Scanned Data Stored as Files	47
When Scanned Data Is Stored in MFP LOCAL	47
When Scanned Data Is Stored in REMOTE 1 or 2	47

How to Perform Scan to File

In this SCAN TO FILE function, the scanned original data can be sent and stored to the Share folder of the hard disk in the equipment, or the specified PC. You can scan up to 2000 pages per 1 job. You can access the data stored in the Share folder directly from the client PC via network. In the shared folder in the equipment, up to 4 GB of data can be stored.

Notes

- Up to 999 files can be stored in the shared folder in the equipment.
- The network administrator has to make settings for storing the original data to the PCs. For details, see **Network Administration Guide**.
- It is recommended to back up the data stored in the Share folder of the hard disk with the client PC via network.
- Delete the files in the shared folder when they are no longer needed.

The SCAN TO FILE function is available only when the Scanner Kit or Printer/Scanner Kit is installed.

Scanning Procedure for Scan to File

1 Place the original(s).

- For instruction about placing the originals, see **Operator's Manual for Basic Function**.

2 Press the [SCAN] button on the control panel to enter the scan menu.

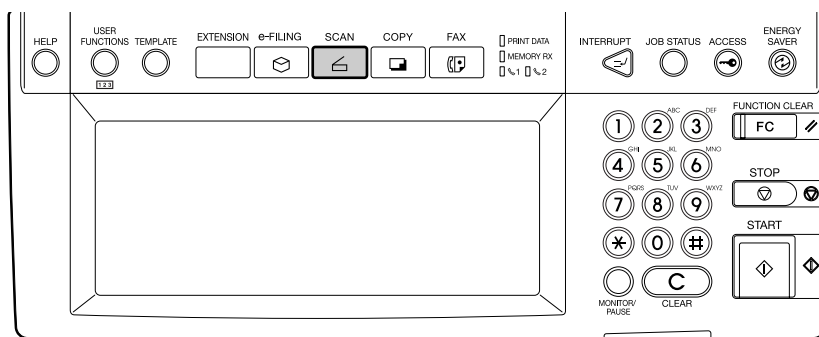

- The basic scan menu is displayed.

3 Press the [SCAN TO FILE] button.

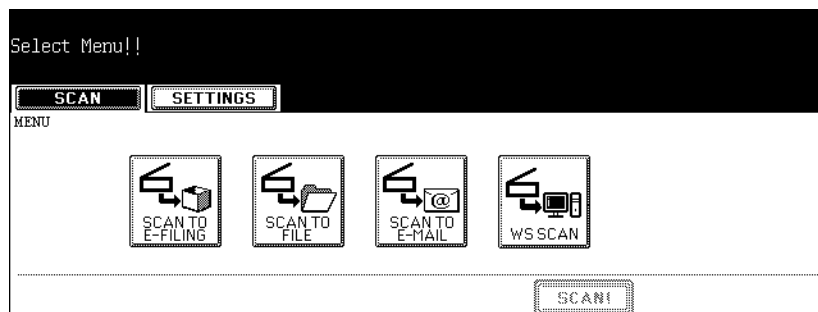

- The SCAN TO FILE screen is displayed.

4 Press the [FILE NAME] button if you want rename the document name of the scanned data.

The screenshot shows the 'SCAN TO FILE' settings interface. At the top, there are two tabs: 'SCAN' and 'SETTINGS'. Below the tabs, the 'SCAN TO FILE' section contains several fields and buttons. The 'FILE NAME' field is set to 'DOC120805' and has a clock icon to its right. The 'MFP LOCAL' button is highlighted with a dark background, indicating it is selected. The 'REMOTE 1' field is set to '\\powerbox\home\take\scan'. The 'REMOTE 2' field is empty. To the right of these fields, there are three sections: 'FILE FORMAT' with buttons for 'PDF', 'TIFF', and 'XPS'; 'MULTI/SINGLE PAGE' with buttons for 'MULTI' and 'SINGLE'; and 'SECURITY' with buttons for 'ON' and 'OFF'. At the bottom of the screen, there are three buttons: 'EDIT', 'CANCEL', and 'ENTER'.

- The letter entry screen is displayed. Enter the value using the keyboard and digital keys, and press the [ENTER] button to set the entry.

Tip

When you want to add the date and time in the file name, press the  button. If you select [PDF] or [TIFF] for its file format and also select [SINGLE] from the “MULTI/SINGLE PAGE” setting, the date and time that the job was performed are added to a folder name created in the file storing process.

5 If you want to store the scanned data in the shared folder of the equipment, make sure the [MFP LOCAL] button is selected (displayed as reversed button).

Note

You can set up to two destinations for Scan to File. If you select the [MFP LOCAL] button, you can specify only one more remote destination. If you want to specify the two remote destinations, press the [MFP LOCAL] button to disable it (displayed as normal button).

6 If you want to store the scanned data in network folder, press the [REMOTE 1] or [REMOTE 2] buttons.

- If the selected remote destination (REMOTE 1 or REMOTE 2) is configured to save the scanned data in specified network folder by the administrator, the button will be the reversed button when you press it. In this case, users cannot change the destination. If the remote destination needs to be changed, it can be configured in the Administration Tab of the TopAccess. Please consult your network administrator.
- If the selected remote destination (REMOTE 1 or REMOTE 2) is configured for users to specify the desired network folder, the screen to set up the remote destination is displayed.

- 7** If the screen to set up the remote destination is displayed by pressing the [REMOTE 1] or [REMOTE 2] button, specify the remote destination. You can specify the remote destination using FTP, SMB, NetWare IPX, or NetWare IP.

When you want to store the data using FTP, select the [FTP] button and specify the following items as you require. Then press the [ENTER] button.

The screenshot shows a menu interface for setting a remote destination. At the top, there are two tabs: 'SCAN' and 'SETTINGS'. Below the tabs, the screen is titled 'REMOTE2'. Under the heading 'PROTOCOL', there are four buttons: 'FTP' (which is highlighted), 'SMB', 'NetwareIPX', and 'NetwareIP'. Below the protocol selection, there are four input fields: 'SERVER NAME' with the value '10.10.70.101', 'NETWORK PATH' with the value 'user01\scan', 'LOGIN USER NAME' with the value 'take', and 'PASSWORD' with a series of asterisks. The 'COMMAND PORT' field contains a hyphen '-'. At the bottom of the screen, there are two buttons: 'CANCEL' and 'ENTER'.

- **[SERVER NAME]**
Press this to enter the IP address of the FTP server. For example, if you want to store the data into “ftp://10.10.70.101/user01/scan/”, enter “10.10.70.101” here.
- **[NETWORK PATH]**
Press this to enter the folder path to the folder where you want to store the data in the FTP server. For example, if you want to store the data into “ftp://10.10.70.101/user01/scan/”, enter “user01\scan” here. Make sure to use “\” instead of “/” to specify the path.
- **[LOGIN USER NAME]**
Press this to enter the user name to login the FTP server if required.
- **[PASSWORD]**
Press this to enter the password to login the FTP server if required.
- **[COMMAND PORT]**
Press this to enter the port number to be used for command. Generally “-” is entered for the command port. When “-” is entered, the port number that is set by the administrator will be used. Change this option only when you want to use another port number.

Tip

When you press each button, the letter entry screen is displayed. Enter the value using the keyboard and digital keys, and press the [ENTER] button to set the entry.

When you want to store the data using SMB, select the [SMB] button and specify the following items as you require. Then press the [ENTER] button.

- **[NETWORK PATH]**
Press this to enter the network path to the folder where you want to store the data.
- **[LOGIN USER NAME]**
Press this to enter the user name to access the network folder if required.
- **[PASSWORD]**
Press this to enter the password to access the network folder if required.

Tip

When you press each button, the letter entry screen is displayed. Enter the value using the keyboard and digital keys, and press the [ENTER] button to set the entry.

Note

[SERVER NAME] and [COMMAND PORT] are not required to set when selecting the [SMB] button for protocol.

When you want to store the data using NetWare IPX or NetWare IP, select the [Netware IPX] or [Netware IP] button and specify the following items as you require. Then press the [ENTER] button.

- **[SERVER NAME]**
When you select the [NetWare IPX] button, press this to enter the NetWare file server name or Tree/Context name (when NDS is available).
When you select the [NetWare IP] button, press this to enter the IP address of the NetWare file server.

- **[NETWORK PATH]**
Press this to enter the folder path to the folder where you want to store the data in the NetWare file server. For example, if you want to store the data into “sys\scan” folder in the NetWare file server, enter “\sys\scan” here.
- **[LOGIN USER NAME]**
Press this to enter the user name to login the NetWare file server if required.
- **[PASSWORD]**
Press this to enter the password to login the NetWare file server if required.

Tip

When you press each button, the letter entry screen is displayed. Enter the value using the keyboard and digital keys, and press the [ENTER] button to set the entry.

Note

[COMMAND PORT] is not required to set when selecting the [NetWare IPX] or [NetWare IP] button for protocol.

8 Select the following items and press the [EDIT] button.

- **FILE FORMAT**
 - [PDF]** — Press this to attach the scanned data as PDF file.
 - [TIFF]** — Press this to attach the scanned data as a TIFF file.
 - [XPS]** — Press this to attach the scanned data as XPS file.
- **MULTI/SINGLE**
 - [MULTI]** — Press this to attach the scanned data as a multiple page file. When scanning several pages, this equipment will store all pages as one file.
 - [SINGLE]** — Press this to attach the scanned data as a single file for each page. When scanning several pages, this equipment will store each page separately as files.
- **SECURITY (Encrypt PDF)**
 - [ON]** Press this to set Encrypt PDF.
 - [OFF]** Press this not to set Encrypt PDF.

A screen for setting Encrypt PDF will appear when the [ON] button in the “SECURITY” field is pressed. Set the items below as required. When the setting is completed, press the [ENTER] button.

The screenshot shows a settings menu for SecurePDF. At the top, there are two tabs: 'SCAN' and 'SETTINGS'. The 'SETTINGS' tab is active. Under the 'SecurePDF' section, there are two password fields: 'USER PASSWORD' with the value '12345' and 'MASTER PASSWORD' with the value '123456'. To the right, under 'Encryption Level', there are two buttons: '128bit RC4' (selected) and '40bit RC4'. Below that is the 'Authority' section with four buttons: 'PRINT', 'CHANGE', 'EXTRACT', and 'ACCESSIBILITY'. At the bottom of the screen are 'CANCEL' and 'ENTER' buttons.

- **Encrypt PDF**

[USER PASSWORD] — Press this to enter a password for opening encrypted PDF files.

[MASTER PASSWORD] — Press this to enter a password for changing Encrypt PDF setting.

Tips

- The user password is set “12345” at our factory. Ask the administrator for resetting master password.
- When you press each button, the letter entry screen is displayed. Enter a value using the keyboard and digital keys, and press the [ENTER] button to set the entry.
- The minimum and maximum numbers of the passwords allowed are 1 and 32, including one-byte digits, “#” and “*”.
- The user password must differ from the master password.

Note

These passwords can be re-entered only by an authorized user. A user cannot change the settings of the “Encryption Level” field and the “Authorization” field noted below if he or she is not authorized to change the master password. Ask the administrator for resetting these passwords.

- **Encryption Level**

[128bit RC4] — Press this to set an encryption level to the one compatible with Acrobat 5.0. PDF V1.4.

[40bit RC4] — Press this to set an encryption level to the one compatible with Acrobat 3.0. PDF V1.1.

- **Authority**

[PRINT] — Press this to authorize users to print documents.

[CHANGE] — Press this to authorize users to change documents.

[EXTRACT] — Press this to authorize users to copy and extract the contents of documents.

[ACCESSIBILITY] — Press this to enable the accessibility feature.

9 Specify the following items as you require, and press the [Next] button.

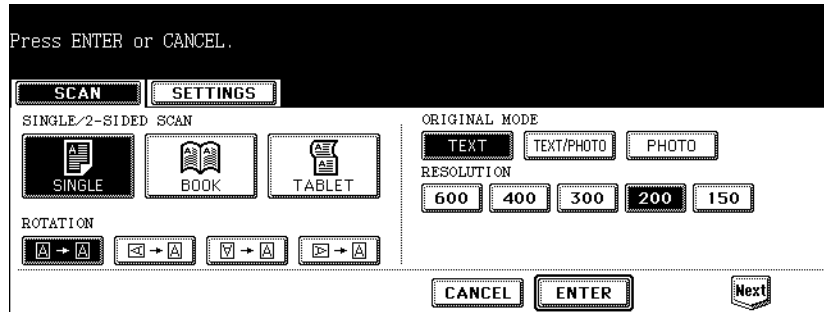

- **SINGLE/2-SIDED SCAN**
 - [SINGLE]** — Press this when scanning only the front page of originals.
 - [BOOK]** — Press this when scanning both side of originals in the same direction.
 - [TABLET]** — Press this when scanning front page in the general direction, and scanning back page rotated 180 degree.
- **ROTATION**
 - [0 degree]** — Press this not to rotate the scanned image.
 - [90 degree right]** — Press this to rotate the scanned image 90 degrees to the right.
 - [180 degree]** — Press this to rotate the scanned image 180 degree.
 - [90 degree left]** — Press this to rotate the scanned image 90 degrees to the left.
- **ORIGINAL MODE**
 - [TEXT]** — Press this when scanning the originals that contain texts.
 - [TEXT/PHOTO]** — Press this when scanning originals that contain texts and photos.
 - [PHOTO]** — Press this when scanning originals that contain photos printed on photographic paper.
- **RESOLUTION**
 - [600]** — Press this when scanning originals in 600 dpi.
 - [400]** — Press this when scanning originals in 400 dpi.
 - [300]** — Press this when scanning originals in 300 dpi.
 - [200]** — Press this when scanning originals in 200 dpi.
 - [150]** — Press this when scanning originals in 150 dpi.

10 Specify the following items as you require, and press the [Enter] button.

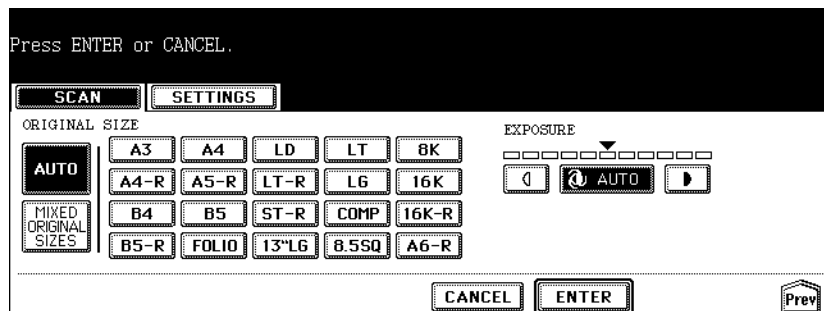

- **ORIGINAL SIZE**
 - Select the button corresponding to the original size, or select the [AUTO] button to automatically detect the original size.
 - When placing different size originals on the Automatic Document Feeder , select the [MIXED ORIGINAL SIZE] button.

- **EXPOSURE**

Press light or dark buttons to specify the exposure for scanning manually, or press the [AUTO] button to select auto mode for the exposure mode for scanning.

11 Press the [ENTER] button.

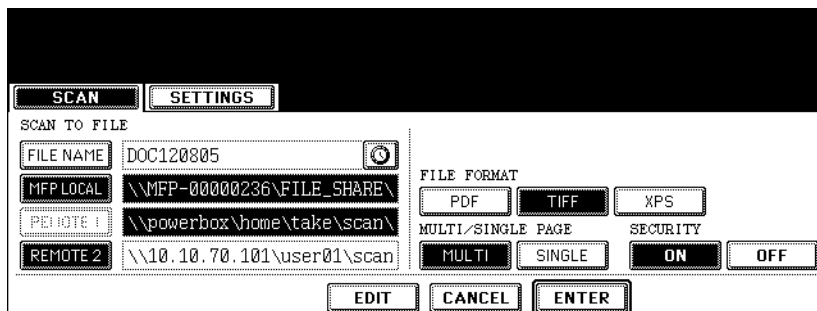

- The screen returns to the basic scan menu.

12 Press the [SCAN!] button.

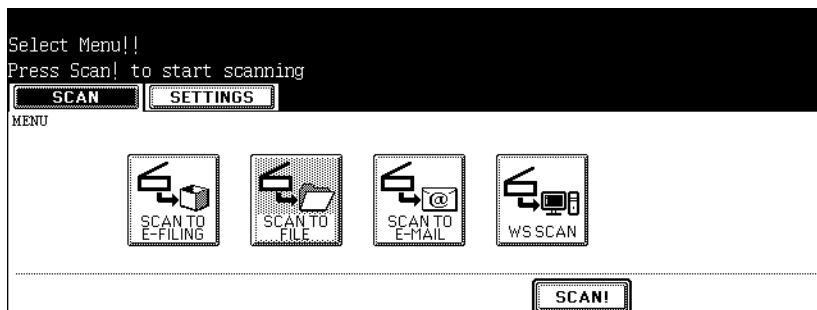

Tip

You can also set another scan agent, by pressing either the [SCAN TO E-FILING] button or [SCAN TO E-MAIL] button to set the scanning conditions.

📖 P.28 “How to Perform Scan to e-Filing”

📖 P.50 “How to Perform Scan to E-mail”

- 13** If the “To continue, place document on glass. And press Scan!” message is displayed, place another original on glass and press [SCAN!] to scan another original, or press the [JOB FINISH] button to finish scanning.



- When the original is set on the Automatic Document Feeder, this screen is not displayed. However, this screen is displayed when you press the [CONTINUE] button during scanning the originals.
- If you want to cancel the storage of the scanned data, press the [JOB CANCEL] button.
- You can change the setting of the original type and scanning conditions, using the [EDIT] button before pressing the [SCAN!] button.

How to Use Scanned Data Stored as Files

You can access scanned data files stored in the shared folder of this equipment or the Network folder by using Windows Explorer of Windows computers or the Finder function of Macintosh computers whose versions are Macintosh OS X 10.3.x or later.

When Scanned Data Is Stored in MFP LOCAL

When selecting the [MFP LOCAL] button for the destination, the scanned data is stored in the shared folder, whose name is “FILE_SHARE”, in the equipment.

You can access to the shared folder in the equipment from the Windows computers or Mac OS X 10.3.x or later to use scanned data for any uses.

Note

You cannot access to the shared folder in the equipment earlier than Mac OS X 10.2.x because these versions of Mac OS computers does not support SMB.

Tip

How scanned data is stored in the shared folder varies depending on the Local Storage Path setting, which can be set in the Save as file Setup page in TopAccess.

When the Local Storage Path is set to send scanned data to a sub folder in the storage path, the equipment creates a sub folder. The name of the sub folders varies depending on how you operate Scan to File. The sub folders are automatically deleted when the folder becomes empty.

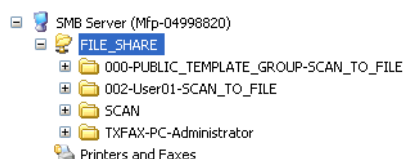

- **“SCAN” folder** — This sub folder contains the files that are stored by pressing the [SCAN TO FILE] button in the basic scan menu.
- **“000-PUBLIC_TEMPLATE_GROUP-[Template Name]” folder** — This sub folder contains the files that are stored by pressing the template button in the Public Template Group.
- **“[Group No.]-[Group Name]-[Template Name]” folder** — This sub folder contains the files that are stored by pressing the template button in the User Template Group.

When the Local Storage Path is set to send scanned data directly to the storage path, they are stored in the “FILE_SHARE” folder in the equipment.

When Scanned Data Is Stored in REMOTE 1 or 2

When selecting the [REMOTE 1] or [REMOTE 2] button for the destination, the scanned data is stored in the specified network folder.

You can access to the network folder using Windows Explorer to use scanned data for any uses.

4

Scan to E-mail

This section describes the instructions on how to perform Scan to E-mail.

How to Perform Scan to E-mail	50
Specifying Destinations	56

How to Perform Scan to E-mail

In this function, the scanned data can be sent to the specified E-mail address as an attached file.

Note

To use SCAN TO E-MAIL, the configuration of the equipment needs to be set by the network administrator.

The SCAN TO E-MAIL function is available only when the Scanner Kit or Printer/Scanner Kit is installed.

Scanning Procedure for Scan to E-mail

1 Place the original(s).

- For instruction about placing the originals, see *Operator's Manual for Basic Function*.

2 Press the [SCAN] button on the control panel to enter the scan menu.

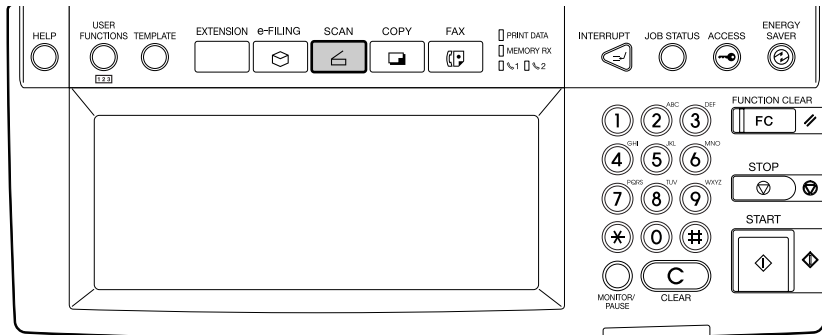

- The basic scan menu is displayed.

3 Press the [SCAN TO E-MAIL] button.

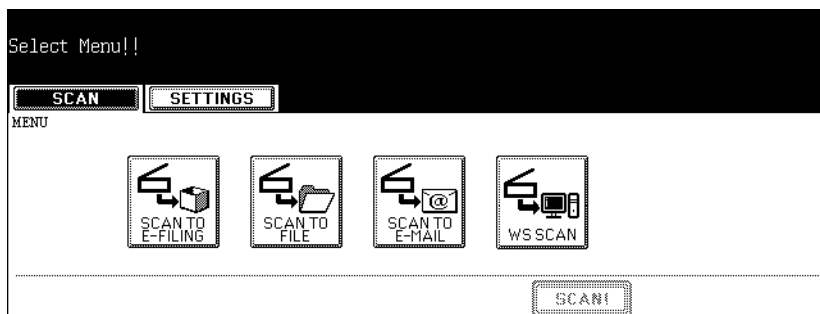

- When the User Authentication for Scan to E-mail is enabled by the administrator, the AUTHENTICATION screen displayed. If the AUTHENTICATION screen is displayed, continue to the next step.
- When the User Authentication for Scan to E-mail is disabled by the administrator, the SCAN TO E-MAIL screen is displayed. If the ADDRESS BOOK screen is displayed, skip to Step 5.

- When the AUTHENTICATION screen is displayed, enter the user name and password by pressing the [USER NAME] and [PASSWORD] buttons, and press the [ENTER] button.

AUTHENTICATION
PASSWORD

▶ Key in the user name and password. Press ENTER

USER NAME

PASSWORD

CANCEL ENTER

- When pressing each button, the letter entry screen is displayed. Enter the value using the keyboard and digital keys, and press the [ENTER] button to set the entry.

Note

This screen is displayed only when the User Authentication for Scan to E-mail is enabled. When this screen is displayed, you must enter your user name and password to login the SCAN TO E-MAIL screen. For user name and password, ask your network administrator.

- Specify the E-mail addresses that you want to send, and press the [SETTINGS] button.

DESTINATION: 0004

Press [START] to start scanning
user04@ifax.com

ADDRESS DESTINATION

ADDRESS BOOK

001User01 User	FAX	E-MAIL	005User05 User	FAX	E-MAIL	KNOWN ID
002User02 User	FAX	E-MAIL	006User06 User	FAX	E-MAIL	SEARCH ADDRESS
003User03 User	FAX	E-MAIL	007User07 User	FAX	E-MAIL	GROUP
004User04 User	FAX	E-MAIL	008User08 User	FAX	E-MAIL	

SETTINGS ALL CLEAR E-MAIL ADDRESS

1/125 Next

- You can specify the E-mail address by various ways. See the following procedures for each instruction.
 - P.56 "Specifying Destinations"

Tip

You can press the [START] button to start sending the E-mail at this screen if you specify an E-mail address and the From Address has been set in TopAccess E-mail setting page or set by the User Authentication for Scan to E-mail setting.

6 Press the [SUBJECT], [BODY], and [FILE NAME] buttons to enter each item.

Press [START] to start scanning

SCAN **SETTINGS**

SCAN TO E-MAIL

E-MAIL TO: User01 User

E-MAIL CC: []

SUBJECT: Scanned from MFP-00000236

BODY: []

FILE NAME: DOC120805 [Clock Icon]

FILE FORMAT: PDF, TIFF, XPS

MULTI/SINGLE PAGE: MULTI, SINGLE

SECURITY: ON, OFF

EDIT CANCEL ENTER Next

- When pressing each button, the letter entry screen is displayed. Enter the value using the keyboard and digital keys, and press the [ENTER] button to set the entry.

Tips

- When you want to add the date and time in the file name, press the [Clock Icon] button. The number to indicate the date and time that the job is performed is added to the file name displayed in the [FILE NAME] field.
- You can also specify the CC destinations for Scan to E-mail by pressing the [E-MAIL CC] button.
- The date and time will be automatically added to the subject.
- The administrator can change the body message from TopAccess. See the "TopAccess Administrator Mode" in the TopAccess Guide for details.

7 Select the following items and press the [Next] button.

Press [START] to start scanning

SCAN **SETTINGS**

SCAN TO E-MAIL

E-MAIL TO: User01 User

E-MAIL CC: []

SUBJECT: Scanned from MFP-00000236

BODY: []

FILE NAME: DOC120805 [Clock Icon]

FILE FORMAT: PDF, TIFF, XPS

MULTI/SINGLE PAGE: MULTI, SINGLE

SECURITY: ON, OFF

EDIT CANCEL ENTER Next

- **FILE FORMAT**
 - [PDF]** — Press this to attach the scanned data as PDF file.
 - [TIFF]** — Press this to attach the scanned data as a TIFF file.
 - [JPEG]** — Press this to attach the scanned data as a JPEG file. This can be set only when [FULL COLOR] or [GRAY SCALE] is selected in the "COLOR MODE" option.
 - [XPS]** — Press this to attach the scanned data as XPS file.
- **MULTI/SINGLE**
 - [MULTI]** — Press this to attach the scanned data as a multiple page file. When scanning several pages, this equipment will store all pages as one file.
 - [SINGLE]** — Press this to attach the scanned data as a single file for each page. When scanning several pages, this equipment will store each page separately as files.
- **SECURITY (Encrypt PDF)**
 - [ON]** Press this to set Encrypt PDF.
 - [OFF]** Press this not to set Encrypt PDF.

A screen for setting Encrypt PDF will appear when the [ON] button in the “SECURITY” field is pressed. Set the items below as required. When the setting is completed, press the [ENTER] button.

The screenshot shows a settings menu for SecurePDF. At the top, there are two tabs: 'SCAN' and 'SETTINGS'. The 'SETTINGS' tab is active. Under the 'SecurePDF' section, there are two password input fields: 'USER PASSWORD' containing '12345' and 'MASTER PASSWORD' containing '123456'. To the right, under 'Encryption Level', there are two buttons: '128bit RC4' (which is highlighted) and '40bit RC4'. Below this is the 'Authority' section with four buttons: 'PRINT', 'CHANGE', 'EXTRACT', and 'ACCESSIBILITY'. At the bottom of the screen, there are 'CANCEL' and 'ENTER' buttons.

- **Encrypt PDF**

[USER PASSWORD] — Press this to enter a password for opening encrypted PDF files.

[MASTER PASSWORD] — Press this to enter a password for changing Encrypt PDF setting.

Tips

- The user password is set “12345” at our factory. Ask the administrator for resetting master password.
- When you press each button, the letter entry screen is displayed. Enter a value using the keyboard and digital keys, and press the [ENTER] button to set the entry.
- The minimum and maximum numbers of the passwords allowed are 1 and 32, including one-byte digits, “#” and “*”.
- The user password must differ from the master password.

Note

These passwords can be re-entered only by an authorized user. A user cannot change the settings of the “Encryption Level” field and the “Authorization” field noted below if he or she is not authorized to change the master password. Ask the administrator for resetting these passwords.

- **Encryption Level**

[128bit RC4] — Press this to set an encryption level to the one compatible with Acrobat 5.0. PDF V1.4.

[40bit RC4] — Press this to set an encryption level to the one compatible with Acrobat 3.0. PDF V1.1.

- **Authority**

[PRINT] — Press this to authorize users to print documents.

[CHANGE] — Press this to authorize users to change documents.

[EXTRACT] — Press this to authorize users to copy and extract the contents of documents.

[ACCESSIBILITY] — Press this to enable the accessibility feature.

8 Specify the following items as you require and click the [EDIT] button.

Press [START] to start scanning

SCAN **SETTINGS**

SCAN TO E-MAIL

FRAGMENT MESSAGE SIZE(KB)

NONE 64 128 256 512 1024 2048

FROM ADDRESS user01@ifax.com

FROM NAME user01

[EDIT] [CANCEL] [ENTER] [Prev]

- **FRAGMENT MESSAGE SIZE**
Select the size of the message fragmentation. If the size of attached file exceeds the selected size, this equipment divides the data into some small blocks.
- **[FROM ADDRESS]**
Press this button to edit the From Address for E-mail. When the administrator enable the User Authentication for Scan to E-mail and set that From Address cannot be edited, you cannot edit the From Address.
- **[FROM NAME]**
Press this button to edit the From Name for E-mail.

Tip

When you press the [FROM ADDRESS] or [FROM NAME] button, the letter entry screen is displayed. Enter the value using the keyboard and digital keys, and press the [ENTER] button to set the entry.

9 Specify the following items as you require, and press the [Next] button.

Press ENTER or CANCEL.

SCAN **SETTINGS**

SINGLE/2-SIDED SCAN

SINGLE BOOK TABLET

ROTATION

ORIGINAL MODE

TEXT TEXT/PHOTO PHOTO

RESOLUTION

600 400 300 200 150

[CANCEL] [ENTER] [Next]

- **SINGLE/2-SIDED SCAN**
[SINGLE] — Press this when scanning only the front page of originals.
[BOOK] — Press this when scanning both side of originals in the same direction.
[TABLET] — Press this when scanning front page in the general direction, and scanning back page rotated 180 degree.
- **ROTATION**
[0 degree] — Press this not to rotate the scanned image.
[90 degree right] — Press this to rotate the scanned image 90 degrees to the right.
[180 degree] — Press this to rotate the scanned image 180 degrees.
[90 degree left] — Press this to rotate the scanned image 90 degrees to the left.

- **ORIGINAL MODE**
[TEXT] — Press this when scanning the originals that contain text.
[TEXT/PHOTO] — Press this when scanning originals that contain text and photos.
[PHOTO] — Press this when scanning originals that contain photos printed on photographic paper.
- **RESOLUTION**
[600] — Press this when scanning originals in 600 dpi.
[400] — Press this when scanning originals in 400 dpi.
[300] — Press this when scanning originals in 300 dpi.
[200] — Press this when scanning originals in 200 dpi.
[150] — Press this when scanning originals in 150 dpi.

10 Specify the following items as you require, and press the [Enter] button.

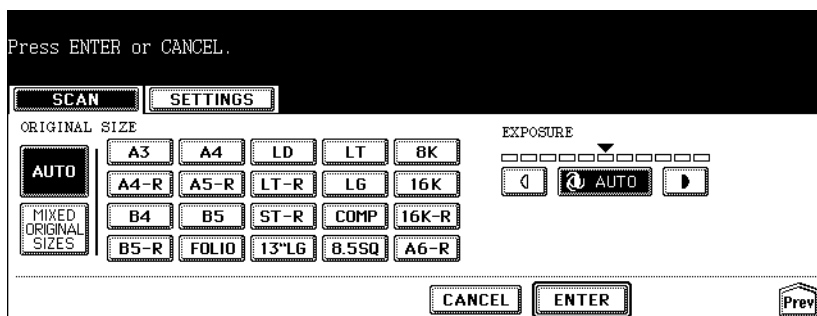

- **ORIGINAL SIZE**
Select the button corresponding to the original size, or select the [AUTO] button to automatically detect the original size.
When placing different size originals on the Automatic Document Feeder , select the [MIXED ORIGINAL SIZE] button.
- **EXPOSURE**
Press light or dark buttons to specify the exposure for scanning manually, or press the [AUTO] button to select auto mode for the exposure mode for scanning.

11 Press the [ENTER] button.

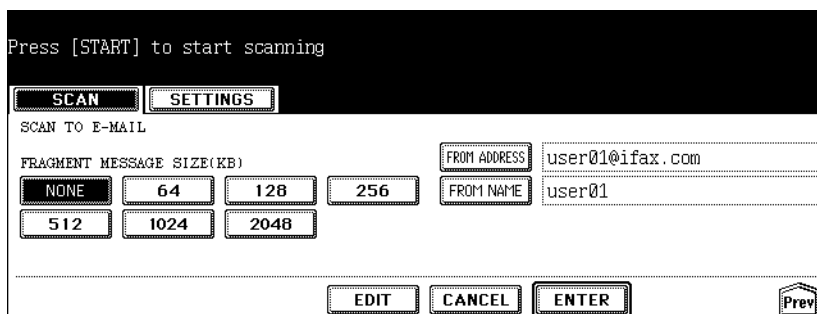

- The screen returns to the basic scan menu.

Tip

You can press the [START] button to start sending the E-mail at this screen without pressing the [ENTER] button.

12 Press the [SCAN!] button.

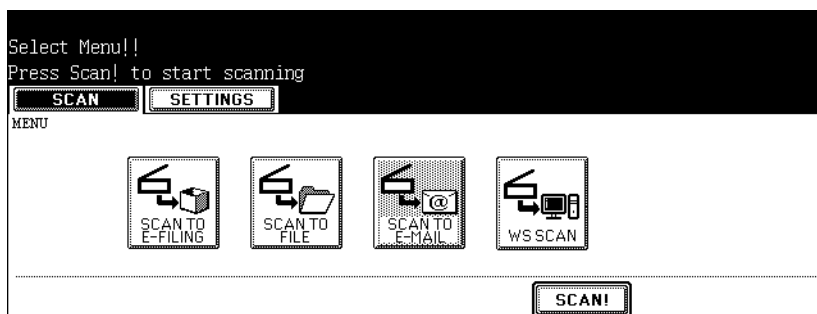

Tip

You can also set another scan agent, by pressing either the [SCAN TO E-FILING] button or [SCAN TO FILE] button to set the scanning conditions.

📖 P.28 “How to Perform Scan to e-Filing”

📖 P.38 “How to Perform Scan to File”

13 If the “To continue, place document on glass. And press Scan!” message is displayed, place another original on glass and press [SCAN!] to scan another original, or press the [JOB FINISH] button to finish scanning.



- When the original is set on the Automatic Document Feeder, this screen is not displayed. However, this screen is displayed when you press the [CONTINUE] button during scanning the originals.
- If you want to cancel the storage of the scanned data, press the [JOB CANCEL] button.
- You can change the setting of the original type and scanning conditions, using the [EDIT] button before pressing the [SCAN!] button.

Specifying Destinations

When pressing the [E-MAIL TO] button in the SCAN TO E-MAIL screen, the ADDRESS BOOK screen is displayed.

You can specify E-mail addresses for Scan to E-mail by following methods:

📖 P.57 “Entering an E-mail address manually”

📖 P.58 “Selecting from address book”

📖 P.58 “Searching with ID number for a contact”

📖 P.59 “Searching with search strings from address book”

📖 P.61 “Searching with search strings from LDAP server”

📖 P.63 “Selecting from groups”

📖 P.64 “Searching with ID number of a group”

📖 P.66 “Searching with group name”

Entering an E-mail address manually

1 Press the [E-MAIL ADDRESS] button.

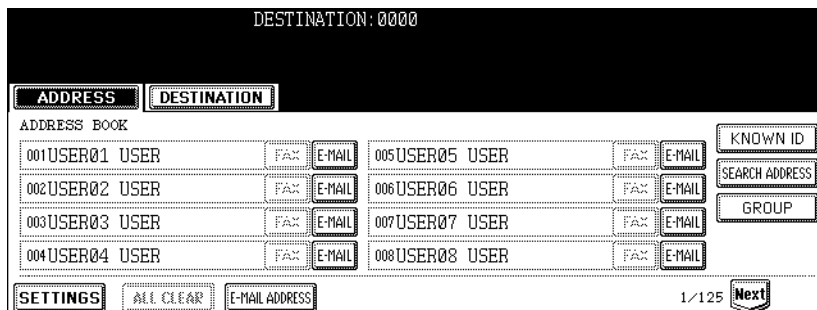

- The letter entry screen is displayed.

2 Enter the E-mail address that you want to send using the keyboard and digital keys, and press the [ENTER] button to set the entry.

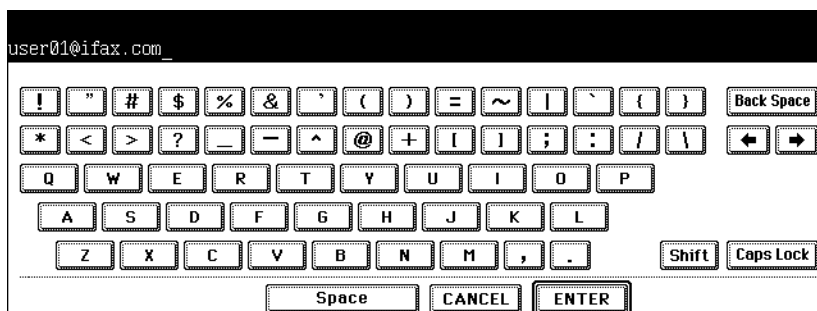

3 Press the [SETTINGS] button.

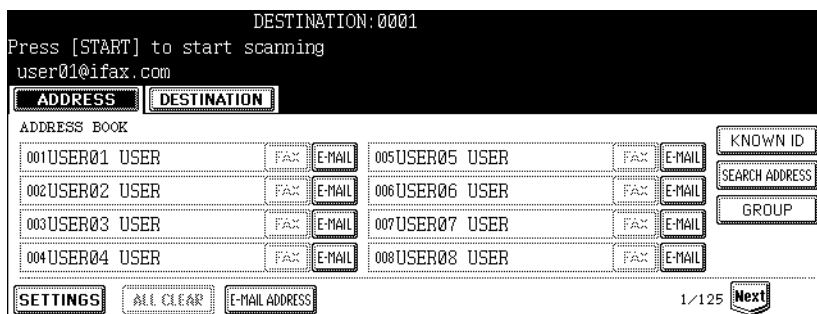

- The screen returns to the SCAN TO E-MAIL screen.

Tips

- Before pressing the [SETTINGS] button, you can specify other E-mail addresses as you require.
- You can confirm or remove the E-mail addresses that you specified in the DESTINATION screen which can be displayed by pressing the [DESTINATION] button.
 - 📖 P.67 “Confirming or removing E-mail addresses from destination”

Selecting from address book

1 Press the contacts that you want to send.

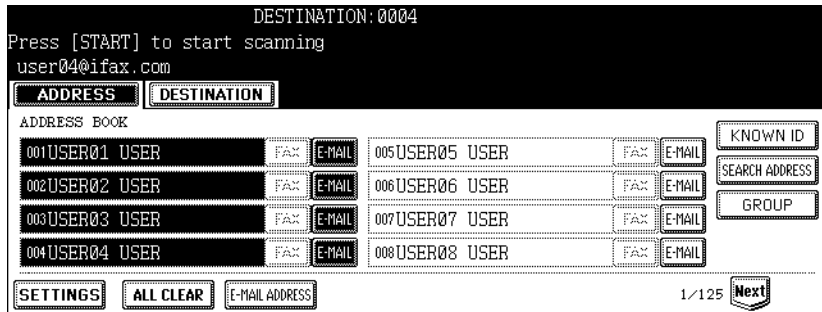

- The selected contacts are displayed as reversed buttons. To cancel the selection, press the contact again, then the button will be a normal button.

2 Press the [SETTINGS] button.

- The screen returns to the SCAN TO E-MAIL screen.

Tips

- Before pressing the [SETTINGS] button, you can specify other E-mail addresses as you require.
- You can confirm or remove the E-mail addresses that you specified in the DESTINATION screen which can be displayed by pressing the [DESTINATION] button.
 P.67 "Confirming or removing E-mail addresses from destination"

Searching with ID number for a contact

1 Press the [KNOWN ID] button.

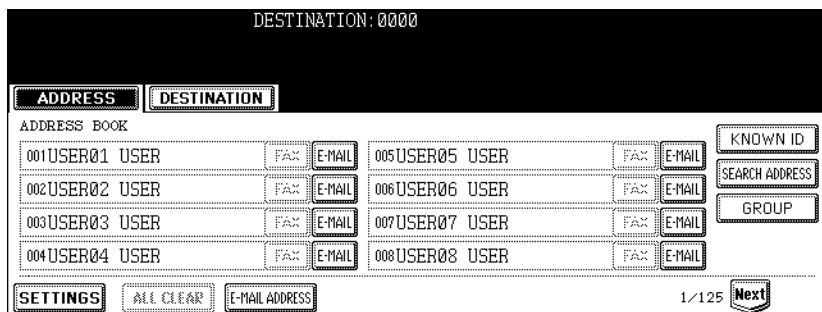

- The KNOWN ID screen is displayed.

- 2 Enter the ID number of the contact that you want to search using the digital keys, and press the [ENTER] button.

DESTINATION: 0000

user04@ifax.com

ADDRESS DESTINATION

KNOWN ID ▶Enter ID Number

KNOWN ID : 50

CANCEL ENTER

- The ADDRESS BOOK screen that contains the contact of the specified ID is displayed.

- 3 Press the contact that you want to send, and press the [SETTINGS] button.

DESTINATION: 0001

Press [START] to start scanning

user50@ifax.com

ADDRESS DESTINATION

ADDRESS BOOK

049 USER49 USER	FAX	E-MAIL	053 USER53 USER	FAX	E-MAIL	KNOWN ID
050 USER50 USER	FAX	E-MAIL	054 USER54 USER	FAX	E-MAIL	SEARCH ADDRESS
051 USER51 USER	FAX	E-MAIL	055 USER55 USER	FAX	E-MAIL	GROUP
052 USER52 USER	FAX	E-MAIL	056 USER56 USER	FAX	E-MAIL	

SETTINGS ALL CLEAR E-MAIL ADDRESS

7/125 Next Prev

- The screen returns to the SCAN TO E-MAIL screen.

Tips

- Before pressing the [SETTINGS] button, you can specify other E-mail addresses as you require.
 - You can confirm or remove the E-mail addresses that you specified in the DESTINATION screen which can be displayed by pressing the [DESTINATION] button.
- P.67 "Confirming or removing E-mail addresses from destination"

Searching with search strings from address book

- 1 Press the [SEARCH ADDRESS] button.

DESTINATION: 0000

ADDRESS DESTINATION

ADDRESS BOOK

001 USER01 USER	FAX	E-MAIL	005 USER05 USER	FAX	E-MAIL	KNOWN ID
002 USER02 USER	FAX	E-MAIL	006 USER06 USER	FAX	E-MAIL	SEARCH ADDRESS
003 USER03 USER	FAX	E-MAIL	007 USER07 USER	FAX	E-MAIL	GROUP
004 USER04 USER	FAX	E-MAIL	008 USER08 USER	FAX	E-MAIL	

SETTINGS ALL CLEAR E-MAIL ADDRESS

1/125 Next

- The ADDRESS SEARCH screen is displayed.

2 Press the buttons to enter the search strings that you want to specify, and then press the [SEARCH] button.

- When pressing each button, the letter entry screen is displayed. Enter the value using the keyboard and digital keys, and press the [ENTER] button to set the entry.

Tip

It will search for the contacts that contain the search text in the specified items.

Note

If the [DIR SERVICE] button is displayed as a selected button, this equipment will search for contacts in the LDAP server. In that case, press the [DIR SERVICE] button to display the Directory Service Name screen and clear the selection of a directory service. Then press the [ENTER] button to return the ADDRESS SEARCH screen.

3 Press the contact that you want to send, and press the [ENTER] button.

ID	Name	FAX	E-MAIL
001	USER01 USER	FAX	E-MAIL
002	USER02 USER	FAX	E-MAIL
003	USER03 USER	FAX	E-MAIL
004	USER04 USER	FAX	E-MAIL
005	USER05 USER	FAX	E-MAIL
006	USER06 USER	FAX	E-MAIL
007	USER07 USER	FAX	E-MAIL
008	USER08 USER	FAX	E-MAIL

- The screen returns to the ADDRESS BOOK screen.

4 Press the [SETTINGS] button.

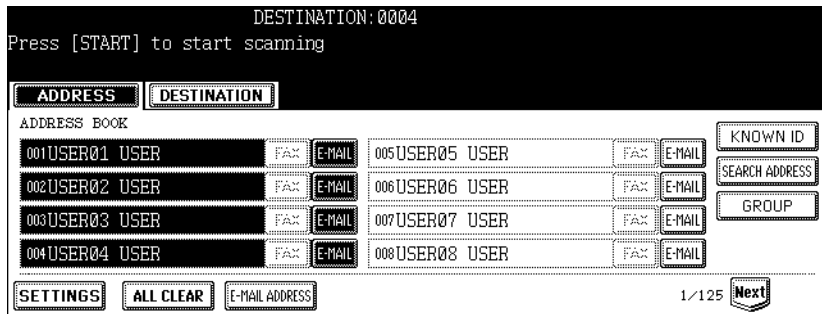

- The screen returns to the SCAN TO E-MAIL screen.

Tips

- Before pressing the [SETTINGS] button, you can specify other E-mail addresses as you require.
- You can confirm or remove the E-mail addresses that you specified in the DESTINATION screen which can be displayed by pressing the [DESTINATION] button.
 P.67 “Confirming or removing E-mail addresses from destination”

Searching with search strings from LDAP server

Note

To search contacts in the LDAP server, the directory service must be registered using TopAccess by the network administrator.

1 Press the [SEARCH ADDRESS] button.

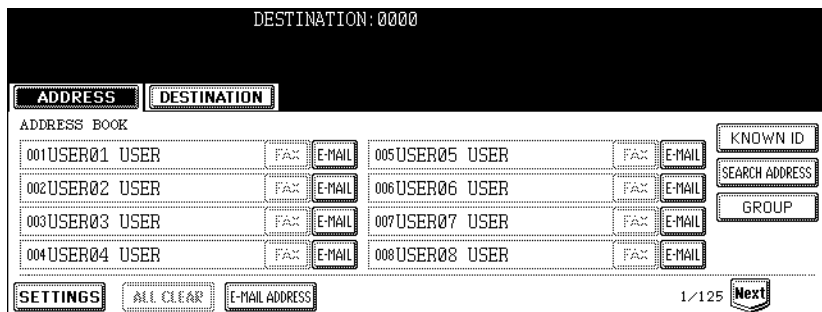

- The ADDRESS SEARCH screen is displayed.

2 Press the [DIR SERVICE] button.

DESTINATION: 0000

ADDRESS DESTINATION

ADDRESS SEARCH

FIRST NAME CORP.

LAST NAME DEPT.

FAX NO. KEYWORD

E-MAIL

DIR SERVICE CLEAR CANCEL SEARCH

- The Directory Search Name screen is displayed.

Tip

When the [DIR SERVICE] button is displayed as a selected button, this equipment is currently configured to search a default directory service.

3 Select the directory service name that you want to search from, and press the [ENTER] button.

DESTINATION: 0000

ADDRESS DESTINATION

Directory Search Name

ldap1

ldap2

ldap3

CANCEL ENTER 1/1

- The screen returns to the ADDRESS SEARCH screen.

4 Press the buttons to enter the search strings that you want to specify, and then enter the [SEARCH] button.

DESTINATION: 0000

ADDRESS DESTINATION

ADDRESS SEARCH

FIRST NAME CORP.

LAST NAME DEPT. Dept01

FAX NO. KEYWORD

E-MAIL

DIR SERVICE CLEAR CANCEL SEARCH

- When pressing each button, the letter entry screen is displayed. Enter the value using the keyboard and digital keys, and press the [ENTER] button to set the entry.

Tip

It will search for the contacts that contain the search text in the specified items.

5 Press the contact that you want to send, and press the [ENTER] button.

DESTINATION: 0004
Press [START] to start scanning
user04@ifax.com

ADDRESS DESTINATION

ADDRESS SEARCH

001USER01 USER	FAX	E-MAIL	005USER05 USER	FAX	E-MAIL	SEARCH ADDRESS
002USER02 USER	FAX	E-MAIL	006USER06 USER	FAX	E-MAIL	
003USER03 USER	FAX	E-MAIL	007USER07 USER	FAX	E-MAIL	SEARCH GROUP
004USER04 USER	FAX	E-MAIL	008USER08 USER	FAX	E-MAIL	

ENTER 1/2 Next

- The screen returns to the ADDRESS BOOK screen.

6 Press the [SETTINGS] button.

DESTINATION: 0004
Press [START] to start scanning

ADDRESS DESTINATION

ADDRESS BOOK

001USER01 USER	FAX	E-MAIL	005USER05 USER	FAX	E-MAIL	KNOWN ID
002USER02 USER	FAX	E-MAIL	006USER06 USER	FAX	E-MAIL	SEARCH ADDRESS
003USER03 USER	FAX	E-MAIL	007USER07 USER	FAX	E-MAIL	GROUP
004USER04 USER	FAX	E-MAIL	008USER08 USER	FAX	E-MAIL	

SETTINGS ALL CLEAR E-MAIL ADDRESS 1/125 Next

- The screen returns to the SCAN TO E-MAIL screen.

Tips

- Before pressing the [SETTINGS] button, you can specify other E-mail addresses as you require.
- You can confirm or remove the E-mail addresses that you specified in the DESTINATION screen which can be displayed by pressing the [DESTINATION] button.
 P.67 "Confirming or removing E-mail addresses from destination"

Selecting from groups

1 Press the [GROUP] button.

DESTINATION: 0000

ADDRESS DESTINATION

ADDRESS BOOK

001USER01 USER	FAX	E-MAIL	005USER05 USER	FAX	E-MAIL	KNOWN ID
002USER02 USER	FAX	E-MAIL	006USER06 USER	FAX	E-MAIL	SEARCH ADDRESS
003USER03 USER	FAX	E-MAIL	007USER07 USER	FAX	E-MAIL	GROUP
004USER04 USER	FAX	E-MAIL	008USER08 USER	FAX	E-MAIL	

SETTINGS ALL CLEAR E-MAIL ADDRESS 1/125 Next

- The GROUP screen is displayed.

2 Press the group buttons that you want to select as the destination, and press the [SETTINGS] button.

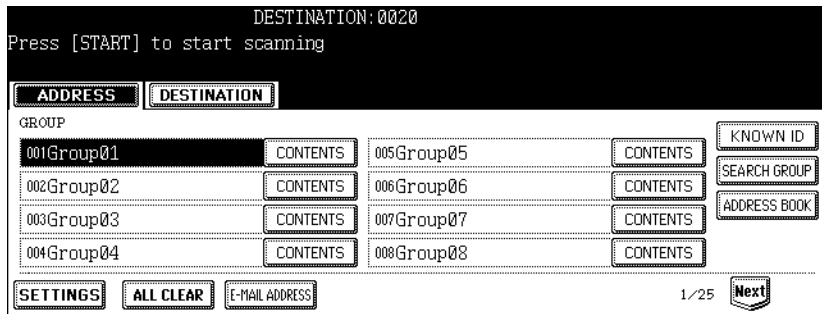

- The screen returns to the SCAN TO E-MAIL screen.

Tips

- You can confirm the E-mail addresses that registered in the group by pressing the [CONTENTS] button.
- Before pressing the [SETTINGS] button, you can specify other E-mail addresses as you require.
- You can confirm or remove the E-mail addresses that you specified in the DESTINATION screen which can be displayed by pressing the [DESTINATION] button.
 P.67 "Confirming or removing E-mail addresses from destination"

Searching with ID number of a group

1 Press the [GROUP] button.

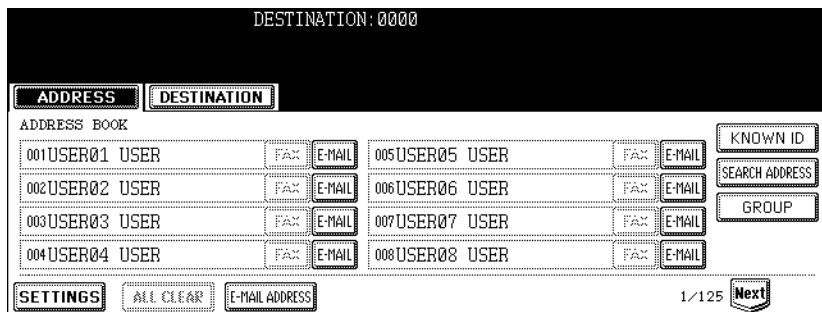

- The GROUP screen is displayed.

2 Press the [KNOWN ID] button.

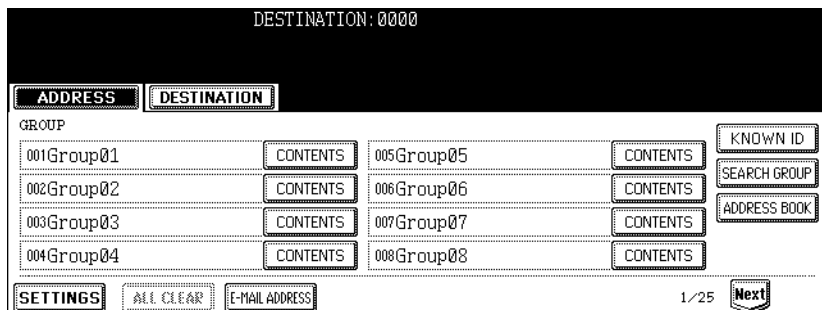

- The KNOWN ID screen is displayed.

- 3 Enter the ID number of the group that you want to search using the digital keys, and press the [ENTER] button.



- The GROUP screen that contains the group of the specified ID is displayed.

- 4 Press the group buttons that you want to select as the destination, and press the [SETTINGS] button.

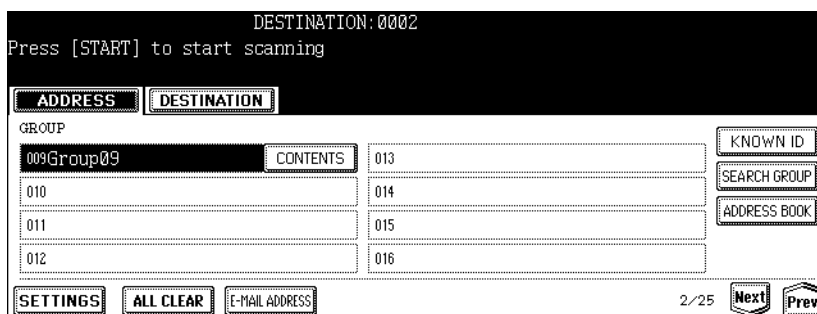

- The screen returns to the SCAN TO E-MAIL screen.

Tips

- You can confirm the E-mail addresses that registered in the group by pressing the [CONTENTS] button.
- Before pressing the [SETTINGS] button, you can specify other E-mail addresses as you require.
- You can confirm or remove the E-mail addresses that you specified in the DESTINATION screen which can be displayed by pressing the [DESTINATION] button.
 P.67 “Confirming or removing E-mail addresses from destination”

Searching with group name

1 Press the [GROUP] button.

DESTINATION: 0000

ADDRESS DESTINATION

ADDRESS BOOK

001USER01 USER	FAX	E-MAIL	005USER05 USER	FAX	E-MAIL	KNOWN ID
002USER02 USER	FAX	E-MAIL	006USER06 USER	FAX	E-MAIL	SEARCH ADDRESS
003USER03 USER	FAX	E-MAIL	007USER07 USER	FAX	E-MAIL	GROUP
004USER04 USER	FAX	E-MAIL	008USER08 USER	FAX	E-MAIL	

SETTINGS ALL CLEAR E-MAIL ADDRESS 1/125 Next

- The GROUP screen is displayed.

2 Press the [SEARCH GROUP] button.

DESTINATION: 0000

ADDRESS DESTINATION

GROUP

001Group01	CONTENTS	005Group05	CONTENTS	KNOWN ID
002Group02	CONTENTS	006Group06	CONTENTS	SEARCH GROUP
003Group03	CONTENTS	007Group07	CONTENTS	ADDRESS BOOK
004Group04	CONTENTS	008Group08	CONTENTS	

SETTINGS ALL CLEAR E-MAIL ADDRESS 1/25 Next

- The KNOWN ID screen is displayed.

3 Press the [GROUP NAME] button to enter the group name that you want to search, and then press the [SEARCH] button.

DESTINATION: 0000

ADDRESS DESTINATION

GROUP SEARCH

GROUP NAME Group09

CLEAR CANCEL SEARCH

- When pressing the [GROUP NAME] button, the letter entry screen is displayed. Enter the value using the keyboard and digital keys, and press the [ENTER] button to set the entry.

Tip

It will search for the groups that contain the search text in the group name.

4 Press the group buttons that you want to select as the destination, and press the [ENTER] button.

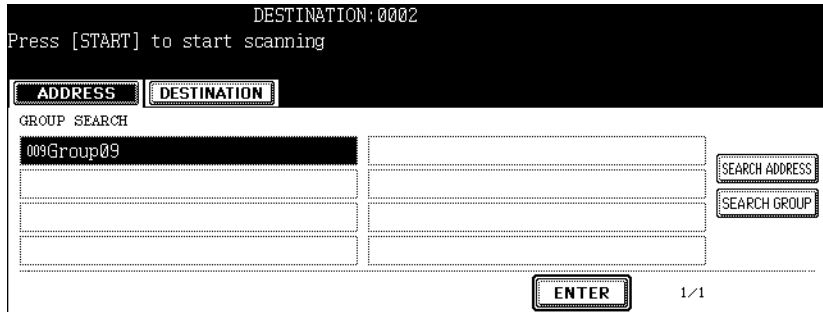

- The screen returns to the GROUP screen.

5 Press the [SETTINGS] button.

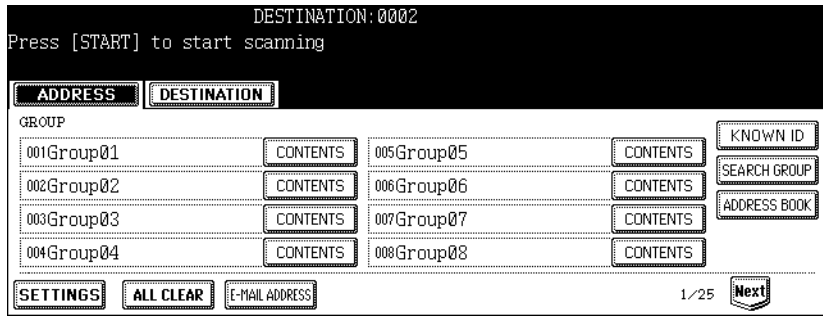

- The screen returns to the SCAN TO E-MAIL screen.

Tips

- You can confirm the E-mail addresses that registered in the group by pressing the [CONTENTS] button.
- Before pressing the [SETTINGS] button, you can specify other E-mail addresses as you require.
- You can confirm or remove the E-mail addresses that you specified in the DESTINATION screen which can be displayed by pressing the [DESTINATION] button.
 P.67 “Confirming or removing E-mail addresses from destination”

Confirming or removing E-mail addresses from destination

When you want to remove the E-mail addresses, contacts, or groups that are added as the destination, operate the following procedure.

1 Press the [DESTINATION] button.

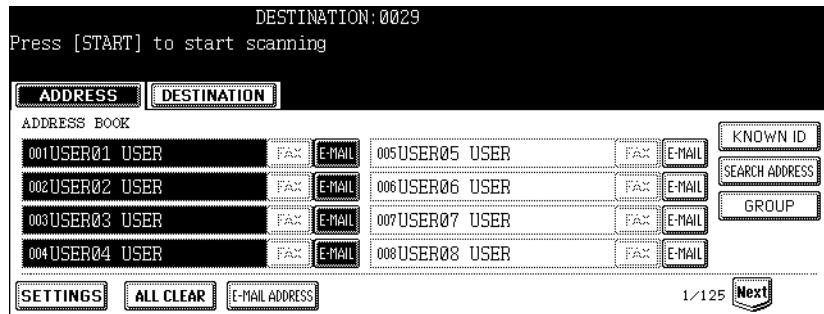

- The DESTINATION screen is displayed.

2 You can confirm the destinations that are currently specified. To remove E-mail addresses, contacts, or groups that you selected for destination, select the name that you want to remove, and press the [DELETE] button.

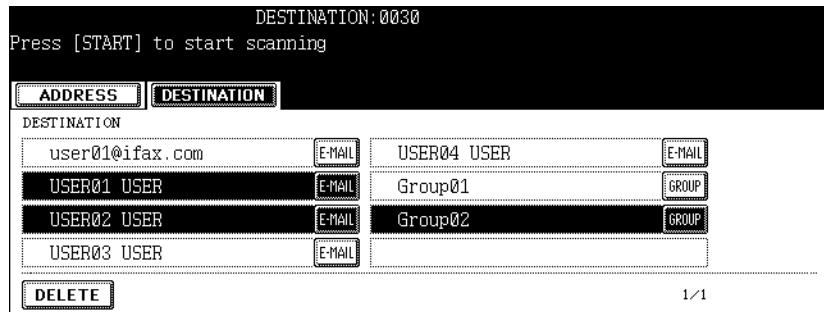

5

Using Template

This section describes the instructions on how to use scan templates.

Scanning Using Template	70
Registering Scan Template	78

Scanning Using Template

Users can also use a template to operate scanning on this equipment.

It enables users to register templates for scanning operations.

After registering a template, users can operate the desired scanning operation quickly without setting the scanning conditions.

Note

Before scanning using a template, users must register a template for scan operations.

For instructions on how to register a template, see the following section.

 P.78 “Registering Scan Template”

Tip

The templates that the Scan to E-mail agent is set will be available after user authenticates the access rights for the Scan to E-mail operation. For instructions on how to operate scan using a template, see the following section.

 P.73 “Using Scan to E-mail template when User Authentication for Scan to E-mail is enabled”

Scan Procedure using a template

1 Place the original(s).

- For instruction about placing the originals, see *Operator’s Manual for Basic Function*.

2 Press the [TEMPLATE] button on the control panel to enter the template menu.

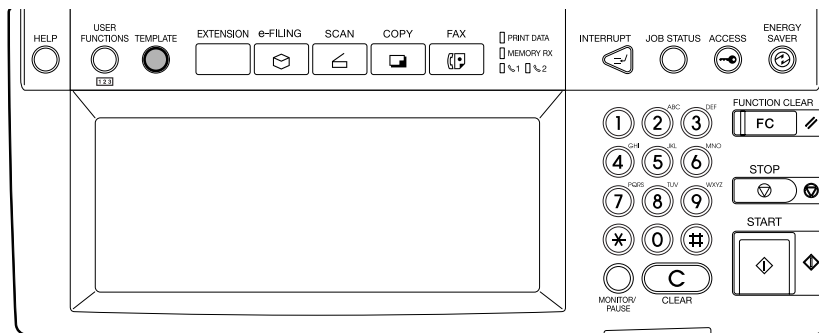

- The screen to select a template group is displayed.

3 Press the template group button that contains the template that you want to recall.

Select a GROUP	
RECALL REGISTRATION	
GROUP Number	
PUBLIC TEMPLATE GROUP	004
001 User01	005
002	006
003	007
CANCEL 1/26 Next	

- When you press a [PUBLIC TEMPLATE GROUP] button or user template group button with no password set, the screen to select a template is displayed. If the screen to select a template is displayed, skip to Step 5.
- If a password has been set for the selected user template group, the password input screen is displayed. If the password input screen is displayed, continue to the next step.

Tip

If you cannot find the desired user template group button in the screen, press the [Next] button to switch the screen to find the desired user template group button.

4 If the password entry screen is displayed, enter the password for the selected user template group using digital keys, and press the [ENTER] button.

PASSWORD
(5-digit)

NAME : User01
USER NAME : User01

Password : *****

CANCEL ENTER

- The screen to select a template is displayed.

5 Press the template button that you want to recall.

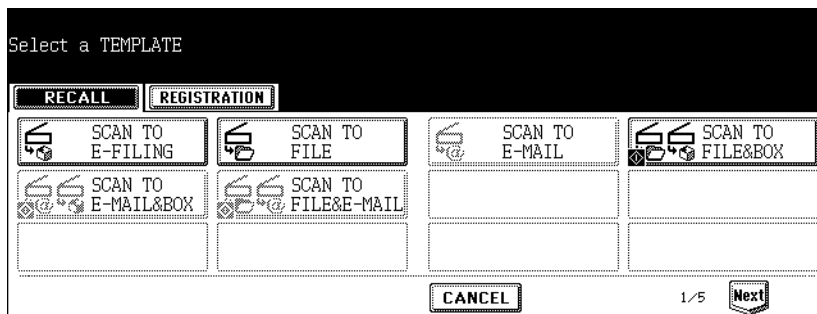

- If you select a template with the automatic start function enabled (the  icon is displayed in the lower left corner of the button) and a password is not set, the scanning operation is automatically started. If a password is set for the template, you must enter the password. In that case, continue to the next step.
- If you select a template with the automatic start function disabled, the basic scan menu is displayed. In that case, continue the operation.

6 If a password is set for the selected template, the password entry screen is displayed. Enter the 5-digit password using the digital keys and press the [ENTER] button.



- If you select a template with the automatic start function enabled, the scanning operation is automatically started and completed.

7 Press the [SCAN!] button.

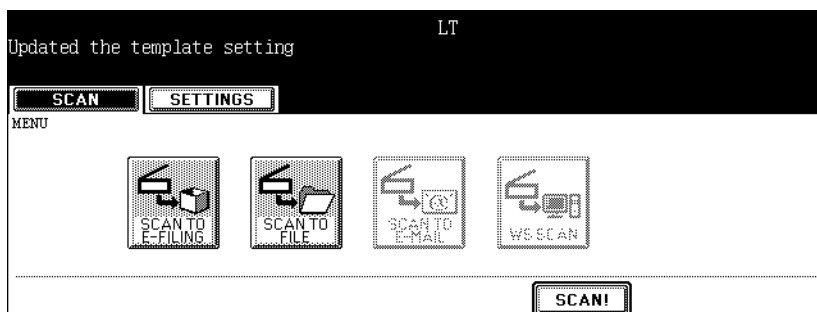

Tip

If you want to change the scan conditions, press the desired agent button and set the scan conditions as you require.

- 8** If the “To continue, place document on glass. And press Scan!” message is displayed, place another original on the glass and press [SCAN!] to scan another original, or press the [JOB FINISH] button to finish scanning.



- When the original is set on the Automatic Document Feeder, this screen is not displayed. However, this screen is displayed when you press the [CONTINUE] button while scanning the originals.
- If you want to cancel the storage of the scanned data, press the [JOB CANCEL] button.
- You can change the setting of the original type and scanning conditions, using the [EDIT] button before pressing the [SCAN!] button.

Using Scan to E-mail template when User Authentication for Scan to E-mail is enabled

When the User Authentication for Scan to E-mail is enabled, operate the following procedure to use the template that is registered the Scan to E-mail agent.

- 1 Place the original(s).**
 - For instruction about placing the originals, see *Operator's Manual for Basic Function*.
- 2 Press the [SCAN] button on the control panel to enter the scan menu.**

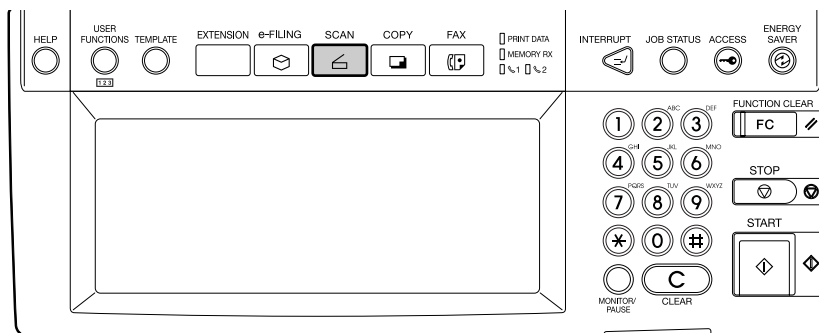

- The basic scan menu is displayed.

3 Press the [SCAN TO E-MAIL] button.

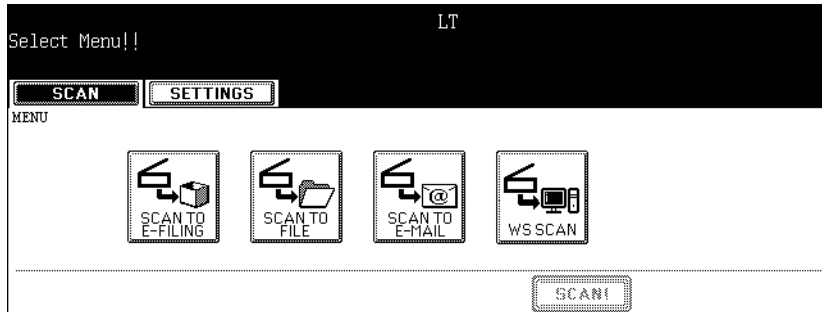

- The AUTHENTICATION screen is displayed.

4 Enter the user name and password by pressing the [USER NAME] and [PASSWORD] buttons, and press the [ENTER] button.

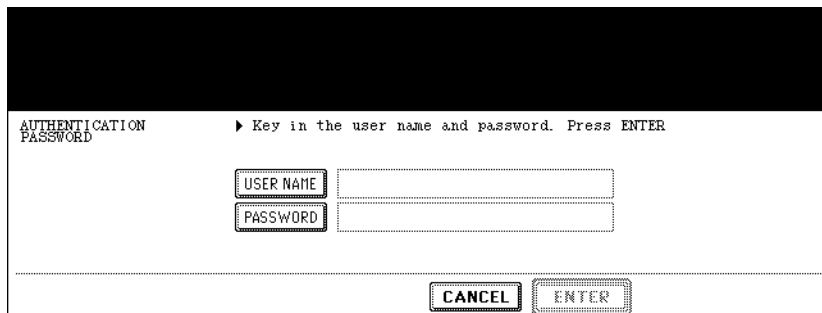

- When pressing each button, the letter entry screen is displayed. Enter the value using the keyboard and digital keys, and press the [ENTER] button to set the entry.

5 Press the [TEMPLATE] button on the control panel to enter the template menu.

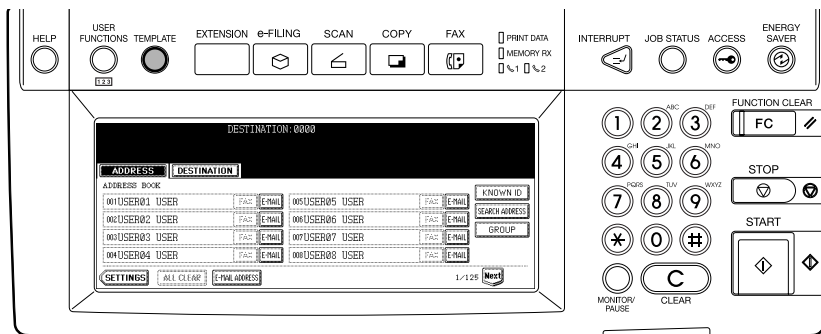

- The screen to select a template group is displayed.

6 Press the template group button that contains the template that you want to recall.

Select a GROUP

RECALL **REGISTRATION**

GROUP Number

PUBLIC TEMPLATE GROUP

004 User04

005 User05

006 User06

007 User07

001 User01

002 User02

003 User03

CANCEL 1/26 Next

- When you press a [PUBLIC TEMPLATE GROUP] button or user template group button with no password set, the screen to select a template is displayed. If the screen to select a template is displayed, skip to Step 8.
- If a password has been set for the selected user template group, the password input screen is displayed. If the password input screen is displayed, continue to the next step.

Tip

If you cannot find the desired user template group button in the screen, press the [Next] button to switch the screen to find the desired user template group button.

7 If the password entry screen is displayed, enter the password for the selected user template group using digital keys, and press the [ENTER] button.

PASSWORD
(5-digit)

NAME : User01

USER NAME : User01

Password : *****

CANCEL ENTER

- The screen to select a template is displayed.

8 Press the Scan to E-mail template button that you want to recall.

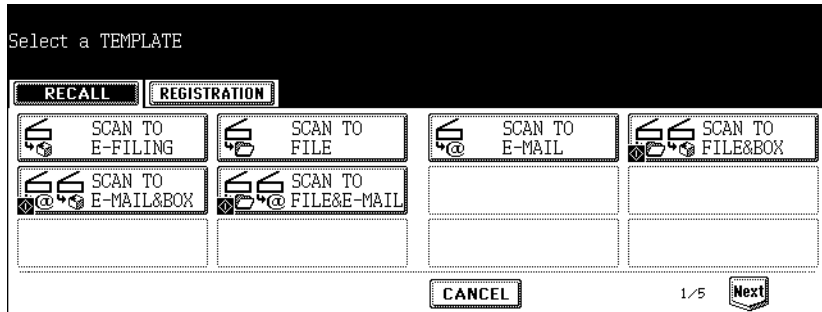

- If you select a template with the automatic start function enabled (the  icon is displayed in the lower left corner of the button), the scanning operation is automatically started. In that case, finish the operation.
- If you select a template with the automatic start function disabled, the basic scan menu is displayed. In that case, continue the operation.

9 Press the [SCAN!] button.

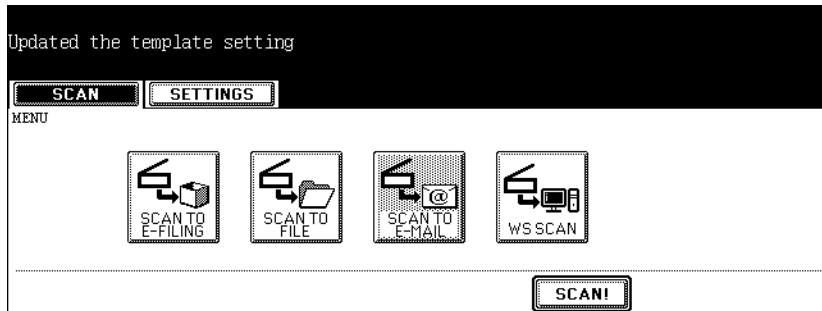

Tip

If you want to change the scan conditions, press the desired agent button and set the scan conditions as you require.

-
- 10** If the “To continue, place document on glass. And press Scan!” message is displayed, place another original on the glass and press [SCAN!] to scan another original, or press the [JOB FINISH] button to finish scanning.



- When the original is set on the Automatic Document Feeder , this screen is not displayed. However, this screen is displayed when you press the [CONTINUE] button while scanning the originals.
- If you want to cancel the storage of the scanned data, press the [JOB CANCEL] button.
- You can change the setting of the original type and scanning conditions, using the [EDIT] button before pressing the [SCAN!] button.

Registering Scan Template

To recall a template, you need to first register the setting combination as a template. This procedure enables users to register templates for scanning operations. The template is registered either in the “PUBLIC TEMPLATE GROUP” or “USER GROUP” depending on your purpose.

- **PUBLIC TEMPLATE GROUP**

Anyone can use the template when the setting combination of the functions frequently used throughout the company or organization have been registered in this group. Up to 60 combinations (templates) are available in this group. According to the purpose of use, you can restrict the use by entering the password.

 P.78 “Registering a scan template in public template group”

- **USER GROUP**

Each department, section or person controls one user group and registers it as a template. It is easier to control it if you set the password for group registration. Up to 200 groups can be set and up to 60 combinations (templates) are available in this group.

Note

When registering the template in the public template group, entering the administrator password is required.

Registering a scan template in public template group

1 Press the [SCAN] button on the control panel to enter the scan menu.

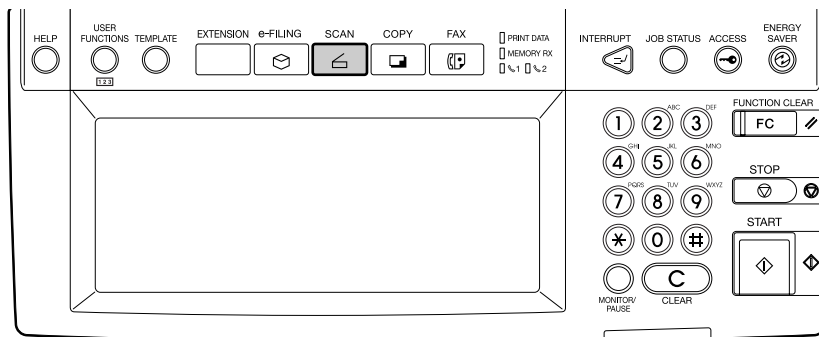

- The basic scan menu is displayed.

2 Press the buttons of the agent and set the scanning conditions.

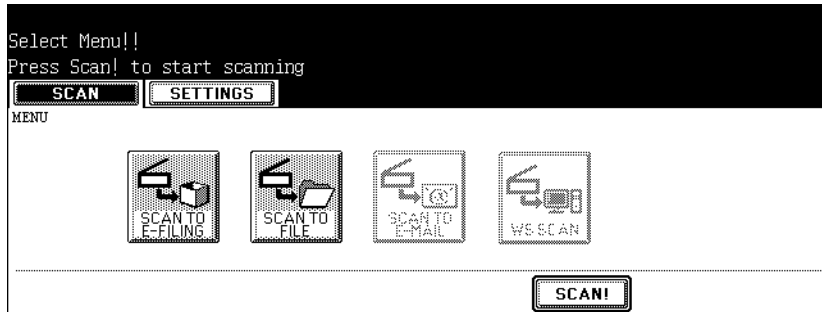

- For instructions on how to set each scan agent, see the instructions for each scan mode.
 - 📖 P.28 “How to Perform Scan to e-Filing”
 - 📖 P.38 “How to Perform Scan to File”
 - 📖 P.50 “How to Perform Scan to E-mail”

Note

Do not press the [SCAN!] button at this time.

3 Press the [TEMPLATE] button on the control panel to enter the template menu.

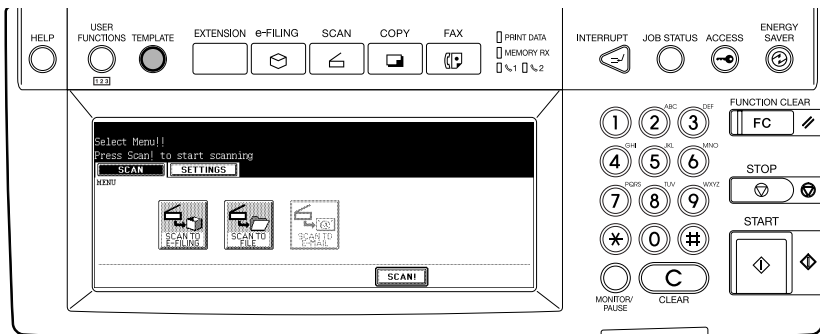

- The screen to select a template group is displayed.

4 Press the [REGISTRATION] button.

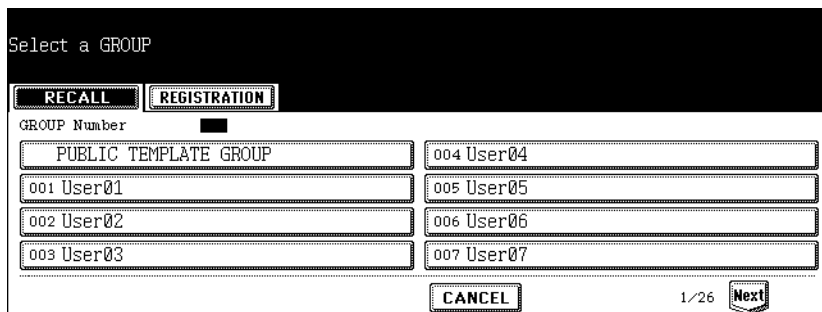

5 Select the “PUBLIC TEMPLATE GROUP” button, and press the [ENTER] button.

Select a GROUP

RECALL REGISTRATION

GROUP Number

PUBLIC TEMPLATE GROUP

001 User01

002 User02

003 User03

004 User04

005 User05

006 User06

007 User07

DELETE EDIT CANCEL ENTER 1/26 Next

- The ADMINISTRATOR PASSWORD screen is displayed.

6 Press the [PASSWORD] button.

ADMINISTRATOR PASSWORD

KEY

PASSWORD

CANCEL

- The letter entry screen is displayed.

7 Enter the administrator password using the keyboard and the digital keys, and press the [ENTER] button.

! " # \$ % & ' () = ~ | \ { } Back Space

* < > ? _ - ^ @ + | | ; : / \ ← →

Q W E R T Y U I O P

A S D F G H J K L

Z X C V B N M , . Shift Caps Lock

Space CANCEL ENTER

- The screen to select a template is displayed.

8 Select the blank template button and press the [SAVE] button.

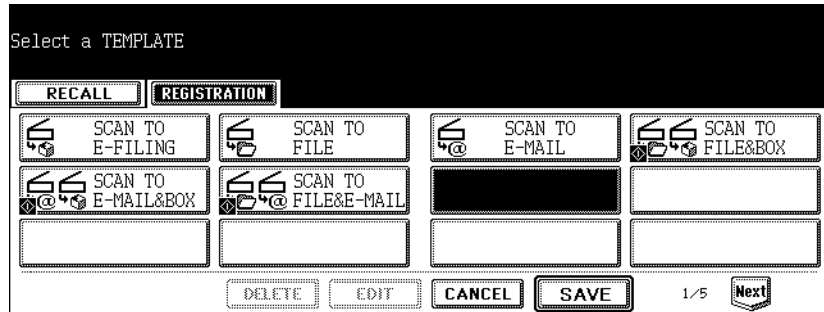

Tip

You can also select the existing template button to overwrite the template settings.

9 Specify the following items as you require and press the [SAVE] button.

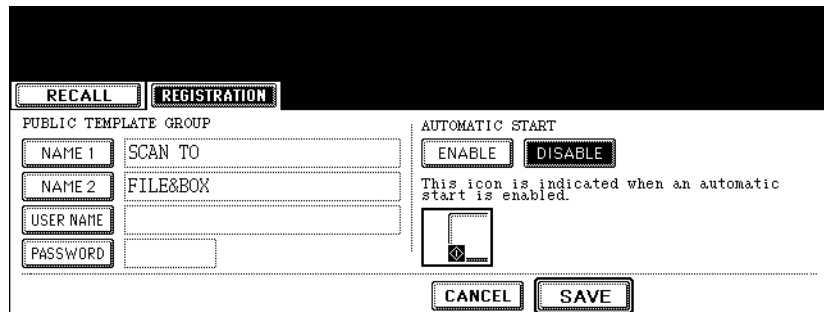

- **[NAME 1]**
Press this to enter the name that appears in the first line on the button.
- **[NAME 2]**
Press this to enter the name that appears in the second line on the button.
- **[USER NAME]**
Press this to enter the user name of the template.
- **[PASSWORD]**
Press this to enter the 5-digit password of the template. If the password is set, users must enter the password to apply the selected template.
- **AUTOMATIC START**
Select whether the automatic start function is enabled or disabled. If the automatic start function is enabled, the operation will start automatically when the user selects the template button. The  icon will be displayed in the lower left corner of the template button if this function is enabled.

10 Press the [FUNCTION CLEAR] button on the control panel to clear the settings in the scan menu.

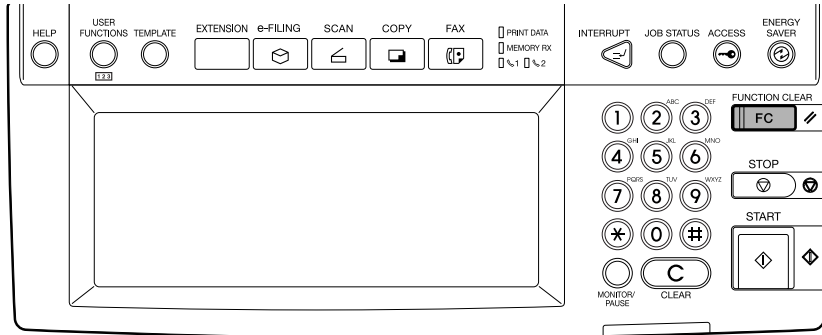

Registering a scan template in a user template group

1 Press the [SCAN] button on the control panel to enter the scan menu.

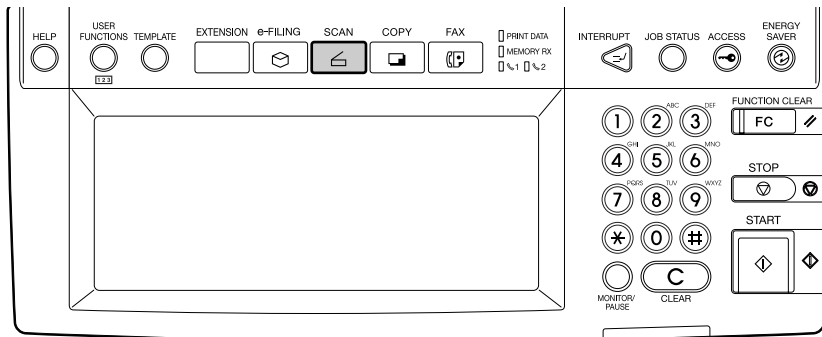

- The basic scan menu is displayed.

2 Press the buttons of the agent and set the scanning conditions.

- For instructions on how to set each scan agent, see the instructions for each scan mode.
 - 📖 P.28 “How to Perform Scan to e-Filing”
 - 📖 P.38 “How to Perform Scan to File”
 - 📖 P.50 “How to Perform Scan to E-mail”

Note

Do not press the [SCAN!] button at this time.

3 Press the [TEMPLATE] button on the control panel to enter the template menu.

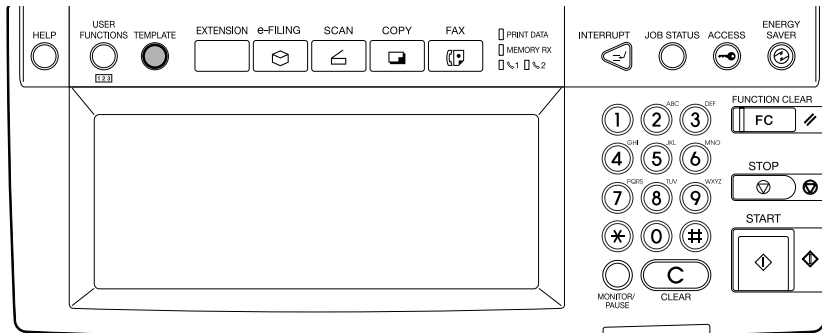

- The screen to select a template group is displayed.

4 Press the [REGISTRATION] button.

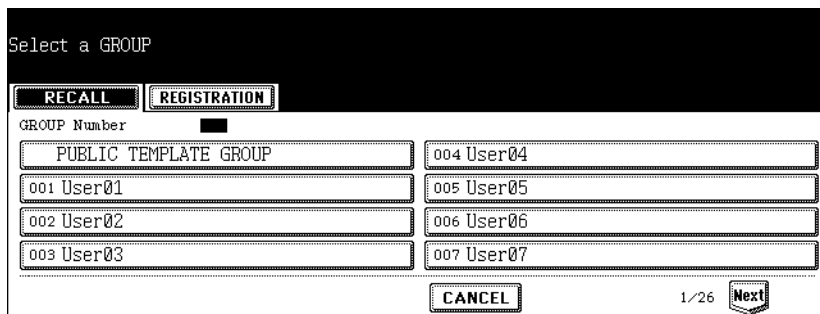

5 Select the user template group name where you want to register a new template, and press the [ENTER] button.

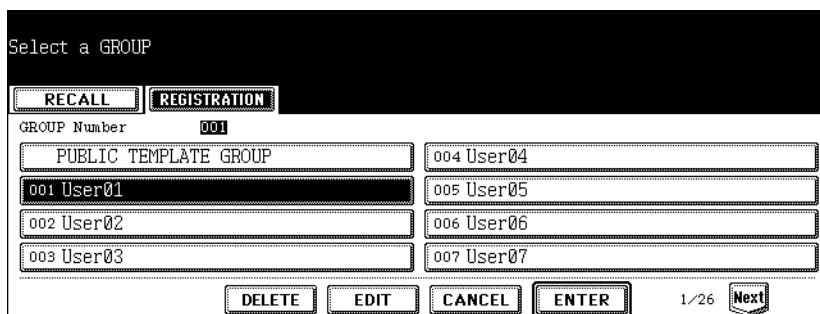

- When you press the user template group button with no password set, the screen to select a template is displayed. If the screen to select a template is displayed, skip to Step 7.
- If a password has been set for the selected user template group, the password input screen is displayed. If the password input screen is displayed, continue to the next step.

Tip

If you cannot find the desired user template group button in the screen, press the [Next] button to switch the screen to find the desired user template group button.

- 6** If the password entry screen displayed, enter the password for the selected user template group using digital keys, and press the [ENTER] button.

- The screen to select a template is displayed.

- 7** Select the blank template button and press the [SAVE] button.

Tip

You can also select the existing template button to overwrite the template settings.

- 8** Specify the following items as you require and press the [SAVE] button.

- **[NAME 1]**
Press this to enter the name that appears in the first line on the button.
- **[NAME 2]**
Press this to enter the name that appears in the second line on the button.
- **[USER NAME]**
Press this to enter the user name of the template.

- **[PASSWORD]**
Press this to enter the 5-digit password of the template. If the password is set, users must enter the password to apply the selected template.
- **AUTOMATIC START**
Select whether the automatic start function is enabled or disabled. If the automatic start function is enabled, the operation will start automatically when user selects the template button. The  icon will be displayed in the lower left corner of the template button if this function is enabled.

9 Press the [FUNCTION CLEAR] button on the control panel to clear the settings in the scan menu.

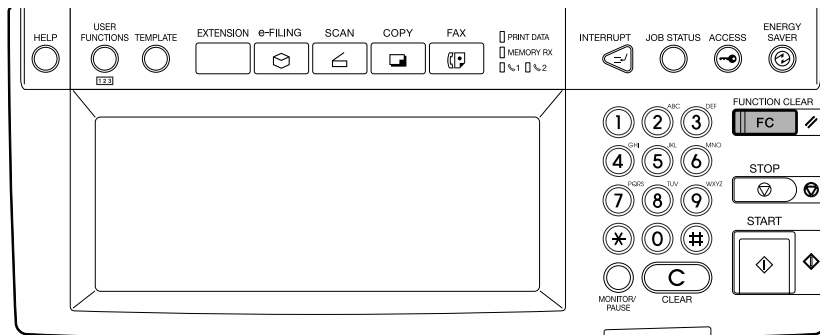

6

Copy & File

This section describes the instructions on how to perform Copy & File.

How to Perform Copy & File	88
---	-----------

How to Perform Copy & File

In this COPY & FILE function, the copied original data can be sent and stored to the Share folder of the hard disk in the equipment or the specified PC. You can access the data stored in the Share folder directly from the client PC via network.

Notes

- The scanned images by Copy & File are stored as black images.
- The network administrator has to make settings for storing the original data to the PCs. For details, see **Network Administration Guide**.
- It is recommended to back up the data stored in the Share folder of the hard disk with the client PC via network.
- The Copy & File operation does not allow you to select the resolutions and JPEG file format. A document that is stored by Copy & File is proper for output, and not for importing as an image into your computer. To get the best image quality for importing an image into your computer, please store the document by "Scan to File".
 P.37 "Scan to File"

Tip

You can also perform Copy & e-Filing. For more information, please refer to the **Operator's Manual for Basic Functions**.

The COPY & FILE function is available only when the Scanner Kit or Printer/Scanner Kit is installed.

Scanning Procedure for Copy & File

1 Place the original(s).

- For instruction about placing the originals, see **Operator's Manual for Basic Function**.

2 Press the [E-FILING/FILE] button on the basic screen to enter the filing menu.

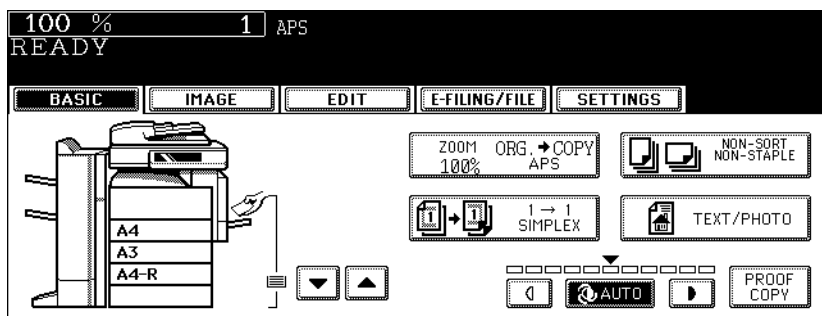

3 Press the [COPY & FILE] button.

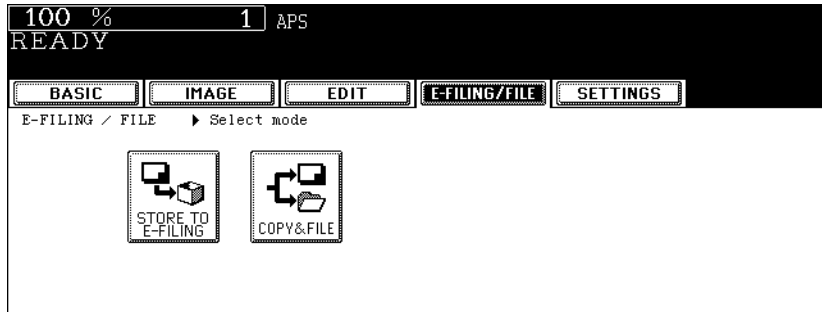

- The SAVE AS FILE screen is displayed.

4 Press the [FILE NAME] button if you want rename the document name of the scanned data.

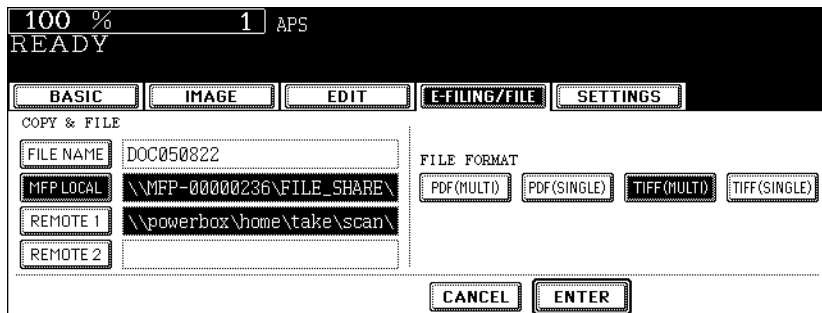

- The letter entry screen is displayed. Enter the value using the keyboard and digital keys, and press the [ENTER] button to set the entry.

5 If you want to store the scanned data in the shared folder of the equipment, make sure the [MFP LOCAL] button is selected (displayed as reversed button).

Note

You can set up to two destinations for Save as File. If you select the [MFP LOCAL] button, you can specify only one more remote destination. If you want to specify the two remote destinations, press the [MFP LOCAL] button to disable it (displayed as normal button).

6 If you want to store the scanned data in network folder, press the [REMOTE 1] or [REMOTE 2] buttons.

- If the selected remote destination (REMOTE 1 or REMOTE 2) is configured to save the scanned data in specified network folder by the administrator, the button will be the reversed button when you press it. In this case, users cannot change the destination.
- If the selected remote destination (REMOTE 1 or REMOTE 2) is configured for users to specify the desired network folder, the screen to set up the remote destination is displayed.

- 7** If the screen to set up the remote destination is displayed by pressing the [REMOTE 1] or [REMOTE 2] button, specify the remote destination. You can specify the remote destination using FTP, SMB, NetWare IPX, or NetWare IP.

When you want to store the data using FTP, select the [FTP] button and specify the following items as you require. Then press the [ENTER] button.

The screenshot shows a menu-driven interface for setting a remote destination. At the top, it displays '100 %' and '1 | APS'. Below that is a 'READY' status. A menu bar contains 'BASIC', 'IMAGE', 'EDIT', 'E-FILING/FILE', and 'SETTINGS'. The 'E-FILING/FILE' option is highlighted. Underneath, the 'REMOTE2' section is active. It includes a 'PROTOCOL' section with buttons for 'FTP', 'SMB', 'NetwareIPX', and 'NetwareIP'. The 'FTP' button is selected. Below the protocol buttons are input fields: 'SERVER NAME' with the value '10.10.70.101', 'NETWORK PATH' with the value 'user01\scan', 'LOGIN USER NAME' with the value 'take', 'PASSWORD' with a masked value '*****', and 'COMMAND PORT' with the value '-'. At the bottom of the screen are 'CANCEL' and 'ENTER' buttons.

- **[SERVER NAME]**
Press this to enter the IP address of the FTP server. For example, if you want to store the data into “ftp://10.10.70.101/user01/scan/”, enter “10.10.70.101” here.
- **[NETWORK PATH]**
Press this to enter the folder path to the folder where you want to store the data in the FTP server. For example, if you want to store the data into “ftp://10.10.70.101/user01/scan/”, enter “user01\scan” here. Make sure to use “\” instead of “/” to specify the path.
- **[LOGIN USER NAME]**
Press this to enter the user name to login the FTP server if required.
- **[PASSWORD]**
Press this to enter the password to login the FTP server if required.
- **[COMMAND PORT]**
Press this to enter the port number to be used for command. Generally “-” is entered for the command port. When “-” is entered, the port number that is set by the administrator will be used. Change this option only when you want to use another port number.

Tip

When you press each button, the letter entry screen is displayed. Enter the value using the keyboard and digital keys, and press the [ENTER] button to set the entry.

When you want to store the data using SMB, select the [SMB] button and specify the following items as you require. Then press the [ENTER] button.

The screenshot shows a terminal window with the following content:

```

100 % 1 APS
READY

BASIC IMAGE EDIT E-FILING/FILE SETTINGS
REMOTE2
PROTOCOL
FTP SMB NetwareIPX NetwareIP
SERVER NAME
NETWORK PATH \\powerbox\home\take\scan2
LOGIN USER NAME take
PASSWORD *****
COMMAND PORT
CANCEL ENTER
  
```

- **[NETWORK PATH]**
Press this to enter the network path to the folder where you want to store the data.
- **[LOGIN USER NAME]**
Press this to enter the user name to access the network folder if required.
- **[PASSWORD]**
Press this to enter the password to access the network folder if required.

Tip

When you press each button, the letter entry screen is displayed. Enter the value using the keyboard and digital keys, and press the [ENTER] button to set the entry.

Note

[SERVER NAME] and [COMMAND PORT] are not required to set when selecting the [SMB] button for protocol.

When you want to store the data using NetWare IPX or NetWare IP, select the [Netware IPX] or [Netware IP] button and specify the following items as you require. Then press the [ENTER] button.

The screenshot shows a terminal window with the following content:

```

100 % 1 APS
READY

BASIC IMAGE EDIT E-FILING/FILE SETTINGS
REMOTE2
PROTOCOL
FTP SMB NetwareIPX NetwareIP
SERVER NAME NWSRV
NETWORK PATH /sys/scan
LOGIN USER NAME admin.org
PASSWORD *****
COMMAND PORT
CANCEL ENTER
  
```

- **[SERVER NAME]**
When you select the [Netware IPX] button, press this to enter the NetWare file server name or Tree/Context name (when NDS is available).
When you select the [Netware IP] button, press this to enter the IP address of the NetWare file server.

- **[NETWORK PATH]**
Press this to enter the folder path to the folder where you want to store the data in the NetWare file server. For example, if you want to store the data into “sys\scan” folder in the NetWare file server, enter “\sys\scan” here.
- **[LOGIN USER NAME]**
Press this to enter the user name to login the NetWare file server if required.
- **[PASSWORD]**
Press this to enter the password to login the NetWare file server if required.

Tip

When you press each button, the letter entry screen is displayed. Enter the value using the keyboard and digital keys, and press the [ENTER] button to set the entry.

Note

[COMMAND PORT] is not required to set when selecting the [IPX/SPX] button for protocol.

8 Select the file format in “FILE FORMAT” option and press the [ENTER] button.

The screenshot shows a menu titled 'COPY & FILE' with a status bar at the top displaying '100 %', '1', and 'APS'. Below the status bar, the word 'READY' is visible. The menu has five tabs: 'BASIC', 'IMAGE', 'EDIT', 'E-FILING/FILE', and 'SETTINGS'. The 'E-FILING/FILE' tab is selected. Under this tab, there are four sections: 'FILE NAME' with the value 'DOC050822', 'MFP LOCAL' with the path '\\MFP-00000236\FILE_SHARE\'', 'PEI NOTE' with the path '\\powerbox\home\take\scan\'', and 'REMOTE 2' with the path '\\10.10.70.101\user01\scan\''. To the right of these sections is the 'FILE FORMAT' section with four buttons: 'PDF (MULTI)', 'PDF (SINGLE)', 'TIFF (MULTI)', and 'TIFF (SINGLE)'. At the bottom of the menu are 'CANCEL' and 'ENTER' buttons.

[PDF (MULTI)] — Press this to attach the scanned data as a multiple page PDF file.

When scanning several pages, this equipment will store all pages as one PDF file.

[PDF (SINGLE)] — Press this to attach the scanned data as a single PDF file for each page. When scanning several pages, this equipment will store each page separately as PDF files.

[TIFF (MULTI)] — Press this to attach the scanned data as a multiple page TIFF file.

When scanning several pages, this equipment will store all pages as one TIFF file.

[TIFF (SINGLE)] — Press this to attach the scanned data as a single TIFF file for each page. When scanning several pages, this equipment will store each page separately as TIFF files.

9 Press the [START] button.

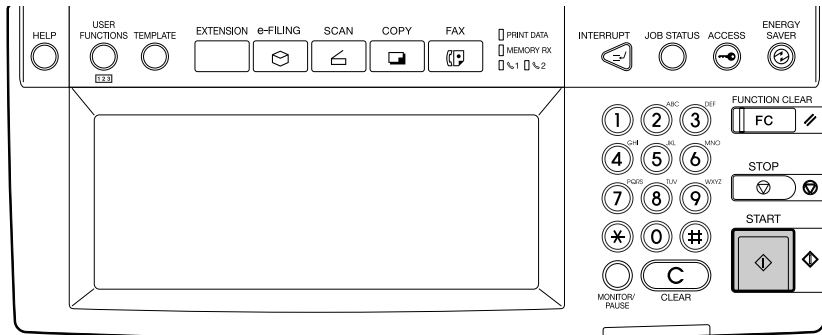

10 If the “NEXT ORIGINAL?” message is displayed, place another original on glass and press the [YES] button to copy another original, or press the [FINISHED] button to finish copying.



- When the original is set on the Automatic Document Feeder, this screen is not displayed.

Internet Fax

This section describes about the Internet Fax functions.

About Internet Fax	96
Precaution for Internet Transmission	96
Internet Fax Transmission Overview	96
How to Perform Internet Fax.....	98
Specifying Destinations	101
Advanced Function	112
Receiving Internet Fax.....	115

About Internet Fax

You can perform the Internet Fax function that provides the ability to transmit a scanned original as an E-mail, with an attached TIFF-FX (Profile S) file. Since an Internet line is used instead of a phone line, the communication cost can be reduced.

In this function, an E-mail address is specified in place of a phone number to transmit a scanned original to the Internet Fax equipment or the client computers.

When the Internet Fax is received, it is automatically output like regular Fax.

Note

The administrator needs to configure the network settings for Internet Fax to function. See the *Network Administration Guide*.

Precaution for Internet Transmission

Transmissions using the Internet Fax function are the same as E-mail transmissions.

Before you start to use the Internet Fax function, it is recommended that you read this section and understand the precautions for Internet transmission.

- The Internet Fax sends a document to the Internet E-mail server and it does not send via the PSTN* like regular facsimile transmissions.
- Internet transmission has low security. It is recommended that you use regular facsimile transmission when a confidential document is sent.
- It may take a considerable amount of time for the recipient to receive the document because of the line traffic in the Internet.
- If the document being transmitted has a large amount of data, it may not be successfully sent due to the configuration of the E-mail server.
- If the Internet Fax is sent to the multiple recipients at the same time and the header page is set to be printed on the recipient's devices, all recipient's addresses will be printed on the header page. If you want to secure the recipient information, send the Internet Fax separately to each recipient rather than sending to the multiple recipients at the same time.

* PSTN (Public Switched Telephone Network) is a global telephone system capable of communicating worldwide using copper wires to transmit analog data.

Internet Fax Transmission Overview

The following is an overview of the various transmissions that can be performed using the Internet Fax function.

- **Internet Fax to Internet Fax**

The equipment can send a document to another Internet Fax equipment through the Internet or Intranet. The document is sent as an E-mail.

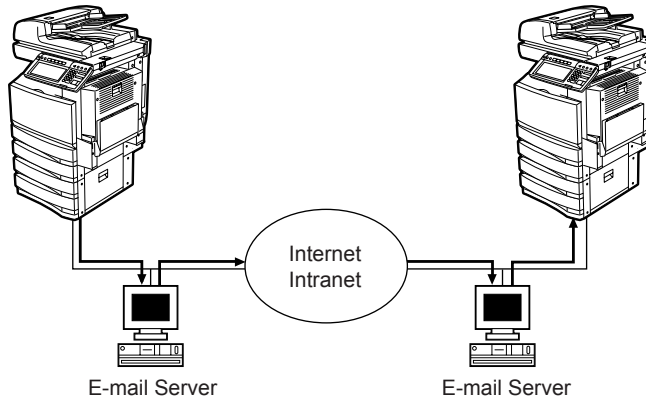

→ E-mail Transmission
— LAN

- **Internet Fax to/from Client Computers**

The equipment can send a document as an E-mail to client computers through the Internet or Intranet. The client computers can send an E-mail to the equipment as well.

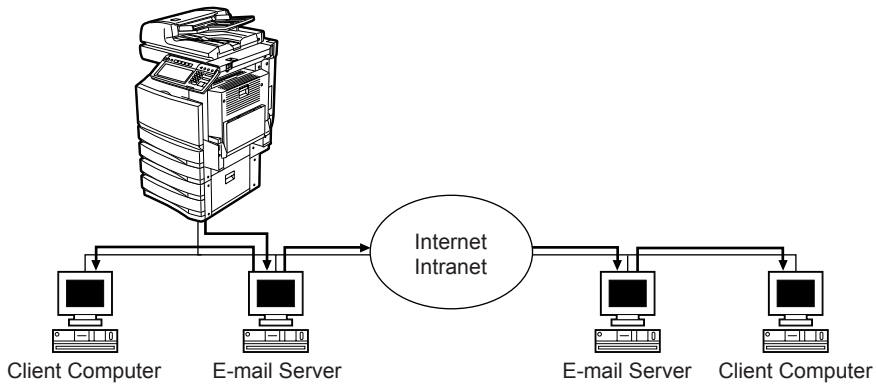

→ E-mail Transmission
— LAN

Notes

- The client computer receives TIFF-FX (Profile S) images when the equipment sends a document using the Internet Fax function.
- The equipment can only print out text files and TIFF images. When sending E-mail from the client computer to this equipment using the E-mail application, files other than text or TIFF images cannot be sent. For Available Format, see the following section.
📖 P.115 “Receiving Internet Fax”.

How to Perform Internet Fax

Using this function, scanned data can be sent to the specified E-mail address as an attached file as with the Scan to E-mail function. However, the Internet Fax function allows sending originals as TIFF-FX (Profile S) files, which are usable by any Internet Fax compatible devices

Note

To use Internet Fax, the configuration of the equipment needs to be set by the network administrator.

The Internet Fax function is available only when the Scanner Kit or Printer/Scanner Kit is installed.

Sending Procedure for Internet Fax

1 Press the [FAX] button on the control panel.

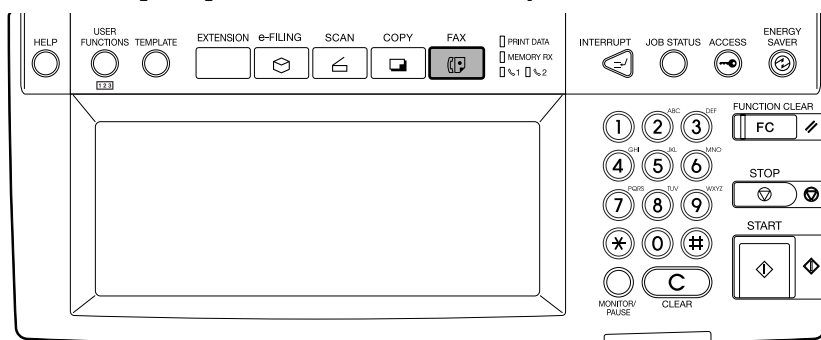

2 Press the [ADDRESS] button to display the address menu, and then press the [OPTION] button.

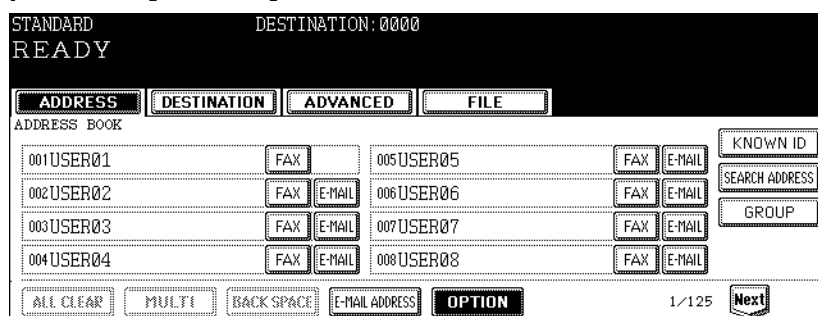

3 Specify the following items as you require and press the [Next] button.

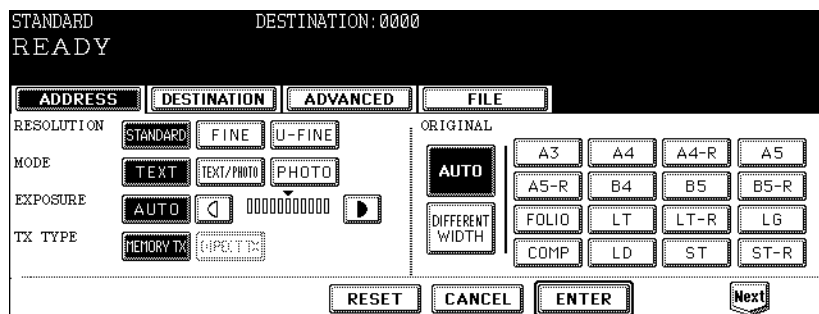

- **RESOLUTION**

Select the resolution before you scan the original to be sent.

Note

When sending to an Internet Fax destination only, [FINE] resolution will be applied even if you select [U-FINE].

- **MODE**

Set the image quality mode before you scan the original to be sent.

[TEXT] — Press this when scanning the originals that contain text.

[TEXT/PHOTO] — Press this when scanning originals that contain text and photos.

[PHOTO] — Press this when scanning originals that contain photos printed on photographic paper.

Tip

The transmission time may be longer when the TEXT/PHOTO or PHOTO mode is selected.

- **EXPOSURE**

Set the image density according to the contrast of the original to be sent.

In the automatic exposure mode, the copier automatically judges the contrast of the original, and selects the optimum contrast.

In the manual exposure mode, you can adjust the contrast manually in 11 steps.

- **TX TYPE**

When sending Internet Fax, you can only select the [MEMORY TX] button.

- **ORIGINAL**

Select the button corresponding to the original size, or select the [AUTO] button to automatically detect the original size.

When placing different-width originals, select the [DIFFERENT WIDTH] button.

Note

For Internet Fax, LT or LG size originals are sent in the same size as the originals. Originals larger than those sizes are reduced to LT to be sent. Originals smaller than those sizes are sent in LT without being enlarged.

4 Specify the following items as you require and press the [ENTER] button.

- **[SUBJECT]**
Press this to enter the subject of the Internet Fax to be sent.
- **[BODY]**
Press this to enter the body message of the Internet Fax to be sent.

Tips

- When you press the [SUBJECT] or [BODY] button, the letter entry screen is displayed. Enter the value using the keyboard and digital keys, and press the [ENTER] button to set the entry.
- The administrator can change the body message from TopAccess. See the "TopAccess Administrator Mode" in the TopAccess Guide for details.

Note

Other items such as "ECM", "QUALITY TX", "LINE SELECT", "[SUB/SEP]", "[SID/PWD]" are only applied to the fax transmission. When you only perform the Internet Fax transmission, you do not need to specify these items.

5 Specify the E-mail addresses that you want to send.

- You can specify the E-mail address by various ways. See the following procedures for each instruction.
 - P.101 "Specifying Destinations"

Tip

You can also set the advanced functions such as the 2-sided original transmission and priority transmission.

• P.112 "Advanced Function"

6 Press the [START] button.

- 7 If the “To continue, place document on glass. And press [START]” message is displayed, place another original on glass and press [START] button to scan another original, or press the [JOB FINISH] button to finish scanning.



- When the original is set on the Automatic Document Feeder, this screen is not displayed.
- If you want to cancel the storage of the scanned data, press the [JOB CANCEL] button.
- You can change the setting of the transmission conditions, using the [OPTION] button before pressing the [START] button.

Specifying Destinations

You can specify E-mail addresses for Internet Fax by following methods:

- 📖 P.101 “Entering an E-mail address manually”
- 📖 P.103 “Selecting from address book”
- 📖 P.103 “Searching with ID number for a contact”
- 📖 P.104 “Searching with search strings from address book”
- 📖 P.106 “Searching with search strings from LDAP server”
- 📖 P.108 “Selecting from groups”
- 📖 P.108 “Searching with ID number of a group”
- 📖 P.110 “Searching with group name”

Entering an E-mail address manually

- 1 Press the [E-MAIL ADDRESS] button.

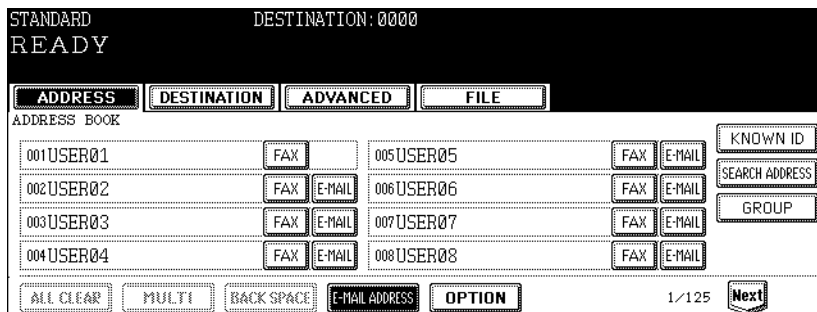

- The letter entry screen is displayed.

- 2** Enter the E-mail address that you want to send using the keyboard and digital keys, and press the [ENTER] button to set the entry.

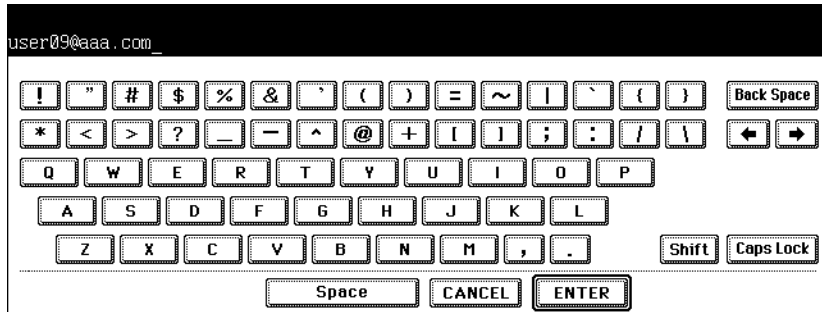

- The screen returns to the address menu.

- 3** Press the [MULTI] button and then press the [E-MAIL ADDRESS] button if you want to specify another E-mail address manually.

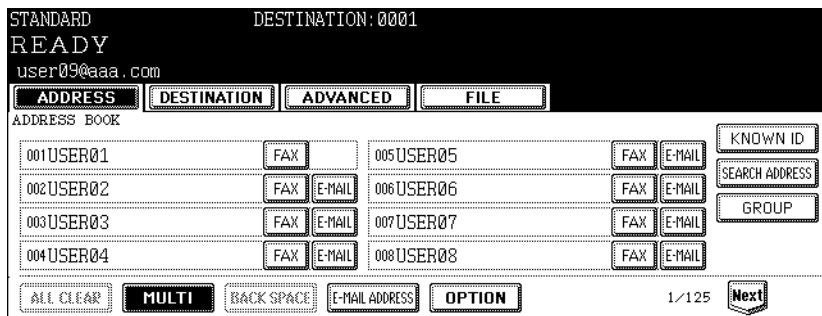

- If you press the [MULTI] button, the entered E-mail address is saved as the destination and you can enter another E-mail address using the [E-MAIL ADDRESS] button.
- If you press the [E-MAIL ADDRESS] button without pressing the [MULTI] button, you can edit the E-mail address that you entered.

Tips

- You can specify other E-mail addresses as you require.
- You can confirm or remove the E-mail addresses that you specified in the DESTINATION screen which can be displayed by pressing the [DESTINATION] button.
 P.111 “Confirming or removing E-mail addresses from destination”

Selecting from address book

1 Press the [E-MAIL] button of the contacts that you want to send.

STANDARD DESTINATION: 0001
READY
user02@aaa.com

ADDRESS DESTINATION ADVANCED FILE

ADDRESS BOOK

001USER01	FAX		005USER05	FAX	E-MAIL	KNOWN ID
002USER02	FAX	E-MAIL	006USER06	FAX	E-MAIL	SEARCH ADDRESS
003USER03	FAX	E-MAIL	007USER07	FAX	E-MAIL	GROUP
004USER04	FAX	E-MAIL	008USER08	FAX	E-MAIL	

ALL CLEAR MULTI BACK SPACE E-MAIL ADDRESS OPTION 1/125 Next

- The selected contacts are displayed as reversed buttons. To cancel the selection, press the contact again, then the button will be a normal button.

Tips

- You can specify other E-mail addresses as you require.
- You can confirm or remove the E-mail addresses that you specified in the DESTINATION screen which can be displayed by pressing the [DESTINATION] button.
 P.111 "Confirming or removing E-mail addresses from destination"

Searching with ID number for a contact

1 Press the [KNOWN ID] button.

STANDARD DESTINATION: 0000
READY

ADDRESS DESTINATION ADVANCED FILE

ADDRESS BOOK

001USER01	FAX		005USER05	FAX	E-MAIL	KNOWN ID
002USER02	FAX	E-MAIL	006USER06	FAX	E-MAIL	SEARCH ADDRESS
003USER03	FAX	E-MAIL	007USER07	FAX	E-MAIL	GROUP
004USER04	FAX	E-MAIL	008USER08	FAX	E-MAIL	

ALL CLEAR MULTI BACK SPACE E-MAIL ADDRESS OPTION 1/125 Next

- The KNOWN ID screen is displayed.

2 Enter the ID number of the contact that you want to search using the digital keys, and press the [ENTER] button.

STANDARD DESTINATION: 0000
READY

ADDRESS DESTINATION ADVANCED FILE

KNOWN ID Enter ID Number

KNOWN ID : 3

CANCEL ENTER

- The ADDRESS BOOK screen that contains the contact of the specified ID is displayed.

3 Press the [E-MAIL] button of the contact that you want to send.

STANDARD DESTINATION: 0001
READY
user03@aaa.com

ADDRESS DESTINATION ADVANCED FILE

ADDRESS BOOK

001USER01	FAX	005USER05	FAX	E-MAIL	KNOWN ID
002USER02	FAX	E-MAIL	006USER06	FAX	E-MAIL
003USER03	FAX	E-MAIL	007USER07	FAX	E-MAIL
004USER04	FAX	E-MAIL	008USER08	FAX	E-MAIL

ALL CLEAR MULTI BACK SPACE E-MAIL ADDRESS OPTION 1/125 Next

Tips

- You can specify other E-mail addresses as you require.
- You can confirm or remove the E-mail addresses that you specified in the DESTINATION screen which can be displayed by pressing the [DESTINATION] button.
 P.111 "Confirming or removing E-mail addresses from destination"

Searching with search strings from address book

1 Press the [SEARCH ADDRESS] button.

STANDARD DESTINATION: 0000
READY

ADDRESS DESTINATION ADVANCED FILE

ADDRESS BOOK

001USER01	FAX	005USER05	FAX	E-MAIL	KNOWN ID
002USER02	FAX	E-MAIL	006USER06	FAX	E-MAIL
003USER03	FAX	E-MAIL	007USER07	FAX	E-MAIL
004USER04	FAX	E-MAIL	008USER08	FAX	E-MAIL

ALL CLEAR MULTI BACK SPACE E-MAIL ADDRESS OPTION 1/125 Next

- The ADDRESS SEARCH screen is displayed.

2 Press the buttons to enter the search strings that you want to specify, and then enter the [SEARCH] button.

DESTINATION: 0000

ADDRESS DESTINATION ADVANCED FILE

ADDRESS SEARCH

FIRST NAME USER03 CORP.

LAST NAME DEPT.

FAX NO. KEYWORD

E-MAIL

DIR SERVICE CLEAR CANCEL SEARCH

- When pressing each button, the letter entry screen is displayed. Enter the value using the keyboard and digital keys, and press the [ENTER] button to set the entry.

Tip

It will search for the contacts that contain the search text in the specified items.

Note

If the [DIR SERVICE] button is displayed as a selected button, this equipment will search for contacts in the LDAP server. In that case, press the [DIR SERVICE] button to display the Directory Service Name screen and clear the selection of a directory service. Then press the [ENTER] button to return the ADDRESS SEARCH screen.

3 Press the contact that you want to send, and press the [ENTER] button.

DESTINATION: 0001

user03@aaa.com

ADDRESS DESTINATION ADVANCED FILE

ADDRESS SEARCH

003USER03	FAX	E-MAIL

ENTER 1/1

- The screen returns to the ADDRESS BOOK screen.

Tips

- You can specify other E-mail addresses as you require.
- You can confirm or remove the E-mail addresses that you specified in the DESTINATION screen which can be displayed by pressing the [DESTINATION] button.
 - 📖 P.111 “Confirming or removing E-mail addresses from destination”

Searching with search strings from LDAP server

Note

To search contacts in the LDAP server, the directory service must be registered using TopAccess by the network administrator.

1 Press the [SEARCH ADDRESS] button.

STANDARD DESTINATION: 0000
READY

ADDRESS DESTINATION ADVANCED FILE

ADDRESS BOOK

001USER01	FAX	005USER05	FAX	E-MAIL	KNOWN ID
002USER02	FAX	E-MAIL	006USER06	FAX	E-MAIL
003USER03	FAX	E-MAIL	007USER07	FAX	E-MAIL
004USER04	FAX	E-MAIL	008USER08	FAX	E-MAIL

ALL CLEAR MULTI BACK SPACE E-MAIL ADDRESS OPTION 1/125 Next

- The ADDRESS SEARCH screen is displayed.

2 Press the [DIR SERVICE] button.

DESTINATION: 0000

ADDRESS DESTINATION ADVANCED FILE

ADDRESS SEARCH

FIRST NAME	CORP.
LAST NAME	DEPT.
FAX NO.	KEYWORD
E-MAIL	

DIR SERVICE CLEAR CANCEL SEARCH

- The Directory Search Name screen is displayed.

Tip

When the [DIR SERVICE] button is displayed as a selected button, this equipment is currently configured to search a default directory service.

3 Select the directory service name that you want to search from, and press the [ENTER] button.

DESTINATION: 0000

ADDRESS DESTINATION ADVANCED FILE

Directory Search Name

dirserv1	
dirserv2	
dirserv3	

CANCEL ENTER 1/1

- The screen returns to the ADDRESS SEARCH screen.

4 Press the buttons to enter the search strings that you want to specify, and then enter the [SEARCH] button.

DESTINATION: 0000

ADDRESS DESTINATION ADVANCED FILE

ADDRESS SEARCH

FIRST NAME	USER03	CORP	
LAST NAME		DEPT.	
FAX NO.		KEYWORD	
E-MAIL			

DIR SERVICE CLEAR CANCEL SEARCH

- When pressing each button, the letter entry screen is displayed. Enter the value using the keyboard and digital keys, and press the [ENTER] button to set the entry.

Tip

It will search for the contacts that contain the search text in the specified items.

5 Press the [E-MAIL] button of the contact that you want to send, and press the [ENTER] button.

DESTINATION: 0001

user03@aaa.com

ADDRESS DESTINATION ADVANCED FILE

ADDRESS SEARCH

003USER03	FAX	E-MAIL	

ENTER 1/1

- The screen returns to the ADDRESS BOOK screen.

Tips

- You can specify other E-mail addresses as you require.
- You can confirm or remove the E-mail addresses that you specified in the DESTINATION screen which can be displayed by pressing the [DESTINATION] button.
 - 📖 P.111 “Confirming or removing E-mail addresses from destination”

Selecting from groups

1 Press the [GROUP] button.

STANDARD DESTINATION: 0000
READY

ADDRESS DESTINATION ADVANCED FILE

ADDRESS BOOK

001USER01	FAX	005USER05	FAX	E-MAIL
002USER02	FAX	006USER06	FAX	E-MAIL
003USER03	FAX	007USER07	FAX	E-MAIL
004USER04	FAX	008USER08	FAX	E-MAIL

KNOWN ID
SEARCH ADDRESS
GROUP

ALL CLEAR MULTI BACK SPACE E-MAIL ADDRESS OPTION 1/125 Next

- The GROUP screen is displayed.

2 Press the group buttons that you want to select as the destination.

STANDARD DESTINATION: 0003
READY

ADDRESS DESTINATION ADVANCED FILE

GROUP

001GROUP01	CONTENTS	005
002GROUP02	CONTENTS	006
003GROUP03	CONTENTS	007
004		008

KNOWN ID
SEARCH GROUP
ADDRESS BOOK

ALL CLEAR MULTI BACK SPACE E-MAIL ADDRESS OPTION 1/25 Next

Tips

- You can confirm the E-mail addresses that registered in the group by pressing the [CONTENTS] button.
 - You can specify other E-mail addresses as you require.
 - You can confirm or remove the E-mail addresses that you specified in the DESTINATION screen which can be displayed by pressing the [DESTINATION] button.
- P.111 "Confirming or removing E-mail addresses from destination"

Searching with ID number of a group

1 Press the [GROUP] button.

STANDARD DESTINATION: 0000
READY

ADDRESS DESTINATION ADVANCED FILE

ADDRESS BOOK

001USER01	FAX	005USER05	FAX	E-MAIL
002USER02	FAX	006USER06	FAX	E-MAIL
003USER03	FAX	007USER07	FAX	E-MAIL
004USER04	FAX	008USER08	FAX	E-MAIL

KNOWN ID
SEARCH ADDRESS
GROUP

ALL CLEAR MULTI BACK SPACE E-MAIL ADDRESS OPTION 1/125 Next

- The GROUP screen is displayed.

2 Press the [KNOWN ID] button.

STANDARD DESTINATION: 0000
READY

ADDRESS DESTINATION ADVANCED FILE

GROUP

001Group01	CONTENTS	005Group05	CONTENTS
002Group02	CONTENTS	006Group06	CONTENTS
003Group03	CONTENTS	007Group07	CONTENTS
004Group04	CONTENTS	008Group08	CONTENTS

KNOWN ID
SEARCH GROUP
ADDRESS BOOK

ALL CLEAR MULTI BACK SPACE E-MAIL ADDRESS OPTION 1/25 Next

- The KNOWN ID screen is displayed.

3 Enter the ID number of the group that you want to search using the digital keys, and press the [ENTER] button.

STANDARD DESTINATION: 0000
READY

ADDRESS DESTINATION ADVANCED FILE

KNOWN ID Enter ID Number

KNOWN ID : 9

CANCEL ENTER

- The GROUP screen that contains the group of the specified ID is displayed.

4 Press the group buttons that you want to select as the destination.

STANDARD DESTINATION: 0004
READY

ADDRESS DESTINATION ADVANCED FILE

GROUP

009Group09	CONTENTS	013	
010		014	
011		015	
012		016	

KNOWN ID
SEARCH GROUP
ADDRESS BOOK

ALL CLEAR MULTI BACK SPACE E-MAIL ADDRESS OPTION 2/25 Next Prev

Tips

- You can confirm the E-mail addresses that registered in the group by pressing the [CONTENTS] button.
- You can specify other E-mail addresses as you require.
- You can confirm or remove the E-mail addresses that you specified in the DESTINATION screen which can be displayed by pressing the [DESTINATION] button.
 P.111 "Confirming or removing E-mail addresses from destination"

Searching with group name

1 Press the [GROUP] button.

STANDARD DESTINATION: 0000
READY

ADDRESS DESTINATION ADVANCED FILE

ADDRESS BOOK

001USER01	FAX	005USER05	FAX	E-MAIL	KNOWN ID
002USER02	FAX	006USER06	FAX	E-MAIL	SEARCH ADDRESS
003USER03	FAX	007USER07	FAX	E-MAIL	GROUP
004USER04	FAX	008USER08	FAX	E-MAIL	

ALL CLEAR MULTI BACK SPACE E-MAIL ADDRESS OPTION 1/125 Next

- The GROUP screen is displayed.

2 Press the [SEARCH GROUP] button.

STANDARD DESTINATION: 0000
READY

ADDRESS DESTINATION ADVANCED FILE

GROUP

001Group01	CONTENTS	005Group05	CONTENTS	KNOWN ID
002Group02	CONTENTS	006Group06	CONTENTS	SEARCH GROUP
003Group03	CONTENTS	007Group07	CONTENTS	ADDRESS BOOK
004Group04	CONTENTS	008Group08	CONTENTS	

ALL CLEAR MULTI BACK SPACE E-MAIL ADDRESS OPTION 1/25 Next

- The KNOWN ID screen is displayed.

3 Press the [GROUP NAME] button to enter the group name that you want to search, and then press the [SEARCH] button.

DESTINATION: 0000

ADDRESS DESTINATION ADVANCED FILE

GROUP SEARCH

GROUP NAME Group09

CLEAR CANCEL SEARCH

- When pressing the [GROUP NAME] button, the letter entry screen is displayed. Enter the value using the keyboard and digital keys, and press the [ENTER] button to set the entry.

Tip

It will search for the groups that contain the search text in the group name.

4 Press the group buttons that you want to select as the destination, and press the [ENTER] button.

The screenshot shows a screen titled "DESTINATION: 0004". At the top, there are four buttons: ADDRESS, DESTINATION, ADVANCED, and FILE. Below these is a "GROUP SEARCH" section with a list of items. The first item, "009Group09", is highlighted. To the right of the list are several empty input fields. At the bottom right, there is an "ENTER" button and a "1/1" indicator.

- The screen returns to the GROUP screen.

Tips

- You can specify other E-mail addresses as you require.
- You can confirm or remove the E-mail addresses that you specified in the DESTINATION screen which can be displayed by pressing the [DESTINATION] button.
 P.111 "Confirming or removing E-mail addresses from destination"

Confirming or removing E-mail addresses from destination

When you want to remove the E-mail addresses, contacts, or groups that are added as the destination, operate the following procedure.

1 Press the [DESTINATION] button.

The screenshot shows a screen titled "DESTINATION: 0003". At the top, there are four buttons: ADDRESS, DESTINATION, ADVANCED, and FILE. Below these is a "DESTINATION" section with a list of users. Each user name (USER02, USER05, USER07) is followed by an "E-MAIL" button. To the right of the list are several empty input fields. At the bottom left, there is a "DELETE" button and a "1/1" indicator.

- The DESTINATION screen is displayed.

- 2** You can confirm the destinations that are currently specified. To remove E-mail addresses, contacts, or groups that you selected for destination, select the name that you want to remove, and press the [DELETE] button.

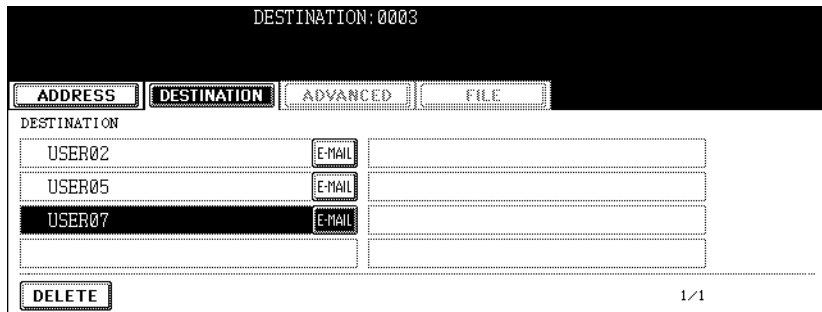

Advanced Function

The following advanced function can be used.

- **2-sided original TX:** 2-sided originals can be sent using the Automatic Document Feeder .
- **Priority TX:** You can send originals prior to the reserved transmissions.

Sending 2-sided Originals

You can scan and send 2-sided originals using the Automatic Document Feeder . Whenever a transmission is completed, the condition will automatically return to the default setting.

- Setting originals when sending LT/A4 2-sided originals
To set the originals on the Automatic Document Feeder , set the originals in the portrait orientation.

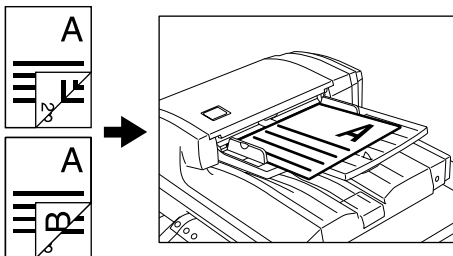

- 1** Press the [ADVANCED] button to display the advanced menu, and then press the [2-SIDED SCAN] button.

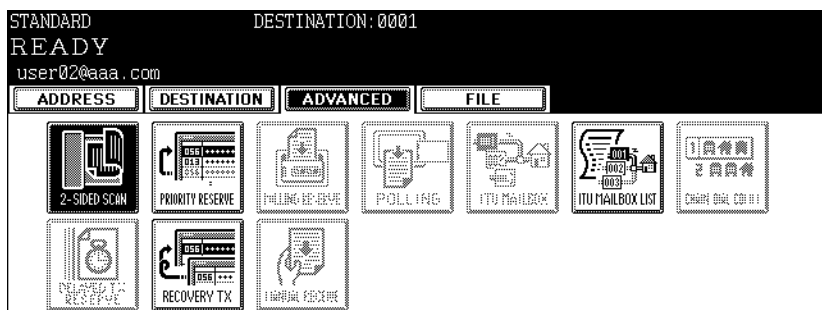

- The 2-SIDED SCAN screen is displayed.

- 2 Select the original type either the [BOOK] or [TABLET] button, and then press the [ENTER] button.

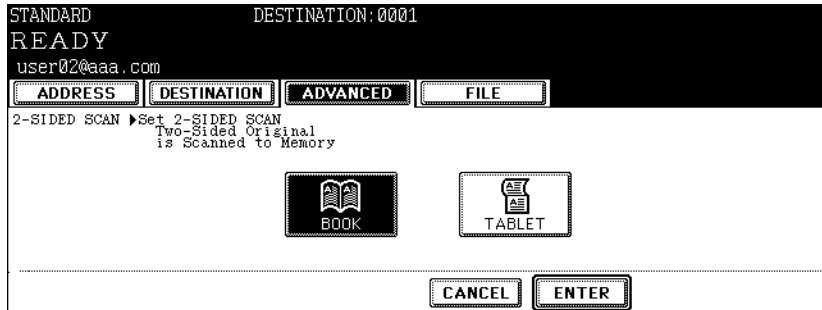

- The screen returns to the advanced menu.

- 3 Press the [ADDRESS] button to return to the address menu.

Priority Transmission

Priority TX allows you to execute a transmission prior to the other reserved transmissions.

Notes

- You can use 'Direct Entry' and 'Address Dialing' to specify the recipients.
- Priority TX can be performed only for 1 transmission.

- 1 Press the [ADVANCED] button to display the advanced menu, and then press the [PRIORITY RESERVE] button.

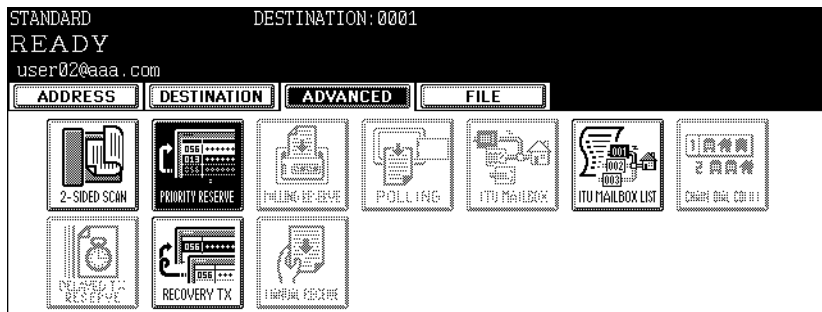

- The PRIORITY RESERVE screen is displayed.

- 2 Press the [ENTER] button.

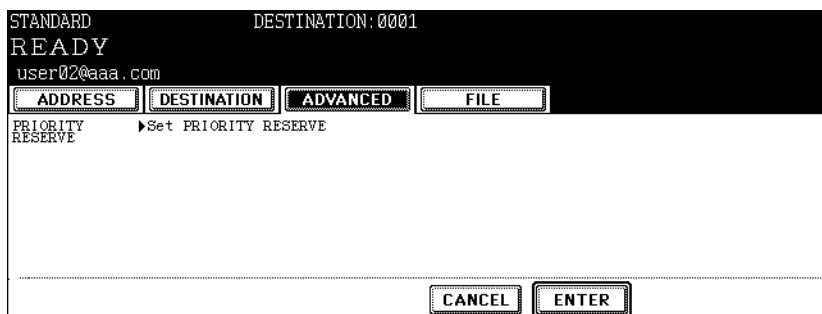

- The screen returns to the advanced menu.

3 Press the [ADDRESS] button to return to the address menu.

Receiving Internet Fax

The equipment accesses the E-mail server at specified intervals to check whether any E-mail has been delivered. If an E-mail has been delivered, the equipment will automatically retrieve and print out the E-mail.

When the [CHECK E-MAIL] button in the [USER] menu in the [USER FUNCTIONS] screen is pressed, the equipment manually accesses the E-mail server to check whether any E-mail has been delivered. If an E-mail has been delivered, the equipment receives and prints out the E-mail.

Available Format:

The TIFF-FX images, TIFF images scanned by the scanner and the text data can be printed. In addition, the resolution of the TIFF-FX image must be 8 x 3.85, 8 x 7.7 or 8 x 15.4 (dot/mm). The resolution of the TIFF images scanned by the scanner must be 200 x 100, 200 x 200, 200 x 400, 400 x 400 or 600 x 600 (dpi). If the received E-mail contains files that are not the ones described above, an error message will be displayed in the receive log.

To avoid such a case, you can print the report when an error occurs for E-mail printing and also forwarding this E-mail to another E-mail address can be set.

If you want to print the report when an error occurs for E-mail printing, set up "Enable Print E-mail Error".

If you want to forward the E-mail to another E-mail address when an error occurs, set up "Enable E-mail Error Forward" and "E-mail Error Transfer Address".

See the "Setting up the E-mail Print" in the **TopAccess Guide**.

Receiving Automatically

To automatically receive the Internet Fax from the E-mail server, set up the "Scan Rate" in the POP3 Network Service setting using TopAccess.

Checking whether any E-mail has been delivered at specified intervals will be performed automatically. (Default setting: every 5 minutes)

For setting the "Scan Rate", see **TopAccess Guide**.

Receiving Manually

1 Press the [USER FUNCTIONS] button on the control panel.

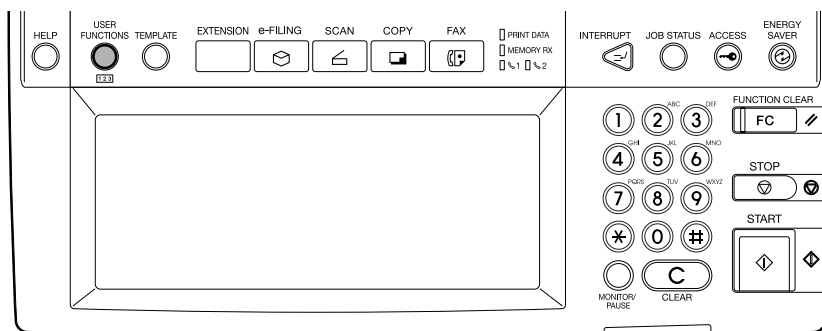

2 Press the [USER] button, and then press the [CHECK E-MAIL].

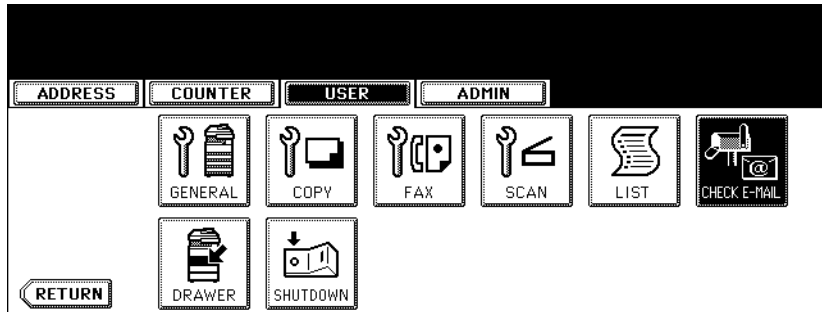

- Checking whether any E-mail has been delivered starts.

3 Checking completes.

- If the Internet Fax is received, "RECEIVING E-mail" appears on the screen upper right. Next, "NEW E-mail RECEIVED" appears for 2 seconds. Then, printing the Internet Fax starts.
- If no Internet Fax is received, "CURRENTLY NO E-mail" appears on the screen upper right for 2 seconds.

8

Remote Scan

This section describes about Remote Scan using the Remote Scan driver.

Installing Remote Scan Driver	118
Planning for Installation.....	118
Installing the Remote Scan Driver.....	118
Scanning Remotely Using Remote Scan Driver	123
When You Are Running the First Time.....	124
Remote Scan Driver Errors	132
Remote Scan Driver Error Conditions.....	132

Installing Remote Scan Driver

This section describes how to install the Remote Scan driver.

Planning for Installation

This equipment provides a Remote Scan driver that allows users to operate scanning remotely from a Windows computer and import the scanned images into a TWAIN-compliant application.

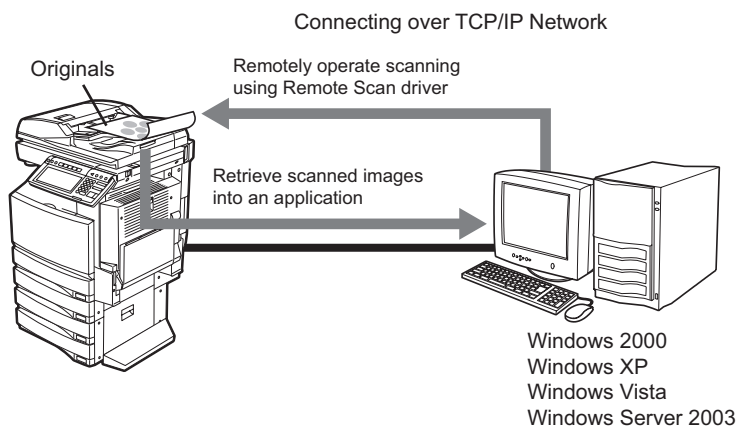

The Remote Scan driver can connect to this equipment over a TCP/IP network.

System Requirements

The Remote Scan driver is available for following environments:

- **OS**
 - Windows 2000 Service Pack 4
 - Windows XP Service Pack 1/Service Pack 2
 - Windows Vista
 - Windows Server 2003
- **Required Software**
 - TWAIN-compliant application
 - Microsoft Internet Explorer 5.5 Service Pack 2 or later (when IPv4 is used)
 - Microsoft Internet Explorer 7.0 or later (when IPv6 is used)
- **Recommended memories**
 - Scanning of the document in the black mode: 256 MB

Installing the Remote Scan Driver

You can install the Remote Scan driver from the Client Utilities CD-ROM or TopAccess.

Installing from Client Utilities CD-ROM

This section describes how to install the Remote Scan driver.

Installing the Remote Scan driver using the installer

This procedure describes an installation on Windows XP. The procedure is the same when other versions of Windows are used.

Note

You must log into Windows as a user who has the “Administrators” or “Power Users” privilege, when using Windows 2000, Windows XP, or Windows Server 2003.

1 Insert the Client Utilities CD-ROM into the CD-ROM drive.

- The installer automatically starts and the Choose Setup Language dialog box appears.
When the installer does not automatically start, double-click “Setup.exe” in the Client Utilities CD-ROM.

2 Select your language and click [OK].

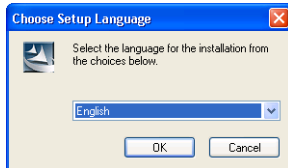

- The License Agreement screen is displayed.

3 Select “I accept the terms of the license agreement” and click [Next].

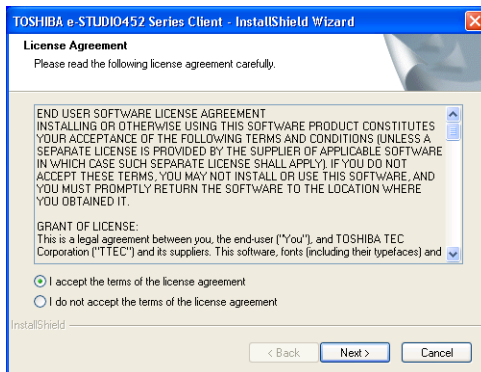

- The Setup Type screen is displayed.

4 Select “Custom” and click [Next].

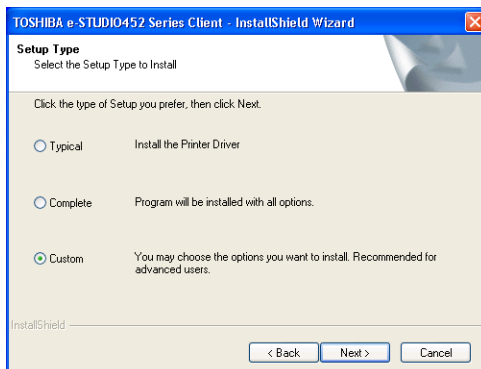

- The Select Components screen is displayed.

5 Check “TOSHIBA e-STUDIO Remote Scan driver”.

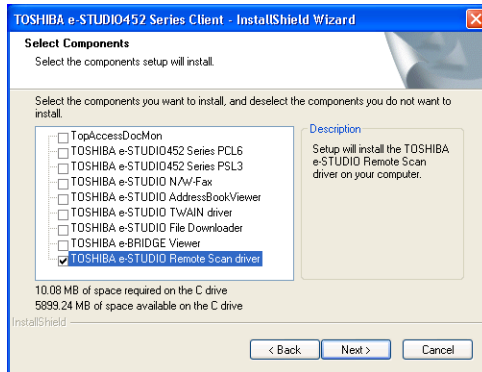

Tip

There are also Printing software, Network Fax software, and e-Filing software in the list. For more information about these software, please see the **Printing Guide**, **Network Fax Guide**, and **e-Filing Guide**.

6 Click [Next].

- The Choose Destination Location screen is displayed.

Tip

When you select the printer drivers or N/W-Fax driver, the Select Port dialog box appears. In that case, see the **Printing Guide** or **Network Fax Guide** for the instruction.

7 Click [Next].

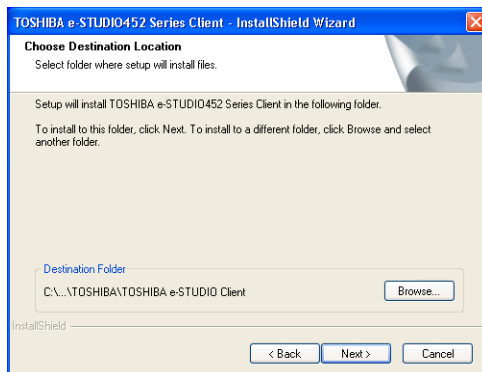

- If you want to change where the programs are installed, click [Browse]. In the dialog box that appears, select the folder and click [OK]. The Select Program Folder screen is displayed.

8 Click [Next].

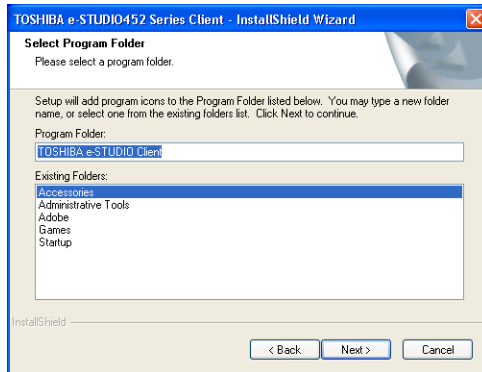

- If you want to change the program folder, rename the folder in the “Program Folder” field.
The Starting Copying Files screen is displayed.

9 Click [Finish].

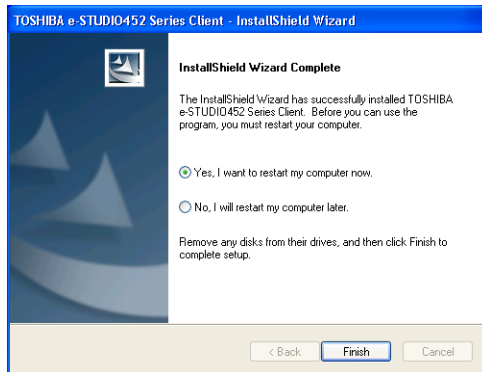

- The installation is completed.

Note

The Installer may ask you to restart your computer. If it does, select “Yes, I want to restart my computer now.” and click [Finish] to restart your computer.

Installing from TopAccess

If the system administrator has uploaded the software to this equipment, you can use TopAccess to install the software on your workstation.

Note

For instructions on how to upload the software in the equipment, please refer to the **TopAccess Guide**.

Installing Remote Scan driver from TopAccess

- 1 In TopAccess, click the Install Software link at the bottom of the screen.

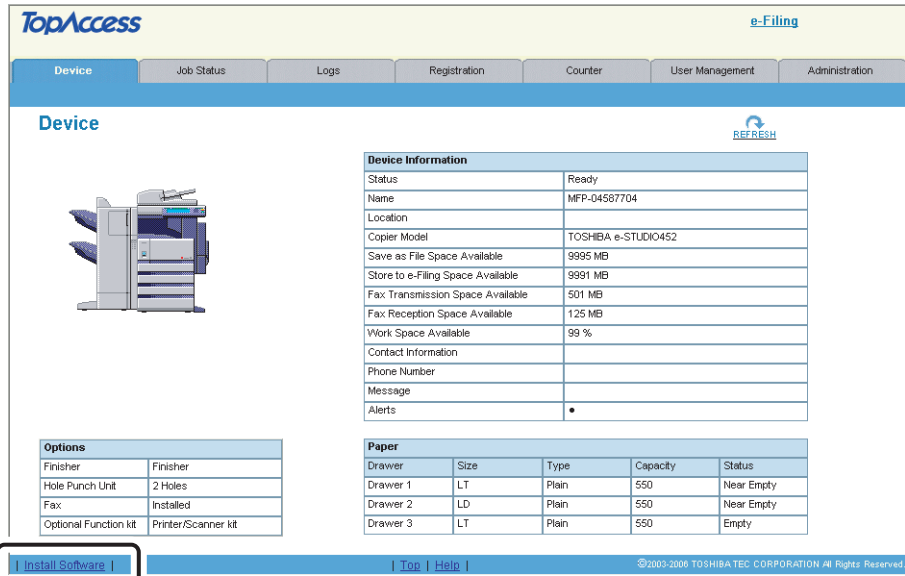

The screenshot shows the TopAccess web interface. At the top, there is a navigation bar with tabs for Device, Job Status, Logs, Registration, Counter, User Management, and Administration. The main content area is titled 'Device' and features a 'Device Information' table, an 'Options' table, and a 'Paper' table. A 'REFRESH' button is located in the top right of the device information section. At the bottom of the page, there is a footer with navigation links for 'Install Software', 'Top', and 'Help', along with a copyright notice for Toshiba Tec Corporation.

Status	Ready
Name	MFP-04587704
Location	
Copier Model	TOSHIBA e-STUDIO452
Save as File Space Available	9995 MB
Store to e-Filing Space Available	9991 MB
Fax Transmission Space Available	501 MB
Fax Reception Space Available	125 MB
Work Space Available	99 %
Contact Information	
Phone Number	
Message	
Alerts	•

Finisher	Finisher
Hole Punch Unit	2 Holes
Fax	Installed
Optional Function kit	Printer/Scanner kit

Drawer	Size	Type	Capacity	Status
Drawer 1	LT	Plain	550	Near Empty
Drawer 2	LD	Plain	550	Near Empty
Drawer 3	LT	Plain	550	Empty

- The Install Client Software page opens.

- 2 Click the “Install Client1” link to download the installer file.

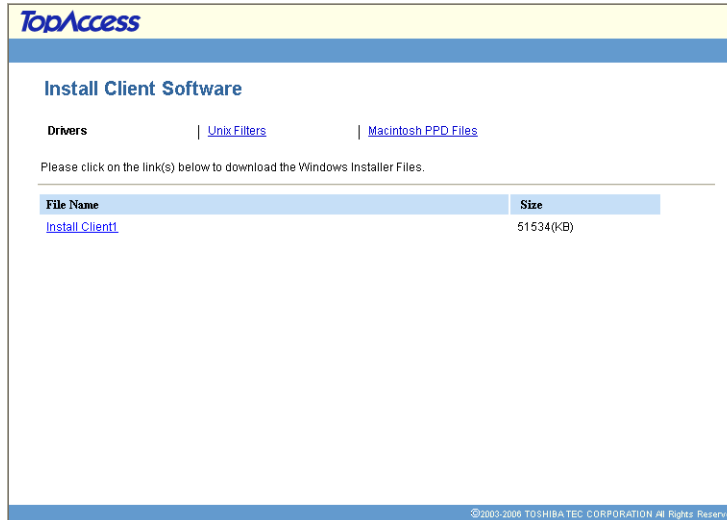

The screenshot shows the 'Install Client Software' page in the TopAccess web interface. The page has a header with the TopAccess logo and a sub-header 'Install Client Software'. Below the header, there are links for 'Drivers', 'Unix Filters', and 'Macintosh PPD Files'. A message states: 'Please click on the link(s) below to download the Windows Installer Files.' Below this message is a table with two columns: 'File Name' and 'Size'. The table contains one entry: 'Install Client1' with a size of 51534(KB). At the bottom of the page, there is a copyright notice for Toshiba Tec Corporation.

File Name	Size
Install Client1	51534(KB)

- 3 Download the installer file on your desktop by following the prompts.
- 4 Double-click the “InstallClient1.exe” file that you downloaded.
 - The installer starts and the InstallShield Wizard dialog box appears.
- 5 Follow the installation procedure using the Client Utilities CD-ROM described in following section.

📖 P.118 “Installing from Client Utilities CD-ROM”

Scanning Remotely Using Remote Scan Driver

You can use Remote Scan driver to import the scanned images into your TWAIN-compliant application. This software allows you to perform scanning the originals set in the equipment remotely from a client computer and acquire the image into the TWAIN-compliant application.

How to Scan

The Remote Scan driver can be launched from the TWAIN-compliant application.

Scanning using remote scan driver

- 1 Place the original(s).**
 - For instruction about placing the originals, see *Operator's Manual for Basic Function*.
- 2 Run the TWAIN-compliant application.**
- 3 Click [Select Device] (or the same functional command) in the [File] menu.**
 - The Select Source dialog box appears.
- 4 Select “e-STUDIO Remote Scan driver” and click [Select].**

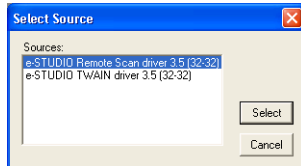

- 5 Click [Acquire Image] (or the same functional command) in the [File] menu.**
 - e-STUDIO Remote Scan driver dialog box appears.

Note

When you are running the Remote Scan driver the first time, the TopAccessDocMon Local Discovery dialog box appears. In this case, search the equipment in your network and configure the connection.

 P.124 “When You Are Running the First Time”

6 Specify the options and click [Scan].

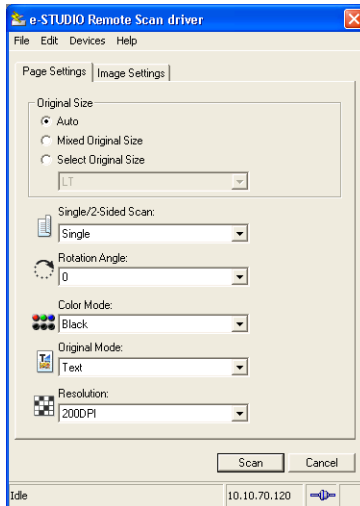

- Scanning originals starts and images are imported into the application when scanning is completed.
(The “Remote Connecting...” message is displayed while scanning the originals.)

When You Are Running the First Time

When you access the Remote Scan driver the first time, the TopAccessDocMon Local Discovery dialog box appears. In this case, search the equipment in your network and configure the connection.

Discovering the device automatically

1 In the TopAccessDocMon Local Discovery dialog box, click [Start Discovery] to begin the process.

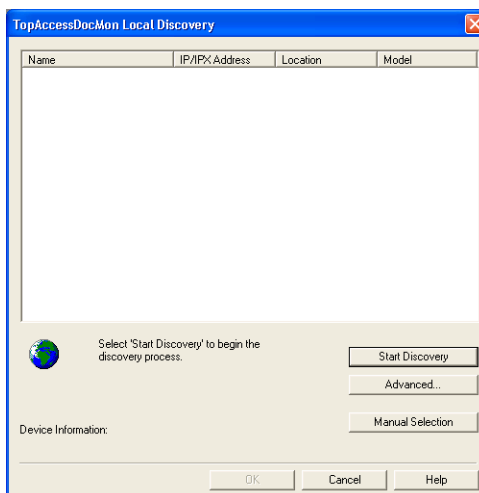

- It locates all the compatible devices in your network.

2 When the process is completed, found devices are listed in the list.

Tip

If the process continues for a long time, it is because too many network clients are on the network. In that case, you can configure the discovery using the [Advanced] button.

 P.126 "Configuring Discovery Settings"

3 Select the equipment that you want to connect from the list and click [OK].

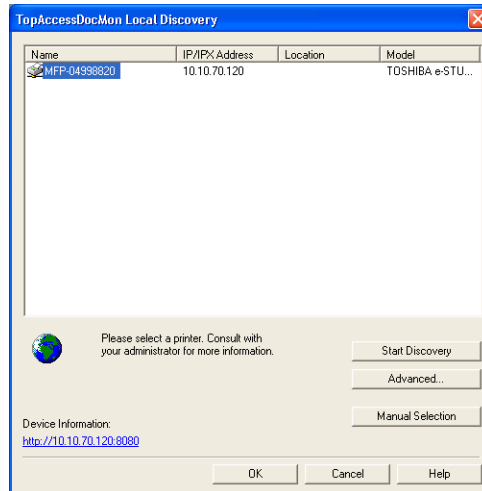

- You are connected to the selected device.

Discovering the device manually

1 In the TopAccessDocMon Local Discovery dialog box, click [Manual Selection].

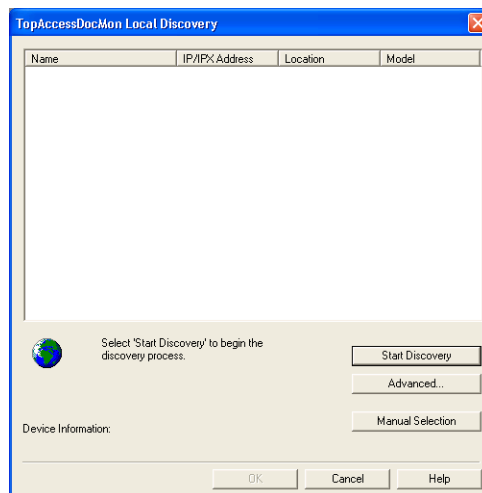

- The Manual Selection dialog box appears.

2 Enter each item to specify the network address of the device and click [OK].

IPV4 — Select this to search for devices set with an IPv4 address.

IPV6 — Select this to search for devices set with an IPv6 address.

IPX Address — This is disabled because the Remote Scan driver does not support the IPX/SPX connection.

Name — Enter the printer name.

Location — Enter the location of the printer.

Note

You must enter “Name” and “IP Address”.

3 The entered printer is added in the list. Select the printers that you want to monitor from the list and click [OK].

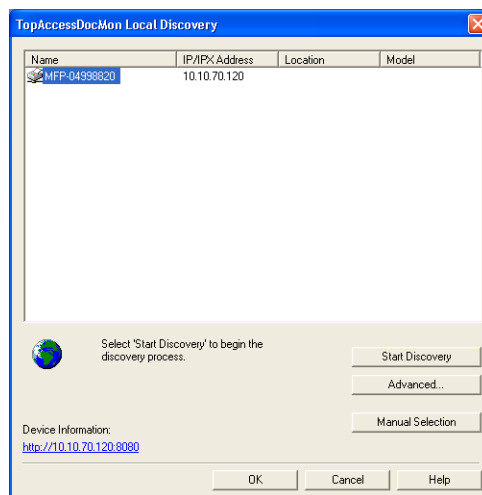

- You are connected to the selected device.

— Configuring Discovery Settings

You can configure the discovery settings.

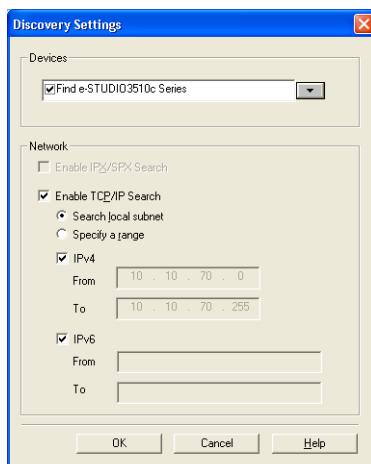

1) Devices

Click the arrow button to display the poll-down list and check the model name that you want to search.

2) Network - Enable IPX/SPX Search

This is disabled because the Remote Scan driver does not support the IPX/SPX connection.

3) Network - Enable TCP/IP Search

Select this to search for devices connected to the TCP/IP network. This is available only when the TCP/IP protocol is installed.

When this is enabled, select how it searches devices in the TCP/IP network.

- **Search local subnet** — Select this to search devices in local subnet.
- **Specify a range** — Select this to search devices in specific range of IP addresses. When this is selected, enter the IP addresses in “From” field and “To” field to specify the range.
- **IPV4** — Select this to search for devices set with an IPv4 address.
- **IPV6** — Select this to search for devices set with an IPv6 address.

How to Use Remote Scan Driver

In the Remote Scan driver, you can set the various scan settings.

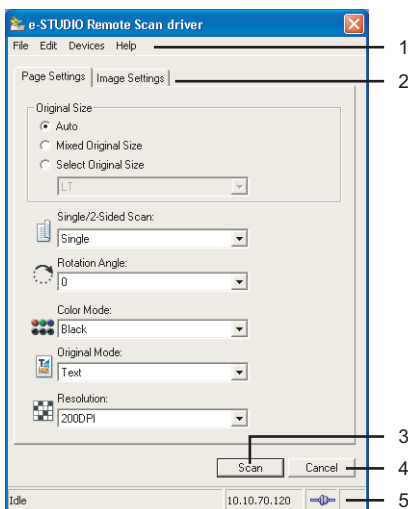

1) Menu Bar

You can select various functions from the menu.

File menu:

- **Page Settings** — Click this menu to display the Page Settings tab.
- **Image Settings** — Click this menu to display the Image Settings tab.
- **Scan** — Click this menu to start remote scanning and acquire the image.
- **Close** — Click this menu to close the Remote Scan driver.

Edit menu:

- **Reset Settings** — Click this to reset the all settings to the factory defaults.

Devices menu:

- **Discovery** — Click this menu to add a new connection to this equipment in your network for the Remote Scan driver.
📖 P.130 “Adding a New Device Using Network Discovery”
- **Select e-STUDIO** — Click this menu to change the target device when retrieving e-Filing documents.
📖 P.130 “Changing the Target Device”

Help

- **Help** — Click this menu to display Online Help.
- **About** — Click this menu to display the version information.

2) Page Settings/Image Settings tab

You can set the various scan settings in each tab.

📖 P.128 “Page Settings Tab”

📖 P.129 “Image Settings Tab”

3) [Scan]

Click this to start remote scanning and acquire the image

4) [Cancel]

Click this to exit the Remote Scan driver.

5) Status Bar

This displays the communication status and the IP address of the equipment to be connected.

Page Settings Tab

In the Page Settings tab, you can set the following options.

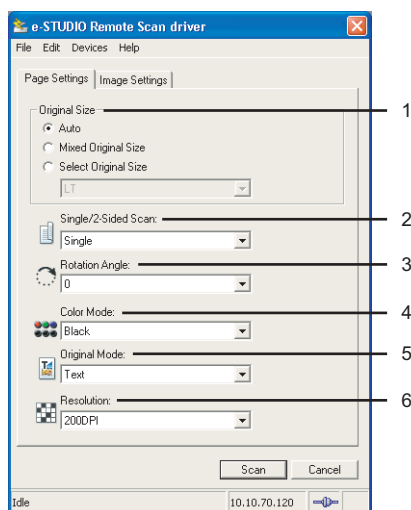
**1) Original Size**

Select the original size to be scanned.

- **Auto** — Select this to detect the original size automatically.
- **Mixed Original Size** — Select this to scan originals of the mixed sizes.
- **Select Original Size** — Select this to set the original size manually. When this is selected, select the original size in the drop down box.

2) Single/2-Sided Scan

Select whether scanning the 2-sided originals or not. This applies only when the originals are set in the Automatic Document Feeder.

- **Single** — Select this when scanning only the front page of originals.
- **2-sided/Book** — Select this when scanning both side of originals in the same direction.
- **2-sided/Tablet** — Select this when scanning front page in the general direction, and scanning back page rotated 180 degree.

3) Rotation Angle

Select the rotation angle when you want to rotate the scanned images.

4) Color Mode

Select the color mode for scanning.

5) Original Mode

Select the original mode for scanning.

- **Text** — Select this when scanning the originals that contain texts.
- **Photo** — Select this when scanning originals that contain photos printed on photographic paper.
- **Text/Photo** — Select this when scanning originals that contain texts and photos.

6) Resolution

Select the resolution for scanning.

Image Settings Tab

In the Image Settings tab, you can set the following options.

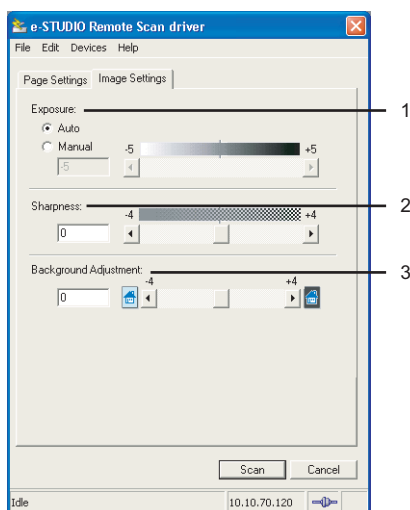

1) Exposure

This sets the exposure for scanning.

- **Auto** — Select this to use auto mode for the exposure mode for scanning.
- **Manual** — Select this to set the exposure manually. When this is selected, set from -5 (lowest) to 5 (highest) in units of 1 by moving the scroll bar.

2) Sharpness

This sets the sharpness for scanning. You can set from -4 (smoothest) to 4 (sharpest) in units of 1 by moving the scroll bar.

Note

This cannot be set when the Remote Scan driver is connected to the e-STUDIO451c Series, e-STUDIO452 Series, or e-STUDIO282 Series.

3) Background Adjustment

This sets the contrast of background color for scanning. You can set from -4 (lowest) to 4 (highest) in units of 1 by moving the scroll bar.

Notes

- You can set from -2 (lowest) to 2 (highest) in units of 1 by moving the scroll bar when the Remote Scan driver is connecting to the e-STUDIO451c Series.
- This cannot be set when the Remote Scan driver is connecting to the e-STUDIO452 Series or e-STUDIO282 Series.

Adding a New Device Using Network Discovery

You can add a new connection to other equipment by searching the equipment in your network. This enables you to add several devices that you can connect using the Remote Scan driver. To add a new connection, click the [Devices] menu and select [Discovery]. The TopAccessDocMon Local Discovery dialog box appears and discovers the devices in your network to add a new connection. For further instruction on how to discover the devices using the TopAccessDocMon Local Discovery dialog box, see the following section.

 P.124 “When You Are Running the First Time”

Tip

After you add other devices in the connection list, you can change the target equipment by selecting the [Select e-STUDIO] command under the [Devices] menu.

 P.130 “Changing the Target Device”

Changing the Target Device

If you have added more than one device to connect, you can change the target device for scanning originals using the Remote Scan driver.

Selecting the target device

1 Click the [Devices] menu and select [Select e-STUDIO].

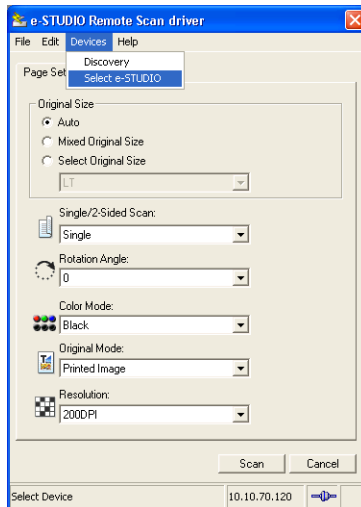

- The Select Device dialog box appears.

2 Select the name of the equipment that you want to connect to, and click [OK].

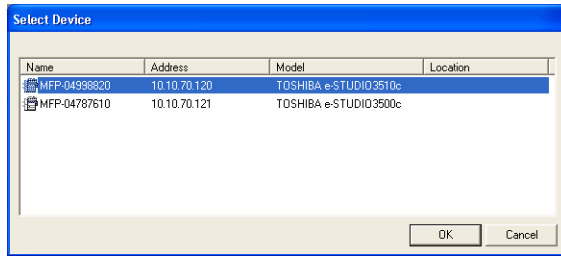

- The target device has been changed to the selected equipment.

Remote Scan Driver Errors

This section describes the most common Remote Scan driver errors and provides steps to resolve the conditions. If the problem persists after you have followed all of the steps, make sure to note the name of the application you were using, what you were trying to do, and any error messages — and then contact a authorized dealer for further assistance.

Tip

Please refer to the README file for Remote Scan driver about the problems that are not described here.

Remote Scan Driver Error Conditions

Refer to the corrective action for the following error conditions.

 P.132 “Cannot Find the Device”

 P.132 “Cannot Connect to the Device Found by Discovery”

 P.133 “Cannot Acquire Document”

Cannot Find the Device

Problem Description:

Cannot find this equipment using the Local Discovery or Network Discovery feature.

Corrective Action:

Confirm the following statements:

- The equipment and your computer is correctly connected to the TCP/IP network.
- The default gateway setting is correctly set up if the equipment is connected to a different subnet.

Cannot Connect to the Device Found by Discovery

Problem Description:

The Local Discovery finds the device, but you cannot connect to it.

Corrective Action:

1. In case of using IPv4, make sure that Microsoft Internet Explorer 5.5 SP2 or later has been installed. In case of using IPv6, make sure that Microsoft Internet Explorer 7.0 or later has been installed.
2. Make sure the Proxy settings on the Microsoft Internet Explorer have been set correctly so that it can connect to the device.
3. Make sure Microsoft Internet Explorer is not in the off-line mode. If it is in off-line mode, change it to the on-line mode.
4. Make sure that you connect to the equipment.

Note

It also fails to connect to the device when too many computers connect to the device at the same time. Please try again later.

Cannot Acquire Document

Problem Description:

Cannot acquire a document using the Remote Scan driver.

Corrective Action:

If the equipment is not ready for the Remote Scan operation, it cannot acquire document using the Remote Scan driver. Please check the status of the equipment. When the equipment shows the following status, the Remote Scan operation cannot be performed.

- When the paper jam occurs in the equipment.
- When the serviceman call occurs in the equipment.
- When copying, scanning, faxing, or user function setting is performed in the equipment.
- When any cover is open.
- When the document feeder cover is open and the original is set in the document feeder.

9

Web Service SCAN

This section describes how to utilize Web Service Scan.

Preparing “Web Service Scan”	136
Planning and preparation	136
Installing a Driver	136
How to Perform Web Service Scan Operations	137

Preparing “Web Service Scan”

Planning and preparation

The Web Service Scan operations are performed on client computers via a network connected using the features in Windows Vista. Images scanned in this equipment can be stored in your client PC. You can store images scanned with this equipment into a client computer, or you can retrieve images from applications supporting WIA (Windows Imaging Acquisition) Scan Driver of a client computer into this equipment. In this section a procedure for storing images scanned with this equipment into a client computer. For operations on a client computer, follow the procedure provided by your application that supports the WIA Scan Driver.

System Requirements

Web Service Scan is available under the following environments:

- **OS**
Windows Vista
- **Required Software**
WIA(Windows Imaging Acquisition) Scan Driver-compliant application

Installing a Driver

Use the WIA(Windows Imaging Acquisition) Scan driver included in Windows Vista. A driver for Web Services Scanning is automatically installed as well as the client software of Web Services Printing. For the installation procedure, see “Installing Client Software for Web Services Printing” in the Printing Guide.

How to Perform Web Service Scan Operations

Procedure for Scan

- 1 Place the original(s).
 - See the **Operator's Manual for Basic Functions** for how to place originals.
- 2 Press the [SCAN] button on the control panel to enter the scan menu.

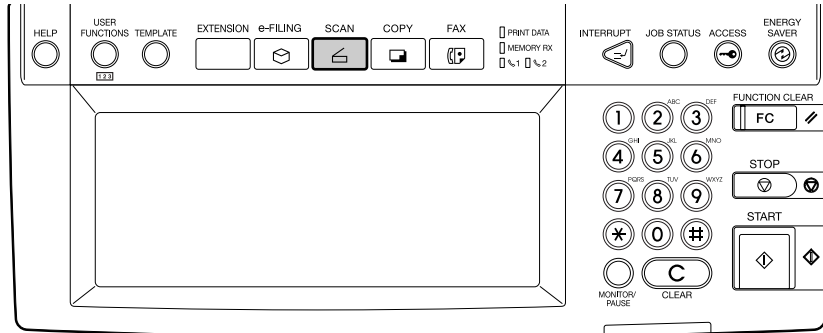

- The basic scan menu is displayed.

- 3 Press the [WS SCAN] button.

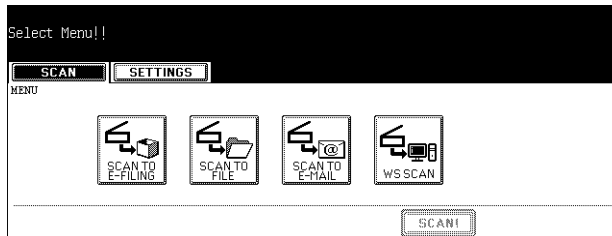

- The WS SCAN menu is displayed.

- 4 Select the name of the client computer in which you want to store image data.

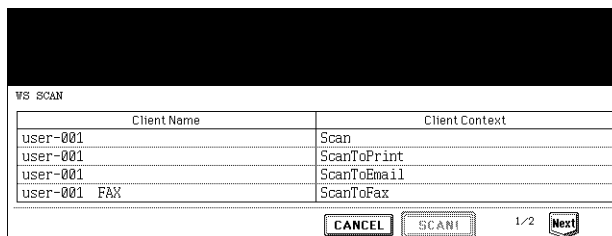

- If the desired client name is not shown in the list, press the [Next] or [Prev] button to switch the page on the screen.

5 Press the [SCAN!] button.

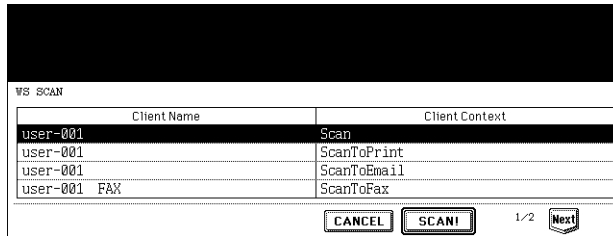

- The screen for external connection is displayed.

6 The basic scan menu is displayed after the data have been stored in the client computer.

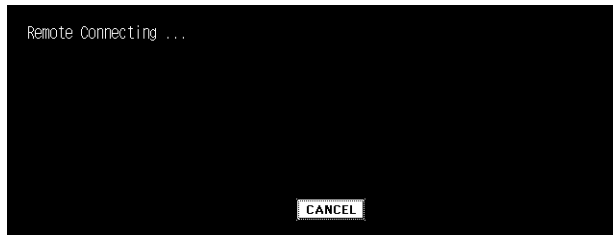

- If you want to cancel the storage of the data being scanned, press the [CANCEL] button.

Note

If the screen for external connection is not displayed after your pressing the [SCAN!] button, confirm if the selected client computer is running.

INDEX

Numerics

2-SIDED SCAN 112

A

About 128
Advanced 125
Advanced Function 112
AUTHENTICATION 51
Authority 43, 53
AUTOMATIC START 81, 85

B

BOX/FOLDER 29

C

Client Utilities CD-ROM 118
Close 127
Color Mode 128
COMMAND PORT 40, 90
COPY & FILE 89

D

Devices 127
Devices menu 127
DIFFERENT WIDTH 99
Discovery 127, 130
Dual Agents 20

E

Edit menu 127
E-MAIL ADDRESS 57, 101
E-MAIL CC 52
Enable IPX/SPX Search 127
Enable TCP/IP Search 127
Encrypt PDF 43, 53
Encryption Level 43, 53
EXPOSURE 33, 45, 55, 99
Exposure 129

F

FILE FORMAT 42, 52, 92
File menu 127
FRAGMENT MESSAGE SIZE 54
FROM ADDRESS 54
FROM NAME 54

G

GROUP 63, 64, 66, 108, 110
GROUP NAME 66, 110

H

Help 128
Help menu 128

I

Image Settings 127, 129
Internet Fax 95
Internet Fax Transmission Overview 96
IPV4 126
IPV6 126
IPX Address 126

K

KNOWN ID 58, 64, 103, 109

L

Location 126
LOGIN USER NAME 40, 41, 42, 90, 91, 92

M

Manual Selection 125
Menu Bar 127
MFP LOCAL 39, 89
MIXED ORIGINAL SIZE 32, 44, 55
MODE 99
MULTI/SINGLE 42, 52

N

Name 126
NAME 1 81, 84
NAME 2 81, 84
NETWORK PATH 40, 41, 42, 90, 91, 92

O

ORIGINAL 99
ORIGINAL MODE 32, 44, 55
Original Mode 129
ORIGINAL SIZE 32, 44, 55
Original Size 128

P

Page Settings 127, 128
PASSWORD .. 40, 41, 42, 81, 85, 90, 91, 92
PDF (MULTI) 92
PDF (SINGLE) 92
Precaution for Internet Transmission 96
PRIORITY RESERVE 113
Priority Transmission 113

R

Receiving from POP3 Server 115
REMOTE 1 39, 89
REMOTE 2 39, 89
Reset Settings 127
RESOLUTION 32, 44, 55, 99
Resolution 129
ROTATION 32, 44, 54
Rotation Angle 128

S

Scan 127

Scan Mode 16

SCAN TO E-FILING 19, 21, 29

Scan to e-Filing mode 16

SCAN TO E-MAIL 19, 21, 50, 74

Scan to E-mail mode 17

SCAN TO FILE 19, 21, 38

Scan to File mode 17

SEARCH ADDRESS 59, 61, 104, 106

SEARCH GROUP 66, 110

Search local subnet 127

SECURITY (Encrypt PDF) 42, 52

Select e-STUDIO 127, 130

Sending 2-sided Originals 112

SERVER NAME 40, 41, 90, 91

Sharpness 129

Single Agent 18

SINGLE/2-SIDED SCAN 32, 44, 54

Single/2-Sided Scan 128

Specify a range 127

Start Discovery 124

T

TIFF (MULTI) 92

TIFF (SINGLE) 92

TopAccessDocMon Local Discovery 123, 124, 130

TX TYPE 99

U

USER NAME 81, 84

X

..... 42, 52

DP-3540/4540
DP-2050/2340/2840
OME050115C0

MULTIFUNCTIONAL DIGITAL SYSTEMS

Scanning Guide

e-STUDIO352/452

e-STUDIO202L/232/282

TOSHIBA TEC CORPORATION

2-17-2, HIGASHIGOTANDA, SHINAGAWA-KU, TOKYO, 141-8664, JAPAN



Free Manuals Download Website

<http://myh66.com>

<http://usermanuals.us>

<http://www.somanuals.com>

<http://www.4manuals.cc>

<http://www.manual-lib.com>

<http://www.404manual.com>

<http://www.luxmanual.com>

<http://aubethermostatmanual.com>

Golf course search by state

<http://golfingnear.com>

Email search by domain

<http://emailbydomain.com>

Auto manuals search

<http://auto.somanuals.com>

TV manuals search

<http://tv.somanuals.com>