



EHV Hybrid H.264 DVR

Digital Recording and Transmission System

User Guide

Surveillix™ EHV
User Manual

Manual Edition 31041AA – MARCH 2012

Printed in USA

No part of this documentation may be reproduced in any means, electronic or mechanical, for any purpose, except as expressed in the Software License Agreement. Toshiba shall not be liable for technical or editorial errors or omissions contained herein. The information in this document is subject to change without notice.

The information in this publication is provided “as is” without warranty of any kind. The entire risk arising out of the use of this information remains with recipient. In no event shall Toshiba be liable for any direct, consequential, incidental, special, punitive, or other damages whatsoever (including without limitation, damages for loss of business profits, business interruption or loss of business information), even if Toshiba has been advised of the possibility of such damages and whether in an action or contract or tort, including negligence.

This software and documentation are copyrighted. All other rights, including ownership of the software, are reserved to DVR Support Center. TOSHIBA, and Surveillix are registered trademarks of TOSHIBA CORPORATION in the United States and elsewhere; Windows, and Windows 7 are registered trademarks of Microsoft Corporation. All other brand and product names are trademarks or registered trademarks of the respective owners.

The following words and symbols mark special messages throughout this guide:

WARNING: Text set off in this manner indicates that failure to follow directions could result in bodily harm or loss of life.

CAUTION: Text set off in this manner indicates that failure to follow directions could result in damage to equipment or loss of information.

LIMITED WARRANTY

DIGITAL VIDEO RECORDER

The Imaging Systems Division of Toshiba America Information Systems, Inc. ("ISD") makes the following limited warranties. These limited warranties extend to the Original End-User ("You[r]").

Limited Two (2) Year Warranty of Labor and Parts

The Imaging Systems Division of Toshiba America Information Systems warrants this product and parts against defects in material or workmanship for a period of two years from the date of original retail purchase by the end-user. During this period, ISD will repair or replace a defective product or part with a new or refurbished item. The user must deliver the entire product to the Surveillix DVR Repair Facility. The user is responsible for all transportation and insurance charges for the product to the DVR Repair Facility. ISD reserves the right to substitute Factory Refurbished Parts and / or Factory Refurbished Product in place of those in need of repair.

Step-by-step Procedures – How to Obtain Warranty Service

[1] Verify operation of the unit by checking the instruction manual and web site for the latest updates at

www.toshibasecurity.com

[2] If there is a defect in material or workmanship, contact the Surveillix DVR Support Center at (877) 855-1349 [877-855-1-FIX] to speak to a technical support representative and schedule service.

[3] Arrange for delivery of the product to the Surveillix DVR Repair Facility. Products must be insured and securely packed, preferably in the original shipping carton. A letter explaining the defect and a copy of the bill of sale or other proof of purchase must be enclosed with a complete return street address and daytime telephone number. The Tracking Number should also be indicated on your documents. Charges for transportation and insurance must be prepaid by the end-user.

Critical Use Disclaimer

The product is not designed for any "critical applications." "Critical applications" means life support systems, exhaust or smoke extraction applications, medical applications, commercial aviation, mass transit applications, military applications, homeland security applications, nuclear facilities or systems or any other applications where product failure could lead to injury to persons or loss of life or catastrophic property damage. Accordingly, Toshiba disclaims any and all liability arising out of the use of the product in any critical applications.

Your Responsibilities

The above warranty is subject to the following conditions:

[1] You must retain the bill of sale or provide other proof of purchase.

[2] You must schedule service within thirty days after you discover a defective product or part.

[3] All warranty servicing of this product must be made by the Surveillix DVR Repair Facility.

[4] The warranty extends to defects in material or workmanship as limited above, and not to any products or parts that have been lost or discarded by user. The warranty does not cover damage caused by misuse, accident, improper installation, improper maintenance, or use in violation of instructions furnished by ISD. The warranty does not extend to units which have been altered or modified without authorization of ISD, or to damage to products or parts thereof which have had the serial number removed, altered defaced or rendered illegible.

ALL WARRANTIES IMPLIED BY STATE LAW, INCLUDING THE IMPLIED WARRANTIES OF MERCHANTABILITY AND FITNESS FOR A PARTICULAR PURPOSE, ARE EXPRESSLY LIMITED TO THE DURATION OF THE LIMITED WARRANTIES SET FORTH ABOVE. Some states do not allow limitations on how long an implied warranty lasts, so the above limitation may not apply. WITH THE EXCEPTION OF ANY WARRANTIES IMPLIED BY STATE LAW AS HEREBY LIMITED, THE FOREGOING EXPRESS WARRANTY IS EXCLUSIVE AND IN LIEU OF ALL OTHER WITH RESPECT TO THE REPAIR OR REPLACEMENT OF ANY PRODUCTS OR PARTS. IN NO EVENT SHALL ISD BE LIABLE FOR CONSEQUENTIAL OR INCIDENTAL DAMAGES. Some states do not allow the exclusion or limitation of incidental or consequential damages so the above limitation may not apply.

No person, agent, distributor, dealer, service station or company is authorized to change, modify or extend the terms of these warranties in any manner whatsoever. The time within which an action must be commenced to enforce any obligation of ISD arising under this warranty or under any statute, or law of the United States or any state thereof, is hereby limited to one year from the date you discover or should have discovered, the defect. This limitation does not apply to implied warranties arising under state law. Some states do not permit limitation of the time within which you may bring an action beyond the limits provided by state law so the above provision may not apply to user. This warranty gives the user specific legal rights, and user may also have other rights, which may vary from state to state.

TOSHIBA AMERICA INFORMATION SYSTEMS, INC.
Imaging Systems Division

Copyright © 2007 Toshiba America Information Systems, Inc. All rights reserved.

TOSHIBA

IMPORTANT SAFEGUARDS

1. **Read Owner's Manual** – After unpacking this product, read the owner's manual carefully, and follow all the operating and other instruction
2. **Power Sources** – This product should be operated only from the type of power source indicated on the label. If you are not sure of the type of power supply to your home or business, consult your product dealer or local power company
3. **Ventilation** – Slots and openings in the cabinet are provided for ventilation and to ensure reliable operation of the product and to protect it from overheating, and these openings must not be blocked or covered. The product should not be placed in a built-in installation such as a bookcase or rack unless proper ventilation is provided or the manufacturer's instructions have been adhered to.
4. **Heat** – The product should be situated away from heat sources such as radiators, heat registers, stoves, or other products that produce heat.
5. **Water and Moisture** – Do not use this product near water.
6. **Cleaning** – Unplug this product from the wall outlet before cleaning.
7. **Power Cord Protection** – Power-supply cords should not be routed so that they are not likely to be walked on or pinched by items placed against them, paying particular attention to cords at plugs, convenience receptacles, and the point where they exit from the product.
8. **Overloading** – Do not overload wall outlets; extension cords, or integral convenience receptacles as this can result in a risk of fire or electrical shock.
9. **Lightning** – For added protection for this product during storm, or when it is left unattended and unused for long periods of time, unplug it from the wall outlet. This will prevent damage to the product due to lightning and power line surges.
10. **Object and Liquid Entry Points** – Never insert foreign objects into the recorder, other than the media types approved by Toshiba as they may touch dangerous voltage points or short-out parts that could result in a fire or electrical shock. Never spill liquid of any kind on the product.
11. **Accessories** – Do not place this product on an unstable cart, stand, tripod, bracket, or table. The product may fall, causing serious personal injury and serious damage to the product.
12. **Disc Tray** – Keep fingers clear of the disc tray as it is closing. Neglecting to do so may cause serious personal injury.
13. **Burden** – Do not place a heavy object on or step on the product. The object may fall, causing serious personal injury and serious damage to the product.
14. **Disc** – Do not use a cracked, deformed, or repaired disc. These discs are easily broken and may cause serious personal injury and product malfunction.
15. **LAN Port** - This equipment is for indoor use and all the communication wirings are limited to inside of the building.
16. **Damage Requiring Service** – Unplug the unit from the outlet and refer servicing to qualified service personnel under the following conditions:
 - a) When the power-supply cord or plug is damaged.
 - b) If liquid has been spilled, or objects have fallen into the unit.
 - c) If the unit has been exposed to rain or water.
 - d) If the unit does not operate normally by following the operating instructions. Adjust only those controls that are covered by the operating instructions as an improper adjustment of other controls may result in damage and will often require extensive work by a qualified technician to restore the unit to its normal operation.
 - e) If the unit has been dropped or the enclosure has been damaged.
 - f) When the unit exhibits a distinct change in performance - this indicates a need for service.

17. **Servicing** – Do not attempt to service this product yourself as opening or removing covers may expose you to dangerous voltage or other hazards. Refer all servicing to qualified personnel.
18. **Replacement Parts** – When replacement parts are required, be sure the service technician has used replacement parts specified by the manufacturer or have the same characteristics as the original part. Unauthorized substitutions may result in fire, electric shock or other hazards.
19. **Safety Check** – Upon completion of any service or repairs to this unit, ask the service technician to perform safety checks to determine that the unit is in proper operating condition.

BATTERY EXPLOSION CAUTION STATEMENT

CAUTION: Risk of Explosion if Battery is replaced by an Incorrect Type.
Dispose of Used Batteries According to the Instructions.

NOTES ON HANDLING

Please retain the original shipping carton and/or packing materials supplied with this product. To ensure the integrity of this product when shipping or moving, repackage the unit as it was originally received from the manufacturer.

Do not use volatile liquids, such as aerosol spray, near this product. Do not leave rubber or plastic objects in contact with this product for extended periods of time. Rubber or plastic objects left in contact with this product for extended periods of time will leave marks on the finish.

The top and rear panels of the unit may become warm after long periods of use. This is not a malfunction.

NOTES ON LOCATING

Place this unit on a level surface. Do not use it on a shaky or unstable surface such as a wobbling table or inclined stand.

If this unit is placed next to a TV, radio, or VCR, the playback picture may become poor and the sound may be distorted. If this happens, place the recorder away from the TV, radio, or VCR.

AVOID VOLATILE LIQUID

Do not use volatile liquids, such as an insect spray, near the unit. Do not leave rubber or plastic products touching the unit for a long time. They will leave marks on the finish. Do not use a chemically saturated cloth.

NOTES ON MAINTENANCE

To keep the recorder always operational we recommend regular inspection maintenance (cleaning parts or replacement). For details, contact the nearest dealer.

NOTES ON MOISTURE CONDENSATION

Moisture condensation damages the recorder. Read the following information carefully.

Moisture condensation occurs during the following cases:

- When this product is brought directly from a cool location to a warm location.
- When this product is moved to a hot and humid location from a cool location.
- When this product is moved to a cool and humid location from a warm location.
- When this product is used in a room where the temperature fluctuates.
- When this product is used near an air-conditioning unit vent
- When this product is used in a humid location.

Do not use the recorder when moisture condensation may occur.

If the recorder is used in such a situation, it may damage discs and internal parts. Remove any CD discs, connect the power cord of the recorder to the wall outlet, turn on the recorder, and leave it for two to three hours. After two to three hours, the recorder will warm up and evaporate any moisture. Keep the recorder connected to the wall and moisture will seldom occur.

CAUTION

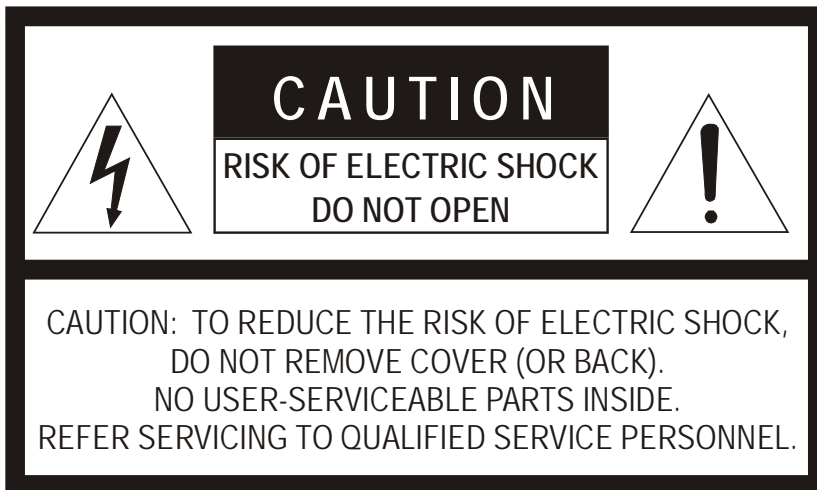

RACK MOUNT INSTRUCTIONS

Elevated Operating Ambient – If installed in a closed or multi-unit rack assembly, the operating ambient temperature of the rack environment may be greater than room ambient. Therefore, consideration should be given to installing the equipment in an environment compatible with the maximum ambient temperature (T_{ma}) specified by the manufacturer.

Reduced Air Flow – Installation of the equipment in a rack should be such that the amount of airflow required for safe operation of the equipment is not compromised.

Mechanical Loading – Mounting of the equipment in the rack should be such that a hazardous condition is not achieved due to uneven mechanical loading.

Circuit Overloading – Consideration should be given to the connection of the equipment to the supply circuit and the effect that overloading of the circuits might have on over current protection and supply wiring. Appropriate consideration of equipment nameplate ratings should be used when addressing this concern.

Grounding – Grounding of rack-mounted equipment should be maintained. Particular attention should be given to supply connections other than direct connections to the branch circuit (e.g. use of power strips).

FCC STATEMENT

INFORMATION TO THE USER: This equipment has been tested and found to comply with the limits for a Class B digital device, pursuant to Part 15 of the FCC Rules. These limits are designed to provide reasonable protection against harmful interference in a residential installation. This equipment generates, uses and can radiate radio frequency energy and, if not installed and used in accordance with the instructions, may cause harmful interference to radio communications. However, there is no guarantee that interference will not occur in a particular installation. If this equipment does cause harmful interference to radio or television reception, which can be determined by turning the equipment off and on, the user is encouraged to try to correct the interference by one or more of the following measures:

- Reorient or relocate the receiving antenna.
- Increase the separation between the equipment and receiver.
- Connect the equipment into an outlet on a circuit different from that to which the receiver is connected.
- Consult the dealer or an experienced radio/TV technician for help.

USERS OF THE PRODUCT ARE RESPONSIBLE FOR CHECKING AND COMPLYING WITH ALL FEDERAL, STATE, AND LOCAL LAWS AND STATUTES CONCERNING THE MONITORING AND RECORDING OF VIDEO AND AUDIO SIGNALS. TOSHIBA SHALL NOT BE HELD RESPONSIBLE FOR THE USE OF THIS PRODUCT IN VIOLATION OF CURRENT LAWS AND STATUTES.

UL NOTICE

Underwriters Laboratories Inc. has not tested the performance or reliability of the security or signaling aspects of this product. UL has only tested for fire, shock and casualty hazards as outlined in UL's Standard for Safety UL 60950-1. UL Certification does not cover the performance or reliability of the security or signaling aspects of this product. UL MAKES NO REPRESENTATIONS, WARRANTIES OR CERTIFICATIONS WHATSOEVER REGARDING THE PERFORMANCE OR RELIABILITY OF ANY SECURITY OR SIGNALING RELATED FUNCTIONS OF THIS PRODUCT.

Disclaimer

We disclaim any responsibility and shall be held harmless for any damages or losses incurred by the user in any of the following cases:

1. Fire, earthquake or any other act of God; acts by third parties; misuse by the user, whether intentional or accidental; use under extreme operating conditions.
 2. Malfunction or non-function resulting in indirect, additional or consequential damages, including but not limited to loss of expected income and suspension of business activities.
 3. Incorrect use not in compliance with instructions in this user's manual.
 4. Malfunctions resulting from misconnection to other equipment.
 5. Repairs or modifications made by the user or caused to be made by the user and carried out by an unauthorized third party.
 6. Notwithstanding the foregoing, Toshiba's liabilities shall not, in any circumstances, exceed the purchase price of the product.
-

Usage Limitation

The product is not designed for any "critical applications." "Critical applications" means life support systems, exhaust or smoke extraction applications, medical applications, commercial aviation, mass transit applications, military applications, homeland security applications, nuclear facilities or systems or any other applications where product failure could lead to injury to persons or loss of life or catastrophic property damage.

Accordingly, Toshiba/TAIS disclaims any and all liability arising out of the use of the product in any critical applications.

CONTENTS

1	Contents	9
2	Introduction	13
	Product Description	13
	Features	13
	USB Flash Drive Approved List.....	14
	PTZ Compatibility List	14
	Quick Start Instructions	15
	Logging In for the First Time	15
3	Installation	16
	Front Panel Controls	16
	Rear Panel Connectors.....	16
	16 Channel	16
	8 Channel	17
	4 Channel	17
	Remote Control	18
	Connection Guide.....	19
	Connecting the Monitor	19
	Connecting to a Network.....	19
	Connecting Audio	19
	Connecting a PTZ Camera.....	19
	Connecting to a Sensor Input	19
	Connecting to a Relay Output	20
	Installing the Rackmount Kit.....	20
	Turning on the DVR.....	20
	Using the Power Button.....	20
	Setting the Remote Controller ID	21
4	Setup	22
	Setup Menus	22
	Quick Setup.....	23
	System.....	24
	System Configuration	24
	Upgrade Firmware.....	25
	Disk Configuration	26
	Format	26
	Overwrite	27
	Check.....	28
	SMART Check.....	29
	User Configuration.....	30
	Adding / Changing a User.....	30
	Configuration	31
	Shutdown.....	31
	Camera.....	32

Camera Configuration	32
Adding a Privacy Zone.....	32
Color Setup (Adjust)	33
PTZ Configuration	33
Spot / Sequence Configuration	34
Monitor Configuration	35
Record	36
Recording Configuration.....	36
Frame	36
IP Camera.....	37
Schedule.....	39
Holiday Setup	40
Audio.....	41
Instant Recording.....	42
Using Instant Recording.....	42
Motion/Event Configuration	43
Input	43
Setting Up Motion Detection Recording	44
Sensor	45
Action	46
Alarm Monitor	47
Network	48
Network Configuration	48
Serial Configuration	49
E-mail Configuration	51
Information	52
System Log View.....	52
Version View.....	52
Status View.....	53
5 Operation.....	57
Login.....	57
Default Administrator Log In	57
Live Display Mode	57
Channel Selection	57
Icons	58
Mouse-Over Menu	59
Popup Menu	60
No Signal	60
No Permission	60
PTZ.....	61
PTZ Popup Menu.....	61
Create PTZ Preset Position	62
Search	62
Searching Recorded Data	62
Quick Search	63
Graphic Search.....	63
Quick Backup in Search Mode	63

Express Search	64
Jump to First Saved Data	64
Jump to Last Saved Data	64
Event Search	64
Daylight Savings Search	64
Search Popup Menu	64
Backup (Export)	65
Manual Export	65
Search Backup Data	66
Deinterlacing	66
Using the Backup Viewer	67
Controlling Backup Viewer	67
Setup and Save Functions	68
Screen Division Buttons	68
Upgrade Firmware at the DVR	68
Play Back Backup Image	69
Save Settings	69
Save Settings	69
Import Settings	69
6 Remote Software	70
Set up a Remote Connection	70
Minimum System Requirements	70
Recommended System Requirements	70
Configuring the DVR	71
Creating a DVR Connection with Remote Software	71
Default Remote Software Log in Information	71
Access Remote Connection	72
Connecting Multiple DVRs	72
Using the Remote Software	73
Setting the Time and Date	73
Live View Screen	73
Camera View	74
Screen Division Buttons	75
Setup Overview	75
Search Overview	76
Play Controls	76
Performing a Basic Search	77
Adjust the Brightness of an Image	77
Zooming in on an Image	77
Zooming in on a Portion of an Image	77
Printing an Image	77
Save Clip	78
Saving a Video Clip	78
Graphic Search	79
Performing a Graphic Search	79
PTZ Overview	80
Accessing PTZ Menus	80

Controlling a PTZ Camera	80
Using the Graphical PTZ Controller	80
Using the On-screen Compass	81
Web Viewer Overview	82
Connecting to a DVR Using Web Viewer	83
Search Video Using Web Viewer	83
Performing a Basic Search	83
Status Search	84
Performing a Status Search.....	84
Clean Image	84
Print.....	85
Save.....	85
Alarm Monitor	86
Assign Status Settings.....	86
Connecting to a DVR using Alarm Monitor	87
Set up Alarm Monitor Options	87
Add Items to Alarm Confirm List.....	88
Filter Alarm Events	88
Search Alarm Window	89
View Recorded Video	89
Export Video	90
Digital Verifier Overview	91
Using the Digital Verifier	91
SCS Multi-Site Management Software.....	91
Connecting to a DVR using SCS.....	91
7 Appendix	92
Button Index	92
Enter / Exit Buttons.....	92
Function Buttons.....	92
Directional and Playback Control Buttons	93
DVR FAQ.....	93
General.....	93
Live Monitoring	93
Recording	93
Searching and Playing Video	94
Backup.....	94
Network	94
Miscellaneous.....	94
Troubleshooting.....	94

INTRODUCTION

PRODUCT DESCRIPTION



Surveillix's EHV Hybrid H.264 DVR is a powerful, yet affordable, video management solution designed for easy installation and operation. Preconfigured for continuous recording, with no additional setup required, the DVR offers quick search, setup, and backup features.

The Surveillix Embedded DVR comes ready for fast and seamless integration within your existing IT infrastructure. The EHV offers unparalleled stability, security, and ease of use in a 2U chassis. Accordingly, your security investment has never been easier to maintain. Multiple users may connect through digital networks such as LANs and WANs for simultaneous live viewing, and digital search. This powerful software enables users to view live video, perform searches, and operate PTZ cameras. It also provides system users and administrators with additional capabilities such as establishing recording schedules, and creating motion detection zones. With the latest advancements in the EHV software, searching and indexing your video archive has never been easier.

FEATURES

The EHV H264 includes the following features:

- 4/8/16 Composite Video Input Connectors
- Compatible with Color (NTSC or PAL) and B&W Video Sources
- Multiple Search Methods (Calendar, Event)
- Records up to 480 NTSC Images Per Second / 400 PAL Images per Second
- Live Real Time Video Display (480 NTSC Images Per Second / 400 PAL Images Per Second)
- Continuous Recording with Disk Overwrite Mode
- Continuous Recording on Archiving, Transmitting to Remote, and Playback
- Motion Based Recording Uniquely Configurable for Each Channel
- Customizable Motion Detection Grids Uniquely Configurable for Each Channel
- Multiple Recording Modes (Manual / Schedule / Event)
- Audio (Mono) Recording and Playback
- 4/8/16 Built in Sensor Inputs (Normally Open or Normally Closed)
- 4 Built in Relay Outputs (Normally Open or Normally Closed)
- Remote Access via Ethernet and/or Modem
- PTZ Camera Control

USB FLASH DRIVE APPROVED LIST

These USB flash drives have been tested and approved to work with the EHV DVR. Other USB flash drives may also work with the EHV DVR but have not yet been tested.

Manufacturer	Model
SanDisk	Cruzer
Talent	Flash
Corsair	Voyager
Lexar	JumpDrive
Kingston	Traveler

Note The USB ports on the EHV H.264 only provide enough power for a flash based external device. To use an external hard disk drive (HDD), then you must use external power or a USB Y cable to provide sufficient power. Most external HDDs come with an external power supply or a USB Y cable.

PTZ COMPATIBILITY LIST

The Surveillix DVRs support a wide selection of PTZ camera protocols:

American Dynamics	SCC-641
Cynix Speed Dome	SCC-645A
DynaColor	SDM-100
ERNITech	SJ-3728R1
FastraxII	SK-P
Ganz-PT	SK-S
HISHARP	SPD-1600
HSDN 251/230	SRX-1008
KALATEL	TBT-DOME
LG (LVC-A70X)	Vison-360
LILIN	Visiontech
ORX-1000	WSD7425D
Pelco-D	WV-CS854
Pelco-P	YOKO-CCTV
PTC-400C	
RS-485 DIRECT	

QUICK START INSTRUCTIONS

1. Turn on the DVR. See the Turning on the DVR section for more details.
2. Log in -- Use the number buttons to enter the password when prompted – The default password is <none> – Press Enter.
3. Complete System Configuration to set up the date, time and system ID. See the System Configuration section for more details.
4. Complete Disk Configuration to set overwrite options and enable SMART Check. See the Disk Configuration section for more details.
5. Complete User Configuration to change the Admin password and add additional users. See the System >User Configuration section for more details.
6. Complete Camera Configuration for all attached cameras. See the Camera Configuration section for more detail.
7. Complete PTZ Configuration for any attached Pan / Tilt / Zoom cameras. See the PTZ Configuration section for more details.
8. Create a recording schedule. See the Record section for more details.
9. Complete Sensor Configuration to enable any external devices connected to sensor inputs or relay outputs. See the Record > Motion/Event Configuration section for more details.
10. Complete Motion/Event Configuration to trigger recording on an event: motion, sensor, video loss. See the Motion/Event Configuration section for more details.
11. The DVR is now configured to record, search and playback video. See the Operation section in this manual for more information on using the DVR.

LOGGING IN FOR THE FIRST TIME

The default administrative log in information:

ID: admin

Password: <none>

INSTALLATION

FRONT PANEL CONTROLS

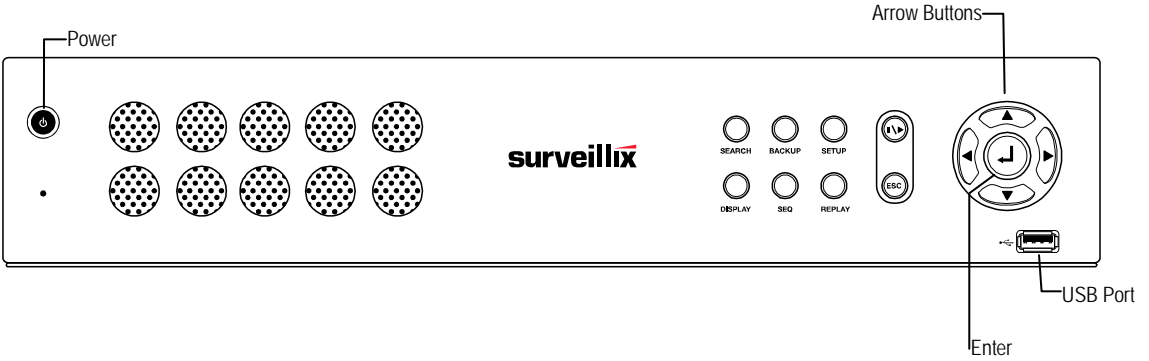

REAR PANEL CONNECTORS

The rear panel of the DVR contains virtually all of the connectors you will be using. The diagram below shows the location and description of each connector.

16 Channel

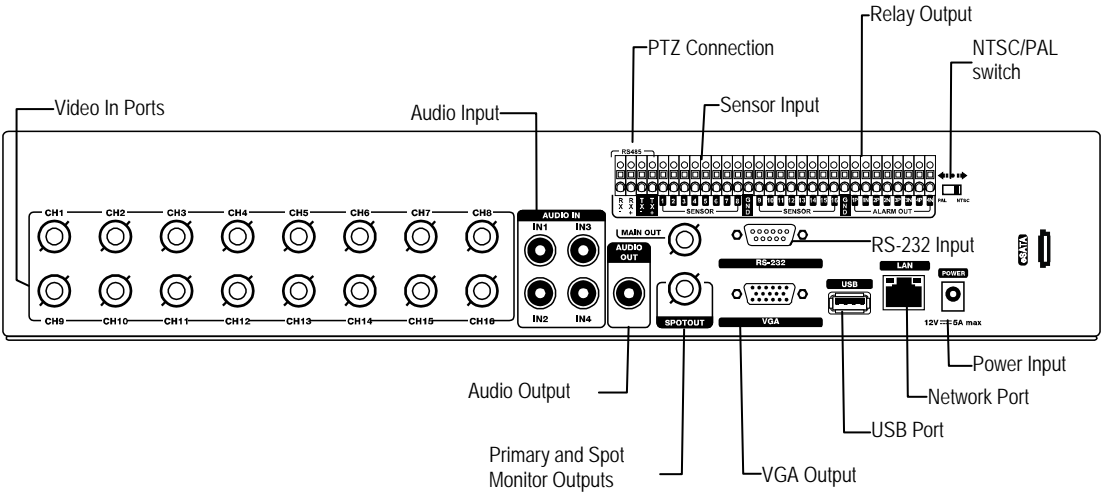

8 Channel

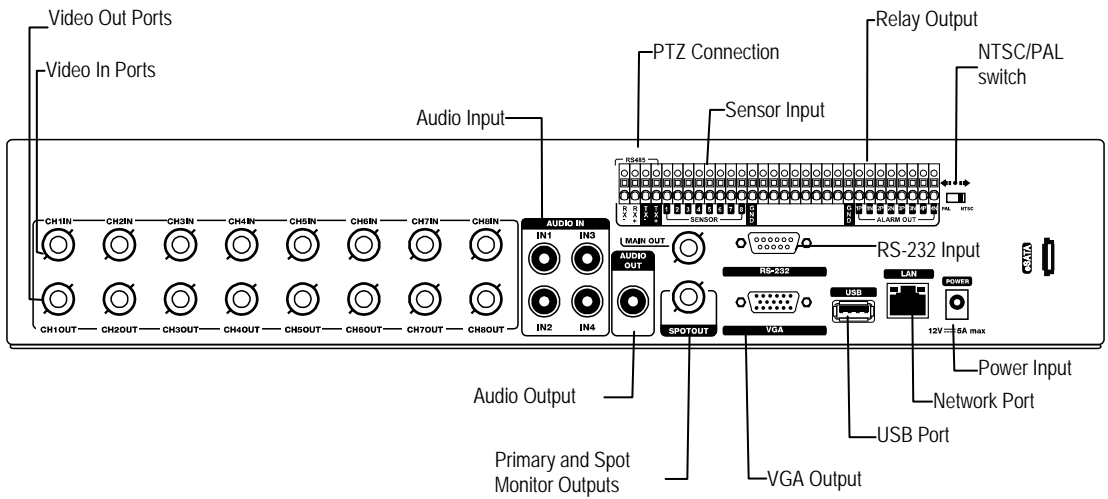

4 Channel

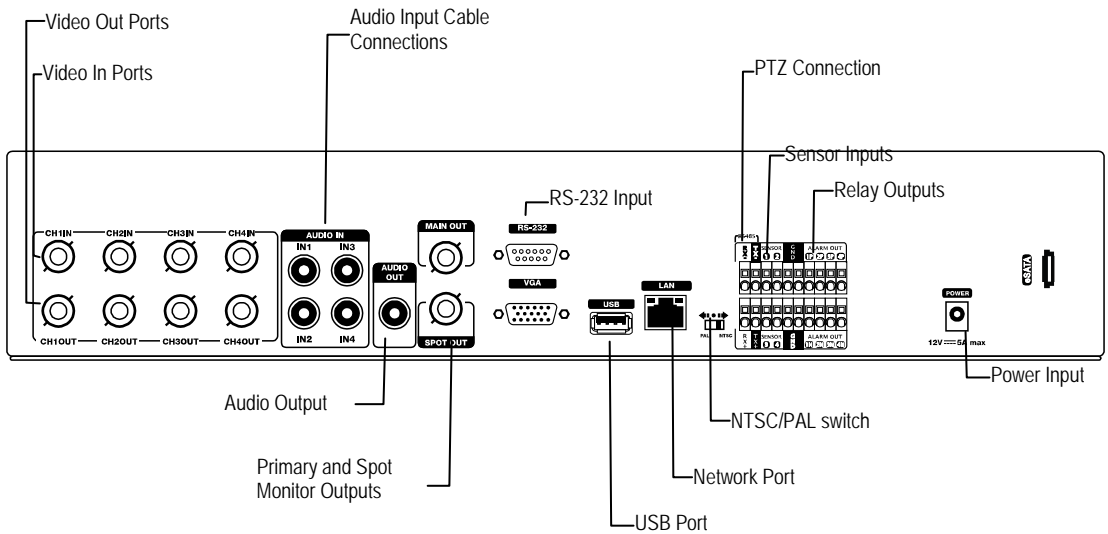

REMOTE CONTROL

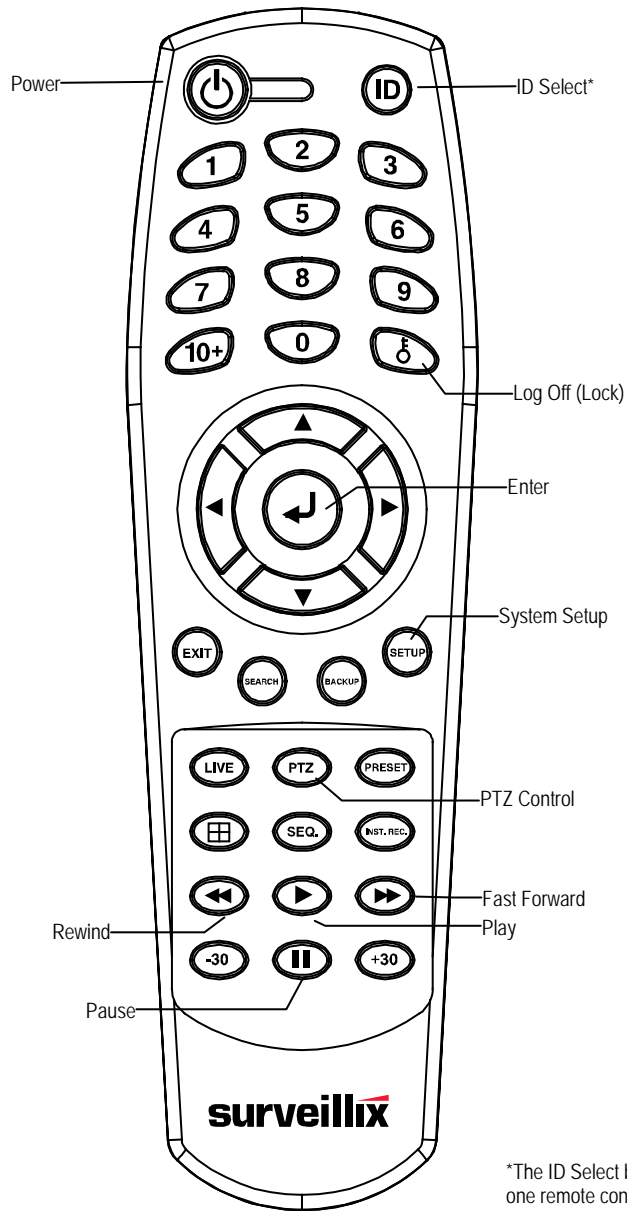

*The ID Select button allows you to use one remote control for several DVRs.

CONNECTION GUIDE

Connecting the Monitor

There are three available monitor outputs on the DVR.

- Composite Monitor output for CCTV monitor – BNC (Marked MAINOUT)
- Spot monitor output for CCTV monitor - BNC (Marked SPOTOUT)
- VGA output for VGA monitor – Mini-Sub D15

Connecting to a Network

Use the RJ45 jack (LAN) on the rear of the DVR when connecting to a network.



Connecting Audio

- To record audio on the DVR connect the audio source to the connections on the audio ports on the back of the DVR.
- To listen to live or recorded audio connect the Audio Out Port to an amplified speaker system.

Note The DVR audio output is a line level source which requires an amplified speaker system. The audio input can be from an amplified source or line level microphone.

Connecting a PTZ Camera

The RS485 connector can be used to control Pan / Tilt / Zoom (PTZ) cameras. See the PTZ camera manufacturer's manual for configuring the RS485 connection.

Note Use the RS485 connector for external control systems such as a control keyboard. Connect RX-/TX- and RX+/TX+ of the control system to the TX-/RX- and TX+/RX+ (respectively) of the DVR.

Connecting to a Sensor Input

To make connections on the Alarm Connector Strip: Press and hold the button and insert the wire into the hole below the button. To disconnect the wire, press and hold the button above the wire and pull it out.

Alarm In

Use external devices to send a signal to the DVR when an event occurs. Mechanical or electrical switches can be wired to the Alarm In and Ground (GND) connectors.

Note All connectors marked GND are common. Connect the ground side of the alarm input and/or alarm output to the GND connector.

Connecting to a Relay Output

To make connections on the Alarm Connector Strip: Press and hold the button and insert the wire into the hole below the button. To disconnect the wire, press and hold the button above the wire and pull it out.

Alarm Out

The DVR can activate external devices such as buzzers or lights. Connect the external device to the Alarm Out and Ground (GND) connectors. See Sensor Configuration in the manual for more details.

INSTALLING THE RACKMOUNT KIT

Caution There must be a minimum 1U space between the DVR and any other items in the rack.

1. Attach the rackmount brackets with the screws provided on each side of the DVR. Do not remove the plastic edge guards.
2. Mount the DVR in your rack.

TURNING ON THE DVR

1. Connect camera cables.
2. Connect a network cable and a monitor cable.
3. Connect the power cable to the DVR and wait until the main screen is displayed on the connected monitor; this process will take approximately two minutes.

Tip See the Connection Guide section for more details

Using the Power Button

To start the DVR:

- Press and hold the Power button on the front panel of the DVR until the lights start to flash.



To shutdown the DVR:

- Press and hold the Power button on the front panel of the DVR, log in when prompted and select OK to shut down.

Note Only authorized users can shut down the DVR.

SETTING THE REMOTE CONTROLLER ID

When more than one EHV DVR is installed in the same location, you can use one remote controller to control multiple DVRs – up to 20 DVRs. To control multiple DVRs, you must change the remote controller ID to the DVR ID of the DVR.

To change the remote controller ID:

1. On the DVR, go to **SYSTEM > SYSTEM CONFIGURATION**.
2. Enter the desired **DVR ID** number.
3. On the remote controller, press and hold the ID button and enter the desired **DVR ID** number to operate the corresponding DVR.

Note The DVR ID must be input as two numbers on the remote controller. You must input 00 for the system ID 0 and input 01 for 1.

SETUP

SETUP MENUS



Use the setup menus to configure all of the DVR settings, schedule recording, networking and shutdown.

- Press the SETUP key on the front of the DVR or remote control to enter the setup menus and log in.
- See the Logging In for the First Time section if entering setup for the first time.
- Use the ▲ and ▼ keys on the front of the DVR or remote control to navigate individual menus, and use the ◀ and ▶ keys to select a new setup menu.

QUICK SETUP

The Quick Setup screen allows you to define global recording settings for an easy and custom recording schedule on the DVR.



Global Resolution – 352 x240 / 704 × 240 / 704 × 480.

Record Mode – Continuous / Motion

Average Days to Record – [The estimated days of recording determined by resolution, FPS (Frames Per Second), Picture Quality, and available storage size.]

Average FPS – 1-30 [Maximum varies with resolution.]

Average Picture Quality – Low / Normal / High / Highest

SYSTEM

System Configuration



To enter System Configuration, press the Setup key on the front of the DVR and press Enter to select System Configuration. Use the arrow buttons on the front panel of the DVR or the remote control to navigate the display. Select Save and press Enter to update settings.

Video Format – NTSC / PAL.

Language – ENGLISH / SPANISH / FRENCH / PORTUGUESE / GERMAN / DUTCH [User Selectable].

DVR ID - Required for the operation of multiple units using the supplied IR remote control. Each system must have a unique ID to function properly.

Date Format – US (MM-DD-YYYY) / EURO (DD-MM-YYYY) / ASIA (YYYY-MM-DD) – [User Selectable].

Date – Press Enter to select the Date and use the number keys and/or arrow buttons to set the date. Press Enter again to deselect.

Time – Press Enter to select the Time and use the number keys and/or arrow buttons to set the time. Press Enter again to deselect.

Time Zone – Press Enter to open the Time Zone window. Use the arrow keys to navigate the list and press Enter to make selection. Select Exit and press Enter to close the window.

Note The date and time must be set manually; changing the time zone will not automatically change the Time/Date display.

System Configuration Continued

Use DST – After completing the Time Zone setup, highlight USE DST and press Enter to turn Daylight Saving Time ON / OFF.

NTP Type – Highlight NTP (Network Time Protocol) and press Enter to SYNC the DVR with the Network Time.

Keypad Beep – ON / OFF [Enables / Disables Audible keypad touch confirmation].

Auto Log Off – OFF or 1-10 Minutes [This feature will close the Configuration Menu after XX minutes of inactivity. This is a security feature.]

S/W Upgrade – Start firmware upgrade from selected media (USB)

Upgrade Firmware

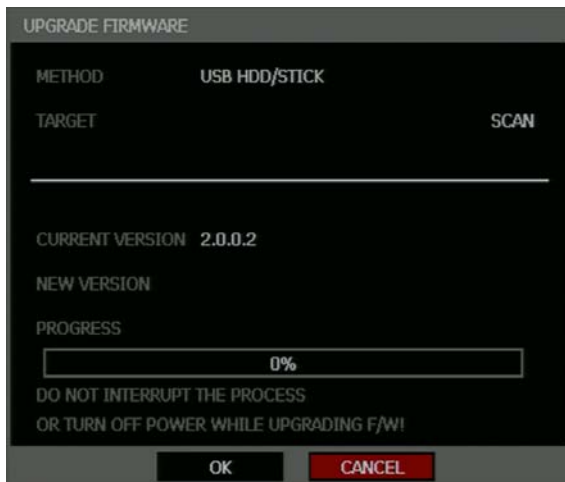

1. Press SETUP on the front panel or remote control.
or
Click TOOL on the hover menu and select SETUP.
2. Select SYSTEM > SYSTEM CONFIGURATION.
3. Click S/W UPGRADE to open the UPGRADE FIRMWARE window.
4. Insert the USB device.
5. Select the media type (USB HDD/STICK).
6. Click SCAN.
7. Click OK to start the upgrade.

Disk Configuration

Format

Shows installed Hard Disk Drives and the status of other attached storage devices.

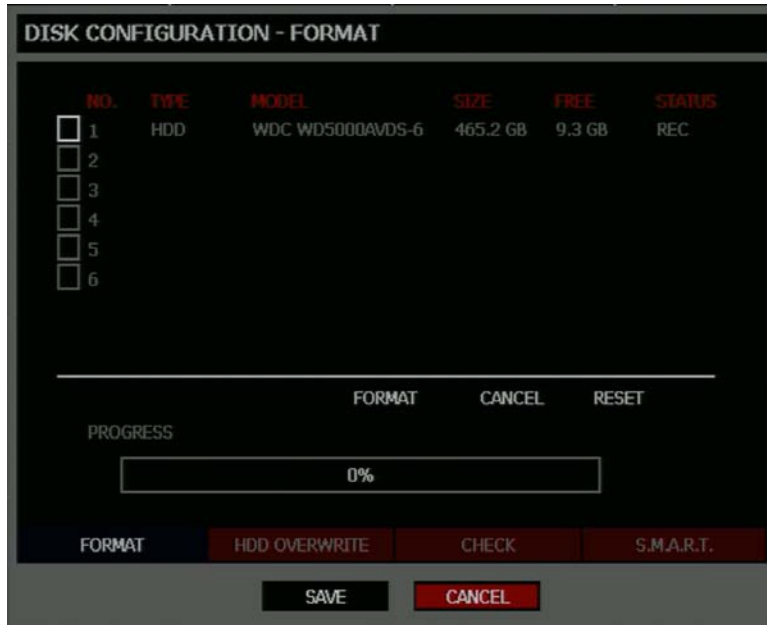

- To format a Hard Drive use the arrow keys to select the appropriate device and press Enter. Select FORMAT and press Enter, select YES to confirm formatting and press Enter.
- To format a USB device use the arrow keys to select the device and press Enter. Select Format and press Enter. Select YES to confirm and press Enter.

Tip Refer to the list of Approved USB Flash Drives in the Introduction chapter.

- To refresh the list of connected USB devices select RESET and press Enter.

Caution All USB devices must be formatted as FAT32 before using with the DVR.

Note Upon formatting a drive, all video and other data stored on that drive will be permanently erased and cannot be recovered.

Overwrite

Sets the options for overwriting data when the Hard Disk Drive is full.

DISK CONFIGURATION - HDD OVERWRITE

WARNING CONDITION

HDD OVERWRITE	ENABLE
DISK-FULL WARNING	ON
REMAINING TIME	10 MIN
USED SPACE	90 %

WARNING METHOD

DISK-FULL ALARM	1
DISK-FULL BUZZER	OFF
DISK-FULL MESSAGE	OFF

FORMAT
HDD OVERWRITE
CHECK
S.M.A.R.T.

SAVE
CANCEL

Enable HDD OVERWRITE to allow the DVR to write over previously recorded data, starting with the oldest date, when the HDD is full. If set to DISABLE the DVR will not record any new data after the HDD is full.

Enable a WARNING METHOD to select the desired notification method when the HDD is full and HDD Overwrite is disabled.

Check

Checks the HDD for errors or failure.

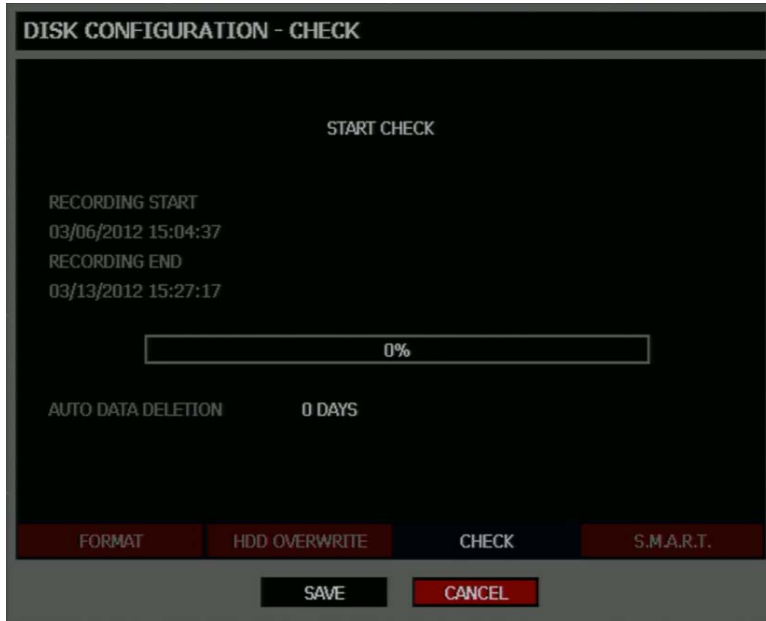

Auto Data Deletion

The Auto Data Deletion function saves data for a user specified number of days before deleting it. This function should be used in installations where local law prevents retention of data past a certain number of days.

- Click the number of days displayed next to **AUDO DATA DELETION** to adjust the number of days to save video data.

SMART Check

S.M.A.R.T. = Self Monitoring Analysis & Reporting Technology.
 Enable SMART Check to detect signs of HDD failure.

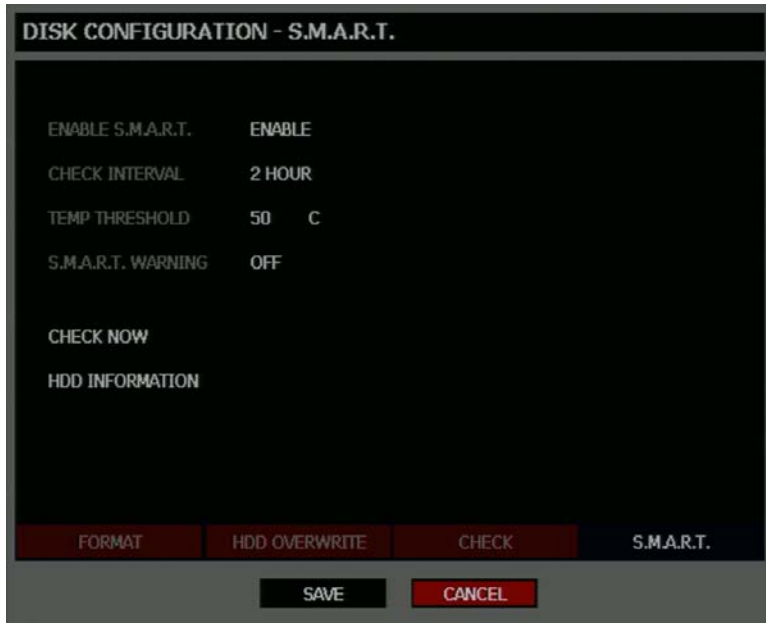

1. Set **ENABLE S.M.A.R.T.** to **ENABLE** or **DISABLE**.
2. Set a **CHECK INTERVAL** between 1 and 24 hours.
3. Define a **TEMP THRESHOLD** and select Celsius or Fahrenheit.

Note The recommended upper optimum operating temperature for the HDD is between 104F to 122F (40C to 50C).

4. Select a **S.M.A.R.T. WARNING** to be activated when the HDD reaches the defined threshold.
5. Select **SAVE** and press Enter to save settings.

Tip Select **HDD INFORMATION** and press Enter to view the current HDD, and USB drive information.

User Configuration

Use the User Configuration to Add or Delete users.



Adding / Changing a User

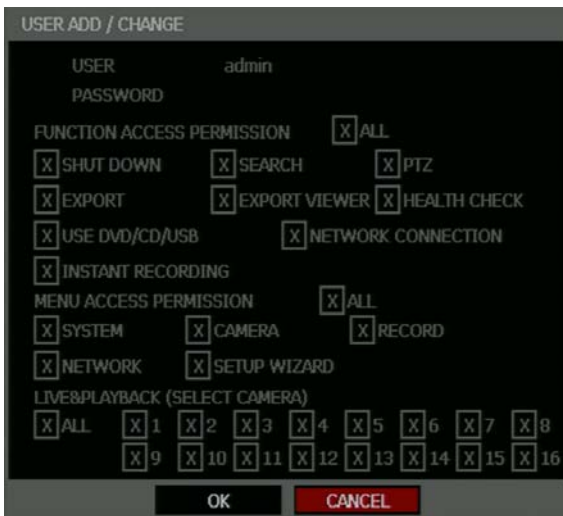

SHUT DOWN – Allow the user to shut down or restart the DVR.

EXPORT – Allow the user to perform an export or backup saved data.

USE CD/DVD/USB - Allow the user to use an external DVD or USB Drive. *This feature is not available when using the remote software.*

SEARCH – Allow the user to perform a calendar, or event search and access data from the current day using the Replay button on the front panel.

EXPORT VIEWER – Allow the user to include a copy of the Backup Viewer application when a local backup is made. *This feature is not available when using the remote software.*

PTZ – Allow the user control of any connected PTZ cameras.

HEALTH CHECK – Allow the user to use the Health Check function of SCS to connect to and monitor the DVR.

NETWORK CONNECTION – Allow the user to log in using Web Viewer, SCS, or Remote.

MENU ACCESS PERMISSION – Allow the user to access the selected portion of the setup menu.

LIVE & PLAYBACK – Allow the user to view live and recorded data for only the selected cameras.

To add a new user:

1. Press **SETUP** on the front panel or remote control.
or
Click **TOOL** on the Mouse-over menu and select **SETUP**.
2. Select **SYSTEM > USER CONFIGURATION**.
3. Click **ADD/CHANGE**.
4. Enter a **USER** name.
5. Enter a **PASSWORD** and **CONFIRM** for the new user.
6. Select the **FUNCTION** and **MENU ACCESS** options for the user.
7. Select which cameras will be visible to the user in **LIVE & PLAYBACK** modes.

Configuration

Import and Export current settings. See details in the Save Settings section.

Shutdown

Use Shutdown to safely shut down the system.

1. Select **System > Shutdown**.
2. Select **OK** to confirm and press Enter to safely shutdown the system.
3. Turn the power off when shutdown is complete by unplugging the power adapter cord on the back of the DVR.

Note Improper shut down of the system can cause data loss and system corruption.

CAMERA

Camera Configuration



CH – Camera Channels

NAME – Use the on-screen keyboard to enter a camera name [user defined]

HIDDEN – ON/OFF

Note HIDDEN on the CAMERA CONFIGURATION page hides cameras from the main monitor (VGA/MAIN BNC) when no users are logged in. To hide cameras from users, clear camera check boxes on SYSTEM > USER CONFIGURATION > ADD/CHANGE.

ADJUST – Detailed camera display settings.

PRIVACY ZONE – Set masked area where there will be no recording.

Adding a Privacy Zone

Adding a privacy zone to a specific camera means the recorder will not record video of anything within the masked area. Privacy zones can be used when a camera field of view includes sensitive information areas, windows into private residences, or changing areas.

1. Press SETUP on the front of the DVR or remote control.
2. Select CAMERA > CAMERA Configuration and select PRIVACY ZONE .
3. Use the mouse to select or clear squares on the grid:
 - a) Click the squares to include in the motion grid.
 - b) Right-click and select SAVE AND EXIT to save the selected motion grid.

Color Setup (Adjust)

- CAMERA – 1 ~ 16 [camera to apply color settings to]
- BRIGHTNESS – 0 ~ 20
- CONTRAST – 0 ~ 20
- COLOR – 0 ~ 20
- DEFAULT – Apply default system color settings.
- APPLY ALL – Apply current color settings to all cameras

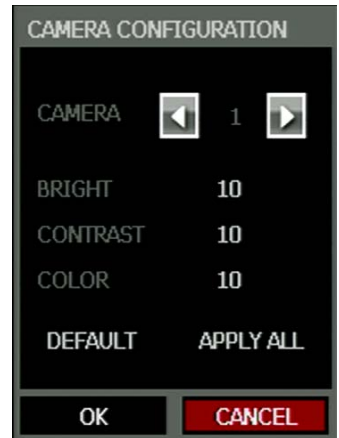

PTZ Configuration

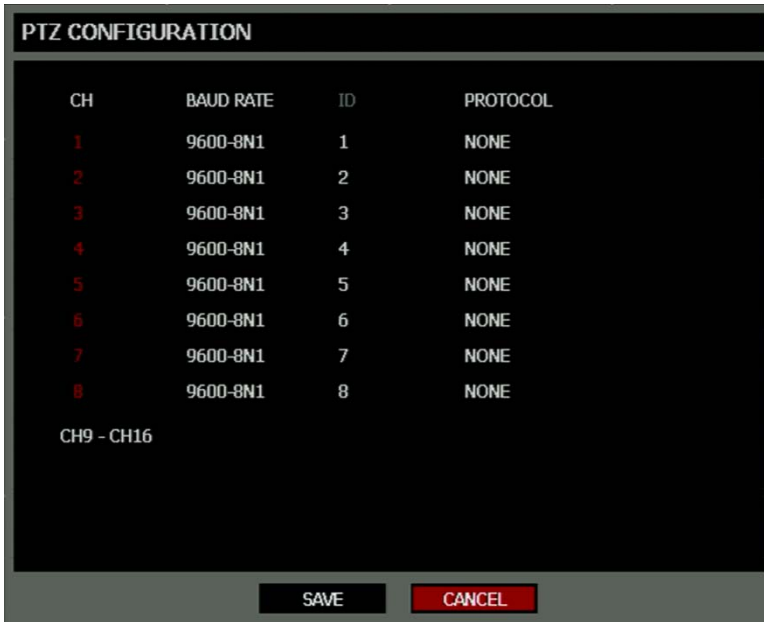

CH – Camera Channels

BAUD RATE – Sets the port information for the connected camera. [Consult the documentation provided by the camera manufacturer to obtain this information.]

ID – Sets the PTZ ID from 1-255

PROTOCOL – Select a PTZ protocol

Spot / Sequence Configuration

Spot/Sequence Configuration allows you to set the parameters for the SPOT OUT on the DVR and the local live view sequencing.

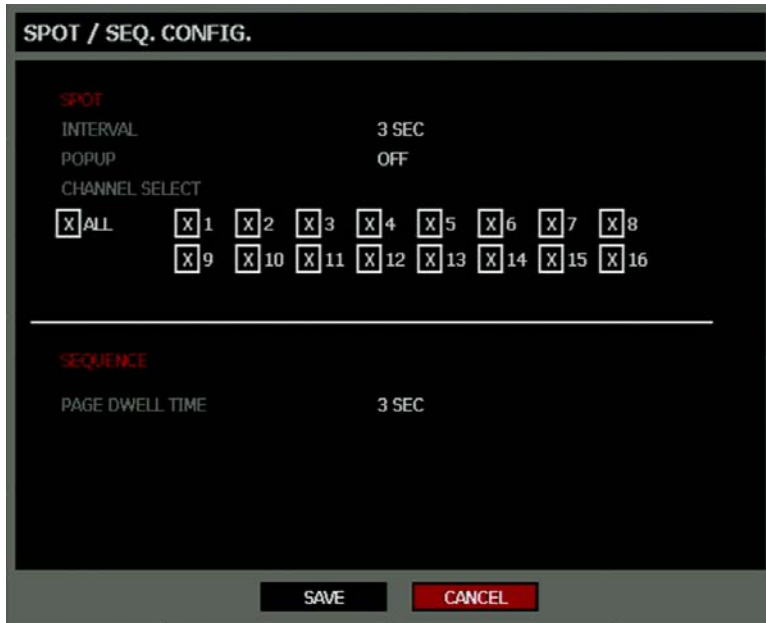

SPOT –Configure the SPOT OUT connection.

INTERVAL– 1 ~ 100 seconds [Set the sequence interval time].

POPUP – ON / OFF [When set to ON, this function interrupts the sequencing when an event occurs, and switches to the event channel.]

CHANNEL SELECT – 1~16 / ALL [Select cameras to include in sequence.]

SEQUENCE – Configure the appearance of the sequence on the live view screen (MAIN/VGA).

PAGE DWELL TIME – 0 ~ 100 seconds [Set the sequence interval time for full page].

Monitor Configuration

The screenshot shows a 'MONITOR CONFIGURATION' menu with the following settings:

- TRANSPARENCY SETUP: 0
- VGA RESOLUTION: 1024X768
- FIT-IN VGA
- OSD:
 - ALL
 - DATE
 - TIME
 - TITLE
 - PTZ
 - RECORD
 - AUDIO
- INFORMATION: FIT-IN VGA : Main Output is VGA(VGA or SPOT)

At the bottom of the screen are two buttons: 'SAVE' and 'CANCEL'.

TRANSPARENCY SETUP – 0 ~ 20 [Set the transparency of the setup windows].

VGA RESOLUTION – Set monitor resolution.

FIT-IN VGA – Adjusts the display to display properly on a VGA monitor. When the FIT-IN VGA check box is cleared, the display is adjusted to display on a monitor connected to the MAIN BNC output.

OSD – Select the items to display on the screen (DATE, TIME, TITLE, PTZ, RECORD, AUDIO).

RECORD

Recording Configuration

Frame

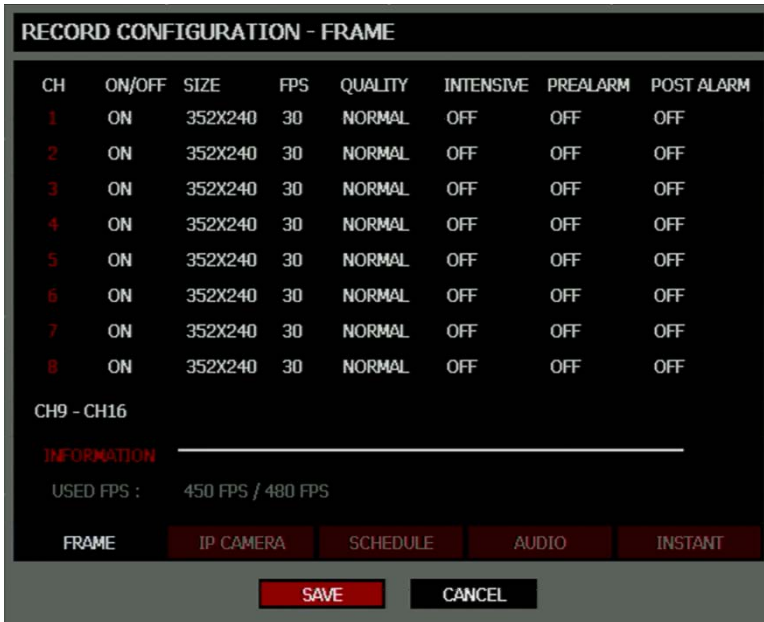

ON/OFF – Enable or disable recording on individual camera channels.

SIZE – 352 × 240 / 704 × 240 / 704 × 480. [Resolution]

FPS – 1–30 [Recording Images Per Second]

QUALITY – Low / Normal / High

INTENSIVE – ON/OFF [Intensive Recording on sensor or motion event]

Note When a motion or sensor event occurs, INTENSIVE RECORDING automatically increases the recording rate to the maximum FPS that is available (based on your current recording configuration frame rate) up to 30 FPS per channel. If events occur on multiple channels with intensive recording enabled, the available FPS is evenly distributed across those channels.

PREALARM – 0–5 seconds [Pre-Alarm Recording]

POSTALARM – 0–30 seconds [Post Alarm Recording]

USED FPS – Displays the images per second (FPS) currently used, and the total available FPS. EHV models have up to a maximum of 480 FPS.

IP Camera

The EHV is a hybrid video recorder and allows you to add up to four IP cameras to the recorder. The IP cameras will be assigned to the last four channels on the recorder.

Note You must use SCS or Remote software to view the live camera video.



To add and configure IP cameras on the EHV recorder:

1. Press **SETUP** on the front of the DVR or remote control.
2. Select **RECORD > RECORDING CONFIGURATION > IP CAMERA**
3. Use **CAMERA DISCOVERY**, or set **ENABLE** to **ON** for the desired channel and manually enter the **IP** address.
4. Select the **STREAM** type, and enter the **ID**, **PASSWORD**, and **PORT** information for the camera.
5. Click **SAVE** and then go to **LIVE** view. If the cameras were added correctly, the screen will display **CONNECTED**.

Using Camera Discovery

Use Camera Discovery to automatically detect IP cameras that are connected to the recorder. Using Camera Discovery is available for recorders with a static IP address and makes it easy to add IP cameras.

Note To configure a Static IP address on the recorder, go to the Network Configuration screen

1. If the EHV is connected to the network and has a static IP address, click **CAMERA DISCOVERY** to locate the cameras on the local network.
2. Select a camera from the list, click the **CH** number on the bottom of the window to select the channel the camera will be assigned to, and then click **APPLY**.
3. Click **CLOSE** to close the **IPCAM LIST** window and complete the IP camera configuration.



Schedule

Set the recording schedule for each camera:

1. Press **SETUP** on the front panel or remote control.
or
Click **TOOL** on the Mouse-over menu and select **SETUP**.
2. Select **RECORD > RECORD CONFIGURATION > SCHEDULE**.
3. Select a camera to create a recording schedule, or select **ALL**.
4. Select the check box of the desired **RECORD MODE**.
5. Click the hour block or the day of the week to set the entire day.

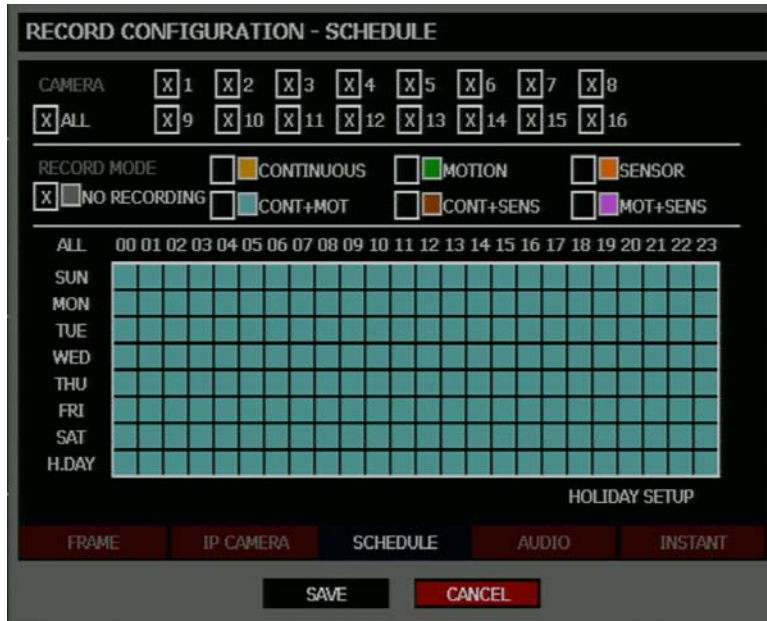

NO RECORDING No recording.

No Color Even if you set recording frames and select ON in RECORD > CONFIGURATION > FRAME, the DVR will not record anything if you set NO RECORDING in RECORD > SCHEDULE.

CONTINUOUS CONTINUOUS recording.

Yellow

MOTION MOTION-detection recording.

Green

In this mode, the DVR records only when motion is detected in the motion area, and stops recording when motion is not detected. Adjust motion area settings in RECORD > MOTION/EVENT CONFIGURATION > INPUT.

If you set Motion to OFF in RECORD > MOTION/EVENT CONFIGURATION and set CONT + MOT in SETUP > RECORD > SCHEDULE the DVR will NOT record when motion is detected.

SENSOR SENSOR-activated recording

Orange

In sensor mode, the DVR will record when a sensor is triggered - during DURATION time as set in RECORD > MOTION/EVENT CONFIGURATION > ACTION.

CONT+MOT Sky Blue	CONTINUOUS + MOTION detection recording The DVR records in CONTINUOUS mode but switches to MOTION when motion is detected in the motion area. The DVR also will log a Motion Event and send the event to the Remote Monitoring software. If you set motion to OFF in RECORD > MOTION/EVENT CONFIGURATION and set CONT + MOT in RECORD > RECORD CONFIGURATOIN > SCHEDULE the DVR will NOT record when motion is detected.
CONT+SENS Brown	CONTINUOUS + SENSOR-activated recording In this mode, the DVR records continuously and switches to SENSOR recording mode when a sensor is triggered. The DVR also will log a Sensor Event and send the event to the Remote Monitoring software.
MOT+SENS Lilac	MOTION detection + SENSOR-activated recording The DVR will only record when motion is detected or a sensor is triggered.

Holiday Setup

Add a recording schedule for a specific date in HOLIDAY SETUP. You can add up to 32 individual HOLIDAY recording schedules. To add a new HOLIDAY schedule:

1. Press **SETUP** on the front panel or remote control.
or
Click **TOOL** on the Mouse-over menu and select **SETUP**.
2. Select **RECORD > RECORD CONFIGURATION > SCHEDULE**.
3. Create a recording schedule in the **H.DAY** row.
4. Select **HOLIDAY SETUP**.
5. Select **DATE** and set the date using the on-screen calendar.
6. Type a description in the box next to the **DATE** box using the on-screen keyboard.
7. Select **ADD** to add the holiday.

Audio

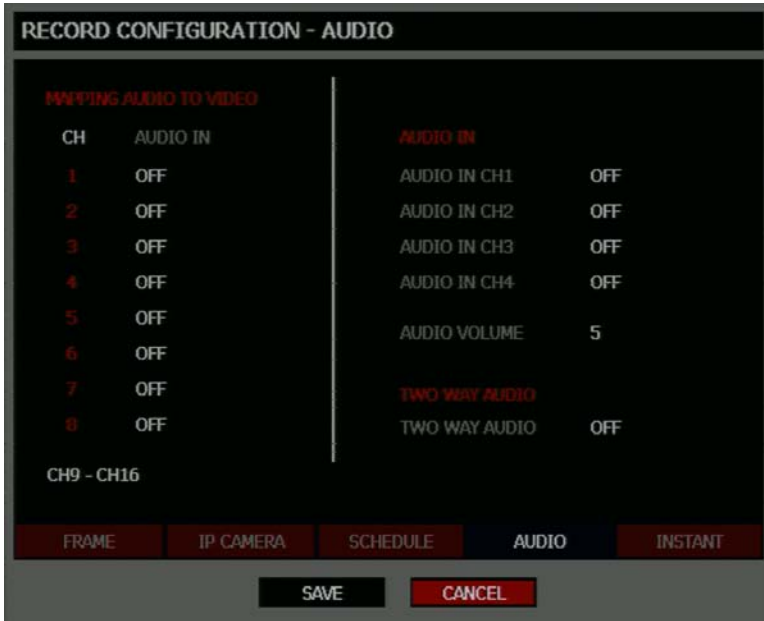

Associate cameras to the appropriate audio channel and enable each audio channel for recording.

Instant Recording

The DVR remote controller has an Instant Recording button. Press the INST. REC. button to start recording all the channels at the recording rate configured in Instant Record setup. All the channels, regardless of recording mode & recording on/off, will record.

I-REC will show in live mode and a red bar represents Instant Recording video in the graphic search bar.

Configure the recording settings for Instant Recording to use when it is activated.



FPS – Set the FPS (recording rate per camera).

QUALITY – Set the picture quality (affects file size).

SIZE – Set the resolution of the video image.

Using Instant Recording

To activate Instant Recording on the DVR:

- Press the REC key on the front panel of the DVR or remote control, or click the Instant recording button on the mouse-over OSD menu.
The I-REC recording icon will appear in the lower right corner of the screen.

To cancel Instant Recording on the DVR:

- Press the REC key on the front panel of the DVR or remote control.
The DVR will resume scheduled recording.

Motion/Event Configuration

Motion / Event Configuration has four sections; Input, Sensor, Action, and Alarm Monitor. When an event comes in (Input) the DVR records the image according to its settings (Camera Configuration) and triggers an alarm (Action).

Input

CH	MOTION	SENSITIVITY	AREA	SENSOR	VIDEO LOSS
1	ON	5	ON	OFF	OFF
2	ON	5	ON	OFF	OFF
3	ON	5	ON	OFF	OFF
4	ON	5	ON	OFF	OFF
5	ON	5	ON	OFF	OFF
6	ON	5	ON	OFF	OFF
7	ON	5	ON	OFF	OFF
8	ON	5	ON	OFF	OFF

CH9 - CH16

INPUT SENSOR ACTION ALARM MONITOR

SAVE CANCEL

CH – ▲ Channels 1-8 / ▼ Channels 9-16

MOTION – ON / OFF [Specify whether to use motion input or not.]

SENSITIVITY – 1-10 (1 = least sensitive, 10 = most sensitive)

AREA – Define the motion detection area.

SENSOR – Associate a sensor with the camera channel.

VIDEO LOSS – Trigger recording on video loss events.

Setting Up Motion Detection Recording

To record data only when motion is detected:

The screenshot shows a menu titled "MOTION/EVENT CONFIGURATION - INPUT". It contains a table with columns: CH, MOTION, SENSITIVITY, AREA, SENSOR, and VIDEO LOSS. Channels 1 through 8 are listed, all with MOTION set to ON, SENSITIVITY set to 5, AREA set to ON, SENSOR set to OFF, and VIDEO LOSS set to OFF. Below the table, it says "CH9 - CH16". At the bottom, there are four menu options: INPUT, SENSOR, ACTION, and ALARM MONITOR. Below these are two buttons: SAVE and CANCEL.

CH	MOTION	SENSITIVITY	AREA	SENSOR	VIDEO LOSS
1	ON	5	ON	OFF	OFF
2	ON	5	ON	OFF	OFF
3	ON	5	ON	OFF	OFF
4	ON	5	ON	OFF	OFF
5	ON	5	ON	OFF	OFF
6	ON	5	ON	OFF	OFF
7	ON	5	ON	OFF	OFF
8	ON	5	ON	OFF	OFF

CH9 - CH16

INPUT SENSOR ACTION ALARM MONITOR

SAVE CANCEL

1. Press **SETUP** on the front of the DVR or remote control.
2. Select **Record > Motion/Event Configuration** and set **MOTION** to **ON**.
3. Set the motion **SENSITIVITY** level. [1~10].
4. Select **AREA** and press Enter to set a motion area (global setting; each channel can be configured individually).
5. Use the mouse to select or clear squares on the grid:
 - c) Click the squares to include in the motion grid.
 - d) Right-click and select **SAVE AND EXIT** to save the selected motion grid.
6. Repeat as necessary for each channel.
7. When motion area setup is complete select **SAVE** to save settings and exit setup.

Sensor



Sensor Setup

1. Use the arrow buttons to select Sensor 1 and press Enter to change to **N/O** (Normally Open) or **N/C** (Normally Closed).
2. Repeat for all sensors.
3. Select **SAVE** and press Enter to save settings.

Alarm Setup

1. Use the arrow buttons to select Alarm 1 and press Enter to turn the **SIGNAL** to **OFF** or **ON**.
2. Set each Alarm to **N/O** (Normally Open) or **N/C** (Normally Closed).
3. Repeat for all relays.
4. Select **SAVE** and press Enter to save settings.

Power Off

The **POWER OFF** option is a preset function that triggers an alarm relay when the DVR loses power. This function is preconfigured to set alarm relay No. 4 to **ON** and **N/C**. When a power loss occurs, alarm relay No. 4 will open. When power is restored the alarm will close.

S.M.A.R.T. Alarm

The **S.M.A.R.T. ALARM** option is a preset function that triggers an alarm relay when the DVR HDD exceeds the temperature threshold configured on the **SYSTEM > DISK SETUP > S.M.A.R.T.** page. This function is preconfigured to set an alarm relay to **ON** and **N/C**. When the HDD exceeds the temperature threshold, the alarm relay will open. When the temperature is at a safe level again the alarm will close.

Latch Mode

Latch Mode will trigger the Video Loss alarm to remain on until the video signal is restored. When video returns the alarm will turn off. The Latch Mode option is set to **ON** by default

Note SET and CLEAR are used to test the alarm relay operation. SET is used to manually activate all relays that are set to ON. CLEAR is used to manually deactivate all relays.

Action

CH	ALARM	DELAY	DURATION	PRESET
1	OFF	OFF	5 SEC	OFF
2	OFF	OFF	5 SEC	OFF
3	OFF	OFF	5 SEC	OFF
4	OFF	OFF	5 SEC	OFF
5	OFF	OFF	5 SEC	OFF
6	OFF	OFF	5 SEC	OFF
7	OFF	OFF	5 SEC	OFF
8	OFF	OFF	5 SEC	OFF
CH9 - CH16				NOTIFY

INPUT SENSOR ACTION ALARM MONITOR

SAVE CANCEL

CH – ▲ Channels 1-8 / ▼ Channels 9-16

Alarm – OFF / 1-4 [Associate an alarm relay with a channel].

Delay – 0-100 Seconds [Delay time before relay activates].

Duration – 0-100 Seconds [Time that the relay is active].

Preset – 0-100 [Enable PTZ camera to move to a preset position when an event occurs. See PTZ Control for more information.]

NOTIFY – BUZZER/POPUP [Type of alarm with event].

Alarm Monitor

Send event information to a remote client, like SCS, using the Alarm Monitor software.

MOTION/SENSOR		
NO.	IP ADDRESS	PORT
1	192.168.0.1	2001
2	192.168.0.1	2001
3	192.168.0.1	2001
4	192.168.0.1	2001
5	192.168.0.1	2001

1. Select SEND TO ALARM MONITOR and press Enter to select ON.
2. Select the types of events to send to the Emergency Agent (MOTION, SENSOR, MOTION + SENSOR.)
3. Enter the IP ADDRESS of the remote client.
4. Enter the PORT number.

Note The port number selected is the port that Alarm Monitor uses on the remote PC. The port shown in this screen must match the port shown in Alarm Monitor or SCS and the port must be open on the remote PC.

NETWORK

Network Configuration

Configure network settings.



Network

HOST NAME – Hostname for the DVR on the network.

NETWORK TYPE – STATIC IP (User must manually define a static IP address. Contact your network administrator for this information.) DHCP (System gets IP address automatically from a DHCP server.)

IP ADDRESS – DHCP or Static. Contact your network administrator for this information.

CLIENT CONFIGURATION – Set up the connection ports and Max transfer speed for remote connections.

Center PORT – The EHV uses the Center port and the primary communication port to create remote connections. This port must be the same as the port setting on the remote PC.

VIDEO PORT – The EHV uses multiple ports to create remote connections: the remote port is user defined (default 2000), and a secondary port is automatically assigned (default 2002). The DVR assigns the secondary port based on the remote port, in increments of two. (ex: if you set the remote port to 2222, then the secondary port will be 2224). Verify that all these ports are available when setting up Network Address Translation (NAT) or firewall.

Network Configuration continued

WEB PORT – Defines the port that Internet Explorer uses to connect over the web and view video. If this port is changed then the new port must be defined when attempting to web connect (ex: if your DVR IP address is 10.0.0.5 and you change the web port to 800, then you must type http://10.0.0.5:800 in your browser).

MAX TRANSFER SPEED – Set network bandwidth. This feature is used for slower internet connections to throttle the amount of data the DVR sends across the network at a time.

DDNS – DDNS (Dynamic Domain Name Service) is a service that allows a connection to an IP address using a hostname (URL) address instead of a numeric IP address. Most Internet Service Providers use Dynamic IP Addressing that frequently changes the public IP address of your internet connection; this means that remote connections through SCS and Surveillix Remote would require frequent updates. DDNS automatically redirects traffic to your current IP address when using the hostname address (i.e. MyEHV.toshibaddns.com).

DDNS SERVER – The current DDNS server.

HOST NAME – Hostname for the DDNS server account.

ID – Username for the DDNS server account.

PASSWORD – Password for the DDNS server account.

STATUS – Checks DDNS settings by attempting to communicate with the DDNS Server.

Serial Configuration

Configure connected serial devices.

The screenshot shows a 'SERIAL CONFIGURATION' window with two columns of settings. The left column is for 'RS-232' and the right column is for 'RS-485'. Both columns have identical settings: TYPE: NONE, MODEL: NONE, BAUDRATE: 9600 BPS, DATA BIT: 8, PARITY: NONE, and STOP BIT: 1. At the bottom, there are 'SAVE' and 'CANCEL' buttons.

RS-232		RS-485	
TYPE	NONE	TYPE	NONE
MODEL	NONE	MODEL	NONE
BAUDRATE	9600 BPS	BAUDRATE	9600 BPS
DATA BIT	8	DATA BIT	8
PARITY	NONE	PARITY	NONE
STOP BIT	1	STOP BIT	1

TYPE – None / External Controller.

MODEL – Select appropriate model.

Port Information

BAUD RATE / DATA BIT / PARITY / STOP BIT

E-mail Configuration

The DVR can send an email notification to up to six defined e-mail addresses when an event happens.

E-MAIL SERVER – DVR/SMTP [Configure the DVR to use selected e-mail server.]

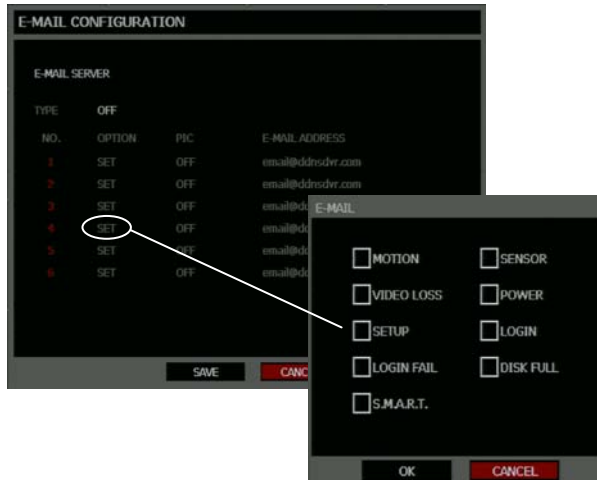

OPTION – Define the type of event that will trigger an e-mail notification.

MOTION – After a motion alarm is triggered.

SENSOR – After a sensor alarm is triggered.

VIDEO LOSS – After video loss on a camera.

POWER – When the DVR is shutdown and restarted.

SETUP – When a user accesses Setup.

LOGIN – When a user logs in.

LOGIN FAIL – After three failed login attempts.

DISK FULL – When the HDD reaches the user-defined maximum disk full percentage. See DISK MANAGEMENT – OVERWRITE.

SMART – When the HDD reaches the user-defined maximum temperature. See DISK MANAGEMENT – SMART.

PIC – ON / OFF [Enable to send a picture of the event.]

E-MAIL ADDRESS – Enter the e-mail address.

INFORMATION

System Log View

System Log View displays the recent activity of all users on the DVR. You can export and save the System Log to review user activity.

SYSTEM LOG

DATE 03/13/2012

ALL SYSTEM SETUP NETWORK

NO. DATE SYSTEM LOG ◀ 1/8 ▶

1	03/13/2012 16:10:47	Monitor Configuration Changed
2	03/13/2012 16:10:33	Enter SETUP
3	03/13/2012 16:10:33	Login Success
4	03/13/2012 16:10:24	Recording Start
5	03/13/2012 16:10:24	System Started

USER admin

Monitor Configuration Changed

TARGET NONE SCAN EXPORT

EXIT

Version View

Displays system information and software version information for the DVR.

VERSION

VIDEO FORMAT NTSC

VIDEO MUX 80503.1

VIDEO CODEC 60115.0

VIDEO I/O 40618.0

FIRMWARE 2.0.0.2

MCU MODULE 5.3.0

PTZ MODULE 2.0

DRIVER MODULE 8.01-16-N

MAC ADDRESS 00:1C:84:10:98:8C

EXIT

Status View

Displays status screens for:

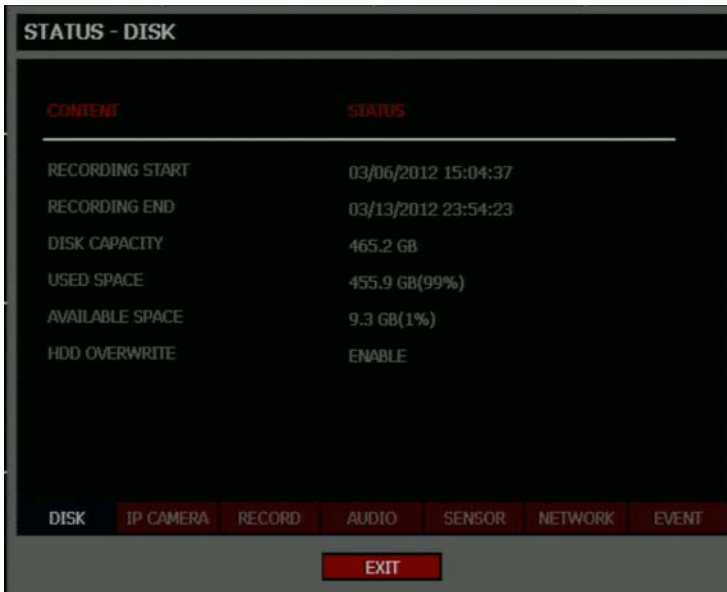

Disk

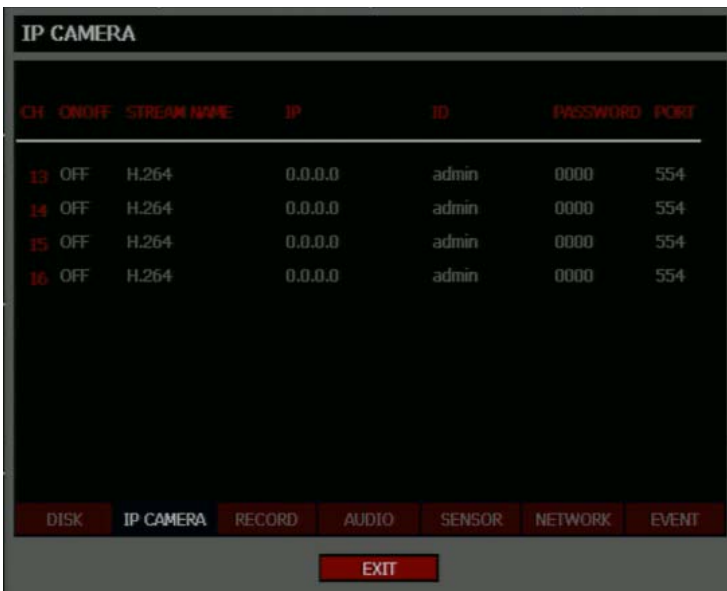

IP Camera

STATUS - RECORD			
CH	FPS	RESOLUTION	QUALITY
1	30	352X240	NORMAL
2	30	352X240	NORMAL
3	30	352X240	NORMAL
4	30	352X240	NORMAL
5	30	352X240	NORMAL
6	30	352X240	NORMAL
7	30	352X240	NORMAL
8	30	352X240	NORMAL

CH9 - CH16

DISK IP CAMERA RECORD AUDIO SENSOR NETWORK EVENT

EXIT

Record

STATUS - AUDIO			
MAPPING AUDIO TO VIDEO			
CH	AUDIO IN	AUDIO IN	
1	OFF	AUDIO IN CH1	OFF
2	OFF	AUDIO IN CH2	OFF
3	OFF	AUDIO IN CH3	OFF
4	OFF	AUDIO IN CH4	OFF
5	OFF	AUDIO VOLUME	5
6	OFF	TWO WAY AUDIO	
7	OFF	TWO WAY AUDIO	OFF
8	OFF		

CH9 - CH16

DISK IP CAMERA RECORD AUDIO SENSOR NETWORK EVENT

EXIT

Audio

STATUS - SENSOR

SENSOR		ALARM		
NO.	TYPE	POWER OFF	OFF	
1	N/O	S.M.A.R.T. ALARM	OFF	
2	N/O	NO.	SIGNAL	TYPE
3	N/O	1	OFF	N/O
4	N/O	2	OFF	N/O
5	N/O	3	OFF	N/O
6	N/O	4	OFF	N/O
7	N/O			
8	N/O			

CH9 - CH16

DISK IP CAMERA RECORD AUDIO **SENSOR** NETWORK EVENT

EXIT

Sensor

STATUS - NETWORK

CONTENT	STATUS
HOST NAME	dvr
NETWORK TYPE	DHCP
IP ADDRESS	192.168.0.1
SUBNET MASK	255.255.255.0
GATEWAY	192.168.0.1
DNS	192.168.0.1
CENTER PORT	2000
WEB PORT	80

CLIENT

DISK IP CAMERA RECORD AUDIO SENSOR **NETWORK** EVENT

EXIT

Network

STATUS - EVENT

CH	MOTION	SENSOR	ALARM
1	ON	OFF	OFF
2	ON	OFF	OFF
3	ON	OFF	OFF
4	ON	OFF	OFF
5	ON	OFF	OFF
6	ON	OFF	OFF
7	ON	OFF	OFF
8	ON	OFF	OFF

CH9 - CH16

DISK IP CAMERA RECORD AUDIO SENSOR NETWORK EVENT

EXIT

Event

OPERATION

LOGIN

The LOG-IN window will display on the monitor until a user logs in with the correct ID & password.

Tip To prevent unauthorized changes to the system settings, the administrator should change the default administrator password and create a User account.

Default Administrator Log In

The default administrator account login is:

USER: admin

PASSWORD: <blank>

LIVE DISPLAY MODE

Channel Selection

A live image can be selected by pressing corresponding number key on the DVR front panel.

The images can be seen in real-time in the configuration of 1, 4, 9, 16 channels and PiP screen. To toggle through the viewing options press LIVE on the DVR.

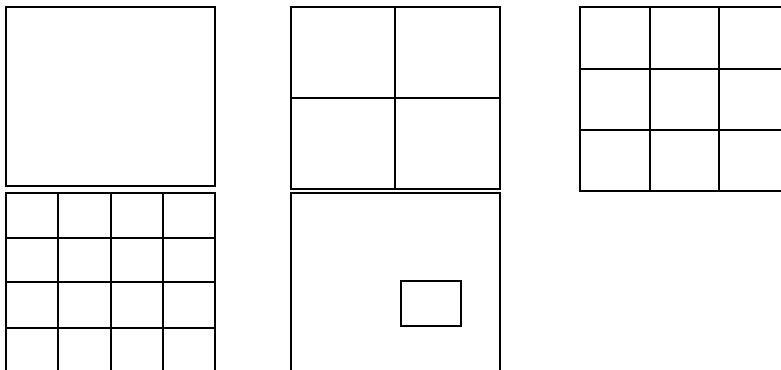

To select a channel using a mouse, double-click the video image. To return to a previous screen mode after selecting a viewing channel, double-click again.







Icons

In Live mode, icons or messages on the screen indicate the system mode or status.

Right-upper corner on each CH screen

-  Continuous Recording
-  Motion Detection Recording
-  Sensor Activated Recording
-  Continuous + Motion Alarm Recording
-  Continuous + Sensor Activated Recording
-  Motion Detection + Sensor Activated Recording
-  Emergency Recording
-  Sensor Activated
-  Motion Detected
-  PTZ Camera
-  Audio Channel

Right-bottom corner on full screen.

-  No HDD, Smart Alarm & HDD Failure
-  Using Emergency Recording
-  Using PTZ
-  Warning when exceeding temperature
-  Showing sequence mode
-  Showing digital zoom mode

Mouse-Over Menu

Move the mouse to the bottom of the monitor in live mode. The mouse-over menu will instantly appear.



Sequence – Click to start camera sequence.



Instant Recording – Click to start instant recording. In instant recording mode, the records all channels at the recording rate configured in the Emergency Recording setup.



PTZ Mode – Click to enter PTZ mode. In PTZ mode, you can pan/tilt and zoom by moving the mouse pointer, referred to as a virtual joystick.



Quick Search – Click to automatically play back the most recent video clip.



Dock Tool Menu – Click to dock the Tool menu at the bottom of the screen. If the Tool menu is not docked, it will be shown only when you place the mouse pointer in the lower portion of the screen.

Note If there is no icon in the upper right corner of the live screen mode, it means that the system is not currently recording. If this is the case, you should check the recording schedule or camera setup in the main setup menu.

Popup Menu

Right-click the live screen to open the Popup Menu.

HIDE LIVE VIEW – Hide the selected camera from Live view.

RECORD CHANGE – Change the recording settings for that channel including FPS, quality, resolution and event response.

PAGE SEQUENCE – The SEQ icon is shown on the bottom right of the screen and displayed channels will be sequentially changed.

FREEZE ALL – Pause all channels displayed on-screen.

SHOW MOTION AREA – Display the motion grid for the selected camera.

DISPLAY-PIP – Change screen display to PIP.

AUDIO – Select an audio channel to play (live).

LOGOFF – Select to log out the active user.

SEARCH – Open the Search Menu.

PTZ – Switch to PTZ mode.

SETUP – Open the Setup Menu.



No Signal

If no camera is connected to a channel, NO SIGNAL is shown on the display screen. When a camera is disconnected, the DVR will generate a warning sound according to the system settings.

No Permission

The Administrator can set different levels of authorization for each user. If a user is not allowed to view a certain live or playback channel, a PERMISSION NOT GRANTED! warning is shown on the display screen.

PTZ

To enter PTZ mode:

- Right-click the Live screen and select PTZ on the pop-up menu, or
- Click the PTZ icon on the Tool menu on the bottom of the main screen.

Drag the mouse up/down or left/right to move pan/tilt position of the camera. As you move the mouse away from the center of the screen, the camera movement speed increases. You can also zoom-in/out by using the scroll wheel on the mouse.

Note Full PTZ functions are available using the front panel buttons, a mouse, the IR remote control, or a keyboard controller.

PTZ Popup Menu

Right-click the desired camera to open the PTZ Popup menu while in PTZ mode.



Arrow Buttons – Move Camera

M – Open camera's on screen display menu (dependant on camera model support, see your camera's manual for information)

ZOOM – Zoom in/out on PTZ camera. Enabled by default in PTZ mode

FOCUS – Adjust focus on PTZ camera.

IRIS – Adjust the iris on PTZ camera.

PRESET – Go to preset position. Select the preset number. The maximum preset number is 255

PRESET TOUR – Start preset tour. PRESET TOUR will sequence though all preset positions. Can only be enabled while in full screen mode.

SOFTWARE TOUR – Create a tour including up to 10 presets stored on the camera and save the tour to the DVR. This works best with cameras that do not have a built-in Tour feature.

Create PTZ Preset Position

1. Right-click the desired PTZ camera to open the PTZ Popup menu while in PTZ mode.
2. Select a PTZ Preset ID number.
3. Select MOVE under PRESET to move the camera to the desired position.
4. Select SET to save the preset position.

SEARCH

Searching Recorded Data

Search recorded video on the DVR to find a specific time or event.



1. Press the SEARCH key on the front of the DVR or the remote control to enter Search Mode.
2. Select TARGET media (HDD, USB).
3. Select the desired search method.

Quick Search

Click the  button on the Tool menu bar to automatically playback the latest video clip.

Using the playback control icons, you can search recordings and control the speed of the playback by 2x, 4x, 8x, 16x, or 32 times to the forward or backward directions.

Graphic Search

In the search mode, click the colored time bar to search the desired section of recorded video.

- The white-vertical line indicates the current search time.
- The colors of the time bar are different according to the recording method selected.

Yellow – Continuous recording.

Green – Motion-detection recording.

Orange – Sensor-activated recording.

Sky Blue – Continuous + Motion detection recording.

Dark orange – Continuous + Sensor-activated recording.

Pink – Motion detection + Sensor-activated recording.

Red – Instant Recording.

Dark Blue – Data recorded during DST (Daylight Saving Time).



Quick Backup in Search Mode

You can easily archive video while watching a video playback.

In the search mode:

1. Press the BACKUP on the front panel to set the Start time. You will see the indicator "S", for Start, and the Date/Time of clip in the right bottom of the playback monitor.
2. Continue video playback until you reach the end of the desired clip.
3. Press the BACKUP again to set the end time. The backup menu will open and you can select the backup media (USB thumb drive) and execute the backup.

Express Search

Select a specific date and time to search for recordings:

1. Press SEARCH on the front panel or remote control and then EXPRESS SEARCH, or Click TOOL on the Tool menu, select SEARCH and then select EXPRESS SEARCH.
2. Select a date from the date list and press PLAY on the front panel or remote to begin playing that date from the beginning, or press Enter to select a time.
3. Select a time by scrolling to the timeline box and pressing enter. Use the left/right arrows to scroll forward and backward in time. Use the up/down arrows to change between hours and minutes view.

Tip Dates with an asterisk contain recorded video data.

Jump to First Saved Data

Go to the first frame of the recorded data. This is the oldest image recorded.

Jump to Last Saved Data

Go to the last frame of the recorded image. This is the latest image recorded.

Event Search

Use the Event Search to find particular events.

The 11 most recent events display on the first Event Search/Log page. Click the arrows at the top of the screen to view the remaining entries for each date. You can filter the log results by SENSOR, MOTION, and VIDEO LOSS.

Write the Event log to a connected USB device in text file format:

1. Insert a USB device in the DVR.
2. Click SCAN, and then click EXPORT to copy the log information to the USB device.
3. The Event Log is saved in a dated folder as a system.log file.

Daylight Savings Search

Daylight Savings Search is used to find recorded data after switching the time at the end of Daylight Savings Period. The System will record data with the same time stamp for two hours when they are repeated. If any overlapped time data exists the system will display the times on this page.

Search Popup Menu

Use to access display options in Search Mode.

- Right-click the desired channel to open the Search Popup Menu.

TIME SELECTION – Change the Date/Time to search.

AUDIO ON – ON/OFF.

SAVE JPEG – Save a JPEG still image of the current frame.

INTERPOLATION – Helps smooth out playback video.



Note SAVE JPEG is only available when a single camera is selected. To activate, select a single channel (full screen), pause playback, and press ENT twice, or right-click the channel to open the popup menu.

BACKUP (EXPORT)

Manual Export

Back up recorded data on a connected USB device.

Tip Refer to the USB Flash Drive Approved List in the Introduction chapter. If you are using a new USB device to back up your data, you must format it first as FAT32.

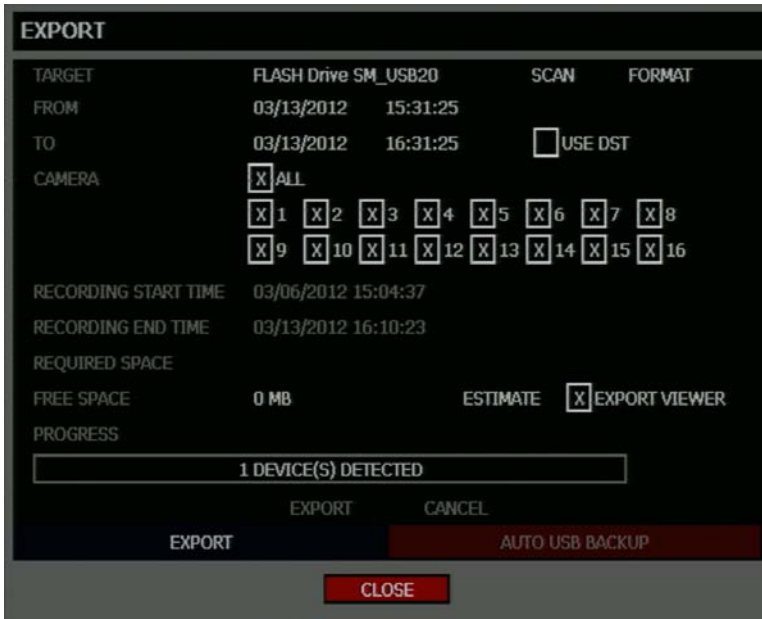

To configure a data backup:

1. Press BACKUP on the front panel or remote control.
or
Click TOOL on the hover menu and select EXPORT.
2. Connect a USB device.
3. Select SCAN to locate the device.
4. Select the desired CAMERAs and the RECORDING START TIME and RECORDING END TIME for the backup.
5. Select ESTIMATE to display estimated data size and free space available.

Note ESTIMATE must be selected first, before EXPORT. If any backup parameters are changed (Date, Time, Channels) you must select ESTIMATE again.

6. Select the EXPORT VIEWER check box to add the Export Viewer to the backup file.

Tip Video data is saved in a proprietary format and must be viewed using the Export Viewer software.

7. Select EXPORT.

Caution Do not shutdown the system during the backup process.

Search Backup Data

Backup files are saved in folders by date.

To view a backup file:

1. Insert the backup file media in a computer.
2. Double-click the Export Viewer program to open.
3. Open the desired backup file (saved by date).
4. Use the controls on the Export Viewer screen to playback, zoom, print or save an image.
5. Select additional options including, Audio Play, Deinterlace, Digital Zoom, Save, and Print.
- 6.

Deinterlacing

De-interlacing is often required for smooth playback of video that is recorded in 704x480 (4CIF) resolution.

The picture comparison below shows the difference between Interlaced video and a De-interlaced video clip.



Interlaced Image



De-interlaced image

USING THE BACKUP VIEWER

Play recorded video on a PC using Backup Viewer, the proprietary media player included with every backup file.

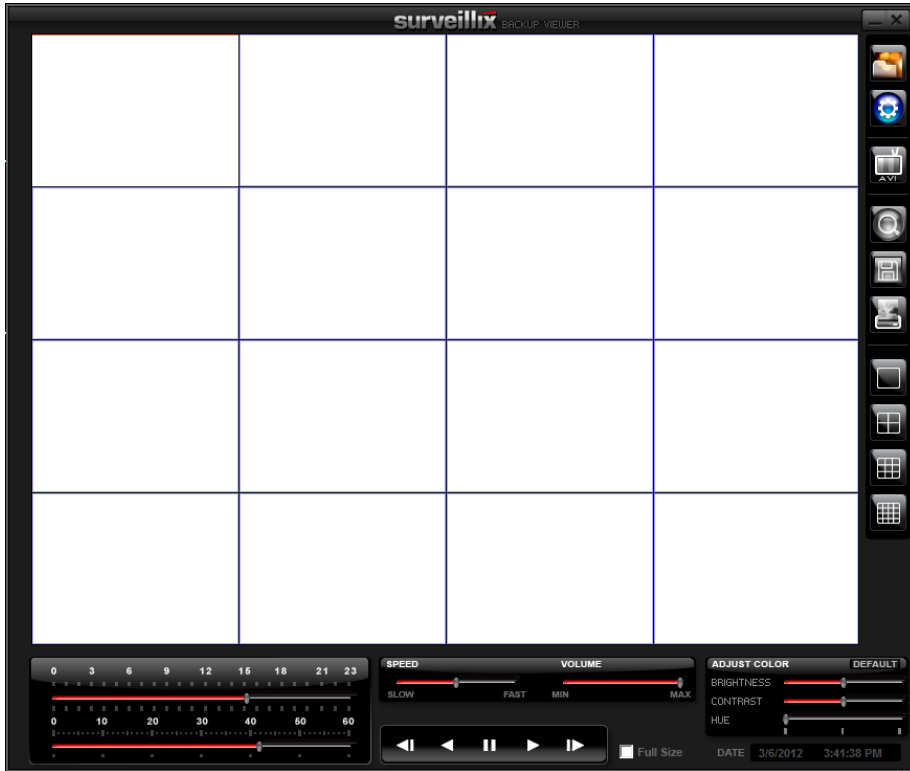

Controlling Backup Viewer

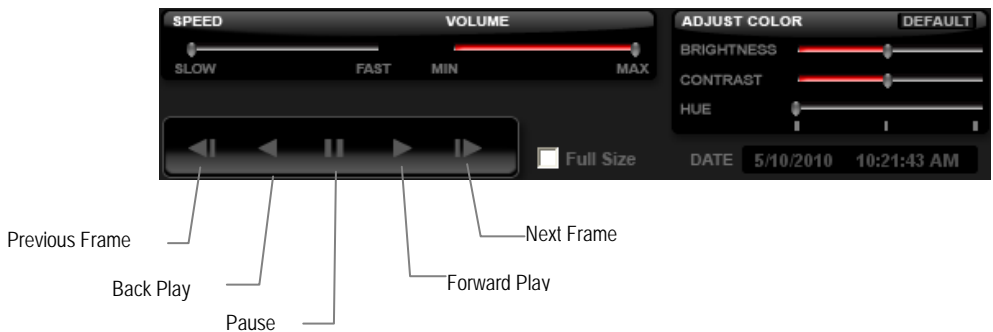

Setup and Save Functions

These function buttons allow you to configure the Backup Viewer and save a JPEG image or AVI video.



OPEN – Allows you to choose which data to open. When selecting data that is saved to your local hard drive, the video must be in a directory named DATA. Navigate to the folder above the DATA directory and click OK to see the available playback options.



SETTINGS – Select Direct Draw De-Interlacing for image viewing. Also allows you to include Image information when exporting a JPEG.



EXPORT AVI –To export an AVI file: Click this button, enter the desired Digital Signature, the AVI start time, the AVI end time and to include audio data (if desired) and press OK.



ZOOM – Select this button to turn your cursor into a magnifying glass and click the desired camera image to zoom in.



EXPORT JPEG – To save a JPEG: Click this button, enter the desired Digital Signature and click OK, then browse to the desired save location.



PRINT – Opens the print window on your computer.

Screen Division Buttons

The Screen Division buttons allows you to view cameras in groups such as two by two, three by three and four by four. The button options are shown below.



Single Channel View – Displays one camera channel. To return to a different Multi-Camera View, select a different Screen Division button.



Four Channel View – Displays cameras 1-4 in the Video Display Area. Click the button again to rotate to cameras 5-8, 9-12, etc. To return to a different Multi-Camera View, select a different Screen Division button.



Nine Channel View – Displays cameras 1-9 in the Video Display Area. Click the button again to rotate to cameras 9-16. To return to a different Multi-Camera View, select a different Screen Division button.



16 Channel View – Displays cameras 1-16 in the Video Display Area. To return to a different Multi-Camera View, select a different Screen Division button.

UPGRADE FIRMWARE AT THE DVR

Obtain the latest software release and save the file to a USB Device. Please check the product web site at www.toshibasecurity.com or contact Technical Support for the latest software.

1. Insert a USB Drive containing the update files.
2. Select **System > System Configuration**.
3. Select **S/W UPGRADE** to open the **UPGRADE FIRMWARE** window.
4. Select the media type (USB HDD/STICK).
5. Click **SCAN**.
6. Click **OK** to start the upgrade.

PLAY BACK BACKUP IMAGE

Play recorded video on a PC using the proprietary media player included with every backup file.

1. Connect an external USB device to the PC.
2. Navigate to the files on the USB drive.
3. Double-click the BKPlayer application.
4. Click the Open Video File icon and select the file to view from the desired date folder.

SAVE SETTINGS

Use the System Configuration menu to export and import saved or factory default system settings.



Save Settings

1. Press the **SETUP** key on the front of the DVR or remote control and log in.
2. Select **SYSTEM > CONFIGURATION**.
3. Select an empty **PROFILE** and define a name for the settings configuration. To save settings to a USB device, select **EXPORT**.
4. Select **SAVE** and confirm to continue the export process.

Import Settings

1. Press the **SETUP** key on the front of the DVR or remote control and log in.
2. Select **SYSTEM > CONFIGURATION**.
3. Select a previously saved **PROFILE** and select **LOAD**. To import a profile saved on a USB device, select **IMPORT**.
4. Select **OK** and press Enter on the front of the DVR to complete the import process.

REMOTE SOFTWARE

SET UP A REMOTE CONNECTION

The administrator and up to nineteen additional users (four simultaneously) can access the DVR remotely using software installed on a personal computer.

Minimum System Requirements

Windows XP, Vista or 7 Operating System
Intel Dual Core Processor
1GB RAM
256 MB+ NVIDIA or ATI Video Card
DirectX 9 or higher
256k Network Connection
32-bit color
1280x1024 Resolution

Recommended System Requirements

Windows XP, Vista or 7 Operating System
Intel Core 2 Duo 2.8 GHz processor
2GB RAM
DirectX 9 or higher
256k Network Connection
32-bit color
1280x1024 Resolution

Configuring the DVR

1. Press the **SETUP** key on the front of the DVR or remote control to log in.
2. Select **NETWORK > NETWORK CONFIGURATION** (see the Network Configuration section of this manual for more details).
3. Select **CLIENT CONFIGURATOIN SETUP** to change port settings or write down current port settings.
4. Select **DHCP** or **STATIC IP** depending on your network (Ask your network administrator for assistance).
5. If **STATIC IP** is selected - define the IP address and additional network information.
6. If **DHCP** is selected - write down the IP address supplied by the DVR system.

Note If the DVR does not display the IP Address after setting DHCP to ON, Select Save to change the network and open Network Configuration again.

7. Select **SAVE** to save current settings.

Creating a DVR Connection with Remote Software

1. Install the Remote Software on a PC using the disc provided with your DVR.
2. Open the Remote Software. The **Local Setup** window will open automatically.
3. Click **New**.
4. Select **EHV Series** as the **Site Type**.
5. Enter a name for the system in the **Site Name** box.
6. Enter the IP address of the DVR - found in **NETWORK > NETWORK CONFIGURATION** on the DVR.
7. Enter the Port number found in **NETWORK > NETWORK CONFIGURATION > CLIENT CONFIGURATION** on the DVR (default is 2000).
8. Click **OK**.
9. Enter the user name and password of an authorized user as defined in **SYSTEM > USER CONFIGURATION** on the DVR.

Note User Name and Password are both case sensitive.

10. Click **Connect**.

Default Remote Software Log in Information

The default administrative log in information for the remote software:

User Name: admin
Password: <none>

ACCESS REMOTE CONNECTION

1. Open the Remote Software.
2. Click on the icon of the server as defined previously.
3. Enter the user name and password of an authorized user as defined in the **SYSTEM > USER CONFIGURATION** menu on the DVR.

Note User Name and Password are both case sensitive.

4. Click **Connect**.

Connecting Multiple DVRs

Connect up to four EHV DVRs to the Remote Software to easily switch between DVRs.

1. Configure all DVR connections as described above in Configuring a Remote PC.
2. After connecting to the first DVR, click **Connect** on the **Display** screen to open the **Local Setup** window.
3. Select a second pre-configured DVR and click **Connect**.
4. Use the drop-down menu in the lower left corner of the display screen to switch between the connected DVRs.

USING THE REMOTE SOFTWARE

Setting the Time and Date

The Remote Software uses the system time of the PC. If the system time is not correct, follow the steps below to change it.

1. Exit to Windows by clicking the **Exit** button on the Live View screen and selecting **Restart in Windows Mode**.
2. Open Windows Explorer. Do this by right-clicking the My Computer Icon (located on the top left hand corner of the Desktop) and select Explore.
3. Click **Control Panel** to open it. If you do not see Control Panel listed, click **My Computer** to expand the folder tree.
4. Double-click **Date and Time** inside Control Panel.
5. Adjust the Date and Time.
6. When finished, close all open windows and restart the PC. Do this by clicking Start (located on the lower left hand side of the Desktop) and selecting **Shut Down**.

Live View Screen

Each time the software is restarted, the program defaults to the Live View screen. The following diagram outlines the buttons and features used on the Live View screen. It is important to be familiar with these options as this is the screen displayed the majority of the time.

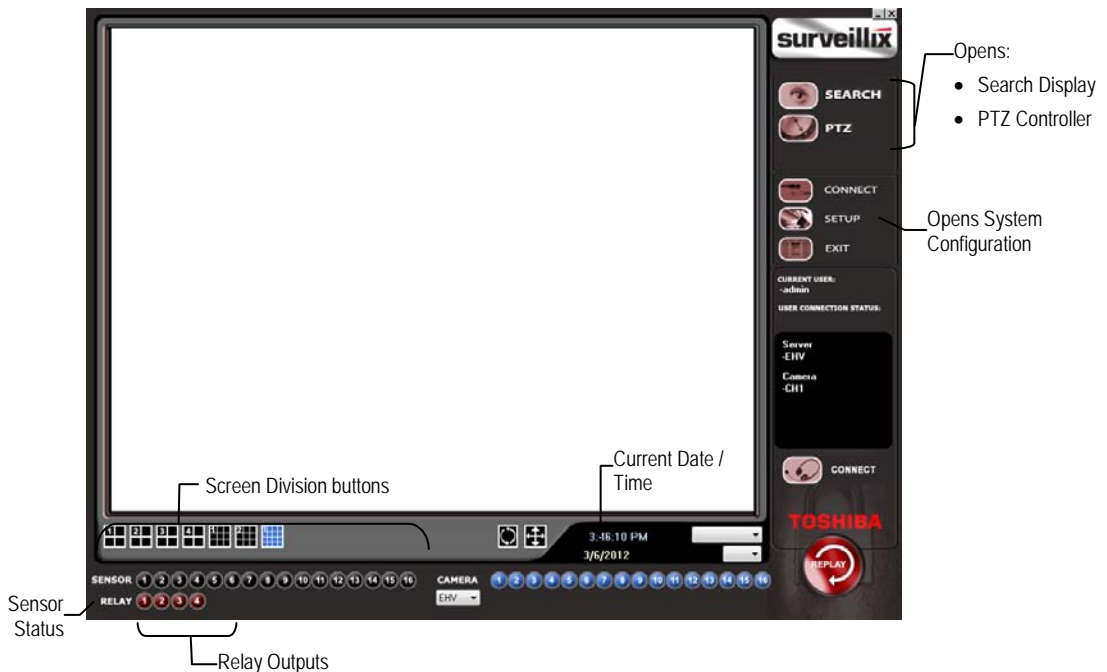



Camera View

The Camera status for each camera is displayed on the upper right corner of the video display area.



Recording Status Indicator

The following are the different states for each camera:

- | | | |
|---|-------------------------|--|
|  | Recording | Displayed when the camera is currently being recorded to the DVR. |
|  | Motion Detection | Displayed when a camera (set up for motion detection) detects motion. |
|  | Display | Displayed when the video from the camera is currently not being recorded to the DVR. |

Screen Division Buttons

The Screen Division buttons allow you to view cameras in groups such as two by two, three by three and four by four. The button options are shown below.



1st Four Cameras View – Displays cameras 1-4 in the Video Display Area. To return to a different Multi-Camera View, select a different Screen Division option from the Screen Division Menu.



2nd Four Cameras View – Displays cameras 5-8 in the Video Display Area. To return to a different Multi-Camera View, select a different Screen Division option from the Screen Division Menu.



3rd Four Cameras View – Displays cameras 9-12 in the Video Display Area. To return to a different Multi-Camera View, select a different Screen Division option from the Screen Division Menu.



4th Four Cameras View – Displays cameras 13-16 in the Video Display Area. To return to a different Multi-Camera View, select a different Screen Division option from the Screen Division Menu.



16 Camera View – Displays cameras 1-16 in the Video Display Area. To return to a different Multi-Camera View, select a different Screen Division option from the Screen Division Menu.



Full Screen – The Full Screen Option allows you to view the Video Display Area using the entire viewable area on the monitor. When this is selected, no menu options are visible. You can activate the Full Screen Option by clicking Full Screen within the Screen Division Menu. You can deactivate Full Screen mode by right-clicking on the screen.



Auto Sequence – Sequences through the Screen Divisions sets. For example, selecting the 1A and then the Loop button will sequence through 1A, 2A, 3A, 4A and then repeat.

Setup Overview

Remote users can view live video, search and access the System, Camera, Record, Network and Quick Setup Configuration options.

For details on how to configure the DVR using the setup options, refer to the Setup chapter in this document.

Search Overview

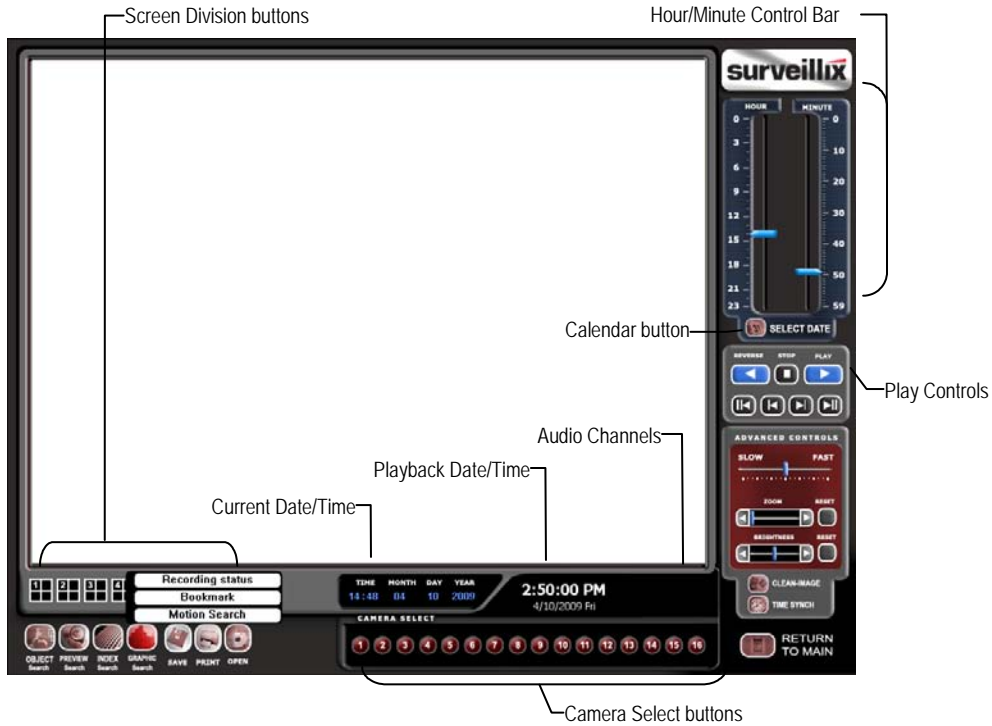

Play Controls

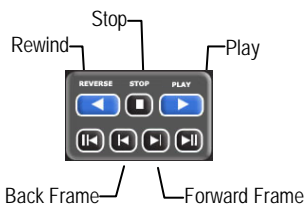

Back Frame	Moves video back one frame
Rewind	Rewinds video
Stop	Stops video playback
Play	Plays video
Forward Frame	Moves video forward one frame

Performing a Basic Search

1. Select a date using the Calendar button on the Date Display.
2. Select a time using the hour and minute control bars.
3. Select one or more cameras.
4. Click Play. (Video can be played forwards, backwards, or frame-by-frame.)

Adjust the Brightness of an Image

1. Pause the video and select an image to adjust by double-clicking the desired image. (Multiple images cannot be adjusted at one time.)
2. Move the Bright slider bar to the right or left to adjust the brightness.
3. Reset the Brightness by moving the slider back to the center of the bar.

Zooming in on an Image

1. Pause the video and select an image to adjust by double-clicking on the desired image. (Multiple images cannot be adjusted at one time.)
2. Move the Zoom slider bar to the right or left to zoom in or out of an image.
3. Reset the Zoom by moving the slider back to its original position on the bar.

Zooming in on a Portion of an Image

1. Using the mouse pointer, point to the area of interest on the image and click the right mouse button.
2. Keep clicking the right mouse button to zoom in further.
3. Continue clicking the right mouse button and the image zoom will cycle back to the original size.

Printing an Image

1. Using the Search screen, locate a frame to print and double-click the image.

Note Only one camera can be selected at a time for this function to work.

2. Click the Print button. (A Print Preview window appears. Depending on the printer being used, there may be several printing options available. Refer to the printer manual for more information.)
3. Click the Page Option button to add a memo to the printout and set the paper size and orientation.
4. Click the Print button to print the selected images.

Note The message "NO DEFAULT PRINTERS INSTALLED" will display if no printer is installed.

Save Clip

The DVR can export single images in the JPG file format, save video clips in the AVI format, or output to a VCR using the s-video port. The JPG and AVI file formats are extremely common with universal computer support making them ideal formats to use. A digital signature is also attached to every JPG and AVI file exported by the DVR for use with the bundled Digital Verifier application. This function is unique to the DVR and its verification software and should not interfere with viewing the files using other applications.

JPG

The format (JPG) is optimized for compressing full-color or grayscale photographic images. JPG images are 24-bit (16.7 million color) graphics. JPG is used to export a single image or frame.

AVI

AVI image data can be stored uncompressed, but it is typically compressed using a Windows-supplied or third party compression and decompression module called a codec. AVI files save a video clip.

Saving a Video Clip

1. Perform a basic search to locate the desired clip.
2. Click **Save** to open the **Export Wizard**.
3. Click **JPEG** or **AVI** to select the desired file type.

AVI File

- a) Select **Mark Digital Signature**.
- b) Select a **Compression Codec**. Each codec provides different levels of quality, compatibility and file-size.
- c) Enter the duration (seconds) to record. Although 50 is the longest time displayed, a longer recording may be entered manually.

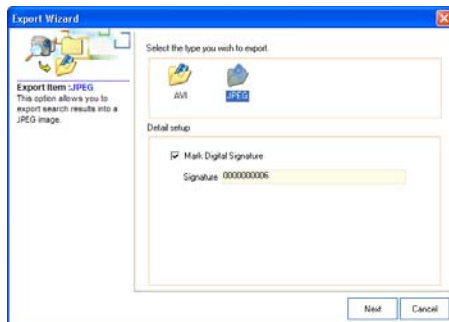

- d) Select **Quality - 50>100**. When size is not an issue, set quality to 100.

JPEG File

- Select Mark Digital Signature.
4. Click **Next**.

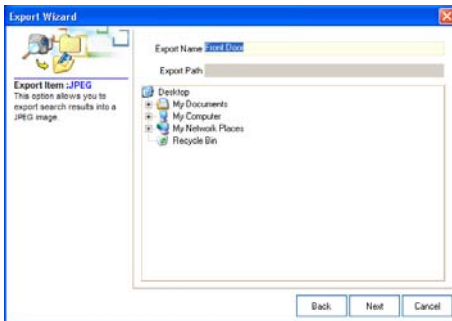

5. Define the file name in the **Export Name** box.
6. Define the location to save the file by using menu tree below **Export Path**.
7. Click **Next**.
8. A message displays to confirm that the save was successful.
9. Click **OK**. The Export Wizard will display the name, location and size of the file.
10. Click **Finish**.

Graphic Search

The Graphic Search option displays a timeline in graph format. Scroll through multiple cameras and easily locate hours with recorded video.

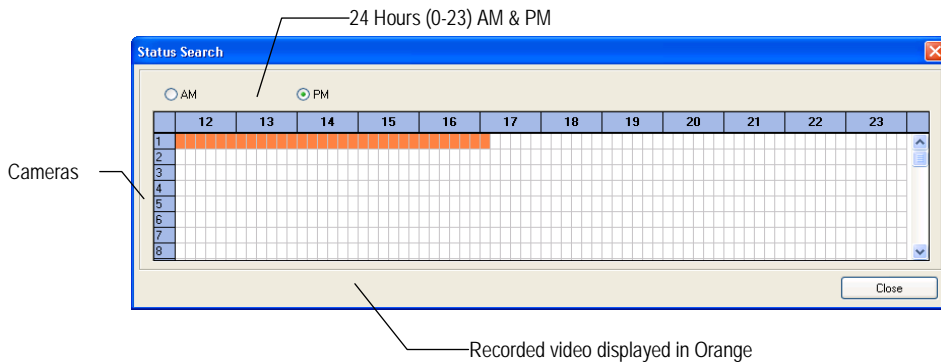

Performing a Graphic Search

1. In Search mode, click the Date button to open the calendar and select a date.
2. Click **Graphic Search**.
3. Click along the orange recorded video block to select a desired camera or time frame.
4. After locating the desired video, close the Status Search window and use the playback controls to play forward, reverse or frame-by-frame.

PTZ Overview

Accessing PTZ Menus

Some protocols support the ability to access the Internal PTZ Onscreen Menu. Click PTZ on the remote software Live View screen to open the graphical PTZ controller.

Since every PTZ camera is different, the functions of these options can vary slightly.

The DVR provides an easy way to access the cameras options. For explanations of what those options are please refer to the manual that came with the camera.

Note Use the arrow buttons on the PTZ controller move through the PTZ Menu options and/or highlight options.

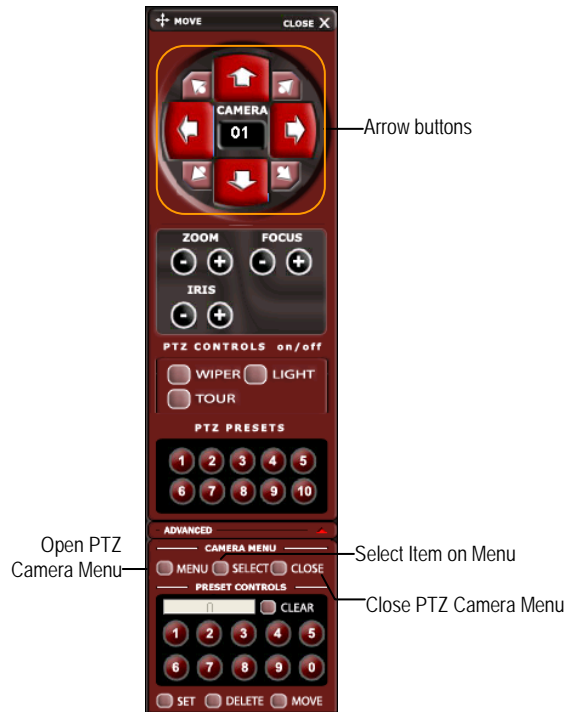

Controlling a PTZ Camera

- The first method is to use the graphical PTZ Controller that appears when PTZ is clicked on the Live View screen.
- The second method is to use the mouse to control the camera directly from the live video display.

Using the Graphical PTZ Controller

- Use the Arrow buttons to control the direction of the PTZ camera.
- To select a new camera, click the video display of a different camera on the Live View screen.

Note Eight directions are available only for select protocols. Only four of the PTZ Control buttons work for all protocols (UP, DOWN, LEFT, RIGHT).

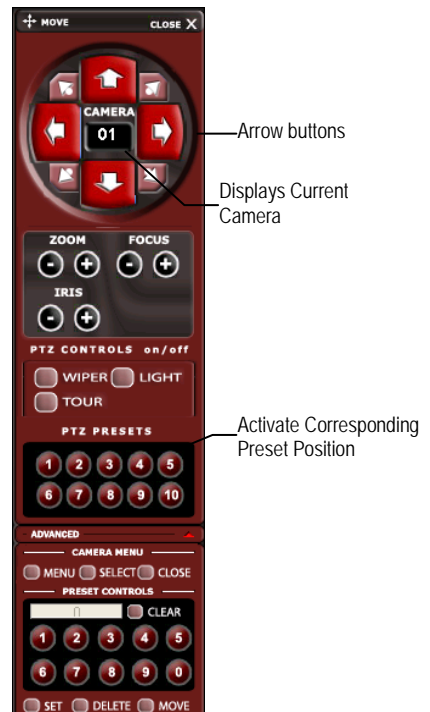

Using the On-screen Compass



1. Click PTZ on the Live View screen.
2. Control the PTZ by dragging the mouse on the screen in the desired direction.
3. A green line will appear to show the direction the PTZ will move. The shorter the line the less the PTZ will move. The longer the line the more the PTZ will travel in the specified direction.

WEB VIEWER OVERVIEW

The DVR allows access to the video using Microsoft® Internet Explorer® browser 6+.

To log in to the DVR server from the Web Viewer, a user account must be made for the user. This ensures that only authorized users are allowed to log in. In addition, each user can be assigned different privileges that allow or deny access to different functions.

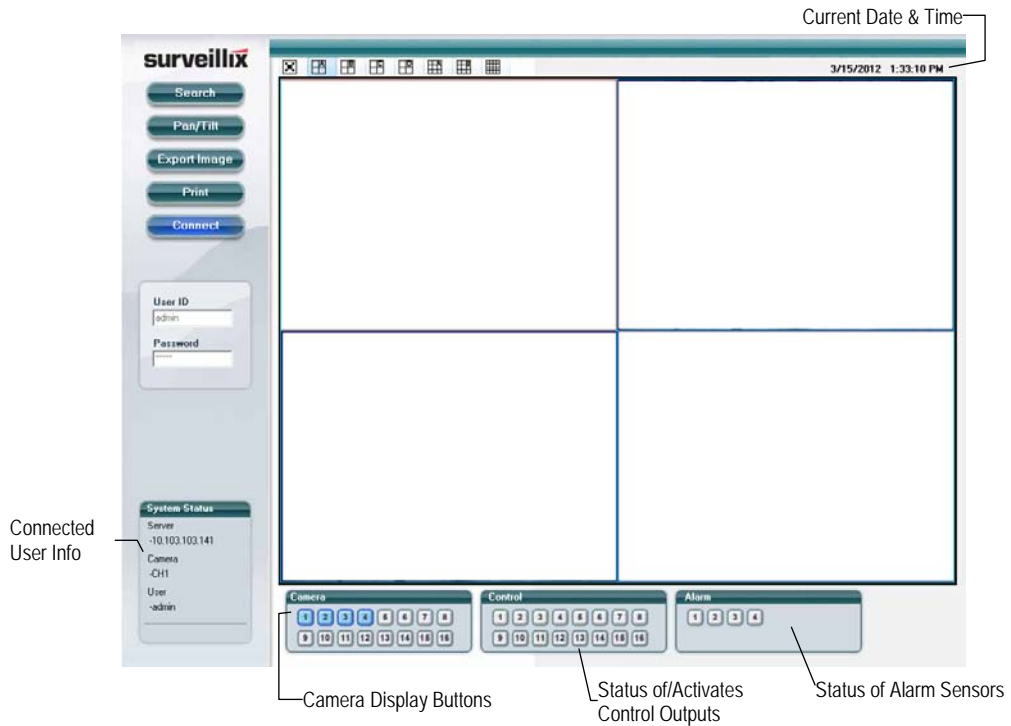

Search - Open the Search screen.

PAN/TILT - Open the PTZ controller.

Export Image - Save JPG file of selected image.

Print - Print selected image on connected printer.

Connect - Connect to a DVR.

Connecting to a DVR Using Web Viewer

1. Open Microsoft Internet Explorer.
2. Type the IP address of the DVR into the Address bar.
3. When attempting this for the first time you will be asked to accept an Active X installation. Click **Yes**.

Note If you receive a message saying Internet Explorer security settings do not allow you to download Active X components then you will need to adjust the browser security settings. Add the IP address of the DVR to the trusted sites list inside Internet Explorer settings. Contact the System administrator for additional help with adjusting Internet Explorer settings.

4. Type the **User ID** and **Password** of an authorized user.
5. Click **Connect**. The cameras will display.

Search Video Using Web Viewer

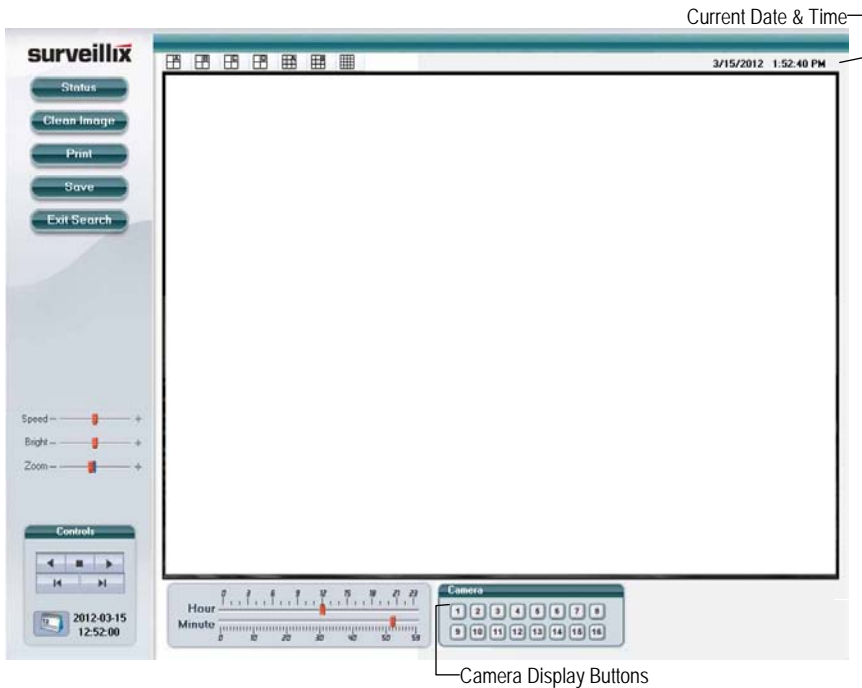

Performing a Basic Search

1. Click **Select Date** to open the calendar and select a date.
2. Select a time using the hour and minute control bars.
3. Select one or more cameras.
4. Click **Play**. Video can be played forwards, backwards, or frame-by-frame.

Status Search

The Status Search option displays a timeline in graph format. Scroll through multiple cameras and easily locate hours with recorded video.

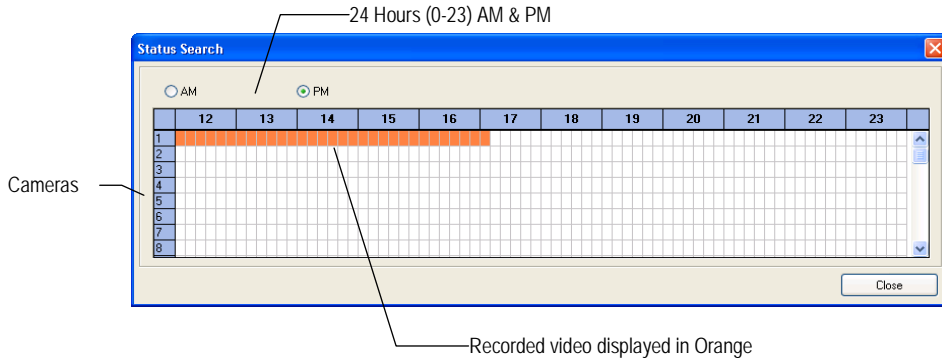

Performing a Status Search

1. Click **Search**, and then click **Status**.
2. Click **Select Date** to open the calendar and select a date.
3. Click along the orange recorded video block to select a desired camera or time frame.
4. After locating the desired video, close the **Status Search** window and use the playback controls to play forward, reverse or frame-by-frame.

Clean Image

The DVR can record video using one of three different resolutions. When using the 704 x 480 resolution, two fields are mixed. Because of the timing gap between the two fields, according to the standardized image rules, after image might occur to high speed moving images.

- Click **Search**, and then click **Clean Image** to remove the after image.

Print

1. Use **Search** to locate the desired frame. Double-click the image.

Note Only one camera can be selected at a time for this function to work.

2. Click **Print**. The **Print Options** window opens. Depending on the printer being used, there may be several printing options available. Refer to the printer manual for more information.
3. Click **Print** to print the selected images.

Note The message "NO DEFAULT PRINTERS INSTALLED" will display if no printer is installed.

Save

The EHV can export single images in the Image file formats and save video clips in an .AVI format. Both .JPG and .AVI file formats are the most commonly used graphical formats today. Virtually every computer offers some type of support for these file formats which make them the most ideal formats to use.

JPEG – Optimized for compressing full-color or grayscale photographic images, JPEG images are 24-bit (16.7 million color) graphics. Use JPEG to export a single image or frame.

AVI – AVI image data can be stored uncompressed, but it is typically compressed using a Windows-supplied or third party compression and decompression module called a codec. AVI is used to export a video clip.

1. From the Search screen, click **Save**.
2. Select the export type, JPEG or AVI.

Note Different image format types provide different file-sizes, quality and compatibility

3. Select **Mark Digital Signature** if desired.

AVI File

- a) Select a compression Codec. Each codec provides different levels of quality, compatibility and file-size.
 - b) Enter the **Time to Save** (seconds) to record. Although 50 is the longest time displayed, a longer recording may be entered manually.
 - c) Select **Quality** - 50>100. When size is not an issue, set quality to 100.
4. Click **Next** to select a save location to save file.
 5. Click **Next** to start exporting the file. The **Cancel** button exits the window without exporting file.

ALARM MONITOR

The Alarm Monitor is used to view emergency alarms from the connected DVRs, including Video Signal Loss and Sensor alarms. Use the Filter Options to filter through the different types of alarms. After viewing event video, include a memo for future searches.

Double-click an alarm entry to open the search window with the associated DVR, camera, and time related to the event already selected.

Note If all Alarm Event results are not visible, click **Off** to turn the Filter Options off.

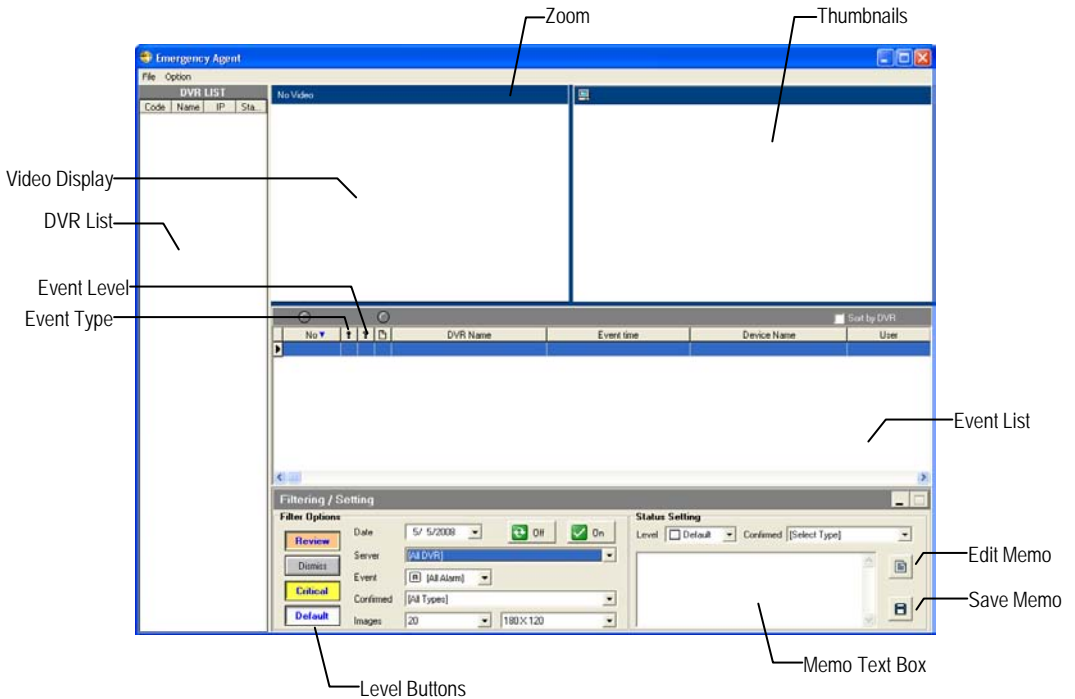

Assign Status Settings

1. Select an **Alarm Event** from the list.
2. Right-click the event and select a status level: Default, Review, Dismiss, Critical.
3. Select a defined **Alarm Confirmed Type** from the list under **Status Setting**.
4. Type a memo in the Memo box and then click the memo button.

Connecting to a DVR using Alarm Monitor

1. Press **SETUP** on the front of the EHV DVR.
2. Go to **RECORD > MOTION/EVENT CONFIGURATION > ALARM MONITOR**.
3. Set **SEND TO ALARM MONITOR** to **ON**.
4. Define the types of alarms to send to the Alarm Monitor software (MOTION, SENSOR, MOTION+SENSOR).
5. Enter the IP Address of the computer running the Alarm Monitor software.
6. Note the Port setting.

Note The Alarm Monitor uses one port to transfer the data through. The port can be adjusted inside the Network settings if necessary. It is recommended that the default setting should be used unless the port must be changed.

7. Create a schedule for the appropriate sensors and cameras.

Set up Alarm Monitor Options

1. From the **Option** menu, click **Setup**.
2. Enter the **Network Port** number. This port is located on the Alarm Monitor page on the HRDP EHV DVR. **RECORD > MOTION/EVENT CONFIGURATION > ALARM MONITOR**
3. Select **Show Popup Messenger** if desired.
4. Select a sound option for alarm events.
5. Add items to the **Alarm Confirm List**.
6. Click **OK** to save changes and close the window.

Add Items to Alarm Confirm List

1. Type the desired text in the box below the Alarm confirm list.

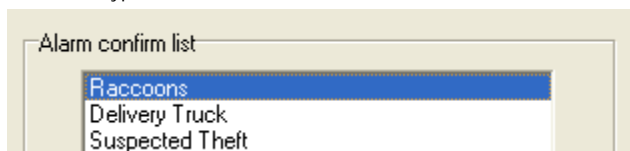

Note The items in the Alarm Confirm List will be available on a list under Status Setting in the Alarm Monitor window.

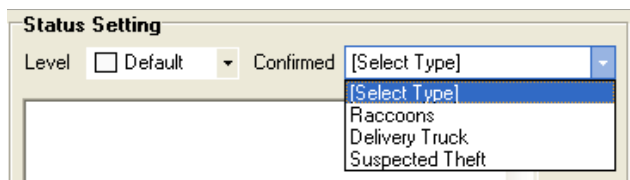

2. Click Add.
3. Click OK to save changes and close the window.

Filter Alarm Events

1. Select one or more **Status Level** buttons.
2. Select a date.
3. Select a DVR from the **Server** list.
4. Select the type of alarm event or select **All Events**.
5. Select **Normal** or **Emergency Alarm** or select **All Alarms**.
6. Select a **Confirmed** type.
7. Select the number and size of the thumbnail results.
8. Click **On** to filter results.

Search Alarm Window

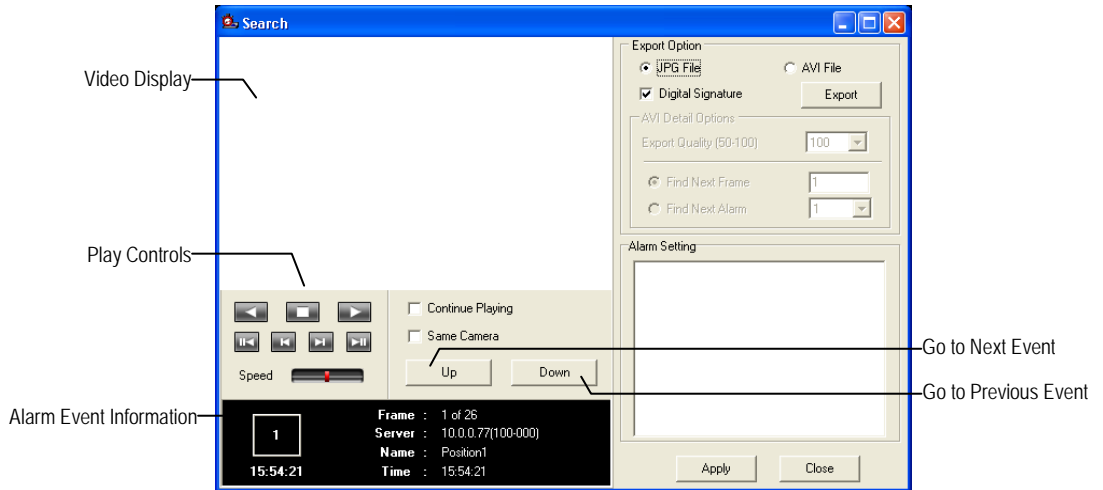

View Recorded Video

1. Double-click an event listing to open the **Search Alarm** window.
2. Use the play controls to locate the desired video frame.
3. Select the **Continue Playing** check box to watch all recorded events. When not selected, playback stops at the end of the alarm event.
4. Select the **Same Camera** check box to watch all events recorded by a single camera.
5. Click **Apply** after making any changes.

Export Video

1. Double-click an event listing to open the **Search Alarm** window.
2. Use the play controls to locate the desired video frame.
3. Click rewind to return to the beginning or desired spot in the video.
4. Click the stop button.
5. Select the **Export Type** – JPG or AVI.

Save JPG

- a) Select the **Digital Signature Text** check box to print the digital signature on the JPG file and then click **Next**.
- b) Click **Save As** to define the save location and then click **Next**.
- c) Click **Start** to save the image.

Save AVI

- a) Select a CODEC from the list and the number of frames to include in the AVI file. Reduce **Export Quality** only if necessary to reduce the size of the file.
 - b) Click **Next**.
 - c) Click **Save As** to define the save location and then click **Next**.
6. Click **Start** to save the video file.

DIGITAL VERIFIER OVERVIEW

JPG images and AVI video files that are exported from the Digital Video Recorder are automatically embedded with a digital signature. Digital signatures are a way to verify the authenticity of the images to ensure that they have not been tampered with or edited in any way. Included on the Software Installation DVD, supplied with the DVR, is the Digital Signature Verification program. This program can be installed on any Windows XP, Windows Vista, or Windows 7 computer.

Using the Digital Verifier

1. Open the Digital Verification program by selecting Start > Programs > Surveillix > Digital Signature Verifier > Surveillix Digital Signature Verifier.
2. Click the Browse button to load the JPG image.
3. Enter the **Site Code** of the DVR that the image was originally extracted from. (The Site Code is specified in the **System Configuration** menu).
4. Click **Verify** to continue or **Close** to close the window without verifying.

If the image has not been tampered with, a blue square will appear around the image with the message "Original image file."

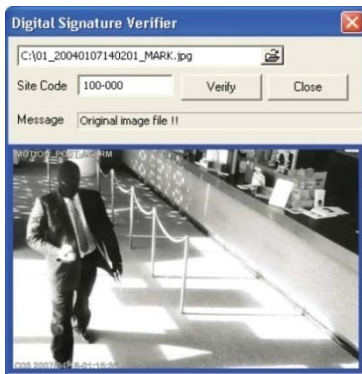

If the image has been tampered with, a red square will appear around the image with the message "Entire image changed or wrong SITE CODE."



SCS MULTI-SITE MANAGEMENT SOFTWARE

Connecting to a DVR using SCS

SCS software is Multi-Site Management Software; a powerful utility that allows 100 or more DVRs to be controlled using one computer. This software allows you to view live video, search saved video, edit and configure setup on each DVR, and import maps of buildings and other locations.

1. Configure the DVR for remote access as shown in this manual in Set up a Remote Connection.
2. Follow the instructions in the SCS manual for Adding a New Site.

APPENDIX

BUTTON INDEX

Enter / Exit Buttons



Enter Input data, and make selections.



Esc Return to the previous mode or menu, without saving.

Function Buttons



Setup Open the system setup menu.



Search Open the Search Menu.



Display Change the display mode. Display switches in the following order when the DISPLAY key is pressed successively: (Single > 4 > 9 > 16 > PIP).



Backup Opens the Export menu.



Sequence Starts the sequence function



Replay Starts playing last recorded video (10sec from current time).



Power Press and hold to shutdown or turn on the recorder.

Directional and Playback Control Buttons



PTZ Move the camera view point up.



PTZ Move the camera view point to the right.

Search Play recorded videos. When pressed successively, the search jumps forward in time by 30 minute increments.

Search-Pause Step forward one frame.



PTZ Move the camera view point up.



PTZ Move the camera view point to the left.

Search Play recorded videos in reverse. When pressed successively, the search jumps back in time by 30 minute increments.

Search-Pause Step backward one frame.



Play/Pause Start playback or pause recorded video.

DVR FAQ

General

Q. What does Embedded Linux mean?

A. Embedded Linux means that the operating system of the DVR has been imprinted into the CPU (Central Processing Unit). This means that the system response time is faster, more stable, and that the core of the DVR is protected against external factors, such as virus.

Q. Is the DVR upgradeable by USB or network?

A. Yes. You can update the firmware using a removable USB stick or over remotely over the network.

Q. How can I reset the DVR to the factory default settings?

A. Load the factory default settings from the System Configuration Menu.

Live Monitoring

Q. Is it possible to monitor the live video of specific cameras?

A. You can set the camera sequence through Spot/Sequence Configuration or by connecting to the spot monitor output on the rear of the DVR unit.

Recording

Q. How do you record?

A. For information on this topic view the Recording Configuration section of this manual.

Q. What is Time Recording?

A. Time recording is recording scheduled to occur regardless of whether a motion or alarm event occurs.

Q. What is Event Recording?

A. Event Recording is recording which is activated when an event (motion or alarm) occurs.

Searching and Playing Video

Q. How do I play back recorded video?

A. For more information on this topic, see the Search section of this manual.

Q. Is it possible to back up recorded video?

A. Yes, for more information on this topic see the Backup section of this manual.

Backup

Q. Is it possible to back up to DVD media?

A. Yes, if you use an external USB connected DVD writer.

Q. Can I back up to a USB memory stick?

A. Yes, for more information on this topic view the Backup section of this manual.

Network

Q. Does it support dynamic IP?

A. Yes. Enable DHCP in Network Configuration.

Q. Mail is not sent out.

A. Please check all the settings in the Network E-Mail Configuration.

Miscellaneous

Q. What types of cameras can be used?

A. The EHV DVR supports either NTSC or PAL analog cameras. Both standards may not be used simultaneously.

TROUBLESHOOTING

Problem	Possible Solutions.
No Power	Check the power cord connections. Check power at the outlet.
No Live Video	Check camera video cable and connections. Check monitor video cable and connections. Check camera power. Check camera lens setting .
Live Video Too Bright	If a cable is attached to the video channels looping output, make sure that it is properly terminated.
DVR has stopped recording	The HDD is full, delete video or set the DVR Overwrite Mode to On in Disk Configuration > Overwrite.

Free Manuals Download Website

<http://myh66.com>

<http://usermanuals.us>

<http://www.somanuals.com>

<http://www.4manuals.cc>

<http://www.manual-lib.com>

<http://www.404manual.com>

<http://www.luxmanual.com>

<http://aubethermostatmanual.com>

Golf course search by state

<http://golfingnear.com>

Email search by domain

<http://emailbydomain.com>

Auto manuals search

<http://auto.somanuals.com>

TV manuals search

<http://tv.somanuals.com>