

TOSHIBA

Leading Innovation >>>

User's Guide

THRiVE™

If you need assistance:

- ❖ Toshiba's Support Web site
tabletsupport.toshiba.com
- ❖ Toshiba Customer Support Center
Calling within the United States (800) 457-7777
Calling from outside the United States (949) 859-4273

For more information, see “If Something Goes Wrong” on [page 105](#) in this guide.

▲ WARNING

Handling the cord on this product will expose you to lead, a chemical known to the State of California to cause birth defects or other reproductive harm. ***Wash hands after handling.***

Model: AT100 Series

Regulatory Information

Protection of Stored Data

For your important data, please make periodic back-up copies of all the data stored on the hard disk or other storage devices as a precaution against possible failures, alteration, or loss of the data. **IF YOUR DATA IS ALTERED OR LOST DUE TO ANY TROUBLE, FAILURE OR MALFUNCTION OF THE HARD DISK DRIVE OR OTHER STORAGE DEVICES AND THE DATA CANNOT BE RECOVERED, TOSHIBA SHALL NOT BE LIABLE FOR ANY DAMAGE OR LOSS OF DATA, OR ANY OTHER DAMAGE RESULTING THEREFROM. WHEN COPYING OR TRANSFERRING YOUR DATA, PLEASE BE SURE TO CONFIRM WHETHER THE DATA HAS BEEN SUCCESSFULLY COPIED OR TRANSFERRED. TOSHIBA DISCLAIMS ANY LIABILITY FOR THE FAILURE TO COPY OR TRANSFER THE DATA CORRECTLY.**

Critical Applications

The device you have purchased is not designed for any “critical applications.” “Critical applications” means life support systems, medical applications, connections to implanted medical devices, commercial transportation, nuclear facilities or systems or any other applications where product failure could lead to injury to persons or loss of life or catastrophic property damage.

ACCORDINGLY, TOSHIBA, ITS AFFILIATES AND SUPPLIERS DISCLAIM ANY AND ALL LIABILITY ARISING OUT OF THE USE OF THE DEVICE PRODUCTS IN ANY CRITICAL APPLICATIONS. IF YOU USE THE DEVICE PRODUCTS IN A CRITICAL APPLICATION, YOU, AND NOT TOSHIBA, ASSUME FULL RESPONSIBILITY FOR SUCH USE.

Radio Frequency (RF) Energy Exposure

When the transmitter and receiver on your device is powered ON, RF energy is received and transmitted. The power level your device transmits at is controlled by your network access while in communication.

Your device is approved to the radio standard by the country/region listed in the approved countries table for the module installed in your device.

FCC Notice “Declaration of Conformity Information”

This equipment has been tested and found to comply with the limits for a Class B digital device, pursuant to Part 15 of the FCC rules. These limits are designed to provide reasonable protection against harmful interference in a residential installation.

This equipment generates, uses and can radiate radio frequency energy and, if not installed and used in accordance with the instructions, it may cause harmful interference to radio communications. However, there is no guarantee that interference will not occur in a particular installation. If this equipment does cause harmful interference to radio or television reception, which can be determined by turning the equipment off and on, the user is encouraged to try to correct the interference by one or more of the following measures:

- ❖ Reorient or relocate the receiving antenna.
- ❖ Increase the separation between the equipment and receiver.
- ❖ Connect the equipment to an outlet on a circuit different from that to which the receiver is connected.
- ❖ Consult the dealer or an experienced radio/TV technician for help.

NOTE

Only Peripherals complying with the FCC Class B limits may be attached to this equipment. Operation with noncompliant peripherals or peripherals not recommended by Toshiba is likely to result in interference to radio and TV reception. Shielded cables must be used between the external devices and the device's ports. Changes or modifications made to this equipment not expressly approved by Toshiba or parties authorized by Toshiba could void the user's authority to operate the equipment.

This device complies with Part 15 of the FCC Rules. Operation is subject to the following two conditions:

- ❖ This device may not cause harmful interference.
- ❖ This device must accept any interference received, including interference that may cause undesired operation.

Contact either:

- ❖ Toshiba's Support Web site at tabletsupport.toshiba.com.

-
- ❖ Or call the Toshiba Customer Support Center:
Within the United States at (800) 457-7777
Outside the United States at (949) 859-4273

Industry Canada Requirement

This Class B digital apparatus complies with Canadian ICES-003.

Cet appareil numérique de la classe B est conforme à la norme NMB-003 du Canada.

Wireless Interoperability

The Toshiba Wireless LAN Card products are designed to be interoperable with any wireless LAN product that is based on Direct Sequence Spread Spectrum (DSSS) radio technology, and is compliant to:

- ❖ The IEEE 802.11 Standard on Wireless LANs (Revision A/B/G), as defined and approved by the Institute of Electrical and Electronics Engineers.
- ❖ The Wireless Fidelity (Wi-Fi[®]) certification as defined by the Wi-Fi Alliance. The “Wi-Fi CERTIFIED” logo is a certification mark of the Wi-Fi Alliance.

CAUTION

Bluetooth[®] and Wireless LAN devices operate within the same radio frequency range and may interfere with one another. If you use *Bluetooth*[®] and Wireless LAN devices simultaneously, you may occasionally experience a less than optimal network performance or even lose your network connection.

If you should experience any such problem, immediately turn off your *Bluetooth*[®] or Wireless LAN device.

Please contact Toshiba product support on Web site <http://www.toshiba-europe.com/computers/tnt/bluetooth.htm> in Europe or tabletsupport.toshiba.com in the United States for more information.

Wireless LAN and Your Health

Wireless LAN products, like other radio devices, emit radio frequency electromagnetic energy. The level of energy emitted by Wireless LAN devices however is far much less than the electromagnetic energy emitted by wireless devices like for example mobile phones.

Because Wireless LAN products operate within the guidelines found in radio frequency safety standards and recommendations, Toshiba believes Wireless LAN is safe for use by consumers. These standards and recommendations reflect the consensus of the scientific community and result from deliberations of panels

and committees of scientists who continually review and interpret the extensive research literature.

In some situations or environments, the use of Wireless LAN may be restricted by the proprietor of the building or responsible representatives of the organization. These situations may for example include:

- ❖ Using the Wireless LAN equipment on board airplanes, or
- ❖ In any other environment where the risk of interference to other devices or services is perceived or identified as harmful.

If you are uncertain of the policy that applies on the use of wireless devices in a specific organization or environment (e.g. airports), you are encouraged to ask for authorization to use the Wireless LAN device prior to turning on the equipment.

CAUTION

Exposure to Radio Frequency Radiation

The radiated output power of the Toshiba Wireless LAN Card is far below the FCC radio frequency exposure limits. Nevertheless, the Toshiba Wireless LAN Card shall be used in such a manner that the potential for human contact during normal operation is minimized. The antenna(s) used for this transmitter must not be co-located or operating in conjunction with any other antenna or transmitter.

Specific Absorption Rate (IEEE)

Your device is designed to be in compliance with Radio Waves exposure regulations and does not exceed the limits for exposure to radio waves (radio frequency electromagnetic fields) in accordance with the Federal Trade Communications Commission (FCC) and Industry Canada (IC). A substantial safety margin is set to assure the safety of all persons, regardless of health.

A unit of measurement known as the Specific Absorption rate, or SAR is utilized for the radio wave exposure guidelines. The SAR measurement for devices does not exceed 1.6W/kg.

The actual SAR values for your device, while in use, are normally well below the stated values. The operating power of your device is automatically decreased when full power is not needed for the wireless connection to increase system efficiency and to minimize interference on the network. The lower the power output of the device the lower its SAR value.

As stated by the World Health Organization, present scientific information indicates no special precautions are needed for the use of this device. To further reduce any exposure, limit your usage.

⚠ WARNING**Turn Wi-Fi®, Bluetooth®, and Wireless WAN Functionalities off for Cardiac Pacemakers**

- ❖ Turn Wi-Fi®, Bluetooth®, and Wireless WAN functionality off when you are near a person who may have a cardiac pacemaker implant or other medical electric device. Radio waves may affect pacemaker or medical device operation, possibly resulting in serious injury. Follow the instructions of your medical device when using any Wi-Fi® or Bluetooth® or Wireless WAN functionally.

Regulatory Information

This device complies with the following radio frequency and safety standards.

Canada – Industry Canada (IC)

This device complies with RSS 210 of Industry Canada.

CAUTION

The installer of this radio equipment must ensure that the antenna is located or pointed such that it does not emit RF field in excess of Health Canada limits for the general population; consult Safety Code 6, obtainable from Health Canada's Web site www.hc-sc.gc.ca/rpb. The RF device shall not be co-located with any other transmitter that has not been tested with this device.

Operation is subject to the following two conditions: (1) this device may not cause interference, and (2) this device must accept any interference, including interference that may cause undesired operation of this device.

L' utilisation de ce dispositif est soumise aux deux conditions suivantes: (1) il ne doit pas produire de brouillage et (2) l'utilisateur du dispositif doit être prêt à accepter tout brouillage radioélectrique reçu, même s'il est susceptible de compromettre son fonctionnement.

The term "IC" before the equipment certification number only signifies that the Industry Canada technical specifications were met.

To prevent radio interference to the licensed service, this device is intended to be operated indoors and away from windows to provide maximum shielding. Equipment (or its transmit antenna) that is installed outdoors is subject to licensing.

Pour empêcher que cet appareil cause du brouillage au service faisant l'objet d'une licence, il doit être utilisé à l'intérieur et devrait être placé loin des fenêtres afin de fournir un écran de blindage maximal. Si le matériel (ou son antenne d'émission) est installé à l'extérieur, il doit faire l'objet d'une licence.

Radio Approvals for Wireless Devices

Approved Countries/Regions for the Broadcom® Wireless Wi-Fi® AW-NH931 Series

This equipment is approved to the radio standard by the countries/regions in the following table.

CAUTION

Do not use this equipment except in the countries/regions in the following table.

Australia	Austria	Bangladesh
Belgium	Bolivia	Bulgaria
Canada	Colombia	Cyprus
Czech Republic	Denmark	Dominican Republic
El Salvador	Estonia	Finland
France	Germany	Greece
Guatemala	Hong Kong	Hungary
Iceland	Ireland	Italy
Japan	Latvia	Liechtenstein
Lithuania	Luxembourg	Malta
Monaco	Netherlands	New Zealand
Norway	Panama	Poland
Portugal	Puerto Rico	Romania
Saudi Arabia	Slovak Republic	Slovenia
Spain	Sri Lanka	Sweden
Switzerland	Taiwan	Turkey
United Kingdom	USA	

Europe - Restrictions for use of 2.4 GHz Frequencies in European Community Countries

België/ Belgique:	For private usage outside buildings across public grounds over less than 300m no special registration with IBPT/BIPT is required. Registration to IBPT/BIPT is required for private usage outside buildings across public grounds over more than 300m. For registration and license please contact IBPT/BIPT.
	Voor privé-gebruik buiten gebouw over publieke grond over afstand kleiner dan 300m geen registratie bij BIPT/IBPT nodig; voor gebruik over afstand groter dan 300m is wel registratie bij BIPT/IBPT nodig. Voor registratie of licentie kunt u contact opnemen met BIPT.

	Dans le cas d'une utilisation privée, à l'extérieur d'un bâtiment, au-dessus d'un espace public, aucun enregistrement n'est nécessaire pour une distance de moins de 300m. Pour une distance supérieure à 300m un enregistrement auprès de l'IBPT est requise. Pour les enregistrements et licences, veuillez contacter l'IBPT.
Deutschland:	License required for outdoor installations. Check with reseller for procedure to follow.
	Anmeldung im Outdoor-Bereich notwendig, aber nicht genehmigungspflichtig. Bitte mit Händler die Vorgehensweise abstimmen.
France:	Restricted frequency band: only channels 1 to 7 (2400 MHz and 2454 MHz respectively) may be used outdoors in France. Please contact A.R.T. (http://www.art-telecom.fr) for applicable procedures to follow.
	Bande de fréquence restreinte: seuls les canaux 1- 7 (2400 et 2454 MHz respectivement) doivent être utilisés endroits extérieur en France. Vous pouvez contacter l'Autorité de Régulation des Télécommunications (http://www.art-telecom.fr) pour la procédure à suivre.
Italia:	License required for indoor use. Use with outdoor installations not allowed.
	È necessaria la concessione ministeriale anche per l'uso interno. Verificare con i rivenditori la procedura da seguire.
Nederland:	License required for outdoor installations. Check with reseller for procedure to follow.
	Licentie verplicht voor gebruik met buitenantennes. Neem contact op met verkoper voor juiste procedure.

Bluetooth® Wireless Technology Interoperability

Bluetooth® Cards from Toshiba are designed to be interoperable with any product with Bluetooth® wireless technology that is based on Frequency Hopping Spread Spectrum (FHSS) radio technology, and is compliant to:

- ❖ Bluetooth® Specification as defined and approved by The Bluetooth® Special Interest Group.

-
- ❖ Logo certification with *Bluetooth*[®] wireless technology as defined by The *Bluetooth*[®] Special Interest Group.
-

CAUTION

Always use *Bluetooth*[®] cards from Toshiba in order to enable wireless networks over two or more (up to a total of seven) Toshiba portable computers using these cards. Please contact Toshiba product support on Web site <http://www.toshiba-europe.com/computers/tnt/bluetooth.htm> in Europe or tabletsupport.toshiba.com in the United States for more information.

When you use *Bluetooth*[®] cards from Toshiba close to 2.4 GHz Wireless LAN devices, *Bluetooth*[®] transmissions might slow down or cause errors. If you detect certain interference while you use *Bluetooth*[®] cards from Toshiba, always change the frequency, move your device to the area outside of the interference range of 2.4 GHz Wireless LAN devices (40 meters/43.74 yards or more) or stop transmitting from your device. Please contact Toshiba product support on Web site <http://www.toshiba-europe.com/computers/tnt/bluetooth.htm> in Europe or tabletsupport.toshiba.com in the United States for more information.

Bluetooth[®] and Wireless LAN devices operate within the same radio frequency range and may interfere with one another. If you use *Bluetooth*[®] and Wireless LAN devices simultaneously, you may occasionally experience a less than optimal network performance or even lose your network connection. If you should experience any such problem, immediately turn off either one of your *Bluetooth*[®] or Wireless LAN. Please contact Toshiba product support on Web site <http://www.toshiba-europe.com/computers/tnt/bluetooth.htm> in Europe or tabletsupport.toshiba.com in the United States for more information.

Approved Countries/Regions for use (*Bluetooth*[®] wireless technology)

Bluetooth[®] Card from Toshiba equipment is approved to the radio standard by the countries/regions in the following table.

CAUTION

Do not use this equipment except in the countries/regions in the following table.

Australia	Austria	Bangladesh
Belgium	Bolivia	Bulgaria
Canada	Colombia	Cyprus
Czech Republic	Denmark	Dominican Republic
El Salvador	Estonia	Finland
France	Germany	Greece

Guatemala	Hong Kong	Hungary
Iceland	Ireland	Italy
Japan	Latvia	Liechtenstein
Lithuania	Luxembourg	Malta
Monaco	Netherlands	New Zealand
Norway	Panama	Poland
Portugal	Puerto Rico	Romania
Saudi Arabia	Slovak Republic	Slovenia
Spain	Sri Lanka	Sweden
Switzerland	Taiwan	Turkey
United Kingdom	USA	

Bluetooth® Wireless Technology and Your Health

The products with *Bluetooth*® wireless technology, like other radio devices, emit radio frequency electromagnetic energy. The level of energy emitted by devices with *Bluetooth*® wireless technology however is much less than the electromagnetic energy emitted by wireless devices such as mobile phones.

Because products with *Bluetooth*® wireless technology operate within the guidelines found in radio frequency safety standards and recommendations, Toshiba believes *Bluetooth*® wireless technology is safe for use by consumers. These standards and recommendations reflect the consensus of the scientific community and result from deliberations of panels and committees of scientists who continually review and interpret the extensive research literature.

In some situations or environments, the use of *Bluetooth*® wireless technology may be restricted by the proprietor of the building or responsible representatives of the organization. These situations may for example include:

- ❖ Using the equipment with *Bluetooth*® wireless technology on board airplanes, or
- ❖ In any other environment where the risk of interference to other devices or services is perceived or identified as harmful.

If you are uncertain of the policy that applies on the use of wireless devices in a specific organization or environment (e.g. airports), you are encouraged to ask for authorization to use the device with *Bluetooth*® wireless technology prior to turning on the equipment.

CAUTION

Exposure to Radio Frequency Radiation

The radiated output power of the *Bluetooth*® Card from Toshiba is far below the FCC radio frequency exposure limits. Nevertheless, the *Bluetooth*® Card from Toshiba shall be used in such a manner that the potential for human contact during normal operation is minimized.

Copyright

This guide is copyrighted by Toshiba America Information Systems, Inc. with all rights reserved. Under the copyright laws, this guide cannot be reproduced in any form without the prior written permission of Toshiba. No patent liability is assumed, however, with respect to the use of the information contained herein.

©2011 by Toshiba America Information Systems, Inc. All rights reserved.

Export Administration Regulation

This product and/or document contains technical data that may be controlled under the U.S. Export Administration Regulations, and may be subject to the approval of the U.S. Department of Commerce prior to export. Any export, directly or indirectly, in contravention of the U.S. Export Administration Regulations is prohibited.

Notice

While Toshiba has made every effort at the time of publication to ensure the accuracy of the information provided herein, product specifications, configurations, prices, system/component/options availability are all subject to change without notice. For the most up-to-date product information about your device, or to stay current with the various product software or hardware options, visit Toshiba's Web site at tabletsupport.toshiba.com. Toshiba assumes no liability for any damages incurred directly or indirectly from any errors or omissions contained herein. In no event shall Toshiba be liable for any incidental, consequential, special, or exemplary damages, whether based on tort, contract or otherwise, arising out of or in connection with this information or any other information contained herein or the use thereof.

Trademarks

App Place, Resolution+, and THRiVE are either trademarks or registered trademarks of Toshiba America Information Systems, Inc. and/or Toshiba Corporation.

Bluetooth word mark and logos are owned by the Bluetooth SIG, Inc. and any use of such marks by Toshiba is under license. Other trademarks and trade names are those of their respective owners.

Broadcom is a registered trademark of Broadcom Corporation and/or its affiliates in the United States, certain other countries, and/or the EU.

Google, the Google logo, Android, Android Market, Google Maps, Google eBooks, Gmail, YouTube, and Google Talk are trademarks of Google, Inc.

HDMI, the HDMI Logo and High-Definition Multimedia Interface are trademarks or registered trademarks of HDMI Licensing, LLC.

Microsoft is a registered trademarks of Microsoft Corporation in the United States and/or other countries.

Secure Digital and SD are trademarks of SD Card Association.

Wi-Fi is a registered trademark of the Wi-Fi Alliance.

All other brand and product names are trademarks or registered trademarks of their respective companies.

Product Disposal Information

Discard this device in accordance with applicable laws and regulations.

Disposal of this product may be regulated due to environmental considerations. For disposal, reuse or recycling information, please contact your local government or the Electronic Industries Alliance at www.eiae.org.

As part of Toshiba's commitment to preserving the environment, Toshiba supports various trade-in and recycling programs. For details, please visit us.toshiba.com/green.

Licenses

This Product is licensed under the AVC, the VC-1 and the MPEG-4 Part 2 Visual patent portfolio licenses for the personal and non-commercial use of a consumer to (i) encode video in compliance with the above standards ("Video Standards") and/or (ii) decode AVC, VC-1 and MPEG-4 Part 2 Visual that was encoded by a consumer engaged in personal and non-commercial activity or was obtained from a video provider licensed to provide such video. None of the licenses extend to any other product regardless of whether such product is included with this product in a single article. No license is granted or shall be implied for any other use. Additional information may be obtained from MPEG LA, LLC. See www.mpegla.com.

Contents

Introduction.....	18
This guide	19
Safety icons	19
Other icons used	20
Your device's features and specifications	20
Other documentation	20
Service options	21
Precautions	21
File management tips	22
Toshiba's online resources	22
Chapter 1: Getting Started.....	23
Features and components.....	23
Front	24
Back	25
Right side.....	26
Left side	27
Top	27
Bottom	28
Connecting to a power source	29

Charging the battery	31
Changing the battery	32
Removing the battery from the device	32
Inserting a charged battery	34
Taking care of your battery	36
Safety precautions	36
Optimizing battery life	36
Maintaining your battery	37
Disposing of used batteries	38
Using the device for the first time	39
Turning on the power	39
Setting up your device	40
Setting up your Wi-Fi® connection	40
Setting location preferences	41
Setting the date and time	41
Sign in to your Google™ Account	42
Setting up Wi-Fi® and Bluetooth® connections	44
Registering your Toshiba device	45
Backing up your data	45
Backing up data using TOSHIBA File Manager	45
Backing up data using your Google™ Account	45
Restoring your data using your Google™ Account	46
Navigation and features	47
Home screen	48
Touch screen navigation	49
Navigating the Home screen	50
System bar	50
Securing your tablet	53
Customizing your Home screens	55
Adding an item to a Home screen	55
Moving an item from the Home screen	56
Removing an item from a Home screen	56

Changing the wallpaper.....	56
Turning off the device	57
Options for turning off the device	57
Using Shut down mode	57
Using Sleep mode.....	58
Syncing and managing your accounts	59
Add an account	59
Remove an account	60
Navigation, Maps, Places, and Latitude.....	60
Managing downloads.....	61
Factory data reset	62
Caring for your device.....	63
Cleaning the device	63
Chapter 2: Settings	64
Customizing your device's settings.....	64
Apps and Settings menus	64
Wireless and networks settings	69
Sound settings.....	71
Screen settings	72
Multimedia settings	72
Location and security settings	73
Applications settings.....	75
Accounts & sync settings	76
Privacy settings	77
Storage settings.....	78
Language & input settings	78
Accessibility settings	81
Date & time settings	81
About tablet	82
Chapter 3: Working with Apps.....	84
Downloading Toshiba Apps	84
TOSHIBA Media Player	84
Apps	85
Downloading from Android Market™	85

Preinstalled Apps on your tablet	85
Uninstalling Apps on your tablet	86
Chapter 4: Exploring the Features on your Device.....	87
Using the onscreen keyboard.....	87
Type to enter text	88
Speak to enter text	90
Using the built-in speakers	90
Using external speakers or headphones.....	90
Recording sounds.....	91
Using the cameras	91
Using an SD™ Card.....	91
Inserting memory media	92
Removing memory media	92
Adding optional external devices.....	93
Using external devices	93
Connecting an HDMI™-compatible television or display device	94
Using an external keyboard.....	94
Using an external mouse	94
Using a docking station	95
Connecting your tablet to a docking station	95
Chapter 5: Utilities.....	97
TOSHIBA Service Station	98
Check for application updates	99
Downloading updates	99
Installing updates.....	100
Downloading and installing System updates	100
TOSHIBA File Manager Utility.....	101
File browsing screen	102
Operation of files/folders.....	102
TOSHIBA Adaptive display	104
TOSHIBA Resolution+®	104

Chapter 6: If Something Goes Wrong	105
Problems when you turn on the device	105
The operating system is not working	106
Internet problems	106
Power and the batteries	107
Display problems	108
Sound system problems	108
Wireless networking problems.....	109
If you need further assistance.....	109
Before you contact Toshiba	110
Contacting Toshiba	110
Other Toshiba Internet Web sites.....	111
Toshiba's worldwide offices.....	111
Appendix A: Power Cord/Cable Connectors.....	113
Glossary.....	114
Index.....	124

Introduction

Welcome to the world of powerful, portable, multimedia. With your Toshiba tablet device, you can watch movies, listen to your favorite music, read books, play games and do much more.

NOTE The product specifications and configuration information are designed for a product Series. Your particular model may not have all the features and specifications listed or illustrated. For more detailed information about the features and specifications on your particular model, please visit Toshiba's Web site at tabletsupport.toshiba.com.

While Toshiba has made every effort at the time of publication to ensure the accuracy of the information provided herein, product specifications, configurations, prices, system/component/options availability are all subject to change without notice. For the most up-to-date product information about your device, or to stay current with the various device software or hardware options, visit Toshiba's Web site at tabletsupport.toshiba.com.

This guide

This guide introduces the features on your device as well as some basic procedures needed to perform tasks on your tablet powered by Android™.

You can:

- ❖ Read the entire guide from beginning to end.
- ❖ Skim through and stop when a topic interests you.
- ❖ Use the table of contents and the index to find specific information.

Safety icons

All of the Safety instructions contained in this manual must be read carefully and be fully understood before you attempt to use this device, in order to avoid potential hazards that could cause bodily injury, property damage, or damage to the device.

- ❖ The Safety Instructions contained in this Manual have been categorized according to the seriousness of the potential hazards, through the use of the following signal words.

▲ DANGER Indicates an imminently hazardous situation which, if not avoided, will result in death or serious injury.

▲ WARNING Indicates a potentially hazardous situation which, if not avoided, could result in death or serious injury.

▲ CAUTION Indicates a potentially hazardous situation which, if not avoided, may result in minor or moderate injury.

CAUTION Indicates a potentially hazardous situation which, if not avoided, may result in property damage.

NOTE Provides important information.

Other icons used

Additional icons highlight other helpful or educational information:



TECHNICAL NOTE: This icon indicates technical information about the device.



HINT: This icon indicates helpful hints and tips.



DEFINITION: This icon indicates the definition of a term used in the text.

Your device's features and specifications

Certain chassis are designed to accommodate all possible configurations for an entire product Series. Your select model may not have all the features and specifications corresponding to all of the icons or switches shown on the chassis, unless you have selected all those features.

This information applies to all the features and icons described in this guide.

Below are examples of some of the many possible icons used on your device:



(Sample Illustration) System icons

Other documentation

Your device comes with the following documentation:

- ❖ A Legal/Safety/Regulatory document
- ❖ A Quick Start Card
- ❖ A standard limited warranty
- ❖ It may also contain guides for other programs that may come with your system.

For accessory information, visit Toshiba's Web site at accessories.toshiba.com.

Service options

Toshiba's standard limited warranty, extended warranty, and service upgrade terms and conditions are available at warranty.toshiba.com.

To stay current on the most recent applications, application updates, and hardware options for your device, as well as other product information, be sure to regularly check the Toshiba Web site at tabletsupport.toshiba.com.

If you have a problem or need to contact Toshiba, see “If Something Goes Wrong” on page 105.

Precautions

Your device is designed to provide optimum safety and ease of use, and to withstand the rigors of travel. You should observe certain precautions to further reduce the risk of personal injury or damage to the device.

▲ WARNING

Keep this device away from small children. This device is not a toy and may be hazardous to small children, for example, small detachable parts may be a choking hazard. Improper use of device could result in loud volume emitting from the device possibly causing hearing damage, and improper use and handling of batteries could result in possible injury.

CAUTION

Never place a heavy object on the device and be careful not to drop a heavy object onto the device. It could damage the device or cause system failure.

- ❖ Never turn off the device if a drive light indicates a drive is active. Turning off the device while it is reading from or writing to an external hard drive or flash media may damage the disk or flash media.
- ❖ Keep the device and disks away from objects that generate strong magnetic fields, such as large stereo speakers.
- ❖ Scan all new files for viruses.

This precaution is especially important for files you receive via email or download from the Internet. Occasionally, even new programs you buy from a supplier may contain a virus. You need a special program to check for viruses.

File management tips

- ❖ Back up your files to external media on a regular basis. Label the backup copies clearly and store them in a safe place.
Your data stays in the device's temporary memory until you back it up to external media. If the network you are using goes down and you must restart your device to reconnect, or your battery runs out of charge while you are using your device, you will lose all data since you last backed it up. See [“Backing up your data” on page 45](#) for further information.
- ❖ Scan all new files for viruses.
This precaution is especially important for files you receive via external media, email, or download from the Internet.
- ❖ Do not turn off the device if a drive indicator light indicates a drive is active.

Toshiba's online resources

Toshiba maintains a number of online sites to which you can connect. These sites provide information about Toshiba products, give help with technical questions and keep you up to date with future upgrades. For more information, see [“Contacting Toshiba” on page 110](#).

Chapter 1

Getting Started

This chapter provides tips for using your device effectively, summarizes how to connect components, and explains what to do the first time you use your device.

Please read and adhere to all safety information carefully and make sure you fully understand the instructions before you attempt to use your device in order to avoid potential hazards that could cause bodily injury, property damage, or damage the device.

Features and components

For further details on each of the items listed in the following section, be sure to follow the provided references to sections later in this document.

Front

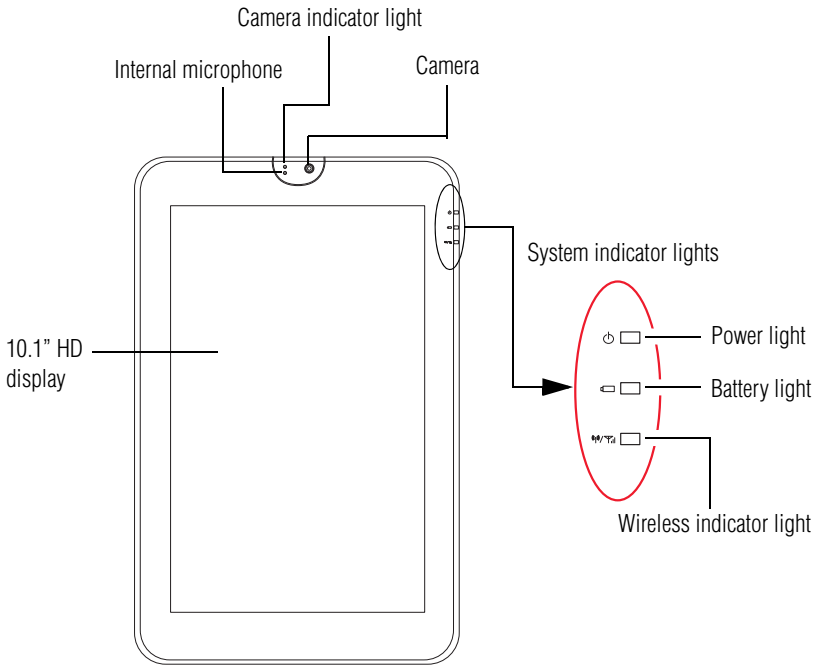

(Sample Illustration) Front view

- ❖ **Front Camera indicator light**—Glow blue when the front Camera is in operation. For more information, see [“Using the cameras”](#) on page 91.
- ❖ **Internal microphone**—Allows you to record sounds for your application. For more information, see [“Recording sounds”](#) on page 91.
- ❖ **Front Camera**—Allows you to take still photos or record videos.
- ❖ **Power light**—Glow white when the device is on.
- ❖ **Battery light**
 - ❖ **Tablet is plugged into AC power:** The light glow white when the battery is fully charged and glow amber when battery power is low.
 - ❖ **Tablet is not plugged into AC power:** The light does not glow.
- ❖ **Wireless indicator light**—Glow amber when Wi-Fi® or Bluetooth® is enabled. For more information, see [“Setting up Wi-Fi® and Bluetooth® connections”](#) on page 44.

Back

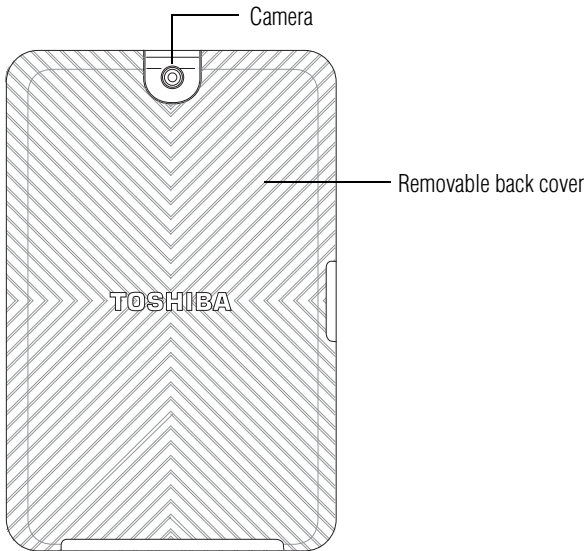

(Sample Illustration) Back view

- ❖ **Camera**—Allows you to take still photos and videos. For more information, see [“Using the cameras”](#) on page 91.
- ❖ **Removable back cover**—Can be removed to replace the battery. For more information, see [“Changing the battery”](#) on page 32.

Right side

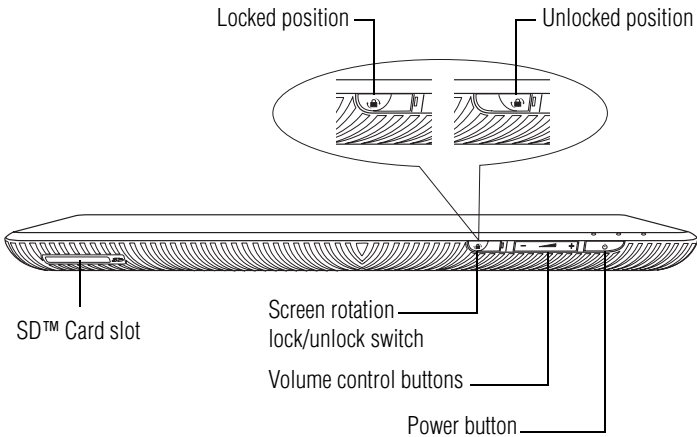
*(Sample Illustration) Right side view*

- ❖ **SD™ Card slot**—Supports the use of Secure Digital™ (SD™) media. For more information, see [“Using an SD™ Card” on page 91](#).
- ❖ **Screen rotation lock/unlock switch**—Allows you to lock the orientation of the display screen so that the current view does not rotate with movement. For more information, see [“Screen settings” on page 72](#).
- ❖ **Volume control buttons**—Allows you to increase/decrease the volume.
- ❖ **Power button**—Turns the device on and off. Press and hold the button for several seconds to turn the device ON/OFF. Press the button quickly to wake the device from Sleep mode or to place it into Sleep mode. For more information, see [“Options for turning off the device” on page 57](#).

Left side

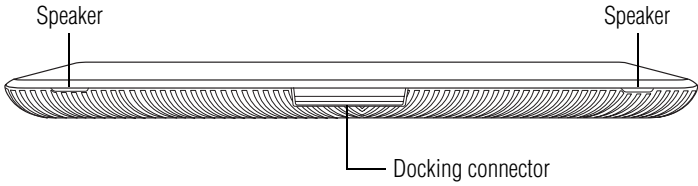

(Sample Illustration) Left side view

- ❖ **Docking connector**—Allows connection to a docking station. Remove the docking connector cover to access to the docking connector. For more information, see [“Using a docking station”](#) on page 95.
- ❖ **Speakers**—Allow you to listen to sounds on your device. For more information, see [“Using the built-in speakers”](#) on page 90.

Top

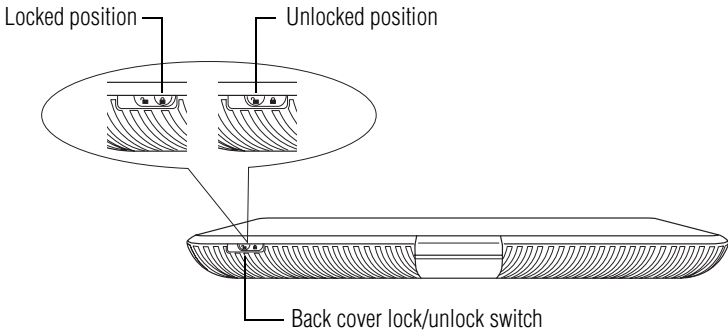

(Sample Illustration) Top view

- ❖ **Back Cover lock/unlock switch**—Allows or prevents removal of the back cover. The locked position secures the cover in place, and in the unlocked position the back cover can be removed. For more information, see [“Removing the battery from the device”](#) on page 32.

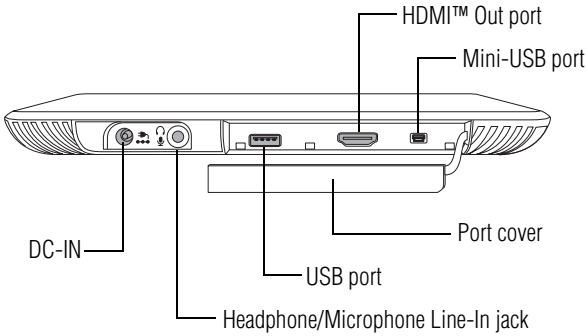
Bottom

(Sample Illustration) Bottom view

NOTE Remove the port cover to access the ports.

- ❖ **DC-IN**—Allows connection of the AC adaptor to charge the battery or run your device on AC power. For more information, see [“Using the device for the first time” on page 39](#).
- ❖ **Headphone/Microphone Line-In jack**—Allows you to listen to or record sounds onto your device. For more information, see [“Using external speakers or headphones” on page 90](#).
- ❖ **USB port**—Allows the transfer of data, and connection of some external devices (consult your device manufacturer).
- ❖ **HDMI™ Out port**—Allows for the transfer of video and audio signals, as well as control signals. For more information, see [“Using external devices” on page 93](#).
- ❖ **Mini-USB port**—Allows the transfer of data.

Connecting to a power source

Your device requires power to operate. Use the power cord/cable and AC adaptor to connect the device to a live electrical outlet, or to charge the device's battery.

⚠ WARNING

Always confirm that the power plug (and extension cable plug if used) has been fully inserted into the socket, to ensure a secure electrical connection. Failure to do so may result in a fire or electric shock, possibly resulting in serious injury.

Be careful if you use a multiple connector. An overload on one socket could cause a fire or electric shock, possibly resulting in serious injury.

⚠ WARNING

Always use the Toshiba AC adaptor that was provided with your device, or use AC adaptors specified by Toshiba to avoid any risk of fire or other damage to the device. Use of an incompatible AC adaptor could cause fire or damage to the device possibly resulting in serious injury. Toshiba assumes no liability for any damage caused by use of an incompatible adaptor.

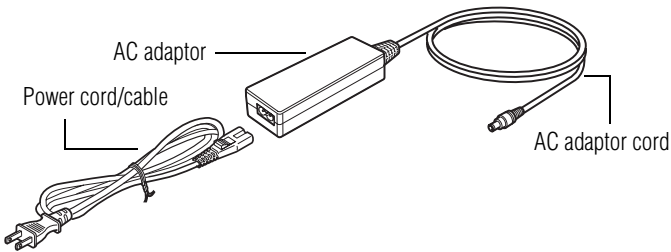

(Sample Illustration) Power cord/cable and AC adaptor

To connect AC power to the device:

- 1 Connect the power cord/cable to the AC adaptor.

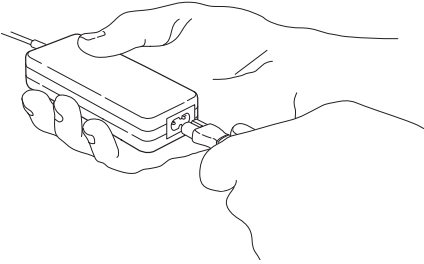

(Sample Illustration) Connecting the power cord/cable to the AC adaptor

⚠ WARNING

Handling the cord on this product will expose you to lead, a chemical known to the State of California to cause birth defects or other reproductive harm. **Wash hands after handling.**



- 2 Plug the AC adaptor cord into the DC-IN on the bottom of the device.

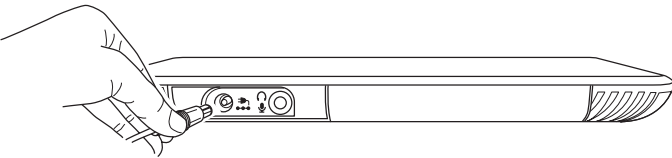

(Sample Illustration) Connecting the AC adaptor cord to the device

- 3 Connect the power cord/cable to a live electrical outlet.



The Power light on the indicator panel glows white.

⚠ WARNING

Never attempt to connect or disconnect a power plug with wet hands. Failure to follow this instruction could result in an electric shock, possibly resulting in serious injury.

The device's battery light gives you an indication of the battery's current charge:

- ❖ Glows amber while the battery is being charged (AC adaptor connected)
- ❖ Glows white when the battery is fully charged

- ❖ Is unlit when the battery has discharged, the battery is not charging, or the AC adaptor is not plugged into the device or AC outlet
- ❖ Flashes amber when the battery charge is low and it is time to recharge the battery or plug in the AC adaptor

Charging the battery

Your device contains a rechargeable battery that may need to be charged prior to use.

To use external power or to charge the battery you must attach the AC adaptor. See [“Connecting to a power source” on page 29](#).

To charge the battery, leave the device plugged into an AC power source with the device turned off until the battery light glows white. After that, the battery will be completely charged and ready to power the device.

CAUTION

Once the battery is charged for the first time, avoid leaving the device plugged in and turned off for more than a few hours at a time. Continuing to charge a fully charged battery can damage the battery.



TECHNICAL NOTE: The recharging of the battery cannot occur when your device is using all of the power provided by the AC adaptor to run applications, features, and external devices.

NOTE

Battery life and charge time may vary depending on the external conditions, or the applications and features used.

NOTE

Please handle your device carefully to avoid scratching or damaging the surface.

Changing the battery

When your battery has run out of power, you have two options: plug in the AC adaptor or install a charged battery.

⚠ WARNING Never short-circuit the battery pack by either accidentally or intentionally bringing the battery terminals in contact with another conductive object.

- ❖ Never expose a battery pack to abnormal shock, vibration or pressure.
Failure to observe the foregoing could result in serious injury.

Removing the battery from the device

To remove the battery:

NOTE Remove the SD™ Card from the SD™ Card slot. The SD™ Card slot must be empty when removing the battery from the device.

- 1 Turn the tablet's power off and remove all cables and peripherals that are connected to the device.
- 2 Turn the tablet upside down and slide the cover lock to the unlocked position.

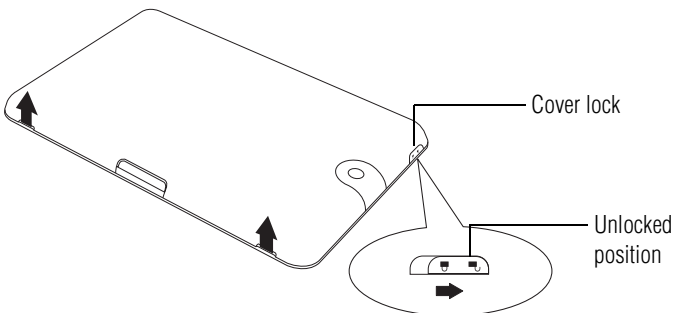

(Sample Illustration) Unlocking the back cover lock

- 3 Slide your finger under the cover recess (speaker area) and first lift up the corner closest to the lock.

- 4** Lift up and gently remove the cover.

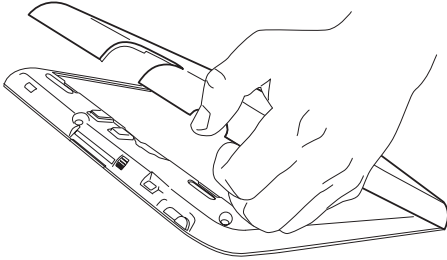

(Sample Illustration) Removing the back cover

- 5** Slide the battery release lock to the unlocked position.

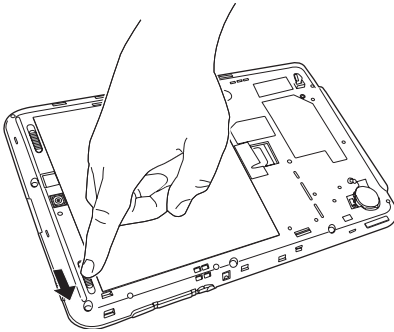

(Sample Illustration) Unlocking the battery release lock

- 6** Slide and hold the battery release latch to disengage the battery with one hand, then using the other hand, lift up from the center to remove the battery from the tablet.

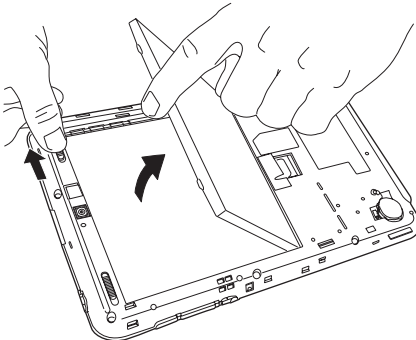

(Sample Illustration) Removing the battery

⚠ WARNING If the battery is leaking or its case is cracked, put on protective gloves to handle it, and discard it immediately. Always dispose of used batteries in compliance with all applicable laws and regulations.

Inserting a charged battery

To insert a battery:

- 1 Wipe the connectors of the charged battery with a clean cloth to ensure a good connection.
- 2 With the label side of the battery facing down, line up the connector of the battery with that of the tablet, and then gently insert the battery into the tablet at the angle of approximately 30 degrees.
- 3 Seat the battery securely in place and slide the battery lock to the locked position.

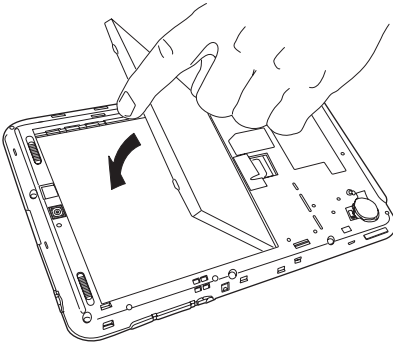

(Sample Illustration) Inserting the battery

CAUTION If the battery does not slide into the slot easily, move the battery release lock to the unlocked position and try again. Do not force the battery into position.

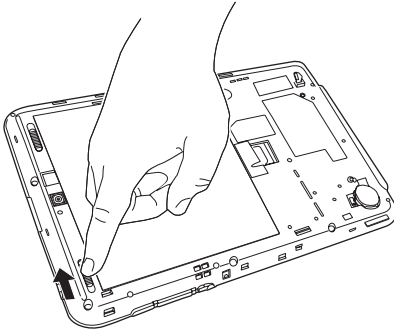

(Sample Illustration) Locking the battery release lock

- 4** Seat the back cover in place, and then slide the cover lock to the locked position.

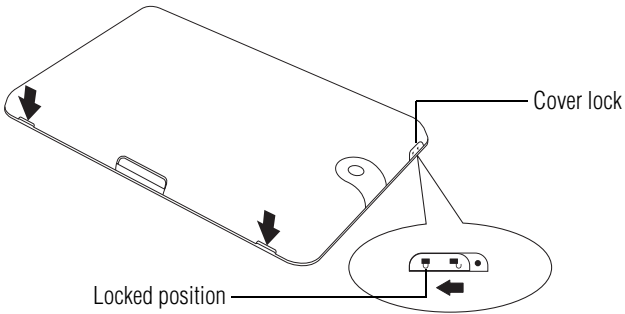

(Sample Illustration) Replacing the back cover lock

- 5** Turn the device right side up.
- 6** Reconnect any cables that were removed in step 3 of [“Removing the battery from the device”](#) on page 32.
- 7** Restart the device.

Taking care of your battery

The following sections offer tips on how to take care of your battery and prolong its life.

Safety precautions

⚠ WARNING

Battery pack warning indicators

- ❖ Always immediately turn the power off and disconnect the power cable/ cord plug from the plug socket and stop using the battery pack if you observe any of the following conditions:
 - ❖ Offensive or unusual odor
 - ❖ Excessive heat
 - ❖ Discoloration
 - ❖ Deformation, cracks, or leaks
 - ❖ Smoke
 - ❖ Other unusual event during use, such as abnormal sound

Do not turn on the device's power again until an authorized Toshiba service provider has checked it for safety. Continued use could cause a fire or rupture possibly resulting in serious injury or device failure including but not limited to the loss of data.

Optimizing battery life



You can extend your battery's life between charges by turning off features you don't need. You can also change and monitor the way apps and system resources consume battery power.

Below are some of the things you can do:

- ❖ To turn off Wi-Fi® or Bluetooth® when you are not using them, touch the **Apps** (📱 Apps) icon, swipe to the second screen, touch the **Settings** (⚙️) icon, and then touch **Wireless & networks**. For more information, see [“Wireless and networks settings” on page 69](#) and [“Location and security settings” on page 73](#).
- ❖ Turn down the screen brightness and set a shorter screen time-out. For more information, see [“Screen settings” on page 72](#).
- ❖ If you do not need them, turn off automatic syncing for Gmail™, Calendar, Contact, etc. For more information, see [“Accounts & sync settings” on page 76](#).

- ❖ If you know you will not be near a Wi-Fi® network for some time, switch to Airplane mode. For more information, see “Wireless and networks settings” on page 69.

To check the battery charge level:

- 1 Touch the **Apps** () icon.
The Apps menu appears.
- 2 Swipe to the second screen and touch the **Settings** () icon.
The Settings menu appears.
- 3 Touch the **About tablet** () icon.
The About tablet menu appears.
- 4 Touch **Status**.

The battery status (charging/discharging) and level (as a percentage of fully charged) are displayed at the top of the screen.

NOTE For more details on your battery use, touch **Battery use**.

Maintaining your battery

Fully discharging your battery will allow better accuracy of the battery meter.

- ❖ To fully discharge your battery, periodically, disconnect the device from a power source and operate it on battery power until the battery fully discharges.
- ❖ If you have extra batteries, rotate their use.
- ❖ If you will not be using the system for an extended period, more than one month, remove the battery.
- ❖ Store spare batteries in a cool dry place out of direct sunlight.

Disposing of used batteries

The life of a battery depends on usage. When the battery needs replacing, the battery light flashes amber shortly after you have fully recharged the battery.

You must discard a battery if it becomes damaged.

⚠ WARNING

Never attempt to dispose of a battery pack by burning or by throwing it into a fire, and never allow exposure to a heating apparatus (e.g., microwave oven).

Always dispose of used battery packs in compliance with all applicable laws and regulations.

⚠ WARNING

Always use the battery pack supplied as an accessory or an equivalent battery specified in the User's Guide. Other battery packs have different voltage and terminal polarities. Use of non-conforming batteries could generate smoke or cause fire or rupture, possibly resulting in serious injury.

After repeated use, the batteries will finally lose their ability to hold a charge and you will need to replace them. Under certain applicable laws and regulations, it may be illegal to dispose of old batteries by placing them in the trash.

Please be kind to our shared environment. Check with your local government authority for details regarding where to recycle old batteries or how to dispose of them properly. If you cannot find the information you need elsewhere, call Toshiba at: (800) 457-7777.

In addition, Toshiba's recycling initiatives include recycling programs, events, and consumer promotions. For details, please visit us.toshiba.com/green.

Toshiba is dedicated to preserving the environment by sponsoring **Call2Recycle**[®], a program of the Rechargeable Battery Recycling Corporation. For more information and for drop-off locations, visit www.rbc.org or call 1-800-822-8837.

Notice regarding CR coin cell batteries, applicable to California, U.S.A. only:

Perchlorate Material - special handling may apply.

See <http://www.dtsc.ca.gov/hazardouswaste/perchlorate/>

Using the device for the first time

The device is now ready for you to turn it on and begin using it.

Turning on the power

To turn on the device:

- 1 Make sure any external devices (such as the AC adaptor, if you plan to use AC power rather than battery power) are properly connected and ready.
- 2 Check to ensure that all slots are empty.
- 3 Press and hold the Power button for several seconds. The Power light glows white.

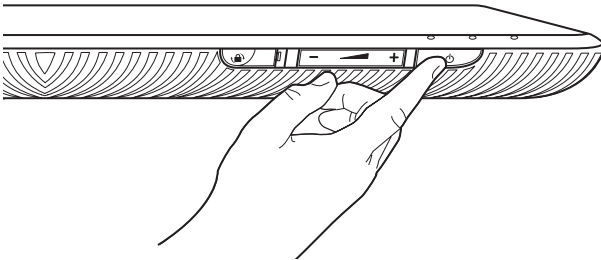

(Sample Illustration) Turning on the power

Small bright dots may appear on your screen display when you turn on your device. Your display contains an extremely large number of thin-film transistors (TFT) and is manufactured using high-precision technology. Any small bright dots that may appear on your display are an intrinsic characteristic of the TFT manufacturing technology. Over a period of time, and depending on the usage of the device, the brightness of the screen will deteriorate. This is also an intrinsic characteristic of the screen technology.

Setting up your device

NOTE

To take full advantage of features for your device, Toshiba recommends that you have access to a Wi-Fi® network and a Google™ Account before setting up your device.

The first time you power on your tablet the Welcome screen appears and you will be asked to choose a language.

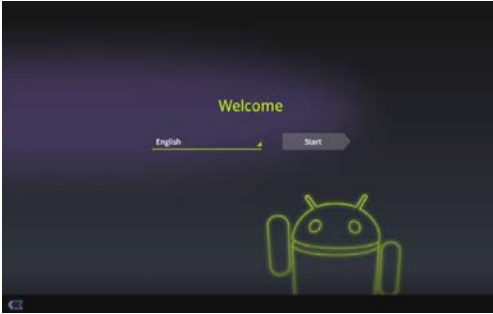

(Sample Image) Welcome screen

- ❖ If English is your language of choice touch **Start**.
- ❖ Touch **English** to change your language. Choose from the list of language options and then touch **Start**.

Your tablet begins the activation process when you touch **Start** on the Welcome screen.

Setting up your Wi-Fi® connection

After choosing your language the “Wi-Fi setup” screen appears, displaying all available Wi-Fi® networks.

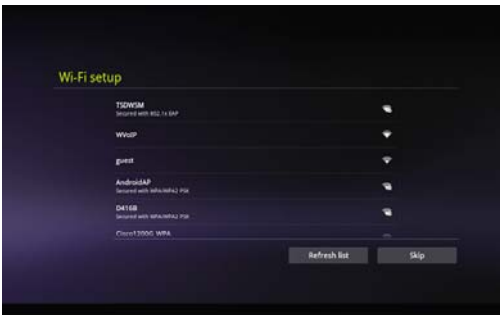

(Sample Image) Wi-Fi setup screen

Touch the name of the network you want to connect to, and then touch **Confirm**. (If the network is a secured/locked network, you will be asked to enter the appropriate credentials before confirming.)

Setting location preferences

After you choose an available Wi-Fi® network, the “Use Google location service” screen appears. Your approximate location is made available to the apps you use by Google’s location service.

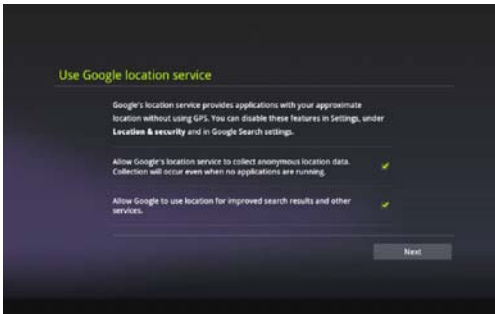

(Sample Image) Use Google location service screen

Touch your preferred settings, and then touch **Next** to continue.

Setting the date and time

When your location preferences have been chosen, the “Set date and time” screen appears.

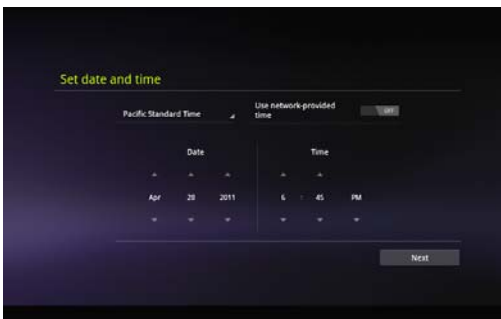

(Sample Image) Set date and time screen

There are two options available for setting date and time:

- ❖ Use network provided time (leave the setting option **ON**), and then touch **Next**.

- ❖ Set the option, “Use network provided time” to **OFF**. This allows you to manually enter the date/time information.
 - 1 Select the region. The default setting is “Pacific Standard time.”
 - 2 Set the date by touching the up/down arrows, and then touch **Next** to continue.

Sign in to your Google™ Account

Once the date and time have been set, the “Sign in with your Google Account” screen appears.

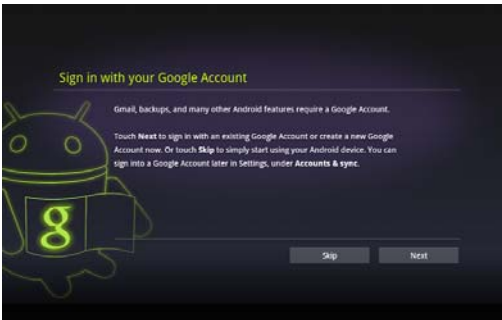

(Sample Image) Set date and time screen

A Google Account is required to access many of the powered by Android™ features, including Gmail™, backing up your data, etc.

NOTE

Sign in to your Google Account now to restore settings that have been previously backed up. If you wait until after setup, you will not be able to restore your settings. For more information, see [“Backing up your data” on page 45](#).

Touch **Next** to sign in with an existing Google Account or create a new one now.

The “Sign in with your Google Account” screen appears.



(Sample Image) Sign in with your Google Account screen

- ❖ Enter your existing Google Account information, and then touch **Sign in**.
- ❖ If you do not already have a Google Account, you can create a new one by touching **Create account**.

The “Signing in” screen appears.

Touch **Skip** to skip the account setup for now. You can sign in to a Google Account later in **Settings**, under **Accounts & sync**.

NOTE This may take several minutes. If your screen times-out and goes blank/dark, press the Power button to turn on the screen again.

Waking the tablet

If the screen times-out:

- 1 Press the Power button.

The lock screen appears, unless you have previously disabled it.

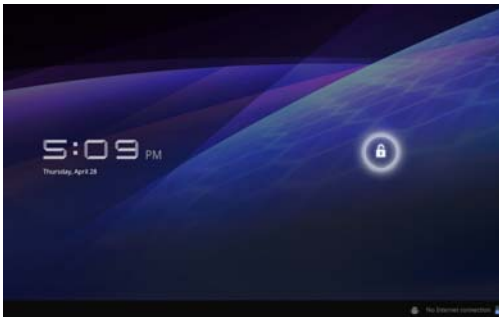

(Sample Image) Lock screen

- 2 Touch and hold the **Lock** (🔒) icon and drag it to the edge of the large circle surrounding it.
The last screen viewed appears.

Setting up Wi-Fi® and Bluetooth® connections

Wi-Fi®:

- 1 Touch the **Apps** (📁 Apps) icon. Then swipe to the second screen, and touch the **Settings** (⚙️) icon, the **Wireless & networks** (📶) icon, **Wi-Fi settings**, and then **Wi-Fi**, if not turned on.
The device scans for and displays all available Wi-Fi® networks.
- 2 Touch the Wi-Fi® network you want to connect to.
If the network is open, you will be asked to confirm the connection.
- 3 Touch **Connect** to confirm.
The **Wireless & networks** (📶) icon appears in the System bar.
- 4 Touch the **Back** (⬅️) icon to try a different network.
To connect to secure/locked networks, you will be prompted to enter the appropriate credentials.

NOTE Wi-Fi® is enable by default and the device saves this information so that you can connect automatically the next time you come within range of this network.

If you use third-party applications on this device, any information those applications collect (including location-based information) may be sent to third parties and merged with other customer information subject to their respective privacy policies.

Bluetooth®:

- 1 Touch the **Apps** (📁 Apps) icon. Then swipe to the second screen, and touch the **Settings** (⚙️) icon, the **Wireless & networks** (📶) icon, and then **Bluetooth** (select the check box to enable it).
- 2 Touch **Bluetooth settings**, and then **Find nearby devices**.
The device scans/finds nearby devices (i.e. keyboard, mouse).
- 3 Touch the name of the device to pair with and then touch **Pair**.

Registering your Toshiba device

NOTE To register online, you must be connected to the Internet.

Product registration is strongly recommended, and allows Toshiba to send you periodic updates, announcements, and special offers applicable to your product. Product registration can be completed by either visiting the Toshiba Web site at <http://www.register.toshiba.com>, or by touching the **Registration** (📄) icon on the Home screen. Failure to complete Product Registration will not diminish Customer rights under the Standard Limited Warranty.

Backing up your data

Back up the data you create in case something happens to your device. You can back up your data to different types of media such as an SD™ Card (see “Using an SD™ Card” on page 91), external storage media, or to a network, if available.

You can also back up your settings as well as your data using your Google™ Account. Your data is backed up automatically using this option. For more information, see “Privacy settings” on page 77. If you need to replace your device, your data can be restored to your new one.

Backing up data using TOSHIBA File Manager

Using the TOSHIBA File Manager, you can back up your data to an SD™ Card or other external media. For more information, see “TOSHIBA File Manager Utility” on page 101.

Backing up data using your Google™ Account

You can also back up your settings as well as your data using your Google™ Account. Your data is backed up automatically using this option. For more information, see “Sign in to your Google™ Account” on page 42.

Restoring your data using your Google™ Account

If your data was previously backed up using this service you can sign in to your Google™ Account and choose to restore your settings from your Google Account to your device.

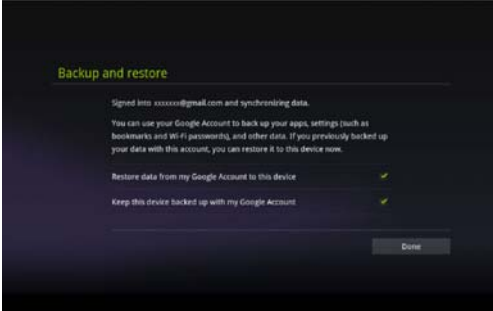

(Sample Image) Backup and Restore screen

The data that is backed up may include the following:

- ❖ Your Wi-Fi® networks and passwords, user data, and tablet settings
- ❖ Many Google application settings, such as your Browser bookmarks
- ❖ The apps you download from Android Market™



Navigation and features





Your device exemplifies the innovative blending of touch-screen technology and intuitive application design making the most of your tablet device.

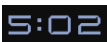

(Sample Image) Central Home screen

Icons and buttons you may find on your display screen.

<i>Icon</i>	<i>Name</i>	<i>Description</i>
	Home button	Touch to return to the Home screen.
	Back button	Touch to return to the previously viewed screen.
	Recent Apps button	Touch to view the most recently view apps.
	Time display	Located in the System bar to the left of the Status icons.

Icon	Name	Description
	Battery status icon	Located in the System bar. Displays the status of the battery charge.
	Customize button	Touch to Customize your Home screens.
	Voice recognition button	Touch to perform a voice-enabled search.
	Google Search bar	Touch to perform a search using the keyboard.

Home screen

The total number of available Home screens is five. Move between screens by swiping your finger to the left or right.



(Sample Image) 5 available Home screens

Your device's five home screens have several standard features, including icons and a customizable background pattern (wallpaper). The wallpaper image spans the width of all five Home screens.

The middle screen is your Central Home screen and the starting point after your device has been set up. However, your device will return to the last home screen viewed each time you wake up your device from Sleep mode. Touch the Home button to return to the central Home screen.

Icons

An icon represents a shortcut of either a widget, application, bookmark, or game that can be quickly launched by touching the icon on a Home screen.

Each Home screen may display icons for any of the following:

- ❖ Widgets
- ❖ Applications
- ❖ Bookmarks
- ❖ Games
- ❖ Thumbnails

Your Home screen will contain other icons depending on how you have customized it. See [“Customizing your Home screens” on page 55](#).



Gmail™ icon—An example of an icon located on a Home screen is the Gmail icon. This shortcut, when touched, launches your Gmail webmail account.

Touch screen navigation

Use your finger to manipulate the onscreen icons, buttons, menu items, onscreen keyboard, and other items on the touchscreen. You can also change the screen's orientation.

CAUTION

The screen is made of glass so avoid contact with sharp, rough, or abrasive objects or substances as screen may break or scratch if not handled properly. If you see a crack in the glass, discontinue use of the device to avoid injury.

Touch—Touch to activate items displayed on the screen, such as app and setting icons or onscreen buttons. Touch to type using the onscreen keyboard.

Touch & hold—Touch and hold an item on the screen by touching and holding the item in place until an action occurs.

Drag—Touch and hold an item for a moment and then, without lifting your finger, move the item until you reach the target position. For example, drag items on the Home screen to reposition them, see [“Customizing your Home screens” on page 55](#).

Swipe or slide—To swipe or slide, quickly move your finger across the surface of the screen without pausing. For example, slide the Home screen left or right to view another Home screen.

Double-tap—Tap quickly twice to zoom in. For example, double-tap a section of a Web page to zoom in on that section. Double-tap again to zoom out.

Pinch—In some apps (such as Maps, Browser, and Gallery), you can zoom in and out by placing two fingers on the screen at once and pinching them together (to zoom out) or spreading them apart (to zoom in).

Rotate the screen—In most apps, the orientation of the screen rotates with the tablet as you turn it. You can turn this feature on and off, using the Screen rotation lock switch on the side of your tablet. This allows you to lock the screen to the currently viewed screen orientation.

Navigating the Home screen



When the setup process is complete, the Home screen appears. This is your starting point for all features used on your tablet. You can use the Customize button to add shortcuts for apps, widgets, and other features to all five of your Home screens. You can also change your wallpaper to more customize the look of your device. For more information, see “[Customizing your Home screens](#)” on [page 55](#).

System bar

The System bar displays icons of tasks or programs that run continuously in the background and displays notifications, such as incoming email and the status of your wireless connection. Touch an icon to learn more about its task.

Navigation buttons

Using the navigation buttons in the System bar is an easy way to quickly switch between apps.

The System bar displays the Back () button, Home () button, and Recent Apps () button. Also displayed are the Notification icons, the time, and Status icons.

Touch the Home button at any time to return to the Home screen. Swipe your finger right or left to view another Home screen, or touch and hold anywhere on the Home screen to view the thumbnail view of all five Home screens. Touch the Home button again to return to the central Home screen.

In some media apps, the System bar controls are replaced by dim dots while a movie, slide show, etc. is displayed. This increases the viewing space on the screen. Touch the dot that corresponds with

the desired control, or touch a blank area of the System bar to restore the full view.

At the top of the screen you will find the Google™ Search bar (🔍 Google), and next to that is the search by voice (🗣️) button. Also available at the top of the screen are the Apps (📁 Apps) button and the Customize (+) button.

Status icons

Status icons are located on the far right of the System bar. Status icons display current system status information, such as power usage and network connectivity status.

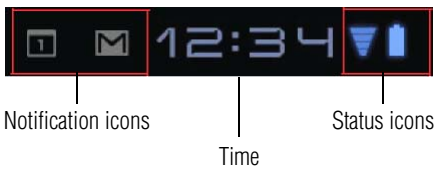

(Sample Image) Status icons

Touch the **Time** display to view the Status Details panel. For more information, see “[Securing your tablet](#)” on page 53.

After your Google™ Account is set up, the Network Status icons are blue when connected to Google services. This indicates that the tablet is ready to sync your Gmail™, Calendar, and contacts, and to back up your settings. When your tablet is not connected to a Google Account or the wireless connection is disabled, the icons are gray.

Managing Notifications

Notifications report the arrival of new messages, calendar events, and alarms, and they report the status of your Wi-Fi® connection.

Notification icons appear in the System bar, to the left of the time display, along with a summary that appears briefly.

Depending on your settings you may also hear a notification sound.

Typical notifications are currently running programs and available updates. To activate a specific task, click the appropriate Notification bar icon.

Most apps that send notifications, such as Gmail™ and the calendar, have their own settings. These settings can be configured to send notifications in different ways, with a sound or vibration, etc. See the documentation for those apps for details. You can open the Notifications list to view all of your current notifications.

Opening a notification

- 1 Touch the time display in the System bar on the lower right of your Home screen.

The Notification summary panel opens.



(Sample Image) Notification summary panel screen

- 2 Touch a notification summary to view it or to respond to it.

Touch the notification's Close button to remove it from the Notifications list. Touching a blank area of the screen closes the list without removing the notification.

Responding to notifications

When the Notification summary panel is open you can respond to a notification by touching the associated icon.

Notification panels contain a variety of information and controls, including:

- ❖ A message summary, with the date and picture of the sender
- ❖ Media controls to play/pause music or to skip to the next or previous track
- ❖ Progress bars that indicate the progress of currently downloading apps

- 1 Touch a notification icon in the System bar.

The notification's summary panel opens.

- 2 Touch a notification in the Notification summary panel to open it in its application.

It will then be cleared from the Notification summary panel.

- 3 To remove the notification without viewing it, touch its Close button.

Securing your tablet



CAUTION

If you choose to set a password (with or without encryption), Toshiba strongly recommends that you write down your password and keep it in a safe location where you can later access it should you not remember it.

Toshiba is not responsible for any losses that may occur, as a result of the inability to access your device.

When you initially turn on or wake the tablet, the lock screen requires you to drag the **Lock** () icon to unlock the screen, see “Waking the tablet” on page 43. Alternatively, you can secure the lock screen by requiring a pattern or entry of a numeric PIN or password, so only you can access your data. You may also be required to secure the lock screen by a policy set by an email account or other account you add to your tablet. For more information, see “Location and security settings” on page 73.

You can also encrypt the data on your tablet, so you must enter a numeric PIN or a password to decrypt it each time you power it on.

- 1 Touch the **Time** () display in the System bar, touch the time in the Status Details panel, and touch the **Settings** () icon at the bottom of the Quick Settings screen.

You can also open Settings by touching the **Settings** () icon in the Apps screen or on a Home screen (if you placed a shortcut to it there).

- 2 Touch the **Location & security** () icon.
- 3 Touch **Configure lock screen**.
- 4 Touch **Pattern, PIN, or Password**.

If you touch **Pattern**, you're guided to create a pattern you must draw to unlock the screen. The first time you do this, a short tutorial about creating an unlock pattern appears. Then you are prompted to draw and redraw your own pattern.

If you touch **PIN** or **Password**, you are prompted to set a numeric PIN or a password you must enter to unlock your screen.

The next time you turn on your tablet or wake up the screen, you must draw your unlock pattern or enter your PIN or password to unlock it.

You can encrypt all the data on your tablet: Google™ Accounts, application data, music and other media, downloaded information, etc. If you do, you must enter a numeric PIN or password each time you power on your tablet.

CAUTION

- ❖ Encryption is irreversible. The only way to revert to an unencrypted device is to perform a factory data reset, which will erase all your data.
 - ❖ You must not interrupt the encryption process or you will lose some or all of your data. (See “[Privacy settings](#)” on page 77 and “[If Something Goes Wrong](#)” on page 105).
-

- 1 Before starting the encryption process on your tablet, you must:
 - ❖ Set a lock screen PIN or password (see “[Securing your tablet](#)” on page 53).
 - ❖ Charge your tablet’s battery.
 - ❖ Plug your tablet to the AC adaptor.
 - ❖ Schedule an hour or more for the encryption process:
- 2 Touch the **Settings** (⚙️) icon, **Location & security** (📍) icon, and then **Encrypt tablet**.

Read the information on the Encrypt Tablet screen carefully.

If you change your mind touch the **Back** (⬅️) button to exit the encryption process.
- 3 Touch the **Encrypt tablet** button.
- 4 Enter your lock screen PIN or password and touch **Continue**.
- 5 Touch the **Encrypt tablet** button again, to confirm you want to continue.

The encryption process begins and displays the progress.

Encryption can take an hour or more, during which time your tablet may restart several times.

When encryption is complete, you are prompted to enter your PIN or password. Subsequently, you must enter your PIN or password each time you power on your tablet, to decrypt it.

Customizing your Home screens

You can add Apps icons, Widgets, Bookmark shortcuts, and other items to any available free space on any Home screen. You can also change the Wallpaper.

For more information on the Home screens, see [“Navigation and features” on page 47](#).

Adding an item to a Home screen

- 1 Open the Home screen you want to add the item to. For more information on using the Home screens, see [“Navigation and features” on page 47](#).
- 2 Touch the **Customize** (+) button located at the top-right of the screen or touch & hold an empty area of the Home screen.
- 3 Touch the category of the item you want to add. If there are no empty spots on the Home screen, “Add” is dimmed and you must delete or move an item or switch to another Home screen before you can add a new item.
- 4 In the pop-up menu, touch the tab for the category of the item you want to add.
 - ❖ **App shortcuts**—Application icons you can place on your Home screen. Touching them opens the associated apps without having to first open the Apps screen.
 - ❖ **Widgets**—Miniature applications. You can place the associated icons on the Home screen.
 - ❖ **Wallpapers**—Background images downloaded from the Web or chosen from the Gallery (pictures taken with your camera, or still images included with the system). A live wallpaper is an animated scene or maybe a map that centers on your location.
 - ❖ **More**—This category includes Browser bookmark shortcuts, shortcuts created in the Maps app, and many more items.
- 5 Swipe your finger left or right to view additional items in each category.
- 6 Touch & hold the item, and then drag it to the location you wish to place it on the Home screen.

Moving an item from the Home screen

To move an item to a new location on the current Home screen or to move it to another Home screen, touch & hold the icon, and then drag and drop it to the new location.

Removing an item from a Home screen

- 1 Touch & hold the item you wish to remove.
The **Remove** button appears in the top right corner of the display.
 - 2 Drag the item to the **Remove** button.
 - 3 Lift your finger when the icon turns red.
-

NOTE

The item has been removed from the Home screen, but not deleted from the system. To add the item back to your Home screen, see [“Adding an item to a Home screen” on page 55](#).

Changing the wallpaper

- 1 Touch the **Customize** (⊕) button located at the top-right of the screen.
- 2 Touch **Wallpapers**.
- 3 Touch **Wallpapers**, **Gallery**, or **Live wallpapers**.
 - ❖ **Wallpapers**—Opens a thumbnail page, displaying the sample wallpaper images that came preinstalled on your tablet. Touch a thumbnail image to preview it on the screen.
 - ❖ **Gallery**—Opens a thumbnail page, displaying the images you have taken with the tablet’s camera. Pictures can be cropped before setting them as a wallpaper.
 - ❖ **Live wallpapers**—Opens a thumbnail page, displaying the sample live wallpapers that came preinstalled on your tablet. Touch a thumbnail image to preview it on the screen.

Additional wallpapers can be downloaded from Android Market™.

- 4 Touch the wallpaper you want. The selected wallpaper is set as the background image on your display screen.

Turning off the device

It is a good idea to turn off your device when you are not using it for a while.

If you are using the device for the first time, leave the device plugged into a power source (even though the device is off) to fully charge the battery.

Options for turning off the device

You have two options available for turning off the device: Shut down and Sleep mode. Each option has its advantages.

- ❖ Use shut down if you will not be using the device for several days or if you must turn off your device.



TECHNICAL NOTE: Before using the shut down option to turn off your device, backup your data and make sure all disk activity lights are off.

If you change your mind and decide to continue working after all, wait a few seconds before turning the device on again.

NOTE

If you do not intend to use your device for a long period of time, turn off the device, disconnect the power plug from the plug socket, and store your device in a dry dust-free location.

- ❖ Letting the screen time-out or enter into Sleep mode allows the device to conserve power. When turning on the device again, the system automatically returns to the last screen viewed.

To change the screen time-out setting, see [“Screen settings” on page 72](#).

Using Shut down mode

The Shut down mode completely shuts down the device without saving your data or the current state of the device. Shut down mode closes all open apps, shuts down the operating system, and then turns off your tablet.

CAUTION

Always back up your data and settings before shutting down your tablet.

To turn off your device using Shut down mode:

- 1 Press and hold the Power button.

A pop-up screen appears, asking whether you would like to shut down.





(Sample Image) Shut down pop-up screen

- 2 In the pop-up window, touch **OK** to completely shut down the tablet.

The operating system shuts down and the tablet turns off.

- 3 Touch **Cancel** to abort the shut down process.

Using Sleep mode

Your device will automatically time-out after a few minutes of non-operation, placing it into Sleep mode. The screen dims and then darkens to conserve battery power. For more information on waking the tablet from Sleep mode, see [“Waking the tablet” on page 43](#). To change the amount of time it takes for the display to darken, touch the **Apps** () icon, swipe to the second screen and touch the **Settings** () icon, and then the **Screen** () icon.

NOTE

Increase battery life between charges by using the shortest available time-out setting. See [“Screen settings” on page 72](#).

You can also place your tablet into Sleep mode by pressing the Power button quickly.

Factors to consider when choosing Sleep mode:

- ❖ While in Sleep mode, the device uses some battery power.
- ❖ Because the state of the system is stored in memory, you will lose data if the battery discharges completely while the device is in Sleep mode.

- ❖ Waking your device from Sleep mode takes less time and consumes less battery power than restarting after shutting down the device.
- ❖ When starting up again, the device returns to the screen last viewed.

CAUTION



If you place the device in Sleep mode and the battery discharges fully, your unsaved data will be lost. Be sure to backup your data first.

Syncing and managing your accounts

Using the Accounts & Sync settings, you can configure the ways in which your account interacts with the applications on your tablet, and you can sync contacts, email, calendar events, etc. from your multiple Google™ Accounts.

Add an account

Add multiple Google Accounts and Microsoft® Exchange ActiveSync accounts to have all your accounts available on your tablet device. For more information, see [“Accounts & sync settings”](#) on page 76.

- 1 Touch the **Apps** () icon.
The Apps menu appears.
- 2 Swipe to the second screen, and touch the **Settings** () icon.
The Settings menu appears.
- 3 Touch the **Accounts & sync** () icon.
The Accounts & sync menu appears displaying the current sync settings and a list of the current accounts.

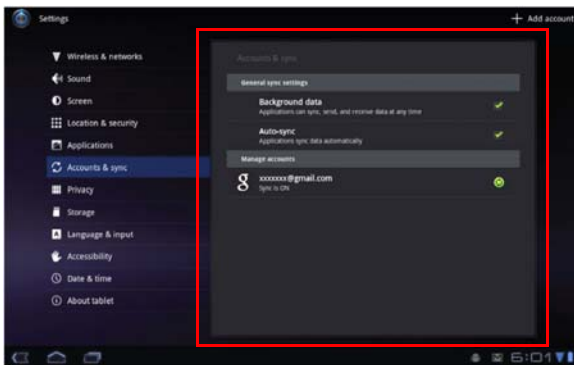



(Sample Image) Accounts & sync screen

- 4 Touch **Add account**.
- 5 Follow the onscreen instructions to enter the required account information.
- 6 Configure the account settings. For more information, see [“Accounts & sync settings” on page 76](#).
The account is added to the list in the Accounts & sync settings.







Remove an account

To remove an account and all the associated information, including email, contacts, settings, etc.:

- 1 Touch the **Apps**  icon.
The Apps menu appears.
- 2 Swipe to the second screen, and touch the **Settings**  icon.
The Settings menu appears.
- 3 Touch the **Accounts & sync**  icon.
The Accounts & sync menu, appears, displaying the current sync settings and a list of the current accounts.
- 4 Touch the account you wish to delete.
- 5 Touch **Remove account** and confirm to continue.
The account and the associated information is removed from the Accounts & sync settings.

Navigation, Maps, Places, and Latitude

To access Navigation, Maps, Places and Latitude:

- 1 Touch the **Apps**  icon.
The Apps menu appears.
- 2 Swipe to the second screen, and touch the **Settings**  icon.
The Settings menu appears.
- 3 Touch the **Navigation**  icon, **Maps**  icon, **Places**  icon, or the **Latitude**  icon.

WARNING Do not use this device while driving.

Navigation: Access turn-by-turn, spoken driving instructions with the free Google™ Navigation application (Beta).

Maps: Finds your current location to access real-time traffic conditions, and obtain detailed directions by foot, public transportation, or car, using the free Google Maps application (Beta).



Places: Quickly find local establishments, such as restaurants, banks, or gas stations, using the free Google Places application.

Latitude: Locate points-of-interest directly on a street map or satellite image. Some areas support street-level views of businesses and neighborhoods. View your friends' locations on your maps and share your location and other information with them, using Google Latitude.

To learn more, visit the the Google Help Center.

Managing downloads

To access downloads:

- 1 Touch the **Apps** () icon.
The Apps menu appears.
- 2 Swipe to the second screen, and touch the **Settings** () icon.
The Settings menu appears.
- 3 Touch the **Downloads** () icon.
The Downloads menu appears.
- 4 Touch an item to open it.

Items can be deleted from your tablet or sorted by file size or date/time of download for easier viewing.

To sort the items:

- 1 Touch the **Menu** () icon.
- 2 Touch **Sort by size** or **Sort by time**.

To delete items:

- 1 Select the items you wish to delete.
- 2 Touch **Delete**, and then confirm the deletion.

Files, apps, and items downloaded from a Web Browser, Gmail, etc., are stored on your tablet's internal storage. Use the Downloads app to view, open, or delete downloaded items.

Factory data reset



This restores the device to the out of box state. All data on the device is erased, including system/application settings, user downloaded/installed applications and data such as photos, music, videos, contacts, etc.

CAUTION

The recovery process deletes all data, restoring the tablet to its out-of-box state. Be sure to save your data to external media before executing the recovery), see [“Backing up your data” on page 45.](#)

Before restoring the device to the out of box state, back up all data to external media. You can use your Google™ account to back up all data and apps settings.

To perform this process:

- 1 Touch the **Apps** () icon.
The Apps menu appears.
- 2 Swipe to the second screen, and touch the **Settings** () icon.
The Settings menu appears.
- 3 Touch the **Privacy** () icon.
The Privacy menu appears.
- 4 Touch **Factory data reset**.
- 5 Touch **Reset tablet**.
- 6 Touch **Erase everything**.

Caring for your device

This section gives tips on cleaning and moving your device. For information about taking care of your device's battery, see [“Taking care of your battery”](#) on page 36.

CAUTION

The screen is made of glass so avoid contact with sharp, rough, or abrasive objects or substances as screen may break or scratch if not handled properly. If you see a crack in the glass, discontinue use of the device to avoid injury.

Cleaning the device

CAUTION

Keep liquids, including cleaning fluid, out of the device's ports, speakers and other openings. Never spray cleaner directly onto the device. Never use harsh or caustic chemical products to clean the device.

To keep your device clean, gently wipe it with a lightly dampened soft cloth.

Chapter 2

Settings

Customizing your device's settings

You can customize the settings for the various functions on your Toshiba tablet, such as screen orientation, or sound settings.

Apps and Settings menus

This menu contains most of the tools you will need to customize and configure your tablet.

Accessing the Apps and Settings menus

To access the Apps menu:







- ❖ Touch the **Apps** ( Apps) icon.



The Apps menu appears.



(Sample Image) Apps menu screen

The following are some of the icons you may find in the Apps menu.

<i>Icon</i>	<i>Name</i>	<i>Description</i>
	Settings	Touch to open the Settings menu and change the settings on your tablet, see “Apps and Settings menus” on page 64 .
	Browser	Touch to open and view Web sites.
	Camera	Touch to open the Camera application. Take photos/videos, using the camera on either the back or the front of the tablet, see “Using the cameras” on page 91 .
	Apps Place	Touch to access and download available Toshiba apps.
	Gmail™	Touch to access your Gmail email account.
	Maps	Touch to open the Maps app, see “Navigation, Maps, Places, and Latitude” on page 60 .
	Android Market™	Touch to open Android Market to view and download available apps for your tablet.

Icon	Name	Description
	Navigation	Touch to open the Navigation app, see " Navigation, Maps, Places, and Latitude " on page 60.
	Gallery	Touch to view the photos/videos you have recorded, using the camera, or images preinstalled on your tablet, see " Using the cameras " on page 91.
	Calendar	Touch to view your Calendar.
	Contacts	Touch to view your Contacts.
	Calculator	Touch to open the Calculator application.
	Downloads	Touch to view the Downloads application, see " Managing downloads " on page 61.
	Media Player	Touch to open the multimedia player, see " TOSHIBA Media Player " on page 84.
	Books	Touch to view the books that have been downloaded to your tablet.

To access the Settings menu:

- ❖ Touch the **Apps** () icon. Then swipe to the second screen, and touch the **Settings** () icon.













The Settings menu appears.



(Sample Image) Settings menu screen

Customizing your device's settings

The following are some of the icons you may find in the Settings menu.

Icon	Name	Description
	Wi-Fi®	Configure and manage connections to networks and devices via Wi-Fi®, or <i>Bluetooth</i> ®, see “Wireless and networks settings” on page 69 .
	Sound	Configure the Sound settings to set the audio for media playback, notifications, and alarms with the your desired volume level and notification sounds, see “Sound settings” on page 71 .
	Screen	Configure the screen orientation or use energy saving settings, see “Screen settings” on page 72 .
	Multimedia	Touch to adjust the multimedia playback settings, see “Multimedia settings” on page 72 .
	Location & security	Configure how you want the tablet to determine your location, see “Location and security settings” on page 73 .
	Applications	Touch to view and manage the installed applications, see “Applications settings” on page 75 .
	Accounts & sync	Add, remove, and manage all of your accounts, and sync accounts to work together, see “Accounts & sync settings” on page 76 .
	Privacy	Back up your settings and data to Google™ servers, using your Google Account, or perform a factory data reset, see “Privacy settings” on page 77 .
	Storage	Monitor the used and available space on your tablet's internal storage and other storage media installed on your tablet, see “Storage settings” on page 78 .
	Language & input	Configure the various input methods available on your tablet, see “Language & input settings” on page 78 .
	Date & time	Configure your preferences for the way in which dates are displayed, see “Date & time settings” on page 81 .
	About tablet	Displays information regarding your operating system software and hardware, see “About tablet” on page 82 .

Access Settings from the Quick Settings menu

You can open the Quick Settings menu to view and control the tablet settings you most often use, as well as access the Settings menu.

- 1 Touch the **Time** (5:02) display in the lower-right corner of the screen in the System bar.

The Status Details menu displays.

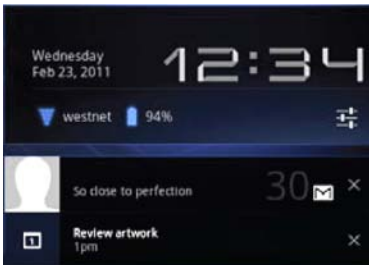

(Sample Image) Status Details menu screen

- ❖ Touch any open area of the display screen to close the Status Details menu.

Or

- ❖ Touch anywhere in the Status Details menu to display the Quick Settings menu.



The Quick Settings menu displays below the Status Details menu, replacing the list of current notifications.





(Sample Image) Quick Settings menu screen

- 2 Touch the **Settings** (⚙️) icon to open the Settings menu, and then select the setting you wish to change.

The following are icons you will find in the Quick Settings menu.

Icon	Name	Description
	Airplane mode	Touch to turn ON/OFF Airplane mode, see “Wireless and networks settings” on page 69 .
	Wi-Fi®	Touch to view the current Wi-Fi® connections, see “Wireless and networks settings” on page 69 .
	Lock screen orientation	Touch to turn ON/OFF screen rotation, see “Screen settings” on page 72 .

NOTE This may also be locked/unlocked by using the screen rotation lock/unlock switch.

	Screen brightness	Touch to adjust the screen brightness, see “Screen settings” on page 72 .
	Notifications	Touch to turn ON/OFF Notifications, see “Sound settings” on page 71 .
	Settings	Touch to select the tablet setting you wish to change, see “Apps and Settings menus” on page 64 .



Wireless and networks settings

Use the Wireless & networks settings to configure and manage connections to networks and devices via Wi-Fi®, or *Bluetooth*®. For more information, see [“Setting up Wi-Fi® and Bluetooth® connections” on page 44](#). The Wireless & Networks settings can also be used to configure connections between your tablet and virtual private networks (VPNs), and to turn off the device's radios while in-flight.

To change the **Wireless & networks** settings:

- 1 Touch the **Apps** (⌘ Apps) icon.
The Apps menu appears.
- 2 Swipe to the second screen, and touch the **Settings** (⚙️) icon.
The Settings menu appears.

- 3 Touch the **Wireless & networks** ( icon).
The Wireless & networks menu appears.
- 4 Touch the item you wish to change in the Wireless & networks menu.

Below are some of the categories to choose from:

- ❖ **Airplane mode**—Select to turn off the tablet's radios that transmit data.
- ❖ **Wi-Fi**—Select to turn on Wi-Fi® so you can connect to Wi-Fi® networks.
- ❖ **Wi-Fi settings**—See [“Setting up Wi-Fi® and Bluetooth® connections” on page 44.](#)

In addition to the settings described in this section, you can touch the **Menu** () button in this screen's Application bar and touch **Advanced** to view the settings in the “Advanced Wi-Fi settings screen.”

- ❖ **Wi-Fi**—Select to turn on Wi-Fi® so you can connect to Wi-Fi® networks. The network name is displayed when a network is connected.
- ❖ **Network notification**—If this is selected, you will receive a notification in the System bar when an open Wi-Fi® network becomes available.
- ❖ **Wi-Fi networks**—Displays a list of Wi-Fi® networks you've previously configured and those detected when the tablet last scanned for Wi-Fi® networks. See [“Setting up your Wi-Fi® connection” on page 40.](#)
- ❖ **Add Wi-Fi network**—Touch to open a dialog box to add a Wi-Fi® network by entering its SSID (the name it broadcasts), security type, and other properties. See [“Setting up your Wi-Fi® connection” on page 40.](#)
- ❖ **Bluetooth**—Select to turn on *Bluetooth*® so you can connect to *Bluetooth*® devices, such as an external keyboard.
- ❖ **Bluetooth settings**—For more information, see [“Setting up Wi-Fi® and Bluetooth® connections” on page 44.](#)
- ❖ **Bluetooth**—Select to turn on *Bluetooth*® so you can connect to *Bluetooth*® devices.
- ❖ **Device name**—Touch to open a dialog box to give your tablet a name that is visible on some *Bluetooth*® devices. The current name is displayed.



- ❖ **Discoverable**—Select to make your tablet discoverable by other *Bluetooth*® devices for a brief period of time.
- ❖ **Bluetooth devices**—Displays a list of *Bluetooth*® devices that you've previously configured and those detected when the tablet last scanned for *Bluetooth*® devices.
- ❖ **Find nearby devices**—Touch to search for and display information about nearby *Bluetooth*® devices.



Sound settings

The Sound settings can be configured to set the audio for media playback, notifications, and alarms with the desired volume level and notification sounds. You can also set audible feedback when touching or locking and unlocking the screen.

To change the **Sound** settings:

- 1 Touch the **Apps** ( Apps) icon.
The Apps menu appears.
- 2 Swipe to the second screen, and touch the **Settings** ( icon).
The Settings menu appears.
- 3 Touch the **Sound** ( icon).
The Sound menu appears.
- 4 Touch the item you wish to change in the Sound menu.

Below are some of the categories you can choose from:



- ❖ **Volume**—Select to open a screen containing three sliders, used to adjust media volume, notification sounds, and alarm sounds.
- ❖ **Notification sounds**—Select to open a screen containing a list of notification sounds. Touch a notification sound to listen to a sample of it.
- ❖ **Audible selection**—Select to hear a sound while touching the buttons, icons, and other onscreen items.
- ❖ **Screen lock sounds**—Select to hear a sound when locking or unlocking the screen.



Screen settings

You can change the Screen settings for various things, such as orientation of the display or brightness level for energy conservation.

To change the Screen settings:

- 1 Touch the **Apps**  icon.
The Apps menu appears.
- 2 Swipe to the second screen, and touch the **Settings**  icon.
The Settings menu appears.
- 3 Touch the **Screen**  icon.
The Screen menu appears.
- 4 Touch the item you wish to change in the Screen menu.



Below are some of the categories you can choose from:

- ❖ **Screen time-out**—Displays a list of time interval settings that indicate the amount of time it takes for the screen to time-out. Using the shortest time-out period extends the battery life between charges.
- ❖ **Brightness**—Displays the Brightness control bar screen. To change the brightness level, uncheck the Automatic brightness option. Then touch and slide the bar left or right to decrease or increase the screen brightness.
- ❖ **Auto-rotate screen**—Check the check-box to enable your screen to auto-rotate the screen in apps, Web pages, and games that support auto-rotation. This allows the screen to automatically switch the orientation of the currently viewed screen as you turn the tablet sideways or upright.
- ❖ **Animation**—Displays a list of settings to enable or disable animation while navigating your tablet in menus, screens, and apps that support it.



Multimedia settings

Change the way in which your tablet displays media playback in videos, music, photos, etc.

- 1 Touch the **Apps**  icon.
The Apps menu appears.
- 2 Swipe to the second screen, and touch the **Settings**  icon.
The Settings menu appears.

- 3 Touch the **Multimedia** (📺) icon.
The Multimedia menu appears.
- 4 Touch the item you wish to change in the in the Multimedia menu.



Location and security settings

Use the Location & security settings to configure how you want the tablet to determine your location (this affects accuracy), and the way in which you want to share your location with Google™ and others. Security settings can also be configured to help secure your tablet and its data.



Do not use this device while driving.

To change the **Location & security** settings:

- 1 Touch the **Apps** (📱 Apps) icon.
The Apps menu appears.
- 2 Swipe to the second screen, and touch the **Settings** (⚙️) icon.
The Settings menu appears.
- 3 Touch the **Location & security** (📍) icon.
The Location & security menu appears.
- 4 Touch the item you wish to change in the Location & security menu.

Below are some of the categories you may choose from:

- ❖ **Use wireless networks**—Under **My Location**, selecting this option allows your tablet to use information from Wi-Fi® and networks to determine your approximate location. This is important for use in Maps and other geographically aware applications, etc. You will be asked if you consent to sharing your location anonymously with Google's location service, in order help improve the service.
- ❖ **Use GPS satellites**—Under **My Location**, selecting this option allows your tablet's global positioning system (GPS) receiver to pinpoint your location to within as close as several meters (street level). Actual GPS accuracy depends on weather conditions, as well as other factors.
- ❖ **Use location for Google Search**—Under **My Location**, select this option to include information about your location when you use Google Search, Voice Search, etc.

- ❖ **Configure lock screen**—Under **Screen unlock**, touch this option to configure your lock screen with a required pattern, PIN, or password to unlock the screen. For more information, see “[Securing your tablet](#)” on page 53.
 - ❖ **Owner info**—Under **Screen unlock**, touching this option displays a screen that allows you to display information about yourself (such as your contact information) on the lock screen. You will be prompted to enter the text you wish to display.
 - ❖ **Encrypt tablet**—Under **Screen unlock**, touch this option to encrypt the contents of your tablet in the event that it is powered off. Configure a required numeric PIN or password to decrypt your tablet each time you power it on, see “[Securing your tablet](#)” on page 53.
-

CAUTION

If you choose to set a password (with or without encryption), Toshiba strongly recommends that you write down your password and keep it in a safe location where you can later access it should you not remember it.

Toshiba is not responsible for any losses that may occur, as a result of the inability to access your device.

- ❖ **Visible passwords**—Under **Passwords**, select this option to briefly display each character of your passwords as you enter them into the keyboard.
- ❖ **Select device administrators**—Under **Device administration**, touch open a screen with a list of the applications you have authorized to be administrators for your tablet. This is typically an email, calendar, or other enterprise application that you granted this authority to, when you added an account hosted by an enterprise service that requires the ability to implement security policies on any devices that connect to it. Touch an application in this list to disable its authority to be a device administrator; if you do, the account you added will typically lose some functionality in its applications, such as the ability to sync new email or calendar events, until you restore the application's authority as a device administrator. Applications whose device administration authority you disable in this way, but that have accounts that require them to be a device administrators, typically notify you how to restore their authority when you try to use them, unless you delete those accounts.

- ❖ **Use secure credentials**—Under **Credential storage**, select to allow applications to access your tablet's encrypted store of secure certificates and related passwords as well as other credentials. Credential storage is used to establish some kinds of VPN and Wi-Fi® connections, see “[Setting up Wi-Fi® and Bluetooth® connections](#)” on page 44. This setting is dimmed if you do not set a password for credential storage.
- ❖ **Install from storage**—Under **Credential storage**, select to install a secure certificate from your tablet's storage.
- ❖ **Set password**—Under **Credential storage**, touch to open a dialog box. Enter the password you wish to use to set or change an existing password for your secure credential storage. Your password must have at least 8 characters.
- ❖ **Clear storage**—Under **Credential storage**, select to delete all secure certificates and related credentials. You will be prompted to also confirm deletion of the credential storage password.



Applications settings

You use the Applications settings to view details about the applications installed on your tablet, to manage their data, to force them to stop if needed, and to set whether you want to permit installation of applications that you obtain from Web sites and email.

To change the **Applications** settings:

- 1 Touch the **Apps** (📱 Apps) icon.
The Apps menu appears.
- 2 Swipe to the second screen, and touch the **Settings** (⚙️) icon.
The Settings menu appears.
- 3 Touch the **Applications** (📱) icon.
The Applications menu appears.
- 4 Touch item you wish to change in the Applications menu.

Below are some of the categories you can choose from:

- ❖ **Manage applications**—Displays a list of the applications and other software installed on your tablet. The file information is available for each item.
- ❖ **Running services**—Displays a list of applications, processes, and services currently running.
- ❖ **Storage use**—Displays a list of the applications that are currently using memory resources on your tablet.

-
- ❖ **Battery use**—Displays a list of the applications using battery power since you last charged your tablet.





Accounts & sync settings

You can add, remove, and manage your Google™ Accounts and other accounts, using the Accounts & sync settings. For more information, see [“Syncing and managing your accounts” on page 59](#). Use these settings to also control the ways in which applications send, receive, and sync data on their own schedules, or how applications synchronize user data automatically.

Gmail™, Calendar, and other applications may have their own setting options. For details, refer to the application's documentation.

To change the **Accounts & sync** settings:

- 1 Touch the **Apps**  icon.
The Apps menu appears.
- 2 Swipe to the second screen, and touch the **Settings**  icon.
The Settings menu appears.
- 3 Touch the **Accounts & sync**  icon.
The Accounts & sync menu appears.
- 4 Touch the item you wish to change in the Accounts & sync menu.

Below are some of the categories you can choose from:

- ❖ **Background data**—Select to allow applications to synchronize data in the background even if the application is not currently being used. Disabling this setting can save battery power and data use.
- ❖ **Auto-sync**—Select to allow applications to synchronize data on their own schedule.

NOTE

If Background data is not selected, automatically synchronizing data is disabled and data will need to be manually synchronized in each application that supports it.

-
- ❖ **Manage accounts**—You can manage your Google Accounts and others you have added to the tablet by touching an account on this screen.

The account's screen displays.



- ❖ **Account screen**—The options available on this screen depend on the account screen you have displayed. You can choose to turn ON/OFF synchronize for each account, or touch the **Synchronize** button at the top right of the Application bar to synchronize data now. Touch **Remove account** to remove the account and all its data. For more information, see “[Privacy settings](#)” on page 77.



Privacy settings

You can use the Privacy settings to back up your settings and data to Google™ servers, using your Google Account. You can also perform a factory data reset to erase all data on your tablet. For more information, see “[Backing up your data](#)” on page 45.

To change the **Privacy** settings:

- 1 Touch the **Apps** ( Apps) icon.
The Apps menu appears.
- 2 Swipe to the second screen, and touch the **Settings** ( icon).
The Settings menu appears.
- 3 Touch the **Privacy** ( icon).
The Privacy menu appears.
- 4 Touch the item you wish to change in the Privacy menu.

Below are some of the categories you can choose from:

- ❖ **Back up my data**—Select to back up your personal data (Wi-Fi® passwords, Browser bookmarks, etc.) to Google servers, with your Google Account. Your data can be restored to a new tablet the first time you sign in with your Google Account. Some third-party applications may also take advantage of this feature, allowing you to restore the associated data of a reinstalled application.

NOTE

If you disable this option, data will no longer be backed up to your Google Account. All existing backed up data is deleted from Google servers.

- ❖ **Backup account**—Displays the Google Account used to back up your settings and data. Sign in to this account to restore your settings and data to a new tablet or other device.
- ❖ **Automatic restore**—Select this option to restore the associated settings and data when reinstalling an application.

-
- ❖ **Factory data reset**—See “Factory data reset” on page 62.
-

CAUTION



The recovery process deletes all data, restoring the tablet to its out-of-box state. Be sure to save your data to external media before executing the recovery), see “Backing up your data” on page 45.)



Storage settings

The Storage settings can be used to monitor the used and available space in your tablet's internal storage and other storage media installed on your tablet.

To change the **Storage** settings:

- 1 Touch the **Apps**  icon.
The Apps menu appears.
- 2 Swipe to the second screen, and touch the **Settings**  icon.
The Settings menu appears.
- 3 Touch the **Storage**  icon.
The Storage menu appears.
- 4 Touch the item you wish to change in the Storage menu.



You can also view and manage the amount of storage used by your applications.



Language & input settings

You can select the language and configure various input methods, such as the text-to-speech synthesizer for applications that support it.

To change the **Language & input** settings:

- 1 Touch the **Apps**  icon.
The Apps menu appears.
- 2 Swipe to the second screen, and touch the **Settings**  icon.
The Settings menu appears.
- 3 Touch the **Language & input**  icon.
The Language & input menu appears.
- 4 Touch the item you wish to change in the Language & input menu.

Below are some of the categories you can choose from:

- ❖ **Select language**—Select to open the Language screen, and then select your preferred language for use on your tablet.
- ❖ **User dictionary**—Select to open a list of the words you've added to the dictionary. Touch a word to edit it, or touch the red **X** next to a word to delete it. Touch the **Plus** button at the top right of the Application bar to add a word.
- ❖ **Voice recognizer settings**—Select to open a screen that allows you to configure the following settings:
 - ❖ **SafeSearch**—Set whether you want Google™ SafeSearch filtering to block some search results when using Google Voice Search.
 - ❖ **Block offensive words**—Select to have your Google voice recognition replace offensive words with hash symbols (#).
 - ❖ **Personalized recognition**—To improve the device's recognition of your own voice, select this option.
 - ❖ **Google Account dashboard**—Touch to view your Google™ Account dashboard in a Web browser. You can view and manage the information associated with your Google Account.
- ❖ **Text-to-speech settings**—Select to open a screen that allows you to configure the following settings:

NOTE

Only the **Install voice data** setting is available if you do not have a speech synthesizer application installed.

- ❖ **Listen to an example**—Using your current settings, a brief sample of the speech synthesizer is played.
- ❖ **Always use my settings**—Select to use the settings on your device, rather than an application's speech synthesizer settings.
- ❖ **Default engine**—If you have more than one text-to-speech application installed, select to set one of them as the default application.
- ❖ **Install voice data**—If you do not have a speech synthesizer application installed on your device, this option connects to Android Market and guides you through the download process.

NOTE The **Install voice data** setting is not available if a synthesizer application is already installed on your device.

- ❖ **Speech rate**—Touch to select the speed in which you would like the synthesizer to speak.
 - ❖ **Language**—Touch to select the text language you wish your synthesizer to speak.
 - ❖ **Engines**—Touch to view the text-to-speech applications installed on your device. Touch one to view or change its settings.
 - ❖ **Current input method**—Select to open the screen, and then select the input method you wish to use, if more than one is installed. Touch **Configure input methods** to open the screen, and then configure the current input method. Alternative keyboards and other input methods can be downloaded from Android Market™.
 - ❖ **Input method selector**—Select to open the screen, and then choose whether you want the Input Selector button to appear in the System bar, to the left of the Time display.
 - ❖ **Configure input methods**—Select to open a screen that allows you to configure the following settings:
 - ❖ **Active input methods**—Touch to select the languages you want available when speaking and typing, using the onscreen keyboard and voice input. When languages are specified, the Input Method button appears in the System bar when the onscreen keyboard is used.
 - ❖ **Settings**—Touch to select the keyboard settings you wish to use (**Auto-capitalization**, **Sound on keypress**, **Auto-correction**, **Show correction suggestions**).
-

NOTE The correction and capitalization features are supported only in English.



For more information on using the onscreen keyboard, see [“Using the onscreen keyboard” on page 87](#).



Accessibility settings

Use the Accessibility settings to configure any plug-ins that are installed on the tablet.

To change the **Accessibility** settings:

- 1 Touch the **Apps** () icon.
The Apps menu appears.
- 2 Swipe to the second screen, and touch the **Settings** () icon.
The Settings menu appears.
- 3 Touch the **Accessibility** () icon.
The Accessibility menu appears.
- 4 Touch the item you wish to change in the Accessibility menu.

Below are some of the categories you can choose from:



- ❖ **Accessibility**—Select to enable all installed accessibility plug-ins.
- ❖ **KickBack**—Select to allow the tablet to vibrate briefly while navigating, using the buttons, icons, keyboard, etc.
- ❖ **TalkBack**—Select to allow the tablet's installed speech synthesizer to announce the labels of the buttons, icons, etc. while navigating the tablet.
- ❖ **SoundBack**—Select to hear a sound each time you touch a button, icon, etc.
- ❖ **Accessibility scripts**—Select to hear a sound each time you touch a button, icon, etc.



Date & time settings

Use the Date & time settings to configure your preferences for the way in which dates are displayed.

To change the **Date & time** settings:

- 1 Touch the **Apps** () icon.
The Apps menu appears.
- 2 Swipe to the second screen, and touch the **Settings** () icon.
The Settings menu appears.
- 3 Touch the **Date & time** () icon.
The Date & time menu appears.
- 4 Touch the item you wish to change in the Date & time menu.

Below are some of the categories you can choose from:



- ❖ **Automatic date & time**—Clear the selection to set the date and time manually.
- ❖ **Automatic time zone**—Clear the selection to set the time zone manually.
- ❖ **Set date**—If **Automatic date & time** is cleared, a screen opens to set the date manually.
- ❖ **Set time**—If **Automatic date & time** is cleared, a screen opens to set the time manually.
- ❖ **Select time zone**—If **Automatic time zone** is cleared, a screen opens to set the time zone manually.
- ❖ **Use 24-hour format**—Select to display the time using a 24-hour time format (i.e. 13:00, rather than 1:00).
- ❖ **Select date format**—Select to open a screen to select the displayed date's format.



About tablet

The About tablet menu displays information regarding your operating system software and hardware.

To view the **About tablet** information:

- 1 Touch the **Apps**  icon.
The Apps menu appears.
- 2 Swipe to the second screen, and touch the **Settings**  icon.
The Settings menu appears.
- 3 Touch the **About tablet**  icon.
The About tablet menu appears.
- 4 Touch the item you wish to view in the About tablet menu.

Below are some of the categories you can choose from:

- ❖ **System updates**—Select to open a screen that lists the availability of operating system software updates.
- ❖ **Status**—Select to open a screen that displays information about your battery, network connections, etc.

- ❖ **Battery use**—Select to open a list of the applications and operating system components used since you last charged the tablet.
- ❖ **Legal information**—Select to open a screen that displays legal information about the system software included with your tablet.
- ❖ **Version information**—Select to open a screen that lists details about the model and version of your tablets's hardware and operating system software.

Chapter 3

Working with Apps

Downloading Toshiba Apps

You can download Toshiba apps from the Toshiba App Place™ by touching the App Place™ icon.

NOTE To download apps, you must be connected to the Internet.

TOSHIBA Media Player

The TOSHIBA Media Player is a multimedia player that allows users to experience outstanding multimedia viewing enjoyment.

The TOSHIBA Media Player supports a number of multimedia content formats. For detailed information regarding supported file formats, see the detailed specifications for your device at tabletsupport.toshiba.com.

NOTE Toshiba does not guarantee that all audio/video files will play correctly.

On the Media Player's main screen, touch the **Menu**  button to open the following options:

- ❖ **About**—Displays version information, etc.

- ❖ **Capture Photo**—Turns on the camera application in photo mode.
- ❖ **Capture Video**—Turns on the camera application in video mode.
- ❖ **Help**—For more information, refer to the TOSHIBA Media Player Help file.

TOSHIBA Resolution+®

NOTE Viewing enhancements may vary depending upon content quality and display device capability/functionality/settings. Depending on the quality of the content, some video noise may be visible.

This technology upconverts standard-definition video content, instantly improving sharpness and color, for a higher quality visual experience. For more information, see “[TOSHIBA Resolution+®](#)” on page 104.

Apps

In Android Market™ you will have direct access to more than 100,000 apps. Search for your favorite games, apps, wallpapers, and more to customize your tablet.

To learn more, visit the Google™ Help Center.

Downloading from Android Market™

On the first Home Screen, touch the **Market** (📦) icon. This opens Android Market™, allowing you to choose from the available apps, games, etc.

Preinstalled Apps on your tablet

Android Market™, Browser, Gmail™, Maps, YouTube™, Calendar, and Contacts apps are preinstalled on your tablet and the shortcuts for them appear on your Home screen. You can move the icons for these applications to other Home screens to customize the look of your tablet, see “[Moving an item from the Home screen](#)” on page 56.

You can install many more apps, widgets, games, etc. by visiting the Toshiba App Place™ or Android Market.

Uninstalling Apps on your tablet

To uninstall applications from your tablet.

- 1 Touch the **Apps**  icon.
- 2 Touch & hold the icon that represents the application you want to delete, and then drag it to the Trash can.
- 3 Confirm the deletion.

NOTE

Applications that came preinstalled on your tablet cannot be deleted from the device.

Chapter 4

Exploring the Features on your Device

Using the onscreen keyboard

Your tablet comes with an onscreen keyboard.

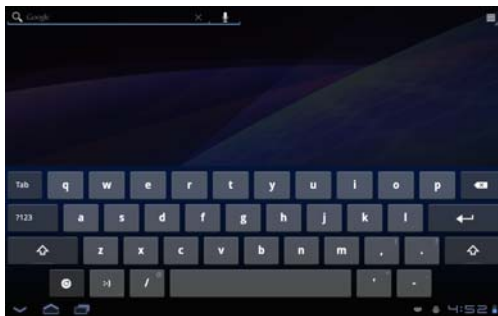

(Sample Image) Onscreen keyboard

Enter text using the onscreen keyboard. Some applications open a text field that when touched, opens the onscreen keyboard allowing you to enter text. Some apps open the keyboard automatically.

The onscreen keyboard has a number of settings. For more information, see [“Language & input settings”](#) on page 78.

Type to enter text

To begin typing, touch the text field in the application you are using to open the onscreen keyboard.



(Sample Image) Touching a text field to type

An insertion point tab (⏏) appears where you touch the text field. If text has been previously entered you can drag the insertion point by its tab to move it to the location in the text line you wish to begin typing from.

You may also select one or more words to copy, cut, and paste:

- 1 Select the text you wish to cut or copy.



(Sample Image) Touching a text field to type

- 2 Touch **Cut** (✂ Cut) or **Copy** (📄 Copy) in the Application bar. Touching **Cut** removes the selected text from the text field, but it can be pasted into another text field.
- 3 Place the cursor in the text field where you want to place the text.



- 4 Touch **Paste** ( Paste) in the application bar.
The text is inserted into the new text field.

NOTE Text can be copied and pasted from one app to another.

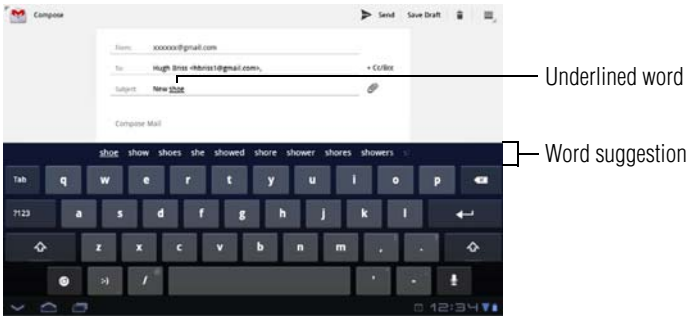
- ❖ Touch the space bar or a punctuation mark to auto complete a word you are typing.
- ❖ Touch the **Shift** () key one time to capitalize the next letter typed.
- ❖ Double-tap the **Shift** key to capitalize all of the letters you type. Touch the **Shift** key again to type in lower case.



(Sample Image) Touching a text field to type

- ❖ While typing, spelling suggestions and similar word suggestions appear just above the keyboard. Touch a word suggestion to use it in place of the underlined word in the text field. To change the input settings, see [“Language & input settings” on page 78](#).
- ❖ Touch the **Delete** () key to erase characters to the left of the cursor.
- ❖ Touch the Number and Symbols () key to type numbers, symbols, and other special characters.
- ❖ Touch the Close Keyboard () button when you are finished.

You can change the language you want to use by touching the Input Method () button, or by going to the Settings menu, see [“Language & input settings” on page 78](#).

Speak to enter text

You can use the speech-recognition feature to input text to the onscreen keyboard.

- 1 Touch the text field.
- 2 Touch the Microphone (🎤) key on the keyboard.
- 3 Speak your text when you are prompted to “Speak now.”
The speech-recognition types the words you say.
- 4 To enter punctuation, say “comma,” “period,” “exclamation mark,” etc.
The text you enter by speech is underlined.
- 5 Touch the **Delete** (✖) key to erase the underlined text, or the **Send** (▶ Send) button to accept the text.

You can change the language you want to use by touching the Input Method (IM) button, or by going to the Settings menu, see “Language & input settings” on page 78.

Using the built-in speakers

Your tablet is equipped with internal speakers. To increase or decrease the volume, use the volume control buttons on the side of your tablet.

You can silence your tablet, so that your notifications are announced with a vibration instead of a tone. To place your tablet into Silent mode do one of the following:

- ❖ Using the volume decrease button to turn the volume down completely.
The lowest setting places your tablet into Silent mode.
- ❖ Press and hold the power button, and then touch **Silent mode**.

Using external speakers or headphones

Instead of using the internal speakers, you can connect headphones or a pair of external stereo speakers.

CAUTION

Do not set the volume too high on this device or when using headphones. Continuous exposure to loud sound can harm your hearing. Discontinue use and consult a physician if you experience any hearing discomfort.



TECHNICAL NOTE: When using amplified speakers, use speakers that require an external power source. Other types of speakers will be inadequate to produce sound from the device.



To play back sound files through external speakers or headphones:

- 1 Locate the headphone jack on the device.
- 2 Using any necessary adapters, plug the cable from the headphones or external speakers into the headphone jack.

The headphone jack requires a 16-ohm stereo mini connector.

To adjust the volume:

- ❖ For external speakers, use the volume controls on each speaker.
- ❖ For headphones, use the device's volume control.

Recording sounds

You may record sounds using the internal microphone on the device or by connecting an optional external microphone.

Using the cameras

Your device comes with a built-in camera on the front and one on the back of the tablet. With these cameras you can do the following:

- ❖ Take pictures and record videos with your device
- ❖ Chat with others and have them see you while using instant messaging (IM) programs
- ❖ Have video conference calls

NOTE

To email, instant message or video conference, you must be connected to the Internet.

The camera indicator light glows when the front camera is active.

Using an SD™ Card

For detailed information regarding supported SD™ Cards, see the detailed specifications for your device at tabletsupport.toshiba.com.

The SD™ Card reader supports the use of Secure Digital™ (SD™) media. This media can be used with a variety of digital products: digital music players, cellular phones, PDAs, digital cameras, digital video camcorders, etc.

CAUTION

To avoid damaging your tablet device when using a micro or mini SD™ Card, an SD™ adapter is required.

Inserting memory media**CAUTION**

When inserting memory media, do not touch the metal contacts. You could expose the storage area to static electricity, which can destroy data.

To insert an SD™ Card:

- 1 Turn the media so that the contacts (metal areas) are face down.
- 2 Push the media into the adapter until it locks in place.

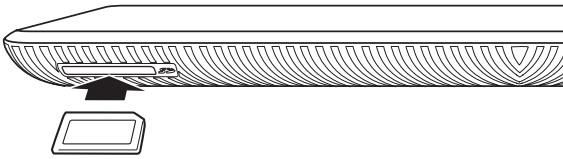

(Sample Illustration) Inserting memory media

Removing memory media**CAUTION**

Do not remove media while data is being written or read, or your data could be destroyed.

To prepare the card for removal:

- 1 Touch the **Apps** (📁 Apps) icon.
The Apps menu appears.
- 2 Swipe to the second screen, and touch the **Settings** (⚙️) icon.
The Settings menu appears.
- 3 Touch the **Storage** (💾) icon.
The Storage menu appears.
- 4 Touch **Unmount SD card**.
- 5 Gently press the card inward to release it.
The card pops out slightly.

- 6 Grasp the card and pull it straight out.

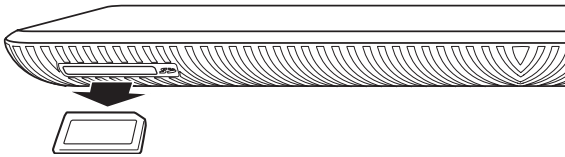

(Sample Illustration) Removing memory media

Adding optional external devices

After starting your device for the first time you may want to:

- ❖ Connect a mouse (see “Using an external mouse” on page 94)
- ❖ Connect an external keyboard (see “Using an external keyboard” on page 94)
- ❖ Connect an external monitor (see “Using external devices” on page 93)

Using external devices

You can connect external devices to your device using the following available ports:

NOTE

Not all USB or HDMI™ devices are compatible with your tablet. Check with the manufacturer of the external device for compatibility.

- ❖ A USB port—Connect an external keyboard or mouse, or backup your data to an external hard drive or flash drive.



TECHNICAL NOTE: When using external USB media, you may need to reformat the media in the exFAT file system. For information on how to do this, contact the manufacturer of the media device.

- ❖ An HDMI™ Out port—Connect an HDMI™-compatible television or display device to your tablet.

NOTE

To connect a device to the HDMI™ Out port, you must purchase an HDMI™ cable.

- ❖ A Mini-USB port—Supports data transfer.

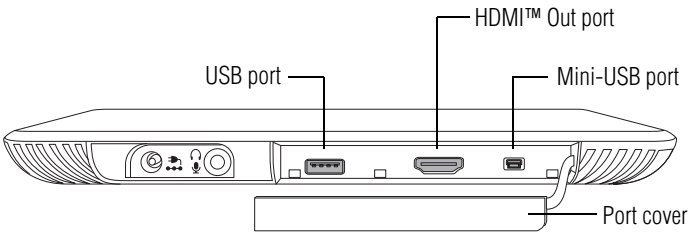

(Sample Illustration) External device ports on the bottom of the tablet

Connecting an HDMI™-compatible television or display device

To connect an HDMI™-compatible television or display device to the device:

- ❖ Connect one end of an HDMI™ cable (not included with your device) to the HDMI™ Out port on the side of your device, and then connect the other end of the cable to your television or display device. Refer to the manual that came with the television or display device for more information.

Your device will automatically detect the external display device.

Using an external keyboard

If you prefer to use an external keyboard, you can attach one to your device via the USB port. You can also pair a *Bluetooth*® enabled keyboard using the available *Bluetooth*® connectivity on your device. For more information, see “[Setting up Wi-Fi® and Bluetooth® connections](#)” on page 44 and “[Using external devices](#)” on page 93.

NOTE Some keyboard functionality may not be supported.

Using an external mouse

You may want to use an external mouse instead of the device’s touch screen. The device’s USB port supports a USB-compatible mouse.

NOTE Some mouse functionality may not be supported.

Using a docking station

The docking connector, located on the side of your tablet device, is used to attach your device to a docking station (not shipped with your system).

You can leave network cables and external devices (such as an external keyboard, mouse, speakers, and USB devices) connected to the docking station when the tablet is not connected to it. This allows you to quickly connect your tablet to the docking station and have immediate access to all of your network resources and external devices. This eliminates the time-consuming process of connecting each external device individually, and saves wear and tear on the ports and cables.

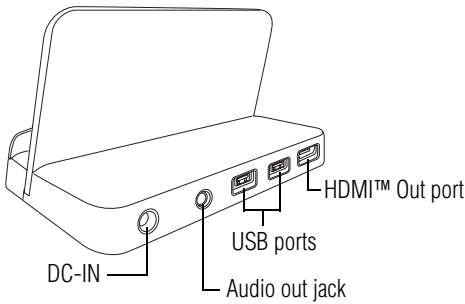

(Sample Illustration) Docking station - Back

To achieve a proper connection between your tablet and the docking station, your tablet must be properly aligned with the docking station. For more information, consult the user's manual that came with your docking station, or visit support.toshiba.com.

To find a docking station that is compatible with your tablet device, please visit accessories.toshiba.com.

Connecting your tablet to a docking station

- 1 Connect the power cord to the AC adaptor (provided with your tablet device).

NOTE Additional Toshiba AC adaptors can be purchased separately at accessories.toshiba.com.

- 2 Connect the AC adaptor cord to the DC-IN on the back of the dock.
- 3 Connect the other end of the power cord to a live electrical outlet.

- 4 Remove the docking connector cover on the side of your tablet.

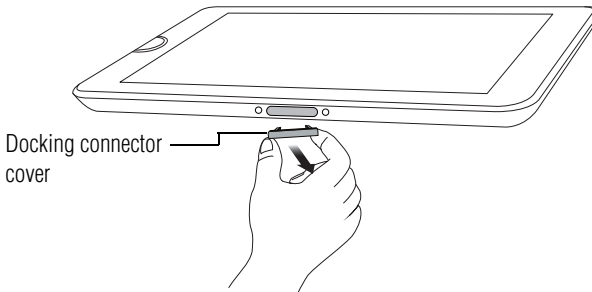

(Sample Illustration) Removing the docking connector cover

- 5 Align the docking interface located on your tablet with the docking connector on the dock.

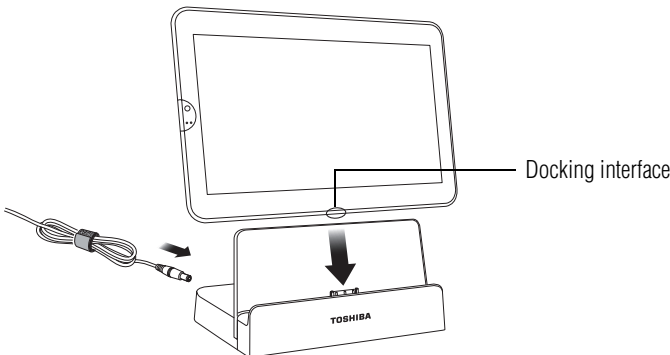

(Sample Illustration) Aligning the docking interface with the docking connector

NOTE Not all USB devices are compatible. Check with the manufacturer of the USB device for compatibility.

The tablet charging light glows amber while charging, and glows white when fully charged.

Chapter 5

Utilities

Your device includes several utilities designed to help you reconfigure your system to best meet your individual needs. Together, these allow you to ascertain certain system details, set additional options, or change default options. These utilities are described in this chapter.

NOTE The utilities described in this chapter, and the icons shown in the sample images are applicable only if the related utility is available on your system.

- ❖ TOSHIBA Service Station
- ❖ TOSHIBA File Manager Utility
- ❖ TOSHIBA Adaptive display
- ❖ TOSHIBA Resolution+®

TOSHIBA Service Station

The TOSHIBA Service Station utility provides you with updates for both application and system software. It notifies you when new versions of your system software are available, and then prompts you to download and install them.

To open TOSHIBA Service Station:

- 1 Touch the **Apps** () icon.
- 2 Touch the **Service Station** () icon.

The TOSHIBA Service Station screen appears.

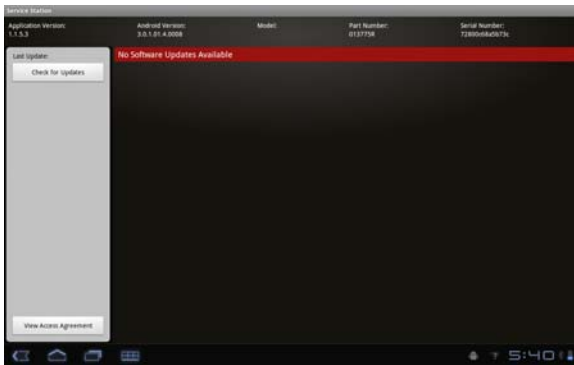

(Sample Image) TOSHIBA Service Station screen

The first time TOSHIBA Service Station is run, you will be prompted to accept the access agreement. This agreement authorizes the utility to collect certain basic information about your device and send it to the Toshiba servers as part of the process of obtaining updates.



(Sample Image) TOSHIBA Service Station Acceptance screen

Touch the **Accept** button (recommended) to accept the agreement or touch the **Decline** button to decline.

NOTE The TOSHIBA Service Station utility will not be able to notify you of new software and application updates if you choose to decline the agreement.

The main screen of this application includes the following areas:

- ❖ **Header**—This section runs along the top of the screen and contains basic information about your system, such as the version of the OS, the device part number, and serial number.
- ❖ **Buttons**—Buttons are displayed on the screen. Depending on the actions you have available, the buttons will vary.
- ❖ **Information**—The main part of the screen displays information, such as the list of available updates, or more detailed information about each specific update.

Check for application updates

During normal operations, the TOSHIBA Service Station will periodically check for updates to your system. This is done automatically. You will be notified with the **TOSHIBA Service Station** icon in the Status bar when new updates become available.

You can also check for updates manually. Touch the **Check for Updates** button. The application will refresh the list of available updates.

NOTE Connect the AC adaptor before updating.

Downloading updates

NOTE Toshiba strongly recommends before downloading updates to back up your data and settings.

Touch the **TOSHIBA Service Station**  icon in the Status bar when an update becomes available to display additional information about that item. To download the update, touch the **Download** button. The update begins to download and displays a progress indicator in the Notification bar.

NOTE Touch the Home () button to allow the download to continue while you use your tablet. A notification of download completion appears in the Status bar.

To discontinue the download process, touch the Back () button.

Installing updates

Once an update has been successfully downloaded, it can be installed.

- 1 Touch the **Download completion** notice on the Status bar.
- 2 Touch the **Install** button.
The application installer launches.
- 3 Confirm the installation to continue.

Downloading and installing System updates

TOSHIBA Service Station downloads both application and system updates. System updates require the device to be rebooted during the update process.

Installing a system update is similar to an application update, however you will be reminded that the device will automatically reboot during the update process. Make sure to close any applications and save all data prior to installing a system update.

CAUTION

Do not interrupt or turn off your tablet during a system update once it has begun. Data loss may occur.

TOSHIBA File Manager Utility

Using the TOSHIBA File Manager, you can back up your data to an SD™ Card, or an external USB storage device.

- 1 Insert an SD™ Card into the SD™ Card slot, or an external USB device via the USB port on your tablet. For more information, see “Using an SD™ Card” on page 91.

NOTE



Not all USB or HDMI™ devices are compatible with your tablet. Check with the manufacturer of the external device for compatibility.

- 2 Touch the **Apps** ( Apps) icon.
- 3 Touch the **File Manager** () icon.



The TOSHIBA File Manager screen appears.





(Sample Image) TOSHIBA File Manager screen

- 4 Make sure the **Internal Storage** () icon, at the top left corner, is selected.
- 5 Touch the **Select File** ( Select File) icon at the bottom of the screen, and then touch the files/folders you wish to back up, or touch the **Select All** ( Select All) icon.

A red check mark () indicates the selected files/folders.

- 6 Touch the **Copy** ( Copy) icon at the bottom of the screen.
- 7 Touch the **SD** () icon or the **USB** () icon in the top left corner of the screen.

Touching the **SD** () icon displays the file/folder content on the SD™ Card.

Touching the **USB** () icon displays the file/folder content on the external USB storage device.



TECHNICAL NOTE: When using external USB media, you may need to reformat the media in the exFAT file system. For information on how to do this, contact the manufacturer of the media device.

- 8 Select the folder you want to copy the files to, and then touch the **Paste** () icon at the bottom of the screen.

The files are copied to the SD™ Card or external USB storage device.

File browsing screen

The available options in the File browsing screen are:

- ❖ **Device**—Internal storage, SD™ Card, and USB storage are displayed.
- ❖ **Path**—The device name is displayed on the left side of the screen, and the relative path is displayed on the right.
- ❖ **File**—Files/folders are listed in multi-columns with thumbnails showing the file information, such as name, modified date/time, etc. The selected files/folders are tagged in red.
- ❖ **Control**—You can select files, create folders and go to the top level directory by selecting different options.

Operation of files/folders

Touch **Select File** to open a screen, enabling you to multi-select, copy, cut, and delete selected files/folders.

The available options in this screen are:

- ❖ **Select All**—Touch to select all of the files/folders in the current path.
The selected files/folders are tagged in red.
- ❖ **Deselect All**—Touch to deselect all the files/folders in the current path.
- ❖ **Cancel**—Touch to cancel file operation and return to the file browsing screen.
- ❖ **Copy**—Touch to copy the selected files/folders to a target path. After choosing the correct path, touch **Paste** to copy the files/folders into the target directory.
- ❖ **Cut**—Touch to cut the selected files/folders and paste them to a target path. After choosing the correct path, touch **Paste** to move the files/folders to the target directory.

- ❖ **Delete**—Touch to delete the selected files. Confirm the deletion in the pop-up window. Touch **OK** or **Cancel** to continue.

Touch & hold a file/folder to display a pop-up menu, enabling you to **Cut**, **Copy**, **Delete** or **Rename** the selected file/folder.

Rename files/folders

To rename a file/folder:

- 1 Touch & hold the selected file/folder.
- 2 Touch **Rename** in the pop-up window and create a new name for the selected file/folder.
- 3 Touch **OK**.



Create folders

To create a new folder:

- 1 Choose the desired top directory in the File browsing screen.
- 2 Touch **Create a folder**.
A pop-up window appears.
- 3 Create a new folder name.
- 4 Touch **OK** to continue.

Storage structure

The following describes the function of each of the icons on the TOSHIBA File Manager screen:

<i>Icon</i>	<i>Name</i>	<i>Description</i>
	Internal storage	Displays the file content of the device's internal storage, (excluding system files).
	SD™ Card	Displays the file content of the SD™ Card that is inserted into the SD™ Card slot.
	USB storage	Displays the file content of the attached USB storage device.

TOSHIBA Adaptive display

The Toshiba Adaptive display provides an enhanced visual experience in varying locations and conditions. It automatically adjusts the display brightness and gamma based on ambient light. It also automatically adjusts locally stored pictures and video content for optimal viewing.



TOSHIBA Resolution+[®]

This technology upconverts standard-definition video content, instantly improving sharpness and color, for a visual experience that looks and feels more like HD.

NOTE

Viewing enhancements may vary depending upon content quality and display device capability/functionality/settings. Depending on the quality of the content, some video noise may be visible.

To enable/disable these features:

- 1 Touch the **Apps**  icon.
The Apps menu appears.
- 2 Swipe to the second screen, and touch the **Settings**  icon.
The Settings menu appears.
- 3 Touch the **Multimedia**  icon.
The Multimedia menu appears.
- 4 Touch **Video Enhancement**.

Chapter 6

If Something Goes Wrong

Some problems you may encounter when using your tablet are relatively easy to identify and solve.

This chapter aims to help you solve many problems by yourself. It covers the problems you are most likely to encounter.

If all else fails, contact Toshiba. You will find information on Toshiba's support services at the end of this chapter.

Problems when you turn on the device

These problems may occur when you turn on the power.

The device will not start.

Make sure you attached the AC adaptor and power cord/cable properly or installed a charged battery.

If you are using the AC adaptor, check that the wall outlet is working by plugging in another device, such as a lamp.

Verify that the device is on by looking at the ON/OFF indicator. If the indicator is glowing, the device is on. Also, try turning the device off and then on.

The device starts but when you touch an icon nothing happens.

Your device may be in Sleep mode and have an application or resource conflict.

The operating system is not working

Once you are familiar with the Home screens and used to the way the operating system responds, you can easily detect if the it is not working correctly. For example:

- ❖ The operating system responds differently from the normal routine
- ❖ Screens and apps take a long time to load
- ❖ The screen does not look right

Unless a hardware device has failed, problems usually occur when you change the system in some way such as installing a new app or adding an external device.

If you experience any of these problems, use the About tablet setting to check for available system updates. For more information, see [“About tablet” on page 82](#).

Internet problems

My Internet connection is very slow.

Many factors contribute to the speed with which you can surf the Internet. They include: network speed, network conditions, time of day (when everyone else is surfing, your access can be slow) and popularity of the sites you are trying to access. If accessing a particular site is very slow, try later.

My browser cannot find the URL address I typed in.

Make sure you separated the domain names of the address with the forward slash (/). Check the spelling of each name and the syntax of the address carefully. A single incorrect letter or missed character will make it impossible for your browser to locate the site.

My browser cannot find a site I bookmarked.

The World Wide Web is constantly changing. A site you bookmarked yesterday may not be available today or its server may be down for temporary repair. Try again later.

Power and the batteries

Your device receives its power through the AC adaptor and power cord/cable or from the system battery. Power problems are interrelated. For example, a faulty AC adaptor or power cord/cable will neither power the device nor recharge the batteries.

Here are some typical problems and how to solve them:

The Power light does not come on when you plug in the AC adaptor and power cord/cable.

Make sure the AC adaptor and power cord/cable are firmly plugged into both the wall outlet and the device.

If the Power light still does not come on, check that the wall outlet is working properly by plugging in a lamp or other appliance.

The AC adaptor and power cord/cable work correctly, but the battery will not charge.

The battery does not charge while the device is consuming full power. Try turning off the device.

The battery may not be inserted correctly in the device. Turn off the device, remove the battery, clean the contacts with a soft dry cloth (if necessary) and replace the battery. See [“Removing the battery from the device” on page 32](#).

The battery may be too hot or too cold to charge properly. If you think this is the probable cause, let the battery reach room temperature and try again.

If the battery light does not glow after a few minutes, the battery may have reached the end of its useful life. Try replacing it.

The battery appears not to power the device for as long as it usually does.

If you frequently repeat shallow charge and discharge, the battery meter may become inaccurate. Let the battery discharge completely, then try charging it again.

Check the power options. For more information, see [“Optimizing battery life” on page 36](#). Have you added a device, such as a memory module, that takes its power from the battery? Is your software using the internal storage drive more? Is the display power set to turn off automatically? Was the battery fully charged to begin with? All these conditions affect how long the charge lasts.

After a period of time, the battery will lose its ability to perform at maximum capacity and will need to be replaced. This is normal for all batteries. To purchase a new battery, see your accessories information included with your device, or visit the Toshiba Web site at accessories.toshiba.com. Refer to this site often to stay current on the most recent software and hardware options for your device, and for other product information.

For more information on maintaining battery power, see “Charging the battery” on page 31.

Display problems

Here are some typical display problems and their solutions:

The screen does not look correct.

You can change the display settings by touching the **Settings**  icon on the Home screen. For more information, see “Screen settings” on page 72. You can also choose a theme for your Home screen background (Wallpaper).

Small bright dots appear on your TFT display when you turn on your device.

Small bright dots may appear on your screen display when you turn on your device. Your display contains an extremely large number of thin-film transistors (TFT) and is manufactured using high-precision technology. Any small bright dots that may appear on your display are an intrinsic characteristic of the TFT manufacturing technology. Over a period of time, and depending on the usage of the device, the brightness of the screen will deteriorate. This is also an intrinsic characteristic of the screen technology.

When the device is operated on battery power, the screen will dim and you may not be able to increase the brightness of the screen while on battery power.

Sound system problems

The sound settings can be configured to your desired user preferences. For more information, see “Sound settings” on page 71.

No sound is coming from the device’s speakers.

Adjust the volume control.

If you are using external headphones or speakers, check that they are securely connected to your device.

Wireless networking problems

NOTE This section provides general troubleshooting tips for networking problems, specifically wireless (Wi-Fi®) networking.

The terms and concepts used assume a basic understanding of networks, and may be for more advanced users. If you need assistance or if you are not familiar with the terminology, please contact Toshiba.

- ❖ Your device is equipped with an internal Wi-Fi® adapter. Verify that your Wireless connection is enabled. For more information, see “[Setting up Wi-Fi® and Bluetooth® connections](#)” on page 44.
- ❖ Verify that your device can detect access points or routers. If it can detect a Wi-Fi® access point or router then it may be a configuration issue.
- ❖ Verify that the signal strength is good.
- ❖ If another device is on the same network, verify that it has network access, and can connect to the Internet. If, for example, the other device cannot browse to a public Web site, the ISP’s (Internet Service Provider) service may be disrupted.
- ❖ Verify that the Service Set Identifier (SSID), or network name, is correct - i.e., that it matches the SSID assigned to the access point you are attempting to connect through. SSIDs are case-sensitive.
- ❖ If you have enabled any security provisions (closed system, MAC address filtering, Wired Equivalent Privacy [WEP], etc.), check the access point vendor's Web site for recent firmware upgrades. Problems with WEP keys, in particular, are frequently addressed in new firmware releases.

If you need further assistance

If you have followed the recommendations in this chapter and are still having problems, you may need additional technical assistance. This section contains the steps to take to ask for help.

Before you contact Toshiba

Since some problems may be related to the operating system or the program you are using, it is important to investigate other sources of assistance first.

Try the following before you contact Toshiba:

- ❖ Review the troubleshooting information.
- ❖ If the problem occurs while you are running a program, consult the program's documentation for troubleshooting suggestions. Contact the software company's technical support group for their assistance.
- ❖ Consult the dealer from whom you purchased your device and/or program. Your dealer is your best source for current information.

For the detailed specifications for your device, visit tabletsupport.toshiba.com.

Contacting Toshiba

If you still need help and suspect that the problem is hardware-related, Toshiba offers a variety of resources to help you.

Toshiba's Technical Support Web site

For technical support, or to stay current on the most recent software and hardware options for your device, and for other product information, be sure to regularly check the Toshiba Web site at tabletsupport.toshiba.com.

Toshiba voice contact

Before calling Toshiba, make sure you have:

- ❖ The serial number for your device
- ❖ The device and any optional devices related to the problem
- ❖ Name and version of the app involved in the problem along with its installation media
- ❖ Information about what you were doing when the problem occurred
- ❖ Exact error messages and when they occurred

For technical support, call the Toshiba Customer Support Center:
Within the United States at (800) 457-7777
Outside the United States at (949) 859-4273

Other Toshiba Internet Web sites

toshiba.com	Worldwide Toshiba corporate site
us.toshiba.com	Marketing and product information in the USA
accessories.toshiba.com	Accessories information in the USA
www.toshiba.ca	Canada
www.toshiba-Europe.com	Europe
www.toshiba.co.jp/index.htm	Japan
support.toshiba.com	Mexico and all of Latin America
acclaim.toshiba.com	Toshiba USA Self-Service support web site
laptopforums.toshiba.com	Community discussion forums for Toshiba laptop users

Toshiba's worldwide offices

Australia

Toshiba (Australia) Pty. Limited
84-92 Talavera Road
North Ryde NSW 2113
Sydney
Australia

France

Toshiba Systèmes (France) S.A.
7, Rue Ampère; B. P. 131
92800 Puteaux Cédex
France

Italy

Centro Direzionale Colleoni
Palazzo Perseo
Via Paracelso 10
20041, Agrate Brianza
Milano, Italy

Canada

Toshiba Canada Ltd.
191 McNabb Street
Markham, Ontario
L3R - 8H2
Canada

Germany

Toshiba Europe GmbH
Leibnizstraße 2
D-93055 Regensburg
Germany

Japan

Toshiba Corporation, PCO-IO
1-1, Shibaura 1-Chome
Minato-Ku, Tokyo, 105-8001
Japan

Latin America and Caribbean

Toshiba America Information
Systems
9740 Irvine Blvd.
Irvine, California 92618
USA

800-457-7777 (within the US)

949-859-4273 (outside of the US -
this call may incur long-distance
charges)

Spain

Toshiba Information Systems
(España) S.A.
Parque Empresarial San Fernando
Edificio Europa, 1a Planta
Escalera A
28831 (Madrid) San Fernando de
Henares
Spain

United States

Toshiba America Information
Systems, Inc.
9740 Irvine Boulevard
Irvine, California 92618
United States

Mexico

Toshiba de México S.A. de C.V.
Sierra Candela No.111, 6to. Piso
Col. Lomas de Chapultepec.
CP 11000 Mexico, DF.

United Kingdom

Toshiba Information Systems
(U.K) Ltd.
Toshiba Court
Weybridge Business Park
Addlestone Road
Weybridge, Surrey KT15 2UL
United Kingdom

The Rest of Europe

Toshiba Europe (I.E.) GmbH
Hammfelddamm 8
D-4-1460 Neuss
Germany

For more information on additional Toshiba worldwide locations,
please visit: www.toshiba.co.jp/index.htm.

Appendix A

Power Cord/Cable Connectors

Your device ships with the correct power supply for the country of purchase. This appendix shows the shapes of the typical AC power cord/cable connectors for various parts of the world.

USA



UL approved

Canada

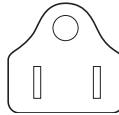

CSA approved

United Kingdom

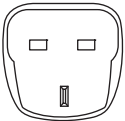

BS approved

Europe



VDA approved
NEMKO approved

Australia



AS approved

Glossary



TECHNICAL NOTE: Some features defined in this glossary may not be available on your device.

Acronyms

The following acronyms may appear in this User's Guide.

AC	Alternating Current
Apps	Applications
bps	bits per second
CPU	Central Processing Unit
DC	Direct Current
DPI	Dots Per Inch
EPROM	Erasable Programmable Read-Only Memory
FCC	Federal Communications Commission
GB	gigabyte
GPS	Global Positioning System
HDD	Hard Disk Drive
HDMI	High-Definition Multimedia Interface
HTML	Hypertext Markup Language

IEEE	Institute of Electrical and Electronics Engineers
I/O	Input/Output
IRQ	interrupt request
ISP	Internet Service Provider
KB	kilobyte
LCD	Liquid Crystal Display
LED	Light Emitting Diode
MB	megabyte
RAM	Random Access Memory
RFI	Radio Frequency Interference
ROM	Read-Only Memory
RTC	Real-Time Clock
SD	Secure Digital
TFT	Thin Film Transistor
USB	Universal Serial Bus
URL	Uniform Resource Locator
WAN	Wide Area Network
www	World Wide Web
WLAN	Wireless Local Area Network

Terms

The following terms may appear in this User's Guide.

- A** **active-matrix display**—A liquid crystal display (LCD) made from an array of liquid crystal cells using active-matrix technology. Also known as a “TFT display,” in its simplest form there is one thin film transistor (TFT) for each cell. This type of display works well with tablet devices because of its shallow depth and high-quality color. Active-matrix displays are viewable from wider angles than most passive-matrix displays.

adapter—A device that provides a compatible connection between two units. For example, the tablet’s internal display adapter receives information from the software and translates it into images on the screen. An adapter can take a number of forms, from a microprocessor to a simple connector. An intelligent adapter (one that is capable of doing some processing) may also be called a controller.

Alternating Current (AC)—The type of power usually supplied to residential and commercial wall outlets. AC reverses its direction at regular intervals. Compare *Direct Current (DC)*.

application—A set of instructions that can be executed by a tablet.

App shortcut—An application icon that can be placed on a Home screen. Touching one opens the app without having to first open the Apps screen. See also *icon*.

B

backup—A copy of a file, usually on a removable disk, kept in case the original file is lost or damaged.

baud rate—The speed at which a communication device, such as a printer or modem, transmits information. Baud rate is the number of signal changes per second (not necessarily the same as bits per second). See also *bits per second*.

bits per second (bps)—A way of measuring the speed at which information is passed between two devices. This is the basic unit of measure used in modem communications, and is similar, but not identical, to the baud rate. See also *baud rate*.

Bluetooth—A proprietary open wireless technology standard that uses short wavelength radio transmissions to exchange data over short distances. Bluetooth can transmit from fixed and mobile devices, and provides a high level of security.

Bookmark—A Shortcut can be created and placed on a Home screen from a selected browser bookmark. Touching the icon opens the Web browser to the chosen bookmarked page. See also *icon*.

boot—To start the tablet. The term “boot” originates from bootstrap program (as in “pulling itself up by its bootstraps”), a program that loads and initializes the operating system. See also *reboot*.

bus—An electrical circuit that connects the central processing unit (CPU) with other parts of the tablet, such as the video adapter, disk drives, and ports. It is the pathway through which data flows from one device to another. See also *bus speed*, *frontside bus*.

bus speed—The speed at which the central processing unit (CPU) communicates with the other parts of the tablet.

C

cache—A section of very fast memory in which frequently used information is duplicated for quick access. Accessing data from cache is faster than accessing it from the tablet's main memory. See also *CPU cache*, *L1 cache*, *L2 cache*.

Central Processing Unit (CPU)—The chip that functions as the “brain” of the tablet. It takes information from outside sources, such as memory or keyboard input, processes the information, and sends the results to another device that uses the information.

character—Any letter, number, or symbol you can use on the tablet. Some characters are non-printing characters, such as a paragraph break in a word-processing program. A character occupies one byte of tablet device storage.

chip—A small piece of silicon containing tablet device logic and circuits for processing, memory, input/output, and/or control functions. Chips are mounted on printed circuit boards.

compatibility—The extent to which tablets, programs, or devices can work together harmoniously, using the same commands, formats, or language as another.

configuration—(1) The collection of components that make up a single tablet operating system. (2) How parts of the system are set up (that is, configured).

controller—A device that controls the transfer of data from a tablet device to a peripheral device and vice versa. For example, disk drives, monitors, keyboards, and printers all require controllers.

CPU—See *Central Processing Unit (CPU)*.

CPU cache—A section of very fast memory residing between the CPU and the tablet's main memory that temporarily stores data and instructions the CPU will need to execute commands and programs. See also *cache*, *L1 cache*, *L2 cache*.

cursor—An on-screen symbol (usually a flashing vertical line) that indicates the position where characters will appear when you enter data.

D

default—The setting selected by a program when the user does not specify an alternative setting.

device—A component attached to the tablet. Devices may be external (outside the tablet’s case) or internal (inside the tablet’s case). Printers, disk drives, and modems are examples of devices.

device driver—A program (called a “driver”) that permits the tablet to communicate with a device.

Direct Current (DC)—The type of power usually supplied by batteries. DC flows in one direction. Compare *Alternating Current (AC)*.

disable—To turn the option off. See also *enable*.

disk drive—The device that reads and writes information and programs on external media or hard disk. It rotates the disk at high speed past one or more read/write heads.

document—Any file created with an application and, if saved to disk, given a name by which it can be retrieved. See also *file*.

download—(1) In communications, to receive a file from another source through a network. (2) To send font data from the tablet to a printer. See also *upload*.

drag—To touch and hold an item for a moment and then, without lifting your finger, move the item until you reach the target position.

driver—See *device driver*.

E

emulation—A technique in which a device or program imitates another device or program.

enable—To turn on an option. See also *disable*.

executable file—A program that is ready to run. Application programs and batch files are examples of executable files. Names of executable files usually end with a .bat, .exe, or .apk extension.

expansion device—A device that connects to a tablet to expand its capabilities. Other names for an expansion device are port expander, port replicator, docking station, or network adapter.

extension—See *file extension*.

external device—See *device*.

F **file**—A collection of related information, saved on disk with a unique name. A file may be a program, information used by a program, or a document. See also *document*.

file name—A set of characters that uniquely identifies a file within a particular folder. It consists of two parts: the actual name and the file name extension. See also *file extension*.

file extension—The three characters following the period (pronounced “dot”) at the end of a file name. The extension indicates the type of file. Examples are .apk for application files and .pdf for documentation files. See also *file name*.

folder—A container for organizing files saved to a disk. A folder is symbolized on screen by a graphical image (icon) of a file folder. A folder can contain files and other folders.

G **ground**—A conductor to which all components of an electric circuit are connected. It has a potential of zero (0) volts, is connected to the earth, and is the point of reference for voltages in the circuit.

H **hard disk**—A storage device composed of a rigid platter or platters that can be magnetically coded with data. Hard disks hold much more information than some other external media and are used for long-term storage of programs and data. The primary (or only) hard disk in a tablet device is usually fixed.

hardware—The physical components of a tablet system. Compare *software*.

HDMI (High-Definition Multimedia Interface)—An interface used to transmit high quality audio and video signal via a single cable in digital format, providing better picture quality than analog signal.

hot swapping—The ability to add or remove devices from the tablet while it is running and have the operating system automatically recognize the change.

- I** **icon**—A small image displayed on the screen that represents a function, file, or program.
- interlaced**—A method of refreshing the display screen, in which only every other line of pixels is refreshed. Interlaced screens take two passes to create a complete screen image. Compare *non-interlaced*.
- internal device**—See *device*.
- Internet**—The decentralized, world-wide network of computers that provides electronic mail, the World Wide Web, and other services. See also *World Wide Web*.
- L** **LED (Light Emitting Diode)**—A solid state lamp (SSL) that uses light-emitting diodes (LEDs) as the source of light, which offers long life and high efficiency output. Multiple diodes are used together, since the light created by individual light-emitting diodes is small compared to incandescent and compact fluorescent lamps.
- LCD (Liquid Crystal Display)**—A type of display that uses a liquid substance between two transparent electrode panels. When an electric current passes through the electrodes, the molecules in the liquid form a crystalline pattern that polarizes the light passing through it. A filter over the electrodes permits only non-polarized light to pass to the surface of the display, creating light and dark pixels.
- M** **memory**—Typically refers to the tablet's main memory, where programs are run and data is temporarily stored and processed. Memory can be volatile and hold data temporarily, such as RAM, or it can be nonvolatile and hold data permanently, such as ROM. A tablet's main memory is RAM. See also *RAM*, *ROM*.
- microprocessor**—See *Central Processing Unit (CPU)*.
- motherboard**—The computer's main circuit board that contains the processor, memory, and other primary components.
- mount**—To initialize the external storage device for transferring and storing files.
- multimedia**—A combination of two or more media, such as sound, animation, and video in an application or presentation.

- N** **network**—A collection of computers and associated devices that are connected by communications facilities. A network allows you to share data and peripheral devices, such as printers, with other users and to exchange electronic mail.
- non-interlaced**—A method of refreshing the tablet screen, in which each pixel of every line is refreshed as the electron beam scans across and down the screen. Compare *interlaced*.
- O** **online**—Available through a computer. Online may refer to information being read from your own computer's internal storage drive, such as online documentation or online Help, or to information coming from another company on a company network or the Internet.
- operating system**—A set of programs that controls how the tablet device works.
- P** **password**—A unique string of characters entered by a user to verify his or her identity to a computer or the network.
- peripheral**—Any device, such as a mouse or keyboard, that is attached to the tablet and controlled by the tablet's CPU.
- pixel**—Short for "picture element." The smallest dot that can be produced on a screen or printer.
- Plug and Play**—Generally, refers to the tablet's ability to automatically configure itself to work with peripheral devices. When capitalized, refers to a standard that, when followed by a device manufacturer, allows the tablet to configure itself automatically to work with the device.
- port**—A socket on the tablet where you plug in a cable for connection to a peripheral device.
- processor**—See *Central Processing Unit (CPU)*.
- properties**—The attributes of an object or device. For example, the properties of a file include the file's type, size, and creation date.
- R** **RAM (Random Access Memory)**—*Volatile* memory that can be written to as well as read. *Volatile* here means that information in RAM is lost when you turn off your tablet. This type of memory is used for your tablet's main memory. See also *memory*. Compare *ROM*.
- Random Access Memory**—See *RAM*.

Read-Only Memory—See *ROM*.

reboot—See *boot*, *restart*.

removable disk—A disk that can be removed from a disk drive. A Flash drive is one example of a removable disk.

resolution—A measure of the sharpness of the images that can be produced by a printer or displayed on a screen. For a printer, resolution is expressed in dots per inch (dpi). For a screen, it is expressed as the number of pixels available horizontally and vertically.

restart—Synonymous with reboot. To reset the tablet by reloading the operating system without turning the tablet off. See also *boot*.

ROM (Read-Only Memory)—Non-volatile memory that can be read but not written to. *Non-volatile* here means that information in ROM remains whether or not the tablet is receiving power. This type of memory is used to store your tablet's BIOS, which is essential instructions the tablet reads when you start it up. See also *BIOS*, *memory*. Compare *RAM*.

S

Secure Digital (SD)—A small, portable, non-volatile memory card used to store and transfer data between digital products, providing encryption capability for content security.

select—To highlight or otherwise specify text, data, or graphics with the intent to perform some operation on it.

shortcut—See *Application shortcut*.

Sleep—A feature of some operating systems that allows you to turn off the tablet without exiting your open applications and to continue from where you left off when you turn the tablet on again.

software—See *application*. Compare *hardware*.

Swipe—To move your finger quickly across the surface of the screen without pausing.

Sync—To synchronize files and data or accounts so that the same information is shared in multiple places.

T

TFT display—Thin Film Transistor display. See *active-matrix display*.

Touch—To activate items displayed on the screen, such as apps, setting icons, and onscreen buttons by touching them with your finger.

Transfer—To move files or data from one location to another.

U

Universal Serial Bus (USB)—USB is a serial bus that supports data transfer. USB allows hot swapping of peripherals. See also *bus*, *hot swapping*, *serial*.

unmount—To prepare the external storage media for removal from the device.

upload—To send a file to another computer through a modem or network. See also *download*.

USB—See *Universal Serial Bus (USB)*.

USB Flash drive—A small, portable flash memory card that plugs into the tablet's USB port and functions as a portable hard drive. They are smaller and more durable than an external hard drive because they do not contain any internal moving parts, but have less storage capacity. See also *Universal Serial Bus (USB)*.

utility—A computer program designed to perform a narrowly focused operation or solve a specific problem. Utilities are often related to computer system management.

W

Wallpaper—is a background image downloaded from the Web or chosen from the Gallery (pictures taken with the camera, or still images included with the system). A live wallpaper is an animated scene or maybe a map that centers on the current location.

Web—See *World Wide Web*.

Widget—A miniature app that can be placed on a Home screen. Touching the icon opens the application. Many of these include a clock, a music player, and the Google™ Search bar. See also *icon*.

Wi-Fi®—A registered trademark term of the Wi-Fi Alliance that stands for Wireless Fidelity, and is another term for the communication protocol to permit an Ethernet connection using wireless communication components.

World Wide Web (www)—The worldwide network of Web sites linked together over the Internet. A user of the Web can jump from site to site regardless of the location of the tablet hosting the site. See also *Internet*.

Index

A

- about tablet
 - battery use 83
 - legal information 83
 - settings 82
 - status 82
 - system updates 82
 - version information 83
- AC adaptor 29
- Accessibility
 - Accessibility settings 81
- accessibility
 - settings 81
- Accessibility scripts
 - Accessibility settings 81
- Accessibility settings
 - Accessibility 81
 - Accessibility scripts 81
 - KickBack 81
 - SoundBack 81
 - TalkBack 81
- accounts
 - manage 59
 - sync 59
- accounts & sync
 - account screen 77
 - auto-sync 76
 - background data 76
 - manage accounts 76
 - settings 76
- adding
 - optional external devices 93
- airplane mode
 - wireless & networks 70
- animation
 - screen settings 72
- applications
 - settings 75
- applications settings
 - battery use 76
 - manage applications 75
 - running services 75
 - storage use 75
- Apps 85
- apps
 - icon 64
 - Latitude 60
 - Maps 60

- menu 64
- Navigation 60
- open 64
- Places 60
- preinstalled 85
- uninstalling 86

apps menu

- apps 65

audible selection

- sound settings 71

automatic date & time

- date & time settings 82

automatic time zones

- date & time settings 82

auto-sync

- account screen 77
- accounts & sync 76
- manage accounts 76

B

back camera 91

back cover

- removable 25

back cover lock/unlock switch 27

background data

- accounts & sync 76

backing up data 22

backup data 45

- Google™ Account 45
- TOSHIBA File Manager 45

battery

- Call2Recycle™ 38
- care 36, 37
- changing 32
- charge indicator light 30
- charging 31
- disposal 38
- installation 32, 34
- maintaining 37
- monitoring power 30
- optimizing battery life 36
- removing 32

- safety precautions 36
- taking care of 36

battery use

- about tablet 83
- applications settings 76

Bluetooth®

- setting up 44
- wireless & networks 70

button

- power 39

buttons

- back cover lock/unlock switch 27
- buttons and features 47
- power button 26
- screen rotation lock/unlock switch 26
- volume control 26

C

Call2Recycle™

- battery 38

camera

- back camera 25
- front camera 24
- internal microphone 24

cameras

- using 91

caring for your device 63

changing

- battery 32

charging the battery 31

cleaning the device 63

clear storage

- location & security 75

configure input methods

- language & input settings 80

configure lock screen

- location & security 74

connecting

- AC adaptor 29
- AC adaptor cord to (DC-IN) 30

- HDMI™-compatible TV or display device 94
- power cord/cable 30
- power source 30
- current input method
 - language & input settings 80
- customize
 - device settings 64
- D**
- data
 - backing up 22, 45
 - restoring 46
- date & time
 - settings 81
- date & time settings
 - automatic date & time 82
 - automatic time zone 82
 - Select date format 82
 - select time zone 82
 - set date 82
 - set time 82
 - Use 24-hour format 82
- date and time
 - setting up 41
- DC-IN port 28
- device
 - caring for 63
 - cleaning 63
 - turning off 57
 - turning off options 57
- device administrators
 - settings 74
- device will not start
 - troubleshooting 105
- devices
 - external 93
- disposal information 12
- disposing of used batteries 38
- docking connector 27
- docking station
 - connecting to 95
- downloads
 - managing 61
- E**
- encrypt tablet
 - location & security 74
- external device
 - Mini-USB port 94
 - USB port 93
- external devices
 - keyboard 94
 - mouse 94
 - ports 93
- external display device
 - HDMI™ Out port 93
- external headphones
 - using 90
- external speakers
 - using 90
- F**
- factory data reset 62
- features 20
 - features and components 23
 - other documentation 20
 - this guide 19
- features and components
 - back view 25
 - bottom view 28
 - front view 24
 - left side view 27
 - right side view 26
 - top view 27
- files/folders
 - operation 102
- first time use 39
- front camera 91
- front/back camera
 - indicator light 24
- G**
- Gmail icon 49

- Google™ Apps
 - Android Market™
 - downloading 85
- GPS
 - location & security 73
- H**
- HDMI™ Out port 28
- headphone jack 28
- Home screen
 - adding items 55
 - moving items 56
 - removing items 56
- Home screens
 - apps 48
 - bookmarks 48
 - customizing 55
 - icons 48
 - thumbnails 48
 - widgets 48
- I**
- icon
 - apps 64
 - Gmail 49
 - safety 19
 - settings 64
- input method selector
 - language & input settings 80
- installing
 - a charged battery 34
 - battery 32
- K**
- keyboard, external 94
- KickBack
 - Accessibility settings 81
- L**
- language & input
 - settings 78
- language & input settings
 - configure input methods 80
 - current input method 80
 - input method selector 80
 - select language 79
 - text-to-speech settings 79
 - user dictionary 79
 - voice recognizer settings 79
- LEDs
 - system indicator lights
 - battery light 30, 31
 - Power light 29, 30, 39
- legal information
 - about tablet 83
- Licenses 12
- lights
 - battery light 24
 - front/back camera indicator light 24
 - ON/OFF light 24
 - power light 24
- location & security
 - clear storage 75
 - configure lock screen 74
 - encrypt tablet 74
 - GPS 73
 - location for Google 73
 - owner info 74
 - secure credentials 75
 - set password 75
 - settings 73, 74
 - visible passwords 74
 - wireless networks 73
- location for Google
 - location & security 73
- location preferences
 - setting up 41
- M**
- maintaining your battery 37
- manage
 - accounts 59
- manage applications
 - applications settings 75
- managing

- downloads 61
- microphone Line-In jack 28
- Mini-USB port 28
- mouse, external 94
- multimedia
 - settings 72

N

- Navigation and features 47
- navigation buttons 50
- notification sounds
 - sound settings 71
- notifications
 - managing 51
 - notification bar 51
 - viewing new 52

O

- online resources
 - Toshiba 22
- onscreen keyboard
 - speaking 90
 - typing 88
 - using 87
- operating system
 - troubleshooting 106
- optimizing battery life 36
- optional external devices
 - adding 93
- other documentation 20

P

- ports
 - DC-IN 28
 - docking connector 27
 - external devices 93
 - HDMI™ 93
 - HDMI™ Out port 28
 - headphone 28
 - microphone Line-In 28
 - Mini-USB 28
 - Mini-USB port 94
 - SD™ Card 26

- USB 28
- USB port 93
- power
 - connecting cable to AC adaptor 30
 - cord/cable 30
 - cord/cable connectors 113
 - turning on 39
- power button 26, 39
- Power light 29
- precautions
 - safety 21
- preinstalled apps 85
- privacy settings
 - automatic restore 77
 - back up my data 77
 - backup account 77
 - factory data reset 78
 - settings 77

Q

- Quick Settings menu
 - settings 68

R

- recording sounds 91
- recovery
 - factory data reset 62
- registering your Toshiba device 45
- removable back cover 25
- removing
 - battery from the device 32
- restoring your data 46
- running services
 - applications settings 75

S

- safety
 - disposing of batteries 38
 - icons 19
 - precautions 21
- safety precautions
 - battery 36

- screen
 - screen auto-rotate 72
 - settings 72
- screen auto-rotate
 - screen 72
- screen brightness
 - screen settings 72
- screen rotation lock/unlock switch 26
- screen settings
 - animation 72
 - screen brightness 72
 - screen time-out 72
- screen time-out
 - screen settings 72
- SD™ Card
 - using 91
- SD™ Card reader
 - inserting memory media 92
 - removing memory media 92
- SD™ Card slot 26
- secure credentials
 - location & security 75
- securing your tablet 53
- Select date format
 - date & time settings 82
- select language
 - language & input settings 79
- select time zone
 - date & time settings 82
- service options
 - standard limited warranty 21
- set date
 - date & time settings 82
- set password
 - location & security 75
- set time
 - date & time settings 82
- setting up
 - AC adaptor 29
- Settings
 - using Quick Settings 68
- settings
 - about tablet 82
 - accessibility 81
 - accounts & sync 76
 - applications 75
 - customize device settings 64
 - date & time 81
 - device administrators 74
 - icon 64
 - language & input 78
 - location & security 73
 - menu 64
 - multimedia 72
 - open 64
 - privacy settings 77
 - Quick Settings menu 68
 - screen 72
 - sound 71
 - storage 78
 - wireless & networks 69
- settings menu
 - settings 65
- setup
 - Bluetooth® 44
 - date and time 41
 - Google™ Account, sign in 42
 - language 40
 - location preferences 41
 - Wi-Fi® 44
 - Wi-Fi® connection 40
- Shut down mode
 - using 57
- Sleep mode 58
 - using 58
 - waking the tablet 43
- sound
 - settings 71
- sound settings
 - audible selection 71
 - notification sounds 71
 - volume 71
- SoundBack
 - Accessibility settings 81

- sounds
 - recording 91
- speakers 27
 - using 90
- status
 - about tablet 82
- storage
 - settings 78
- storage use
 - applications settings 75
- sync
 - accounts 59
- sync accounts
 - add an account 59
 - remove an account 60
- System bar
 - Apps button 50
 - Customize button 50
 - Google™ Search 50
 - navigation buttons 50
 - notification icons 50
 - status icons 50
 - time 50
- system indicator lights
 - AC power 29
 - LEDs 30, 31, 39
- system updates
 - about tablet 82
- T**
- taking care of battery 36
- TalkBack
 - Accessibility settings 81
- text-to-speech settings
 - language & input settings 79
- this guide
 - features 19
- Tips
 - file management tips 22
- Toshiba
 - online resources 22
 - worldwide offices 111
- Toshiba App Place™
 - downloading apps 84
- TOSHIBA Apps Place
 - TOSHIBA Media Player,
TOSHIBA Resolution+® 85
- Toshiba Apps Place
 - Media Player 84
- TOSHIBA File Manager Utility
 - file browsing 102
 - files/folders 102
 - rename files/folders 103
- TOSHIBA Resolution+® 85
- TOSHIBA Service Station
 - Application updates 99
 - download updates 99
 - install updates 100
 - tablet system updates 100
- touch screen navigation
 - onscreen 49
- troubleshooting 108
 - bookmarked site not found 106
 - contacting Toshiba 110
 - device will not start 105
 - display problems
 - screen is blank 108
 - operating system not working 106
 - power and batteries 107
 - screen does not look correct/
flickers 108
 - slow Internet connection 106
 - sound system 108
 - touch screen will not respond 105
 - URL address not found 106
 - wireless networking 109
- turning off
 - device 57
 - options 57
- turning on
 - power 39

U

- uninstalling apps 86
- USB port 28
- Use 24-hour format
 - date & time settings 82
- user dictionary
 - language & input settings 79
- using Quick Settings
 - Settings 68
- Utilities 97
 - TOSHIBA Adaptive display 104
 - TOSHIBA File Manager Utility 101
 - TOSHIBA Resolution+® 104
 - TOSHIBA Service Station 98

V

- version information
 - about tablet 83
- visible passwords
 - location & security 74
- voice recognizer settings
 - language & input settings 79
- volume
 - sound settings 71
- volume control buttons 26

W

- waking the tablet 43
- wallpaper
 - customize background 56
- warranty
 - standard limited warranty 21
- Wi-Fi®
 - setting up 44
 - wireless & networks 70
- Wi-Fi® connection
 - setting up 40
- wireless & networks
 - airplane mode 70
 - Bluetooth® 70
 - settings 69
 - Wi-Fi® 70

- wireless networking
 - troubleshooting 109
- wireless networks
 - location & security 73

Free Manuals Download Website

<http://myh66.com>

<http://usermanuals.us>

<http://www.somanuals.com>

<http://www.4manuals.cc>

<http://www.manual-lib.com>

<http://www.404manual.com>

<http://www.luxmanual.com>

<http://aubethermostatmanual.com>

Golf course search by state

<http://golfingnear.com>

Email search by domain

<http://emailbydomain.com>

Auto manuals search

<http://auto.somanuals.com>

TV manuals search

<http://tv.somanuals.com>