

Strata[®] ***DK***

Digital Business Telephone Solutions

Programming Manual

DK14

Software Release 3.1

DK40i

Software Release 4.1

DK424

**Software Release 4.1
and ACD**

Strata DK

General End User Information

The Strata DK Digital Business Telephone System is registered in accordance with the provisions of Part 68 of the Federal Communications Commission's Rules and Regulations.

FCC Requirements

Means of Connection: The Federal Communications Commission (FCC) has established rules which permit the Strata DK system to be connected directly to the telephone network. Connection points are provided by the telephone company—connections for this type of customer-provided equipment will not be provided on coin lines. Connections to party lines are subject to state tariffs.

Incidence of Harm: If the system is malfunctioning, it may also be disrupting the telephone network. The system should be disconnected until the problem can be determined and repaired. If this is not done, the telephone company may temporarily disconnect service. If possible, they will notify you in advance, but, if advance notice is not practical, you will be notified as soon as possible. You will be informed of your right to file a complaint with the FCC.

Service or Repair: For service or repair, contact your local Toshiba telecommunications distributor. To obtain the nearest Toshiba telecommunications distributor in your area, call Toshiba America Information Systems, Inc., Telecommunication Systems Division in Irvine, CA (949) 583-3700.

Telephone Network Compatibility: The telephone company may make changes in its facilities, equipment, operations, and procedures. If such changes affect the compatibility or use of the Strata DK system, the telephone company will notify you in advance to give you an opportunity to maintain uninterrupted service.

Notification of Telephone Company: Before connecting a Strata DK system to the telephone network, the telephone company may request the following:

1. Your telephone number.
2. FCC registration number:
 - ♦ Strata DK may be configured as a Key or Hybrid telephone system. The appropriate configuration for your system is dependent upon your operation of the system.
 - ♦ If the operation of your system is only manual selection of outgoing lines, it may be registered as a Key telephone system.
 - ♦ If your operation requires automatic selection of outgoing lines, such as dial access, Least Cost Routing, Pooled Line Buttons, etc., the system must be registered as a Hybrid telephone system. In addition to the above, certain features (tie Lines, Off-premises Stations, etc.) may also require Hybrid telephone system registration in some areas.
 - ♦ If you are unsure of your type of operation and/or the appropriate FCC registration number, contact your local Toshiba telecommunications distributor for assistance.
DK14 and DK40i
Key system: **CJ6MLA-74479-KF-E**
Hybrid: **CJ6MLA-74478-MF-E**
DK424
Hybrid: **CJ69XA-10243-MF-E**
Key system: **CJ69XA-10242-KF-E**
PBX: **CJCHN-22757-PF-E**
3. Ringer equivalence number: 0.3B. The ringer equivalence number (REN) is useful to determine the quantity of devices which you may connect to your telephone line and still have all of those devices ring when your number is called. In most areas, but not all, the sum of the RENs of all devices connected to one line should not exceed five (5.0B). To be certain of the number of devices you may connect to your line, as determined by the REN, you should contact your local telephone company to ascertain the maximum REN for your calling area.

Publication Information

Toshiba America Information Systems, Inc., Telecommunication Systems Division, reserves the right, without prior notice, to revise this information publication for any reason, including, but not limited to, utilization of new advances in the state of technical arts or to simply change the design of this document.

Further, Toshiba America Information Systems, Inc., Telecommunication Systems Division, also reserves the right, without prior notice, to make such changes in equipment design or components as engineering or manufacturing methods may warrant.

DKA-MA-PRGRM-VE
4025060

Version E, May 1999

Version D.3, December 1998 (Format change)

Version D.2, October 1998 (Update TBDK-0021)

Version D.1, September 1998 (Update TBDK-0019)

Version D, June 1998 (Update TBDK-0009)

Version C, October 1997

Version B, April 1997

Version A.1, February 1997 (Update TB16-0003)

Version A, December 1996

4. Network connection information USOC jack required: RJ1CX, RJ2EX, RJ2GX, RJ48C, RJ48X, RJ11, RJ14C, RJ21X (see Network Requirements in this document). Items 2, 3 and 4 are also indicated on the equipment label.

Radio Frequency Interference

Warning: This equipment generates, uses, and can radiate radio frequency energy and if not installed and used in accordance with the manufacturer's instruction manual, may cause interference to radio communications. It has been tested and found to comply with the limits for a Class A computing device pursuant to Subpart J of Part 15 of FCC Rules, which are designed to provide reasonable protection against such interference when operated in a commercial environment. Operation of this equipment in a residential area is likely to cause interference, in which case, the user, at his/her own expense, will be required to take whatever measures may be required to correct the interference.

This system is listed with Underwriters Laboratory.

UL Requirement: If wiring from any telephone exits the building or is subject to lightning or other electrical surges, then secondary protection is required. Secondary protection is also required on DID, OPS, and tie lines. (Additional information is provided in this manual.)



Important Notice — Music-On-Hold

In accordance with U.S. Copyright Law, a license may be required from the American Society of Composers, Authors and Publishers, or other similar organization, if radio or TV broadcasts are transmitted through the music-on-hold feature of this telecommunication system. Toshiba America Information Systems, Inc., hereby disclaims any liability arising out of the failure to obtain such a license.

CP01, Issue 8, Part I Section 14.1

Notice: The Industry Canada label identifies certified equipment. This certification means that the equipment meets certain telecommunications network protective, operational and safety requirements as prescribed in the appropriate Terminal Equipment Technical Requirements document(s). The Department does not guarantee the Equipment will operate to the user's satisfaction.

Before installing this equipment, users should ensure that it is permissible to be connected to the facilities of the local telecommunications company. The equipment must also be installed using an acceptable method of connection. The customer should be aware that compliance with the above conditions may not prevent degradation of service in some situations.

Repairs to certified equipment should be coordinated by a representative designated by the supplier. Any repairs or alterations made by the user to this equipment, or equipment malfunctions, may give the telecommunications company cause to request the user to disconnect the equipment.

Users should ensure for their own protection that the electrical ground connections of the power utility, telephone lines and internal metallic water pipe system, if present, are connected together. This precaution may be particularly important in rural areas.

CAUTION! Users should not attempt to make such connections themselves, but should contact the appropriate electric inspection authority, or electrician, as appropriate.

CP01, Issue 8, Part I Section 14.2

Notice: The Ringer Equivalence Number (REN) assigned to each terminal device provides an indication of the maximum number of terminals allowed to be connected to a telephone interface. The terminal on an interface may consist of any combination of devices subject only to the requirement that the sum of the Ringer Equivalence Numbers of all the Devices does not exceed 5.

© Copyright 1999

Toshiba America Information Systems, Inc. Telecommunication Systems Division

All rights reserved. No part of this manual, covered by the copyrights hereon, may be reproduced in any form or by any means—graphic, electronic, or mechanical, including recording, taping, photocopying, or information retrieval systems—without express written permission of the publisher of this material.

Strata is a registered trademark of Toshiba Corporation. Strategy is a registered trademark of Toshiba America Information Systems, Inc. Strata AirLink, Call Center Viewer are trademarks of Toshiba America Information Systems, Inc.

Trademarks, registered trademarks, and service marks are the property of their respective owners.

Contents

Introduction

Organization.....	vii
Conventions.....	viii
Related Documents/Media.....	ix

Chapter 1 – Overview

Numerical Program Listing.....	1-1
Alphabetical Program Listing.....	1-7
How to Program a Strata DK System.....	1-10
First-time Programming.....	1-14
Programming Examples.....	1-16

Chapter 2 – Initialization & Test

Program 91-9 – System Initialization.....	2-2
Program 90 – Initialize Programs 00~*99.....	2-4
Program 91-1 – Automatic PCB Recognition and Port Renumber.....	2-6
Program 91-2 – Data Transfer from Temporary Memory to Working Memory.....	2-8
Program 92 – Initializing Misc. Backup RAM.....	2-9
Program 00 – Part 1: Software Check.....	2-12
Program 00 – Part 2: Processor RAM Test.....	2-15

Chapter 3 – System & Station

Program 01 – Station Logical Port Display and/or Change.....	3-1
Program 02 – Station Physical Port Display and/or Change.....	3-2
Program 03 for DK14 – Slot Assignments.....	3-3
Program 03 for DK40i – Flexible PCB Slot Assignments.....	3-4
Program 03 for DK424 – Flexible PCB Cabinet Slot Assignments.....	3-6
Program *03 for DK424 – Cabinet Type Identification.....	3-11
Program 04 – Station Logical Port [PDN] Assignment.....	3-12
Program *04 – [PhDN] and Distributed Hunt [DN] Assignments For Internal and Tie Line Calls..	3-17
Program 05 – Flexible Access Code Numbering.....	3-19
Program *05 – Call Park Pickup Abbreviated Dialing.....	3-22
Program 09 – Built-in Auto Attendant Prompt / Station Assignments.....	3-23
Program *09 – [PDN], [PhDN], DH, ACD or Modem DID Ext. Assignments.....	3-25
Program 10-1 – System Assignments, Part 1 of 3.....	3-27
Program 10-2 – System Assignments, Part 2 of 3.....	3-30
Program 10-3 – System Assignments, Part 3 of 3.....	3-35
Program *10 – Enhanced 911 Operation.....	3-39
Program 12 – System Assignments, Basic Timing.....	3-41

Program 13 – Defining the Message Center	3-43
Program 15 – Ground/Loop/Tie/DID Line Options.....	3-44
Program *15 – CO Line Tenant Assignments	3-47
Program 16 – Assign CO Line Groups (or Dial 9)	3-48
Program 17 – DID/Tie Line Options	3-50
Program *17 – DID Intercept Port Number (Vacant or Wrong Number)	3-53
Program 19 – Alternate Background Music Source Slot Assignment	3-54
Program 20 – Computer and Data Interface Unit Configuration	3-55
Program 21 – Modem Pool Port Assignments.....	3-58
Program 22 – RPCI and DIU Station Hunting for Data Calls	3-60
Program 23 – Built-in Auto Attendant (AA) Primary Announcement Assignments	3-61
Program 24 – Built-in AA Secondary Announcement Assignments.....	3-61
Program 25-1 – Built-in AA Incoming Call Overflow Time.....	3-62
Program 26 – Built-in AA Camp-on Busy Time	3-63
Program 27 – DKT Handset/Headset Receiver Volume Level	3-65
Program 28 – DSS Console/Attendant Telephone Assignments	3-66
Program 29-1~8 – DSS Console and Number Button Assignments.....	3-68
Program *29 – Add-on Modules Button Assignments	3-71
Program 30 – Station Class of Service.....	3-73
Program *30 – Telephone Group Page Assignments	3-79
Program 31 – Station Class of Service.....	3-80
Program *31 – Group Pickup Assignments.....	3-86
Program 32 – Automatic Preference	3-87
Program *32 – RS-232 Voice Mail Message Center Port	3-89
Program 33 – [PDN]/ [PhDN] Station Hunting (Voice Calls Only).....	3-90
Program *33 – [PhDN] Owner Telephone Assignment	3-92
Program 34 – Hold Recall Timing	3-94
Program *34 – Station Class Of Service.....	3-95
Program 35 – Station Class of Service.....	3-97
Program 36 – Fixed Call Forward.....	3-101
Program *36 – System NT Button Lock Password Changing Station Assignment	3-102
Program 37 – Ring Transfer (Camp-on) Recall Time	3-103
Program *37 – Park Recall Timing.....	3-104
Program 38 – Digital and Electronic Telephone Keystrip Type.....	3-105
Program *38 – Standard Telephone Ring-Down Destination.....	3-109
Program 39 – Flexible Button Assignments	3-111
Program *40 – Distributed Hunt Group Member Assignments.....	3-120
Program *41 for DK424 – T1 Assignment Series (Part 1)	3-122
Program *50 – Caller ID Circuit Assignments to CO Line PCBs	3-126
Program *51 – Station Memory Allocation	3-128
Program *52 – Caller ID/ANI Abandoned Call Number Station Owner Assignments.....	3-130
Program 58 – DK424 Attendant Console Series (Part 1)	3-132
Program 59 – Attendant Console Flexible Button Codes	3-135
Program 60-1 – SMDR Data Output Options	3-139
Program 60-2~7 – SMDR Output/Account Code Digit Length	3-140
Program 60-8 – Call Forward External (Remote Change, Security) ID Code.....	3-142
Program 69 – Verified Account Codes	3-143
Program 70 – Verified Account Code Toll Restriction Assignments.....	3-145
Program 71 – DNIS.....	3-147
Program *71~*73 – [DN] to [DN], Tie to [DN], and DID to [DN] Ringing Assignments	3-152

Program 72 – DNIS Number Network Table Assignments.....3-154
 Program 74 – System NT Button Lock Password3-156
 Program 76-1(X-Y) – DK14, DK40i, All RCTUs.....3-157
 Program 76-2 (X-Z) – WSIU, TSIU and RSIU / RSIS / RMDS Transmission Rates.....3-158
 Program 77-1 – Peripheral Options (Door Phones)3-159
 Program 77-2 – Door Phone Busy Signal/Door Lock Assignments.....3-163
 Program 77-3 – Night Ringing Over PIOUS External Page Zones3-165
 Program 77-4 – RSIU Open Architecture Interface (OAI) Data Output Assignments.....3-166
 Program 78 – CO Line Special Ringing Assignments.....3-168
 Program 79 – Door Phone Ringing.....3-170
 Program *79 – Door Phone to [DN] Flashing Assignments.....3-172
 Program 80 – EKT and DKT Ringing Tones (CO Line Calls).....3-173
 Program *80 – Call Forward Station Ring Assignment.....3-174
 Programs 81~89 – Ground/Loop Start/CO Line Station Ringing.....3-175
 Programs *81, *84, and *87 – Ground/Loop Start/CO Line to [DN] LED Flash Assignments.....3-179
 Program 93 – CO Line Identification.....3-183
 Program 97 – Printing Program Data through SMDR.....3-185

Chapter 4 – Toll Restriction

Toll Restriction Methods.....4-1
 Toll Restriction Features4-1
 Completing the Toll Restriction System Record4-3
 Program 40 – Station CO Line Access4-4
 Program 41 – Station Outgoing Call Restriction4-6
 Program 42-0 – CO Line to PBX/Centrex Connection & Access Codes4-8
 Program 42-1~8 – PBX/Centrex Access Codes.....4-10
 Program 43 – 0 + Credit Card Dialing Option.....4-11
 Program 44-1~8 – Toll Restriction/Traveling Class Override Codes.....4-13
 Program 44-91~93 – Emergency Bypass of Forced/Verified Account Codes4-14
 Program 45-1 – LCR/Toll Restriction Dial Plan.....4-15
 Program 45-2 – Toll Restriction Disable4-19
 Program 45-3~6 – Special Common Carrier Numbers and Authorization Code Digit Length.....4-20
 Program 45-8~9 – Toll Restriction Override Code.....4-22
 Program *45-1 (1~4) – Toll Restriction for Office Codes.....4-23
 Program *45-2 (1~6) – LCR/Toll Restriction Bypass4-24
 Program *45-3 (1~9) – LCR/Toll Restriction Bypass For Special Numbers that Begin with */#4-26
 Program *45-4 – Special Code Dialing Sequence with LCR4-28
 Program 46-2~4 – Toll Restriction Allowed/Denied Area Codes by Class4-30
 Program 46-6~8 – Toll Restriction Allowed/Denied Local Office Codes Assigned by Class4-31
 Programs 46-10~80 – Toll Restriction Class Parameters4-33
 Programs 46-11~46-81 – Toll Restriction Class (1~8) Parameters4-35
 Program 47 – Toll Restriction Exception Office Codes Assigned by Area Codes (Tables 1~16)4-36
 Program 48 – Station Toll Restriction Classification4-38

Chapter 5 – Least Cost Routing

LCR Features5-1
 LCR Conditions5-2
 LCR CO Line Programming Reference Table.....5-3
 Program 50-1 – LCR Parameters5-4

Program 50-2 – LCR Home Area Code 5-5
 Programs 50-3 (1~5) – LCR Special Codes..... 5-6
 Program 50-4 – LCR Long Distance Information (LDI) Plan Number 5-7
 Program 50-5 – LCR Local Call Plan Number 5-8
 Program 50-6 – LCR Dial 0 (Zero) Time-out 5-9
 Program 51 – LCR Area Codes 5-10
 Program 52 – LCR Office Code Exceptions for Specified Area Code 5-12
 Program 53 – LCR Schedule Assignments for LCR Plans 5-14
 Program 54 – LCR Route Definition Tables 5-17
 Program 55 – LCR Modified Digits Table 5-19
 Program 55-0 – Delete Number of Digits From the Front of Dialed Number 5-20
 Program 55-1 and 2 – Add Digits Before and/or After the Dialed Number 5-21
 Program 56 – LCR Station Group Assignments 5-23

Chapter 6 – Automatic Call Distribution

Program 03 – RSIU, RSSU, PIOUS, PIOUS ACD/MIS Slot Assignments 6-2
 Program 09 – Auto Attendant Prompt/ACD Group Assignments 6-3
 Program *09 – ACD Group DID Line Digit Assignments 6-5
 Program 10-4 – ACD/ISDN Parameters 6-6
 Program 11 – ACD Timing Assignments 6-8
 Program 14-0 – Loop/Ground Start Line Direct to ACD Group Assignments 6-12
 Program 14-1 – ACD Agent Identification Code Assignments 6-13
 Program *14-1 – Auto Answer with Zip Tone Assigned to Agent ID 6-14
 Program 18 – Agent Names for SMIS/MIS Assignments 6-15
 Program 14-2 – ACD Supervisor Passwords 6-17
 Program *14-2 – DID, Tie, DNIS, ANI Line After Shift/Overflow Substitution Destinations 6-18
 Program 14-3 – Announcement/Music Port and Queue Pattern 6-20
 Program 14-4 – Queue Time Out Overflow Destination 6-23
 Program 14-5 – Overflow Point and Ring No Answer Routing Destination 6-25
 Program 14-6 – After Shift Service Destination 6-29
 Program 14-71 – Queue Size for Alarm, Immediate Assignments 6-31
 Program 14-72 – Queue Size for Alarm 1 6-32
 Program 14-73 – Queue Size for Alarm 2 6-33
 Program 14-8 – Alarm Pattern Assignments 6-34
 Program 14-9 – Work Unit Assignments 6-35
 Program 15 – Ground/Loop/Tie/DID Line Options 6-36
 Program 17 – DID/Tie Line Options 6-36
 Program 35 – Station Class of Service 6-36
 Program 71 – DID/Tie/DNIS/ANI Lines 6-36
 Program 39 – Flexible Button Assignments for ACD Telephones 6-37

Chapter 7 – ISDN

System Programs Overview 7-1
 ISDN Related Programs 7-3
 Trunk Programs Overview 7-5
 Program 16 – Assign CO Line Groups 7-6
 Program *16 – ISDN Trunk Group Type Assignment 7-7
 Program *42 – Clock Source 7-8
 Program *42-1 – Primary Timing Reference Assignments (Release 3.1 and earlier) 7-9

Program *43-1~3 – D-Channel Control and NFAS Assignments 7-10
 Program *43-2 – Non-Facility Associated Signaling (NFAS) Assignment 7-11
 Program *43-3 – Network PRI Interface Assignment 7-12
 Program *44 – BRI Service Profile Identifier (SPID) Parameters 7-13
 Program *60 – BRI Line/Station Operation Assignment 7-14
 Program *61 – Analog Trunk Services for ISDN 7-15
 Program *62 – Non-ISDN Station Bearer Service 7-16
 Program *63 – ISDN Dialing Parameters 7-17
 Program *64-1 – Direct Inward Dialing Parameters 7-18
 Program *64-2 – Number of DID/DNIS Digits for Trunk Groups 7-19
 Program *65 – ISDN Channel Group Assignment 7-20
 Program *66-1 – Channel Group Number Parameters 7-21
 Programs *66-2 and *66-4 – Call-by-Call Trunk Group Codes and Network ID 7-22
 Program *66-3 – Channel Group/Trunk Parameters 7-24
 Program *66-5 – Line Directory Number (LDN) Registration 7-25
 Program *66-6 – LDN/Trunk Group to Channel Group Assignments 7-26
 Program *66-7 – LDN/Trunk Group Assignments 7-27
 Program *67-1 – Trunk Group Call Direction 7-28
 Program *67-2 – Call Types for ISDN Trunk Group Supported 7-29
 Program *67-3 – ISDN Trunk Group Minimum Channel Reservation 7-30
 Program *67-4 – ISDN Trunk Groups Maximum Channel Reservation 7-31
 Program *67-5 – Multiple Time Zone Settings 7-32
 Program *68-1 – Calling Number ID Presentation Parameters 7-33
 Program *68-2 – Outbound CNIS Parameters 7-34
 Program *69-1 – CNIS Presentation Parameters 7-35
 Program *69-2 – Special Number Assignment 7-36

Chapter 8 – E911

Operation Overview 8-1
 SMDR 8-2
 Programming Overview 8-3
 Program *11-0 – E911/CAMA Trunk Assignments 8-4
 Program *11-1 – CAMA Trunk Group Line Assignments 8-6
 Program *11-2 – CAMA Trunk Group Hunting Assignments 8-7
 Program *11-5 – CAMA Digits Sent on 911 Calls 8-8
 Program *11-6 – E911 Interdigital Timer 8-9
 Program *11-8 – 911 Special [DN] Notification Assignments 8-10
 Program *12 – CESID Station Information 8-11
 Program *13 – Station To CAMA Trunk Group Assignment 8-13

Glossary GL-1

Index IN-1

Introduction

This manual provides for programming the Strata DK14, DK40i, and DK424 digital business telephone systems. It is intended for qualified service technicians and system programmers. At the time of this printing, this book contains Release 4.1 information for the DK424. It also contains some pre-release information for software beyond Release 4.1.

Important! *Information beyond Release 4.1 is preliminary and given prior to product release. Be careful when using this information as the software will change and updates/additions will be required upon final release.*

This manual uses simplified, generic system record sheets that have legends that show you specific port configurations for Strata DK14, DK40i and DK424 systems.

After using the legends, copy the generic record sheets as required to accommodate your system ports and settings.

The *Installation and Maintenance (I&M) Manual*, a companion book, covers the installation and maintenance information and instructions for the Strata DK systems discussed in this book.

Organization

This manual is organized as follows for your convenience:

- ♦ **Chapter 1 – Overview** includes general programming information and basic instructions on how to program the system with a 20-button LCD digital or electronic telephone.
- ♦ **Chapter 2 – Initialization & Test** includes information for initializing and test programs.
- ♦ **Chapter 3 – System & Station** includes programming information for the entire system and individual stations.
- ♦ **Chapter 4 – Toll Restriction** includes programming information for Toll Restriction.
- ♦ **Chapter 5 – Least Cost Routing** includes programming information for Least Cost Routing.
- ♦ **Chapter 6 – Automatic Call Distribution** includes ACD programming for DK424 (ACD does not apply to the RCTUA processor).
- ♦ **Chapter 7 – ISDN** includes programming instructions and record sheets for Integrated Systems Digital Networking features for the DK424 and DK40i.
- ♦ **Chapter 8 – E911** includes programming information for connecting the DK424 to Enhanced 911 CAMA trunks.
- ♦ **Glossary/Index**

The programs in each chapter are given in numerical order (except Initialization and Test which is given in order of importance). The “*” programs are located behind the program of the same name (e.g., Program *09 follows Program 09).

Conventions

Conventions	Description
Note	Elaborates specific items or references other information. Within some tables, general notes apply to the entire table and numbered notes apply to specific items.
Important!	<i>Calls attention to important instructions or information.</i>
CAUTION!	Advises you that hardware, software applications, or data could be damaged if the instructions are not followed closely.
WARNING!	Alerts you when the given task could cause personal injury or death.
[DN]	Represents any Directory Number button, also known as an extension or intercom number.
[PDN]	Represents any Primary Directory Number button (the extension number for the telephone).
[SDN]	Represents any Secondary appearance of a PDN. A PDN which appears on another telephone is considered an SDN.
[PhDN]	Represents any Phantom Directory Number button (an additional DN).
Arial Bold	Represents telephone buttons.
Courier	Shows a computer keyboard entry or screen display.
“Type”	Indicates entry of a string of text.
“Press”	Indicates entry of a single key. For example: Type prog then press Enter .
Plus (+)	Shows a multiple PC keyboard or phone button entry. Entries without spaces between them show a simultaneous entry. Example: Esc + Enter . Entries with spaces between them show a sequential entry. Example: # + 5.
Tilde (~)	Means “through.” Example: 350 ~ 640 Hz frequency range.
➤	Denotes the step in a one-step procedure.
➤	Denotes a procedure.
	Used in a programming sequence to denote a variable LED button. A number on the black button represents a specific LED button.
• • •	Indicates continuation of a series of numbers entered.
See Figure 10	Grey words within the printed text denote cross-references. In the electronic version of this document (Library CD-ROM or FYI Internet download), cross-references appear in blue hypertext.

Related Documents/Media

Note Some documents listed here may appear in different versions on the CD-ROM, FYI or in print. To find the most current version, check the version/date in the Publication Information on the back of the document's title page.

The following documents and CD-ROMS can be used to reference further information about the Strata DK systems.

- ♦ **Digital Telephone User Guide** provides all the procedures necessary to operate Toshiba-proprietary digital telephones, including Liquid Crystal Display (LCD) features. It also includes instructions for using the add-on module/DSS console.
- ♦ **Digital Telephone Quick Reference Guide** provides a quick reference for frequently-used digital telephone features.
- ♦ **Digital Single Line Telephone User Guide** provides all the procedures necessary to operate Toshiba-proprietary digital single line telephones.
- ♦ **Electronic Telephone User Guide** explains all the procedures necessary to operate Toshiba-proprietary electronic telephones, including all LCD features. Does not apply to the Strata DK14 system. It also includes instructions for using the electronic DSS console.
- ♦ **Electronic Telephone Quick Reference Guide** provides a quick reference for frequently-used electronic telephone features. Does not apply to the Strata DK14 system.
- ♦ **Standard Telephone User Guide** explains all the procedures necessary to operate rotary dial and push-button standard telephones.
- ♦ **Strata AirLink External Wireless Handset User Guide** shows how to use the wireless handset configured to standard ports of the Strata DK telephone system and many non-Toshiba systems.
- ♦ **Strata AirLink External Wireless Quick Reference Guide** contains instructions for operation of commonly used Strata AirLink External Wireless Handset features.
- ♦ **Strata AirLink Integrated Wireless Handset User Guide** shows how to use the wireless handset configured to digital ports of the Strata DK telephone system.
- ♦ **Strata AirLink Integrated Wireless Quick Reference Guide** contains instructions for operation of commonly used Strata AirLink Integrated Wireless Handset features.
- ♦ **System Administrator Guide** gives instructions for the System Administrator to manage the system. Contains instructions for Station Relocation, System Speed Dial, and other features only activated by the System Administrator.
- ♦ **PC/Data Interface User Guide** explains all the procedures necessary to operate stand-alone data interface units while in the data mode for printer sharing and modem pooling. Also provides instructions on connecting to a Personal Computer with Telephone Application Programming Interface (TAPI).
- ♦ **Cordless Telephone User Guide** provides instructions on using the DKT2004-CT cordless digital telephone as a single unit or in conjunction with a digital telephone.
- ♦ **PC-DKT User Guide** provides installation and operation information for the Personal Computer Digital Key Telephone system.
- ♦ **Strata DK Feature Description Manual** describes each feature associated with the Strata DK424, DK40i and DK14. Also provides descriptions of compatible Toshiba-proprietary telephones and peripherals.

- ♦ **Keyprint 2000 User Guide** provides instructions for the Keyprint 2000 software printing package which allows you to print and store custom button label keystrips for Strata DK 2000-series 10-button or 20-button digital telephones, 20-button add-on modules, and 60-button digital DSS consoles.
- ♦ **Strata DK Programming Manual** provides all instructions necessary to program the system and system record sheets, including ACD.
- ♦ **Strata DK Installation & Maintenance Manual** provides installation instructions for configuring and installing the Strata DK14, DK40i and DK424. It also includes T1/DS-1 interface installation and configuration instructions, as well as fault finding flowcharts to troubleshoot the systems. An ACD Section provides instructions for installing ACD into the Strata DK424.
- ♦ **Strata AirLink External Wireless System Installation Guide** provides step-by-step hardware and software installation instructions. It includes examples of system configurations, information on performing a site survey, and troubleshooting techniques.
- ♦ **Hospitality Management Information System (HMIS) General Description** provides an overall view of the system's hardware, software, applications and features. The HMIS is a PC-based solution, designed to meet the specific operational needs of small- to medium-sized hotel/motels and includes both the PC and software.
- ♦ **Hospitality Management Information System (HMIS) User Guide** describes the product's many software features and gives step-by-step instructions for using them.
- ♦ **Strata DK Library CD-ROM** enables you to view, print, navigate and search publications for Strata DK14, DK40 and DK424 digital business telephone systems. It also includes Strata DK424 ACD Documentation, including the *Strata DK424 Call Center Solutions General Description*, *ACD Agent Guide*, *ACD Supervisor's Guide*. ACD Installation and Programming instructions are included in the *Strata DK Installation and Maintenance Manual* and *Programming Manual*.
- ♦ **Strata DK HMIS CD-ROM** contains a copy of all HMIS documentation/bulletins and enables you to view, print, navigate and search publications.
- ♦ **StrataControl CD-ROM** contains the StrataControl software, that enables viewing, downloading, editing, and uploading Strata DK programmed data on a PC. This software also provides a method of creating custom lists and user guides based on information from the Strata DK system. The CD-ROM contains the *StrataControl User Guide*.
- ♦ **DKQuote CD-ROM** contains the DKQuote application and the *DKQuote User Guide*, that shows how to use this interactive software to assist you with Strata DK Systems configuration and pricing worksheets.
- ♦ **DKAdmin/DKBackup CD-ROM** includes the programs that let you easily and quickly custom program and/or update the Strata DK14/DK40/DK424 with a user-friendly PC display. The CD-ROM also contains the *DKAdmin/DKBackup User Guide*, that explains how to use the DKAdmin/DKBackup interactive software applications. The current version does not support DK40i.

The following documentation and media applies to the Strata DK424 system only.

- ♦ **Strata DK424 Call Center Solutions General Description** provides a system overview, including hardware and feature information. Highlights the technology employed in operating the ACD Strata DK424 system.
- ♦ **ACD Agent Guide** describes the ACD agent feature operation along with step-by-step procedures for using features.
- ♦ **ACD Supervisor Guide** provides instruction on how to use the ACD supervisor features.

- ♦ **Insight DK CD-ROM** which includes Insight DK software, the upgrade to Insight DK Plus, Demo software, Insight DK documentation and training modules.
- ♦ **Insight DK Installation Guide** explains how to set up the network, install the server software, install clients and explains how the data files are organized.
- ♦ **Insight DK Supervisor Guide** provides instructions for using the Strata DK Insight and Insight DK Plus MIS for the Supervisor of a call center. Instructions for creating and using Real Time Displays, Reports, Alarms, and Wallboards are also included.
- ♦ **Insight DK inView Quick Reference Guide** provides instructions for viewing and customizing the on-screen wallboard and large character views of the real time call center data.
- ♦ **PC Attendant Console User Guide** explains the procedures necessary to operate the PC Attendant Console.
- ♦ **PC Attendant Console Quick Reference Guide** provides a quick reference for frequently-used PC Attendant Console features.
- ♦ **Call Center Viewer User Guide** describes how to install and operate the Call Center Viewer application on a PC. It explains how to view and customize ACD group and agent status information.
- ♦ **Software MIS (SMIS) Supervisor Manual** provides descriptions, examples, and instructions on using the Software MIS application.

For authorized users, Internet site FYI (<http://fyi.tsd.toshiba.com>) contains all current Strata DK documentation and enables you to view, print, and download current publications.

Numerical Program Listing

The following numerical listing gives you the Strata DK program numbers, titles and program types.

Program Number	Program Title	Initialization & Test	System	Station	Toll Restriction	Least Cost Routing	ACD	ISDN
00	Part 1: Software Check/Remote Maintenance Security Code Assignments	X						
00	Part 2: RCTU: Random Access Memory (RAM) Test	X						
01	Station Logical Port Display and/or Change			X				
02	Station Physical Port Display and/or Change			X				
03	Flexible PCB Cabinet and Slot Assignments		X				X	
*03	Cabinet Type Identification		X					
04	Station Logical Port Primary Directory Number Assignment			X				
*04	[PhDN] and Distributed Hunt [DN] for Internal Tie Line Calls			X				
05	Flexible Access Code Numbering		X					
*05	Call Park Pickup Abbreviated Dialing		X					
09	Built-in Auto Attendant Prompt/Station Assignments		X				X	
*09	[PDN], [PhDN], DH, ACD or Modem DID External Assignments		X				X	
10-1~3	System Assignments, Basic Timing		X					X
10-4	ACD Parameters and ISDN PRI and BRI T-wait Timers						X	X
*10-11	E911 Standard Telephone Ports Assignment		X					
*10-12	E911 Standard Telephone Ports Assignment		X					
*10-91	E911 Interdigital Timer		X					
*10-92	E911 Pause Before Send Timer		X					
11	ACD Timing Assignments						X	
*11-1~9	CAMA Trunk Assignments		X					
12	System Assignments		X					
*12	ANI Station Information			X				
13	Defining the Message Center			X				
*13	Station Group Information			X				
14-0	Loop/Ground Start CO Line Direct Ring to ACD Group Assignments						X	
14-1	ACD Agent Identification Code Assignments						X	

Program Number	Program Title	Initialization & Test	System	Station	Toll Restriction	Least Cost Routing	ACD	ISDN
*14-1	Auto Answer with Zip Tone Assigned to Agent ID						X	
14-2	ACD Supervisor Passwords						X	
*14-2	DID/Tie/DNIS/ANI Line After Shift and Overflow Substitution Destination						X	
14-3	Announcement / Music Port Assignments and Queue Pattern						X	
14-4	Queue Time Out Overflow Destination						X	
14-5	Overflow Point and Ring No Answer Routing Destination Assignments						X	
14-6	After Shift Service Destination						X	
14-71	Queue Size for Alarm (Immediate Assignments)						X	
14-72	Queue Size for Alarm 1						X	
14-73	Queue Size for Alarm 2						X	
14-8	Alarm Pattern Assignments						X	
14-9	Work Unit Assignments / Stroke Digit Length						X	
15	Ground/Loop/Tie/DID Line Options		X				X	
*15	CO Line Tenant Assignments		X					
16	Assign CO Line Groups (Dial 9, 81~84, 81~88 or 801~816)		X					X
*16	ISDN Trunk Group Type Assignment							X
17	DID/Tie Line Options		X				X	
*17	DID Intercept Port Number		X					
18	Agent ID Code Name for MIS Assignments						X	
19	Alternate Background Music (BGM) Source Slot Assignment		X					
20	Computer Interface Unit and Data Interface Unit Configuration			X				
21	Modem Pool Port Assignments			X				
22	Computer and Data Interface Units (DIU) Station Hunting (Data Calls)			X				
23	Built-in Primary Auto Attendant Announcement Device Assignments		X					
24	Built-in Secondary Auto Attendant Announcement Device Assignments		X					
25-1	Incoming Built-in Auto Attendant Call Overflow Time		X					
26	Built-in Auto Attendant Camp-on-Busy Time			X				
27	Digital Telephone Handset/Headset Receiver Volume Level			X				
28	DSS Console/Attendant Telephone Assignments			X				
29-1~8	DSS Console Button Assignments Console Number			X				
*29	Add-on Module Button Assignments			X				
30	Station Class of Service			X				
*30	Telephone Group Page Assignments			X				
31	Station Class of Service			X				
*31	Group Pickup Assignments			X				
32	Automatic Preference			X				
*32	RS-232 (SMDI or Toshiba Proprietary) Voice Mail Message Center Port			X				
33	Station Intercom and Directory Number Hunting (Voice Calls Only)			X				
*33	Phantom Directory Number [PHDN] Owner Telephone Assignments			X				



Program Number	Program Title	Initialization & Test	System	Station	Toll Restriction	Least Cost Routing	ACD	ISDN
34	Hold Recall Timing			X				
*34	Station Class of Service (Standard Telephone Camp-on Busy and Busy Override Tone Option)			X				
35	Station Class of Service			X			X	
36	Fixed Call Forward (Voice Calls Only)			X				
*36	System NT Button Lock Password Changing Station Assignment			X				
37	CO and Tie Line Ring Transfer (Camp-on) Recall Time			X				
*37	Park Recall Timing			X				
38	Digital and Electronic Telephone Keystrip Type			X				
39	Flexible Button Assignment			X			X	
40	Station CO Line Access				X			
*40	Distributed Hunt Group Member Assignments			X				
41	Station Outgoing Call Restriction				X			
*41-1	T1 Span Frame and Coding Assignments			X				X
*41-2	T1 Channel Assignments			X				X
*41-3	T1 Span Transmit (Send) Level Pad Assignments			X				
*41-4	T1 Span Receive Level Pad Assignments			X				
42-0	CO Line to PBX/Centrex Connection				X			
42-1~8	PBX/Centrex Access Code				X			
*42-1	T1 Span Primary Reference Assignments			X				
*42-2	T1 Span and Secondary Timing (Backup) Reference Assignments			X				
43	0 + Credit Card Dialing Option				X			
*43-1~3	D-Channel Control and NFAS Assignments							X
44-1~8	Toll Restriction Class (1-8)/Traveling Class Override Codes				X			
44-91~93	Emergency Bypass of Forced/Verified Account Codes				X			
*44	BRI Service Profile Identifier (SPID) Parameters							X
45-1	LCR/Toll Restriction Dial Plan				X		X	
45-2	Toll Restriction Disable				X			
45-3-6	Special Common Carrier (SPCC) Numbers and Authorization Code Digit Length				X			
45-8-9	Toll Restriction Override Code				X			
*45-1	Toll Restriction for Office Codes in Local and All Other Area Codes				X			
*45-2	LCR/Toll Restriction Bypass for Special Numbers That Do Not Begin with * or # Digits				X		X	
*45-3	LCR/Toll Restriction Bypass - Special Numbers Beginning with * or #				X		X	
*45-4	LCR/Toll Restriction Bypass				X		X	
46-2~4	Toll Restriction Allowed/Denied Area Codes Assigned by Class				X			
46-6~8	Toll Restriction Allowed/Denied Office Codes Assigned by Class for Local Calls				X			
46-10~80	Toll Restriction Class Parameters				X			

Program Number	Program Title	Initialization & Test	System	Station	Toll Restriction	Least Cost Routing	ACD	ISDN
46-11~81	Toll Restriction Class Parameters				X			
46-21,46-31								
46-41,								
46-51,	Toll Restriction Classes 2~8				X			
46-61,								
46-71,								
46-81								
47	Toll Restriction Exception Office Codes Assigned by Area Codes			X				
48	Station Toll Restriction Classification				X			
50-1	Least Cost Routing Parameters					X		
50-2	Least Cost Routing Home Area Code					X		
50-31~35	Least Cost Routing Special Code					X		
50-4	Least Cost Routing Long Distance Information (LDI) Plan Number					X		
50-5	Least Cost Routing Local Call Plan Number					X		
50-6	Least Cost Routing Dial Zero Time-out					X		
*50	Caller ID (RCIU/RCS) Circuit Assignments to CO Line (RCOU, RCOS, RGLU, and PCOU)		X					
51	Least Cost Routing Area Codes					X		
*51	Station Memory Allocation to Store Caller ID and/or ANI Numbers on Abandoned/ Unanswered Calls			X				
52	Least Cost Routing Code Exceptions for Specified Area Code					X		
*52	Caller ID or ANI Ground/Loop/Tie/DID Line Circuit Abandoned Call Number Store Station Owner Assignments			X				
53	Least Cost Routing Schedule Assignments for LCR Plans					X		
54	Least Cost Routing Route Definition Tables					X		
55-0	Least Cost Routing Modified Digits Table (Delete)					X		
55-1~2	Least Cost Routing Modified Digits Table (Add)					X		
56	Least Cost Routing Station Group Assignments					X		
58-1	Attendant Console Overflow Timer			X				
58-2	Attendant Console Display Type, Answer Button Operation, and Call Waiting Tone			X				
58-4	Attendant Console Answer Button Priority Assignments			X				
58-5	Attendant Console Overflow Destination Assignments			X				
59	Attendant Console Flexible Button Codes			X				
60-1	SMDR Data Output Options			X				
*60	BRI Assignment for Line/Station Operation							X
60-2~7	SMDR Output/Account Code Digit Length		X					
60-8	Call Forward External (Remote Change, Security) ID Code		X					
*61	Analog Trunk Bearer Service							X
*62	Non-ISDN Station Bearer Service							X
*63	Timer for Sending Dialed Digits							X
*64-1	Direct Inward Dialing Parameters							X

Overview

Program Number	Program Title	Initialization & Test	System	Station	Toll Restriction	Least Cost Routing	ACD	ISDN
*64-2	Number of DID/DNIS Digits for Trunk Groups							X
*65	Call by Call Channel Group Assignment							X
*66-1	Channel Group Number Parameters							X
*66-2, *66-4	Call-by-Call Trunk Group Codes and Network ID							X
*66-3	Channel Group/Trunk Parameters							X
*66-5	Line Directory Number (LDN) Registration							X
*66-6	LDN/Trunk Group to Channel Group Assignments							X
*66-7	LDN/Trunk Group Assignments							X
*67-1	Trunk Group Call Direction							X
*67	Call Types for ISDN Trunk Group Supported							X
*67	Call Types for ISDN Trunk Groups							X
*67	ISDN Trunk Group Maximum Channel Reservation							X
*68-1	Calling Number ID Presentation Parameters							X
*68-2	Outbound CNIS Parameters							X
69	Verified Account Codes		X					
*69-1	CNIS Presentation Parameters							X
*69-2	Special Number Assignment							X
70	Verified Account Code Toll Restriction Class Assignments		X					
71-0	DID/Tie/DNIS/ANI Lines		X					
71-1~3	DNIS Number and ANI Line Routing Assignments		X					X
71-4	DNIS Number and ANI Only Lines Voice Mail (VM) ID Assignments		X					
71-5	DNIS Number Name Display		X					
*71~*73	[DN] to [DN], Tie to [DN], and DID to [DN] Ringing Assignments			X				
72	DNIS Network Table Assignments		X					
74	System NT Button Lock Password		X					
76-1	TSIU, WSIU, RSIU, RSIS, and RMDS Port Assignments		X					
76-2	TSIU, WSIU, RSIU, RSIS, and RMDS Port Assignments		X					
77-1	Peripheral Options RSIU, RSIS, RMDS, IMDU, PIOU, PIOUS, and PEPU		X					
77-2	Door Phone Busy Signal/Door Lock Assignments			X				
77-3	Night Ringing Over PIOU External Page Zones		X					
77-4	RSIU Open Architecture Interface (OAI) Data Output Assignments (Caller ID/DNIS/ANI Open Architecture Output Options)		X					
78	Ground and Loop Start CO Line Special Ringing Assignments, DISA, IMDU, RMDS, and Night Ringing Over External Page		X					
79	Door Phone Ringing			X				
*79	Door Phone to [DN] Flashing Assignments			X				
80	Electronic and Digital Telephone Ringing Tones (CO Line Calls)			X				
*80	Call Forward Station Ring Assignment (Release 3.2)			X				

Program Number	Program Title	Initialization & Test	System	Station	Toll Restriction	Least Cost Routing	ACD	ISDN
*81, *84, *87	Ground/Loop Start/ CO Line to Directory / Number Button LED Flash Assignments		X					
81~89	Ground/Loop Start/CO Line/Station Auto Attendant, Attendant Console, and Distributed Hunt Group Ringing Assignments		X					
90	Initializing Program 00~*99	X						
91-1	Automatic PCB Recognition/Port Renumber	X						
91-2	Data Transfer from Temporary Memory to Working Memory	X						
91-9	System Initialization	X						
92	Initializing Speed Dial Numbers, VM ID Codes, Character Message Memory Timed Reminders, Digital Telephone Volume, Called ID, ANI, and Call Forward Backup RAM	X						
93	CO Line Identification		X					
97	Printing Program Data through SMDR		X					

Alphabetical Program Listing

This alphabetical program listing gives you features/topics and the corresponding Strata DK program numbers that relate to the topic

Feature or Topic	Program Number
Account Codes	15, 70, 39, 69, 30, 60
ACD	03, 09, *09, 10-4, 11, 14-0, 14-1, *14-1, 14-2, *14-2, 14-3, 14-4, 14-5, 14-6, 14-8, 14-9, 14-71, 14-72, 14-73, 15, 17, 18, 35, 39, 71-1~3
Add-on Module	*29
Alarm Sensor	39
All Call Voice Page	05, 10-2, 31, 39
Alert Signal	39
Alternate Point Answer	10-1
Amplified Conference (External)	10-2, 10-3
ANI	10-3, 20, 39, *51, *52, 59, 60-1, 71-0~5), 72, 77-4
Attendant Console	03, 58-1, 58-2, 58-4, 58-5, 59
Auto Attendant (Built-in)	09, 10-3, 23~26, 78, 81~89
Automatic Busy Redial (ABR)	10-1, 16, 30, 39
Automatic Callback	05, 39, 10-2
Automatic Hold	35
Automatic Hold Recall	34
Automatic PCB Recognition	91
Automatic Preference	32
Automatic Release Hold/VM Port	15
Background Music	05, 10-2, 19, 39
Busy Override	05, 31
Busy Station Transfer/Ringing	35
Cabinet Type Identification	*03
Call Blocking (VM Ports)	31
Call Forward Blocking with Handsfree	35
Call Forward External	05, 12, 15, 41, 60-8
Call Forward Station Ring (ground/loop start lines)	*80
Call Forwarding (all types)	10-2, 36, 39, 40
Call Park Orbits	*05, *37, 39, 58-4, 59

Feature or Topic	Program Number
Call Pickup	10-1, *15, *31, 39
Call Transfer with Camp-on	10-1
Caller ID	03, 10-3, 20, 39, *50, *51, *52, 59, 60-1, 77-4, (DK 14 only: 76-1, 76-2)
Camp-on	10-2, 31, *34, 37
Centrex/PBX Compatible	42-0, 42-1~8, *45
Centrex Ringing Repeat	10-1
CO/Centrex/PBX Feature Buttons	39, 42-0, 42-1~8
CO Line Access	39, 40, 41
CO Line Alpha Identification	93
CO Line Groups	16
CO Line Reseize Guard Time	10-1, 42-0
CO Line Queuing	05, 16
CO Line Ringing	78, *80, 81~89, *81, *84, *87
Conferencing	10-1, 10-2, 10-3, 15
Credit Card Calls (0 + dialing)	43, 60-7
Data Port/DIU Configuration	20, 21, 22, 39
DAY/NIGHT Mode	10-2, 78, 81~89, *80, *81, *84, *87
Delayed Ringing	*80, 82, 83, 85, 86, 88, 89
Digital Telephone	03, 27, 30, 38, 39, 80, 92-5
Direct Inward Dialing (DID)	*09, 15, 17, *17, 30, 71, 72
Direct Inward System Access (DISA)	15, 10-1, 60, 78
Direct Station Selection Buttons	29-1~29-8, 39
Directory Number	04, *04, *33, 39, 71-(0-3), *71, *72, *73, 79, *79, 81-89, *81, *84, *87
Directory Number Buttons	39
DISA Code Revision	04, 05, 30, 40, 41
Distinctive Station Ringing	10-2, 80
Distributed Hunt	*04, 33, *40, 71-(0-3), 81-89, *81, *84, *87
DKAdmin	77-1

Overview

Alphabetical Program Listing

Feature or Topic	Program Number
DNIS	12, 17, 20, 60-1, 71-(0-5), 72, 77-4
Do Not Disturb	39
Do Not Disturb Override	05, 30
Door Lock Control	39, 77-1, 77-2
Door Phones	05, 77-1, 77-2, 79, *79
DSS Console Features	03, 28, 29-1~29-8, 10-2
DSS DKT/EKT	28
DTMF and Dial Pulse Assignments	10-1, 15, 30, 39
DTMF Receiver (QRCU3, K5RCU, RRCS) Operation	03, 12, 15
DTMF Signal Time, CO lines (80/160 ms)	10-1
DTMF Signal Time, VM Ports (80/160 ms)	10-2
DTMF Tone/No Tone/Padded Tone Return	10-2
DTMF Continuous Tone (2000-series DKT)	35
Emergency Numbers	44-91~93
Enhanced 911 (E911)	*11-0, *11-1, *11-2, *11-5, *11-6, *11-8, *12, *13
Exclusive Hold	10-1
Executive Override	05, 10-2, 30
External Page Interface	10-2, 77-1, 77-3, 78
External Zone Paging	05, 77-1, 77-3
Fixed Call Forwarding	36, 39
Flash Key Assignment	39
Flash Timing	12
Flexible Access Code Numbering	05, *05
Flexible Button Assignments	38, 39
Flexible Directory Numbering	04, *04, 05, 39
Flexible Line Ringing Assignment	81~89
Flexible PCB Slot Configuration	91-9, 91-1, 03
Forced and Voluntary Account Codes	15, 30, 60, 39
Group Paging	05, *30
Group Pickup	*31

Feature or Topic	Program Number
HMIS	03, 50-1, 50-2, 50-3, 50-4, 50-5, 50-6, 51, 52, 53, 54, 55-0, 55-1/2, 56, 60-2, 60-3, 76-1
ISDN	10-1, 10-4, 16, *16, *42-1, *42-2, *43-1~3, *44, *60, *61, *62, *63, *64-1, *64-2, *65, *66-1~7, *67-1~4, *68-1, *68-2, *69-1, *69-2
Handsfree Answerback	17, 31
Hold/Park Recall Timing	34
Hunting, Station	10-2, 22, 33
Immediate Transfer with Soft Key	10-2
Initialization (system programs)	91-9, 91-1, 90
Initialization (system/personal memory)	91-9, 92
Keystrips	38
Least Cost Routing	*45-2, *45-3, *45-4, 50~56
Liquid Crystal Display Features	10-2, 35, 39
Logical Port Display/Change	01
RAM Memory Test	00 (Part 2)
Message Center	13, *32
Message Waiting/Flash	05, 10-2, 12, 35, 39
Microphone Control	30, 39
Modem Pool Port Assignment	20, 21
Music-on-Hold	77-1
Night Pickup Code	05
Night Ringing over External Page	77-1, 77-3, 78
Night Transfer	29, 39, 59, 77-1, 78
Night Transfer Lock	*36, 39, 59, 74
Off-hook Call Announce	03, 30, 31, 39
On-hook Dialing	32
Outgoing Call Restriction	41
Paging-DKT/EKT (Also see Group Paging and External Paging)	31, 39
Passwords-Remote Programming	00
Pause Timing	12, 39
PBX Access Code	42-1~42-8
PBX Backup	42-0

Feature or Topic	Program Number
Physical Port Display/Change	02
Pooled CO Lines	16, 39
Pooled Line Buttons	16, 39
Pooled Line LED – No Flash	31
Port/Station Number Assignment	04
Privacy/Non-Privacy	31, 30, 39
Privacy Override	10-2, 30, 31
RAM Test (see Memory Test)	00 (Part 2)
Redial Last Number	39
Remote Administration and Maintenance	00, 03, *09, 77-1, 78
Repeat Last Number Dialed	39
Ring Transfer	10-1, 37
Ringling Repeat	10-1
Ring Tones	80
Ring Flash Assignments	*71~*73, 81~89, *81, *84, *87
Ringling Line Preference	32, 81~89
RS-232 Interface	03, (41, 42, 43, 49), 20, 76, 77-1, 77-4
Saved Number Redial	39
Security Code (CF-EXT.)	60-8
Security Code (DISA)	05, 30, 60-6
Security Code (R. Maintenance)	00
Slot Assignment	03
Software Version	00
Speakerphone Assignment	30
Speed Dial	10-1, 30, 39
Speed Dial Clear	92
Speed Dial Entry Timeout	10-3
Standard Telephone Options	10-2, 30, *34, 35
Station Class of Service	30, 31, *34, 35
Station Hunting (Data Calls)	22
Station Hunting (Voice Calls)	33
Station Message Detail Recording (SMDR)	03, 60-1~60-7, 76, 97
Station-to-Station Volume	10-1
SMDI VM Interface	03, 10-2, 10-3, 13, 31, *32, *40, 76

Feature or Topic	Program Number
T1 Assignments	*41, *42
Tandem CO Line Connections	10-1, 15
Tenant Service	*15, *36, 39, 77-3, 74
Tie Lines	03, 04, 15, 17, 30, 37, 71, 72
Toll Restriction	10-1, 30, 35, 41~48, *45-1~3
Toll Restriction Override	10-1
Toll Restriction Override Code Revision	30
Toshiba Proprietary VM Interface	03, 10-2, 13, *32
Transfer Privacy	10-1
Traveling Class	44-1~8
Traveling Class Code Revision	30
Verifiable Account Codes	15, 30, 39, 60, 69, 70
Verifiable Account Codes Revision	30
Voice Mail Interface	10-2, 31, 33, 39
Voice or Tone Signaling	05, 10-1, 10-2
Volume Reset (Digital Telephones)	92-5
Volume Set (Digital Telephones)	27
Voluntary Account Codes	39

How to Program a Strata DK System

Fill out the record sheets that are provided, then enter this data using a 20-button LCD digital (DKT) or electronic (EKT) telephone. Strata DK enables you to enter data from an on-site or off-site PC with Toshiba DKAdmin software. Toshiba highly recommends this easier method of programming.

DK14/DK40i: the programming telephone must be any 20-button LCD DKT (or EKT, DK40i only). The DKT must be connected to a Base KSU, PDKU, RDSU, QCDU, or KCDU digital port. An EKT must be connected to a PEKU port.

DK424: the programming telephone must be a 20-button LCD DKT or EKT connected to circuit 6 of a PDKU or PEKU installed in cabinet slot 11 and/or slot 12.

Note Telephones connected to an RDSU or PESU cannot be used to program DK424.

Programming Section Layout

Each programming section within a chapter begins with the program’s number and title, followed by processor and program type, initialized default, program sequence, then record sheets. A program overview and additional program information are given after the record sheets (see Figure 1-1).

Note Some common program sections also include examples for your convenience.

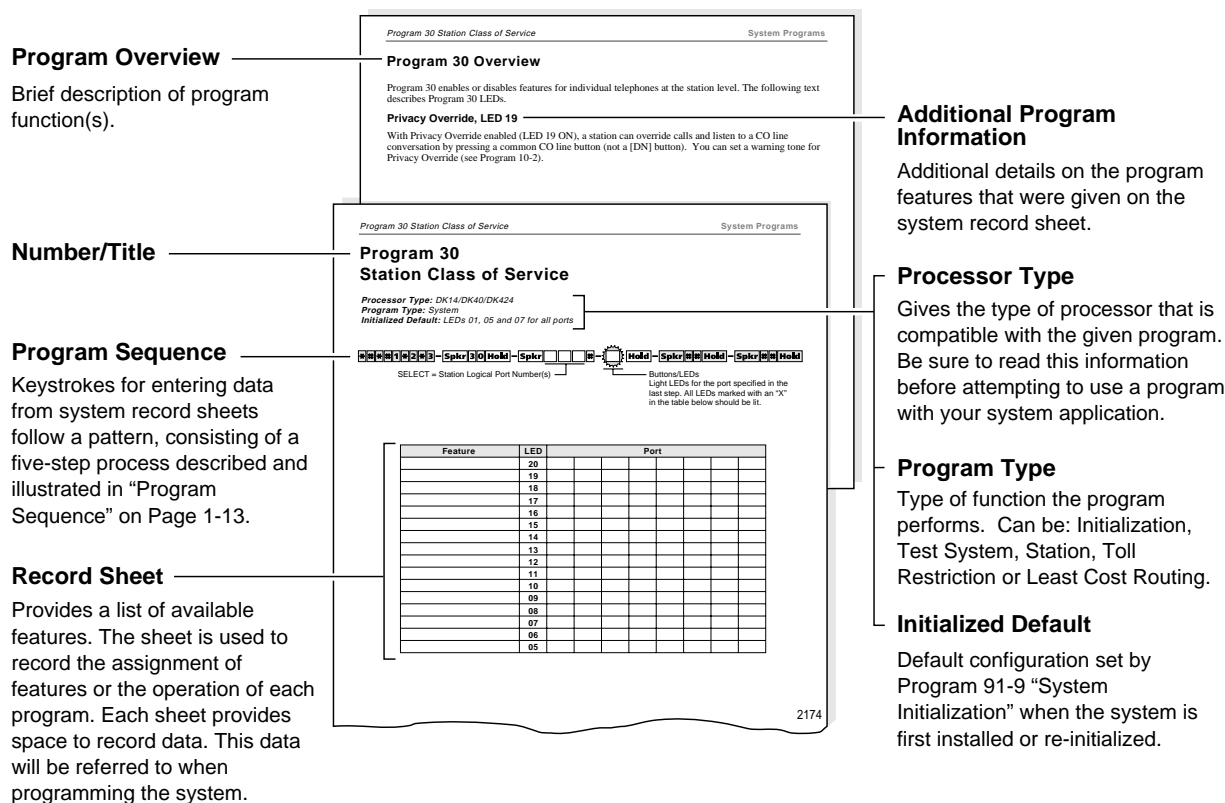

Figure 1-1 System Record Sheet Sample

Program Sequence

Detailed data entry instructions are on the top of each record sheet (see Figure 1-2).

► To use the program sequence on the record sheet

1. From the programming telephone, enter the programming mode by pressing a series of shaded buttons. The shaded buttons represent the entry sequence for all programs.
2. Enter the program number. This sequence is unique for every program. The buttons are white on every record sheet.
3. Enter the program data. Again, this sequence is unique for every program. The buttons are white on every record sheet. To make another entry, repeat this step until ready to exit the current program.
4. Exit the current program. This sequence never changes, and the buttons are always shaded. Upon exiting the current program, repeat Step 2 to enter another program, or continue with Step 5 to exit the programming mode entirely.
5. Exit the programming mode by pressing the same button sequence as in Step 4. This sequence also never changes and is always shaded.

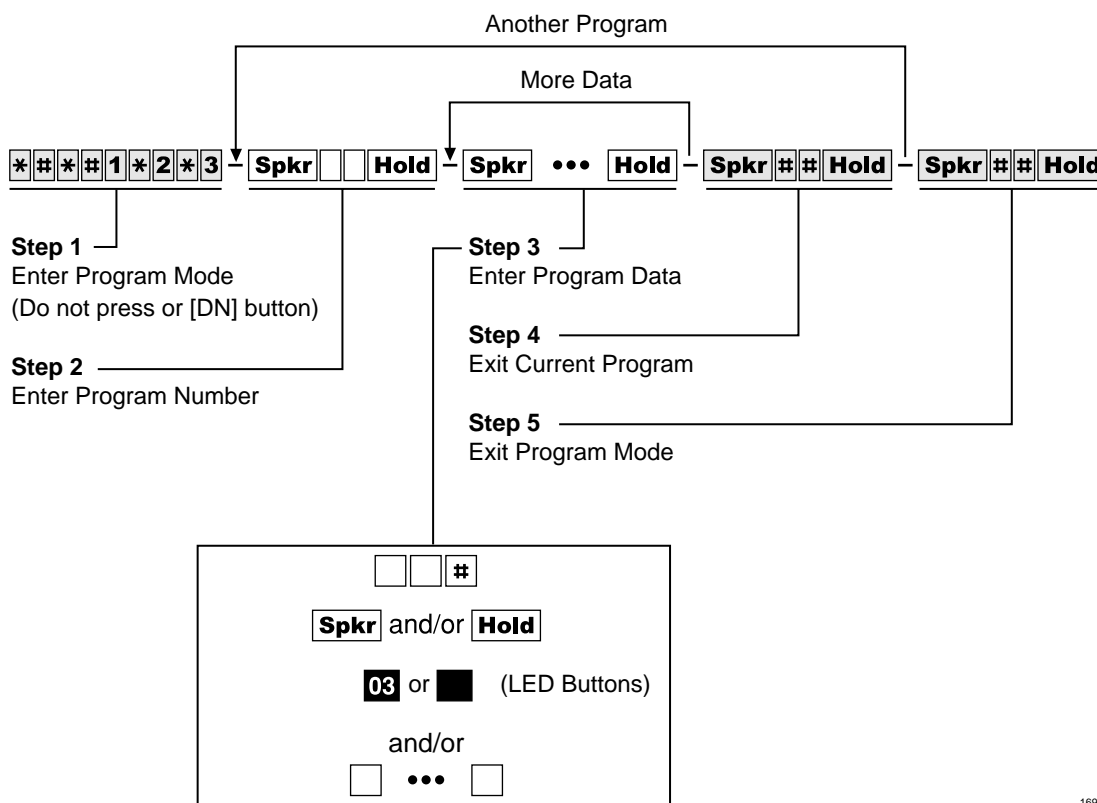

1697

Figure 1-2 Programming Button Sequence Overview

Programming Data Variations

There are two different ways to enter data in Step 3 (Figure 1-2) of a program: pressing the buttons on the dial pad and pressing the LED buttons. Many programs are multidimensional and involve both types of entry.

Simple Programs

Simple programs such as Program 00, only require data to be specified through the dial pad. Data entered from the dial pad displays on the programming digital or electronic telephone's LCD, along with prompts and confirmations.

Multidimensional Programs

Once a program number is entered, the first dimension (usually a CO line number, a station port number, or a range of ports) must be specified. Upon specifying this first dimension on the dial pad, programming button LEDs 01~20 light in the default configuration.

The status of each LED can be changed by pressing its associated button. Pressing the button while its LED is lit turns the LED OFF; pressing the button while its LED is OFF turns the LED ON. An example of multidimensional programming is Program 30.

Range Programming

Data can be entered for a range of stations, [DN] reference ports and CO lines with some programs.

► To enter a range

- Enter a “*” between the starting point of a range and the ending point of a range.

For example, to program the station range of 001~010 for Program 35, press **001*010**.

- ✦ When programming a range of station ports, the station's programming LEDs indicate whether the data programmed matches for all items in the range:
- ✦ LED ON: Indicates that all ports in the range are programmed with the data choice that lights the particular LED.
- ✦ LED OFF: Indicates that all ports in the range are programmed with the data choice that does not light the particular LED.
- ✦ LED Flashing: Indicates that data is currently inconsistent for all ports in the range. Some may be programmed with the LED ON; some with the LED OFF.

CO Line Programming

Since the programming telephone only has 20 buttons, data can only be entered for 20 CO lines at a time.

► To program another range

- Press the **Page** or **Scroll** button below the LCD.

For example, to change from one range to another in Program 15, enter the program code, then press **Scroll** to advance or **Page** to go back to another range.

If the programming telephone is a digital telephone, all CO lines within a range can be activated or deactivated for a feature by pressing the **Vol ▲/Vol ▼** buttons.

- Press **Vol ▲** to turn all LEDs ON; press **Vol ▼** button to turn all LEDs OFF.

► To check the status of a CO line in Program 15

1. Press the **Mode** button (below the LCD) after entering the program code.
2. Then enter the CO line number to be verified.
3. Press **#** to display the status of the CO line and to advance to the next CO line.

Programming LED Buttons Keystrip Template

You place a special buttonstrip template (see Figure 1-3) over the 20 flexible feature buttons of the programming telephone. The template assigns a series of numbers to each of the 20 buttons that correspond with tables found on the record sheets for programming purposes.

Since each button represents more than one CO line, depending on the CO line range selected, the template assigns more than one number to each button.

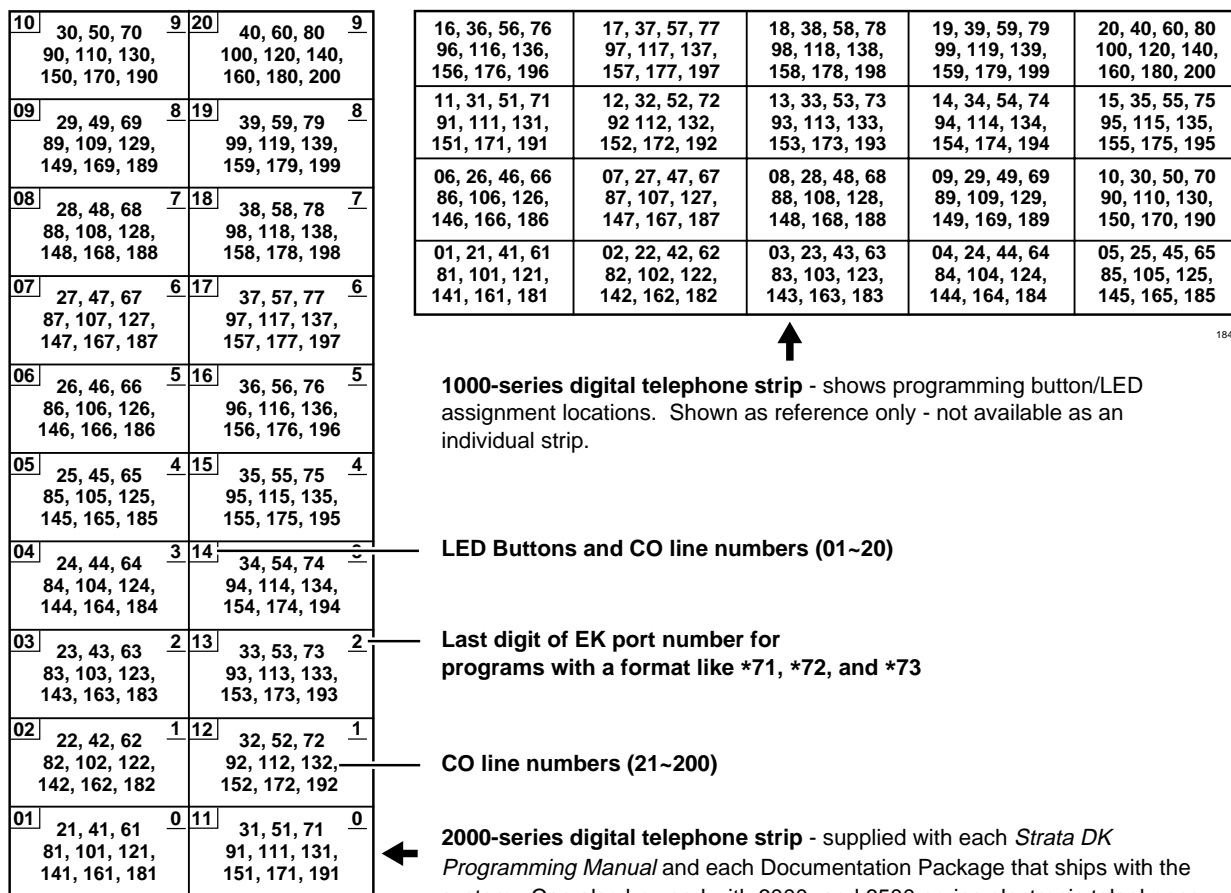

Figure 1-3 LED Buttons Programming Keystrips

First-time Programming

Follow these general procedures the first time you install a system or after major hardware changes and/or you need to start from scratch.

Step 1: Check Minimum Hardware Requirements

A system must have the following minimum hardware installed for programming, as described in the Installation chapters of the *Strata DK Installation and Maintenance Manual*.

► To check hardware requirements on the DK14 and DK40i

1. Make sure the base cabinet power supply was tested and is functional.
 2. Make sure a 20-button digital LCD DKT telephone (equipped with a programming template) is connected to any digital telephone circuit (Base KSU, PDKU, QCDU, KCDU or RDSU digital port); or make sure that a 20-button electronic LCD EKT telephone is connected to a PEKU electronic port (not PESU).
- ✦ **DK14 and DK40i:** make sure the Base KSU's BATT jumper is in the ON position.

► To check hardware requirements on the DK424

1. Make sure the base cabinet power supply was tested and is functional.
2. If using an RCTUE/F, remove the small jumper PCB (MBJU) from the front side of the DK424 base unit backplane (between slot R11 and the RCTU slot. All other RCTUs require the MBJU PCB.
3. Make sure an RCTUA, RCTUBA, RCTUC/D or RCTUF is installed and that its BATT jumper is in the ON position.
4. Make sure a PDKU or PEKU, is installed in Slot S11 or S12 in the base cabinet (S11 if RSIU is not installed, S12 if RSIU is installed in S11).
5. Make sure a 20-button LCD DKT or EKT telephone (equipped with programming template) is connected to physical port 005 and/or port 013 (PDKU or PEKU - circuit 6/slot 11 and/or circuit 6/slot 12). Do not use RDSU or PESU.

Step 2: Initialize the System

1. From a 20-button LCD programming telephone, or from DKAdmin on a PC, run Program 91–9 *twice* in succession to initialize the system. At this point it is not necessary that all PCBs are installed. However, if they are, Program 03 codes are automatically assigned to the appropriate slots.

CAUTION! If you run Program 91-9 while the system is in service, all program data is erased and all calls are dropped.

Program 91-9 sets the following elements to initial default status:

- ✦ Data for Programs 00~*99
- ✦ Speed Dial Memory
- ✦ Logical/Physical Port Locations
- ✦ Voice Mail Identification Codes
- ✦ Character Message Memory

- ✦ Timed Reminders
 - ✦ Digital Telephone Volume Levels
 - ✦ Call Forward Memory (Power OFF, then ON).
 - ✦ Station Message Waiting Status
 - ✦ Caller ID Lost Call Memory
2. Install all PCBs. Run Program 91-1 to inform the software of the system hardware configuration.

Step 3: Run Programs 03 and 19-1

1. Run Program 03 for all PCBs that have options.
2. Run Program 19-1 to inform the software of the system option Alternate BGM slot.

Step 4: Run Program 00

- Run Program 00 - Part 1 to assign remote maintenance security codes. Run Program 00 - Part 2 to test the processor and RAM.

Step 5: Set Date, Time and Day

You can set date, time and day anytime - individually or all.

1. Use DKT or EKT assigned to logical Port 000 or attendant console.
2. Make sure the handset is on-hook.
3. Set the date:

[PDN] # 6 5 1 - - **Redial**

Date in year/month/day format (YYMMDD). If month or day is single digit, precede with a zero.

4. Set the time:

[PDN] # 6 5 2 - - **Redial**

Time in hours/minutes/seconds format (HHMMSS from 000000 to 235959). If any of these values is single digit, precede with a zero.

5. Set the day:

[PDN] # 6 5 3 - - **Redial**

Enter the digit for today's day:

- 1 = Sunday
- 2 = Monday
- 3 = Tuesday
- 4 = Wednesday
- 5 = Thursday
- 6 = Friday
- 7 = Saturday

Step 6: Run Additional Programs as Required

Programming Examples

Some commonly used programs have explicit examples (listed below). Refer to these pages to help familiarize you with running these programs.

Program	Page
Program 91-9—System Initialization	2-2
Program 90—Initializing Programs 00~*99	2-4
Program 91-1—Automatic PCB Recognition and Logical/Physical Port Initialization	2-6
Program 92—Initializing Speed Dial Numbers, VM ID Codes, Character Message Memory, Timed Reminders, Digital Telephone Volume, and Call Forward Backup Memory	2-9
Program 00—Software Check	2-12
Program 03—DK14 Slot Assignments and DK14/DK424 Flexible PCB Slot Assignments	3-3, 3-4, 3-6
Program 04—Station Logical Port Primary Directory Intercom or Number Assignment	3-12
Program 30—Station Class of Service	3-73
Program 33—Station Hunting	3-90

This chapter gives you information on the Strata DK's Initialization and Test programs. The programs in this chapter are not given in numerical order, rather in order of importance. These programs include:

- ♦ **Program 91-9** – System Initialization
- ♦ **Program 90** – Initialize Programs 00~99
- ♦ **Program 91-1** – Automatic PCB Recognition and Port Renumber
- ♦ **Program 91-2** – Data Transfer from Temporary Memory to Working Memory
- ♦ **Program 92** – Initializing Misc. Backup RAM
- ♦ **Program 00** – Part 1: Software Check
- ♦ **Program 00** – Part 2: RCTU RAM Test

Examples are also given for these programs - except Programs 91-2 and Program 00 - Part 2.

Program 91-9 – System Initialization

Processor Type: DK14, DK40i, All RCTUs

Program Type: Initialization

Initialized Default: See individual programs

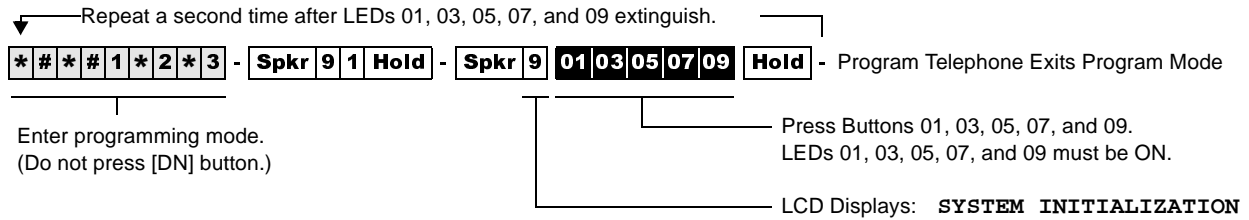

Program 91-9 Overview

Note Always run Program 91-9 before entering the customer database when first installing a system or when its software must be set to the default configuration, but not while system is in service.

CAUTION! If you run Program 91-9 while the system is in service, it will erase all program data and drop all calls.

Running Program 91-9 also runs Program 03 and assigns codes to all PCBs (except options) installed. It also erases all Program 03 option codes for piggyback PCBs, DSS consoles, RRCS, etc., except the RCOS PCB Code (17).

Program 91-9 erases all random or programmed data in all Strata DK software programs and sets all program data to the default value. It automatically runs all other initialization Programs 90-00~*99, 91-1, and 92-1~9. It also brings back logical and physical ports to their initialized settings.

If you are installing the system processor(s) for the first time, after initializing the system, test the RAM: run Program 00 Part 2.

CAUTION! Running Program 00 Part 2 drops all calls in progress and interrupts telephone service for 15 seconds. This test will not erase programmed customer data.

Important! Do not use Program 91-9 if you are only making minor programming changes and system programming is basically correct.

Note Run Program 03 after Program 91-9 for: PCBs with options such as Dual-tone Multi-frequency Receivers K5RCU, QRCU3, RRCS, and DSS consoles, etc.

...or if entering a customer database into system RAM memory before other system PCBs (stations, lines, options) are installed. Program 03 identifies which universal and option PCBs (e.g., RRCS, etc.) are to be installed in each cabinet slot.

Program 91-9 Example

Action (press buttons + LED Buttons)	LCD Response
1. Use the programming LCD electronic or digital telephone. (See "Programming Examples" on Page 1-16.)	No. N-N ¹ Jan 20 Sun 06:43
2. ***#1*2*3 Enter programming mode. (Do not press [DN] button.)	Program Mode
3. Spkr (Speaker) 91 Hold Access Program 91. System beeps after Spkr (Speaker) is pressed to indicate program number may be entered.	Program = 91 Data Store
4. Spkr (Speaker) Prepare the system for a station port selection.	91 Select =
5. Press 9	System Initialization
6. Press LED Buttons 01, 03, 05, 07, and 09 (LEDs turn ON)	System Initialization
7. Press Hold The telephone will exit the programming mode and button LEDs 01, 03, 05, 07, and 09 will go out after a short delay. Make sure all LEDs go out before proceeding to Step 8.	No. N-N (Month Day Time)
8. Repeat Steps 1~7 a second time.	No. N-N (Month Day Time)

1. N-N is the Program Telephone [DN].

Program 90 – Initialize Programs 00~*99

Processor Type: DK14, DK40i, All RCTUs

Program Type: Initialization

Initialized Default: See individual programs

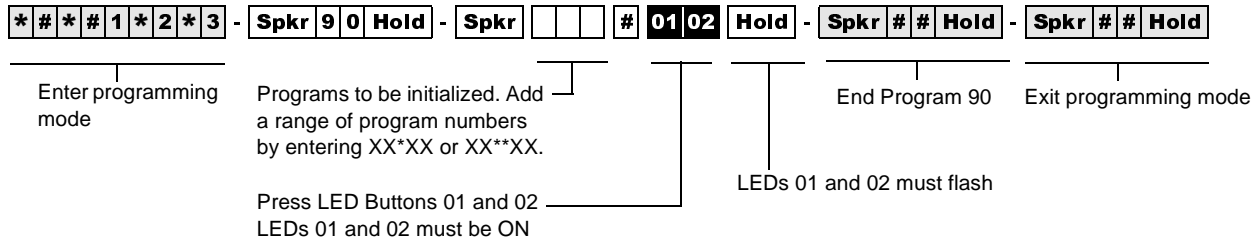

Program 90 Overview

Program 90 enables you to clear all customer data and initialize individual programs or range of programs.

Important! *When installing the system, you must run Program 91-9 which runs Program 90 (before running any other program); if you do not, the system could begin to operate erratically.*

Notes

- Running Program 91-9, automatically runs Program 90.
- To initialize all programs without dropping calls or erasing user names, speed dial numbers, voice mail ID codes, etc., enter **00* *99** as “Programs to be initialized.”
- Each “*” program record sheet immediately follows the program record sheet having the same number (example: *31 follows 31 record sheet). However, in system memory all “*” programs follow Program 99. Therefore, “*” program ranges must be initialized separately from non-star programs unless initializing all system Programs (00**99).
For example, to initialize Programs 30, *30, 31, *31, and 32: initialize the range (30*32), for Programs 30, 31, 32; and the range (*30**31), for Programs *30 and *31.
- If you are installing the system for the first time, run Program 91-9 to erase random data from RAM (caused by battery jumper movement to the internal battery). You can then skip Program 90, since Program 91-9 automatically runs Program 90.

Program 90 Example

Action	LCD Response
1. Use the LCD programming phone per Minimum Hardware Requirements on -14.	No. N-N ¹ Jan 20 Sun 06:43
2. Enter Program mode by pressing ***#1*2*3 . (Do not press [DN] button.)	Program Mode
3. Spkr (Speaker) 90 Hold Access Program 90. System beeps after Spkr (Speaker) is pressed to indicate program number may be entered.	Program = 90 Data Store
4. Spkr (Speaker) Prepare the system for the programs to be initialized.	90 Select =
5. 00* *99+ LED buttons 01 & 02 Enter Program numbers individually, followed by #, or in a range. For a range, separate the low program number and the high program number with an asterisk. 00* *99 initializes all Programs 00~*99. Star * Program memory follows Program 97.	90 Select = 00**99 Data Clr
6. Hold Secure data in system programming. LEDs 01 and 02 flash.	90 Select = 00**99 Data Programmed
7. Spkr (Speaker) Prepare system for another selection (go back to Step 5) or exit Program 90 (continue with Step 8).	90 Select =
8. ##Hold Secure default data in system memory. LED 01 and 02 continue to flash.	90 Select = ## Data Programmed
9. Spkr (Speaker) Exit Program 90. Enter another program number (see “Program 92 Example” on Page 2-10) or exit programming mode (go to Step 10). System beeps to indicate it is exiting Program 90.	Program =
10. ##Hold Exit programming mode. The system will not allow the Spkr (Speaker) LED to light to re-enter the programming mode.	No. N-N Jan 20 Sun 06:43

1. N-N is the Program Telephone [DN].

Initialization & Test

Program 91-1 – Automatic PCB Recognition and Port Renumber

Processor Type: DK14, DK40i, All RCTUs

Program Type: Initialization

Initialized Default: None

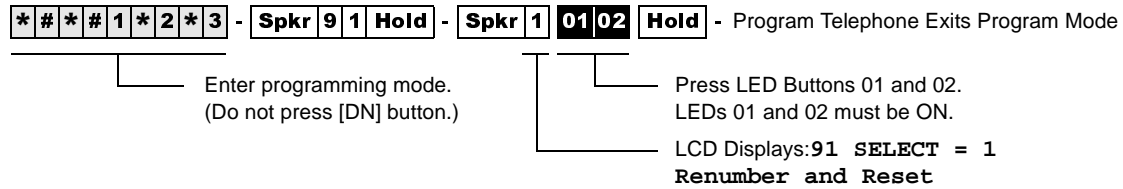

Program 91-1 Overview

Program 91-1 makes slot code assignments to installed PCBs that do not have options - such as a PDKU without a Data Interface Unit or Off-hook Call Announce (OCA), the common control without a Dual-tone Multi-frequency Receiver (RRCS), K5RCU, QRCU3, etc.

Program 91-1 also sets physical *and* logical ports to their initialized settings - even if you previously relocated them. (See Program 01 and 02 for initialized settings.). Programs 04, *04, 05, *05, *09, or 71 are not affected.

CAUTION! Running Program 91-1 drops all calls.

Important! To identify Program 03 PCB slot codes, run Program 91-1 after you install all PCBs.

Notes

- You can run Program 91-1 after setting PCB option codes with Program 03; this does not erase option codes. For example, if Slot 00 is assigned code 92, Program 91-1 will not erase the codes previously assigned with Program 03.
- If you install PCBs before initializing the system with Program 91-9, it is not necessary to run Program 91-1 to assign the Program 03 PCB slot codes for the installed PCBs. You must always run Program 03 to identify PCB options such as K5RCU, QRCU3, and RRCS codes 92, 93 and 94 and PDKU codes 61, 62, and 64, etc.

Program 91-1 Example

Action (press buttons + LED Buttons)	LCD Response
1. Use the LCD programming phone per Minimum Hardware Requirements on -14.	No. N-N ¹ Jan 20 Sun 06:43
2. ***#1*2*3 Enter programming mode. (Do not press [DN] button.)	Program Mode
3. Spkr (Speaker) 91 Hold Access Program 91. System beeps after Spkr (Speaker) is pressed to indicate program number may be entered.	Program = 91 Data Store
4. Spkr (Speaker) Prepare the system for a station port selection.	91 Select =
5. Press 1	91 Select = 1 Renumber and Reset
6. Press LED Buttons 01 and 02 (LEDs turn ON)	91 Select = 1 Renumber and Reset
7. Press Hold The telephone will exit the programming mode and button LEDs 01 and 02 will go out after a short delay.	No. N-N (Month Day Time)

1. N-N is the Program Telephone [DN].

Program 91-2 – Data Transfer from Temporary Memory to Working Memory

Processor Type: DK14, DK40i, All RCTUs

Program Type: Initialization

Initialized Default: See individual programs

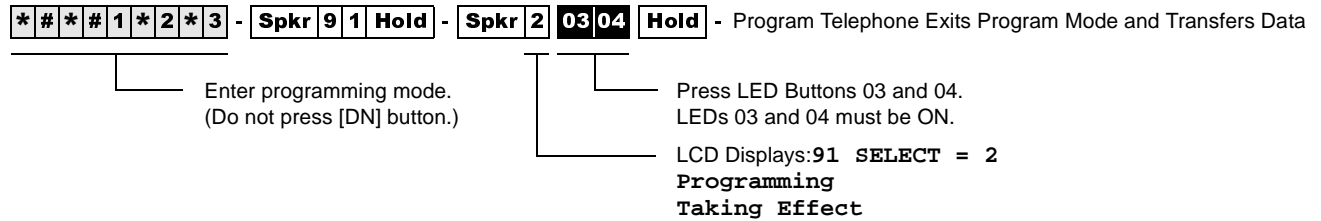

Program 91-2 Overview

Program 91-2 simulates turning system power OFF for five seconds then ON to transfer data from temporary memory to working memory.

This power OFF / power ON sequence is required when programming with a telephone or when using DK Admin/DK Backup. In these cases Program 03, *41-2, *50 and 76-1 data must be transferred from temporary to working memory.

Program 91-2 does not change or erase any programmed data including directory numbers set in Program 04 and *04 or logical/physical port assignments in Program 01 and 02.

CAUTION! Running Program 91-2 drops all calls and renders the system inoperative for up to eight seconds.

Program 92 – Initializing Misc. Backup RAM

Processor Type: DK14, DK40i, All RCTUs

Program Type: Initialization - Includes: Initializing Speed Dial Number, VM ID Codes, Character Message Memory, Timed Reminders, Digital Telephone Volume, Called ID, ANI, and Call Forward Backup RAM

Initialized Default: See individual programs

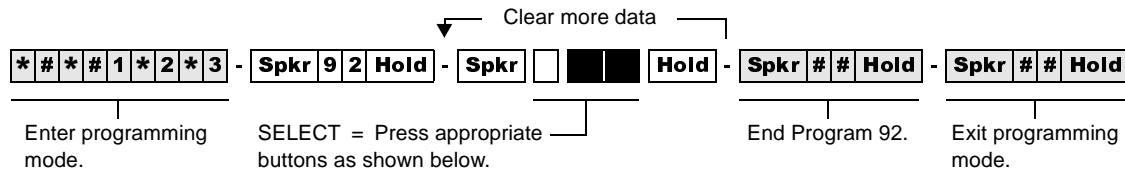

- 1** **01 03** Clears Station Speed Dial, Voice Mail ID Codes, and LCD memos assigned to Station Speed Dial numbers.
- 2** **01 04** Clears System Speed Dial and LCD memos assigned to System Speed Dial numbers.
- 3** **02 03** Clears Character Message Memory (Station and System) and User Name/Number Display.
- 4** **02 04** Clears Timed Reminders.
- 5** **01 05** Resets digital telephone volume levels to initialized settings, specifically, speaker volume levels for Internal Calls [DN], Tone/BGM, Busy Override (muted ring), and Ring volume to approximately mid-range on all DKTs. Program 92-5 does not affect digital telephone handset receiver volume levels. Use Program 27 to set off-hook digital telephone handset receiver volume levels.
- 9** **03 04** **Hold** Power OFF 5 seconds; then Power ON Clears Call Forward and Message Waiting Memory (all stations). Program 92-9 does not affect Call Forward External or Fixed Call Forward settings.

Program 92 Overview

Program 92 clears all previously entered or random data (of the type listed) but does not clear data in system Programs 00~*99.

CAUTION! You must run Program 92 when first installing the system or an RCTU; if you do not, the system could begin to operate erratically.

Running Program 91-9 automatically runs Program 92 (1~9) to erase customer data.

Notes

- Running Program 92-5 does not affect digital telephone handset receiver volume levels. Use Program 27 to set off-hook handset receiver volume levels for digital telephones.

Initialization & Test

Program 92 – Initializing Misc. Backup RAM

- Program 92-9 does not affect Call Forward External or Fixed Call Forward settings.
- You must power the system OFF then back ON to clear telephone LCD Call Forward Displays and Call Forward button LEDs. Call Forward memory is cleared when you run Program 92-9, even if system power is not cycled.

Program 92 Example

Action (press buttons + LED Buttons)	LCD Response
1. Use the programming LCD electronic or digital telephone. (See “Step 1: Check Minimum Hardware Requirements” on Page 1-14.)	No. N-N ¹ Jan 20 Sun 06:43
2. ***#1*2*3 Enter programming mode. (Do not press [DN] button.) System beeps after Spkr (Speaker) is pressed to indicate program number may be entered.	Program Mode
3. Spkr (Speaker) 92 Hold Access Program 92.	Program = 92 Data Store
4. Spkr (Speaker) Prepare the system for selection of programs to initialize. For new system installation perform all 1~4.	92 Select =
5. Select one of the following. 1 + LED Buttons 01 & 03 Clears Station Speed Dial, Voice Mail ID codes, and LCD memos assigned to station speed dial numbers.	92 Select = 1 Each Dial Clr
or... 2 + LED Buttons 01 & 04 Clears System Speed Dial and LCD memos assigned to system speed dial numbers.	92 Select = 2 Common Dial Clr
or... 3 + LED Buttons 02 & 03 Clears Character Message Memory (station and system) and user name display.	92 Select = 3 Msg Clr
or... 4 + LED Buttons 02 & 04 Clears timed reminders.	92 Select = 4 Tmr Reminder Clr
or... 5 + LED Buttons 01 & 05 Presets the Ring, Speaker, Mute Ring, and Intercom Tone, BGM, volume levels of all digital telephones to approximately mid-range.	92 Select = 5 DKT VR Initial
or... 9 + LED Buttons 03 & 04 Clears Call Forward and Message Waiting (R3) Memory except Fixed Call Forward Memory.	92 Select = 9 Back Up RAM Clr
6. Hold LEDs lit in Step 5 turn off to secure data in system programming. Repeat Steps 4~6 until Step is completed.	92 Select = (1~0) Data Programmed

1. N-N is the Program Telephone [DN].

Action (press buttons + LED Buttons)	LCD Response
7. Spkr (Speaker) Prepare system for another selection (go back to Step 5) or exit Program 92 (continue with Step 8).	92 Select =
8. ##Hold Initialized data in system memory (LEDs got out).	92 Select = ## Data Programmed
9. Spkr (Speaker) Exit Program 92. Enter another program number (see “Program 30 – Station Class of Service” on Page 3-73) or exit programming mode (go to Step 10). System beeps to indicate it is exiting Program 92.	Program =
10. ##Hold Exit programming mode.	Jan 20 Sun No. N-N 06:43

Initialization & Test

Program 00 – Part 1: Software Check

Processor Type: DK14, DK40i, All RCTUs

Program Type: Test - Includes: Remote Maintenance Security Code Assignments

Initialized Default: None

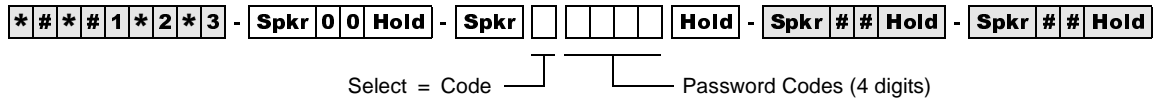

Select = Code	Item	Password or S/W Check Codes	LCD Display
0	ROM Version (not programmable)		Version =
1	1st Level Password		Password =
2	2nd Level Password		Password =
8	Software RAM Checksum (not programmable)		Sum =
9	Power Cycle Counter (not programmable)		Counter =

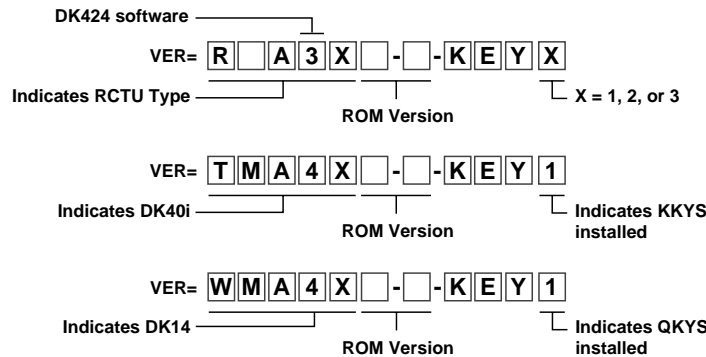

1830

DKT LCD Display	RCTU Type
WMA4	DK14
TMA4	DK40i
RAA3X	RCTUA3
RBA3X	RCTUBA3/RCTUBB3
RCA3X	RCTUC3/D3
REA3X	RCTU E3/F3

Key Type	Description
KEY 1	AA: Indicates built-in Auto Attendant software (RKYS1, KKYS, or QKYS installed).
KEY 2	ACD: Indicates Automatic Call Distribution software and AA (RKYS2 installed).
KEY 3	ACD/MIS: Indicates Automatic Call Distribution, Management Information System Software, plus AA and ACD (RKYS3 installed).
KEY 4	Open Architecture Interface (OAI) and AA, plus AA, ACD, and ACD/MIS (RKYS4 R3.2 installed).

Program 00 Part 1 - Overview

This program enables you to run various checks on the Strata DK System.

DK14: the QKYS feature key must be installed on the QRCU3 PCB to allow AA.

DK40i: the KKYS feature key must be installed on the K5RCU PCB to allow AA.

DK424: the RKYS feature key must be installed on the RCTU to allow AA, ACD, and ACD/MIS.

Code 0, ROM Version

Code 0 displays the software version of the system common control unit (RCTUA, RCTUB, RCTUBA/RCTUBB and RCTUC/RCTUD, RCTUE/F, DK40i Base KSU, or DK14KSU) and if installed on the RCTU, the RKYS, KKYS, or QKYS key type. See the Program 00 Record Sheet for an illustration of software displays. This information cannot be altered with this program.

Code 1, Level 1 Security Code

Use to assign a Remote Maintenance security code that allows entry to all programs and data.

Code 2, Level 2 Security Code

Use this program to assign a Remote Maintenance security code that allows entry to Programs 30~39, 77~89, and *30~*31.

Important! *When using a DK Admin PC, either Security Code (1 or 2) enables the DK Admin user full access to all Strata DK programs. Always change Security Code 1 and Code 2 to prevent unauthorized programming changes by DK Admin users that may try to log-in remotely with the default security code: 0000.*

Code 8, Software RAM Checksum and Code 9, Power OFF Counter

For factory purposes only.

Program 00 Part 1 - Example

Action (press buttons + LED Buttons)	LCD Response
1. Use the programming LCD electronic or digital telephone. (See "First-time Programming" on Page 1-14.)	No. N-N ¹ Jan 20 Sun 06:43
2. ***#1*2*3 Enter programming mode. (Do not press [DN] button.)	Program Mode
3. Spkr (Speaker) 03 Hold Speaker beeps to indicate when to enter program number. Access Program 00.	Program = 00 Data Store
4. Spkr (Speaker) Prepare system for a selection.	00 Select =
5. Select one of the following attributes:	
0 View the software version. This attribute can not be edited. or...	00 Select = 0 RNAXNN-Key X Note NN = The actual version number and letter. See Program 00 record sheet for details). X = 1, 2, or 3.

Initialization & Test

Program 00 – Part 1: Software Check

Action (press buttons + LED Buttons)	LCD Response
<p>1NNNN</p> <p>Define the Level 1 remote maintenance security code from the System Record Sheet (four digits maximum). Level 1 allows remote access to all programs and data. Default Level 1 security code is "0000."</p> <p>or...</p>	<p>00 Select = 1</p> <p>Password = 0000</p>
<p>2NNNN</p> <p>Define the Level 2 remote maintenance security code from the System Record Sheet (four digits maximum). Level 2 allows remote access to programs 30~39 and 77~89 only. Default Level 2 security code is "0000."</p> <p>or...</p>	<p>00 Select = 2</p> <p>Password = 0000</p>
<p>8</p> <p>View the software RAM Checksum. This attribute can not be edited. The default checksum may change.</p> <p>or...</p>	<p>00 Select = 8</p> <p>Sum = XXXXXXXXX</p>
<p>9</p> <p>View the RPSU Power Cycle Counter. This attribute can not be edited. The counter indicates the number of times power is removed from the system after Program 00 was initialized via Program 90 or 91-9.</p>	<p>00 Select = 9</p> <p>Counter = XXXX</p>
<p>6. Hold</p> <p>Secure data in system programming. (Only works for "1" and "2")</p>	<p>00 Select = (0,1,2,8, or 9)</p> <p>Data Programmed</p>
<p>7. Spkr (Speaker)</p> <p>Prepare system for another selection (go back to Step 5) or exit Program 00 (continue with Step 8).</p>	<p>00 Select =</p>
<p>8. ##Hold</p> <p>Secure Program 00 data in system memory.</p>	<p>00 Select = ##</p> <p>Data Programmed</p>
<p>9. Spkr (Speaker)</p> <p>Exit Program 00. Enter another program number (see "Program 91-1 Example" on Page 2-7) or exit programming mode (go to Step 10). System beeps to indicate it is exiting Program 00.</p>	<p>Program =</p>
<p>10. ##Hold</p> <p>Exit programming mode.</p>	<p style="text-align: right;">No. N-N</p> <p>Jan 20 Sun 06:58</p>

1. N-N is the Program Telephone [DN].

Program 00 – Part 2: Processor RAM Test

Processor Type: DK14, DK40i, All RCTUs

Program Type: Test - Includes: Remote Maintenance Security Code Assignments

Initialized Default: None

General RAM Test

Note See “Program 00 Part 2 - Overview” on Page 2-16

##1*2*3 - Spkr 0 0 Hold - Spkr 5 1 01 03 Hold - Tests RAM (15 seconds downtime)

Programming Telephone LCD Displays: _____
GENERAL RAM TEST

Display General RAM Test Results

##1*2*3 - Spkr 0 0 Hold - Spkr 5 2 - Programming Telephone LCD Displays:

DK424

TEST 1 X=OK Y=OK

or...

**TEST 1 X=NG Y=NG
 X=00000 X=00000**

DK14/DK40i

TEST 1 =OK

or...

TEST 1 =NG

Where:

X = RCTUA, RCTUBA, RCTUC

Y = RCTUD3, RCTUF

OK = RAM is good

NG = RAM is defective

An **X=NG** or **Y=NG** RAM test result indicates a defective RCTU PCB; change the appropriate (X or Y) RCTU PCB and retest RAM on the newly installed RCTU.

Replace the DK14 KSU or DK40i Base KSU if **Test 1=NG**.

Backup RAM Test

##1*2*3 - Spkr 0 0 Hold - Spkr 6 1 - 02 04 - Hold - RCTU Tests RAM (15 seconds downtime)

Programming Telephone LCD Displays: _____
BACKUP RAM TEST

Display Backup RAM Test Results

##1*2*3 - Spkr 0 0 Hold - Spkr 6 2 - Programming Telephone LCD Displays:

DK424

TEST 2 X=OK Y=OK

or...

TEST 2 X=NG Y=NG
X=00000 X=00000

DK14/DK40i

TEST 1 =OK

or...

TEST 2 =NG

Where:

X = RCTUA, RCTUBA, RCTUC

Y = RCTUD3, RCTUF

OK = RAM is good

NG = RAM is defective

An X=NG or Y=NG RAM test result indicates a defective RCTU PCB; change the appropriate (X or Y) RCTU PCB and retest RAM on the newly installed RCTU.

Replace the DK14 or DK40i Base KSU if Test 1=NG.

Program 00 Part 2 - Overview

Use this program to test the RAM on system processor. If a RAM test error occurs during this test, the processor causing the error should be replaced. In the case of two-PCB processors, isolation of a RAM failure is indicated on the programming telephone X or Y (see above).

If the DK14 or DK40i processor fails the RAM test, the Base KSU must be replaced.

CAUTION! Running each RAM test drops all calls and interrupts telephone service for 15 seconds.

Note Running Program 00 RAM tests do not change or erase any customer data.

This chapter gives you programming information for the Strata DK system and its stations.

Program 01 – Station Logical Port Display and/or Change

Processor Type: DK14, DK40i, All RCTUs

Program Type: Station

Initialized Default: Logical port number = physical port number
Program 90, 91-1, or 91-9 initializes Program 01

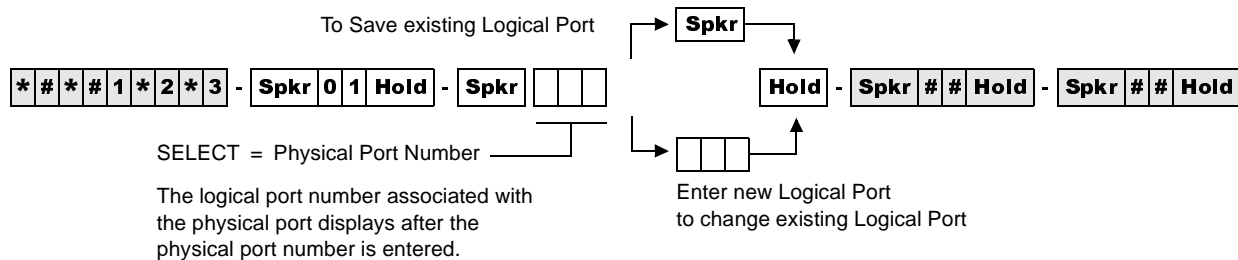

Processor	[PDN] Port Range
DK14	000-009
DK40i	000-027
RCTUA	000-031

Processor	[PDN] Port Range
RCTUBA/BB	000-079
RCTUC/D	000-239
RCTUE/F	000-335

Program 01 Overview

Program 01 enables you to enter a physical port to display the associated logical port. You then have the option to assign a new logical port to the physical port. (To return ports to their initialized settings, see Programs 90 and 91.)

Note Record port locations on Program 04 record sheet.

Program 02 – Station Physical Port Display and/or Change

Processor Type: DK14, DK40i, All RCTUs

Program Type: Station

Initialized Default: Logical port number = physical port number
 Program 90, 91-1, or 91-9 initializes Program 02

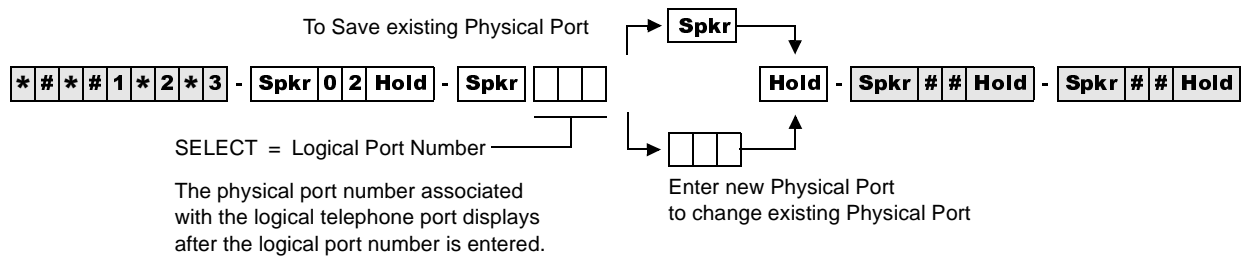

Processor	[PDN] Port Range
DK14	000-009
DK40i	000-027
RCTUA	000-031

Processor	[PDN] Port Range
RCTUBA/BB	000-079
RCTUC/D	000-239
RCTUE/F	000-335

Program 02 Overview

Program 02 enables you to enter a logical port to display the associated physical port. You then have the option to assign a new physical port to the logical port. (To return ports to their initialized settings, see Programs 90 and 91.)

Notes

- Record port locations on Program 04 record sheet.
- The system allows only like ports to be reassigned (see below).

Allowed	Not Allowed
Digital-to-Digital Ports (KCDU-QCDU-PDKU-PDKU-RDSU Ports)	Attendant Console (DK424 only), DSS, BGM or Amplified Conference Ports should not be reassigned
Electronic-to-Electronic Ports (PEKU-PEKU-PESU Ports)	Door Phone Ports (004, 012, 020, 028) should not be reassigned
Standard Tel to Standard Tel Ports (QSTU-KSTU-PSTU-RSTU-PESU-RDSU/RSTS)	Tie/DID Line Ports – should not be reassigned
	PDKU to PEKU – cannot be exchanged
	PSTU to PDKU – cannot be exchanged
	PEKU to PSTU – cannot be exchanged

- RCIU/RCIS circuit assignments to CO lines are not affected by Program 01 and 02.

Program 03 for DK14 – Slot Assignments

When DK14 is powered ON, Program 03 automatically assigns the correct codes for installed PCBs. No record sheet is needed. Refer to the following table for PCB slot and slot code information:

DK14 Base KSU

	WMAU	DKU	COU and QCDU2	QSTU2	None
Slot Number	00	11	12	13	14
PCB Code	91 or 92	62	11	00 or 31	00
PCB Type	QRCU3				
Options		OCA/DIU			
Station Numbers		000~007		008~009	
CO Line Numbers			001~004		

Notes

- In the DK14 software: QCDU2 digital ports are considered to be installed in slot 11. QCDU2 CO lines are considered to be installed in slot 12.
- opt=QRCU3
- opt=Always assigns 8 ports (000~007), digital ports (OCA/DIU). No DSS allowed.
- Always assigns 4 CO lines
- Always assigns 2 ports (008, 009) standard telephone ports

Program 03 for DK40i – Flexible PCB Slot Assignments

Processor Type: DK40i

Program Type: System

Initialized Default: PCB codes of PCBs installed prior to running Program 91-1 or Program 91-9
Code 00 for empty slots (15–18), Base KSU has codes for PCBs

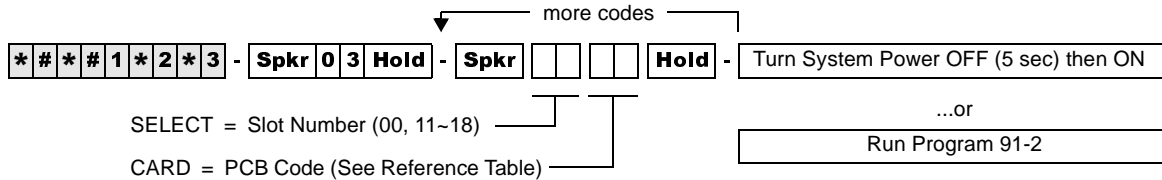

DK40i Base KSU

	TMAU2	DKU	TBSU, TCOU, or TDDU	KSTU2	TCIU2
Slot Number	00	11	12	13	14
PCB Code	91, 92 or 98	62 or 64	00, 11, 16, or 77	00 or 31	00 or 81
PCB Type					
Options					
Station/BRI Port Numbers					
CO/DID/BRI Line Numbers					

DK40i Expansion KSU

Cabinet Label	04	05	06	07
Slot Number	15	16	17	18
PCB Code				
PCB Type				
Options				
Station/BRI Port Numbers				
CO/Tie/DID/BRI Line Numbers				

Notes

- For systems containing ISDN PCBs, immediately after running Program 03, make sure to run Program *60 to identify all station (NT) and CO (TE) BRI circuits for each RBSU/RBSS and TBSU installed. Program *60 causes station port and CO line shifting on PCBs installed in higher slots that follow the BRI PCBs.
- Consult DK40i configuration section to check that the DK40i is configured properly.

PCB Code Reference Table

PCB Fixed Slot	Code	Ports/Type
Common Control	91	None
Common Control w/K4RCU3	92	4 DTMF/ABR
Common Control w/K5RCU or K5RCU2	98	5 DTMF/ABR
PIOU/PIOUS/RSSU/PEPU	41	None
PEKU	21	8 EKT
PEKU with EOCU	22	8 EKT
PEKU with DSS	23	8 EKT
PEKU with EOCU, DSS	24	8 EKT
PESU	25	2 SLT/4 EKT
PESU with EOCU	26	
KSTU2/RSTU2/Stratagy DK	31	4 SLT/8 SLT/8VM
TCOU/PCOU/RCOU/RGLU2	11	4/CO
RCOU + RCOS	17	8 Loop CO
Base Unit DKT CKTs, PDKU, and RWIU	61	8 DKT
Base Unit DKT CKTs & PDKU w/ DIU or SP-OCA	62	8 DKT
Base Unit DKT CKTs and PDKU with DSS (w/ or w/o DIU or SP-OCA)	64	8 DKT
KCDU	65	2/CO, 4 DKT
KCDU SP-OCA or DIU	66	2/CO, 4 DKT
RDSU (RSTS)	27	4 DKT/4 SLT
RDSU (RSTS) with DIU or SP-OCA	28	4 DKT/4 SLT
RDDU/TDDU	16	4 DID Lines
REMU	13	4-Tie Lines
RCIU2/RCIS/TCIU2	81	4 or 8 Caller ID
TBSU or RBSU	77	2 BRI S/T
RBSU/RBSS	78	4 BRI S/T
TSIU		No Code Required
None	00	None

Program 03 for DK40i - Overview

Program 03 tells the system what type of optional PCBs are installed in the Expansion KSU. You must run Program 03 after installing PCBs with options such as OCA, DIU, etc. Also, run Program 03 for each PCB slot when installing a PCB in that location.

It is not necessary to run Program 03 for slots 00~14. The DK40i automatically assigns the Base KSU PCBs if they are installed when system power is turned ON. However, if DSS is required on the Base KSU's DKT circuit 8, you must run Program 03 to assign code 64 to slot 11. If universal PCBs are installed, Program 91-1 and 91-9 automatically assign the appropriate PCB codes to the installed slots. But, Programs 91-1 or 91-9 do not assign option codes (such as OCA, DIU, etc.).

Codes allowed in DK40i Expansion KSU: 11, 13, 16, 21~28, 31, 41, 61~62, 64~66, 77, 78, 91, 92, and 81.

CAUTION! Running Program 91-9 erases Program 03 option codes; Program 91-1 does not.

Important! After completing Program 03 set the configuration in memory by running OFF and wait five seconds before turning it back ON.

The Program 03 record sheet is the main record for the hardware configuration of the entire system. It provides space to record station ports assigned to the station, Tie, and DID line PCBs and line numbers assigned to the ground loop start, CO, Tie, and DID line PCBs. Use the PCB Code Reference Table on the Program 03 record sheet to determine the proper option code for each PCB with an option.

The DK40i Base KSU is divided into four fixed slots, even though the unit has no slots per se.

- ♦ Slot 00 represents the system's common control (TMAU2) and optional K4RCU3, K5RCU, or K5RCU2
- ♦ Slot 11 contains the KSU's eight digital circuits/ports (DKU)
- ♦ Slot 12 contains the KSU's four optional CO or DID line circuits (TCOU or TDDU) or two BRI (TBSU) circuits
- ♦ Slot 13 contains the four optional standard telephone circuits KSTU2
- ♦ Slot 14 contains four optional Caller ID circuits for TCOU (TCIU2)

DK40i Slots 15~18 (Expansion KSU Assignment Criteria)

- ♦ Allowed PCBs: PDKU, RDSU/RSTS, RSTU, RSTU2, PSTU, PEKU, PESU, KCDU, RCOU/RCOS, RGLU2, RCIU2/RCIS, RWIU, PCOU, RDDU, REMU, PEMU, PIOUS, PIOUS, RSSU, PEPU, Stratagy DK.

Note Some PCBs cannot be installed in slot 18 (see Chapter 2 – DK40i Configuration).

- ♦ Expansion KSU PCBs must be installed in the slots specified in Tables 2-9~2-15 or the system may not operate properly. (See tables in Chapter 2 – DK40i Configuration of the *Strata DK Installation and Maintenance Manual*.)
- ♦ Slots 15 and 16 support Speaker OCA and RPCI/DIU Data Switching; slots 17 and 18 do not. All slots support Handset OCA and RPCI-DI TAPI operation.
- ♦ On DK40i, RCIU2 must be installed in slot 17; RCIU1 cannot be used.
- ♦ The RWIU must be installed in slot 15 and slot 16 must be vacant to support 9 to 16 wireless handsets. It can be installed in any expansion slot to support 1~8 wireless handsets.
- ♦ If the RWIU supports 9 to 16 handsets, program code 61 in slot 15 and 16.

Program 03 for DK424 – Flexible PCB Cabinet Slot Assignments

Processor Type: All RCTUs

Program Type: System

Initialized Default: PCB codes of PCBs installed prior to running Programs 91-1 or 91-9;
Code 00 for empty slots

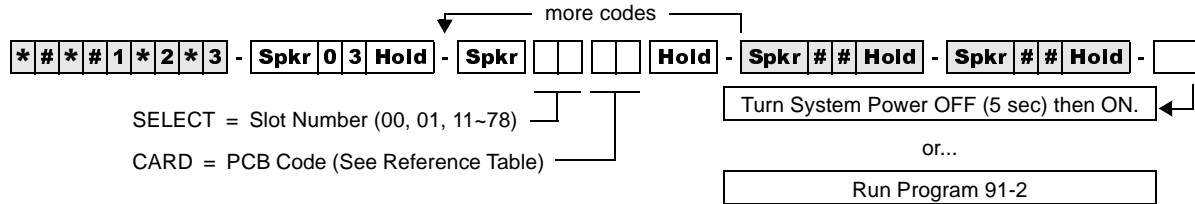

DK424 Base Cabinet 1

Slot Number	00 (R11)	01 (RCTU)	S11	S12	S13	S14	S15	S16
PCB Code								
PCB Type								
Options								
Station/Tie/DID/ISDN Port Numbers								
CO/Tie/DID/ISDN Line Numbers								

DK424 Expansion Cabinet 2

Slot Number	S21	S22	S23	S24	S25	S26	S27	S28
PCB Code								
PCB Type								
Options								
Station/Tie/DID/ISDN Port Numbers								
CO/Tie/DID/ISDN Line Numbers								

DK424 Expansion Cabinet 3

Slot Number	S31	S32	S33	S34	S35	S36	S37	S38
PCB Code								
PCB Type								
Options								
Station/Tie/DID/ISDN Port Numbers								
CO/Tie/DID/ISDN Line Numbers								

DK424 Expansion Cabinet 4

Slot Number	S41	S42	S43	S44	S45	S46	S47	S48
PCB Code								
PCB Type								
Options								
Station/Tie/DID/ISDN Port Numbers								
CO/Tie/DID/ISDN Line Numbers								

DK424 Expansion Cabinet 5

Slot Number	S51	S52	S53	S54	S55	S56	S57	S58
PCB Code								
PCB Type								
Options								
Station/Tie/DID/ISDN Port Numbers								
CO/Tie/DID/ISDN Line Numbers								

DK424 Expansion Cabinet 6

Slot Number	S61	S62	S63	S64	S65	S66	S67	S68
PCB Code								
PCB Type								
Options								
Station/Tie/DID/ISDN Port Numbers								
CO/Tie/DID/ISDN Line Numbers								

DK424 Expansion Cabinet 7

Slot Number	S71	S72	S73	S74	S75	S76	S77	S78
PCB Code								
PCB Type								
Options								
Station/Tie/DID/ISDN Port Numbers								
CO/Tie/DID/ISDN Line Numbers								

DK424 PCB Codes

PCB	Code	Ports/Type
RCOU, RGLU2	11	4 Gnd./Loop Lines
RCOU/RCOS	17	8 Loop CO Lines
RDDU	16	4 DID Lines/4 Stations
REMU	13	4 Tie Lines/4 Stations
PEKU	21	8 Stations
PEKU (EOCU)	22	8 Stations
PEKU w/DSS	23	8 Stations
PEKU (DSS, EOCU)	24	8 Stations
PESU	25	6 Stations
PESU (OCA)	26	6 Stations
RDSU/RSTS	27	8 Stations
RDSU/RSTS (OCA, DIU)	28	8 Stations
RSTU2	31	8 Stations
PIOU, PIOUS/ RSSU, PEPU	41	Remote Maintenance (TTY)
PIOU/PIOUS/RSSU	42	MIS for ACD (TTY)
PIOU/PIOUS/RSSU	43	SMDI VM Interface (TTY)
PDKU2, RWIU	61	8 Stations
PDKU2 (OCA, DIU)	62	8 Stations
PDKU2 (DSS, OCA, DIU)	64	8 Stations

PCB	Code	Ports/Type
RDTU	71	8 T1 Channels
RDTU	72	16 T1 Channels
RDTU	73	24 T1-channels
RCTU	91	None
RCTU (with 4-CKT RRCS)	92	None
RCTU (with 8-CKT RRCS)	93	None
RCTU (with 12-CKT RRCS)	94	None
NONE	00	00
RATU	51	4 Stations
RSIU	49	I/O Interface
RCIU2/RCIS	81	8 CKT, Caller ID
Stratagy DK	31	8 VM Ports
RBUU without RBUS	75	2 U Interfaces (4 stations/4 CO lines)
RBUU with RBUS	76	4 U Interfaces (8 stations/8 CO lines)
RBSU without RBSS	77	2 S/T Interfaces (4 stations/4 CO lines)
RBSU with RBSS	78	4 S/T Interfaces (8 stations/4 CO lines)
RPTU Interface Card	79	PRI Interface (24 CO lines)

See the following text for specific installation rules on the above PCBs.

Program 03 for DK424 - Overview

Program 03 tells the system what type of optional PCBs are installed.

The Program 03 record sheet is the main record for the hardware configuration of the entire system. It provides space to record station ports assigned to the station, Tie, and DID line PCBs and line numbers assigned to the ground loop start, CO, Tie, and DID line PCBs.

Use the DK424 PCB Code table on Page 3-7 to determine the proper option code for PCBs with options. You must run Program 03 after installing PCBs with options such as OCA, RRCS, DIU, etc. Also, run Program 03 for the slot of each new PCB when installing a new PCB in an existing installation.

If universal PCBs are installed, Program 91-1 and 91-9 automatically assigns the appropriate PCB codes to the installed slots. But, they do not assign option codes (such as OCA, PDIU, RRCS, etc.).

CAUTION! Running Program 91-9 erases Program 03 option codes; Program 91-1 does not.

Important! After completing Program 03 set the configuration in memory by running Program 91-2 or turn the base cabinet power supply switch off and wait five seconds before turning it back on.

Expansion slots 7 and 8 can only be used if the following equipment is installed: DK424 Base (with RCTUE/F and MBJU removed) and the DK424 Expansion.

See Chapter 4 – DK424 Configuration (Strata DK Installation and Maintenance Manual) to determine PCB slot placement.

PIOU/PIOUS/RSSU

Codes 41, 42, and 43 assigns PIOU/PIOUS RSSU TTY port as Remote Maintenance, MIS for ACD, and SMDI respectively; SMDR, Paging, Relay Control, and other miscellaneous options are active on the PIOU/PIOUS that has the lowest number code (41, 42 or 43) in the system. Codes set for RSIU/RSIS/RMDS in Program 76 have priority over codes 41, 42, and 43.

Piggyback PCB / Speaker OCA / Data Interface Unit Options

Run Program 03 to assign codes for all options except RCOS. Program 91-9 erases option codes assigned with Program 03; Program 91-1 does not erase option codes already programmed. After completing all Program 03 data entry, run Program 91-2 or cycle system power to transfer Program 03 data into working memory.

RCIU/RCIS or RCIU2/RCIS

When installing RCIU2/RCIS, enter the Caller ID circuit numbers on the record sheet in place of the CO line number. Each RCIU2/RCIS slot uses eight Caller ID circuits. RCIU2/RCIS circuit numbers are assigned automatically in numerical order (001~200) starting with the lowest slot number, to the highest RCIU2/RCIS slot number in 8-circuit increments.

Important! *If more than four circuits are needed, never install an RCIU without an RCIS.*

On DK424, RCIU2/RCIS can be installed in any universal slot except slot 11 or if RSIU is installed, slot 12; they do not have to be installed adjacent to corresponding CO lines. Refer to Program *50 to manually assign RCIU2/RCIS circuits to CO line circuits.

RWIU

Code 61 must be set for all RWIU slots including slots that are vacant because they support RWIU channels 09~32.

RCTU

The table below gives you slot locations and PCB Code Assignments for all RCTUs.

Processor	R11 Slot	RCTU Slot Cabinet 1	Slot Code	PCB Code Assignment
RCTUA	No	Yes	00	91~94
RCTUB	No	Yes	00	91~94
RCTUBA	Yes	No	00	91~94
RCTUBB	No	Yes	01	91
RCTUC	Yes	No	00	91~94
RCTUD	No	Yes	01	91~94
RCTUE	Yes	No	00	91~94
RCTUF	No	Yes	01	91~94

PCB Codes:

91=No RRCS

92=4 -circuit RRCS

93=8 -circuit RRCS

94=12 -circuit RRCS

Note When using RCTUA, Slot 15 and 16 does not support Speaker OCA or DIU Data Switching. RCTUA does not support ACD, ACD/MIS, RS-232 Voice Mail Integration (SMDI), and attendant console features.

RSIU

If an RSIU is installed in base cabinet slot 11, you must connect the programming station to circuit 6 in slot 12. In this case, a PDKU or PEKU should be installed in slot 12 and Station Port Number 000~007 will be in slot 12.

If an RSIU is not installed, you must connect the programming station to circuit 6 in slot 11 (Port 005) and/or circuit 6 in slot 12 (port 013). The station must be a 20-button digital LCD or electronic LCD telephone. Also, if an RSIU is not installed, install a PDKU or PEKU in slot 11.

Program 03 Example

Action (press buttons + LED buttons)	LCD Response
1. Use an LCD programming phone per Minimum Hardware Requirements on Page 1-14.	No. 205 Jan 20 Sun 06:43
2. ***#1*2*3 Enter programming mode. (Do not press [DN] button.)	Program Mode
3. Spkr (Speaker) 03 Hold Access Program 03. System beeps after Spkr (Speaker) is pressed to indicate program number may be entered.	Program = 03 Data Store
4. Spkr (Speaker) Prepare the system for a selection.	03 Select =
5. Dial a PCB slot number (00~78 for DK424 or 00-18 for DK40i) using the dial pad.	03 Select = (00~78) Card = (91, 62 or 00)
The system defaults as follows: 00 Initialized default assigns slot 00 and 01 to be a non-optioned RCTU without RRCS DTMF receivers, or DK40i Base without K4RCU3, K5RCU, and K5RCU2.	03 Select = 00 (Slot Number) Card = 91
11 Initialized default assigns slot 11 to be a non-optioned PDKU without DSS console or OCA (Code 61).	03 Select = 11 (Slot Number) Card = 61
00, 01, 12~78 (DK424), 00~18 (DK40i) Initialized default assigns slot 12~78 to be empty (Code 00).	03 Select = 12~78 (Slot Number) Card = 00
6. 00~99 Dial the PCB code recorded on the record sheet. Refer to the PCB code reference table on Program 03 record sheet for a definition of the codes.	03 Select = (00~78) Card = (00~97)
7. Hold Secure data in system programming.	03 Select = (00~78) Data Programmed
8. Spkr (Speaker) Prepare system for another selection (go back to Step 5) or continue with Step 9.	03 Select =
9. ##Hold Secure Program 92 data in system memory.	92 Select = ## Data Programmed
10. Spkr (Speaker) Exit Program 92 (system beeps). Enter another program number or exit programming mode (go to Step 11).	Program =
11. ##Hold Exit programming mode.	No. 205 Jan 20 Sun 06:58
12. To secure Program 03 entries, Power off for five seconds, then power on, or run Program 91-2.	

Program *03 for DK424 – Cabinet Type Identification

Processor Type: RCTUE/F only

Program Type: System

Initialized Default: All cabinets = 1

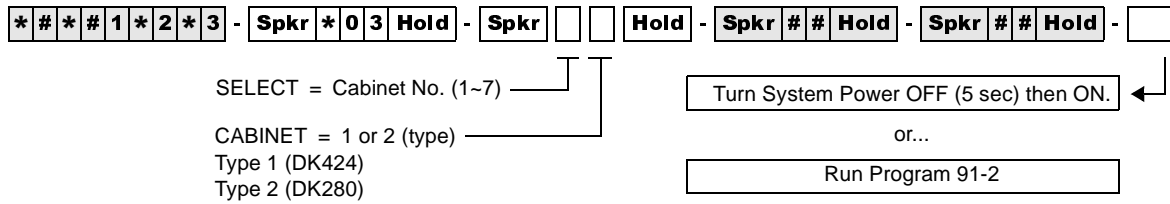

SELECT = (Cabinet No. 1~7)	Cabinet Type (1 or 2)
1 (Base)	
2 (1st Expansion)	
3 (2nd Expansion)	
4 (3rd Expansion)	
5 (4th Expansion)	
6 (5th Expansion)	
7 (6th Expansion)	1 only

Expansion Cabinet Universal PCB Slot Availability

Case 1

RCTUE/F in DK424 Base Cabinet with MBJU removed

Expansion Cabinet (max 6)	Universal PCB Slots
DK424	1~8 available
DK280	1~6 available

Case 2

RCTUE/F in DK280 Base Cabinet

Expansion Cabinet (max 5)	Universal PCB Slots
DK424	1~6 available
DK280	1~6 available

Program *03 - Overview

You must run this program when using the RCTUE/F processor. It identifies which type of cabinets are installed (DK424 or DK280). The RCTUE/F processor can be installed in a DK424 or DK280 base cabinet. The expansion cabinets can be any combination of DK424 and DK280 - except the seventh expansion cabinet must be a DK424.

The DK280 expansion cabinet can only support six universal PCB slots in any possible configuration.

The DK424 expansion cabinet supports eight universal PCB slots only if the RCTUE/F is installed in a DK424 base cabinet and the MBJU jumper is removed from the DK424 base cabinet backplane.

Expansion Slot Configuration Record¹: Slot 15 _____ Slot 16 _____ Slot 17 _____ Slot 18 _____

Physical Ports	Modular Jack Location Record	Logical Ports	[PDNs] (Initialized)	Port Type for Different Base Configurations				
				TCOU or TDDU	TCOU, TBSU ² or TDDU+KSTU2	TBSU	TBSU+KSTU2	
000		000	(10)	Base Slot 11 8 - Digital Telephone Ports	Base Slot 11 8 - Digital Telephone Ports	Base Slot 11 8 - Digital Telephone Ports	Base Slot 11 8 - Digital Telephone Ports	
001		001	(11)					
002		002	(12)					
003		003	(13)					
004		004	(14)					
005		005	(15)					
006		006	(16)					
007		007	(17)					
008		008	(18)	Expansion Slots 15~18	Base Slot 13 4 KSTU2 Ports	Base Slot 12 ³ TBSU CKT 1 2 Ports	Base Slot 12 ³ TBSU CKT 1 2 Ports	
009		009	(19)			Base Slot 12 ³ TBSU CKT 2 2 Ports	Base Slot 12 ³ TBSU CKT 2 2 Ports	
010		010	(20)		Expansion Slots 15~18	Expansion Slots 15~18	Expansion Slots 15~18	Expansion Slots 15~18
011		011	(21)					
012		012	(22)					
013		013	(23)					
014		014	(24)					
015		015	(25)					
016		016	(26)					
017		017	(27)					
018		018	(28)					
019		019	(29)					
020		020	(30)					
021		021	(31)					
022		022	(32)					
023		023	(33)					
024		024	(34)					
025		025	(35)					
026		026	(36)					
027		027	(37)					

1. Expansion slots 15~18: See DK40i Configuration tables in Chapter 2 of the *Strata DK Installation and Maintenance Manual*.
2. TBSU circuits configured for line-side BRI.
3. If TBSU circuits that are set as station-side in Program *60, use two station ports per circuit. TBSU circuits that are set to line-side do not use station ports.



System & Station

Program 04 – Station Logical Port [PDN] Assignment

DK424 Record Sheet

* # * # 1 * 2 * 3 - Spkr 0 4 Hold - Spkr [] [] # [] [] [] Hold - Spkr # # Hold - Spkr # # Hold

SELECT = Station Logical Port Number(s) _____ Press [PDN] or Button LED 01 to erase (1~4 digits)

Processor	[PDN] Port Range	Initialized [PDNs]	DISA Port	Reserved for Special Functions
RCTUA	000-031	200-231	039	032-039
RCTUBA/BB	000-079	200-279	089	080-089
RCTUC/D	000-239	200-239	249	240-249
RCTUE/F	000-335	100-435	344	336-349

Physical Ports	Modular Jack Location Record	Logical Ports	[PDN]	Cabinet and Slot Number	Physical Ports	Modular Jack Location Record	Logical Ports	[PDN]	Cabinet and Slot Number	
				Cabinet: _____ Slot: _____					Cabinet: _____ Slot: _____	
				Cabinet: _____ Slot: _____					Cabinet: _____ Slot: _____	
				Cabinet: _____ Slot: _____					Cabinet: _____ Slot: _____	
				Cabinet: _____ Slot: _____					Cabinet: _____ Slot: _____	

Program 04 Overview

Program 04 assigns the Primary Directory Number [PDN] to each telephone (logical port). [PDNs] can be one to four digits. [PDNs] must not conflict with Phantom Directory Numbers [PhDNs] or, DK424 Distributed Hunt Directory Numbers set in Program *04.

[PDNs] can be changed using Program 04, but door phone and modem numbering cannot.

- Door phone standard numbering is #151~#159 and #161~#163; the internal modem (IMDU or RMDS) is #19 (DK40i and DK424).
- [PDNs] cannot begin with the digits 41~49 because 44 is the substitute code to rotary dial the “#” in feature access codes.

Only the first digit of a feature code can be changed with Program 05. The system automatically assigns door phone station numbers if a door phone is specified in Program 77-1. [PDN] assignments are flexible so that each station can have up to four assigned digits.

All Strata DK telephone user guides are written using the standard default access codes and [PDNs]. If desired, a telephone accompanying a DSS console can have an [PDN] of 0 or 01, etc., without conflict.

If you make no assignment in Program 04, the system, upon powering up automatically assigns eight [PDNs] for each station PCB installed and four logical station ports for each PEMU, REMU, RDDU, and RATU PCB.

Each DK424 RDTU, Tie, and DID channel is also assigned a station port. This is done in sequence of ascending slot numbers for station port numbers 008 and up.

DK424 Attendant consoles rings on the ICI “0” button for Dial “0” calls, and on the [PDN] when the [PDN] assigned to the console (station) port in this program is dialed.

Peripheral Devices other than telephones or DIUs can be connected to the ports listed below. If a peripheral device is connected to a Physical Port, the Logical Port must have the same port number as the Physical Port. See the following table.

Logical & Physical Ports	System	Peripheral Device
00	DK40i	Digital telephone associated with DSS console.
02, 03	DK14	Digital Door phone/lock control unit (DDCB).
04, 12, 20	DK40i	Digital Door phone/lock control unit (DDCB).
07, 015, 027	DK40i	Digital Direct Station Selection Console (DDSS).
10	DK14	DISA port number used for Toll Restriction Class and Verified/Forced Account Code assignment.
35	DK40i	
09	DK40i	Separate background Music Source (KSTU2 required in Base KSU).
00, 08, 020	DK40i	Digital telephone associated with DSS console (PDKU/Expansion Unit required).
		Electronic telephone associated with DSS console (PEKU/Expansion Unit required).
00, 13, 17	DK40i	DK40i: Separate Background Music Source (PEKU, PESU, or PSTU/Expansion Unit required). DK14: QSTU2 required.
09	DK14	
31	DK40i	IMDU modem.

Program 04 Example

Action (press buttons+LED buttons)	LCD Response
1. Use an LCD programming phone per Minimum Hardware Requirements in Chapter 1 - Overview.	No. N-N ¹ Jan 20 Sun 06:43
2. ***#1*2*3 Enter programming mode. (Do not press the [DN] button.)	Program Mode
3. Spkr (Speaker) 04 Hold Access Program 04. The speaker beeps to indicate when to enter a program number.	Program = 04 Data Store
4. Spkr (Speaker) Prepare the system for a selection.	04 Select =
5. 000#~335# Select a port number (use three digits plus #).	04 Select = 000 INT = N-N
6. XXXX Enter the port's station number (up to four digits) from the record sheet. Note Station numbers must not exceed four digits, or conflict with feature access codes listed in Program 05 record sheet.	04 Select = 000 ~239 INT = XXXX
7. Hold Secure data in system programming.	04 Select = (000~335) Data Programmed
8. Spkr (Speaker) Prepare the system for another selection (go back to Step 5) or continue with Step 9.	04 Select =
9. ##Hold Secure Program 04 data in system memory.	00 Select = ## Data Programmed
10. Spkr (Speaker) Exit Program 04 (system beeps). Enter another program number or continue with Step 11.	Program =
11. ##Hold Exit programming mode.	No. N-N Jan 20 Sun 06:58

1. N-N = program telephone [PDN]

Program *04 Overview

Program *04 assigns the system Phantom Directory Numbers [PhDNs] and Distributed Hunt (DH) Group [DNs].

All DK systems provide 16 DH groups. [PhDNs] and DH [DNs] can be one to four digits.

[PhDNs] and DH [DNs] cannot conflict with each other, or be the same as Primary Directory Numbers assigned in Program 04. [PhDNs] can not conflict with, or be the same as Distributed Hunt Directory Numbers assigned in this program. Default [PhDNs] and DH [DNs] are shown in the legend above the record sheet.

Note

- [PhDNs] and DH [DNs] cannot have 41~49 as the first two digits because 44 is the substitute code to rotary dial the “#” in feature access codes.
- See Program *09 or 71 for DID line call routing to DH Groups; see Programs 81~89 or Ground/Loop start CO line call routing to DH Groups.

Program 05 – Flexible Access Code Numbering

Processor Type: DK14, DK40i, All RCTUs

Program Type: System

Initialized Default: See record sheet

* # * # 1 * 2 * 3 - Spkr 0 5 Hold - Spkr [] [] Hold - Spkr # # Hold - Spkr # # Hold

SELECT = Access Code (1-9)
See the table below for standard access codes.

SPECIAL DIAL = New Access Codes

The first digit of access codes can be replaced by 2 digits.

Press LED Button 01 to enter blanks.

Default Access Code	Features Affected (N/A = Not Affected/ Cannot Change)	New Access Codes
0	Unused	
1	Voice First/Tone First (Dial 1-N/A) Door Phones: (#151~#159; #161~#163) IMDU or RMDS Access: DK424 and DK40i (#19) Default [PDNs] and Park Orbits (see Program 04)	Station LCD Messages (10~19-N/A) Station Speed Dial (100~139-N/A) RCTUE/F Station Speed Dial Set (10~49-N/A) RCTUA, BA/BB, C/D
2	Default [PDNs] and Park Orbits (see Program 04) Busy Override (Dial 2-N/A) Do Not Disturb Override (Dial 2-N/A)	ACD Ports (*04, *09, 71) Off-hook Call Announce (2-N/A) RCTUE/F System Speed Dial (200~999)
3	Default [PDNs] and Park Orbits (see Program 04) Executive Override (Dial 3-N/A) All Call Voice Page (#30) All Call Voice Page with External Spkrs (#39) RCTUE/F Ext Page Zones #351~#358	RCTUA~C/D External Page Zones 1~4 (#35~#38) Group Page (Internal) (#311~#318) Park + Page (Cnf+#331) Park Pick Up [DN]+#331 (see Program *05) Park + Hold (Cnf+#332)

System & Station

System & Station

Program 05 – Flexible Access Code Numbering

Default Access Code	Features Affected (N/A = Not Affected/ Cannot Change)		New Access Codes
4	Default [PDNs] and Park Orbits (see Program 04) Default [PhDNs] (see Program *04) Automatic Callback (Dial 4-N/A) CO Line Queuing (Dial 4-N/A) Station Number Display (#401) Port Number Display (#402) Hold (#41) Hold Pickup (#42) Automatic Busy Redial (Conf + #44) Automatic Busy Redial Cancel (Int + #44) Message Waiting Answer (#408) from INT, [PDN], or [PhDN] Display [PDN], [SDN], or [PhDN] on LCD (#407) Emergency Call to Attendant Console (#400) Standard telephone Redial (44) or dial # for feature access code Flash (Cnf + #45) Account Code Input (Cnf + #46)	T.R. Override/T. Class Code Input (Cnf + #47) BGM Over Stations ON (#481) BGM Over Stations OFF (#480) BGM Over External Speakers ON (#491)(Station Port 000 only) BGM Over External Speakers OFF (#490)(Station Port 000 only) Cancel Message Waiting at Station (#409) from [PDN] or [PhDN] Retrieve Message Waiting (#408) Access Code/Speed Dial Prefix (44 or #) To store a CO line or feature access code in Speed Dial memory from rotary phones or phones without the Speed Dial and Redial buttons, enter 44 + 7XXX instead of # + 7XXX. Start Trace #489 (Station Port 000 only) Stop Trace #488 (Station Port 000 only) Cancel Auto Call Back (#43)	
5	Call Pickup Station (#5+Station No.), Ringing CO or DID line (#59) Directed Pickup of CO Line on Hold (#5+#7 XXX, XXX = 001~200), Pick-up External Page (#5 + #30 or for Zone Page #5+#35~#38) #5#79 Pick up Tandem Connection (Release 3.2 and above)	Selected Group Pickup (#5+#320~#339) Own Group(s) Pickup (#5+#34) Pickup Ringing Line (#59) [DN] Pickup #5#2+XXX (XXX=[PDN] or [PhDN], DK Release 3.1 and above) Verified Account Codes (DK14, DK40i, RCTUA~C/D: Speed Dial + 50; RCTUE/F Speed Dial + 050)	

Default Access Code	Features Affected (N/A = Not Affected/ Cannot Change)	New Access Codes
6	Call Forward (#601, #602, #603, #604)	T.R. Override Code Change (#654, #655)
	Timed Reminder (#605~#609)	System Speed Dial
	M/W for Voice Mail ON (#63+Station No.)	(N/A 600~699 RCTUB, RCTUBA/BB, & RCTUC/D)
	M/W for Voice Mail OFF (#64+Station No.)	
	Voice Mail ID Code Set (Call Fwd, #656)	System Speed Dial Set (N/A 60~99 - DK14, DK40i and RCTUA)
	Voice Mail ID Code Set (Ans. MW, #657)	LCD User Name (#621-Set, #620-Reset, TR dial plan Set #650 +6267 +7/8/9 Change
	LCD Message Set (#68)	DISA Security Code Change (#658)
	DKT Mute Ring Adjust (#6101)	Verified Account Code Change (#659)
	DKT Ring Level Adjust (#6102)	Set LCD Messages (#68)
	Port Swap/Station Relocation OFF (#6281)	System LCD Messages (N/A 60-99)
	Station Relocation ON (#6282)	Traveling Class Code 1~8 Change (#691~#698)
	Logical Port Swap ON (#6283)	Logical Port Swap (#627 + Destination Intercom No.)
	Call Forward Ext Set or Remote Change Code (#670)	Physical Port Calling (#629 + Physical Port No.)
	Date Set (#651)	Message Waiting Set/Cancel (N/A) (7) (77)
Time Set (#652)	Night Lock Password Change (#622)	
Weekday Set (#653)		
7	CO Line Outgoing Calls (#7001~#7200) To store a CO line or feature access code in Speed Dial memory from rotary telephones or telephones without the Speed Dial and Redial buttons, enter 44 + 7XXX instead of # + 7XXX.	
8	CO Group Outgoing Calls (801~816) Default Distributed Hunt [DNs] (850~ 865) See Program *04	
9	Least Cost Routing or CO Group (9), Distributed Hunt Group Prog *04 Port Ref. (900~915)	

Program 05 Overview

Program 05 enables you to change feature access codes. The first digit of a feature access code can be changed to a different digit or to two digits. Digits after this prefix cannot be changed. Some access codes cannot be changed (such as the code for Automatic Callback) and are shown with N/A on the record sheet.

Notes

- Access code conflicts may exist if new access codes are assigned, and a new system numbering plan will have to be implemented.
- Be sure access code changes do not conflict with existing access code or station numbering schemes. Refer to Program 04 – Port/Station Number Assignment.
- If access codes are being changed to a number that is currently assigned, change the currently assigned code to an unused code first. In the initialized state, the only unused code is zero (0).

Program *05 – Call Park Pickup Abbreviated Dialing

Processor Type: DK14, DK40i, All RCTUs

Program Type: System

Initialized Default: Blank

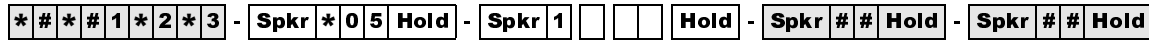

SELECT = 1 ————— DATA = 1 or 2 digit abbreviated dialing for Call Park Pickup.

SELECT = Call Park type:
 1 = Change #331 Call Park Pickup Code
 2 = Change #332 Call Park Pickup Code

It is only necessary to change one code, but each code can be changed to the same or

Program *05 Overview

This program assigns two Call Park Pickup abbreviated dialing codes to pick up parked calls. For dialing convenience, the 1- (or 2-) digit abbreviation for Call Park Pickup replaces the Call Park access codes #331 and #332. To park calls, Code #331 and #332 must still be used if the Program 39 **Park in Orbit** buttons are not available on a telephone. Changing the #331 and #332 codes only applies to Call Park Pickup.

- ♦ LED 01 blanks out the Call Park abbreviated dialing data.

Example:

If Park Pickup code #331 is changed to the digit “1”, Park Pickup functions by dialing 1XXX, where XXX is the orbit number in which the call is parked.

Program 09 – Built-in Auto Attendant Prompt / Station Assignments

Processor Type: DK14, DK40i, All RCTUs

Program Type: System and ACD

Initialized Default: Blank



SELECT = Prompt
Press prompt number offered to caller. First or second digit.

AUTO ATT DIAL = (1~4 digits)
Enter the station numbers, [PDNs], [PhDNs], DH [DNs], or #4 plus the ACD Group No. which will receive Auto Attendant calls. Could be * if establishing the first digit.

Press LED Button 01 to delete data.

Dialed Digit (Menu Prompts)	Station Number [PDN]	Department, Division, Etc.
0		
1		
2		
3		
4		
5		
6		
7		
8		
9		

Program 09 Overview

Program 09 tells the system where to direct calls after incoming Auto Attendant callers dial a digit(s) in response to the menu of dialing prompts offered by one of the Auto Attendant’s digital announcers.

The exact dialing prompts along with their associated station numbers, [PDNs], [PhDNs], Distributed Hunt [DN] and ACD group numbers are assigned with this program. The actual announcements that are delivered to callers are recorded on customer-supplied digital announcers. The dialing prompts can either be all one-digit or all two-digits (or numbers of 1~4 digits).

One digit dialing prompts can be used, but they cannot conflict with the first digit of the [PDN] in Program 04 or the [PhDN] and DH [DN] in Program *04.

Two-digit dialing prompts are only used when it is necessary to stop the announcement to prevent errors in digit translation or when single-digit prompts conflict with [PDN], [PhDN], and DH [DN] numbering plans. Digit Translation errors occur sometimes when line transmission is low or the announcement voice frequencies are the same as a DTMF digit and the system RRCS, K4RCU3, K5RCU, K5RCU2, or QSTU3 circuit will not dial or misdials.

The first digit of the two-digit prompts cannot conflict with [PDNs] in Program 04 or [PhDNs] and DH [DNs] in Program *04.

- **To create one-digit dialing prompts and to assign the associated destination station numbers**
 1. Enter Program 09.
 2. When “**SELECT**” appears on the LCD, press the desired digit (prompt). Then “**AUTO ATT DIAL**” appears on the LCD.
 3. Enter the destination DH or station [PDN] (not Port number) number or **#4** plus the ACD group (per Note) associated with the prompts and then the **Hold** button.
 4. Press **Spkr** and repeat Steps 2 and 3 for more prompt-station entries.

- **To enter two-digit dialing prompts along with their destination station numbers**
 1. Enter Program 09 and then see “**SELECT**” on the LCD.
 2. Press the desired leading digit then see “**AUTO ATT DIAL**” on the LCD.
 3. Press ***** and then the **Hold** button. The first digit will now be set, and “**DATA PROGRAMED**” will again appear on the LCD.
 4. Press **Spkr** and press a second digit, and then see “**AUTO ATT DIAL**” on the LCD.
 5. Enter the destination station [DN] assigned to the two-digit prompt and then the **Hold** button.
 6. To complete more prompt-station entries, repeat Steps 4 and 6.

- **To assign a digit (menu prompt) to an ACD Group**
 - Enter **#4XX** in place of the [DN]) at the “**AUTO ATT DIAL**” LCD programming prompt, where XX is the ACD Group number 01~16.

Note When transmission and DTMF levels are lower than normal or when the digital announcement voice frequencies match DTMF digital frequencies (talk-off), Auto Attendant efficiency may be improved with two-digit dialing options, instead of one-digit dialing options.

Program *09 – [PDN], [PhDN], DH, ACD or Modem DID Ext. Assignments

Processor Type: See legend below

Program Type: Station

Initialized Default: See legend below

* # * # 1 * 2 * 3 - Spkr * 0 9 Hold - Spkr [] [] [] # [] [] [] [] Hold - Spkr # # Hold - Spkr # # Hold

SELECT = Port No. (see legend) DIAL = DID Extension Number (1-4 digits)

To add a port range, enter XXX*XXX (low port * high port). (Do not press # after entering a port range.) Then enter the lowest DID Ext. number as the first Ext. number in the range.

Press LED Button 01 to erase extension numbers.

Processor	[PDN] Port Range	[PDN] Ext. #	[PhDN] Port Range	[PhDN] Ext. #	DH Group Ports	DH Ext. # Default	ACD Port #	ACD Ext. #	RMDS/IMDU Modem Port	Modem [PhDN] Ext. #
DK14	000-009	10-19	500-509	50-59	900-915	Blank	N/A	N/A	N/A	N/A
DK40i	000-027	10-37	500-527	50-77	900-915	Blank	N/A	N/A	031	41
RCTUA	000-031	200-231	500-531	500-531	900-915	Blank	N/A	N/A	035	235
RCTUBA/BB	000-079	200-279	500-579	500-579	900-915	Blank	090-097	290-297	085	285
RCTUC/D	000-239	200-439	500-739	500-739	900-915	Blank	250-265	450-465	245	445
RCTUE/F	000-335	100-435	500-835	450-785	900-915	Blank	345-360	850-865	340	840

[PDN], [PhDN], DH, ACD or Modem Port	[PDN], [PhDN], DH, ACD or Modem Port DID Ext. # (1-4 Digits)

[PDN], [PhDN], DH, ACD or Modem Port	[PDN], [PhDN], DH, ACD or Modem Port DID Ext. # (1-4 Digits)

[PDN], [PhDN], DH, ACD or Modem Port	[PDN], [PhDN], DH, ACD or Modem Port DID Ext. # (1-4 Digits)

Program *09 Overview

This program assigns the routing destinations for incoming DID line calls.

Program *09 DID extension numbers can be routed to [PDNs], [SDNs], or [PhDNs], ACD Groups, or Distributed Hunt groups. Each [PDN]/[SDN] and/or [PhDN] can appear and ring (immediate, 12 sec. delay or 24 sec. delay with Program *71, *72 and *73) on up to 120 telephones. A DID extension number can ring up to 120 telephones maximum.

Any DID line can be assigned to route with Program 71 and 72 DNIS routing assignments, instead of Program *09 assignments, to provide all the DNIS call routing features to normal DID lines.

Which program options (Program *09 or Program 71 and 72) DID line call routing will follow is determined for each DID line in Program 17, LED 05 and/or 07 (see Program 17 for more details).

On DK424, DID calls will alternately ring all or selected Attendant Consoles (in the load share group, assigned in Program 81-89) when a DID Attendant Console extension number is assigned to ring any one of the Attendant Console ports in the load share group.

Program 10-1 – System Assignments, Part 1 of 3

Processor Type: DK14, DK40i, All RCTUs

Program Type: System

Initialized Default: LEDs 07, 08, 09, 16, 18, 19 and 20 are ON

* # * # 1 * 2 * 3 - Spkr 1 0 Hold - Spkr 1 Hold - Spkr # # Hold - Spkr # # Hold

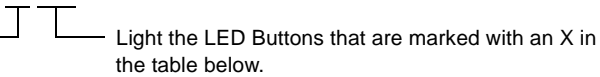
SELECT = 1  Light the LED Buttons that are marked with an X in the table below.

Button/ LED	X	LED ON	LED OFF
20		Two-CO Line Conference/Allowed	Not Allowed Two-CO line Conference must be allowed for Tandem Line, DISA, CF-EXT, and DNIS external routing operation. Also See Program 15, Code 5.
19		Conference/Allowed	Not Allowed
18		Ring Detect Time-Normal	Ring Detect Time-Short Rings
17		Station to Station Call Volume PAD (-8db)	No Station to Station Call PAD
16		BRI Standard Initialization (2 TEIs)	None (TEI = 0)
15-13		Not Used	Not Used
12		ABR Cycles/10 times	15 times
11		ABR Redial time/30 sec.	1 min.
10		System Speed Dial Override, Toll Restriction	Restricted
09		Exclusive Hold/Allowed	Not Allowed
08		Alternate Point Answer	Transfer Privacy
07		Ring Transfer of CO Line Allowed	Not Allowed If Ring Transfer is allowed, set Ring Transfer Recall time in Program 37; if ring transfer is not allowed (LED 07 OFF), the station recalls immediately if transfer is attempted.
06		CO Line Repeat Ringing	Standard Ring Standard ring pattern is 1 sec. on, 3 sec. off.
05		Incoming Call Abandon 8 sec.	6 sec.
04		CO Line DTMF Signal Time 160 msec.	80 msec. LED 04 DTMF Signal Time applies to manual and speed dial tones sent out of the system via CO lines. This applies when dialing from any Toshiba telephone, including the 2000-series Digital Telephone. LED 04 does not apply to Call Forward or Voice Mail ID DTMF tones sent to voice mail ports. (See Program 10-2, LED 06, for tones sent to Voice Mail ports.)
03		Dial Pulse Make Ratio 33%	40%
02		0.45 or 1.5 sec. per Program 42-0	CO Line Re-seize guard time 0.45 CO line guard time is the time interval the system requires to release a CO line and re-seize it. If LED 02 is off, all lines are set with 0.45 second guard time; if LED is on, guard time is 0.45 or 1.5 seconds per Program 42-0.
01		Tone First (from SLTs, DKTs and EKTs)	Voice First (from SLTs, DKTs and EKTs) This applies to [PDNs] not [PhDNs]; [PhDNs] are always tone first.

System & Station

Program 10-1 Overview

You can make the following system assignments with Program 10-1:

LED 20: Two-CO Line Conference

Two lines can be conferenced with one or two telephones (digital, electronic, or standard). Conference (see LED 19) in this program to enable this feature. Also, Two-line Conference must be allowed for DISA, CF-EXT, and DNIS external routing use of outgoing lines. CO lines must be enabled for tandem connection with Program 15, Code 5.

LED 19: Conference

Gives stations the ability to enable (LED 19 ON) or disable (LED 19 OFF) any Conference.

LED 18: Ring Detect Time

Sets normal ring detect time (LED 18 ON). Only use the normal setting, except unless connected to CO/Centrex lines that send ring signals less than 120 milliseconds.

LED 17: Station-to-Station Call Volume PAD

ON reduces station-to-station talk path volume (-8 dB). LED 17 should be OFF in all cases except where extreme quiet room noise is expected.

LED 16: BRI Standard or Non-initializing Terminal

Determines the initialization process for BRI lines connected to the ISDN network. A normal sequence is followed if this is turned ON. If it is OFF, no initialization sequence is needed.

LED 12: Automatic Busy Redial (ABR) Cycles

If activated from an electronic or digital telephone, ABR retries dialing a telephone number on a line if a far end busy signal is detected. Turn LED 12 ON to have the system try up to 10 times; turn OFF for up to 15 attempts. This feature is not available with standard telephones and/or Tie or DID lines.

LED 11: ABR Redial Time

Upon detecting a far end busy signal on a line, ABR will retry either once every 30 seconds or once every minute. Turn LED 11 ON for 30 seconds; turn OFF for one minute.

LED 10: System Speed Dial Override, Toll Restriction

System Speed Dial can be chosen to override Toll Restriction if LED 10 is turned ON.

LED 09: Exclusive Hold

Exclusive Hold allows electronic and digital telephones to place calls on hold (by pressing the **Hold** button twice) so that other stations cannot pick up the held call with a **CO Line** button. This feature can be disabled on a system-wide basis. Any station can pick up an Exclusive Hold call by using the call pickup code.

LED 08: Alternate Point Answer/Transfer Privacy

If Transfer Privacy is selected, a ring/blind transferred call can only be answered at the called station upon transfer of that call (after the transferring party releases the call). With Alternate Point Answer, any electronic or digital telephone with the appropriate CO line or [DN] button can pick up a call transferred to another telephone. In either case, Call Pickup will function from any station. Station [DN] and CO line transferred calls that occur on [DN] buttons are always Private.

LED 07: Ring Transfer of CO Line Allowed

This option defines station operation for transferring [DN] and CO line calls. If Ring Transfer is allowed, the system will allow “blind” transfers to busy or idle stations. The transferring station may release a transferred call before the called party answers. If not allowed, the system will allow supervised transfers only—the called station must answer before the transferring station releases. If Ring Transfer is not allowed, immediate recall occurs if “blind” transfer is attempted. The system denies Ring Transfer to stations in the Do Not Disturb (DND) mode, and immediate recall will occur if attempted.

LED 06: CO Line Repeat Ringing

If selected, the incoming ringing timing pattern at a station will be the same as the CO line ringing pattern. This is used mainly with Centrex or PBX systems which may vary the ring pattern to distinguish between internal and external incoming calls, etc. If Standard Ringing is chosen, CO line station ringing will cycle one second on, three seconds off regardless of the incoming ring pattern. This ringing option may be undesirable for some COs.

LED 05: Incoming Call Abandon Timing

The amount of time between incoming CO line ring signals determines when the system will discontinue (abandon) sending ringing tones to stations. The choice of six or eight seconds depends on the line ring pattern. This assignment has no effect if the Line Repeat Ringing (LED 06) option is used.

LED 04: Dual-tone Multi-frequency (DTMF) Signal Time

DTMF signals sent out to CO lines can be either 80 or 160 msecs. in length. DTMF to QSTU2, KSTU2, RSTU, RSTU2, RDSU/RSTS, PSTU, PESU ports (including voice mail ports) are not affected by this assignment. See Program 10-2 for standard telephone port DTMF timing. This program pertains to manual dialing or speed dialing from all Toshiba telephones, with the following exception. When dialing manually from 2000-series telephones, signals last as long as the buttons are pressed (minimum 80 msec.).

LED 03: Dial Pulse (DP) Make Ratio

Dial Pulse timing sent out to CO lines can be changed from the normal 40% make ratio to 33%. This selection only applies to those CO lines assigned in Program 15 to signal dialing with dial pulse instead of Dual-tone Multi-frequency (DTMF).

LED 02: Line Reseize Guard Time

Should be set for 0.45 seconds for most installations. Set guard time for 1.5 seconds (using Program 10-1, LED 02 ON, and Program 42-0), if CO lines experience the following situations: no dial tone when a line is released and reseized immediately; or, when operating behind Centrex or PBX, false hookflash signals are sent to the CO when stations release and reseize the same line immediately.

LED 01: Tone First/Voice First Signaling-Electronic and Digital Telephone

With Voice First, a Directory Number call to an electronic or digital telephone will be preceded by a one-second burst of tone, followed by voice communication via the Handsfree Answerback function. For Tone First, repetitive Directory Number ring tone is sent in a one-second on, three-seconds off pattern. Conversion from one signaling mode to the other can be made by dialing an additional digit of 1 from the calling station. Voice First applies to called [PDNs] only; [PhDNs] are always tone first regardless of LED 01 setting.

Program 10-2 – System Assignments, Part 2 of 3

Processor Type: DK14, DK40i, All RCTUs

Program Type: System

Initialized Default: LEDs 02, 14, 15, and 16 are ON

* # * # 1 * 2 * 3 - Spkr 1 0 Hold - Spkr 2 Hold - Spkr # # Hold - Spkr # # Hold

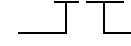
SELECT = 2  Light the LED Buttons that are marked with an X in the table below.

Button/ LED	X	LED ON	LED OFF
20		Padded DTMF Tone Return When Dialing	DTMF/No DTMF Per Prog 10-2, LED 11
19		External Conference Amp Connected to PEKU	No External Amplifier Connected
18		External Conference Amp Connected to PEKU	No External Amplifier Connected
17		"TRNS" Soft Key—Immediate	"TRNS" Soft Key—Normal
16		Executive Override Warning Tone/ON	Executive Override Warning Tone/OFF
15		External Page included with All Call Page	Not Included - see Button/LED 20 note.
14		Privacy Override/Attendant/Supervised Loop Warning Tone/ON	Privacy/Attendant Supervised Loop Override Warning Tone/OFF
13		Send Auto Callback Camp-on Tone	No Callback Tone. Called party receives notification tone when calling party activates Auto Call Back.
12		CO Line 3 min Beep Tone	No Beep Tone
11		No DTMF Tone Return When Dialing	DTMF tone return when dialing
10		BGM connected to PESU, Circuit 8	EKT connected to PESU, CKT 8
09		BGM connected to PEKU, Circuit 3	EKT connected to PEKU, CKT 3
08		Elapsed Time Display 1 min. After Access or Answer a CO line	Elapsed Time Display 15 sec. After Access or Answer a CO Line
07		Standard Tel. CO Ring per Prog. 10-1, LED 06	Standard Tel. CO Ring Distinctive
06		VM ID Code DTMF Signal Time 80 ms	160 ms
05		Send Music-on-hold.	Send Ringback Tone to the transferred party.
04		MW cancel from VM: RS-232 or dial #64 + [DN]	MW cancel from VM: Automatic When Answer
03		3 Ringing Modes	2 Ringing Modes
02		Hunt/C.F. override from DSS console's phone	Hunt/C.F. override from DSS console
01		Tone First (from DSS Console)	Voice First (from DSS Console) This applies to [PDNs] not [PhDNs]; [PhDNs] are always tone first.

Program 10-2 Overview

You can make the following system assignments with Program 10-2:

LED 20: Padded Tone Return

With some Central Offices, callers may experience clicking or squealing sounds or a loud DTMF tone return during or after dialing. To counteract this, it is recommended that padded tone return or no tone return be enabled (LED 20 ON) or No DTMF tone return (LED 20 OFF and LED 11 ON). If this option is not selected (LED 20 OFF), Program 10-2, LED 11 selects normal level DTMF Return or No DTMF Return.

The optional padded DTMF frequency system tone is returned to callers at a lower-than-normal volume level with each digit dialed from the telephone dial pad or when speed dialing is used.

The tones are also heard by callers routed to voice mail when DK sends VM ID codes.

LED 19: Stations Use External Amplified Conference

Enable this feature (LED 19 ON) only if an external amplifier (Program 10-3) is used for Two-line conference calls. This provides additional amplification to the station during a Two-line conference call. If Two-CO line conference/tandem call volume is low due to CO line loss, Toshiba recommends testing two-line Conference with LED 19 ON; if it improves the volume level and there is no hum noise, keep LED 19 ON.

Disable this feature (LED 19 OFF) if an external amplifier is not switched into two-line conference calls in all cases. Do this because line unbalance may cause hum noise on the station talk path during Two-CO line conference calls.

LED 18: Two-CO Line Conference

LED 18 should be OFF whenever Two-line (Tandem, DNIS Network, External Call Forward, DISA) connection is allowed (in Program 15-5 and Program 10-1, LEDs 19 and 20) unless Two-CO line conference amplifiers are connected (Program 10-3, LED 01~04).

This increases the volume level between the two outside parties on a tandem (two-line) connection, but it will not affect station volume if conferenced into the tandem connection. If Two-CO line volume is low due to CO line loss, test the volume level with LED 18 ON. If it improves without adding hum noise, keep LED 18 ON.

LED 17: “TRNS” Soft Key Immediate Transfer

If this feature is activated and a transfer is initiated with the “TRNS” Soft Key, the call will ring transfer (Camp-on Busy) immediately after the last digit of the called station (busy or idle) number is dialed. This feature does not apply to transfers initiated with the fixed **Cnf/Trn** button or “CONF” Soft Key.

LED 16: Executive Override Warning Tone

Executive Override allows a station user (if assigned in) to break into and listen to an existing station conversation. A warning tone can be set optionally to be heard by the conversing parties.

LED 15: External Page Included with All Call Page

External speakers and all electronic and digital telephones are paged by dialing: Directory Number [DN] + **#39**. The **All Call Page** button is used to page all digital and electronic telephones only; external speakers are not included when using the button.

If the All Call voice page access code (**#39**) is entered, or if the paging number is dialed on incoming Tie, DID or DNIS lines, external page (all zones) may be included with All Call telephone speaker paging. This option does not affect the **All Call Page** button function, which activates electronic and digital telephone speakers only, never external page (See Program 17, LED 01 and Program 71).

LED 14: Privacy Override Warning Tone

Privacy Override allows a station user to enter an existing CO line conversation by pressing a **CO Line** button (if the called station is assigned in Program 30). A warning tone can be set optionally to be heard by the conversing parties.

LED 13: Auto Callback Camp-on Tone

A busy called digital or electronic telephone user may optionally hear a one-time beep tone (from the speaker) signifying that another station has tried to call and has activated the Automatic Callback feature.

LED 12: CO Line Beep Tone

If this LED is lit, a beep tone will be sent every three minutes to stations on outgoing line calls.

LED 11: Dual-tone Multi-frequency (DTMF) Tone Return

This option deletes DTMF tones that are returned to digital or electronic telephones when manually dialing or speed dialing. It also eliminates auto dial digits returned to callers when digits are automatically sent to voice mail ports on forwarded calls.

LEDs 10 and 09: Background Music/Music-on-Hold Separation

An alternate Background Music (BGM) source can be sent to digital telephone speakers, electronic telephone speakers, and external page speakers, while another Music-on-hold (MOH) source can be sent to lines or internal stations on hold.

The alternate BGM source can be connected to either circuit 3 on a PEKU PCB, circuit 8 on a PESU PCB, or circuit 2 on a PSTU, KSTU2, RDSU, RSTU2, RSTU, or QSTU2. LEDs 09 and 10 should be OFF for RSTU2, RSTU, RDSU, KSTU2, QSTU2, and PSTU alternate BGM. Also run Program 19 to assign BGM to a PCB slot number.

- ♦ **DK14, DK40i:** The normal MOH source can be connected to the MOH RCA jack on the DK14 KSU or on the DK40i KSU.
- ♦ **DK424:** The normal MOH source always connects to an RCTU. Also run Program 19 to assign BGM to a PCB slot number.

When disabled (LED 10 OFF), deletes DTMF tones returned to digital and electronic telephones when dialing from dial pad or speed dialing; also deletes auto dial digits from callers that are call forwarded to voice mail. This does not affect the actual DTMF tones sent out to trunks or voice mail devices.

When disabled (LED 09 OFF) BGM connected to the PEKU or PESU is sent to electronic and digital telephone speakers and external page (optional). To assign the BGM PCB slot number, see Program 19-1.

PESU/PEKU can be in any universal slot assigned in Program 19-1.

LED 08: Display Dialed Number Timing

An LCD telephone will display a dialed number on outgoing calls and the CO line (Program 93) ID name, DNIS, ANI, or Caller ID information on incoming calls for either 15 or 60 seconds before the display changes to the elapsed time of the call.

LED 07: Standard Telephone Distinctive Ring

If Distinctive Ring is enabled (LED 07 ON) the CO line call ring pattern is standard: 0.2 seconds on, 0.4 seconds off, 0.2 seconds on, 3.4 seconds off; intercom ring is always 1 second on, 3 seconds off. This does not apply to VM Ports (Program 31, LED 17 ON) which are always standard ring. The line call ring pattern to standard telephones can be made distinct from the intercom ring pattern.

If Distinctive Ring is not enabled (LED 07 OFF), the pattern is per Program 10-1, LED 06. Intercom, Transferred, Tie, and DID calls, with or without Distinctive Ring enabled, ring with a 1-second on and 3-seconds off pattern.

LED 06: Voice Mail Identification Code, Dual-tone Multi-frequency (DTMF) Signal Time

DTMF digits automatically sent to RSTU/RDSU/RSTU2/RSTS/PSTU/PESU/KSTU2/QSTU2 voice mail ports can be sent in either 80- or 160-millisecond bursts. This applies to digits sent via the voice mail identification code (**#656/#657**) set at each station. This also applies to manually dialed digits sent to voice mail ports from Toshiba telephones, including 2000-series digital telephones.

LED 05: Music-on-hold or Ring Back Tone

Prior to Release 3.2, transferred parties would either hear Music-on-hold (MOH) or silence. With Release 3.2 and higher, transferred parties can hear MOH or Ring Back Tone (RBT). Turn LED 05 ON to play MOH for transferred parties; turn LED 05 OFF to send RBT. If MOH is not installed, and LED 05 has been turned on, the transferred party will hear nothing.

LED 04: Voice Mail Message Waiting Cancel Via Dial #64/Automatic

Set Voice Mail Message Waiting Cancel Via Dial **#64** (LED 04 ON) if the Strata DK system is connected to a voice mail (VM) system that sets station Message Waiting (MW) LEDs by RS-232 or by dialing **#63** + Station number, [PDN] or [PhDN] or RS-232 signal. This ensures the message LED remains flashing and are not cancelled by the DK system until the VM machine cancels the Message LED by sending an RS-232 signal or pressing **#64** + Station Intercom number, [PDN] or [PhDN].

Also, when using RS-232 Voice Mail Integration (SMDI) LED 16 must be set to ON in Program 31, for PGM 10-2 to function.

Set to Automatic (LED 04 OFF) to cancel the flashing message waiting LED any time a station calls the VM machine and the VM machine answers.

LED 03: Ringing Modes

The Strata DK system can be set for either two-ringing mode or three-ringing mode operation. The Day and Night modes are available with the two-mode operation, and the Day, Day2, and Nights modes are available with the three-mode operation. Each ringing mode has distinct CO line ring assignments (Programs 71 (1~3), 78; 81~89 and *81, *84, *87).

The three-mode selection is useful for alternate answering positions. Station users can change modes with the **Night Transfer** button on either a DSS console (Program 29), a telephone (Program 39) and/or Attendant Consoles (Program 59).

This feature applies to loop and ground start lines, and also Tie, DID, and DNIS lines assigned with Program 17, LED 05 ON; these lines will use Program 71 (1~3) assignments. Tie and DID lines assigned with Program 17, LED 05 OFF cannot be routed to different destinations in the Day/Day 2/Night modes.

LED 02: Call Forward/Station Hunt Override From DSS Console (DK424 and DK40i only)

If a station has activated Call Forwarding or Station Hunting, all calls to that station—except for calls from the DSS console position—will forward or hunt to another number. You can Call Forward from the console itself *or* from the digital or electronic telephone assigned to it. You cannot Call Forward from both; it is an either/or choice. If the console calls (using the DSS console station buttons) are forwarded, the telephone attached to the console will not be forwarded, and vice versa. This allows the console operator flexibility in reaching a station user that has Call Forward or Station Hunt telephone options activated.

Note This feature applies to both types of DSS consoles, the DDSS and the HDSS.

LED 01: Tone First/Voice First-DSS Console

The intercom call signal from a DSS console can be set for Tone First Signaling or Voice First Signaling. This setting is independent of the system-wide signal option in Program 10-1. Thus, DSS consoles and their attendant stations can ring with different signaling modes. Voice First applies to called [PDNs] only; [PhDNs] are always tone first.

Program 10-3 – System Assignments, Part 3 of 3

Processor Type: DK14, DK40i, All RCTUs

Program Type: System

Initialized Default: LEDs 11, 13 and 20 ON, all other LEDs OFF

* # * # 1 * 2 * 3 - Spkr 1 0 Hold - Spkr 3 Hold - Spkr # # Hold - Spkr # # Hold

SELECT = 3  Light the LED Buttons that are marked with an X in the table below.

Button/ LED	X	LED ON	LED OFF
20		SMDI Message Desk Number (001) is sent in SMDI packet.	CO line number is sent in SMDI packet.
19		Speed Dial Entry Timeout- 3 minutes	Speed Dial Entry Timeout - 1 minute
18		Auto Attendant: Normal Ringing Pattern After Camp-on	Auto Attendant: Back to Announcement After Camp-on
17		Auto Attendant: Ring Before Disconnect time	Auto Attendant: Ring Before Disconnect time
16		Auto Attendant: Ring Before Disconnect time	Auto Attendant: Ring Before Disconnect time
15		Auto Attendant: Sends MOH to Caller	Auto Attendant: Sends RBT to Caller
14		SMDI-Bellcore Standard VM Interface, per LED 09 Below	Not used
13		SMDI-Station Number Digit Length (HEX-8)	SMDI-Station Number Digit Length (HEX-0)
12		SMDI-Station Number Digit Length (HEX-4)	SMDI-Station Number Digit Length (HEX-0)
11		SMDI-Station Number Digit Length (HEX-2)	SMDI-Station Number Digit Length (HEX-0)
10		SMDI-Station Number Digit Length (HEX-1)	SMDI-Station Number Digit Length (HEX-0)
09		Bellcore Standard 1985 Version (1-space)	Bellcore Standard 1985 Version (2-space)
08		Caller ID/ANI numbers are sent out the SMDI port	Caller ID/ANI numbers are not sent out the SMDI port.
07			
06			
05			
04		PEKU Ports 33, 34-Amp, connected (RCTUBA/BB or higher)	PEKU Ports 33, 34-stations connected
03		PEKU Ports 25, 26-Amp, connected	PEKU Ports 25, 26-stations connected
02		PEKU Ports 17, 18-Amp, connected	PEKU Ports 17, 18-stations connected
01		PEKU Ports 09, 10-Amp, connected	PEKU Ports 09, 10-stations connected

System & Station

Program 10-3 Overview

You can make the following system assignments with Program 10-3:

LED 20: SMDI Message Desk Number

For CO line calls answered by Voice Mail/Auto Attendant devices, either the three-digit CO line number (001~200) or the Message Desk number (001) can be sent in the Message Desk fields of the SMDI packet. The system distinguishes CO line number 001 from Message Desk number 001.

LED 19: Speed Dial Entry Timeout

Station users can either have up to one minute or up to three minutes to store a Speed Dial number or memo. If they do not store the number or memo within the set time, their station exits the Speed Dial-storage mode and returns to the normal idle state. The timer is required because of the User Programmable Feature Buttons feature, which allows the [PDN], **Hold**, and **Cnf/Trns** buttons to be programmed in Speed Dial Memory. The three-minute setting is recommended if station users frequently store memos with Speed Dial numbers using the **Mode** button below the LCD.

LED 18: Built-in Auto Attendant Camp-on Busy/Ring No Answer Routing

This option is designed for Auto Attendant configurations that have primary announcement devices, but no secondary ones tells the system where to route Auto Attendant calls that ring and are not answered or have been camped-on for a designated time (see Program 26). The calls can be sent back to the primary announcement device or to the station or stations assigned to the CO lines' normal ringing pattern (see Programs 81, 84, and 87).

LEDs 16 and 17: Built-in Auto Attendant Disconnect Time

If LED 18 is assigned for normal ringing, set LEDs 16 and 17 to tell the system when to disconnect Built-in Auto Attendant calls that have not been answered by the alternative stations.

The time the Auto Attendant rings stations (per Program 81, 84, 87) after a loop start line caller does not dial and/or a ringing station does not answer. If a call is not answered before ring disconnect time period time-out, the call will disconnect. This prevents loop start lines from being locked-up when there is no CPC supervision from the central office after the outside caller hangs up.

Set LEDs 16 and 17 for the desired time as follows:

- ◆ 40 seconds: LED 16 OFF, LED 17 OFF (Initialized default)
- ◆ 120 seconds: LED 16 OFF, LED 17 ON
- ◆ 240 seconds: LED 16 ON, LED 17 OFF

LED 15: Built-in Auto Attendant MOH/RBT for Transfer

Callers can hear ring back tone (RBT) or Music-on-hold (MOH) after being transferred from the Built-in Auto Attendant to a station, depending on the selection made with LED 15.

LED 14: RS-232 Voice Mail Signaling Method

The DK provides two types of RS-232 signaling: Bellcore Standard type (TR-TSY-000283, TR-NWT-000283) or Toshiba Proprietary. Refer to the VM machine installation documentation and contact the Toshiba and/or VM machine manufacturer for VM machine SMDI configuration.

Notes

- Toshiba VP products require Release 7 software or above for Toshiba proprietary integration.
- Toshiba VP products require the SW-X0042 feature package (CO Centrex) for SMDI, but not for Toshiba Proprietary RS-232 Interface.
- Toshiba Strategy products support SMDI only in the standard configuration, not Toshiba proprietary RS-232 interface.

LEDs 13-10: SMDI Station Number Digit Length

Set LED 10-13 ON so that the hex values add up to the Voice Mail station digit length for SMDI VM interface. (Example: For VP100 or Stratagy/Stratagy DK SMDI interface, set LEDs 10, 11, and 12 on for 7 digits (1+2+4=7).

Do not set LED 10-13 OFF for Toshiba proprietary interface; it is no longer supported by DK systems.

This refers to the station digit length that the SMDI voice mail system design requires. This parameter is set for the Voice Mail system digit length; not the DK station digit length. If the voice mail system SMDI is designed per the Bellcore Standard TR-TSY-000283, 1985 version, set this parameter to seven-digits (LEDs 10, 11, and 12 ON which is equal to Hex 7). Current VP and Stratagy voice mail SMDI systems are designed for this seven-digit operation.

If the voice mail system SMDI is designed per the Bellcore Standard TR-NWT-000283, 1991 version, set this parameter between 1-10 digits with LEDs 10, 11, 12, and 13. (See Program 10-3 record sheet for LED-HEX values.) Digit length setting is not necessary with Toshiba Proprietary Interface (LED 10-13 OFF).

LED 08: Caller ID / Automatic Number ID

This option determines if Caller ID (CLID) and/or Automatic Number Identification (ANI) telephone numbers will be sent out the system SMDI port (SMDI only not Toshiba proprietary):

- ♦ Turn LED 08, 10, 11, 12, and 13 ON if received Caller ID and/or ANI numbers should be sent out the system SMDI port.
- ♦ Turn LED 08 OFF (initialized default) if received Caller ID and/or ANI numbers should not be sent out the system SMDI port.

LED 09: SMDI Bellcore Standard Version

Toshiba Proprietary and SMDI is available with RCTUB2 or RCTUC/RCTUD2 Release 2 and above only and is only for use with Toshiba VP systems, not with Toshiba Stratagy systems.

Bellcore released two versions of the SMDI specification. Contact your voice mail machine vendor to determine which specification to enable with this program – TR-TSY-000283, Issue 1, July 1985 version, or the TR-NWT-000283, Issue 2, May 1991 version. Toshiba VP and Stratagy SMDI products currently use the 1985 version. In either case, the VM station digit length must be set with LED 10~13 as shown above.

Also note that the 1985 and 1991 version Bellcore specifications use different space/character parameters for some call types which means the DK will not operate properly if the correct version is not selected. Select the 1985 version (LED 09 OFF) for Toshiba VP and Stratagy products. This selection is not needed with Toshiba Proprietary Interface.

LEDs 01~04: Amplified Conference Assignments

Light LEDs 01~04 to identify which PEKU ports should be connected to external amplifiers. External Amplified Conference is provided by customer-supplied two-way amplifiers connected to system PEKU ports to amplify “two-line” calls.

- ♦ **DK424 and DK40i:** Up to four amplifiers can be connected, depending on the DK system type (two PEKU ports per amplifier). The number of simultaneous Two-CO line conferencing (three-party) calls varies according to the processor:

DK40i: 4 calls (2 amplified)

RCTUA: 4 calls (3 amplified)

RCTUB, RCTUBA/BB and RCTUC/D: 10 calls (4 amplified)

RCTUE: 20 calls (4 amplified)

For DK424 and DK 40, amplifiers are switched into Two-CO line calls automatically, one amplifier for each call, starting from the lowest PEKU ports enabled to the highest (see Program 10-3 record sheet). Skipping ports is allowed. Two-CO line calls established after all amplifiers are in use will not be amplified.

Example

The first amplifier can be connected to PEKU ports 017 and 018, skipping ports 009 and 010. In this case, LED 02 should be ON and LED 01 should be OFF. (See Program 10-1, LEDs 19 and 20; Program 10-2, LEDs 18 and 19; and Program 15-5 for more information on Two-line Conference.)

Important! *The amplifiers used for supervised, Two-line Conference connections are switched in automatically starting with the first connection. Calls made when there are no amplifiers available will not be amplified. Unsupervised Two-line tandem connections are not limited to the numbers listed above (by processor), but are limited by the number of lines equipped in the system.*

Note External amplifiers also amplify two-line DISA, Call Forward External, DNIS externally routed calls, DID, and Tie line trunk to trunk calls.

Program *10 – Enhanced 911 Operation

Processor Type: DK14, DK40i, all RCTUs

Program Type: System

Initialized Default: See each program

Program *10 provides two QSTU2, RSTU, KSTU2, RDSU, PSTU, or PESU ports to be assigned to interface with central office E911 trunks.

E911 enhanced operation provides locator information to the responding agency to provide more complete name and address information, including building, floor, etc. This is done by sending the station number of the 911 caller to the E911 emergency center. This locator information is then cross referenced with name/number/address data in the E911 central database, and the E911 operator receives the precise location along with the basic information.

The Strata DK14, DK40i and DK424 accomplishes this through a special interface between the KSU and the CO. This special interface takes the station number information and sends it through the public network in a format compatible with the central E911 database. This special interface is required in addition to sending software within the Strata DK.

The required interface is an external device (Telident or Proctor) that interfaces to up to two standard analog station ports.

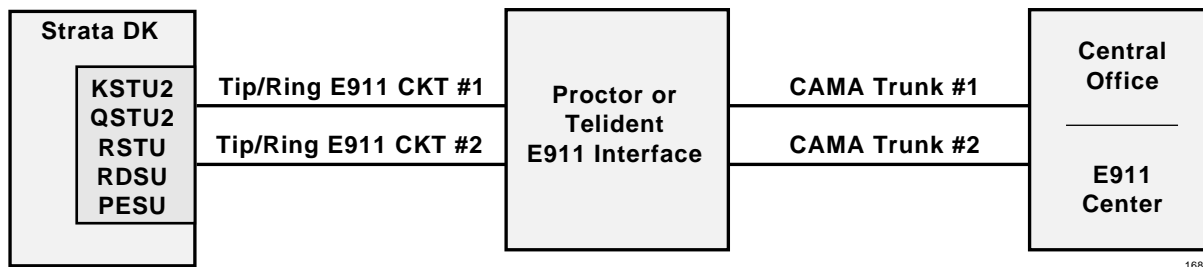

E911 CKT 1 and 2 assigned in Program *10

Figure 3-1 Physical Connection of E911 Interface

Programs *10-11 and *10-12 – E911 Standard Telephone Ports Assignment

Initialized Default: Blank



First E911 Port = 11 — E911 RSTU/KSTU2 Port Number

Second E911 Port = 12

	E911 RSTU/KSTU2/QSTU2 Port Number
First Standard Port	
Second Standard Port	

Programs *10-11 and *10-12 Overview

Programs *10-11 and *10-12 assign which QSTU2, KSTU2, RSTU2, RSTU, RDSU, PSTU, or PESU standard telephone ports are connected to the E911 interface unit.

Important! Program 04 Directory Number data must be blank for E911 QSTU2, KSTU2, RSTU2, or RSTU ports.

Program *10-91 – E911 Interdigital Time

Initialized Default: 15 seconds

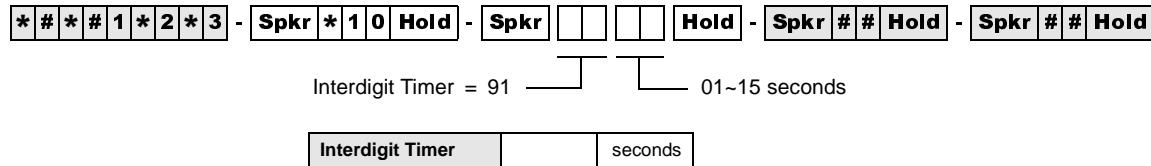

Program *10-91 Overview

*10-91 assigns the time allowed to dial each digit after dialing 9 when using the E911 feature. This time will affect the time that LCR or CO Line dial tone is returned when dialing 9. However, a user can dial a 9+ (non-911) calls normally before receiving LCR or CO line dial tone and the DK will route the call appropriately.

Program *10-92 – E911 Pause Before Send Timer

Initialized Default: 0 - No pause

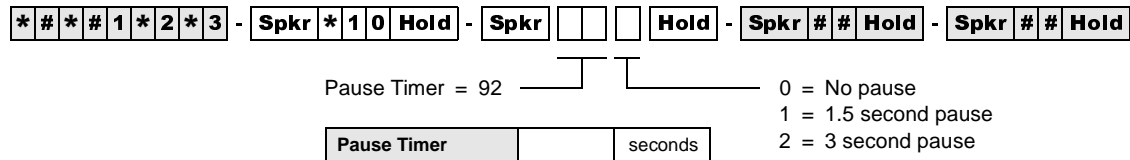

Program *10-92 Overview

*10-92 assigns the time the DK will wait before sending the Station Primary Directory Number to the E911 SLT port after the E911 SLT port answers.

Program 12 – System Assignments, Basic Timing

Processor Type: *DK14, DK40i, All RCTUs*

Program Type: *Station*

Initialized Default:

Program Timing	
Code 1	15 secs.
Code 3	1
Code 4	2
Code 5	0
Code 8	1
Code 9	4

* # * # 1 * 2 * 3 - Spkr 1 2 Hold - Spkr Hold - Spkr # # Hold - Spkr # # Hold

SELECT = 1, 3-5, 8, 9
Enter program code from the table below.

DATA = Enter ring down time (00-60)

SELECT CODE = Enter the 1 digit code which corresponds to the time listed in the table below.

For Program Codes 8 and 9, the LCD responds with

Program Code	Function	Code	Time	Required Code
1	Standard Telephone Ring Down Timer (Release 4.0)	XX	XX = 2 digits. 00-60 secs.	
3	Pause Timing (Speed Dial)	1	1.5 sec	
		2	3.0 sec.	
4	Flash Timing	1	0.5 sec.	
		2	2.0 sec. (Not used in U.S.)	
		4	0.2 sec.	
5	Pause After Flash (Voice Path Delay)	0	no pause	
		1	1.5 sec.	
		2	3.0 sec.	
8	DNIS Ext. Network, External Call Forward, and DISA Disconnect Timer for Loop Start Lines	0	no disconnect timer	
		1	4 min. disconnect	
		2	10 min. disconnect	
		3	20 min. disconnect	
9	QRUC3/K4RCU3/RRCS DTMF Inter-digital Release Time (Standard Phone)	1-9	1-9 secs.	

Program 12 Overview

This program assigns system times for ring down, disconnecting calls, pause times, flash times, auto attendant, DISA, Call Forward External, and DNIS and DTMF receiving decoding.

Code 1: Standard Telephone Ring Down Timer

This feature is available for Release 4.0 and higher. Code 1 assigns the number of seconds that a Hotline or Emergency standard telephone waits after going off-hook before automatically ringing a preassigned directory number. If a valid feature access code or [DN] is dialed prior to the ring down timer expiration, then ring down does not occur. Ring down applies only to standard telephone ports, not electronic or digital telephone ports. Ring down destination numbers are assigned in Program *38.

Code 3: Pause Timing

Code 3 enables station users to program short and long pauses in Speed Dial numbers. Applies to pauses inserted in Speed Dial numbers used for both telephone voice calls and data calls from data interface units. The short pause length can be set system wide for either 1.5 or 3 seconds with this program. The long pause is always 10 seconds.

Code 4: Flashing Timing

When on a CO line, a station user can press the **Flash** button (or enter access code **Cnf/Trn #45**) and the line opens (flash) for 2 seconds, 0.2 seconds (not used in the USA), or 0.5 seconds depending on this assignment. This choice reflects whether to disconnect and regain dial tone (2 seconds), or to use PBX or Centrex features which require a flash signal (0.5 seconds). It also applies to flashes inserted when dialing via Data Interface Units (DIUs).

Code 5: Pause After Flash

Some COs or Centrex facilities require a period of time after a flash signal before they can accept dialing signals. A selection of pause timing is available to automatically delay any dialing signals after flash. This timing applies to Speed Dial calls (with flash signals between the telephone number digits) as well as to manual dialing.

Code 8: DNIS Ext. Network External, Call Forward, and DISA Disconnect Timer for Loop Start Lines

Disconnects DISA, Call Forward External and/or DNIS Telephone Network routed calls when made on loop start lines. Calls can lock-up (keep busy indefinitely) if the CO does not send a disconnect signal (CPC or AR) when the caller hangs up. This timer prevents loop start lines from locking up by disconnecting the call automatically when the timer expires, 4, 10, or 20 minutes from the start of the call. Callers will hear a warning tone and can reset the timer repeatedly by dialing “0”. This disconnect feature is only needed for loop start lines.

Code 9: QRCU3/K4RCU3/K5RCU/K5RCU2/RRCS DTMF Receiver Inter-digital Release Time

With Code 9, one channel of the QRCU3, K4RCU, K5RCU, and K5RCU2 or RRCS Dual-tone Multi-frequency (DTMF) receiver is seized when it is needed for the decoding process, such as for a standard telephone with a DTMF dial pad. When placing outgoing calls with DTMF standard telephones, the talk path to the outside party is not “cut-through” until the DTMF receiver circuit is released. The DTMF receiver channel’s release time can be programmed for between one and nine seconds (initialized timing is four seconds)—this is the time it takes to release the DTMF receiver circuit after the last digit is dialed.

The choice of timing is a trade-off between CO line time to connect and user speed. If the time is too long, the outside called party may answer before the voice path is “cut-through,” and the caller is not heard. If the time is too short, a standard telephone user inputting DTMF tones could be cut off prematurely from using other features, such as Speed Dial or Toll Restriction.

Standard telephones can also defeat Toll Restriction if the seize time is too short and they are not required to dial outgoing calls via Least Cost Routing (LCR). Toshiba recommends that standard telephones should always be required to dial outgoing calls via LCR to prevent them from defeating Toll Restriction.

Note If no digits are dialed after accessing an outgoing CO line, the DTMF receiver remains seized for 15 seconds and then drops; however, the line remains connected.

Program 13 – Defining the Message Center

Processor Type: DK14, DK40i, All RCTUs

Program Type: Station

Initialized Default: No port assigned

* # * # 1 * 2 * 3 - Spkr 1 3 Hold - Spkr 1 [] [] Hold - Spkr # # Hold - Spkr # # Hold

SELECT = 1 PORT = Station Logical Port Number

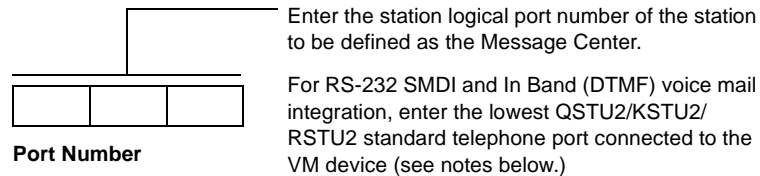

Program 13 Overview

This program assigns a station as the Message Center.

Each digital, electronic and standard telephone can receive a maximum of four message waiting indications per [PDN] and each [PhDN] owned by the station. One of these four is reserved for the designated Message Center. The Message Center should be the customer's main answering position.

Typically, the Message Center is a voice mail device, attendant console, a digital or electronic telephone with a DSS console (DDSS or HDSS), or an add-on module. If incoming traffic to a DDSS or HDSS console attendant is heavy, another station can be assigned as the Message Center.

Notes

- The Message Center is allowed to perform "Message Waiting," even if disallowed on all other stations.
- Assign the Message Center to the customer's main answering position: a station or the lowest port (in VM group) of the customer's voice mail device (see Program 31 for voice mail group port assignments), whichever the customer specifies.
- When using RS-232 SMDI or DTMF voice mail interface, all stations must also be assigned to the message center port in Program *32 and Program 13. This should be the lowest standard telephone port (QSTU2/KSTU2/RSTU2) connected to the VM device. This is also the same (lowest) port assigned in the Program 31 VM group and the lowest standard telephone port assigned in the Program *40 VM Distributed Hunt Group. Do not assign the VM DH Group port number (900~915) as the message center port.

Program 15 – Ground/Loop/Tie/DID Line Options

Processor Type: DK14, DK40i, All RCTUs

Program Type: System

Initialized Default: All LEDs are OFF

* # * # 1 * 2 * 3 - Spkr 1 5 Hold - Spkr Hold - Spkr # # Hold - Spkr # # Hold

SELECT = Program Code _____ LED Buttons = CO line

Press Scroll to advance or **Page** to go back.

To advance the CO line range, press **Scroll** located beneath the LCD. Press **Page** for a lower range.

Specify CO line by setting LEDs as defined by the table below. When you are finished, all LEDs with an "X" should be lit.

Processor Type	CO Line Range
DK14	001-004
DK40i	001-012
RCTUA	001-016

Processor Type	CO Line Range
RCTUBA/BB	001-048
RCTUC/D	001-144
RCTUE/F	001-200

Program Code	Program	LED ON	LED OFF	Line																	
				LED																	
				01	02	03	04	05	06	07	08	09	10	11	12	13	14	15	16	17	18
0	CPC on AR VM Calls and Voice Calls	Detect	Ignore																		
1	CO/DID/Tie Line Signal	DP	DTMF																		
2	CO/DID/Tie Dial Pulse Rate (Pulse per sec.)	20 PPS	10 PPS																		
3	AR Hold	Detect	Ignore																		
4	AR Timing	Crossbar 95 msec.	ESS (electronic) 450 msec.																		
5	Tandem CO Line Connection with Station Dropout	Enabled	Not Enabled																		
7	Forced Account Code	Enabled	Not Enabled																		
8	Operation After CO Line Flash	No DTMF receiver After Flash	DTMF receiver After Flash																		

Program 15 Overview

This program specifies operational options on a line by line basis.

Code 0: Automatic Release (AR) on Voice Mail or Voice Calls

On loop start CO lines, some COs send the AR (Automatic Release) or CPC (Calling party Control) signal after an external party hangs up (typically 1~15 seconds) to disconnect a loop start line. An AR/CPC signal is a 95 or 450-millisecond open of the CO line loop. If the CO sends this signal after an external party hangs up and before the VM/auto attendant transfers a call, D tone will be sent to the voice mail port (Program 30, LED 15), releasing and clearing that port for another call. This feature is active on all voice calls.

When a station is disconnected from a CO line call by the AR/CPC signal, its LCD will display “CO LINE HANG UP”. The line can be disconnected anytime by the AR/CPC signal during the “talk state” of a call. CO line calls disconnected by the AR/CPC signal will be represented on the SMDR report by a “*” next to the CO line number. Code 0 does not apply to ground start lines, which automatically disconnect when the external party hangs up. The Voice Mail device must recognize the “D” tone as a disconnect signal.

Important! *This option cannot always be used because some COs may send unreliable AR/CPC signaling or no AR/CPC signaling for loop start lines.*

Enable AR/CPC-Hold detect on loop start lines only after testing that the CO sends the AR/CPC-Hold signal.

Code 1: CO Outgoing Signal

Each line can be independently assigned to have either Dial Pulse (DP) or Dual-tone Multi-frequency (DTMF) signaling on outgoing calls toward the Central Office.

- ♦ If a line is set for DP operation, the **Tone Dial Select** button must be programmed on stations that must send DTMF tones over the lines.
- ♦ If Tie or DID lines are programmed for dial pulse, turn LED 11 ON in Program 30 for each station port assigned to the DID or Tie line.

Code 2: Line Pulse (DP) Rate

If a line is assigned DP signaling, the rate can be either 20 or 10 pulses per second (PPS). Some Central Offices do not reliably accept 20 PPS.

Code 3: Automatic Release (AR) From Hold/Transfer

The Automatic Release (AR) signal sometimes called Calling Party Control (CPC) or Supervised Loop Control. This signal consists of a momentary open of the loop start CO line provided by some COs—the duration of the open depends on the CO. If a CO line is programmed (Programs 15-0 and 15-3) to detect the AR/CPC signal, the DK system drops the line when the CO sends the signal (typically 1~15 seconds after the outside party hangs up). The system sends D Tone to voice mail ports to drop the ports when AR/CPC is detected.

The Strata DK system disconnects a loop start CO line voice call and displays “CO LINE HANG UP” on the station’s LCD anytime the AR/CPC signal is detected and the CO line has Programs 15-0 and 15-3 enabled.

On loop start CO lines, some Central Offices send an AR/CPC signal. If the system CO line is on hold (or being transferred to another station or Auto Attendant port) when the AR/CPC signal is sent, it is automatically disconnected if this option is activated.

Two-CO line DISA calls always release when AR/CPC is sent. DISA release via AR/CPC is not related to this program. CO line calls disconnected by the AR/CPC signal will be represented on the Station Message Detail Recording (SMDR) report by a “*” next to the CO line number. Code 3 does not apply to ground start lines, which automatically disconnect when the external party hangs up. See Important! note in earlier paragraph on Code 0.

DK424 only: If loop start lines are programmed to detect the AR/CPC-Hold signal, they do not remain on the attendant console loop keys when the attendant console sets up trunk-to-trunk connection. If programmed to ignore AR/CPC-Hold, they remain on the attendant console Hold loop keys.

Important! *Enable AR/CPC-Hold detect on loop start lines only after testing that the CO sends the AR/CPC-Hold signal.*

Code 4: Automatic Release (AR) Time

AR/CPC signaling timing is different depending on the Central Office equipment. An assignment choice exists between Crossbar or ESS Central Offices.

For more information on AR/CPC, see the preceding Code 0 and Code 3 sections.

Code 5: Tandem Line Connection

Once a Two-line Conference call is made by an electronic, digital or (in R3.2) standard telephone users or voice mail ports, the user or voice mail device may drop out of the conference and leave the two lines connected. The choice exists for each line that may have this capability. This option must be enabled to allow CO lines (ground/loop/Tie/DID) to be used for outgoing DISA, Call Forward External, and Tie/DID/DNIS External Network routing calls.

With Release 3.2, a station which set up a tandem call and then dropped out can dial the pickup code (**#5#79**) to retrieve the tandem call. If more than one tandem connection is set up by a station, **#5#79** picks up the call with the lowest CO line as a priority.

Prior to Release 3.2, standard telephones could set up tandem calls, but they could not drop out. If they tried to drop out, the call would ring back to the standard phone.

Code 7: Forced Account Code (Verified or Non-verified)

If the Forced Account Code feature is used, (see Program 30) a station user is required to enter an Account Code before a CO line call can be completed. A choice exists for each line.

Code 8: Operation After CO Line Flash

If a standard telephone user is on an existing CO line call and flashes the hookswitch on their telephone, a Dual-tone Multi-frequency (DTMF) receiver channel may or may not be connected, depending on this assignment. If the CO line is a rotary dial only type, the QRCU2, K4RCU3, K5RCU, K5RCU2, or RRCS must be seized after flash when dialing from DTMF standard telephones. The QRCU2, K5RCU, K5RCU2, K4RCU3 or RRCS will decode the dialed tones and send dial pulses to the line.

Program *15 – CO Line Tenant Assignments

Processor Type: *DK14, DK40i, All RCTUs*

Program Type: *System*

Initialized Default: *All CO lines assigned to Tenant 1*

##1*2*3 - Spkr*15 Hold - Spkr [][] # [] Hold - Spkr## Hold - Spkr## Hold

SELECT = CO Line Number _____ TENANT = Assign the CO line to a tenant
(see legend below)
To add a line range, enter XXX*XXX (low port * high port).

Processor Type	CO Line Range	Tenants Supported	Processor Type	CO Line Range	Tenants Supported
DK14	001-004	2	RCTUBA/BB	001-048	4
DK40i	001-012	2	RCTUC/D	001-144	4
RCTUA	001-016	2	RCTUE/F	001-200	4

CO Line	Tenant Group			
	1	2	3	4

CO Line	Tenant Group			
	1	2	3	4

CO Line	Tenant Group			
	1	2	3	4



Program *15 Overview

A system CO line can be shared by more than one business tenant for the purpose of separating CO line ringing pickup and Night Transfer. Program *15 assigns CO line business tenants.

Program 16 – Assign CO Line Groups (or Dial 9)

Processor Type: DK14, DK40i, All RCTUs

Program Type: System

Initialized Default: All CO lines assigned to the Dial 9 group

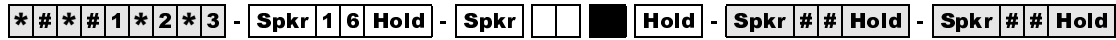

SELECT = CO Line Group (see legend)

LED Buttons = CO line

Only enter the last two digits of the CO line Group, or enter **00** for Dial 9 group.

Specify CO line by setting LEDs as defined by the table below. When you are finished, all LEDs with an "X" should be lit.

Press **Scroll** to advance or **Page** to go back.

To advance the CO line range, press **Scroll** located beneath the LCD. Press **Page** for a

Processor Type	CO Line Range	CO Line Groups
DK14	001~004	01~04
DK40i	001~012	01~08
RCTUA	001~016	01~08

Processor Type	CO Line Range	CO Line Groups
RCTUBA/BB	001~048	01~08
RCTUC/D	001~144	01~16
RCTUE/F	001~200	01~16

LED	Line Number	CO Line Groups														Dial 9(00)	
20																	
19																	
18																	
17																	
16																	
15																	
14																	
13																	
12																	
11																	
10																	
09																	
08																	
07																	
06																	
05																	
04																	
03																	
02																	
01																	

Program 16 Overview

Use Program 16 to assign each CO line to a CO line group or a general “dial 9” group. A general group for outside calling is available with a “dial 9” access code as the initialized state for all lines.

Lines can be accessed with a dialing code instead of with a CO **Line** button. This is useful for WATS lines or other facilities, and is heavily used in Least Cost Routing and Pooled Line Button assignments.

Do not attempt to assign a line to more than one group. A line need not be assigned to a group. If lines are not used, they should be taken out of all groups, including the “dial 9” group. Automatic Busy Redial (ABR) will not function if unconnected (unused) lines are assigned to a line group.

After programming, press:

- ♦ **Vol▲** to turn all LEDs ON
- ♦ **Vol▼** to turn all LEDs OFF
- ♦ **Mode** and CO line number, then **#** to display and advance

Program 17 – DID/Tie Line Options

Processor Type: DK40i, All RCTUs

Program Type: System

Initialized Default: LED 01/02 OFF, LED 03/04 ON

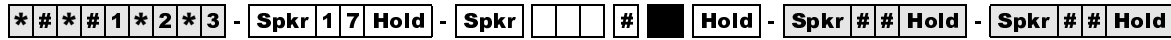

Enter Line No. that will be DID or Tie line. _____ Light LED Buttons 01~08 as noted in table below

To add a port range, enter XXX*XXX (low port * high)

Line Numbers:

LED/Button	X	LED ON	LED OFF
09, 10, and 14~20		Not used at this time.	
08		DID/Tie line DTMF digits with * tones	DID/Tie line DTMF digits without * tones
07		DID/Tie line receives ANI and routes per Programs 71 and 72	DID/Tie line does not receives ANI (DID Program *09 and Tie Program 04)
06		Telephone LCD priority is ANI	Telephone LCD priority is DNIS
05		DID/Tie line routes per DNIS assignments: (Programs 71 and 72)	DID/Tie line routes per Non-DNIS assignments: (DID Program *09 and Tie Program 04)
04		DID/Tie no second dial tone	DID/Tie second dial tone
03		DID line Auto Camp-on busy	DID line no Camp-on busy
02		Wink Start for Tie or DID	Immediate Start for Tie or DID
01		Page and Voice Announce on incoming Tie line Page access for Tie/DID DNIS lines	No Page and Voice Announce on incoming Tie line No Page access for Tie/DID DNIS lines

Program 17 Overview

Program 17 assigns lines for Tie and DID operation.

Important! *When normal Tie/DID lines are configured with Program 71 and 72 DNIS assignments, turn LED 05 ON and LED 06, 07 and 08 OFF for those lines - then program the lines as required in Programs 71 and 72.*

Notes

- Each REMU, PEMU, RDDU or TDDU PCB reduces the station port capacity by four station ports, each RDTU Tie/DID line channel reduces the system’s station port capacity by one port.
- Always install Tie or DID line PCBs in slot numbers that are higher than station PCB slot numbers (see Chapter 2 – DK40i Configuration in the *Strata DK Installation and Maintenance Manual*).
- Incoming Tie line calls camp-on only if Program 71 assignments are used.
- Copy one record sheet for each group of Tie/DID lines that have different Program 17 parameters.

LEDs 09, 10 and 14~20

Not used at this time.

LED 08: ANI/DNIS Digit Format

Most DID/Tie lines with ANI/DNIS digit format include * tone with digits (LED 08 ON). One exception, as of this writing, Sprint provides DNIS without ANI and does not include * tone with digits - in this case LED 08 should be turned OFF.

Examples of this signal format are: *ANI digits*DNIS digits* and *DNIS digits*.

DID/Tie lines with normal digit format does not include * tone with digits (LED 08 OFF).

LED 07: ANI Receive Line Option

If a Tie or DID line should receive ANI information, LED 07 should be turned ON for that line. If the Tie/DID line receives ANI digits only (no DNIS digits) LED 06, 07, and 08 should be ON and LED 05 should be OFF. See Program 71-1, address 199, 299, and 499 for Tie/DID ANI only call routing assignments. If a line receives ANI and DNIS, LEDs 05, 07 and 08 must be ON; LED 06 can be ON or OFF.

LED 06: Telephone LCD Display Option ANI or DNIS

Telephone LCDs can display ANI or DNIS information as a priority when Tie/DID lines or ISDN channels receive both ANI and DNIS digits. This system-wide option determines if ANI or DNIS information should display on telephone LCDs when Tie/DID lines provide both ANI and DNIS information together on incoming calls.

It is not possible to display both ANI and DNIS information simultaneously on the same call but the **Page** button on the LCD telephone can be used to toggle between the ANI and DNIS information when an ANI/DNIS line is ringing the telephone. After answering the call, it is not possible to toggle the LCD display between ANI and DNIS

LED 05: DNIS Line/Non-DNIS Line

This option assigns Tie and/or DID lines to follow Dialed Number Identification Service (DNIS) Program assignments.

Turn LED 05 ON for DNIS only or ANI with DNIS lines.

Turn LED 05 OFF and LED 07 and 08 ON for ANI only lines which should route per the last address assignment in Program 71.

Important! *Any Tie or DID line can be assigned to use the features of Program 71 and 72. If normal Tie/DID lines are assigned Name Tags, External Routing, selective Day/Day2/Night Routing: In Program 17, Turn LED 05 ON and turn LED 06, 07 and 08 OFF for those lines - then program the lines as required in Program 71 and 72. In this case, Program *09 (DID) and Program 04 (Tie) do not apply to these lines.*

LED 04: DID/Tie Second Dial Tone Option

If the second dial tone option is selected (LED 04 OFF), callers calling in on the DK DID or Tie lines will hear dial tone after accessing the DK Tie/DID lines. Second Dial tone will not be sent to callers if this option is not selected (LED 04 ON).

Important! *Normally, Tie lines require a second dial tone (LED 04 OFF) and DID lines should not return a second dial tone (LED 04 ON). The initialized data is set for DID lines so this data must be changed when installing Tie lines if second dial tone is required.*

LED 03/04 applies to REMU, PEMU, TDDU, RDDU and RDTU DIDs and Tie lines.

LED 03: DID Camp-on/Busy

Turn LED 03 ON if DID line callers should hear ringback tone and camp on to busy stations when calling busy stations. Turn LED 03 OFF if the DID callers should hear busy tone when calling busy stations. Analog Tie lines will not camp-on to busy stations.

It is recommended to turn LED 03 ON for all DID lines. To provide Camp-on-busy over RDTU Tie line calls, configure Tie lines as DID lines in Program *41-2; LED 03 must be on for the lines in Program 17. This is allowed because Tie and DID signalling is the same for Tie and DID T1 lines.

Also, both Tie and DID lines that route per Program 71 DNIS assignments will camp on busy if LED 03 is turned ON. Tie lines that route per Program 04 will not camp on busy.

LED 03/04 applies to REMU, PEMU, TDDU, RDDU and RDTU DIDs and Tie lines.

LED 02: Wink/Immediate

Applies to REMU, TDDU, PEMU, and RDDU Tie/DID lines only. Select Wink Start or Immediate Start for the entered Tie or DID line. See Program *41-2 for RDTU Tie/DID Wink/Immediate Start assignments or RDTU T1 Tie lines configured as DID lines in Program *42-1.

LED 01: Page/Handsfree Answerback

Allows (LED 01 ON) or denies (LED 01 OFF) the following features when connecting the Strata DK to another Key/PBX. LED 01 applies to both Tie and DID lines when programmed with Program 71 assignments.

If using a private network, then turn LED 01 ON to allow Page access on Tie and DID lines programmed with DNIS assignments in Program 71 (Code #039).

Per FCC regulations, public telephone network, Tie, DID, or DNIS lines must always be restricted (LED 01 OFF) from Page and Handsfree Answerback.

- ♦ Callers on the far-end Key/PBX system can access the Strata DK system external and/or Station All Call Page over DID and/or Tie lines programmed with DNIS assignment (Program 10-2, LED 15 and Program 71-1, Code #039) for DID/Tie DNIS assignments. Tie lines only that route per Program 04 can dial any Page Zone or Page Group access code.
- ♦ Callers on the far-end Key/PBX system can make voice announce calls to stations on the near-end Strata DK. This option applies only Tie lines (not DID lines) that route per Program 04 or Program 71. You must program the Strata DK as “Voice First” in Program 10-1, LED 01; or, the far end can dial “1” after dialing the [DN] on tone first systems.
- ♦ Callers on the far-end Strata DK can answer Tie lines calls (not DID lines) from the Far End Key/PBX in the hands free mode. You must program the near-end Strata DK as “Voice First” in Program 10-1, LED 01, or the far-end caller must dial “1” to switch from ring to voice signaling.

Program 19 – Alternate Background Music Source Slot Assignment

Processor Type: DK40i, All RCTUs (not used for DK14. See Program 10-2, LED 10)

Program Type: System

Initialized Default: Slot 11

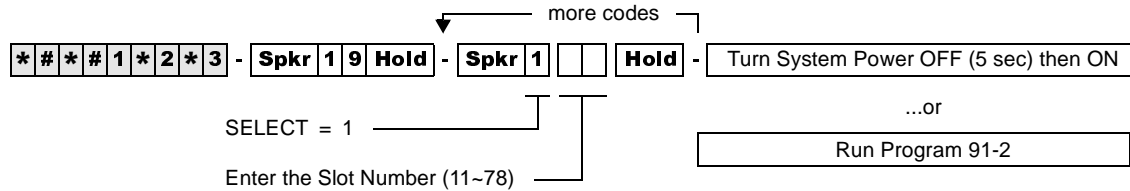

Program 19 Overview

The PCB connected to the alternate BGM source can be in any slot. Use this program to designate that slot. LEDs 09 and 10 in Program 10-2 should be OFF if the source is connected to a QSTU2, KSTU2, PSTU, RSTU, RSTU2, or RDSU. (Only circuit 2 of these PCBs can support the BGM source.)

The alternate BGM source sends BGM to the external speakers and telephone (digital and electronic) speakers. If an alternate BGM source is used, the Music-on-Hold (MOH) source connected to an RCTU will continue to play for lines and stations that are on hold.

Important! *If the alternate BGM source is not connected to a PEKU, PESU or PSTU, RSTU, RSTU2, or RDSU, assign Slot 11 as data in Program 19. If BGM is connected to circuit 2 of QSTU2 or KSTU2, assign slot 13 as data in Program 19. This ensures that all PSTU or RSTU ports function normally. Digital / electronic telephones or RSIU PCBs installed in Slot 11 are not affected by this assignment.*

PEKU/PESU

If using a PEKU, wire the BGM source to circuit 3 and turn LED 09 ON (Program 10-2) to enable the BGM connection.

If using a PESU, wire the BGM source to circuit 8 and turn LED 10 ON (Program 10-2) to enable the BGM connection.

QSTU2, KSTU2, RSTU, RSTU2, RDSU, or PSTU

If using a QSTU2, KSTU2, RSTU, RSTU2, RDSU, or PSTU, wire the BGM source to circuit 2 and turn LED 09 and 10 OFF (Program 10-2). Also, an isolation transformer may be required if connecting the source these PCBs. See Chapter 10 – Peripheral Installation in the Installation and Maintenance Manual for isolation transformer installation instructions.

PDKU

BGM cannot be connected to the PDKU.

Program 20 – Computer and Data Interface Unit Configuration

Processor Type: DK14, DK40i, All RCTUs

Program Type: Station

Initialized Default: LED 17 ON, all others OFF

* # * # 1 * 2 * 3 - **Spkr** 2 0 **Hold** - **Spkr** # **Hold** - **Spkr** # # **Hold** - **Spkr** # # **Hold**

SELECT = PDKU/PDSU Station Logical Port Number that is connected to PDIU-DS or to DKT with PDIU-DI or RPCI-DI

LED Buttons 01~06 define data port type; LED Buttons 17~20 assign data port to security group.

Processor Type	Port Range
DK14	000~009
DK40i	000~027
RCTUA	000~031

Processor Type	Port Range
RCTUBA/BB	000~079
RCTUC/D	000~239
RCTUE/F	000~335

DK40i Base, PDKU, RDSU, KCDU Digital Port Number

LED	X	LED ON	LED OFF
20		Data Security Group 4	Not Included
19		Data Security Group 2	Not Included
18		Data Security Group 3	Not Included
17		Data Security Group 1	Not Included
12~16	Not Used		
11		RPCI-DI DNIS Sent	RPCI-DI DNIS Not Sent
10		RPCI-DI Caller ID/ANI Sent	RPCI-DI Caller ID/ANI Not Sent
07~09	Not Used		
06		DTR Pulse with Data Release	No DTR Pulse
05		Auto Pause Behind PBX	No Auto Pause
04		PDIU-DS Connected	PDIU-DI/RPCI-DI Connected
03		PDIU-DS to Modem Connection	PDIU-DS to other type DCE or DTE
02		AT Commands and Result Codes	AT Commands Only
01		PDIU-DS or RPCI Connected	No PDIU-DS or RPCI Connected

Program 20 Overview

Program 20 identifies the digital station ports connected to RPCI/PDIU and the type of PDIU connected.

RPCIs have two modes: the Data Switching (DIU mode) and the Application Program Interface (or TAPI) mode. In the DIU mode, the RPCI operates as a PDIU-DI (Integrated Data Interface Unit); all Program 20 options apply except LED 10 and LED 11 - which only apply to the RPCI in TAPI mode. In TAPI mode the RPCI does not require Program 20 assignments, except for LED 10 and/or LED 11 if ANI, DNIS, and/or Caller ID must be sent from the RPCI-DI to the PC to which it is connected.

Notes

- RPCIs and PDIUs cannot be connected to PDKU1 circuit 8, but can be connected to all eight PDKU2 circuits. RPCIs and PDIUs that support data switching cannot be connected to PDKU in all slots. See DK424 Chapter 4 – DK424 Configuration, Tables 4-4 and 4-5. DK40i slots 17 and 18 do not support data switching.

- If a PC is connected to the RPCI or PDIU, set the communication mode escape sequences in the PC communication software “Modem Initialization” character sequence. This ensures the escape sequence is restored in case the RPCI Telephone or PDIU is unplugged temporarily.
- RPCI and PDIU-DS units that mostly do data switching, can be connected to ports associated with PDKU1 circuits 1~7 only. All PDKU2 circuits, 1~8, support RPCIs and PDIUs. RDSU digital circuits 5~8 support RPCI and PDIUs.
- Each PDIU-DS requires a separate digital port.
- If a PDIU-DS (Stand-alone Data Interface Unit) is connected to a modem, refer to Modem Setup Recommendations in the PC/Data Communication section of Chapter 10 – Peripheral Installation of the Installation and Maintenance Manual.
- See Chapter 10 – Peripheral Installation for additional hardware information and Chapter 2 – DK40i Configuration and Chapter 4 – DK424 Configuration to identify which slots can support RPCIs and DIUs.

Typical LED Settings for Program 20

RPCI-DI/PDIU-DI Connected to a terminal or personal computer—LEDs 01, 02, 05, and 17 ON; all other LEDs OFF.

PDIU-DS Connected to a Printer: LEDs 01, 04, and 17 ON; all other LEDs OFF.

PDIU-DS Connected to a Modem: LEDs 01, 02, 03, 04, and 17 ON; all other LEDs OFF.

LEDs 17~20: Data Security Groups

Data security groups can be set to block data calls between RPCI/DIUs. RPCI/DIUs can only make data calls to RPCI/DIUs in the same security group. LEDs 17~20 assign the RPCI/DIU to the appropriate security group: light LED 17 for Group 1; LED 18, for Group 3; LED 19, for Group 2; and LED 20, for Group 4. If an RPCI-DI is used in the Application Program Interface (TAPI) mode only, and not the Data Switching mode, this option is not applicable.

LEDs 12~16

Not used at this time.

LED 11: RPCI-DI DNIS to PC Option

DNIS Number or NAME tag information that is sent to a telephone can be sent, or blocked, from the telephone’s RPCI-DI, RS-232 output. If DNIS information should be sent from the Telephone’s RPCI-DI to the Personal Computer to which it is connected, turn LED 11 ON; if this information should not be sent to the PC, turn LED 11 OFF.

LED 10: RPCI-DI Caller ID and ANI to PC Option

Caller ID and ANI information that is sent to a telephone can be sent, or blocked, from the telephone’s RPCI-DI, RS-232 output. If Caller ID and ANI information should be sent from the RPCI-DI to the Personal Computer to which it is connected, turn LED 10 ON; if this information should not be sent to the PC, turn LED 10 OFF. This option does not apply to PDIUs because they can not send ANI, Caller ID, or DNIS numbers.

LEDs 07~09

Not used at this time.

LED 06: DTR Pulse

LED 06 should always be OFF.

LED 06 should be off for all PDIU-DS, RPCI-DIs, or PDIU-DIs. (Refer to Chapter 10 – Peripheral Installation for more PDIU-DS/modem pool information).

LED 05: Auto Pause Behind PBX

Turn LED 05 ON to enable Auto Pause Behind PBX. This inserts the Auto Pause after a Centrex or PBX access code is dialed by a DIU or RPCI. A CO line must be assigned in Program 42-0, and must have an access code assigned in Program 42 (1~8). Pause time is determined by Program 12-3. Also, when Auto Pause Behind PBX is enabled, the Auto Pause is inserted after the CO line access code is dialed (by the DIU).

If the system CO lines are connected to a PBX, Centrex, or a Central Office that is slow to return dial tone after seizure, enable Auto Pause Behind PBX to insert a pause before and after the PBX or Centrex access code is dialed by the DIU or RPCI. Also, light LED 05 to automatically insert a pause before network telephone numbers are autodialed by DIUs or RPCIs.

LED 04: PDIU-DS or PDIU-DI/RPCI-DI Connection

Set LED 04 ON if a PDIU-DS is connected to the digital port.

Important! *If LED 04 is turned on for a telephone port, that telephone cannot be called.*

Set LED 04 OFF if a PDIU-DI or RPCI-DI or any type of telephone is connected. In this case, the digital telephone supporting this PCB may require the Data Call (DATA), Data Release (DRLS), and/or Modem buttons assigned in Program 39. Also, if an RPCI-DI is used in the Application Program Interface (TAPI) mode only, and not the Data Switching mode, set LED 04 OFF.

Note The pause length is set in Program 12-3, and lines behind PBX/Centrex are assigned in Programs 42-0 and 42-1~8.

LED 03: RPCI/PDIU-DS to Modem Connection

If a PDIU-DS is connected to the digital port, identify whether the RPCI/PDIU-DS is connected to a modem (LED 03 ON) or not connected to a modem (LED 03 OFF). If not connected to a modem, the connected device can be a DCE or DTE. This feature is not necessary for RPCI/PDIU-DIs, because they are not normally connected to modems.

LED 02: AT Commands and Result Codes

Enable this feature (LED 02 ON) if the RPCI or DIU must respond to AT commands and return result codes in the Data Switching command mode. RPCI/DIU “AT” dialing commands and “result” codes are listed in the RPCI-DI and the Data Interface User Guide.

If the DIU is connected to a modem, LED 02 should be ON. If the RPCI/DIU is connected to a printer, LED 02 should be OFF. If an RPCI-DI is used in the Application Program Interface (TAPI) mode only, and not the Data Switching mode, this option is not applicable.

If the feature is not enabled (LED 02 OFF), the RPCI/DIU only responds to AT dialing commands (ATDT, ATD, and ATDD) and does not return result codes. If the DIU is connected to a terminal or a personal computer with communication software, LED 02 should be ON

LED 01: RPCI and PDIU Connection

Enable this feature (LED 01 ON) if there is a PDIU-DI, RPCI-DI or PDIU-DS connected to the digital port. Each RPCI-DI or PDIU-DI uses the same digital port as the telephone it is attached to. This feature is not applicable if an RPCI-DI is used only in TAPI, and not DIU mode.

Program 21 – Modem Pool Port Assignments

Processor Type: DK14, DK40i, All RCTUs

Program Type: Station

Initialized Default: Blank

* # * # 1 * 2 * 3 - Spkr 2 1 Hold - Spkr [] [] # [] [] Hold - Spkr # # Hold - Spkr # # Hold

Digital Station Logical Port
Number (see notes below)

Standard Telephone Modem Port
Number (see notes below)

Processor Type	Port Range
DK14	008-009
DK40i	008-027
RCTUA	008-031

Processor Type	Port Range
RCTUBA/BB	008-079
RCTUC/D	008-239
RCTUE/F	008-335

	Logical Port No.		
Assignment 1			
Assignment 2			
Assignment 3			
Assignment 4			
Assignment 5			
Assignment 6			
Assignment 7			
Assignment 8			
Assignment 9			
Assignment 10			

Modem Port No.	

Notes

- Digital Ports include: DK14 KSU, DK40i Base KSU, QCDU2, KCDU, PDKU2, and RDSU digital ports.
- Standard telephone ports include: QSTU2, KSTU2, RSTU2, RDSU, PSTU, and PESU standard telephone ports.

Program 21 Overview

This program assigns modems to the system modem pool. Program 21 identifies modems connected to standard telephone ports (line side of modem) and digital/PDIU-DS ports (RS-232 side of modem). With data security groups (Program 20, LEDs 17~20) and the call blocking feature (Program 31, LED 04), modem access can be denied or allowed to data users.

Notes

- PDIU-DS must be installed on PDKUs in slots designated for DIU operation. (See Chapter 2 – DK40i Configuration and Chapter 4 – DK424 Configuration.)
- When modems are connected to standard telephone ports (PSTU, RSTU, RSTU2, PESU, RDSU/RSTS, KSTU2, QSTU2) the Executive/ Privacy Override blocking feature (Program 31, LED 18) should be enabled for the modem RSTU, RSTU2, PSTU, PESU, RDSU, KSTU2 and QSTU2 ports for data security. The LED 18 feature should be disabled to enable callers to switch from voice to data, or vice versa.
- Digital telephones with RCPI-DIs or PDIU-DIs that must access modems from a pool require a **Modem** button assigned in Program 39.
- PDIU-DS ports that are connected to modems in the modem pool should be set with LEDs 01, 02, 03, and 04 in Program 20.
- If a modem connected to PDIU-DS is connected to a telephone network line instead of a standard telephone station port, Program 21 should not be used.
- Use Program 22 to assign modem/PDIU-DS stations to hunt sequences.
- DIUs can be connected to any ports associated with PDKU circuits, except for ports associated with circuit 8 on a PDKU1. All PDKU2, KCDU, and QCDU circuits can support DIUs. DIUs can also be connected to any digital circuit in the DK14 or DK40i KSU.
- DIUs can be connected to ports associated with PDKU1 circuits 1~7 only. All PDKU2 circuits, 1~8, can support RPCI/DIUs. RDSU circuits 5~8 can support RPCI/DIUs.

Program 22 – RPCI and DIU Station Hunting for Data Calls

Processor Type: DK14, DK40i, All RCTU's

Program Type: Station

Initialized Default: Does not assign "hunt-to" ports to any port

* # * # 1 * 2 * 3 - Spkr 2 2 Hold - Spkr [] [] # [] [] Hold - Spkr # # Hold - Spkr # # Hold

SELECT = Port Number (see legend below) _____ HUNT TO = (see legend below)

Enter the RPCI/DIU digital port number of the "hunt-from" station.

Enter the "hunt-to" RPCI/DIU digital port number.

Enter the port number(s) to which class of service must be assigned.
To add a port range, enter XXX*XXX (low port * high port).

LED Button 01 deletes a digit from the "hunt-to" port.

Processor Type	Port Range
DK14	000-007
DK40i	000-027
RCTUA	000-031

Processor Type	Port Range
RCTUBA/BB	000-079
RCTUC/D	000-239
RCTUE/F	000-335

Hunt From Port	Hunt To Port	Hunt From Port	Hunt To Port	Hunt From Port	Hunt To Port	Hunt From Port	Hunt To Port

Program 22 Overview

This program assigns computer and Data Interface Unit (DIU) station hunt ports for data calls. If a RPCI/PDIU station (printer, modem, etc.) is busy, data station hunting allows the data call to hunt to an alternate RPCI/PDIU station assigned in this program. If the hunted RPCI/PDIU station is busy, the system will ring the next "hunt-to" station, and so on. If all RPCI/PDIU stations in the "hunt-to" sequence are busy, then the data caller will receive a busy tone. Toshiba recommends that all PDIU-DS station ports grouped in a modem pooling or printer pooling/server configuration be placed into a hunt-sequence arrangement with Program 22.

Notes

- Program 22 applies to RCPI-DI, PDIU-DI and PDIU-DS data calls, not telephone station voice calls. If programming an RCPI-DI or PDIU-DI station, use the associated DKT logical port number; the PDIU-DS is programmed using its own unique port number.
- When a PDIU-DS is connected to a modem(s) assigned to the system modem pool in Program 21, modem hunting is automatic when the user presses the **Data Call** button to transfer a line call to a modem. However, if the user dials the modem's PDIU-DS's station number, modem hunting follows the hunt sequence specified in Program 22.

Program 23 – Built-in Auto Attendant (AA) Primary Announcement Assignments

Processor Type: DK14, DK40i, All RCTUs

Program Type: System

Initialized Default: No ports assigned

##1*2*3 - Spkr 2 3 Hold - Spkr Hold - Spkr ## Hold

SELECT = 1-4 AUTO ATT 1 NO. = Port

Select the Auto Attendant device (digital announcer).

Enter the standard station logical port number to which the device will be assigned.

Processor Type	Port Range	Processor Type	Port Range
DK14	008-009	RCTUBA/BB	008-079
DK40i	008-027	RCTUC/D	008-239
RCTUA	008-031	RCTUE/F	008-335

Announcement Device	Port Number
1	
2	
3	
4	

Program 24 – Built-in AA Secondary Announcement Assignments

Processor Type: DK14, DK40i, All RCTUs

Program Type: System

Initialized Default: No ports assigned

##1*2*3 - Spkr 2 4 Hold - Spkr Hold - Spkr ## Hold

SELECT = 1-4 AUTO ATT 2 NO. = Port

Select the Auto Attendant device (digital announcer).

Enter the standard station logical port number to which the device will be assigned.

Note See Program 23 legend for port ranges.

Announcement Device	Port Number
1	
2	
3	
4	

Programs 23 and 24 Overview

Programs 23 and 24 assign customer-supplied Auto Attendant announcement devices (digital announcers) to standard telephone ports (QSTU2, KSTU2, RSTU, RSTU2, PSTU, PESU, RDSU/RSTS). Use Program 23 to assign devices that deliver primary announcements, dialing options and greetings heard when callers first call in; also, devices that deliver secondary announcements.

Use Program 24 to offer options to unanswered calls routed back to the Auto Attendant. Up to eight devices can be connected to a system. See Primary and secondary announcements below:

Processor Type	Primary Announcements	Secondary Announcements	Processor Type	Primary Announcements	Secondary Announcements
DK14	1	1	RCTUBA/BB	4	4
DK40i	4	4	RCTUC/D	4	4
RCTUA, RCTUB	4	4	RCTUE/F	4	4

Any combination is allowed within the maximum limitations. For example, three primary announcements and one secondary announcement are allowed.

Ports assigned in Programs 23 and 24 should never be assigned with External Auto Attendant voice mail options in other programs (30, 31, 81~89, etc.)

To allow the built-in Auto Attendant programs to function:

DK424: the RKYS (1, 2, 3, or 4) and RRCS must be installed on the RCTU PCB;

DK40i: the KKYS must be installed on the K5RCU;

DK14: the QKYS, and QRCU3 must be installed in the DK14 KSU.

Overflow stations and delay ring operation is assigned in Programs 81~89.

Program 25-1 – Built-in AA Incoming Call Overflow Time

Processor Type: *DK14, DK40i, All RCTUs*

Program Type: *System*

Initialized Default: *20 seconds before overflow*

##1*2*3 - Spkr 2 5 Hold - Spkr 1 Hold - Spkr # # Hold - Spkr # # Hold

SELECT = 1 AATT TIME = Seconds before overflowing

Enter the number of seconds, 12~24.

Program 25-1 Overview

This program sets the time it takes an unanswered incoming Auto Attendant call to overflow to a preassigned station(s). The time can be anywhere from 12 to 24 seconds—the default is 20 seconds. The overflow station or group of stations is assigned in Programs 81~89.

This overflow time applies to the overflow of incoming Auto Attendant calls to normal CO line ringing if either a primary announcement device or K5RCU, K5RCU2, K4RCU3/RRCS (DTMF) circuit is not available.

Note Auto Attendant will not answer when all of the RRCS, K5RCU, K5RCU2, K4RCU3 or QRCU2 circuits or primary announcements are busy.

Program 26 – Built-in AA Camp-on Busy Time

Processor Type: DK14, DK40i, All RCTUs

Program Type: Station

Initialized Default: Assigns an AA Camp-on-Busy Time of 016 seconds to all ports

***#*#1*2*3 - Spkr 2 6 Hold - Spkr [] [] # [] [] Hold - Spkr # # Hold - Spkr # # Hold**

SELECT = Port Number

CAMP-ON TIME = AA Camp-on-Busy Time

Enter the number of the called Station Logical port that needs a Camp-on Busy time assigned.

Enter the time in seconds (1~3 digits). The range is 011~999 seconds (16.65 minutes).

To add a port range, enter XXX*XXX (low port * high port).

Processor Type	[PDN] Port Range
DK14	000~009
DK40i	000~027
RCTUA	000~031

Processor Type	[PDN] Port Range
RCTUBA/BB	000~079
RCTUC/D	000~239
RCTUE/F	000~335

Port	Camp-on Time

Port	Camp-on Time

Port	Camp-on Time

Port	Camp-on Time

System & Station

Program 26 Overview

Note This program only applies to Auto Attendant (built-in) calls to busy or ringing stations; it does not apply to ring transfer camp-on time from stations or customer-supplied Auto Attendant devices; see Program 37 Ring Transfer (Camp-on) recall time.

This program establishes the time it takes for unanswered Auto Attendant calls camped-on to busy or ringing [DNs] to be routed to other destinations. The time, which is set for the “camped-on to station”, can be set from 011 seconds to 999 seconds. Ring/No Answer call time to idle stations is fixed at 16 seconds unless Call Forward/No Answer is set at the called station.

The destination that the call can be rerouted to depends on the Auto Attendant application. In Auto Attendant applications that use just primary announcement devices, the destination is set in Program 10-3, and can be either back to the primary announcement or the normal ringing pattern of the line that the call came in on (Programs 81, 84, or 87 for telephone ringing and *81, *82, *83 for [DN] flash. Also see Program 10-3, LEDs 15 and 16 for disconnect time options. In applications that use secondary announcement devices in addition to primary ones, the rerouted calls are automatically sent to secondary announcement devices.

This program timer sets the time that Auto Attendant calls to a busy or ringing station will camp-on before routing back to a primary announcement or to the calling CO line’s normal ring pattern. (See Program 10-3, LED 3 for routing option after Camp-on-Busy). The time set in this program applies to the called station.

If CF-NA or CF-B/NA is set on a Telephone, the CF-N/A ring timer will have priority over this 16-sec. camp-on-busy timer so the telephone will ring for the duration of the CF-NA timer. Auto Attendant calls to a ring-no-answer or busy station will only forward to one destination, if the CF destination station has call forward set, the call will camp-on for 16-seconds and then route per the Auto Attendant flow diagram—the call will not forward a second time to another destination.

Program 28 – DSS Console/Attendant Telephone Assignments

Processor Type: DK40i, All RCTUs

Program Type: Station

Initialized Default: Assigns Console #1 to Attendant Telephone #1;
Console #2 to Attendant Telephone #2; etc.

* # * # 1 * 2 * 3 - Spkr 2 8 Hold - Spkr Hold - Spkr # # Hold - Spkr # # Hold

SELECT = 1~8 _____ DSS ATT = 1~8

Enter the DSS console number.

Enter the attendant digital or electronic telephone number.

Digital DSS consoles (DDSS) should be assigned to digital telephones, and electronic consoles (HDSS) should be assigned to electronic telephones.

Processor	DSS Consoles	HDSS Consoles
DK14	0	0
DK40i	1-3	1-3
RCTUA	1-3	1-3
RCTUBA/BB	1-4	1-4
RCTUC/D	1-8	1-8
RCTUE/F	1-8	1-8

DDSS PDKU/HDSS PEKU PCBs (Lowest to Highest)	DDSS/HDSS Console Number	Attendant DKT/EKT Number (1~8)
Low Slot Number:	1	
Slot Number:	2	
Slot Number:	3	
Slot Number:	4	
Slot Number:	5	
Slot Number:	6	
Slot Number:	7	
High Slot Number:	8	

Program 28 Overview

- DK40i:** allows up to three DSS consoles (DK40i KSU supports one DSS, Expansion Unit supports two more). A DDSS console can only be connected to circuit 8 of the DK40i base digital ports or a PDKU, and an HDSS console can only be connected to circuits 7 and 8 of a PEKU.
- ♦ **DK424:** supports up to eight DDSS consoles, or eight HDSS consoles, or any combination of the two types of consoles up to eight may be installed with an RCTUC/D or RCTUE/F common control unit. The RCTUA and DK40i can support three DSS consoles, the RCTUB, RCTUBA/BB can support four, and the RCTUC/D and RCTUE/F support eight.

The telephone connected to circuit 1 of the PCB or the DK40i Base KSU supporting a console is designated as an attendant telephone. Consoles and telephones are numbered 1~8 as they are installed from the lowest to highest slot number. For example, in DK424, if a PDKU in Slot 11 had a DDSS console connected to it, the DDSS console would be Console #1 and the digital telephone connected to circuit 1 would be Attendant Telephone #1.

As many as four DSS consoles can be assigned to one attendant telephone. Because more than one DSS console can be assigned to an attendant telephone, the detailed arrangement must be programmed. Initialized data assigns one DSS console to one attendant telephone, both connected to the same PDKU or PEKU PCB.

Notes

- Refer to Program 03—Flexible PCB Slot Assignments, for the PCB slots of PEKUs and PDKUs configured to support consoles.
- The system automatically assigns the console supported by the PEKU or PDKU in the lowest-number PCB slot to be console number 1.
- The system automatically assigns the telephone connected to the first station port on a console PDKU or PEKU to be attendant number 1.
- If more than one console is associated with one attendant telephone, then specify the same number attendant telephone for all consoles associated with it.

Program 29-1~8 – DSS Console and Number Button Assignments

Processor Type: DK40i, All RCTUs

Program Type: Station

Initialized Default: See "Program 29 - Initialized Default DSS Console Button Assignments" on Page 3-72



SELECT = DDSS/HDSS console number 1~8

DDSS/HDSS LED Button Group 1~3
Each console has three groups of 20 LED buttons.

DKT LEDs 01~20
Press the DKT LED that is in the same position as the console button being assigned. The LED lights and the LCD displays the console button's number.

CODE =
Assign Speed Dial, trunk access, or DSS access to this button chosen. See code table below.

The **Night Transfer** and **All Call Page** buttons may be changed to **DSS, Line (CO)** or **SD** buttons, but they may not be reassigned to other button locations.

Initialized key assignments are shown following the Program 29 System Record Sheets.

Code Table and Legend

Button Type	Code
All Call	489
Night Transfer 1	439
Night Transfer 2	440
Night Transfer 3	441
Night Transfer 4	442

Processor	Personal Speed Dial Bin Numbers	System Speed Dial Bin Numbers	CO Line Range	DSS Button Range
DK40i	* 10~ * 49	* 60~ * 99	001~012	#000~#027
RCTUA	* 10~ * 49	* 60~ * 99	001~016	#000~#031
RCTUBA/BB	* 10~ * 49	* 600~ * 699	001~048	#000~#079
RCTUC/D	* 10~ * 49	* 600~ * 699	001~144	#000~#239
RCTUE/F	* 100~ * 139	* 200~ * 999	001~200	#000~#335

Console Number _____

Group Number 1	
Button/Code	Button/Code
10	20
09	19
08	18
07	17
06	16
05	15
04	14
03	13
02	12
01	11

Group Number 2	
Button/Code	Button/Code
10	20
09	19
08	18
07	17
06	16
05	15
04	14
03	13
02	12
01	11

Group Number 3	
Button/Code	Button/Code
10	20
09	19
08	18
07	17
06	16
05	15
04	14
03	13
02	12
01	11

Program 29-1~8 Overview

Each button on the DSS consoles can be flexibly assigned as either a Direct Station Selection (**DSS**), Line (**CO**), or **SD** button. The standard equipped **Night Transfer (NT)**, and **All Call Page (AC)** buttons may be changed to one of these three types, but not vice versa.

Station Speed Dial buttons assigned to a DSS console share the associated attendant digital or electronic telephone's Speed Dial memory. The personal Speed Dial numbers of the DSS console circuit port(s) are not available. Initialized data assigns the 60 buttons to be Direct Station Selection (**DSS**), **All Call Page (AC)**, and **Night Transfer (NT)**. Each of the consoles can be independently programmed.

Important! *Only program the following buttons: **SD**, **Line (CO)**, **DSS**, **All Call Page (AC)**, and **Night Transfer (NT)**; programming other feature buttons on a console may cause system operation problems.*

It is not possible to assign [PDNs]/[SDNs]/[PhDNs] to DSS consoles or ADMs

Note When assigning CO line access buttons (001~200), the associated telephone must be assigned access to the CO line also. See Program 40.

Program 29 - Initialized Default DSS Console Button Assignments

Group 1

DSS Button No.	DK40i	RCTUA	RCTUB RCTUC/D RCTUE/F
01	#000	#000	#000
02	#001	#001	#001
03	#002	#002	#002
04	#003	#003	#003
05	#004	#004	#004
06	#005	#005	#005
07	#006	#006	#006
08	#007	#007	#007
09	#008	#008	#008
10	#009	#009	#009
11	#010	#010	#010
12	#011	#011	#011
13	#012	#012	#012
14	#013	#013	#013
15	#014	#014	#014
16	#015	#015	#015
17	#016	#016	#016
18	#017	#017	#017
19	#018	#018	#018
20	#019	#019	#019

Group 2

DSS Button No	DK40i	RCTUA	RCTUB RCTUC/D RCTUE/F
01	#020	#020	#020
02	#021	#021	#021
03	#022	#022	#022
04	#023	#023	#023
05	#024	#024	#024
06	#025	#025	#025
07	#026	#026	#026
08	#027	#027	#027
09	* 10	#028	#028
10	* 11	#029	#029
11	* 12	#030	#030
12	* 13	#031	#031
13	* 14	* 10	#032
14	* 15	* 11	#033
15	* 16	* 12	#034
16	* 17	* 13	#035
17	* 18	* 14	#036
18	* 19	* 15	#037
19	* 20	* 16	#038
20	* 21	* 17	#039

Group 3

DSS Button No	DK40i	RCTUA	RCTUB RCTUC/D RCTUE/F
01	* 22	* 18	#040
02	* 23	* 19	#041
03	* 24	* 20	#042
04	* 25	* 21	#043
05	* 26	* 22	#044
06	* 27	* 23	#045
07	* 28	* 24	#046
08	* 29	* 25	#047
09	* 30	* 26	#048
10	* 31	* 27	#049
11	* 32	* 28	#050
12	* 33	* 29	#051
13	* 34	* 30	#052
14	* 35	* 31	#053
15	* 36	* 32	#054
16	* 37	* 33	#055
17	* 38	* 34	#056
18	* 39	* 35	#057
19	AC (489)	AC (489)	AC (489)
20	NT 1 (439)	NT 1 (439)	NT 1 (439)

Program *29 – Add-on Modules Button Assignments

Processor Type: DK14, DK40i, All RCTUs

Program Type: Station

Initialized Default: See “Program 29 - Add-on Modules Button Assignments” on Page 3-74

* # * # 1 * 2 * 3 - Spkr * 2 9 Hold - Spkr [] [] [] [] [] [] Hold - Spkr # # Hold - Spkr # # Hold

Enter the station logical port of the telephone which will have buttons assigned to its attached Add-on.

CODE= See the Code Table below.

Enter the Add-on Module which will have buttons assigned to it (0, 1, or 2). Enter 0 when removing ADMs.

LED 01~20 Press the LED that is in the same position as the Add-on Module button being assigned.

Processor	Personal Speed Dial Bin Numbers	System Speed Dial Bin Numbers	CO Line Range	DSS Button Range
DK14	* 10~* 49	* 60~* 99	001~004	#000~#009
DK40i	* 10~* 49	* 60~* 99	001~008	#000~#027
RCTUA	* 10~* 49	* 60~* 99	001~016	#000~#031
RCTUBA/BB	* 10~* 49	* 600~* 699	001~048	#000~#079
RCTUC/D	* 10~* 49	* 600~* 699	001~144	#000~#239
RCTUE/F	* 100~* 139	* 200~* 999	001~200	#000~#335

Port _____

Add-on Module 1				Add-on Module 2			
Button	Code	Button	Code	Button	Code	Button	Code
10		20		10		20	
09		19		09		19	
08		18		08		18	
07		17		07		17	
06		16		06		16	
05		15		05		15	
04		14		04		14	
03		13		03		13	
02		12		02		12	
01		11		01		11	

Port _____

Add-on Module 1				Add-on Module 2			
Button	Code	Button	Code	Button	Code	Button	Code
10		20		10		20	
09		19		09		19	
08		18		08		18	
07		17		07		17	
06		16		06		16	
05		15		05		15	
04		14		04		14	
03		13		03		13	
02		12		02		12	
01		11		01		11	

Processor	ADMs	Number of System Speed Dial Numbers	Number of Personal Speed Dial Numbers
DK14	8	40	40
DK40i	12	40	40
RCTUA	12	40	40
RCTUBA/BB	40	100	40
RCTUC/D	120	100	40
RCTUE/F	200	800	40

Program *29 Overview

This program allows ADM buttons to be customized. Each ADM button can be programmed as either a Direct Station Selection, CO line, System Speed Dial or Personal Speed Dial buttons. Only 2000-series Digital Telephones can connect with ADMs, and up to two ADMs can be connected to a telephone.

System & Station

Program *29 – Add-on Modules Button Assignments

Important! Run this program for each station that has an ADM or the ADM will not function.
Program at least one ADM key for each ADM.

It is impossible to assign [PDNs], [SDNs] or [PhDNs] to DSS consoles or ADMs.

Button Assignments

Add-on Module 1 Button No.	DK14	DK40i	RCTUA	RCTUB RCTUC/D RCTUE/F
01	#000	#000	#000	#000
02	#001	#001	#001	#001
03	#002	#002	#002	#002
04	#003	#003	#003	#003
05	#004	#004	#004	#004
06	#005	#005	#005	#005
07	#006	#006	#006	#006
08	#007	#007	#007	#007
09	#008	#008	#008	#008
10	#009	#009	#009	#009
11	*10	#010	#010	#010
12	*11	#011	#011	#011
13	*12	#012	#012	#012
14	*13	#013	#013	#013
15	*14	#014	#014	#014
16	*15	#015	#015	#015
17	*16	#016	#016	#016
18	*17	#017	#017	#017
19	*18	#018	#018	#018
20	*19	#019	#019	#019

Add-on Module 2 Button No.	DK14	DK40i	RCTUA	RCTUB RCTUC/D RCTUE/F
01	*20	#020	#020	#020
02	*21	#021	#021	#021
03	*22	#022	#022	#022
04	*23	#023	#023	#023
05	*24	#024	#024	#024
06	*25	#025	#025	#025
07	*26	#026	#026	#026
08	*27	#027	#027	#027
09	*28	*10	#028	#028
10	*29	*11	#029	#029
11	*30	*12	#030	#030
12	*31	*13	#031	#031
13	*32	*14	*10	#032
14	*33	*15	*11	#033
15	*34	*16	*12	#034
16	*35	*17	*13	#035
17	*36	*18	*14	#036
18	*38	*19	*15	#037
19	*39	*20	*16	#038
20	*40	*21	*17	#039

Program 30 – Station Class of Service

Processor Type: DK14, DK40i, All RCTUs

Program Type: Station

Initialized Default: LEDs 01, 05 and 07 for all ports

* # * # 1 * 2 * 3 - Spkr 3 0 Hold - Spkr [] [] [] # [] [] Hold - Spkr # # Hold - Spkr # # Hold

SELECT = Station Logical Port Number(s)

Enter the port numbers to which class of service must be assigned. To add a port range, enter XXX*XXX (low port * high port).

Light LEDs for the port specified in the last step. All LEDs marked with an "X" in the table below should be lit.

Processor Type	Port Range	DISA Port
DK14	000-009	010
DK40i	000-027	035
RCTUA	000-031	039

Processor Type	Port Range	DISA Port
RCTUBA/BB	000-079	089
RCTUC/D	000-239	249
RCTUE/F	000-335	344

Feature	LED	Port									
SLT/ISDN Terminal "#" Dial	20										
Privacy Override	19										
Executive Override	18										
DND Override	17										
Change TR Traveling Class Code	16										
Change Verified Account Code	15										
Verified Account Codes	14										
	13										
SLT-Hook Flash Anti-Bounce Guard	12										
Dial Pulse - DTMF OFF	11										
Change DISA Security Code	10										
Change TR Override Code	09										
Forced Account Code	08										
OCA Automatic (originating OCA)	07										
ABR Access	06										
Speed Dial Allowed	05										
#5#30 Pickup AC Page Only (Release 3.2 and higher)	04										
Microphone Button on at Start of Call	03										
MIC Button Locked	02										
Speakerphone	01										

System & Station

Program 30 Overview

Program 30 enables or disables features for individual telephones at the station level. The following text describes Program 30 LEDs.

LED 20: SLT/ISDN Terminal “#” Dial

This feature applies to single-line telephones and ISDN station terminals to indicate when a number has been dialed and to begin dialing a sub-address. If a **#** is dialed as the first digit, it indicates that a feature access code is being entered.

For ISDN, if separate dialing and sub-address digits will be used, turn LED 20 ON. If it is OFF, **#** can be used as a dialing separator.

LED 19: Privacy Override

With Privacy Override enabled (LED 19 ON), a station can override calls and listen to a CO line conversation by pressing a common CO **Line** button (not a [DN] button). [DN] buttons are always private. A maximum of two stations can override an existing “station-line” conversation. You can set a warning tone for Privacy Override (see Program 10-2).

Privacy Override of Direct Inward System Access (DISA) Two-CO line calls is not allowed. Privacy Override is not available on any call (CO line or internal) that appears on a [PDN], [SDN], or [PhDN] button.

Block Privacy Override by a station via a **Privacy** button (Program 39) or with the Executive/Privacy Override blocking option (Program 31, LED 18). To configure the Strata DK system to operate as nonprivate, allow Privacy Override from all stations.

Disabling Privacy Override for attendant console ports does not deny Attendant Supervised Loop Monitoring.

LED 18: Executive Override

With Executive Override enabled (LED 18 ON) a station can break into and overhear an existing station conversation by pressing **3** after the busy station number or by pressing the “EXEOVR” LCD soft key. You can set a warning tone for this feature (see Program 10-2).

Privacy Override can be performed from stations with Executive/Privacy Override blocking enabled in Program 31, LED 18. The **Privacy** button does not block Executive Override. Disabling Executive Override for attendant console ports does not deny Attendant Supervised Loop Monitoring.

LED 17: Do Not Disturb (DND) Override

With DND Override enabled, (LED 17 ON), you can override a station that has DND ON. A called station with DND activated will return very fast busy tone (four tones per second). If the caller presses **2** after dialing the DND station directory number, a DND Override tone is heard on the called station’s speaker.

If a DND station has more than one [PDN] and it appears on other telephones, when called, the [PDN] rings at the other telephones and flashes on the DND station. In this case, DND override is not available unless all [PDNs] of the DND station are busy.

LED 16: Change Toll Restriction Traveling Class Code

When LED 16 is ON for a port, the station occupying it can change the four-digit Toll Restriction Traveling Class of Service Codes established in Program 44-1~8. Stations selected for this feature must follow the dialing sequences below to change the codes:

Class 1	#691	Class 5	#695
Class 2	#692	Class 6	#696
Class 3	#693	Class 7	#697
Class 4	#694	Class 8	#698

[PDN] + class code (**#691~#698**) + four-digit code + **Redial**

LED 15: Change Verified Account Code

With LED 15 ON, a station can change the Verified Account Codes established in Program 69. Selected stations must dial the following sequence to change the codes:

[PDN] + **#659** + Verified Account Code + Redial:

System	Verified Account Code
RCTUE/F	000~499
RCTUA, BA/BB, C/D, DK40i, DK14	000~299

Press **#** button if your electronic telephone does not have a **Redial** button.

Total Account Code digit length is set in Program 10-4 (up to 15 digits). All digits do not have to be verified.

LED 14: Verified Account Code

With LED 14 ON, the system verifies all Forced or Voluntary Account Codes (set in Program 69) dialed by the station user. If the station user does not dial a specific Verified Account Codes, the call does not execute (Forced), or the Account Code is not validated for the SMDR call report (Voluntary).

To force a verified account code entry on Two-CO line DISA calls through the system, turn LED 08 and 14 ON for Port 10-DK14, Port 035-DK40i, Port 039-RCTUA, Port 089-RCTUB, RCTUBA/BB or Port 249-RCTUC/D or Port 344-RCTUE/F. Also, you must enable Forced Account Code for outgoing CO line in Program 15-7.

LED 12: Single Line Telephone (SLT) Hookflash Anti-bounce Guard

SLT Hookflash Anti-Bounce Guard (LED 12 ON) prevents false recalls due to hook flash bounce during SLT hang-up on outside calls. The system automatically disconnects the CO line if the SLT hangs-up after a Hook Flash.

Use for QSTU2, PSTU, RSTU, RSTU2, RDSU, PESU, and KSTU2 standard telephone ports that have standard telephones (with/without message lamps) connected to them to prevent false ring signals. With this option ON, a CO line connected to a standard telephone is disconnected if the standard telephone user hookflashes and then hangs up. If this option is OFF, the CO line recalls the standard telephone.

LED 11: Dial Pulse - Dual-tone Multi-frequency (DTMF) OFF

Use Dial Pulse - DTMF OFF (LED 11 ON) if any device, DID or Tie line station port does not require the RRCS, K5RCU, K5RCU2, or K4RCU for DTMF decoding. When the device goes off-hook or the DID or Tie line is seized for an incoming call, the DTMF receiver is not accessed - reducing unnecessary traffic to it.

If a Tie or DID line is Dial Pulse (Program 15-1, LED ON), enable Dial Pulse - DTMF OFF (LED 11 ON) for that Tie or DID station port number. If the DID or Tie line is DTMF tone dial (Program 15-1, LED OFF) disable Dial Pulse - DTMF OFF (LED 11 OFF) and install an RRCS on the RCTU, K5RCU, K5RCU2, or K4RCU3 in the DK40i.

LED 10: Change DISA Security Code

When enabled (LED 10 ON), allows a selected station to change the DISA security code by dialing [PDN] + **#658**, + Security Code + **Redial**.

LED 09: Change Toll Restriction (TR) Override Code

When enabled (LED 09 ON), two TR Override codes are available. When one of these codes is dialed from any station, all Toll Restriction is bypassed. Change TR Override codes by pressing [PDN] + **#654** for Code 1, or [PDN] + **#655** for Code 2. Press **Redial** to store.

LED 08: Forced Account Code

When enabled, (LED 08 ON), a station or DISA CO line user using a line with a Forced Account requirement (Program 15-7) must enter an Account Code before the outgoing CO/Tie/DID line call can be completed. If Forced Account Codes should be verified, enable Verified Account Code (LED 14 ON). Program 60-4 defines the Forced Account Code digit length.

To force a verified account code entry on Two-CO line DISA calls through the system, (LED 08 and 14 ON: Port 10-DK14, Port 035-DK40i, Port 039-RCTUA, Port 089-RCTUB, RCTUBA/BB, 249-RCTU C/D, and Port 344 for RCTU E/F). Also, enable Forced Account Code for outgoing CO line in Program 15-7.

LED 07: Off-hook Call Announce (OCA) Automatic

When LED 07 is ON, a calling station has this feature enabled. If the system is set for Ring First Signaling (Program 10-1, LED 10 ON), the user must dial **21** after hearing busy tone or **12** after hearing ringback tone in order to OCA the called station. OCA Automatic only works on systems with Voice First Signaling (Program 10-1 or 10-2, LED 01, OFF) in which case the user does not have to dial **21** or **12**. Initialized default: ON - all ports. The called station must also be enabled to receive OCA (see Program 31, LED 03).

LED 06: Automatic Busy Redial (ABR) Access

ABR can be enabled (LED 06 ON) or disabled (LED 06 OFF) for each station. The system selects the last line in the originating line group each time ABR is initiated (see also Program 10-1). If you do not enable ABR access here, the ABR soft key does not appear on LCD telephones. ABR operates when calling on ground and loop start lines, but is not functional for DID or Tie line calls. ABR overrides Program 41. Program 41 is normally used with LCR.

For the DK40i, K5RCU, K5RCU2, or K4RCU must be installed; for the DK14, QRCU must be installed to detect busy tone so that ABR will function.

LED 05: Speed Dial

LED 04 enables (ON) or disables (OFF) Station and System Speed Dial. Initialized default: ON - all ports.

LED 04: Call Pickup Code Option

Determines the operation of pickup code **#5#30** in Release 3.2 (and above) software. If LED 04 is ON, **#5#30** only picks up All Call Page and External Page (per Program 10-2, LED 15). If LED 04 is OFF, **#5#30** picks up an internal call ringing on a telephone as a priority or it picks up All Call Page or External Page if no internal calls are ringing. Prior to Release 3.2, **#5#30** picked up ringing calls as priority over All Call Page pickup calls.

LED 03: Microphone Button On at Start of Call

When enabled (LED 03 ON), the microphone and Mic button LED is turned ON at the start of an on-hook speakerphone call. For this feature to work, you must enable the MIC button lock operation (LED 02 ON).

When receiving internal DN calls, the flexible Microphone Cutoff (**Microphn Cut-off**) button (Program 39) can be used to prevent room monitoring and Handsfree Answerback.

LED 02: Mic Button - Locked/Momentary

The **Mic** button turns electronic or digital telephone microphones ON/OFF:

With “Locked” (LED 02 ON), the **Mic** button will be ON or OFF (depending on LED 03) when you begin the call and you can alternately push it ON or OFF. This does not apply to Handset OCA - which is **Mic** push-to-talk only.

With “Momentary” (LED 02 OFF), the **Mic** is always ON at the start of a speakerphone call/ You must continuously press **Mic** to disable the microphone when during a speakerphone call.

LED 01: Speakerphone

Enables (LED 01 ON) or disables (LED 01 OFF) speakerphone operation on any electronic or digital telephone. If disabled, a speakerphone:

- ♦ Can be used as a handsfree electronic or digital telephone.
- ♦ Enables talk back with the receiver on-hook when receiving an internal call.
- ♦ Will not allow you to talk on a call that you place or a call that you answer by pressing a ringing button with the handset on-hook.

Program 30 - Example

Action (press buttons + LED buttons)	LCD Response
1. Use an LCD programming phone per Minimum Hardware Requirements on Page 1-14. Make sure the programming button strip template is installed on the programming telephone.	No. N-N ¹ Jan 20 Sun 06:43
2. ***#1*2*3 Enter programming mode. (Do not press [DN] button.)	Program Mode
3. Spkr (Speaker) 30 Hold Access Program 30.	Program = 30 Data Store
4. Spkr (Speaker) Prepare the system for a station port selection.	30 Select =
5. Enter the port number where the station being defined is connected. Use three digits, followed by a # button. A range of ports may be entered at once by using the * button. (See Note on system record sheet for port numbers.)	30 Select =

System & Station

Program 30 – Station Class of Service

Action (press buttons + LED buttons)	LCD Response
<p>6. LED buttons 01~20</p> <p>LED buttons 01~20 activate features for each station port or port range. Make the following selections by turning the appropriate button LED ON or OFF for each item (01~20) for each port, as marked on the system record sheet:</p> <p>LED 01: Speakerphone Enabled LED 02: Microphone Key Lock Enabled LED 03: Microphone ON at Start of Call LED 04: Not Used LED 05: Speed Dial Allowed LED 06: Automatic Busy Redial Access Enabled LED 07: Automatic Off-hook Call Announce LED 08: Forced Account Code Enabled LED 09: Toll Restriction Override Code Revision Authority</p>	
<p>LED 10: DISA Security Code Change Allowed LED 11: Dial Pulse (DTMF Off) for Standard Telephone LED 14: Account Codes Verified LED 15: Verified Account Code Revision Authority LED 16: Traveling Class of Service Code Revision Authority LED 17: Do Not Disturb Override Allowed LED 18: Executive Override Allowed LED 19: Privacy Override Allowed LED 20: Not Used</p> <p>If programming a port range, the LED indications are as follows:</p> <ul style="list-style-type: none"> ✦ LED-ON, all ports in range are enabled for that item. ✦ LED-OFF, all ports in range are disabled for that item. ✦ LED-FLASHING, some ports in range are enabled and some ports are disabled. 	
<p>7. Hold Secure data in system programming.</p>	<p>30 Select Data Programmed</p>
<p>8. Spkr (Speaker) Prepare system for another selection (go back to Step 5), or exit Program 30 (continue with Step 9).</p>	<p>30 Select =</p>
<p>9. ## Hold Secure Program 30 data in system memory.</p>	<p>30 Select = ## Data Programmed</p>
<p>10. Spkr (Speaker) Exit Program 30. Enter another program number or exit programming mode (go to Step 11). Speaker beeps to indicate it is exiting Program 33.</p>	<p>Program =</p>
<p>11. ## Hold Exit programming mode.</p>	<p style="text-align: right;">No. N-N Jan 20 Sun 06:58</p>

1. N-N = Programming telephone [PDN]

Program *30 – Telephone Group Page Assignments

Processor Type: DK14, DK40i, All RCTUs

Program Type: Station

Initialized Default: All LEDs OFF

* # * # 1 * 2 * 3 - Spkr * 3 0 Hold - Spkr # Hold - Spkr # # Hold - Spkr # # Hold

Enter the station logical port which will be assigned to page a group or groups. To add a port range, enter XXX*XXX (low port * high port).

Press LED Buttons 01~08 to light LEDs for the port specified in the last step. In the table below, "X" all LED Buttons which should be lit.

Processor Type	Port Range	Number of Page Groups
DK14	000~007	4
DK40i	000~027	4
RCTUA	000~031	4

Processor Type	Port Range	Number of Page Groups
RCTUBA/BB	000~079	4
RCTUC/D	000~239	8
RCTUE/F	000~335	8

Feature	LED	Port															
		<input type="checkbox"/>	<input type="checkbox"/>	<input type="checkbox"/>	<input type="checkbox"/>	<input type="checkbox"/>	<input type="checkbox"/>	<input type="checkbox"/>	<input type="checkbox"/>	<input type="checkbox"/>	<input type="checkbox"/>	<input type="checkbox"/>	<input type="checkbox"/>	<input type="checkbox"/>	<input type="checkbox"/>	<input type="checkbox"/>	<input type="checkbox"/>
Page Group H	08																
Page Group G	07																
Page Group F	06																
Page Group E	05																
Page Group D	04																
Page Group C	03																
Page Group B	02																
Page Group A	01																

Shaded groups apply to RCTUC/D and RCTUE/F only.

Program *30 Overview

Digital and electronic telephones can be assigned to “internal telephone speaker” page groups with this program. Each group can have as many as 120 stations. Telephones can be a member of more than one group. Station users can access each group separately by dialing access codes. (See Program 05 for access codes.) The above table shows four or eight page groups. An additional group is the All Call Page Group set in Program 31, LED 10.

Notes

- A maximum of 120 telephones can be assigned to a particular page group.
- Only 120 telephones can be paged simultaneously. Example: If Page Group “A” has 60 telephones, Page Group “B” has 50 telephones, and Page Group “C” has 70 telephones, then Group A + B (60 + 50 = 110) can be paged simultaneously, but Group A + C (60 + 70 = 130) cannot be paged simultaneously.

Program 31 – Station Class of Service

Processor Type: DK14, DK40i, All RCTUs

Program Type: Station

Initialized Default: LED 10 ON for Ports 000~119; LED 11~13 ON for all ports.

##1*2*3 - Spkr 3 1 Hold - Spkr # Hold - Spkr ## Hold - Spkr ## Hold

SELECT = Station Logical Port Number(s)
Enter the port numbers to which class of service must be assigned.

Light LED Buttons for the port specified in the last step. All LED Buttons marked with an "X" in the table below should be lit.

Processor Type	Port Range
DK14	000-009
DK40i	000-027
RCTUA	000-031

Processor Type	Port Range
RCTUBA/BB	000-079
RCTUC/D	000-239
RCTUE/F	000-335

Feature	LED	Port									
Toshiba Stratagy/VP (B + Station No.)	20										
Toshiba Stratagy/VP (B No Station)	19										
Executive & Privacy Override Blocking	18										
End/End Signal Rcv (VM)	17										
Receive VM ID Code	16										
Toshiba Stratagy/VP Integration (A/D)	15										
Handset OCA	14										
Handset OCA Warning Tone	13										
Pooled Line Key - No Flash if No Ring	12										
Busy Override Tone - Continuous	11										
All Call Page Allowed - EKTs/DKTs	10										
VM (No Conference)	09										
VM Group 4 (does not apply to DK14)	08										
VM Group 3 (does not apply to DK14)	07										
VM Group 2	06										
VM Group 1	05										
VM to VM Call Blocking Called/Calling	04										
OCA Enabled (To Receive)	03										
Handsfree No Warning Tone	02										
Handsfree Disabled	01										

Program 31 Overview

Program 31 sets most voice mail or External Auto Attendant port assignments. Each standard telephone port (QSTU2, RSTU2, RSTU, PSTU, PESU, RDSU, KSTU2, QSTU2) connected to a Toshiba Stratagy, Stratagy DK or VP voice mail system should have LEDs 04, 15, 16, 17, 18, 19, and 20, and one of the following: 05, 06, 07, or 08 turned ON. These LED's should be ON for VM ports only, not for telephone ports.

LED 09 should be OFF for VM Auto Attendant “blind” transfer and VM tandem CO line connection with automatic release. LED 09 should be ON for VM Auto Attendant supervised transfer operation.

Example Programming Assignment to Set Up Voice Mail in a Distributed Hunt Group

Program *32	008	VMG1 Message Center
Program 13	010	VMG2 Message Center
Program 31	008 – Button 5 ON 009 – Button 5 ON	VMG1 RSTU VM Ports
	010 – Button 6 ON 011 – Button 6 ON	VMG2 RSTU VM Ports
Program *40	850 – 01 008 850 – 02 009	VMG1 DH Group Members
	851 – 01 010 851 – 02 011	VMG1 DH Group Members

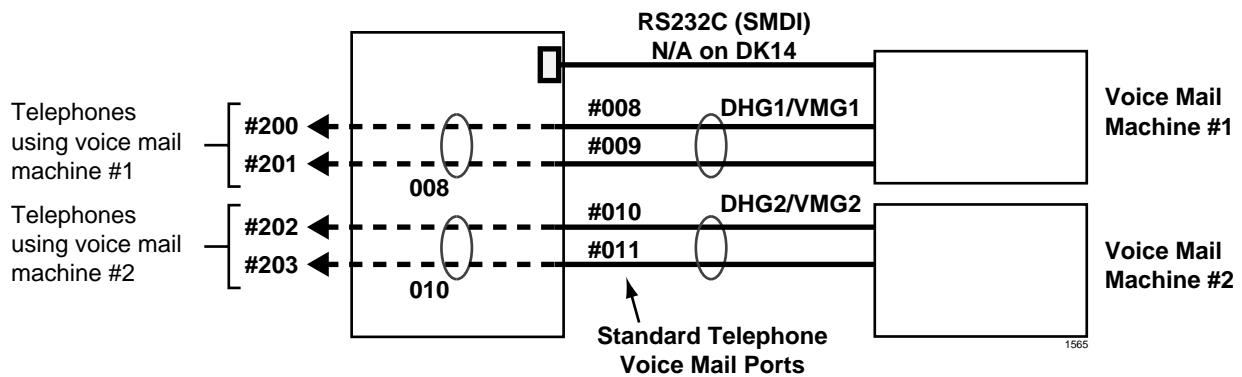

All ports assigned to a Voice Mail Group should also be assigned to a unique Distributed Hunt Group using Program *40. Each Program 31 Voice Mail Group must be associated with a unique Program *40 Distributed Hunt Group that hunts only to its own Voice Mail Group ports. (See above example of how to connect/program two voice mail/auto attendant machines and associate them with two different DH groups.)

- ♦ If LED 15 or 19 is ON, turn LED 17 ON. If LED 20 is ON, turn LEDs 17 and 19 ON.
- ♦ For SMDI or DTMF integration, turn ON LEDs 04, 16, 17 and 18, and one of the following: 05, 06, 07, or 08 for all standard telephone ports connected to a VM unit.
- ♦ Turn LED 19 and 20 OFF if the VM unit does not respond properly to transfer recall (B-Tone) signals when using any type of Voice Mail Interface.
- ♦ LED 09 – see above comments in Program Overview.
- ♦ If CO lines direct ring VM ports via Program 81~89, the data in Programs *81, *84, and *87 must be blank.

Important! Do not assign Program 31 VM/AA options to built-in Auto Attendant digital announcer ports.

LED 20: Toshiba Stratagy/VP (B + Station Number)

Use with Toshiba Stratagy/Stratagy DK/VP systems connected to a standard telephone port (PSTU, RSTU, RSTU2, PESU, RDSU, KSTU2 and QSTU2). Toshiba voice mail systems receiving DTMF B tone followed by the station number may not know where the call is coming from - such as hold recall or “blind” ring transfer recall.

When enabled (LED 20 ON), allows Toshiba voice mail systems to respond more intelligently with appropriate voice prompts. Use this feature for standard telephone ports connected to voice mail devices only, not for station ports connected to telephones. The station number is not returned, it blind transfers to a DND station.

Note You must enable Toshiba Stratagy/Stratagy DK/VP (B No Station) with LED 19 to allow this function.

LED 19: Toshiba Stratagy/Stratagy DK/VP (B No Station)

DTMF “B” tone is sent to Toshiba voice mail systems to signify a recall where Toshiba voice mail systems already knows the recalling station number. Again, this allows Toshiba voice mail systems to respond more intelligently with appropriate voice prompts. Use this feature for standard telephone ports (PSTU, RSTU, RSTU2, PESU, RDSU, KSTU2 and QSTU2) connected to voice mail devices only, not for station ports connected to telephones.

LED 18: Executive and Privacy Override Blocking (Modem)

When enabled (LED 18 ON), denies a station user the capability to break into a station connection with Executive or Privacy Override. Use this feature for standard telephone ports (PSTU, RSTU, RSTU2, PESU, RDSU, KSTU2 and QSTU2) connected to a modem, voice mail/auto attendant or ACD digital announcement device in order to ensure data and voice security. Also, use this feature to deny override of any station. This feature does not block Attendant Supervised Loop Monitoring.

You can use the Privacy Release **Privacy Release** button to disable Privacy on a call-by-call basis; this button does not disable Executive Override Blocking.

Enable this feature if a modem is assigned to the system modem pool in Program 21 to provide data security for modem standard telephone ports.

Disable this feature (LED 18 OFF) for the modem standard telephone ports assigned in Program 21 if using the system modem pool for data calls that must be switched between voice and data.

LED 17: End-to-end Signal RCV (VM)

When enabled (LED 17 ON), provides End-to-end Signaling of Dual-tone Multi-frequency (DTMF) tones through the system. Required on all voice mail ports (RSTU, RSTU2, RDSU/RSTS, PSTU, PESU, RDSU, QSTU2 and KSTU2) for proper signaling communication.

LED 16: Receive Voice Mail (VM) ID Code

When a station is call-forwarded to a VM system, certain identification (ID) DTMF tones are automatically sent to direct the call to a specific mailbox (VM ID Code #656 or DNIS VM ID Code). The automatic ID is also sent to the VM device when electronic, digital, or standard telephone users retrieve messages via the Message Waiting buttons (VM ID Code #657). The VM port must be programmed for this feature to allow the reception of VM ID DTMF digits.

LED 15: Toshiba Strategy, Strategy DK and/or VP Integration (A Tone/D Tone)

When enabled (LED 15 ON), sends an answer tone (DTMF A tone) to the Toshiba voice mail system when a station answers, and a disconnect tone (DTMF D tone) when a station disconnects. This allows Toshiba voice mail systems to respond quickly rather than waiting during long time-outs. If the Central Office (CO) provides an Automatic Release (AR) signal (sometimes referred to as Calling Party Control or Loop Supervision), D tone is also sent to disconnect VM ports when outside callers hang up (see Program 15-0 and 15-3).

LED 14: Off-hook Call Announce (OCA) Handset or Speaker

If a station is enabled to receive OCA (Program 31, LED 03 ON), LED 14 defines which type of OCA the telephone should receive: Headset/Handset (LED 14 ON) or Speaker (LED 14 OFF).

Digital Telephones: Speaker OCA requires a DVSU and a special Program 03 code. Only digital telephones can receive Handset OCA. Handset OCA does not require DVSU or any other special hardware.

Electronic Telephones: Speaker OCA requires a HVSU and three-pair wiring. Headset OCA does not require these items; Electronic or standard telephones cannot receive Handset OCA.

LED 13: OCA Handset Warning Tone

This option enables (LED 13 ON) or disables (LED 14 OFF) a warning-tone (one-second tone burst) for digital telephones that receive Headset OCA. Does not apply to Speaker OCA.

LED 12: Pooled Line Button Operation, No Flash if No Ring

When enabled (LED 12 ON) on telephones assigned to ring in Programs 81~89, incoming line calls in pooled line groups only flash on **Pooled Line** buttons. When disabled (LED 12 OFF), the Pooled Line LED flashes when an incoming line call is received – even if the telephone does not ring.

LED 11: Busy Override (BOV) Tone

Digital or Electronic Telephones: If a [DN] is busy and receives a call on an idle [DN] or CO button from another station or an outside line then BOV tone is sent. BOV tone can be continuous muted one-second rings (LED 11 ON) or two muted one-second rings three seconds apart (LED 11 OFF).

If all the [DN] button appearances of the called [DNs] are busy, the call will camp-on and the telephone receives two muted rings (camp-on tone) three seconds apart (only if LED 01 is ON for the telephone in Program *34).

This BOV feature does not apply to CO lines that are ring transferred to a busy telephone - with or without an idle [DN] or CO **Line** button. In this case, the call is a camped-on call to the busy telephone.

BOV and Camp-on muted ring tone frequency for digital and electronic telephones: 1209Hz/modulated by 10Hz on CO line calls; 1209Hz/unmodulated on station-to-station calls.

Standard Telephones: This feature does not apply to Camp-on tone sent to standard telephones. Standard telephones only receive two Camp-on tone bursts - three seconds apart, regardless of this BOV Tone feature's setting. Also, you must run Program *34 to enable a standard telephone to receive Camp-on tone. Camp-on tone is sent when the busy standard telephone receives a transferred CO line call and when the busy standard telephone receives a direct call from a station or CO line.

BOV and Camp-on muted ring tone frequency for standard telephone:
 BOV tone is a 160ms burst of 1209Hz/ unmodulated, twice - three seconds apart.
 Camp-on tone is two one-second bursts of 1209Hz/interrupted by 160ms bursts, three seconds apart.

LED 10: All Call Page Allowed-Digital and Electronic Telephones

When enabled, (LED 10 ON) any station can be allowed to receive an All Call Page and still have the ability to initiate an All Call Page. Up to 120 stations can be assigned and paged at one time. All Call Page is treated as any other page group. See Program *30 for telephone page group assignments and Program 10-2, LED 15 for External Page with All Call Page option (see Program *34).

LED 09: No Station plus CO Line Conference Origination by VM

When enabled (LED 09 ON), prohibits VM ports from setting up conference calls with a station and the outside line party and tandem calls with two outside lines. Use this feature for VM (RSTU, RSTU2, PSTU, PESU, RDSU/RSTS, KSTU2, QSTU2) ports. This LED should be ON when VM/Auto Attendant does screened or supervised transfers and OFF if only doing blind transfers.

If LED 09 is OFF or ON, station can still set up a conference call with an outside line and a VM port so the station user and outside party can listen to a message together (R3.2 and above).

In DK release 3.2 software, VM ports are allowed to set up tandem calls with two CO lines and then hook-flash and hang-up to exit the call, allowing the two CO lines to remain connected. For this feature, LED 09 must be OFF for VM ports.

LED 05~08: Voice Mail (VM) Groups 1~4

The system allows the following VM station port groups to be configured for support of VM/auto attendant devices:

One group is intended for each different device.

System	Number of VM Groups	LEDs
DK14	1~2	05~06
DK424 and DK40i	1~4	05~08

All standard telephone ports (RSTU, RSTU2, PSTU, PESU, RDSU/RSTS, KSTU2 and QSTU2) connected to a particular VM machine should be assigned to the same VM group (SMDI or DTMF Integration). The purpose of VM grouping is to allow efficient use of the message waiting (MW) set and cancel operations from the VM machine. Since each digital, electronic, and standard telephone can only have a maximum of four messages waiting, the VM device should set MW only once, regardless of how many messages there are.

Assign all ports of each Program 31 VM Group to a unique Program *40 Distributed Hunt (DH) Group. Telephones should Call and/or Call Forward to the DH Group [DN] to connect to VM. In Programs 13 and *32, assign the lowest port in the Program 31 VM group as the message center. Do not assign the VM DH Group port as the message center.

LED 04: Voice Mail (VM) to VM Call Blocking

When enabled (LED 04 ON), prevents VM/auto attendant ports from call forwarding to other VM ports during screened or supervised voice mail transfers. Use this feature for all VM/auto attendant ports if their transferred calls are screened or supervised. Disable this feature (LED 04 OFF) for all VM/auto attendant ports if their calls are ring (blind) transferred.

LED 03: Off-hook Call Announce (OCA) Enabled (Receive)

Enable this option (LED 03 ON) for any digital or electronic telephone requiring OCA. Telephones must be equipped for OCA. OCA is not available on standard telephones.

This feature does not affect the station's ability to originate OCA.

Digital telephones: Speaker OCA requires a DVSU in the telephone. Also, the PDKU supporting OCA must have code 62 or 64 set in Program 03. Handset/headset OCA does not require extra hardware - only that Program 31 LED 03, and 14 be ON.

Electronic telephones: Speaker OCA requires a HVSU/HVSI in the telephone and a third pair of wires from the PEKU. Electronic telephones cannot receive Handset OCA.

LED 02: Handsfree No Warning

As a default, on Voice First systems (Program 10-1, LED 1) a one-second warning tone is sent to a handsfree digital or electronic telephone to inform its user that someone is calling and that they can be heard. If the warning tone is not desired at the called digital or electronic telephone, this assignment can disable it, allowing silent room monitoring of the area surrounding the telephone. This will also prevent ringing the digital or electronic telephone as a ring-first situation. Initialized data activates the warning tone for all ports.

LED 01: Handsfree Disabled

It is possible to disable the internal call Handsfree Answerback function on any digital or electronic telephone. This option ensures privacy (no room monitoring) when enabled on the called station but it prevents the called station from answering an internal call hands free. The **Microphn Cutoff** button (Program 39) can be used instead of this feature to allow the user to enable/disable Handsfree Answerback, as desired.

Program *31 – Group Pickup Assignments

Processor Type: DK14, DK40i, All RCTUs

Program Type: Station

Initialized Default: All LEDs OFF

* # * # 1 * 2 * 3 - Spkr * 3 1 Hold - Spkr # Hold - Spkr # # Hold - Spkr # # Hold

Station Logical Port Number

Enter the station logical port which will be assigned to a pickup group or groups. To add a port range, enter XXX*XXX (low port * high port).

Light LED Buttons for the port specified in the last step. In the table below, mark an "X" for all LED Buttons which should be lit.

Processor Type	Port Range	Pickup Groups
DK14	000-009	8
DK40i	000-027	16
RCTUA	000-031	20

Processor Type	Port Range	Pickup Groups
RCTUBA/BB	000-079	20
RCTUC/D	000-239	20
RCTUE/F	000-335	20

Pickup Group	LED	Port													
		<input type="checkbox"/>	<input type="checkbox"/>	<input type="checkbox"/>	<input type="checkbox"/>	<input type="checkbox"/>	<input type="checkbox"/>	<input type="checkbox"/>	<input type="checkbox"/>	<input type="checkbox"/>	<input type="checkbox"/>	<input type="checkbox"/>	<input type="checkbox"/>	<input type="checkbox"/>	<input type="checkbox"/>
Pickup Group 20	20														
Pickup Group 19	19														
Pickup Group 18	18														
Pickup Group 17	17														
Pickup Group 16	16														
Pickup Group 15	15														
Pickup Group 14	14														
Pickup Group 13	13														
Pickup Group 12	12														
Pickup Group 11	11														
Pickup Group 10	10														
Pickup Group 9	09														
Pickup Group 8	08														
Pickup Group 7	07														
Pickup Group 6	06														
Pickup Group 5	05														
Pickup Group 4	04														
Pickup Group 6	03														
Pickup Group 2	02														
Pickup Group 1	01														

Program *31 Overview

Stations can be divided into as many as 20 pickup groups (see the legend above the record sheet). Station users can pick up calls (internal or line) that are ringing any station within their group by dialing a single access code (or with a **Call Pickup** button assigned with Code 480 in Program 39), and pick up calls that are ringing stations in other groups by dialing selected access codes.

Stations can belong to more than one group. (See Program 05 for access codes.) This feature also picks up ringing transfer and hold recall calls, but does not pick up held calls or selectively by directory number.

To pickup held or ringing [PDN] and/or [PhDN] calls selectively, use the **#5#2** + XXX pickup access code (where XXX is the [PDN] or [PhDN]).

Program 32 – Automatic Preference

Processor Type: DK14, DK40i, All RCTUs

Program Type: Station

Initialized Default: Assigns Ringing Code 1 and Automatic Off-hook (Preference) Code 00 for all ports

* # * # 1 * 2 * 3 - Spkr 3 2 Hold - Spkr # # Hold - Spkr # # Hold - Spkr # # Hold

SELECT = Station Logical Port Number

Enter the port number of the station having preference defined. To add a port range, enter XXX*XXX (low port * high port).

DATA = Ringing Code

- 0 = Disable Ringing Line Preference
- 1 = Enable Ringing Line Preference

Automatic Preference Code:

- 00 = No selection
- 01 = [PDN]
- 02 = Lowest CO, Tie, or DID line
- 11~26 = 01~16 Line groups

(See legend below for maximum line groups.)

Processor Type	Port Range Port Reference Number	Number of CO Line Groups
DK14	000~007	01~04
DK40i	000~027	01~08
RCTUA	000~031	01~08

Processor Type	Port Range Port Reference Number	Number of CO Line Groups
RCTUBA/BB	000~079	01~08
RCTUC/D	000~239	01~16
RCTUE/F	000~335	01~16

Port Number	Ringing Code	Automatic Preference Code

Port Number	Ringing Code	Automatic Preference Code

System & Station

Program 32 Overview

This program defines which [PDN] or CO line a digital (cordless, corded, or Strata AirLink wireless) and electronic telephone will be automatically connected to when the telephone handset is taken off-hook or the **Spkr** button is used.

Note Strata AirLink wireless handsets do not have a **Spkr** button.

The lowest [PDN], lowest CO line, or Line Group is selected only if the telephone is not ringing when it is taken off-hook (no **Spkr** pressed). If a telephone is ringing, the [PDN] Auto Preference, or outgoing CO line is canceled. In this case, no selection is made if Ring Line Preference is disabled; the ring line is selected if Ringing Line Preference is enabled.

Automatic Preference for digital, electronic, or Strata AirLink wireless telephones via handset off-hook or the **Spkr** button is the automatic connection to lines, or the [PDN] of a telephone under various conditions.

With Ringing Line Preference, a digital, electronic, or Strata AirLink wireless telephone user by going off-hook (or by pressing the **Spkr** button) may be automatically connected to the lowest line ringing in without having to press a CO **Line** button or dial an access code.

If no lines are ringing and an electronic or digital telephone goes off-hook, the station can be automatically connected to the [PDN] or to a line. The line connected can be the lowest numbered line available on the telephone or the highest idle line from a selected group.

Notes

- Program 32 does not apply to standard telephones. To allow system features to be accessed, standard telephones always receive system internal dial tone when originating calls.
- If ringing line preference is not selected, no auto preference selection will occur when a station goes off hook during an incoming ring condition.
- Toshiba cordless telephones can have [PDN] (Code 01) selected for Auto Preference so the user will get system dial tone when pressing the **TALK** button from the idle state, or a line or line group can be selected for Auto Preference if CO dial tone should be accessed when the **TALK** button is pressed.
- Strata AirLink wireless handsets must have Code 01 assigned to receive system dial tone after pressing **CALL** in the idle mode. A line or line group can be selected instead, if CO dial tone should be accessed when **CALL** is pressed.

Program *32 – RS-232 Voice Mail Message Center Port

Processor Type: DK14, DK40i, All RCTUs

Program Type: Station

Initialized Default: Blank

*	#	*	#	1	*	2	*	3	-	Spkr	*	3	2	Hold	-	Spkr				#				Hold	-	Spkr	#	#	Hold	-	Spkr	#	#	Hold
---	---	---	---	---	---	---	---	---	---	------	---	---	---	------	---	------	--	--	--	---	--	--	--	------	---	------	---	---	------	---	------	---	---	------

SELECT = Station Logical Port Number
(see ranges below)

Enter the port number having a Message Center assigned. Enter all station ports using the same Voice Mail machine.

To add a port range, enter XXX*XXX (low port * high port).

VM PORT = Voice Mail Message Port

Enter the Voice Mail Message Center Port number (see ranges below) that should be assigned to each station.

Enter the lowest KSTU2, QSTU2 or RSTU2 port number that is connected to the VM machine.

If VM ports are assigned to a Distributed Hunt (DH) Group in Program *40, enter the port number of the first DH Group member, not the DH Group port (900~915). See example following

Processor Type	Port Range
DK14	008-009
DK40i	008-027
RCTUA	000-031

Processor Type	Port Range
RCTUBA/BB	000-079
RCTUC/D	000-239
RCTUE/F	000-335

Port	MW Center Port

Port	MW Center Port

Port	MW Center Port

Port	MW Center Port

System & Station

Program *32 Overview

This program assigns which Voice Mail Message Center port number will be called when a station user presses the flashing **Msg** button. When using SMDI or DTMF voice mail integration, the Voice Mail Port Message Center must be assigned for each station. The Message Center port must be the lowest voice mail standard telephone port in the Program 31 Voice Mail Group. It is normally the same port for all stations.

Program 33 – [PDN]/ [PhDN] Station Hunting (Voice Calls Only)

Processor Type: DK14, DK40i, All RCTUs

Program Type: Station

Initialized Default: Blank

* # * # 1 * 2 * 3 - Spkr 3 3 Hold - Spkr [][] # [][] Hold - Spkr # # Hold - Spkr # # Hold

SELECT = [PDN] or [PhDN] Port Reference Number of the "hunt-from" station.

To add a port range, enter XXX*XXX (low port * high port).

HUNT TO = [PDN] or [PhDN] Port Reference Number of the "hunt-to" station.

Press LED Button 01 to delete digit from the "hunt-to" port.

Processor	[PDN] Port Range	[PhDN] Port Range
DK14	000~009	500~509
DK40i	000~027	500~527
RCTUA	000~031	500~531

Processor	[PDN] Port Range	[PhDN] Port Range
RCTUBA/BB	000~079	500~579
RCTUC/D	000~239	500~739
RCTUE/F	000~335	500~835

Hunt From	Hunt To

Hunt From	Hunt To

Hunt From	Hunt To

Hunt From	Hunt To

Program 33 Overview

Program 33 assigns Station Hunting to [PDNs] or [PhDNs]. When a called station is busy, the Station Hunting feature will ring the alternate "hunt to" [PDNs] or [PhDNs] defined in this program. If the "hunt-to" [DN] is busy, the system will try to ring the next "hunt-to" [DN], and so on.

If a "hunt-to" [DN] is in the Call Forward mode, the call forward will have priority over the hunt. A ground/loop start CO line will hunt from a [PDN] or [PhDN] only if it has been assigned to immediate ring at the owner station of the [PDN] or [PhDN] exclusively (in Programs 81, 84, or 87 and *81, *84, or *87).

On Ring-first systems, if a [PDN] appears on more than one button (on owner's telephone), the DK will not hunt until all appearances of the [PDN] are in use.

On Voice-first systems, the system will hunt for an available station if any one of the [PDN] appearances is busy.

Program 33 - Example

Action (press buttons+LED buttons)	LCD Response
1. Use the programming LCD electronic or digital telephone connected to physical port 005 - circuit 6. Make sure the programming button strip template is installed on the programming telephone. (See "Program 38 Digital and Electronic Telephone Keystrip Type" on Page 3-109.)	No. N-N ¹ Jan 20 Sun 06:43
2. ***#1*2*3 Enter programming mode. (Do not press [DN] button.)	Program Mode
3. Spkr (Speaker) 33 Hold Access Program 33. System beeps after Spkr (Speaker) is pressed to indicate program number may be entered.	Program = 33 Data Store
4. Spkr (Speaker) Prepare the system for a station port selection.	33 Select =
5. 000~335 or 500~835 Select the port number of the Hunt From station. A range of ports can be entered as specified on the record sheet. After the Hunt From port is entered, press the # button. Do not press # when entering a range.	33 Select = (000~335) Hunt To =
6. 000~335 or 500~835 Enter the port number of the Hunt To point, as recorded on the system record sheet. Press LED button 01 to delete a digit from Hunt To point ports.	33 Select = (000~335) Hunt To = (000~335)
7. Hold Secure data in system programming.	33 Select = (000~335) Data Programmed
8. Spkr (Speaker) Prepare system for another selection (go back to Step 5), or exit Program 33 (continue with Step 9).	33 Select = ##
9. ## Hold Secure Program 33 data in system memory.	33 Select = Data Programmed
10. Spkr (Speaker) Exit Program 33. Enter another program number or exit programming mode (go to Step 11). Speaker beeps to indicate it is exiting Program 33.	Program =
11. ## Hold Exit programming mode.	No. N-N Jan 20 Sun 06:58

1. N-N = Program telephone [PDN]

Program *33 Overview

This program assigns each [PhDN] to a designated “Owner” telephone. Each [PhDN] must be assigned to a designated “Owner” telephone and that [PhDN] must be assigned (using Program 39) to appear on the owner telephone. If a [PhDN] is not assigned to an “Owner” telephone, it cannot receive calls (caller will receive reorder tone) but it can be used to originate calls.

If the [PhDN] owner telephone is unplugged, the [PhDN] is busy (vacant) when called, unless CF-All Call is set, in which case, it will forward. A telephone can be assigned as “Owner” of up to eight [PhDNs].

[PhDN] “Owner” telephones have the following attributes for the [PhDNs] that it is assigned to own:

- ◆ Set Call Forward for all [PhDNs] that the telephone owns.
- ◆ Set Call Forward to a VM Mail Box and Message Retrieve ID codes (#656/#657), independent of the telephone’s Voice Mail assignments. This “CF to” VM Box can be the same as the Owner telephone’s VM Box or any other VM Box, including a dedicated VM Box for the [PhDN].
- ◆ Have up to four [PhDN] Message Waiting (MW) LEDs (Program 39, flexible button). This [PhDN] MW button indicates that the [PhDN] has a message waiting from voice mail or another [DN] - again independent of the telephone’s fixed Msg LED.
- ◆ Store ANI and/or Caller ID information for abandon calls directed to the [PhDN]. The [PhDN] Owner telephone must be assigned “Abandon Call Memory” in Program *51 if the [PhDN] rings on more than one telephone.
- ◆ Can receive OCA calls to the [PhDN].

Program 34 – Hold Recall Timing

Processor Type: *DK14, DK40i, All RCTUs*

Program Type: *Station*

Initialized Default: *Assigns a Hold Recall Time of 032 seconds to all ports*

* # * # 1 * 2 * 3 - Spkr 3 4 Hold - Spkr [] [] [] # [] [] [] Hold - Spkr # # Hold - Spkr # # Hold

SELECT = Station Logical Port Number

HUNT TIME = Seconds

Enter the port number having its Hold Recall Time defined.

Enter the number of seconds the system will wait (three digits).

To add a port range, enter XXX * XXX (low port * high port).

Enter 000 for no Hold Recall. Enter 011~160 for 11 to 160 seconds.

Processor	Port Range
DK14	000-009
DK40i	000-027
RCTUA	000-031

Processor	Port Range
RCTUBA/BB	000-079
RCTUC/D	000-239
RCTUE/F	000-335

Port	Seconds	Port	Seconds	Port	Seconds	Port	Seconds

Program 34 Overview

Each station can have a different time (from 011 to 160 seconds) from the point of placing a call on hold to the point of recall. Initialized data assigns a recall time of 032 seconds to all ports.

Program *34 – Station Class Of Service

Processor Type: DK14, DK40i, All RCTUs

Program Type: Station

Initialized Default: LED 01 ON for all ports

##1*2*3 - Spkr * 3 4 Hold - Spkr # Hold - Spkr # # Hold - Spkr # # Hold

SELECT = Station Logical Port Number

Enter the port number(s) being defined.

To add a port range, enter XXX*XXX
(low port * high port).

LED = Select LEDs to light for the port specified in the last step. Mark an "X" in the table below for all LEDs which should be lit.

Processor	Port Range
DK14	000-009
DK40i	000-027
RCTUA	000-031

Processor	Port Range
RCTUBA/BB	000-079
RCTUC/D	000-239
RCTUE/F	000-335

Feature	LED	Port									
	20										
	19										
	18										
	17										
	16										
	15										
	14										
	13										
	12										
	11										
	10										
	09										
	08										
	07										
	06										
	05										
	04										
	03										
	02										
Camp-on Tone to standard telephone, DKT, or EKT handset/Spkr	01										

System & Station

Program *34 Overview

Program *34 assigns Camp-on tone to standard telephones.

A standard telephone can receive (LED 01 ON), or be blocked (LED 01 OFF) from receiving Camp-on tone depending on how LED 01 is programmed for its standard station port.

When LED 01 is ON for a standard telephone: Camp-on tone is sent when the busy standard telephone receives a transferred CO line call and when the busy standard receives a direct call from a station or CO line.

An optional Camp-on busy tone burst can be sent to standard telephone handsets/headsets (LED 01 ON). Turn LED 01 OFF for all standard telephone ports connected to voice mail and/or auto attendant devices.

Camp on tone to a standard telephone handset is:

- ♦ Two 160 ms bursts of 1209 Hz, 3-seconds apart (internal, transferred, or Tie line calls)
- ♦ Two 1-second bursts of 1209 Hz, (interrupted by 160 ms), 3-seconds apart (external CO or DID line call)

If this option is disabled on Toshiba digital or electronic telephones (LED 01 OFF), the telephone will not receive camp-on tone on direct DID calls or transferred CO line calls if there is not an idle [DN] or **Line** button to receive the call, but the telephone will continue to receive BOV tone on direct internal or CO line calls, providing there is a [DN] or **Line** button available for the call to ring.

Also, if a busy DKT or EKT receives any type of call and there is not an idle [DN] or **Line** button available for the call to ring, the DKT or EKT will receive camp-on tone (if LED 01 is ON) or will not receive camp-on or BOV tone (LED 01 OFF).

Program 35 – Station Class of Service

Processor Type: DK14, DK40i, All RCTUs

Program Type: Station

Initialized Default: LED 01, 02, 04, 05, 16 are ON, all other LEDs OFF.

##1*2*3 - Spkr 3 5 Hold - Spkr [] [] # [] Hold - Spkr # # Hold - Spkr # # Hold

SELECT = Station Logical Port Number

Enter the port number(s) being defined.

To add a port range, enter XXX*XXX
(low port * high port).

LED = Select LEDs to light for the port specified in the last step. Mark an "X" in the table below for all LEDs which should be ON.

Processor	Port Range	Maximum LCD Phones With Personal Messages
DK14	000-009	8
DK40i	000-027	16
RCTUA	000-031	16

Processor	Port Range	Maximum LCD Phones With Personal Messages
RCTUBA/BB	000-079	32
RCTUC/D	000-239	96
RCTUE/F	000-335	96

Feature	LED	Port											
Busy Station Transfer	20												
Busy Station Ringing	19												
Automatic Hold	18												
DKT 2000 Telephone Continuous DTMF Tones OFF	17												
No CF/NA Handsfree or OCA	16												
Not used	15												
Toll Restriction After Answer	14												
Toll Restriction After Answer	13												
Not used	12-07												
Disable Hold Display Scrolling (Release 3.2 and higher)	06												
LCD Personal Message (10-19) Allowed	05												
Message Waiting (RCV)	04												
Message Waiting Lamp Standard. Telephones	03												
LCD Type/32-ON/12-OFF	02												
LCD Display	01												

System & Station

Program 35 Overview

LED 19: Busy Station Transfer (BST), LED 20 / Busy Station Ringing (BSR)

BST and BSR operate together to ensure that a busy digital or electronic telephone station always receives transferred line calls along with LED and tone indications. The station or Voice Mail (VM)/auto attendant device that transfers the call must be programmed with BST (LED 20 ON) and the station port that receives it must have BSR (LED 19 ON).

When a busy station with BSR receives a transfer from a station or VM/auto attendant with BST, there is a muted repetitive BOV tone (see Program 31, LED 11) at the busy station; if there is an idle [DN], its LED will flash at the ringing rate until the station transferring the call hangs up. When it does hang up, or if there is not an idle [DN], the line call then camps-on to the busy station. The busy station is alerted of the camp-on by a camp-on tone (see Program *34), the CO line LED flashes at the exclusive hold rate, and a message (“CAMP-ON X”, X = the line number) appears on the LCD (if equipped).

Among other applications, a VM/auto attendant device that transfers calls to a typically busy answering position station benefits from this program. Some auto attendant devices cannot transfer a call to a busy station if BST and BSR are not activated.

Notes

- A BST station receives ringback tone, instead of busy tone, when transferring a call to a busy BSR station.
- Do not assign BST/BSR to built-in Auto Attendant announcement ports.
- BST (LED 20 ON) should be assigned to all ACD agent telephones and BSR (LED 19 ON) should be assigned to all ACD supervisor telephones to allow agent assistance calls to supervisor telephones that are busy.
- LEDs 01, 02, and 04 must be ON to allow the Telephone’s Message Waiting LED to function with voice mail—even if the Telephone is not an LCD type.
- Dial out (with or without Toll Restriction) must be allowed to use Speed Dial Buttons after answering incoming calls. If a CO line is put on hold, Toll Restriction is applied to stations that are restricted when the held line is picked up by a toll restricted station. If “Dial out with T.R.” is enabled, the CO line will drop if a station dials a restricted number after answering an incoming call, or if any digit is dialed with “dial out not allowed.”

LED 18: Automatic Hold

When enabled, (LED 18 ON), station users with CO **Line** buttons can place a CO line or [DN] call on hold, then call another line or station just by pressing another CO **Line** or [DN] button and dialing the number. If Automatic Hold is not allowed (LED 18 OFF), users can put calls on hold and place calls, but they must press the **Hold** button before accessing another line or [DN].

Notes

- CO line or internal calls that appear on the [DN] buttons will automatically hold when accessing another line.
- Toshiba recommends that the **Release and Ans** button be provided via Program 39 to telephones programmed for Auto Hold.

LED 17: Continuous DTMF Tones Off

2000-series digital telephones can send DTMF tones for as long as station users press their buttons (80 msec. minimum). This feature can be disabled (LED 17 ON). If it is disabled, DTMF tones sent by these telephones will be either 80 or 160 milliseconds depending on the selection made with Program 10-1, LED 04 and Program 10-2, LED 06.

Note PDKU1 does not support continuous DTMF tones on 2000-series digital telephones.

LED 16: No Call Forward/No Answer on Handsfree Answerback

When enabled (LED 16 ON), a Handsfree Answerback call to an idle station in the Call Forward No-Answer or Call Forward-Busy/No Answer mode is not forwarded. If the system is Programmed for Voice first (Program 10-1 and 10-2, LED 01 OFF), Voice Announce calls do not Call Forward No-Answer; however, calls will call forward busy. This prevents the call from being forwarded 8-60 seconds after the called party has been talking in the Handsfree Answerback mode.

Outside calls and busy internal calls to the station continue to forward with this feature set. If the system is set for Tone First, calls will call forward on Busy and No Answer.

Notes

- The caller can press the RING Soft Key on digital LCD telephones or press **1** on digital or electronic telephones to activate Call Forward on Voice Announce calls.
- OCA calls do not Call Forward No Answer in any case.

LED 15

Not used at this time.

LEDs 13 and 14: Toll Restriction After Answer

These two LEDs determine whether or not a toll restricted telephone user is allowed to use one touch speed dial buttons after answering an incoming CO line call. LED 13 and 14 should be turned ON for Toll Restricted Telephones that must answer incoming CO line calls and use **SD** (speed dial) buttons programmed to perform functions that Hold or Park calls and access the page system automatically.

LED 13	LED 14	Description
OFF	OFF	Not allowed to use Speed Dial after answering a line call.
ON	OFF	Allowed to use Speed Dial buttons but subject to toll restriction tables.
OFF	ON	Allowed to use Speed Dial buttons and not subject to toll restriction.

Initialized data sets both LEDs 13 and 14 off for all telephone users (not allowed to use Speed Dial buttons after answering incoming CO line calls).

LED 07~12

Not used at this time.

LED 06: Disable Hold Display Scrolling (Release 3.2)

If LED 06 is ON, Hold Display scrolling is disabled. Also, a telephone LCD cannot display which CO lines are on hold on a [PDN] if the **Scroll** button is pressed. Hold Display causes the [DN] button LED, of the line displayed on the LCD, to flash at a fast rate. If LED 06 is OFF, Hold Display Scrolling is enabled. Prior to Release 3.2, Hold Display Scrolling was always enabled. Hold Display Scrolling requires an LCD telephone.

LED 05: LCD Individual Message

This option defines which ports can allow LCD digital and electronic telephones to store up to 10 personal messages. It offers the option of entering alphanumeric memos for each of the LCD's station speed dial numbers. See the record sheet legend for the maximum stations that can have this option:

A low port must be disabled (LED 05 OFF) before adding a port above the initialized ports.

LED 04: Message Waiting (RCV)

If the message waiting indication is not desired on an electronic, digital or standard telephone, this program can be used to deny it. This does not affect that station's ability to send a message waiting indication to another station ([PDN] or [PhDN]). Do not use this option to enable/disable MW lamps on standard telephones; use LED 03 below for standard telephones.

LED 03: Standard Telephone Message Waiting Lamp Enable

This option is used to identify which station ports are connected to Standard Telephones (2500 or 500 type telephones) that have Message Waiting Lamps. LED 03 should be turned ON for all Standard Telephones ports that should support Standard Telephone Message Waiting lamps; LED 03 must be turned OFF for all other station ports including digital and electronic telephone ports that support Message Waiting LEDs. This also applies to Voice Mail ports.

Important! *Standard telephones that require the Message Waiting Lamp functions must be connected to an RSTU2 PCB. Only one standard telephone with Message Waiting Lamp is allowed to be connected to each RSTU2 port.*

LED 02: LCD Type 32/12

Digital and 6000/6500-series LCD electronic telephones have 32-character displays. Therefore, assignments should be left in the initialized state of 32 characters. LED 02 must be ON to receive the voice mail message waiting indication.

LED 01: LCD Display

This option should be used (LED 01 ON) for all stations (even non-LCD), unless it is desired to disable the station's LCD and message waiting functions.

Program 36 – Fixed Call Forward

Processor Type: *DK14, DK40i, All RCTUs*

Program Type: *Station*

Initialized Default: *Does not assign a Fixed Call Forward location to any port*

*** # * # 1 * 2 * 3 - Spkr 3 6 Hold - Spkr [][] # [][] Hold - Spkr ## Hold - Spkr ## Hold**

SELECT = Station Logical Port Number

FORWARD TO TEL = Port Number

Enter the port number of the station that needs a Fixed Call Forward location assigned.

Enter the port number of the [PDN], [PhDN] or DH [DN] that will be call forwarded to when the **Fixed Call Forward** button is pressed.

To add a port range, enter XXX*XXX (low port * high port).

[PhDNs] or DH [DNs] can be entered with DK Release 3.2 and above software only.

Processor	[PDN] Port Range	[PhDN] Port Range	DH Group Ports
DK14	000-009	500-509	900-915
DK40i	000-027	500-527	900-915
RCTUA	000-031	500-531	900-915

Processor	[PDN] Port Range	[PhDN] Port Range	DH Group Ports
RCTUBA/BB	000-079	500-579	900-915
RCTUC/D	000-239	500-739	900-915
RCTUE/F	000-335	500-835	900-915

Port	Forward to Tel Port

Port	Forward to Tel Port

Port	Forward to Tel Port

Port	Forward to Tel Port

Program 36 Overview

Fixed Call Forwarding is different from other station Call Forwarding options. It is fixed in terms of the destination [PDN] which is assigned in this program. The station user cannot change the Fixed Call Forward destination, unlike the other station Call Forwarding options. If Fixed Call Forwarding is set on a station, the station does not ring and all calls forward immediately.

Note Telephones and attendant consoles must have a **Fixed-Call Forward** button to activate this feature (See Programs 39 and 59).

Program *36 – System NT Button Lock Password Changing Station Assignment

Processor Type: DK14, DK40i, All RCTUs

Program Type: Station

Initialized Default: 000



Processor	Port Range
DK14	000-009
DK40i	000-027
RCTUA	000-031

Processor	Port Range
RCTUBA/BB	000-079
RCTUC/D	000-239
RCTUE/F	000-335

Tenant Number	NT Lock Station or Console Port
1	
2	
3	
4	

Program *36 Overview

Attendant Consoles and stations assigned in this program can change the System Night Transfer (NT) Lock password by dialing the sequence below:

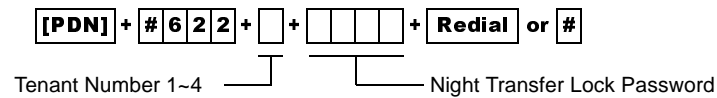

Only one station or console can change the code. System/Tenant CO lines can be locked into the Day, Day2, or Night ringing mode only after the NT Lock password is entered. Locking the system into a particular ringing mode adds security to line call routing which prevents accidental or mischievous changing of the system ringing mode.

Any telephone or an attendant console can lock the system into a ringing mode. The telephone or console must have both a **Night Transfer** and an **Night Transfer Lock** button *and* the person locking the system must enter the password.

NT lock related programs include:

- Program 39** Station Flexible Button Assignments – **Night Transfer** and **Night Transfer Lock** buttons
- Program 59** Attendant Console Flexible Button Codes – **Night Transfer** and **Night Transfer Lock** buttons
- Program *36** NT Lock Station Assignment. Program *36 is not required to assign attendant consoles to NT Lock functions
- Program *15** CO Line Tenant Assignments
- Program 74** System NT Lock Password Assignment
- Program 77-3** Tenant Night Ring Over External Page Assignments

Program 37 – Ring Transfer (Camp-on) Recall Time

Processor Type: DK14, DK40i, All RCTUs

Program Type: Station

Initialized Default: Assigns Ring Transfer Recall Time of 32 seconds to all ports

```
*#*#1*2*3 - Spkr 3 7 Hold - Spkr [ ][ ] # [ ][ ] Hold - Spkr ## Hold - Spkr ## Hold
```

SELECT = Station Logical Port Number ———— HOLD TIME = Port Number

Enter the port number that needs a Ring Transfer Recall Time assigned.

Enter the Ring Transfer Recall Time (three digits, in seconds)

To add a port range, enter XXX*XXX (low port * high port).

Enter 011~999 for 11 to 999 seconds.

Processor	Port Range
DK14	000~009
DK40i	000~027
RCTUA	000~031

Processor	Port Range
RCTUBA/BB	000~079
RCTUC/D	000~239
RCTUE/F	000~335

Port	Hold Time	Port	Hold Time	Port	Hold Time	Port	Hold Time

System & Station

Program 37 Overview

If a busy or ringing station does not answer a call sent to it via ring (blind) call transfer (lines or [DNs]), the station originating the ring (blind) transfer is recalled after an amount of time determined with this program. This time (011~999 seconds) is set independently for each originating station port. Initialized data sets all stations for a 032-second recall time. Ring Transfer must first be enabled for the system with Program 10-1, LED 07 ON.

System & Station

Program *37 – Park Recall Timing

Program *37 – Park Recall Timing

Processor Type: DK14, DK40i, All RCTUs

Program Type: Station

Initialized Default: Assigns Ring Transfer Recall Time of 32 seconds to all ports

##1*2*3 - Spkr*37 Hold - Spkr [] [] # [] [] Hold - Spkr ## Hold - Spkr ## Hold

SELECT = Station Logical Port Number

PARK TIME = Seconds

Enter the port number having its Park Recall Time assigned.

Enter the number of seconds the system will wait (three digits). Enter 011~999 for 11 to 999 seconds.

To add a port range, enter XXX*XXX (low port * high port).

Processor	Port Range
DK14	000-009
DK40i	000-027
RCTUA	000-031

Processor	Port Range
RCTUBA/BB	000-079
RCTUC/D	000-239
RCTUE/F	000-335

Port	Seconds

Port	Seconds

Port	Seconds

Port	Seconds

Program *37 Overview

Each station can have a different duration (from 011 to 999 seconds) from the time of parking a call to the time the parked party recalls the station. Initialized data assigns a park recall time of 032 seconds to all ports.

Program 38 – Digital and Electronic Telephone Keystrip Type

Processor Type: *DK14, DK40i, All RCTUs*
Program Type: *Station*
Initialized Default: *Assigns Code 31 to all ports*

Important!

If you only want to view Program 38 data, do not press **Hold**, press **Spkr**. Pressing **Hold** will change Program 39 assignments.

Spkr

...or



SELECT = Port Number

Enter the port number of the station that needs a keystrip defined.

To add a port range, enter XXX * XXX (low port * high port).

BUTTON MENU = Code

Enter the appropriate code:

- Code 21 = 10-button telephone
- Code 31 = 20-button (A) telephone
- Code 32 = 20-button (B) telephone
- Code 33 = 20-button (C) telephone

Processor	Port Range
DK14	000-009
DK40i	000-027
RCTUA	000-031

Processor	Port Range
RCTUBA/BB	000-079
RCTUC/D	000-239
RCTUE/F	000-335

Port	Button Menu

Port	Button Menu

Port	Button Menu

Port	Button Menu

Program 38 Overview

Four telephone button arrangements are provided (see the Program 38 System Record Sheet). It is best to start with one of these four, and then move on to Program 39, where individual buttons may be programmed. Initialized data treats all digital telephone ports as 20-button types with 17 CO **Line** buttons, one [PDN] button, one **Do Not Disturb** button, and the **Speed Dial** button. See the System Record Sheet for electronic telephone arrangements.

Important!

- Always complete Program 38 before proceeding to Program 39.
- DKAdmin will program a Pause on buttons 11~20 on 10-key telephones.

Assignments for 2000-Series Digital Telephone Keystrips

Speed Dial ¹
Do Not Disturb
Line 7
Line 6
Line 5
Line 4
Line 3
Line 2
Line 1
[PDN]

Code 21 – 10-Button

Line 9	Speed Dial ¹
Line 8	Do Not Disturb
Line 7	SD 14
Line 6	SD 13
Line 5	SD 12
Line 4	SD 11
Line 3	SD 10
Line 2	Line 12
Line 1	Line 11
[PDN]	Line 10

DK424 and DK40i
Code 32 – 20-Button (B)

SD10	Flash
Line 8	Do Not Disturb
Line 7	Speed Dial
Line 6	Redial
Line 5	Speed Dial Pause
Line 4	SD 15
Line 3	SD 14
Line 2	SD 13
Line 1	SD 12
[PDN]	SD 11

DK424
Code 33 – 20-Button (C)
(Keystrip not provided, but can be assigned)

All Call Voice Page (for DK40i only) ...or Line 9	Speed Dial ¹
Line 8	Do Not Disturb
Line 7	Line 17 ²
Line 6	Line 16
Line 5	Line 15
Line 4	Line 14
Line 3	Line 13
Line 2	Line 12
Line 1	Line 11
[PDN]	Line 10

Code 31 (Default) – 20-Button (A)

SD14	Speed Dial ¹
SD13	Do Not Disturb
SD12	SD 22
SD11	SD 21
SD10	SD 20
Line 4	SD 19
Line 3	SD 18
Line 2	SD 17
Line 1	SD 16
[PDN]	SD 15

DK14
Code 32 – 20-Button (B)

Line 9	Flash
Line 8	Do Not Disturb
Line 7	Speed Dial
Line 6	Redial
Line 5	Speed Dial Pause
Line 4	Line 12
Line 3	Line 11
Line 2	Line 10
Line 1	
[PDN]	

DK40i
Code 33 – 20-Button (C)

Assignments for 1000-Series Digital Telephone Keystrips

CO15	CO16	CO17	DND	SDS
CO10	CO11	CO12	CO13	CO14
CO5	CO6	CO7	CO8	CO9
[PDN]	CO1	CO2	CO3	CO4

Code 31 (Default) – 20-Button (A)

SD12	SD13	SD14	DND	SDS
CO10	CO11	CO12	SD10	SD11
CO5	CO6	CO7	CO8	CO9
[PDN]	CO1	CO2	CO3	CO4

Code 32 – 20-Button (B)

PAU	RDL	SDS	DND	FLASH
SD11	SD12	SD13	SD14	SD15
CO5	CO6	CO7	CO8	CO9
[PDN]	CO1	CO2	CO3	CO4

Code 33 – 20-Button (C)

Assignments for Electronic Telephone Keystrips

MW/FL ¹
Do Not Disturb
CO7
CO6
CO5
CO4
CO3
CO2
CO1
[PDN]

Code 21 – 10-Button

CO9	MW/FL ¹
CO8	Do Not Disturb
CO7	CO17 ²
CO6	CO16
CO5	CO15
CO4	CO14
CO3	CO13
CO2	CO12
CO1	CO11
[PDN]	CO10

Code 31 (Default) – 20-Button (A)

CO9	MW/FL ¹
CO8	Do Not Disturb
CO7	SD14
CO6	SD13
CO5	SD12
CO4	SD11
CO3	SD10
CO2	CO12
CO1	CO11
[PDN]	CO10

Code 32 – 20-Button (B)

SD10	MW/FL ¹
CO8	Do Not Disturb
CO7	SDS
CO6	RDL
CO5	PAU
CO4	SD15
CO3	SD14
CO2	SD13
CO1	SD12
[PDN]	SD11

Code 33 – 20-Button (C)

1. The **Speed Dial** button is the same as the **SDS** or **REP** buttons in previous Strata systems (Program 39, Code 97). Also, if changing PEKU PCBs (electronic telephone) to PDKU PCBs (digital telephone), or vice versa, always check that the **Speed Dial** or **MW/FL** button is set appropriately in Program 39.
2. This button is initialized as **SD10** with RCTUA since there are only 16 CO lines.

System & Station

Program 38 – Digital and Electronic Telephone Keystrip Type

10	30, 50, 70 90, 110, 130, 150, 170, 190	9	20	40, 60, 80 100, 120, 140, 160, 180, 200	9
09	29, 49, 69 89, 109, 129, 149, 169, 189	8	19	39, 59, 79 99, 119, 139, 159, 179, 199	8
08	28, 48, 68 88, 108, 128, 148, 168, 188	7	18	38, 58, 78 98, 118, 138, 158, 178, 198	7
07	27, 47, 67 87, 107, 127, 147, 167, 187	6	17	37, 57, 77 97, 117, 137, 157, 177, 197	6
06	26, 46, 66 86, 106, 126, 146, 166, 186	5	16	36, 56, 76 96, 116, 136, 156, 176, 196	5
05	25, 45, 65 85, 105, 125, 145, 165, 185	4	15	35, 55, 75 95, 115, 135, 155, 175, 195	4
04	24, 44, 64 84, 104, 124, 144, 164, 184	3	14	34, 54, 74 94, 114, 134, 154, 174, 194	3
03	23, 43, 63 83, 103, 123, 143, 163, 183	2	13	33, 53, 73 93, 113, 133, 153, 173, 193	2
02	22, 42, 62 82, 102, 122, 142, 162, 182	1	12	32, 52, 72 92, 112, 132, 152, 172, 192	1
01	21, 41, 61 81, 101, 121, 141, 161, 181	0	11	31, 51, 71 91, 111, 131, 151, 171, 191	0

16, 36, 56, 76 96, 116, 136, 156, 176, 196	17, 37, 57, 77 97, 117, 137, 157, 177, 197	18, 38, 58, 78 98, 118, 138, 158, 178, 198	19, 39, 59, 79 99, 119, 139, 159, 179, 199	20, 40, 60, 80 100, 120, 140, 160, 180, 200
11, 31, 51, 71 91, 111, 131, 151, 171, 191	12, 32, 52, 72 92, 112, 132, 152, 172, 192	13, 33, 53, 73 93, 113, 133, 153, 173, 193	14, 34, 54, 74 94, 114, 134, 154, 174, 194	15, 35, 55, 75 95, 115, 135, 155, 175, 195
06, 26, 46, 66 86, 106, 126, 146, 166, 186	07, 27, 47, 67 87, 107, 127, 147, 167, 187	08, 28, 48, 68 88, 108, 128, 148, 168, 188	09, 29, 49, 69 89, 109, 129, 149, 169, 189	10, 30, 50, 70 90, 110, 130, 150, 170, 190
01, 21, 41, 61 81, 101, 121, 141, 161, 181	02, 22, 42, 62 82, 102, 122, 142, 162, 182	03, 23, 43, 63 83, 103, 123, 143, 163, 183	04, 24, 44, 64 84, 104, 124, 144, 164, 184	05, 25, 45, 65 85, 105, 125, 145, 165, 185



1843

1000-series digital telephone strip - shows programming button/LED assignment locations. Shown as reference only - not available as an individual strip.

LED Buttons and CO line numbers (01~20)

Last digit of EK port number for programs with a format like *71, *72, and *73

CO line numbers (21~200)

2000-series digital telephone strip - supplied with each *Strata DK Programming Manual* and each Documentation Package that ships with the system. Can also be used with 6000- and 6500-series electronic telephones.

Note Button numbers 01~200 on electronic telephones (6000, 6500 series, etc.) are in the same position as shown on the 2000-series digital telephone programming keystrip.

Program *38 – Standard Telephone Ring-Down Destination

Processor Type: Release 4.0 and higher RCTUs

Program Type: Station

Initialized Default: Does not assign Ring Down Destination to any port

* * * * 1 * 2 * 3 - **Spkr** * 3 8 **Hold** - **Spkr** **#** **Hold** - **Spkr** **Hold** - **Spkr** **Hold**

SELECT = Standard Telephone Logical Port Number

FORWARD TO TEL = Port Number

Enter the port number of the station that needs a Ring Down Destination assigned.

Enter the port number of the [PDN], [PhDN] or DH [DN] that should ring when the Ring-Down Timer (Program 12-1) expires.

To add a port range, enter XXX*XXX (low port * high port).

Processor	[PDN] Port Range	[PhDN] Port Range	DH Group Ports
DK14	N/A	N/A	900-915
DK40i	N/A	N/A	900-915
RCTUA	000-031	500-531	900-915

Processor	[PDN] Port Range	[PhDN] Port Range	DH Group Ports
RCTUBA/BB	000-079	500-579	900-915
RCTUC/D	000-239	500-739	900-915
RCTUE/F	000-335	500-835	900-915

Port	Forward to Tel Port	Port	Forward to Tel Port	Port	Forward to Tel Port	Port	Forward to Tel Port

System & Station

Program *38 Overview

Standard telephones can be assigned to ring a destination automatically by going off-hook (ring down). They can also be programmed to ring a destination if an incomplete valid number is dialed. This program assigns the ring down destination. The timer in Program 12-1 determines when the destination should ring after the standard telephone goes off hook or if an incomplete valid number is dialed.

If a standard telephone is assigned a ring down destination, ring down will always occur after the ring down timer expires unless a valid feature access code or [DN] is dialed prior to the ring down timer expiration (Program 12-1). Ring down applies only to standard telephone ports, not electronic or digital telephone ports.

Program 39 – Flexible Button Assignments

Processor Type: DK14, DK40i, All RCTUs

Program Type: Station

Initialized Default: See Program 38

* # * # 1 * 2 * 3 - Spkr 3 9 Hold - Spkr [] [] # [] [] [] Hold - Spkr # # Hold - Spkr # # Hold

SELECT = Port Number

Enter the port number(s) to which class of service must be assigned.
To add a port range, enter XXX*XXX (low port * high port).

Code

Press LED Button to be defined.

Port No. _____	10 <input type="checkbox"/>	LCD <input type="checkbox"/>	
	20 <input type="checkbox"/>	DIU <input type="checkbox"/>	
Location:			
Button	Code	Button	Code
10		20	
09		19	
08		18	
07		17	
06		16	
05		15	
04		14	
03		13	
02		12	
01		11	

Port No. _____	10 <input type="checkbox"/>	LCD <input type="checkbox"/>	
	20 <input type="checkbox"/>	DIU <input type="checkbox"/>	
Location:			
Button	Code	Button	Code
10		20	
09		19	
08		18	
07		17	
06		16	
05		15	
04		14	
03		13	
02		12	
01		11	

Port No. _____	10 <input type="checkbox"/>	LCD <input type="checkbox"/>	
	20 <input type="checkbox"/>	DIU <input type="checkbox"/>	
Location:			
Button	Code	Button	Code
10		20	
09		19	
08		18	
07		17	
06		16	
05		15	
04		14	
03		13	
02		12	
01		11	

Port No. _____	10 <input type="checkbox"/>	LCD <input type="checkbox"/>	
	20 <input type="checkbox"/>	DIU <input type="checkbox"/>	
Location:			
Button	Code	Button	Code
10		20	
09		19	
08		18	
07		17	
06		16	
05		15	
04		14	
03		13	
02		12	
01		11	

Port No. _____	10 <input type="checkbox"/>	LCD <input type="checkbox"/>	
	20 <input type="checkbox"/>	DIU <input type="checkbox"/>	
Location:			
Button	Code	Button	Code
10		20	
09		19	
08		18	
07		17	
06		16	
05		15	
04		14	
03		13	
02		12	
01		11	

Port No. _____	10 <input type="checkbox"/>	LCD <input type="checkbox"/>	
	20 <input type="checkbox"/>	DIU <input type="checkbox"/>	
Location:			
Button	Code	Button	Code
10		20	
09		19	
08		18	
07		17	
06		16	
05		15	
04		14	
03		13	
02		12	
01		11	

Port No. _____	10 <input type="checkbox"/>	LCD <input type="checkbox"/>	
	20 <input type="checkbox"/>	DIU <input type="checkbox"/>	
Location:			
Button	Code	Button	Code
10		20	
09		19	
08		18	
07		17	
06		16	
05		15	
04		14	
03		13	
02		12	
01		11	

Port No. _____	10 <input type="checkbox"/>	LCD <input type="checkbox"/>	
	20 <input type="checkbox"/>	DIU <input type="checkbox"/>	
Location:			
Button	Code	Button	Code
10		20	
09		19	
08		18	
07		17	
06		16	
05		15	
04		14	
03		13	
02		12	
01		11	

Port No. _____	10 <input type="checkbox"/>	LCD <input type="checkbox"/>	
	20 <input type="checkbox"/>	DIU <input type="checkbox"/>	
Location:			
Button	Code	Button	Code
10		20	
09		19	
08		18	
07		17	
06		16	
05		15	
04		14	
03		13	
02		12	
01		11	

Port No. _____	10 <input type="checkbox"/>	LCD <input type="checkbox"/>	
	20 <input type="checkbox"/>	DIU <input type="checkbox"/>	
Location:			
Button	Code	Button	Code
10		20	
09		19	
08		18	
07		17	
06		16	
05		15	
04		14	
03		13	
02		12	
01		11	

Port No. _____	10 <input type="checkbox"/>	LCD <input type="checkbox"/>	
	20 <input type="checkbox"/>	DIU <input type="checkbox"/>	
Location:			
Button	Code	Button	Code
10		20	
09		19	
08		18	
07		17	
06		16	
05		15	
04		14	
03		13	
02		12	
01		11	

Port No. _____	10 <input type="checkbox"/>	LCD <input type="checkbox"/>	
	20 <input type="checkbox"/>	DIU <input type="checkbox"/>	
Location:			
Button	Code	Button	Code
10		20	
09		19	
08		18	
07		17	
06		16	
05		15	
04		14	
03		13	
02		12	
01		11	

System & Station

Program 39 Overview

Program 39 assigns features to the flexible buttons for individual telephones in the system. Several types of buttons can be assigned with this program, including:

- ◆ Feature
- ◆ [PDNs], [SDNs] and [PhDNs] – Message Waiting buttons can be assigned to [PhDNs]
- ◆ Alert Signal (Buzz key)

Feature Buttons Assignments

You can assign commonly used telephone features to any flexible button (see Table 3-1). Button assignments can be different for individual telephones. Telephone users can also assign flexible buttons if their COS and/or if programming permits the feature on their telephone.

Strata AirLink handsets interfaced to the Strata DK using the RWIU/WWIS PCB have only six flexible buttons (4~9) available for programming.

Important!

- *DKAdmin programs a Pause on buttons 11~20 on 10-key telephones.*
- *The **Line** button on the DKT2001 is flexible button 01. Only program a [PDN] onto this button. Do not program CO lines or secondary line appearances onto button 01 or in any other position. Since the system assigns CO lines 01~17 by default, be sure to remove any CO line appearances by programming them as Station Speed Dial buttons (code *).*

Note If the **Speed Dial Select** button is removed, the * key becomes the **Speed Dial Select** button. While on an outside call, the user must press * then # to activate the * and # DTMF tones for the duration of the call.

► To assign features to flexible buttons

1. Complete Program 38 before Program 39. Initialized data assigns the keystrip pattern associated with Code 31 from Program 38.
2. Use “Program 39 – Flexible Button Assignments” on Page 3-111 to indicate feature buttons. Use the programming sequence after this table to perform the following steps.
3. Program the port number or enter a range of port numbers.
4. Press the button that will be associated with the feature.
5. Enter the feature code.
6. Repeat this procedure until all feature buttons have been assigned.

Table 3-1 Feature Button Codes for Digital, Electronic, and Strata AirLink Wireless Telephones

Button Function	Button Labels	Code	Notes
Account Code	Account Code or ACCNT	450	Allows a Voluntary Account Code entry.
Alarm ¹	Alarm Reset or ALRM	477	Resets alarm condition system-wide.
Alert Signaling (see following pages) ¹			
All Call Voice Page	All Call Page or AC	489	Pages up to 120 idle electronic or digital telephones over speaker.
Automatic Busy Redial	Auto Busy Redial or ABR	470	Sets ABR of busy outgoing number.
Automatic Callback Busy	Auto Callback or ACB	494	Sets ACB for station recalled by busy line.
Background Music ¹	Tel Set Music or BGM	478	Turns BGM ON or OFF through station speaker.
Call Forward All Calls	Call Frwd All Calls or CFAC	487	All calls forward to selected station.

Table 3-1 Feature Button Codes for Digital, Electronic, and Strata AirLink Wireless Telephones (continued)

Button Function	Button Labels	Code	Notes
Call Forward A.C. Fixed	Call Frwd to: or CFF	486	Forwards all calls to pre-defined destination. See Program 36.
Call Forward Busy	Call Frwd Busy or CFB	459	Forwards calls to selected station if station is busy.
Call Forward Busy/No Answer	Call Frwd Busy/NANs or CFB/NA	457	Forwards calls to selected station if station is busy or does not answer.
Call Forward External	Call Frwd External or CF-EXT	460	Forward calls externally.
Call Forward No Answer	Call Frwd No Answer or CFNA	458	Forwards calls to selected station if station does not answer.
Call Park ²	Park in Orbit or PARK (R3)	464	Call Park Only.
Call Park LCD Display ¹	Park Orbit Display or CPD (R3)	465	CP Display Button and Mode 64 can be used interchangeably. Displays call parked via telephone LCD.
Call Park and Page	Call Park/Page or CP/PG (R3)	463	Parking and Paging Park Pickup.
Call Pickup (Directed)	Directed Pickup or PKUP	484	Picks up ringing or held intercom, trunk calls, and page.
Call Pickup Tenant 4 ³	PKUP 4	435	Picks up tenant's ringing CO calls. See Program *15 for Tenant Group assignments.
Call Pickup Tenant 3 ³	PKUP 3	436	
Call Pickup Tenant 2 ³	PKUP 2	437	
Call Pickup Tenant 1 ³	PKUP 1	438	
Call Pickup (Group) ²	Group Pickup	480	
Unanswered Caller ID and/or ANI Stored Number Auto Dial ¹	Lost Call Auto Dial (R3) or LCAD	462	Will Auto Dial a Caller ID and/or Automatic Number Identification (ANI) telephone number that was stored in station Caller ID/ANI memory.
CO Line Appearance	Line 1~200 or CO 001~CO 200	001~200	CO line access of appearing calls.
Data ¹	Data Call or DATA	456	Used to place data call.
Data Release ¹	Data Release or DRLS	454	Releases data call.
Direct Station Selection	DSS	#000~#239	Assigns DSS hotline keys to port number.
Directory Numbers (see following pages)			
Do Not Disturb ⁴	Do Not Disturb or DND	498	Prevents calls to station.
Door Lock 0 ~4 (DDCB/HDCB) ¹	Unlock Door 0 or DRLK 0 Unlock Door 1 or DRLK 1 Unlock Door 2 or DRLK 2 Unlock Door 3 or DRLK 3 Unlock Door 4 or DRLK 4	471 472 473 474 475	Momentarily unlocks door (3 or 6 seconds). See Program 77-1 and 77-2.
Handset Off-Hook Call Announce ¹	HS-OCA	468	Activates 2-way voice path to Off-Hook Call Announce caller. (R3)
ISDN Sub-address	Sub-address	467	Separates the called party's ISDN sub-address from the called party number. The # digit performs this function on standard telephones.
ISDN Start	Start	469	Initiates DK to send dialed digits to the ISDN network when this button is pressed from a digital or electronic telephone. Program *63-2 invokes the same function when the Dial Timer expires. Also see Tone Button in this table.
LCD Message Select	LCD Msg Select or LCD M	481	Begins LCD message selection.
Message Waiting and Flash	Msg Wait, Flash or MW/FL	499	Provides message waiting LED for EKT and Flash Button.
Microphone Cutoff ⁵	Microphn Cut-off or MCO	488	Sets microphone ON/OFF for incoming handsfree Directory Number [DN] calls.
Modem ¹	Modem or MODEM	455	Used to reserve modem in modem pool.
Night Transfer Tenant 1 ³	Night Transfer1 or NT1	439	Sets Tenant CO line DAY/NIGHT ring mode.
Night Transfer Tenant 2 ³	Night Transfer2 or NT2	440	
Night Transfer Tenant 3 ³	Night Transfer3 or NT3	441	
Night Transfer Tenant 4 ³	Night Transfer4 or NT4	442	
Night Transfer Lock Tenant 1	Night Lock1 or NT1 L1	431	
Night Transfer Lock Tenant 2	Night Lock2 or NT2 L2	432	Available with RCTUA3, RCTUBA3/RCTUBB3 or RCTUC/D3 Release 3 or above only. Used to lock system ringing mode: DAY, DAY2, NIGHT See Programs 74 and *36 for NT Lock Password assignments.
Night Transfer Lock Tenant 3	Night Lock3 or NT3 L3	433	
Night Transfer Lock Tenant 4	Night Lock4 or NT4 L4	434	
Pause ¹	Spd Dial Pause or PAU	495	
Pause (Long) ¹	Spd Dial Lng Pause or PAU/L	493	Sets a 10-second pause in Speed Dial.
Pooled Line	Pooled Line Grp or PL	301~316	Multiple CO line may appear under one button.
Privacy	Privacy On Line or PRIV	453	Prevents Privacy Override (not Executive Override).
Privacy Release	Privacy Release or PRV RLS	479	Changes station Privacy mode to Non-private for CO lines.

Table 3-1 Feature Button Codes for Digital, Electronic, and Strata AirLink Wireless Telephones (continued)

Button Function	Button Labels	Code	Notes
Redial Last Number (# Button)	Redial or RDL	496	Redials the last number.
Release to Idle	Release Call or RLS	476	Releases current call and makes station idle.
Release and Answer	Release and Ans or RLS/ANS	466	Simulates On-hook/Off-hook operation to release an existing call and answer new incoming/ringing call.
Save Last Dialed Number	Save Last Number on SAVE	485	Saves last number dialed for future speed dial.
Speed Dial Select (* Button) ⁶	Speed Dial or SDS	497	Begins speed dial selection.
Station Speed Dial Codes ⁶	SD (All DK systems)		Reserves button for station speed dial. Station Speed Dial code ranges vary per processor:
		* 10~ * 49	DK14, DK40i, RCTUA
		* 10~ * 49	RCTUBA/BB, RCTUC/D
		* 100~ * 139	RCTUE/F
System Speed Dial Codes ⁶	SD		Speed dial number set by station port 000. System Speed Dial code ranges vary per processor:
		* 60~ * 99	DK14, DK40i, RCTUA
		* 600~ * 699	RCTUBA/BB, RCTUC/D
		* 200~ * 999	RCTUE/F
Tone ¹	Tone Dial Select or TONE	490	CO dial signals set to tone or pulse.

1. Unavailable to Strata AirLink handsets (RWIU/WWIS interface).
2. Picks up calls to telephones in any call pickup group to which the telephone is assigned in Program *31.
3. See Program *15 for Tenant Group assignments.
4. The Strata AirLink handset (RWIU/WWIS interface) displays DND, but no warning tone is enabled for Executive or Busy Override.
5. The Strata AirLink handset (RWIU/WWIS interface) has mute only.
6. Both wireless system handsets (RWIU and Base Station Interface Adapter) only have an internal memory Speed Dial capability.

Notes

- The Strata AirLink “call” button is set using Program 39, key 01. It must be set as the PDN of the handset.
- Strata AirLink handset buttons 1~6 when used with the FCN button are set using Program 39, keys 02~07 respectively.

Directory Number Button Assignments

* * * 1 * 2 * 3 - Spkr 3 9 Hold - Spkr X X X # ■ # Y Y Y Hold - Spkr # # Hold - Spkr # # Hold

Enter the logical port number of the telephone that will be assigned a [DN] button.

Press the telephone button to which the [DN] button should be assigned.

...or

Z Z Z

YYY = the Program 04 Port Number (000–336) of the [DN] that should be assigned. If YYY=XXX, then the [DN] is the [PDN]; if YYY does not = XXX, then the [DN] is an [SDN].

ZZZ = the Program *04 Port Number (500–835) of the [PhDN] that should be assigned.

Directory Numbers are assigned to the flexible button positions on telephones.

- ♦ Primary Directory Number Buttons [PDNs] are similar to Intercom numbers.
- ♦ Secondary Directory Numbers [SDNs] are [PDNs] which appear on another telephone.
- ♦ Phantom Directory Numbers [PhDNs] are generally used as numbers that may appear on a group of telephones, such as an extension number which rings all phones in a department.
- ♦ There are a number of considerations for assigning Directory Numbers. Toshiba suggests reading the following steps and Directory Number Considerations before assigning [DNs].

► To assign directory numbers to flexible buttons

1. Refer to the next page to determine how many and what type of Directory Numbers to assign per telephone. You can use the Flexible Button Assignments forms to indicate where [DNs] will be placed (see “Program 39 Flexible Button Assignments” on Page 3-113).
2. Assign [PDNs] and [SDNs] by entering the Program 04 port number assignment sequence shown below. Refer to Program 04 for Station Logical Port Numbers.

##YYY, where YYY is the port number of the DN.

If a telephone has multiple [PDN] buttons, put the lowest number [NNNN-1] on the top, the next lowest number [NNNN-2] below that, etc. This is the order in which they will ring (from the top down). See the Directory Number Programming Example.

3. Assign [PhDNs] by entering the Program *04 port number assignment sequence shown below. Refer to Program *04 for Station Logical Port Numbers. Also refer to Program *33 to determine which Station Logical Port Number is the owner of the [PhDN].

##ZZZ, where ZZZ is the Program *04 port number of the [PhDN].

System & Station

Program 39 – Flexible Button Assignments

Button Type	Button Labels	Code	Notes
Primary Directory Numbers [PDNs] 4-Maximum of same [PDN] per telephone	[PDN] NNNN - 1, Highest button [PDN] NNNN - 2, next highest [PDN] NNNN - 3, next highest [PDN] NNNN - 4, Lowest button	##YYY ##YYY ##YYY ##YYY	YYY = the Program 04 station logical port number of the [DN] that should appear as a [PDN]. YYY should be the same port number as the port number (XXX) of the telephone to which the [PDN] is assigned. NNNN is the actual [DN] assignment for Port YYY in Program 04.
Secondary Directory Numbers [SDNs] 16 total [PDNs] + [SDNs]; 4-Maximum of same [SDN] per telephone	[SDN] NNNN - 1, Highest button [SDN] NNNN - 2, next highest [SDN] NNNN - 3, next highest [SDN] NNNN - 4, Lowest button	##YYY ##YYY ##YYY ##YYY	YYY = the Program 04 station logical port number of the [DN] that should appear as a [SDN]. YYY should not be the same port number as the port number (XXX) of the telephone on which the [SDN] is assigned. NNNN is the actual DN assignment for Port YYY in Program 04.
Phantom Directory Numbers [PhDNs] 8-Maximum unique [PhDNs] 1-Maximum of same [PhDN] per telephone	[PhDN] NNNN	##ZZZ	ZZZ = the Program *04 Port ref. number of the [PhDN]. NNNN is the actual [DN] assignment for Port ZZZ in Program *04. Each [PhDN] must have an owner telephone assigned in Program *33. If an owner is not assigned, the [PhDN] can originate but cannot receive calls.
Phantom Directory Number Message Waiting button [PhDN] 4- maximum [PhDN/MW] per telephone	[PhDN/MW] - 1 Lowest [PhDN] [PhDN/MW] - 2 Next Highest [PhDN/MW] - 3 Next Highest [PhDN/MW] - 4 Highest [PhDN]	423 424 425 426	Message Waiting Key for [PhDNs] assigned to telephone. Telephone must be assigned as [PhDN] owner in Program *33 to allow it to be equipped with a [PhDN/MW] button.

Directory Number Programming Example

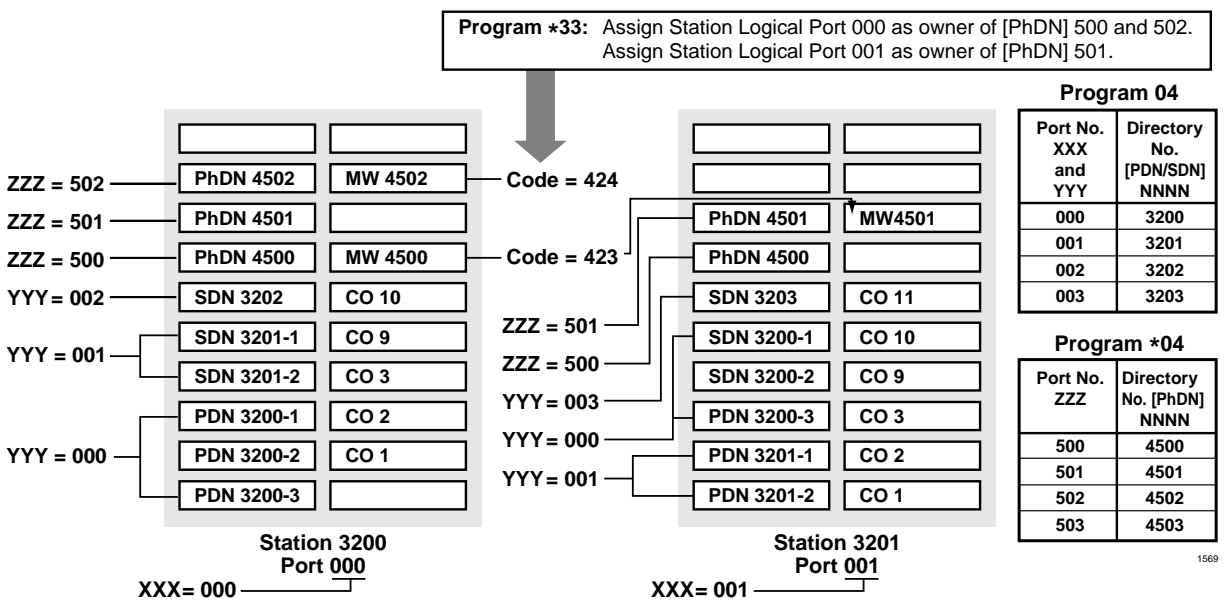

- ♦ The total number of [DNs] allowed on a telephone ([PDN], [SDNs], and [PhDNs]) is limited to the number of buttons on the telephone (i.e., a 20-button telephone can have 20 [DN] buttons).
- ♦ The number of [SDN] buttons programmed on a telephone for a given Primary Directory Number must always be the same as the number of [PDN] buttons that exist on the [PDN] owner telephone.

Example: If [PDN] 200 appears on 3 buttons on station 200, and [SDN] 200 should appear on station 201, then [SDN] 200 must appear on 3-buttons on station 201. Never put more (or less) [SDN] buttons of the same Directory Number on a telephone than [PDN] buttons that appear on the [PDN] owner telephone. If this guideline is not followed, calls to the [PDN] telephone will be missed on the [SDN] telephone.

- ♦ The maximum number of [DNs] per system is listed below:

Processor	Maximum [PDNs] per System	Maximum [PhDNs] per System	Total Number of Unique [DNs] per system [PDNs] + [PhDNs]
DK14	10	10	20
DK40i	27	27	54
RCTUA	32	32	64
RCTUBA/BB	80	80	160
RCTUC/D	240	240	480
RCTUE/F	336	336	672

- ♦ [PhDN] can appear on all Toshiba telephones in the system, but a [PhDN] is limited to ring on 120 telephones maximum.
- ♦ Phantom [DN] owner telephones have the following attributes:
 - ♦ Set Call Forward for [PhDNs]
 - ♦ Set Call Forward Mail Box destinations (VM ID codes) for [PhDNs]
 - ♦ Receive Message Waiting indication for up to four Phantom Directory Numbers on individual [PhDN/MW] button LEDs
 - ♦ When off-hook, the [PhDN] telephone owner will receive OCA calls directed to a busy the [PhDN].
 - ♦ [PDN] and/or [PhDN] Call Forward/Message retrieval can only be set/received from the [PDN] and/or [PhDN] owner telephone.

Alert Signal Button Assignments

* # * # 1 * 2 * 3 - Spkr 3 9 Hold - Spkr [] [] [] # [] [] [] Hold - Spkr # # Hold - Spkr # # Hold

Enter the logical port number of the telephone that will be assigned an **Alert Signal** button.

YYY = the Program 39 code for the **Alert Signal** button that should be installed.

Press the telephone button to which **Alert Signal** should be assigned.

Station Number: _____

Alert Signal Button		Button Number (01~20)	Speed Dial Number	Alert Signal Button Partner Station Number
No.	Code			
1	427			
2	428			
3	429			
4	430			

Station Number: _____

Alert Signal Button		Button Number (01~20)	Speed Dial Number	Alert Signal Button Partner Station Number
No.	Code			
1	427			
2	428			
3	429			
4	430			

The Alert Signal is four short bursts of tone, sent two times/three seconds apart from one partner station when the other partner station when one of the partners presses the **Alert Signal** button on their telephone. An Alert Signal can be sent to stations that are idle or busy, or in Call Forward or Do Not Disturb mode. No talk path will exist before or after the Alert Signal is activated.

Important!

- Both partner stations must have the same Alert Signal button number programmed in Program 39 and the appropriate Speed Dial Number programmed to allow the Alert Signal buttons to operate.
- Strata AirLink does not support this feature.

Alert Signal Button Programming Example

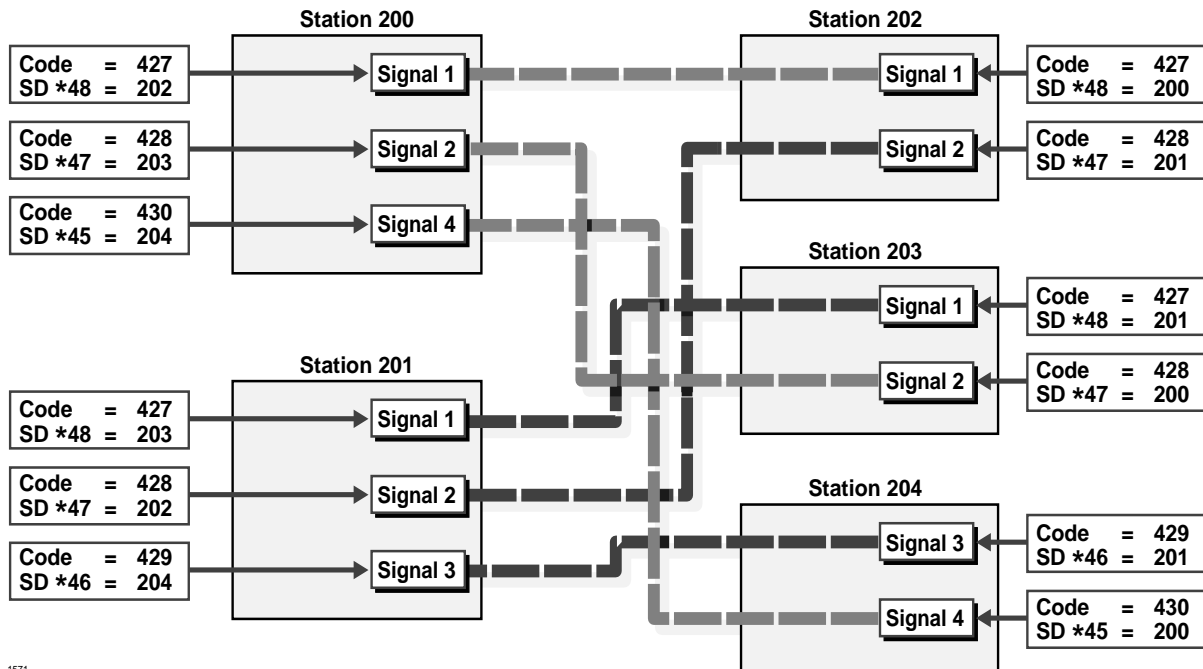

1571

Program *40 Overview

This program assigns the members (station primary [DN] port numbers and hunting orders [01~32] of Distributed Hunt (DH) groups [900~915]). When a member of a DH group is added or deleted, all the other members' hunting orders are automatically shifted to a new sequential order.

If Ground/Loop start CO lines ring DH Group member telephones, use Program 81~89 to assign the selected CO lines to ring the DH group (900~915); do not use *81, *84, and *87 to assign [PDNs] or [PhDNs] to flash and ring on the DH Group member telephones. Instead, put the CO lines in a pooled line group and put the appropriate **Pooled Line Grp** buttons on the DH member telephones. Do not assign DH Group member telephones to ring in Program 81~89.

To assign ANI/DNIS/DID/Tie and Internal calls to ring DH groups, use Program *04, *09, *71~*73, or 71 (1~3) as required and do not put DID or Tie line pooled or direct line buttons on DH member telephones. These calls ring the DH member telephone [PDN].

Each port assigned to a Program 31 Voice Mail Group should also be assigned to a dedicated Distributed Hunt Group. (See Program 31 record sheet overview for Voice Mail/Distributed Hunt program example.)

Program *41 for DK424 – T1 Assignment Series (Part 1)

Processor Type: RCTUBA/BB, RCTUC/D and RCTUE/F

Program Type: System

Initialized Default: See each program

Series Overview

Use Program *41 (Part 1) and *42 (Part 2) series to set T1 parameters and assignments on the DK424. See the Strata DK Configuration and T1 sections for additional T1 information. RCTU support is as follows:

Processor	Number of RDTU's Supported
RCTUBA/BB	2
RCTUC/D	6
RCTUE/F	8

Program *41-1 – T1 Span (RDTU) Frame and Line Code Assignments

Initialized Default: LED 01 and LED 02 OFF for all T1 span lines



SELECT = 1 ————
 Select the RDTU being programmed (1-8)

LEDs 01 and 02
 Set as described below.

T1 Span	Extended Superframe LED 01 ON	Superframe LED 01 OFF	B8ZS LED 02 ON	AMI Code LED 02 OFF
1 RDTU				
2 RDTU				
3 RDTU				
4 RDTU				
5 RDTU				
6 RDTU				
7 RDTU				
8 RDTU				

Program *41-1 Overview

T1 Span Framing Assignments: Each RDTU PCB can be individually assigned for Superframe (LED 01 OFF) or Extended Superframe (LED 01 ON).

T1 Span Line Code Assignments: Each RDTU PCB can be individually assigned for B8ZS (LED 02 ON) or AMI coding (LED 02 OFF).

Program *41-2 – T1 Channel Assignments

Initialized Default: 1 = Loop Start

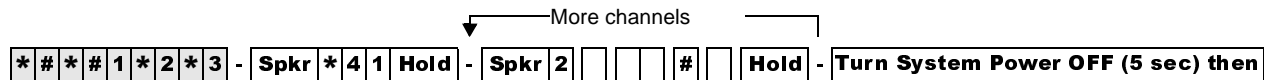

SELECT = 2

Enter the RDTU being programmed (1-8).

Enter the RDTU channel number (01-24) to be assigned a line type.

To add a port range, enter XXX*XXX (low port * high port).

Enter the line type to be assigned to the RDTU channel:

- 1 = Loop Start (initialized)
- 2 = Ground Start
- 3 = Tie (immediate)
- 4 = Tie (Wink)
- 5 = DID (immediate)
- 6 = DID (Wink)

See Programs 17 and 71 for other Tie/DID assignments;

See Program *17 and Program *09 for other DID assignments.

Processor	Line Range
RCTUBA/BB	001-048
RCTUC/D	001-144
RCTUE/F	001-200

RDTU: _____ Slot: _____

RDTU Channel No.	Line Type
1	
2	
3	
4	
5	
6	
7	
8	
9	
10	
11	
12	
13	
14	
15	
16	
17	
18	
19	
20	
21	
22	
23	
24	

RDTU: _____ Slot: _____

RDTU Channel No.	Line Type
1	
2	
3	
4	
5	
6	
7	
8	
9	
10	
11	
12	
13	
14	
15	
16	
17	
18	
19	
20	
21	
22	
23	
24	

RDTU: _____ Slot: _____

RDTU Channel No.	Line Type
1	
2	
3	
4	
5	
6	
7	
8	
9	
10	
11	
12	
13	
14	
15	
16	
17	
18	
19	
20	
21	
22	
23	
24	

Important! See Program 17 for other Tie/DID assignments; see Program *17 and Program *09 for other DID assignments.

System & Station

Notes

- You must cycle system power or run Program 91-2 to transfer Program *41-2 data from temporary memory to working memory. Turn system power OFF (five seconds) and ON after running Program *41-2.
- Always install RDTU PCBs that have Tie or DID channels in slot numbers that are higher than station and Attendant Console PCB slot numbers whenever possible. Each Tie or DID line installed uses a station port in software (see the Configuration worksheets for Tie/DID configuration in the *Strata DK Installation and Maintenance Manual*).

Program *41-2 Overview

RDTUs provide 8, 16, or 24 channels as set in Program 03. Each channel can operate independently as CO lines (ground start or loop start), Tie lines (Wink or Immediate Start), or DID lines (Wink or Immediate Start). Assign the number of channels for each RDTU with Program 03.

Important! Program 91-2 must be run or System Power must be momentarily turned OFF (five seconds) then ON for Program *41-2 to take effect.

Program *41-3 – T1 Span Transmit Level Pad Assignments

Initialized Default: 5 (-6dB)

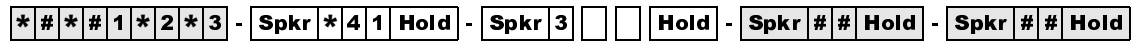

SELECT = 3 ————
 Enter the RDTU being programmed (1-8). ————
 Enter one of the following pad codes for the transmission of path:

- 1 = +6 dB pad
- 2 = +3 dB pad
- 3 = 0 dB pad
- 4 = -3 dB pad
- 5 = -6 dB pad (Initialized: PAD_S = 5)
- 6 = -9 dB pad
- 7 = -12 dB pad
- 8 = -15 dB pad

RDTU No.	1	2	3	4	5	6	7	8
PAD Code								

Program *41-3 Overview

The transmission path of each RDTU can be set for one of several pad settings:

Code	Decibel Level
Enter 1	+6 decibel (dB) padding
Enter 2	+3 dB
Enter 3	0 dB
Enter 4	-3 dB

Code	Decibel Level
Enter 5	-6 dB (initialized setting)
Enter 6	-9 dB
Enter 7	-12 dB
Enter 8	-15 dB

Program *41-4 – T1 Span Receive Level Pad Assignments

Initialized Default: 4 (-3dB)

* # * # 1 * 2 * 3 - Spkr * 4 1 Hold - Spkr 4 [] [] Hold - Spkr # # Hold - Spkr # # Hold

SELECT = 4

Enter the RDTU being programmed (1-8).

Enter one of the following pad codes for the transmission of path:

- 1 = +6 dB pad
- 2 = +3 dB pad
- 3 = 0 dB pad
- 4 = -3 dB pad
- 5 = -6 dB pad (Initialized: PAD_R = 4)
- 6 = -9 dB pad
- 7 = -12 dB pad
- 8 = -15 dB pad

RDTU No.	1	2	3	4	5	6	7	8
PAD Code								

Note See “Program *41-3 Overview” on Page 3-124 above for decibel levels.

Program *42 for DK424 – T1 Assignment Series (Part 2)

See “Program *42 – Clock Source” on Page 7-8.

Program *50 Overview

In DK40i and DK424, each analog ground/loop start CO line that receives Caller ID information from the local Central Office must be assigned to an RCIU or RCIS circuit using this program.

In DK14, each CO line that receives Caller ID must be assigned an MLX-41 interface box circuit number. For information regarding the MLX-41, see Chapter 1 - DK14 Installation in the *Strata DK Installation and Maintenance Manual*. This is necessary to allow Caller ID information to be recognized by the DK system processor. Any RCIU, RCIS or MLX-41 circuit can be assigned to any analog ground/loop start CO line circuit.

Each RCIU slot will be allocated eight Caller ID circuits when assigned with Code 81 in Program 03; because of this, you should always install RCIS on RCIU when more than four circuits are required. TCIU2 allocates four Caller ID circuits to TCOU.

Program *51 Overview

Use this program to allocate “Abandon-Call-Memory” when any LCD telephone must store abandon call information for Caller ID, Ground/Loop start line and/or ANI, DID/Tie lines.

On direct incoming calls that ring on more than one telephone, the Caller ID, Ground/Loop start, line must also be assigned to the designated abandon call storage LCD telephone in Program *52. If a CO line only direct-rings one telephone, that telephone will store the abandoned call information automatically without being assigned in Program *52; however, Program *51 is still required.

The IDL memory allocation displays on the program telephone’s LCD, indicating the total number of telephone numbers that can be stored at the designated port(s). These numbers are reduced accordingly each time memory is allocated to a station.

On direct incoming calls, the ANI abandon call information is stored in the “Abandon-Call-Memory” of the [PDN] owner or [PhDN] owner LCD telephone - depending on which [DN] rings when the call is received. Do not assign ANI/DNIS lines in Program *52.

Abandoned “Call-forwarded” calls will store Caller ID and/or ANI information in the “Abandon-Call-Memory” of the “first-call-forwarded-from-station”. The “first-call-forwarded-from-station” does not have to be assigned as the owner of the CO line in program *52 or as the owner of the [PhDN] in Program *33, but it must be assigned memory in this program.

Distributed Hunt Queue or DISA line, Abandoned Calls store ANI/Caller ID data in the Program *52 CO line owner station.

If a Caller ID CO line is programmed to direct ring more than one station (81~89) a station logical port must be assigned as owner of the ground and/or loop start Caller ID line (in Program *52) to be able to store Caller ID numbers on abandoned or unanswered calls on Direct Incoming calls.

If a Caller ID CO line is programmed (81~89) to ring only one station, that station will store Caller ID abandoned call information regardless of Program *52 data - the station must have storing memory assigned in Program *51. ANI abandoned call numbers will be stored in the telephone memory of the called Primary Directory Number [PDN] owner telephone or the called Phantom Directory Number [PhDN] owner telephone.

Transferred Caller ID and/or ANI line abandoned call numbers will be stored in the “transferred-to” telephone memory if that telephone is assigned memory in this program. (see Program *52). Call forwarded Caller ID and/or ANI line abandoned call numbers will be stored in the [PDN] or [PhDN] owner telephone memory if that telephone is assigned memory in this program.

ACD calls that are abandoned while the call is in queue or calls abandoned while connected to an Auto Attendant or VM device will register on the SMDR report as a call answered by the ACD announcement [DN], Auto Attendant [DN], or Voice Mail [DN].

Program *52 Overview

Use this program for any LCD telephone that must store abandon call information for Caller ID, Ground/Loop start lines and/or ANI, DID/Tie lines must be allocated “Abandon-Call-Memory” LCD telephones can be allocated memory to save up to 100 numbers in 10 number increments (see IDL totals).

When Caller ID and ANI lines ring into the Strata DK system and the caller hangs-up before the call is answered, the call is considered abandoned. In this case, the Caller ID and ANI information received can be stored at a designated LCD telephone. When a Caller ID line rings at more than one telephone (Program 81-89), the LCD telephone that should store the Caller ID information for that line must be programmed as the owner of that Caller ID line using this program.

When a Caller ID line rings only one LCD telephone (Program 81-89), the abandoned call Caller ID information will be stored at that LCD telephone regardless of the Program *52 assignment. The number of abandoned calls the station can store is set in Program *51.

An LCD telephone can be assigned as owner of any number of Caller ID lines. A Caller ID line can only be assigned to one owner LCD telephone.

If a Caller ID CO line or ANI Tie/DID line is answered by the, Distributed Hunt group queue, or DISA line, and if this call is abandoned before it is routed to and rings a station, the Caller ID or ANI data will be stored in the abandoned call memory of the station owner assigned to the Caller ID or ANI line assigned in this program.

Notes

- Abandoned “call-forwarded” calls will store Caller ID information in the “Abandon-Call-Memory” of the “first-call-forwarded-from-station”. The “first-call-forwarded-from-station” does not have to be assigned to the CO line in this program. To store abandon call information for CO lines, the station must also be allocated “Abandon Call Memory” in Program *51.
- If a Caller ID CO line is answered by the Strata DK Distributed Hunt Group Queue or DISA line, and if this call is abandoned before it is routed to and rings a station, the Caller ID data is stored in the abandon call memory of the station owner assigned to the Caller ID line assigned in this program.
- Tie/DID ANI lines store abandoned call ANI numbers on the Primary and/or Phantom Directory Number owner telephones if they are allocated memory in Program *51. Tie/DID ANI line calls that are abandoned while Distributed Hunt Group queue will store ANI information on the station owner assigned in this program.
- ACD or Auto Attendant calls that are abandoned while the call is in queue or calls abandoned while connected to an Auto Attendant or VM device will register on the SMDR report as a call answered by the ACD announcement [DN], Auto Attendant [DN], or Voice Mail [DN].

Program 58 – DK424 Attendant Console Series (Part 1)

Processor Type: RCTUBA/BB, RCTUC/D and RCTUE/F

Program Type: Station

Initialized Default: see each program

Program 58-1 – Attendant Console Overflow Timer

Initialized Default: 32 seconds

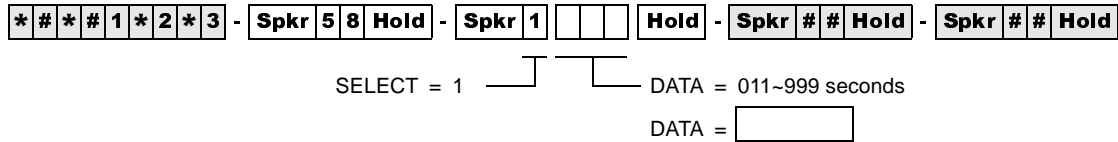

Program 58-1 Overview

Incoming Line Calls (not recalls) to attendant consoles will overflow to a designated attendant console or station port (Program 58-5) if the call is not answered within the time (011~999 seconds) specified by this program. The overflow call will ring on either the **In-Trans** button (assigned in Program 59) of the console that receives the overflow call, or the [DN] or CO **Line** button of a station.

Notes

- This program sets overflow timer for all attendant consoles (1~4)
- The overflow destination is assigned in Program 58-5.

Program 58-2 – Attendant Console Display Type

Initialized Default: All LEDs OFF

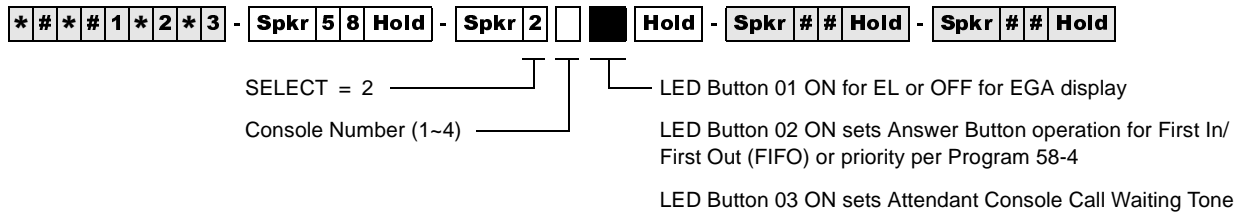

Attendant Console	Button 01 LED		Button 02 LED		Button 03 LED	
	ON (EL)	OFF (EGA)	ON (FIFO)	OFF (58-4)	ON (Call Waiting Tone)	OFF (No Call Waiting Tone)
1						
2						
3						
4						

Program 58-2 Overview

This program identifies in software the type of display connected to each console. It also enables you to set priorities for types of incoming calls. You can also enable Call Waiting tones.

LED 01: Attendant Console Display Type

Base units can connect to an Electroluminescent (EL) display (LED 01 ON) or Extended Graphics Adapter (EGA) Display (LED 01 OFF).

LED 02: Answer Button Operation

The attendant console **Answer** button can be programmed to answer calls on either a First-in, First-out (FIFO) or a Priority basis. With FIFO, new calls or recalls are stacked in queue in the order in which they are received. This is true regardless of the type of call/recall (CO line, Intercom, [DN] call or Hold Recall, etc.). The queued calls ring to the **Answer** button in the order in which they are received.

With Priority operation, each type of incoming call or recall (CO line call, [DN] call, Hold Recall or Park Recall, etc.) is assigned a specific answering priority ranging from 1~6. (Call Priority is flexible and is assigned in Program 58-4.) Calls will queue to the attendant in order of their predetermined priority levels. For example, Priority Level 1 calls ring to the attendant before Priority 2 calls; Priority 2 calls ring before Priority 3 calls, and so forth.

LED 03: Attendant Console Call Waiting Tone

Each attendant console can be programmed individually to receive a muted ring signal that will alert the console that a new call is waiting while the console is busy on another call. If call waiting tone is not enabled, new calls do not present an audible indication. The call waiting display always displays the number of calls waiting to be answered.

Program 58-4 – Attendant Console Answer Button Priority Assignments

Initialized Default: 0, 1, 2, 3, 4, 5, 6

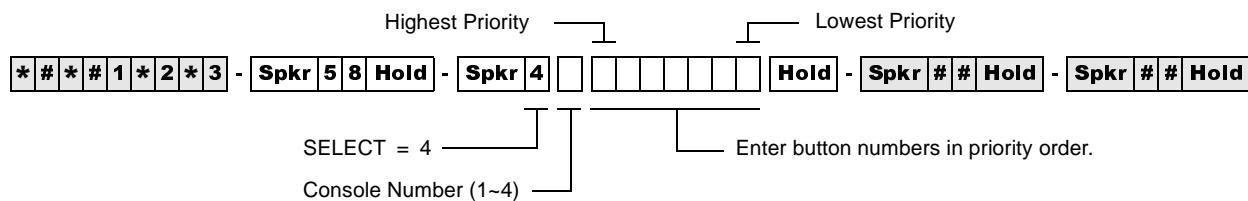

Button Name	Park-RC	Trans RC	Hold-RC	In-Trans	LINE	In Dial "O"	[PDN]
Button Number	0	1	2	3	4	5	6

Program 58-4 Overview

Each incoming call or recall type can be assigned a specific **Answer** button priority level, ranging from 0~6. If the **Answer** button is assigned Priority answer operation in Program 58-2, then incoming calls/recalls will ring to the **Answer** button based on their assigned priority levels. Priority 1 calls have the highest priority while Priority 6 calls have the lowest.

Notes

- EMRG has first priority over the above key assignments.
- See Program 59 for the function of each button.

Program 58-5 – Attendant Console Overflow Destination Assignments

Initialized Default: *Blank*

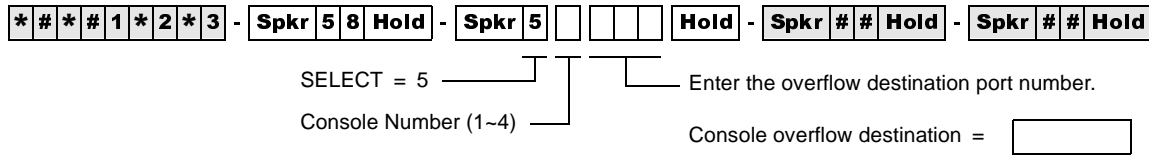

Processor	[PDN] Port Range	Max. Consoles
RCTUBA/BB	000-079	2
RCTUC/D	000-239	4
RCTUE/F	000-335	4

Program 58-5 Overview

When the attendant console has been placed in the Overflow mode (via the **Overflow** button), calls queue to be answered based on the predetermined FIFO or priority basis. If a call remains in queue for a period longer than the time period set for the Overflow Timer (set in Program 58-1), then the call will overflow to the destination assigned in this program.

The assigned destination can be either a station, voice mail, auto attendant, or another attendant console.

- Calls that will overflow include ring transfer, incoming CO **Line**, dial “0”, and **Attd Call** button calls; Transfer Recall (**In-Trans**) and **Hold** recall will not overflow.
- Overflow recall time is set in Program 58-1.

Program 59 – Attendant Console Flexible Button Codes

Processor Type: RCTUBA/BB, RCTUC/D, RCTUE/F

Program Type: Station

Initialized Default: Given throughout this section



Attendant Console (1~4)

1 = Left
2 = Right

DATA = Button Code
See legend.

Press LED Buttons 01~12 on Programming Telephone to enter data for corresponding console button.

Codes (Left Buttons 1-12)

Split (295)	Join Loop (239)	Sup. Loop (296)
In-Emrg (261)	In-DN (257)	In-Dial "0" (262)
In-Trans (258)	Trans-RC (260)	Hold-RC (259)
In-LG3 (243)	In-LG2 (242)	In-LG1 (241)

Codes (Right Buttons 1-12)

Conf (297)	Overflow (299)	Night (439)
Redial (496)	Spdial (497)	SD13 (*13)
BLF (298)	Out Dial (294)	SD12 (*12)
Attd Call (000)	SD10 (*10)	SD11 (*11)

Console 1

Left

10		11		12	
07		08		09	
04		05		06	
01		02		03	

Right

10		11		12	
07		08		09	
04		05		06	
01		02		03	

Console 2

Left

10		11		12	
07		08		09	
04		05		06	
01		02		03	

Right

10		11		12	
07		08		09	
04		05		06	
01		02		03	

Console 3

Left

10		11		12	
07		08		09	
04		05		06	
01		02		03	

Right

10		11		12	
07		08		09	
04		05		06	
01		02		03	

Console 4

Left

10		11		12	
07		08		09	
04		05		06	
01		02		03	

Right

10		11		12	
07		08		09	
04		05		06	
01		02		03	

Program 59 Overview

Attendant Consoles have 24 flexible buttons (12 on left and 12 on the right side of the dial pad). This program is used to assign each button to an available function or options. Program 59 record sheets define the button options (and codes) available.

Table 3-2 Required PC Attendant Console Button Codes

Button Function	Button Labels	Code	Notes
Conference	Conf	297	Starts conference calls.
Hold Recall	Hold-RC	259	Held calls recall on this button.
Incoming Dial "0"	In-Dial "0"	262	Dial "0" calls ring in on this button.
Incoming Directory Number	In-DN	257	Incoming calls to the console DN ring on this button. The console [DN] is the Prog 04 assignment of the Prog 04 console port number.
Incoming Ring Transfer	In-Trans	258	Receive call transfer.
Join-Loop	Join-Loop	293	Connects any held call to an existing call.
Out Dial	Out Dial	294	Switches ATTD consoles dial pad from digital to tone mode.
Redial Last Number (#)	Redial or RDL	496	Redials the last number.
Release to Idle	Release Call or RLS	476	Releases current call and makes station idle.
Speed Dial Select (*)	Speed Dial or SDS	497	Begins speed dial selection.
Split Call	Split	295	Allows attendant to talk to either party separately on a conference call.
Supervised Loop	Sup Loop	296	Places call on attendant hold loop key so attendant can supervise call.
Transfer Recall	Trans-RC	260	No answer transferred calls, recall on this button.
Attendant Call	Attd Call	000	Can originate calls on this button. The Attendant Call LED is lit red any time the attendant talk path is connected.

Table 3-3 Recommended PC Attendant Console Button Codes

Button Function	Button Labels	Code	Notes
Display BLF	BLF	298	Displays BLF on CRT or EL display.
Incoming Emergency	In-Emrg	261	Indicates to all consoles an incoming emergency call.
Message Waiting/Flash	Msg Wait, Flash or MW/FL	499	Indicates a message from station or VM device to Attendant. Disconnects and recalls dial tone on CO line; accesses Centrex or PBX features; enters pause or flash during speed dial programming.
Overflow	Overflow	299	Places console in the call overflow mode.
Park Recall	Park-RC	263	Parked calls recall on this button.

Table 3-4 Incoming Line Group Button Assignments

In-LG1~241	In-LG5~245	In-LG9~249	In-LG13~253
In-LG2~242	In-LG6~246	In-LG10~250	In-LG14~254
In-LG3~243	In-LG7~247	In-LG11~251	In-LG15~255
In-LG4~244	In-LG8~248	In-LG12~252	In-LG16~256

Table 3-5 Optional Attendant Console Button Codes

Button Function	Button Labels	Code	Notes
Alarm	Alarm Reset or ALRM	477	Resets alarm condition system-wide.
Call Pickup Tenant 1~Call Pickup Tenant 4	PKUP 1~PKUP 4	435~438	Picks up tenant 3's ringing CO calls.

Table 3-5 Optional Attendant Console Button Codes (continued)

Button Function	Button Labels	Code	Notes
CO Line Appearance	Line 1~48 Line 1~144 Line 1~200	001~048 001~144 001~200	CO line access of appearing calls. CO line ranges vary according to processor: RCTUBA/BB RCTUC/D RCTUE/F
Door Lock 0~Door Lock 4 (DDCB/HDCB)	DRLK 0~4	471~475	Momentarily unlocks door (3 or 6 seconds). The PC attendant activates these options when these buttons are assigned.
Emergency Page Access	Emrg Page	292	Activates ALL CALL Paging to telephone speakers (not EXTR Page). Overrides any existing ALL CALL page.
Night Transfer Tenant 1~Tenant 4	Night Transfer1 or NT1~Night Transfer4 or NT4	439~442	Sets Tenant 1 CO line DAY/NIGHT ring mode.
Privacy	Privacy On Line or PRIV	453	Prevents Privacy Override (not Executive Override).
Privacy Release	Privacy Release or PRV RLS	479	Changes station Privacy mode to Non-private for CO lines.
Pause	Spd Dial Pause or PAU	495	Sets pause in Speed dial (see Program 12-3.)
Pause (Long)	Spd Dial Lng Pause or PAU/L	493	Sets a 10-second pause in Speed Dial.
Unanswered Caller ID and/or ANI Stored Number Auto Dial	Lost Call Auto Dial or LCAD	462	Will Auto Dial a Caller ID and/or Automatic Number Identification (ANI) telephone number that was stored in station Caller ID/ANI memory.

Table 3-6 Additional Feature Button Codes

Button Function	Button Labels	Code	Notes
Account Code	Account Code or ACCNT	450	Allows a Voluntary Account Code to be entered.
Alert Signaling	Alert 1~4	427~430	Console can alert another station but another station cannot alert the console. See Program 39 for more information.
All Call Voice Page	All Call Page or AC	489	Pages up to 120 idle electronic or digital telephones over speaker.
Automatic Busy Redial	Auto Busy Redial or ABR	470	Sets ABR of busy outgoing number.
Automatic Callback Busy	Auto Callback or ACB	494	Sets ACB for station recalled by busy line.
Call Forward All Calls	Call Frwd All Calls or CFAC	487	All calls forward to selected station.
Call Forward A.C. Fixed	Call Frwd to: or CFF	486	Forwards all calls to pre-defined destination. See Program 36.
Call Forward Busy	Call Frwd Busy or CFB	459	Forwards calls to selected station if station is busy.
Call Forward Busy/No Answer	Call Frwd Busy/NAAns or CFB/NA	457	Forwards calls to selected station if station is busy or does not answer.
Call Forward External	Call Frwd External or CF-EXT	460	Forward calls externally.
Call Forward No Answer	Call Frwd No Answer or CFNA	458	Forwards calls to selected station if station does not answer.
Call Park	Park in Orbit or PARK	464	Call Park Only.
Call Park LCD Display	Park Orbit Display or CPD	465	CP Display Button and Mode 64 can be used interchangeably. Displays call parked via telephone LCD.
Call Park and Page	Call Park/Page or CP/PG	463	Parking and Paging Park Pickup.
Call Pickup (Directed)	Directed Pickup or PKUP	484	Picks up ringing or held intercom, trunk calls, and page.

Table 3-6 Additional Feature Button Codes (continued)

Button Function	Button Labels	Code	Notes
Call Pickup (Group)4	Group Pickup	480	Picks up a call to any group to which station is assigned in *31.
Do Not Disturb	Do Not Disturb or DND	498	Prevents calls to station.
ISDN Sub-address	Sub-address	467	Separates the called party's ISDN sub-address from the called party number. The # digit performs this function on standard telephones.
ISDN Start	Start	469	Initiates DK to send dialed digits to the ISDN network when this button is pressed from a digital or electronic telephone. Program *63-2 invokes the same function when the Dial Timer expires. Also see Tone Button in this table.
LCD Message Select	LCD Msg Select or LCD M	481	Begins LCD message selection.
Night Transfer Lock Tenant 1~Night Transfer Lock Tenant 4	Night Lock1 or NT1 L1~Night Lock4 or NT4 L4	431~434	Used to lock system ringing mode: DAY, DAY2, NIGHT See Programs 74 and *36 for NT Lock Password assignments.
Release and Answer	Release and Ans and RLS/ANS	466	Simulates On-hook/Off-hook operation to release an existing call and answer new incoming/ringing call.
Save Last Dialed Number	Save Last Number or SAVE	485	Saves last number dialed for future speed dial.
Station Speed Dial Codes	SD	*10~*49 *10~*49 *100~*139	Reserves button for station speed dial for the following processors: RCTUBA/BB RCTUC/D RCTUE/F
System Speed Dial Codes	SD	*600~*699 *600~*699 *200~*999	Speed dial number is set by station port 000. RCTUBA/BB RCTUC/D RCTUE/F
Tone	Tone Dial Select or TONE	490	CO dial signals set to tone or pulse. For ISDN applications, after the user presses the Tone Dial Select button, any digits dialed after it will be sent using DTMF tones.

Notes

- See Program *15 for Tenant Group assignments.
- Picks up calls to telephones in any call pickup group to which the telephone is assigned in Program *31.
- Attendant consoles cannot be equipped with [SDNs] or [PhDNs]. The console [DN] is assigned to the console port number in Program 04. The console's [DN] can have only one appearance.
- Attendant consoles cannot be equipped with [PDNs], [SDNs], or [PhDNs]. The [In-DN] button is the console's [DN], assigned in Program 04; it supports incoming calls only and can only appear once on a console.

Program 60-1 – SMDR Data Output Options

Processor Type: *DK14, DK40i, All RCTUs*

Program Type: *System*

Initialized Default: *LED 01 OFF*

* # * # 1 * 2 * 3 - Spkr 6 0 Hold - Spkr 1 Hold - Spkr # # Hold - Spkr # # Hold

SELECT = 1 Light the LED Buttons that are marked with an X in the table below.

LED/Button	X	LED ON	LED OFF
20			
19			
18			
17			
16			
15			
14			
13			
12			
11			
10			
09			
08			
07			
06			
05			
04			
03			
02			
01		Caller ID, ANI and DNIS data will be sent from the system SMDR port	Account code data will be sent from the system SMDR port

System & Station

Program 60-1 Overview

Program 60-1 determines which information will be sent out the system SMDR port: System Account codes or Caller ID and/or ANI telephone numbers.

Turn LED 01 ON if received Caller ID and/or ANI information should be sent out the system SMDR port.

Turn LED 01 OFF if Account Code information should be sent out the system SMDR port.

Note LED 01 determines if received Caller ID and/or ANI information (LED 01 ON) or data is sent out the SMDR port. This data is output on the last 15-digit (right hand) field columns of the SMDR print out.

Program 60-2~7 – SMDR Output/Account Code Digit Length

Processor Type: DK14, DK40i, All RCTUs

Program Type: System

Initialized Default: Item 2: 10 seconds
 Item 3: SMDR output is enabled for answered incoming/outgoing calls
 Item 4: a 6-digit length is assigned to all Forced/Voluntary Account Codes
 Item 7: 21 digits

* # * # 1 * 2 * 3 - Spkr 6 0 Hold - Spkr [] [] [] [] Hold - Spkr # # Hold - Spkr # # Hold

SELECT = 2~7 (Item) ———— See table below.

Make a selection from the table below.

Item	Description	Data
2	SMDR Threshold Time 0 = 1 second 1 = 10 seconds	Time
3	SMDR Output when a call is completed 0 = Outgoing Only 1 = Incoming and Outgoing	SMDR COR
4	Forced/Voluntary Account Code Digit Length 04~15 (See Program 69 for Verified Account Codes) Digits are verified per Program 30, Button/LED 14 and Program 69	Account
5	SMDR Printout Options Toll Dial: 0 = All Calls (item 3, printout outgoing call only is still available) 1 = Dial "0" calls only 2 = Dial "1" calls only 3 = Dial "00" calls only 4 = Dial "1", "0" calls only 5 = Dial "1", "00" calls only	Toll Dial Data
6	DISA Security Code 01~15 digits, may be changed from station, per Program 30 If a security code is not programmed, outgoing trunk access via DISA will not require a security code when dialing.	Data Button 01 = blank Button 02 is wild card (any digit from 1~9)
7	Credit Card Call Digit Length, 01~30 digits (see Program 43)	Credit Number of digits required when "0" is the first digit dialed; if this number of digits is not dialed, the system will disconnect the call after 20 seconds. "0" is counted as a digit. Example: 0 + 714 + 583 - 3700 = 11 digits; 11 should be programmed as a minimum in this case.

Program 60-2-7 Overview

This program assigns the type of data to send to the Station Message Detail Report (SMDR).

Item 2: SMDR Threshold Time

The time that a call must be in progress before it will register with SMDR can be set to 1 or 10 seconds.

Item 3: SMDR Output

System output to a Station Message Detail Recording (SMDR) device can include information for both incoming and outgoing calls, or only for outgoing calls. Local and long distance call data will be sent out.

Item 4: Forced/Voluntary Account Code Digit Length

The Account Code entered at a station can vary in length from 4~15 digits. For Forced Account Code use, a call will not be completed unless the specified number of digits is entered by a station user. In the case of Voluntary Account Codes, the Account Code will not be sent to the SMDR call record unless the specified number of digits is dialed. Initialized data assigns a six-digit length for all Account Codes. See Program 60-1 and Program 69 for Verified Account Codes.

Item 5: Station Message Detail Recording (SMDR) Printout Options

This option selectively deletes local call data and allows long distance/toll call data only to be sent out the SMDR port. The type of long distance/toll call data that prints out is selected by long distance prefix codes 0, 1, 00, or 1 or 0.

Item 6: Direct Inward System Access (DISA) Security Code

The optional security code (1~15 digits) is required for incoming DISA calls to access outgoing CO lines. If the DISA security code is not set in programming, DISA users can access outgoing lines without dialing a security code. This code is not required for DISA internal calls to stations. The DISA security code can also be changed from stations enabled in Program 30. If the DK280 built-in Auto Attendant is installed, make sure to program a DISA security code to prevent Auto Attendant callers from making unauthorized external DISA calls by using the DISA access feature (Dial *).

Item 7: Credit Card Call Digit Length

Station users bypassing Toll Restriction with the “0 +” Credit Card Calling feature (Program 43) must dial a predetermined number of digits including the “0.” This predetermined number is established with Item 7, and can be 1~30 digits. Set 11 digits in this program when using LCR.

Notes

- If PBX code is dialed, numbers dialed after the code will be checked.
- If A/C, O/C or SPCC code begins with “0”, “1”, or “00”, that call will print out.
- When accessing LCR feature, all digits sent to CO will be output.

Program 60-8 – Call Forward External (Remote Change, Security) ID Code

Processor Type: DK14, DK40i, All RCTUs

Program Type: System

Initialized Default: No digits

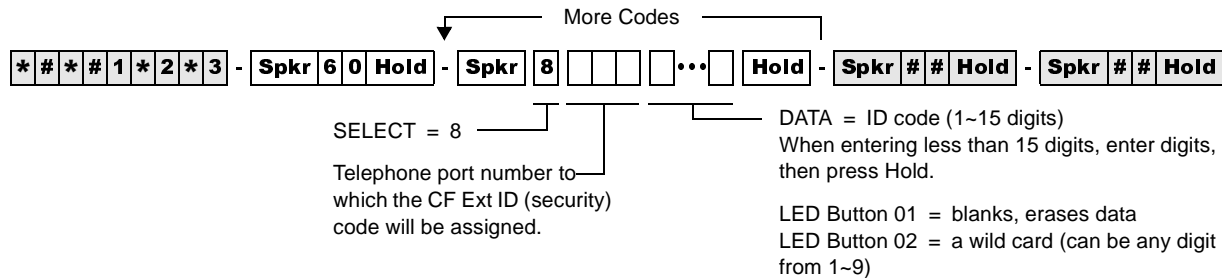

Processor	[PDN] Port Range
DK14	000-009
DK40i	000-027
RCTUA	000-031

Processor	[PDN] Port Range
RCTUBA/BB	000-079
RCTUC/D	000-239
RCTUE/F	000-335

Telephone Port Number	CF/EKT ID Code (1-15 digits)

Telephone Port Number	CF/EKT ID Code (1-15 digits)

Telephone Port Number	CF/EKT ID Code (1-15 digits)

Program 60-8 Overview

Changes a telephone’s External Call Forward destination to [PDNs] but not [PhDNs] from outside the system. The person that wishes to change the destination must call into a DISA CO line, enter the telephone’s [PDN] + **#670** and then enter a security code plus the destination telephone number. CF/EXT ID code must be assigned to a telephone to allow callers to change the Call Forward-External destination of that telephone from a remote location by calling in on a DISA CO line.

The security code (1~15 digits) for each telephone is set with this program.

Important!

To allow Call Forward External, CO lines must be enabled for the following:

- Two CO line connection in Program 10-1 and Program 15-5.
- Outgoing Access in Program 41 including DISA port numbers.

Program 69 Overview

Verified Account Codes (VACs) may be added, deleted, or changed with Program 69. Each Verified Account Code can be 1~15 digits long, but cannot exceed the Account Code length requirement set in Program 60-4.

Account Codes may not conflict with (be the same as) emergency numbers in Program 44-91~93.

The following programs and options should be considered when establishing Verified Account Codes.

Account Code Digit Length

Program 60-4 sets the digit length that must be dialed for all Account Codes: Forced (Verified/Nonverified) and Voluntary (Verified/Nonverified).

Full and Partially Verified Account Codes

Verified Account Codes can contain the same number of digits (full Verified Account Code) or less (partially Verified Account Code) than the length set in Program 60-4.

If the quantity of digits in a VAC is the same as the Account Code digit length in Program 60-4, then all digits will be Verified; if the quantity of digits is less, then only those digits will be verified. Stations must have LED 14 ON in Program 30 to use Verified Account Codes.

If partially verified, the first part of the Account Code is verified and the remainder is not. For example, if VAC 2734 is set in Program 69, but the digit length is set to eight in Program 60-4, then the user must dial 2734 plus any other four digits to enter a partially Verified Account Code. There are many applications for partially VACs. For instance, using the code in the example above, the numbers 2734 could be the user's dial restriction code and the remaining four digits could be a customer-client code, a sales order, etc.

Verified Account Code Toll Restriction Assignments

A Toll Restriction Class can be assigned with Program 70 to each of the 300 VACs. This feature can be used to change a telephone's Class of Service to allow long distance calls from restricted telephones only when a verified account code is entered before dialing the long distance number. These calls will be recorded with the account code on the system SMDR output.

Verified Account Code Dial Requirement

Assigned on a station-by-station basis in Program 30, LED 14 ON. All Account Codes dialed (Forced or Voluntary) from stations assigned in this program will be verified.

Code Change

Stations selected in Program 30, LED 15 ON, can change VACs by dialing the following:

[PDN] + **#659** + **000~499** + VAC + **Redial**

Verified Account Codes: Forced/Voluntary Program Options

Any station can dial a VAC after accessing a CO line—by pressing the **Speed Dial + 50** (DK14, DK40, RCTUA~C/D), **Speed Dial + 050** (RCTUE/F), or by pressing the **Account Code** button. Forced Account Code requirements are assigned via station and line program options: stations are assigned in Program 30, LED 08 ON; and lines are assigned in Program 15-7. Stations must dial VACs when assigned in Program 30, LED 14 ON. Direct Inward System Access (DISA) callers that access outgoing lines can be required to enter Verified Account Codes with Program 30 (LED 08 ON for Port 99).

Program 70 – Verified Account Code Toll Restriction Assignments

Processor Type: DK14, DK40i, All RCTUs

Program Type: System

Initialized Default: 000 for all VACNs



SELECT = Verified Account Code Number (VACN)

DATA = VAC Digit Restriction
 0 = No Digit Restriction
 1 = Digit Restriction

VAC Restrict Code (00~10)

- 00 =No Station Toll Restriction
- 01 =Area Code Toll Restriction
- 02 =Area Code Toll Restriction and 0 or 1 as 1st (or 2nd digit)
- 03 =Class 1 T.R.07 = Class 5 T.R.

Processor	VACN
DK14	000-299
DK40i	000-299
RCTUA	000-299

Processor	VACN
RCTUBA/BB	000-299
RCTUC/D	000-299
RCTUE/F	000-499

VACN	VAC Digit Restrict Code	VAC Restrict Code

VACN	VAC Digit Restrict Code	VAC Restrict Code

VACN	VAC Digit Restrict Code	VAC Restrict Code

System & Station

Program 70 Overview

A Toll Restriction Class can be assigned with this program to each of the 300 Verified Account Codes assigned in Program 69. This class of restriction overrides the normal station class of restriction assigned in Program 48 when a VAC is entered at the station. The station resumes its Program 48 restriction after the call is disconnected.

When a Forced or Voluntary Verified Account Code is dialed at a station after accessing a CO line and before dialing a telephone number, the station temporarily assumes the Toll Restriction Class assigned to the Verified Account Code. When Program 70 is initialized, all Verified Account Codes are assigned as not Toll Restricted (data = 00). Verified Account Code Toll Restriction class assignments are not user programmable; so if the assignments are not known, it is recommended to assign a number (block) of Verified Account Codes to each type of Toll Restriction class. For example:

VACs 000~050 = no restriction

VACs 051~100 = total restriction

VACs 101~150 = Class 1, etc.

- ♦ When stations enter VACs they will be unrestricted.
- ♦ Range programming is not available.
- ♦ If dial “0” credit card dialing is allowed, use Program 43 to allow designated stations/CO lines credit card calling.

Program 71 – DNIS

Processor Type: DK40i, all RCTUs
Program Type: System
Initialized Default: All Programs blank

DNIS Addresses

Processor	DNIS Address	ANI Address
DK14	NA	NA
DK40i	000~199	199
RCTUA	000~199	199

Processor	DNIS Address	ANI Address
RCTUBA/BB	000~349	349
RCTUC/D	000~499	499
RCTUE/F	000~499	499

Program 71-0: DID / Tie / DNIS / ANI Lines

* # * # 1 * 2 * 3 - Spkr 7 1 Hold - Spkr 0 [] [] [] [] Hold - Spkr # # Hold - Spkr # # Hold

DNIS Address (see legend above)

DNIS Number (2~5 digits)

Press LED Button 01 to blank out data.

Program 71-1~3: DNIS Number and ANI Line Routing Assignments

* # * # 1 * 2 * 3 - Spkr 7 1 Hold - Spkr [] [] [] [] Hold - Spkr # # Hold - Spkr # # Hold

Enter 1, 2, or 3

- 1 = Day Ring Assignment
- 2 = Day2 Ring Assignment
- 3 = Night Ring Assignment

Ringing Destination (see legend below)

Use LED Button 01 to blank out data.

DNIS Address (see legend above)

For ANI-only lines, enter address (only one assignment is provided for ANI lines without DNIS, see legend above).

DNIS/ANI Routing Destinations

Route to Ports	[PDN]	[PhDN]	DH [DN]	ACD	IMDU/RMDS	Network Table
DK40i	0000~0027	0500~0527	0900~0915	NA	#031	#300~#399
RCTUA	0000~0031	0500~0531	0900~0915	NA	#035	#300~#399
RCTUBA/BB	0000~0079	0500~0589	0900~0915	#090~#097	#085	#300~#499
RCTUC/D	0000~0239	0500~0739	0900~0915	#250~#265	#245	#300~#599
RCTUE/F	0000~0335	0500~0835	0900~0915	#345~#360	#340	#400~#699

All Processors: External Page = #039

All processors except RCTUE/F: Night Ring Over External Page = #271

Night Ring Over External Page for RCTUE/F = #366

Program 71-4: DNIS and ANI Only Lines Voice Mail ID Assignments

* # * # 1 * 2 * 3 - Spkr 7 1 Hold - Spkr 4 ... Hold - Spkr # # Hold - Spkr # # Hold

DNIS Address
(see legend above)

VM ID Code

Important! *DNIS VM ID codes operate with in-band DTMF tone VM integration only; not with SMDI VM integration.*

Enter VM ID code that should be sent to Voice Mail when the selected DNIS number Call-Forwards or rings directly to Voice Mail (1~16 digits).

Press LED Button 02 to enter *
Press LED Button 03 to enter #
Press LED Button 04 to enter Pause

Program 71-5: DNIS Number Name Display

* # * # 1 * 2 * 3 - Spkr 7 1 Hold - Spkr 5 ... Hold - Spkr # # Hold - Spkr # # Hold

DNIS Address
(see previous legend)

DNIS NAME TAG (up to 16 characters)

Use the character entry procedures that follow Program 93 record sheets. NAME TAG displays on LCD telephones when a DNIS Call rings in.

DNIS Record Sheet

DNIS Address	DNIS Number (1-5 digits) 71-0	DNIS Number Routing Points (71-1, 71-2, 71-3)			DNIS Number VM ID Code (1~16 digits) 71-4	DNIS Number Name (1~16 characters) 71-5
		1	2	3		

A DNIS and/or Tie/DID extension number and/or ANI only line can be assigned to route one of the following destinations:

- ♦ Primary Directory Number [PDN] - secondary appearances of this [PDN] will also ring if Programmed to ring in Program *71, *72, and/or *73
- ♦ Phantom Directory Number
- ♦ Distributed Hunt Group
- ♦ ACD Group
- ♦ Outside telephone number routed externally over the Public Telephone Network
- ♦ The system remote maintenance modem
- ♦ Night ringing over the external page
- ♦ The external voice paging system (Private Network Tie lines only)

A DNIS number or ANI only line can be assigned to route to one destination only in each of the three system ringing modes (Day, Day2 and Night); the destination can be unique or different in each ringing mode. For each DNIS Tie/DID extension number, the routing destination can be a unique destination or it can be the same destination as that assigned to other DNIS numbers. To assign lines that receive both ANI and DNIS with each call to Program 71-1 assignments: Program 17, LED 05, 07 and 08 must be turned ON; for lines that receive DNIS digits only, LED 05 and 08 must be ON.

This program can also be used with non-DNIS or non-ANI Tie and/or DID lines to route calls. In this case, the normal Tie digit assignments in Program 04 and DID digit assignments in Program *09 will not be active - Program 17, LED 06, 07, 08 must be OFF and LED 05 must be ON for normal Tie/DID lines.

The last address (499 for RCTUC3/D3, RCTUE3/F3; 349 for RCTUBA3/B3; and 199 for RCTUA3 or DK40i) in Program 71-0 is used to assign ANI only lines to a routing destination. All ANI only lines must be assigned to the same routing destination; this destination can be unique in each of the ringing modes (Day/Day2/Night).

To assign an ANI only Tie/DID line to Program 71-1 assignments: Program 17, LED 05 must be turned OFF and LED 07 and 08 must be ON for lines that receive ANI digits only.

Program 71-4 Overview

This feature is available when using DTMF In-band VM integration only; it is not provided with SMDI VM integration.

This Program assigns a Voice Mailbox ID (VMID) number to each DNIS/Tie/DID extension number and/or ANI only lines. This allows each DNIS/Tie/DID extension number and/or ANI only lines to be routed to a unique Voice Mail box when the number directly rings or is Call Forwarded to the Voice Mail system. When a DNIS/Tie/DID extension number or ANI line rings a station that has call forwarding set to Voice Mail, the DNIS/Tie/DID extension or ANI VMID is sent to the VM machine (if programmed in Program 71-4). If a DNIS/Tie/DID extension or ANI VMID is not programmed, the Call Forwarding station's VMID is sent to the voice mail machine when the DNIS/Tie/ DNIS extension or ANI call forwards to VM. This program can also be used with non-DNIS Tie and/or DID lines to assign VMID digits to normal Tie or DID numbers.

The last address (499 for RCTUC3/D3, RCTUE3/F3; 349 for RCTUBA3/B3, and 199 for RCTUA3 or DK40i) in Program 71-4 can be used to assign a VMID code to ANI only lines. All ANI only lines will be directed to the same Voice Mailbox.

To assign an ANI only Tie/DID line to Program 71-4 assignments: Program 17, LED 05 must be turned OFF and LED 07 and 08 must be ON for lines that receive ANI digits only.

Program 71-5 Overview

This program is used to assign names to each DNIS number. The names for each DNIS/Tie/DID extension number is normally supplied by the customer. Each DNIS name can be up to 16 alphanumeric characters. The DNIS/Tie/DID extension name will display on a telephone's LCD when the DNIS/Tie/DID extension number rings the telephone directly or is transferred, Call Forwarded, or Hunted to the telephone.

To assign a Tie/DID line to Program 71-5 assignments: Program 17, LED 05 must be turned ON for lines that should display DNIS/Tie/DID extension name tags. When a Tie/DID line receives both DNIS and ANI digits on the same call, Program 17, LED 06 determines what information, DNIS extension name or ANI number, will display as a priority when the line rings incoming to the system.

This program can also be used with non-DNIS or ANI Tie and/or DID lines to display names, associated with the Tie or DID numbers, on telephone LCDs. In this case, the normal Tie digit assignments in Program 04 and/or DID digit assignments in Program *09 will not be active.

Important!

- *An individual telephone user can disable/enable the DNIS name display by using the Mode 60/61 function on his/her LCD telephone.*
- *The DNIS extension name can be assigned or not assigned to display as a priority over the ANI display (in Program 17, LED06) when both ANI and DNIS digits are received on the same call.*
- *If a name is not assigned to a DNIS number, DN:XXXX will display on telephone LCDs when the DNIS/Tie/DID line rings into the DK system (where XXXX = actual DNIS/Tie/DID digits received).*

System & Station

Program *71~*73 – [DN] to [DN], Tie to [DN], and DID to [DN] Ringing Assignments

Program *71~*73 – [DN] to [DN], Tie to [DN], and DID to [DN] Ringing Assignments

Processor Type: DK14, DK40i, All RCTUs

Program Type: System

Initialized Default: [PDNs] are programmed to immediately ring their respective telephones in Program *71; no other default ringing assignments are made.

* # * # 1 * 2 * 3 - Spkr * 7 [] Hold - Spkr [] [] [] # EK Button Hold - Spkr # # Hold

Enter: _____
1 = Immediate Ring
2 = Delay 1 Ring (12 sec. delay)
3 = Delay 2 Ring (24 sec. delay)

To add a port range, enter
XXX*XXX (low port * high port).

Press the button associated with the telephones (EKs) that should ring when the selected [DN] is called.

Port Reference Number of that should ring [PDN] or [PhDN]

Press **Scroll** to advance or **Page** to go back.
Press Vol▲ to turn all LEDs ON.
Press Vol▼ to turn all LEDs OFF.

Processor	[PDN] Port	[PhDN] Port
DK14	000~009	500~509
DK40i	000~027	500~527
RCTUA	000~031	500~531

Processor	[PDN] Port	[PhDN] Port
RCTUBA/BB	000~079	500~589
RCTUC/D	000~239	500~739
RCTUE/F	000~335	500~835

[DN] Port Reference Number	EK Telephone Ports (The Program 04 [PDN] port number of the telephones that should ring.)

Important! In the EK Telephone Ports column, enter the Program 04 telephone ports of the telephones that should ring when the [DN] is called from another [DN] or a Tie or DID line (maximum of 120 telephones can be assigned to ring). The [DN] button must be assigned (Program 39) to the telephone that should ring.

First Telephone Group

Buttons 01~20 on the programming telephone are associated with the telephone groups displayed on the telephone LCD.

- GRP EK000 = Telephone Port 000 is represented by programming button 01...
- GRP EK001 = Telephone Port 001 is represented by programming button 02...
- GRP EK019 = Telephone Port 019 is represented by programming button 20.

Second Telephone Group

In telephone group “GRP 020~039”, the relationship is as shown below:

- GRP EK020 = Telephone Port 020 is represented by programming button 01...
- GRP EK021 = Telephone Port 021 is represented by programming button 02...
- GRP EK039 = Telephone Port 039 is represented by programming button 20.

Program *71, *72, *73 Overview

Primary/Phantom Directory Number and Telephone Ringing assignments:

- ♦ This program assigns telephones to ring when a [PDN] or [PhDN] that appears on the telephone is dialed from another telephone (direct or transferred call). The [PDN] may appear as an [SDN] on other telephones that should ring.
- ♦ This program assigns telephones to ring when a call is routed from a Tie, DID, DNIS, DNIS/ANI or ANI only line to a [PDN] or [PhDN] that appears on the telephone. The [PDN] may appear as an [SDN] on other telephones that should ring.
- ♦ Calls that Call Fwd, Hunt, or are transferred to a [PDN] or [PhDN] will ring on telephones per Program *71, *72, and *73 ringing assignments. The [PDN] or [PhDN] must appear on a flexible button (as a [PDN], [SDN], or [PhDN]) of telephones that should ring.

Important! *120 Telephones (maximum) can be programmed to ring for any given [PDN], [SDN] or [PhDN] in Program *71, *72, and *73 combined.*

For the above case:

- ♦ Telephones can be programmed to immediately Ring (*71 assignments), delay ring after 12 seconds (*72 assignments), or delay ring after 24 seconds (*73 assignments) for each [PDN] or [PhDN] button that appears on the telephone.
- ♦ The called [PDN], [SDN], or [PhDN] button must be programmed to appear (Program 39) on all Telephones that should ring.

Program 72 Overview

This program defines the external Network routing numbers that can be assigned DNIS/Tie/DID extension numbers in the Day, Day2, or Night ringing mode. This assignment will cause incoming DNIS/Tie/DID calls to route (forward) back out over a public, or private, telephone network to a pre-assigned telephone number.

To assign a Tie/DID line to Program 72 assignments: The DNIS/Tie/DID extension number must be assigned to route to the appropriate Network routing number in Program 71-1.

This program can also be used with non-DNIS or ANI (only), Tie and/or DID Lines to assign normal incoming Tie/DID calls to route back out over the public, or private telephone network to an external telephone number.

Important!

- *Tie/DID lines used for DNIS network routing must be enabled with tandem (Two-CO line) connection with Program 15, Code 5 and Program 10-1, LED 20.*
- *DNIS Network routing numbers will not be restricted by DK424 Toll Restriction assignments.*
- *Tie/DID lines must have LED05 ON in Program 17 to use the (DID, Tie) DNIS routing assignments in Program 71 and 72.*
- *DNIS network calls are timed by the Program 12 disconnect timer which, if set to default, will disconnect the call after four minutes. The disconnect timer may be disabled (see “Program 12 – System Assignments, Basic Timing” on Page 3-41).*

Program 74 – System NT Button Lock Password

Processor Type: DK14, DK40i, All RCTUs

Program Type: System

Initialized Default: Port 000 for all tenants

* # * # 1 * 2 * 3 - Spkr 7 4 Hold - Spkr [] [] [] [] Hold - Spkr # # Hold - Spkr # # Hold

Tenant Number (1~4) DATA = Night Lock Password for selected Tenant (4-digits)

Tenant Number	NT Lock Password (4 Digits)			
1				
2				
3				
4				

Program 74 Overview

This program assigns the password for each **Night Transfer** or **Night Transfer1~4** button. To lock the system ringing mode requires a password and two buttons: **Night Transfer** and **Night Transfer Lock**.

- ♦ **Night Transfer** switches the station to Night Transfer mode.
- ♦ **Night Transfer Lock** + the Night Lock password, locks the **Night Transfer** button into that ringing mode.

The Strata DK system provides three system ringing modes (Day/Day2/Night). The system ringing modes are controlled by the **Night Transfer** button which is programmed on a flexible button of a telephone or attendant console. Each ringing mode allows incoming calls to be routed to different destinations.

Programs related to Program 74 are:

Program 39, which assigns the **Night Transfer** and **Night Transfer Lock** buttons to stations. Also, these station(s) must be assigned as the designated Night Transfer Lock station in Program *36.

Program 59, which assigns **Night Transfer/Night Transfer Lock** buttons to attendant consoles. Attendant consoles and stations (assigned in Program *36) can also change the **Night Transfer Lock** button password using a special access code. Program *36 is not required to assign attendant consoles to Night Transfer Lock functions.

Also see Programs 39, *36, *15 and 77-3.

Program 76-1(X-Y) – DK14, DK40i, All RCTUs

Processor Type: DK14, DK40i, All RCTUs

Program Type: System

Initialized Default: Port 1 (Type 1), Ports 2~4 (Type 0)

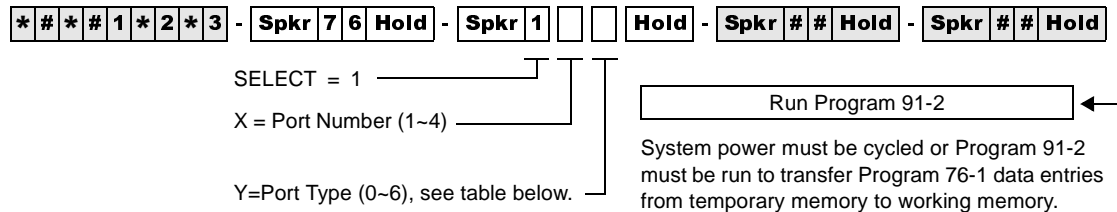

Port Number	Port Type (0~6)
1	
2	
3	
4	

Program 76-1 Overview

This program assigns each installed WSIU (DK14 only), TSIU (DK40i only) or RSIU/RSIS (DK424 only) port to a function.

For Program 76-1(X-Y):

X identifies the WSIU, TSIU port number 1~2 or RSIU/RSIS/RMDS port number 1~4.

Y identifies the WSIU, TSIU or RSIU/RSIS/RMDS port function as shown below:

Port Type (Y)	Function
0	No port equipped. This should be used for any of the four RSIU/RSIS/RMDS ports that are not used.
1	TTY or modem ¹ . TTY RS-232 port (set Program 77-1, LED 14 OFF; DK14, DK40i or DK424). RMDS modem port (set Program 77-1, LED 14 ON; DK424).
2	SMDR
3	MIS or SMIS (DK424)
4	SMDI
5	Open Architecture Interface (see Program 77-4) (DK424 R3.2)
6	Caller ID output to Caller ID interface box (DK14 only) ²

1. If port type code 1 is set, then Program 77-1, LED 14 status determines if the port operates as a system administration/maintenance modem (LED 14 ON) or an RS-232 administration/maintenance TTY port (LED 14 OFF). For modem operation, an RMDS piggy-back PCB is required, for RS-232 TTY port, a TSIU, WSIU, RSIU/RSIS/RMDS PCB may be used.

2. If the DK14 CO lines must pass Caller ID information to the Toshiba telephones, LCD/RPCI-DI, an interface box, TC1041 (MLX-41), must be connected to one of the WSIU outputs. For more information, see the Caller ID instructions in Chapter 1 – DK14 Installation of the *Strata DK Installation and Maintenance Manual*.

- ♦ Port types set in this program override RSSU, PIOU, and/or PIOUS function codes (41, 42, 43) set in Program 03. To activate changes made to this program, system power must be turned off/on or Program 91-2 must be run.
- ♦ Communication Parameters: SMDI, MIS or SMIS, TTY, IMDU/RMDS, Caller ID, OAI: 7 bits, even parity, 1 stop bit. SMDR: 8 bits, no parity, 1 stop bit.

Program 76-2 (X-Z) – WSIU, TSIU and RSIU / RSIS / RMDS Transmission Rates

Processor Type: DK14, DK40i, All RCTUs

Program Type: System

Initialized Default: All ports 2400 bps

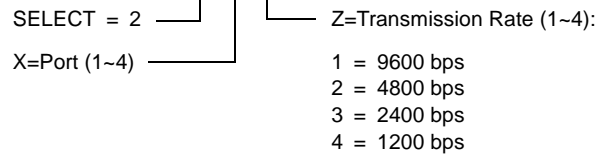
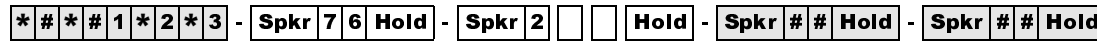

Port Number (x)	Data Transmission Rate (z)
1	
2	
3	
4	
	Total
Note	Total must be ≤ 9600 bps.

Program 76-2 Overview

Assigns each installed WSIU (DK14 only), TSIU (DK40i only) or RSIU port to operate at a specified transmission rate. Where X identifies the WSIU, TSIU port number 1~2 or RSIU/RSIS/RMDS port number 1~4 and Z identifies the WSIU, TSIU or RSIU/RSIS/RMDS port data transmission rate in bits-per-second (bps).

Whenever uploading Program 76 with DKAdmin/DKBackup, the bps rate of the DKBackup/DKAdmin customer database (on the PC) and the WSIU, TSIU or RSIU/RSIS/RMDS TTY/RMDS port must all be set the same. If the bps rate of these items are not the same, uploading Program 76 will fail.

The sum of the transmission rates of equipped WSIU, TSIU or RSIU/RSIS/RMDS ports cannot exceed 9600 bps. Ports assigned “no-function” (code 0) in Program 76-2X-Y will not be included in the transmission rate sum. The RMDS will only function at 1200 or 2400 bps on the DK424 (see Program 77-1 LED 15).

Program 76-2 does not require system power OFF/ON to change the bps rate.

Program 77-1 – Peripheral Options (Door Phones) RSIU / RSIS / RMDS, PIOUS/PIOUS / IMDU, PEPU

Processor Type: DK14, DK40i, All RCTUs

Program Type: System

Initialized Default: All LEDs are OFF

* # * # 1 * 2 * 3 - Spkr 7 7 Hold - Spkr 1 Hold - Spkr # # Hold - Spkr # # Hold

SELECT = 1 Light the LED Buttons that are marked with an X in the table below.

LED/ Button	X	LED ON	LED OFF
20		Door Lock Time/6 seconds	Door Lock Time/3 seconds
19		Port 028/DDCB 4 or HDCB 4 (DK424)	Port 028/Telephone (DK424)
18		Port 020/DDCB 3 or HDCB 3 (DK40i/DK424)	Port 020/Telephone (DK40i/DK424)
17		Port 012/DDCB 2 or HDCB 2 (DK424) Port 012/DDCB 2 or HDCB 2 (DK40i Expansion Unit) Port 003/DDCB 2 (DK14)	Port 012/Telephone (DK40i Expansion Unit, DK424). Port 003/Telephone (DK14).
16		Port 004/DDCB 1 or HDCB 1 (DK424) Port 004/DDCB 1 (DK40i) Port 002/DDCB 1 (DK14)	Port 004/Telephone (DK40i, DK424). Port 002/Telephone (DK14).
15		RMDS Modem Protocol CCIT (2400 bps)	RMDS Modem Protocol Bell212A (1200 bps)
14		RMDS/IMDU Modem (DN #19)/Enabled	RMDS/IMDU Modem (DN #19)/Disabled
10		Enable DKAdmin/Backup ACK/NAC Protocol	Disable DKAdmin/Backup ACK/NAC Protocol
08		Door Phone Ring on External Page in Night Mode	No Ring on External Page in Night Mode
07		Door Lock Relay Enabled	External Page Relay Enabled
06		NT Relay with NT1 and NT2 Button and Ringing CO Line	NT Relay Steady with NT1 Button (DK424 only)
05		MOH Relay Enabled	NT Relay Enabled
04		—	—
03		—	—
02		LED 02 applies to DK14/DK40i only. LED 01 has priority.	External Page on Base Unit Relay Enabled
01		LED 01 applies to DK14/DK40i only. MOH on Base Unit Relay Enabled	NT on Base Unit Relay Enabled

System & Station

Program 77-1 Overview

This program performs the following functions:

- ♦ Programs door lock relays
- ♦ Assigns door phones/lock control units
- ♦ Enables RMDS/IMDU built-in maintenance modems
- ♦ Sets RMDS communications standard type
- ♦ Enables DKAdmin Communications Protocol
- ♦ Enables/disables door phone ring tone to external paging when system is in Night mode
- ♦ Assigns a relay to operate with door lock function or external page for mute control
- ♦ Assigns a relay to operate in one of two Night Transfer modes
- ♦ Assigns a relay to operate in one of two applications

LED 20: Door Lock Time

The Door Lock Relay contact may be programmed to operate for either three or six seconds (applies to PIOU, PIOUS, PEPU, DDCB, and HDCB door lock controls).

LEDs 16~19: Port Number/Door Phone/Lock Control Units

Door phone/lock existence is defined by this program. The door lock option is set via Program 77-2.

- ♦ **DK424:** Door phone/lock controllers (DDCBs and/or HDCBs) can only exist at Ports 004, 012, 020 and 028, and can only be installed on Circuit 5 of a PDKU, RDSU, PEKU and/or PESU. PDKUs and RDSUs support DDCBs, but not HDCBs. PEKUs and PESUs can support HDCBs, but not DDCBs. After assignment of a DDCB or HDCB, door phone numbers (#151~#159, #161~#163) effectively replace the station number assignment in Program 04.

Up to four DDCBs/HDCBs can be installed in a system with RCTUB, RCTUBA/BB and C/D, only 3 are allowed with RCTUA. They must be assigned a PDKU, RDSU, PEKU or PESU port number to operate (DDCB to PDKU or RDSU, and HDCB to PEKU or PESU). (See Program 79 and *79 for door phone ringing assignments)

Station PCBs that are connected to HDCB/DDCB door phones control boxes must be installed in lower slot numbers than Tie, DID, or Attendant Console PCBs.

- ♦ **DK40i and DK14:** See port information on record sheet.

LED 15: RMDS Protocol

This program sets the RMDS communications standard type to CCITT/V.22bis (2400bps) or Bell 212A (1200bps). The standard set in this program must match the standard of the modem that will be used to communicate with the Strata DK RMDS.

- ♦ If the RMDS modem standard should be 2400bps/CCITT/ V.22bis, turn LED 15 on; if the RMDS standard is a 1200 bps/Bell 212A, turn LED 15 off. Most Hayes compatible modems will function with either standard; check with the modem manufacturer's documentation to verify which protocol should be used. When the system is initialized the Bell 212A (1200 bps) standard is set (LED 15 off).
- ♦ IMDU can be 1200 bps or 300 bps as set by SW2 on the PIOU or PIOUS PCB; RMDS can be 1200 bps or 2400 bps as set in Program 76-2 and Program 77-1 LED 15.

LED 14: RMDS or IMDU Modem

DK424: This program enables the DK424 built-in maintenance modem function: RMDS or IMDU. If LED 14 is off, the RSIU Port (1~4) which is set for TTY operation (Code 1 in Program 76-1) will operate as a local RS-232 maintenance port. If RSIU is not configured as TTY, then the PIOU/PIOUS/RSSU that has code 41 set in Program 03, will operate as a local TTY maintenance port.

Only one DK424 built-in modem RMDS or IMDU can be used in the DK424; if both are installed, RMDS will be accessed when a CO line direct rings the modem or is transferred to the modem by dialing **Cnf/Trn+#19**.

- ♦ **DK40i:** Turn LED 14 ON if the optional PIOU or PIOUS has Remote Maintenance from the IMDU modem subassembly. If an IMDU is installed on a DK40i PIOU or PIOUS, it can be accessed by dialing station #19 (unless the access code prefix has been changed with Program 05).

Other system Programs that are related to the system modem are: Program 76, RMDS/TTY assignments on RSIU PCB; *-51~53, system CO line to modem ringing assignments; Program 71-1, DNIS line to modem ringing assignments; Program *09, DID line to modem ringing assignments; Program 77-1, LED 15, RMDS modem Protocol/speed assignments.

If a modem unit (RMDS/IMDU) is installed, it can be accessed by dialing Station #19 and can be assigned a DID extension number in Program *09 or in Program 71 (1~3). See Program 79 and Program *79 for door phone ringing assignments.

LED 10: DKAdmin/Backup

Enables the system to Upload/Download the RCTU RAM data base using Toshiba DKAdmin and/or DKBackup software program. DKAdmin/Backup will automatically turn LED 10 ON when the DKAdmin/Backup PC communicates with the DK424. LED 10 should be OFF if the maintenance PC is using standard communication software (such as Procomm™) to program the DK424.

LED 08: Door Phone Ring On External Page

If a door phone button is pressed, a ring tone can be enabled or disabled to external paging when the system is in the Night mode. Activation of a Tenant 1 **Night Transfer1** button is required to activate this feature. The Tenant 2~4 **Night Transfer2~4** buttons do not apply to door phones.

CO lines must be assigned to night ring over External Page (Program 78-1) to allow the NT relay to operate when incoming CO lines ring. See Programs 79 and *79 for door phone ringing assignments.

LED 07: Door Lock Relay/External Page Relay

A relay on the PIOU, PIOUS, or PEPU can be assigned to operate with the Door Lock function or with External Page for mute control. The door lock button (**Unlock Door0~4**) is assigned in Program 39; the door lock activation time is assigned in Program 77-1. This door lock function is not associated with the DDCB or HDCB door lock, but is an addition to them.

This option applies to the PIOU/PIOUS/PEPU Door Lock Control 0 assigned to electronic or digital telephone buttons using Code 471 in Program 39; it does not apply to DDCB or HDCB Door Lock Control.

LED 06: NT Relay

A relay located on the PIOU, PIOUS, PEPU, DK14 KSU or DK40i KSU can be assigned to operate in one of two Night Transfer modes (see next item, MOH/NT Relay).

- ♦ **DK14:** Activate the NT Relay in the DK14 KSU *before* setting the specific Night Transfer mode with LED 06.
- ♦ **DK40i:** Activate the NT Relay on the PIOU or PIOUS with LED05, or activate the NT Relay on the DK40i KSU with LED 01 before setting Night Transfer mode with LED 06.

In one mode, the relay will activate for one second, then be idle for three seconds when a line rings (incoming) while the system is in the Night mode. The intended application is to control an external ringing device at night.

Program 78 or Program 71 (1~3, Code #271) must have Ring Over External Page activated for this feature. In the second mode, the relay will operate continuously while the NIGHT mode is activated. One application for this mode is to control an external answering machine.

CO lines must be assigned to night ring over External Page (Program 78-1) to allow the NT relay to operate when incoming CO lines ring.

LED 05: MOH/NT Relay (DK40i, DK424)

A relay on the PIOU, PIOUS, or PEPU can be assigned to operate in one of two applications. A choice must be made between use for Night Transfer application (see NT Relay, LED 06) or Music-on-Hold (MOH). If used for MOH, the relay will activate when any trunk or station is placed on hold. The intended application is to control a tape player which can be used as a Music-on-Hold source.

LEDs 02 and 01: MOH/NT/External Page Relay (DK14 and DK40i)

For KSU relay to MOH, LEDs 01 and 02 must be ON.

For NT function, LED 02 must be ON, LED 01 OFF.

For External Page function, LED02 must be OFF, LED 01 can be ON or OFF.

Program 77-2 – Door Phone Busy Signal/Door Lock Assignments

Processor Type: DK14, DK40i, All RCTUs

Program Type: Station

Initialized Default: All LEDs are OFF

* # * # 1 * 2 * 3 - Spkr 7 7 Hold - Spkr 2 ████ Hold - Spkr # # Hold - Spkr # # Hold

SELECT = 2  Light the LED Buttons that are marked with an X in the table below.

LED/ Button	X	LED ON	LED OFF
20		One Door Phone Ring	Five Door Phone Rings
19		—	—
18		—	—
17		—	—
16		DDCB4/HDCB4 B-jack is Lock Control #4 (DK424)	B is connected to Door Phone 4B
15		Door phone 4C Busy Out	No Busy Signal
14		Door phone 4B Busy Out	No Busy Signal
13		Door phone 4A Busy Out	No Busy Signal
12		DDCB4/HDCB3 B-jack is Lock Control #3 (DK40i/ DK424)	B is connected to Door Phone 3B
11		Door phone 3C Busy Out	No Busy Signal
10		Door phone 3B Busy Out	No Busy Signal
09		Door phone 3A Busy Out	No Busy Signal
08		DDCB4/HDCB2 B-jack is Lock Control #2 (DK424) DDCB2 B-jack is Lock Control #2 (DK40i, DK14)	B is connected to Door Phone 2B
07		Door phone 2C Busy Out	No Busy Signal
06		Door phone 2B Busy Out	No Busy Signal
05		Door phone 2A Busy Out	No Busy Signal
04		DDCB4/HDCB1 B-jack is Lock Control #1 (DK424) DDCB1 B-jack is Lock Control #2 (DK40i, DK14)	B is connected to Door Phone 1B
03		Door phone 1C Busy Out	No Busy Signal
02		Door phone 1B Busy Out	No Busy Signal
01		Door phone 1A Busy Out	No Busy Signal

System & Station

Program 77-2 Overview

This program performs three functions:

- ♦ Sets number of times door phone rings
- ♦ Sets fast busy tone if the called door phone does not exist
- ♦ Configures B-pack on DDCB/HDCB output for door lock control

LED 20: Door Phone Ring Count

The number of times that a door phone will ring digital and electronic telephones is set with this LED. Light the LED for one ring; turn it OFF for five rings. The default is five rings. See Program 79 to assign which telephones will be rung by door phones.

LEDs 01, 02, 03, 05, 06, 07, 09, 10, 11, 13, 14, and 15: Door Phone Busy Out

Each door phone controller (DDCB or HDCB) can interface with up to three door phones. The system treats each controller as a station. Therefore, this is quite different from all other station arrangements using telephones. Only one door phone can be in used at one time. The system does not automatically know how many door phones are connected to each DDCB or HDCB, so it must be told.

This program is used to enter that information so that a caller will receive fast busy tone if the called door phone does not exist. Door phones 1A, 1B, 1C are numbered #151, #152, #153, respectively, and are connected to the DDCB or HDCB at Port 004. Door phones 2A, 2B, 2C are numbered #154, #155, #156, respectively, and are connected to the DDCB or HDCB at port 012, etc.

LEDs 04, 08, 12, and 16: Door Lock Assignments

Each B-jack on the DDCB and HDCB output can be configured for door lock control. Door lock control buttons (**Unlock Door0~4**) for door locks are assigned to electronic or digital telephones in Program 39. Door lock activation time is set in Program 77-1. Each DDCB requires one PDKU or RDSU circuit, and each HDCB requires one PEKU or PESU electronic telephone circuit. These door locks are not associated with, but are in addition to the door lock control provided by the PIOU, PIOUS, or PEPU PCB.

CAUTION! To prevent system malfunction, DO NOT install the RDSU or PESU in slot 18 of the DK40i system.

DK424	
DDCB/HDCB Slot Number	Port Number
11	004
12	012
13	020
14	028

DK40i, DK14		
DDCB Type	DK40i Port Number	DK14 Port Number
DDCB1	004	002
DDCB2	012	003
DDCB3	020	NA

Program 77-3 – Night Ringing Over PIOU External Page Zones

Processor Type: DK40i, All RCTUs

Program Type: System

Initialized Default: Zones 1~4 assigned to tenant 1

* # * # 1 * 2 * 3 - Spkr 7 7 Hold - Spkr 3 Hold - Spkr # # Hold - Spkr # # Hold

SELECT = 3
Enter a PIOU external page zone relay (1~4).

Enter the tenant (1~4) to be assigned with the zone entered in the preceding step.

These assignments apply to ground and loop start lines only; they do not apply to DID and Tie lines.

Tenant	Zone 1	Zone 2	Zone 3	Zone 4
Tenant 1 CO Lines				
Tenant 2 CO Lines				
Tenant 3 CO Lines				
Tenant 4 CO Lines				

Program 77-3 Overview

Each tenant's CO lines can be assigned to ring over selected PIOU external page zones during the NIGHT mode. Lines must be allowed to Night Ring over External Page in Program 78 or Program 71 (1~3, Code #271) for this feature to work. Tenant assignments are made in Program *15.

Program 77-4 – RSIU Open Architecture Interface (OAI) Data Output Assignments

Processor Type: All RCTUs (Release 3.2 and above)

Program Type: System

Initialized Default: All LEDs are OFF



SELECT = 4 Light the LED Buttons that are marked with an X in the table below.

LED/ Button	X	LED ON	LED OFF
20			
19			
18			
17			
16			
15			
14			
13			
12			
11			
10			
09			
08			
07			
06			
05			
04			
03			
02		DNIS Number will be sent from OAI port	DNIS Number will not be sent from OAI port
01		Caller ID/ANI will be sent from OAI port	Caller ID/ANI will not be sent from OAI port

Program 77-4 Overview

This program is used to enable Caller ID, Automatic Number Identification (ANI), and/or Dialed Number Identification Service (DNIS) Numbers (received) to be sent from the RSIU Open Architecture Interface (OAI) port. The OAI port sends MIS data for ACD calls (only) along with ANI, Caller ID and/or DNIS Numbers received on ACD calls depending on LED 01 and LED 02 option settings. ANI, Caller ID and/or DNIS numbers on non-ACD calls will not be sent out the OAI port for non-ACD calls.

LED 01/LED 02: RSIU Open Architecture Interface (OAI) Data Output Assignments (Caller ID/DNIS/ANI/OAI Output Options)

Turn LED 01 ON if the OAI port should send Caller ID and/or ANI information for ACD calls and LED 02 ON if the OAI port should send DNIS Number (not DNIS NAME) for ACD calls. LED 01 and 02 may be ON or OFF in any combination.

RCTU PCB requires RKYS4 and RSIU to provide MIS, Caller ID, ANI, and DN information via the system OAI port.

Program 78 – CO Line Special Ringing Assignments

Processor Type: DK14, DK40i

Program Type: Station

Initialized Default: All LEDs are OFF

* # * # 1 * 2 * 3 - Spkr 7 8 Hold - Spkr Hold - Spkr # # Hold - Spkr # # Hold

Feature Number 1, 2, 5, or 6
 Code 1~3

CO Line
 Specify CO lines with LED Buttons as defined by the table below. All LEDs with an X should be lit when finished.
 Press **Scroll** to advance or **Page** to go back.

After programming, press:
 Press **Vol▲** to turn all LEDs ON
 Press **Vol▼** to turn all LEDs OFF
Mode + CO line number + # to display and advance

Processor	CO Line Range
DK14	001~004
DK40i	001~012
RCTUA	001~016

Processor	CO Line Range
RCTUBA/BB	001~048
RCTUC/D	001~144
RCTUE/F	001~200

Feature Number	Code	Feature Description	Line LED																				
			01	02	03	04	05	06	07	08	09	10	11	12	13	14	15	16	17	18	19	20	
1	3	Ring Over External Page during NIGHT mode																					
2	1	DISA CO Line during DAY Mode																					
	2	DISA CO Line during DAY2 Mode																					
	3	DISA CO Line during NIGHT Mode																					
5	1	Ring IMDU or RMDS ¹ Modem during DAY Mode																					
	2	Ring IMDU or RMDS ¹ Modem during DAY2 Mode																					
	3	Ring IMDU or RMDS ¹ Modem during Night Mode																					
6	1	Auto Attendant during DAY Mode ²																					
	2	Auto Attendant during DAY2 Mode ²																					
	3	Auto Attendant during Night Mode ²																					

1. RMDS requires RSIU and is available with DK424 only, IMDU requires PIOU or PIOUS. See Programs 77-1 LED 14, and Program 76 for RMDS. Only one built-in maintenance modem, IMDU or RMDS, will function at a time in DK424.
2. If CO lines should ring telephones before the Auto Attendant answers, use Program 81~89 to assign telephones to ring. Do not assign telephones in Program 81~89, if the Auto Attendant should answer on the first ring.

Program 78 Overview

This program assigns ground/loop start CO lines:

- ◆ to ring over external page during night mode
- ◆ to be used with DISA features
- ◆ for direct access to IMDU/RMDS modem
- ◆ for Auto Attendant operation

Feature 1: Ring Over External Page During Night Mode

This program selects which ground/loop start CO lines will activate ringing over external paging facilities during the NIGHT mode (for Tenants 1~4). The NT Relay on the PIOU, PIOUS, or PEPU will also be activated if it is in the 1-second ON/3-seconds OFF mode.

Feature 2: DISA CO Line Assignment

This program assigns ground/loop start CO lines to be used with the Direct Inward System Access (DISA) features. These lines may be set for DISA operation during the different system modes of DAY, DAY2, and NIGHT. A line will switch to normal ringing after ten seconds if the outside caller does not use the DISA feature. Normal function of these lines occurs for outgoing calls.

Note An optional security code for DISA outgoing lines calls is available via Program 60-6. This code should always be programmed when using DISA and built-in Auto Attendant to prevent unauthorized calls through the DK system.

Feature 5: Ring IMDU or RMDS Maintenance Modem

The IMDU (DK40i and DK424 only) or RMDS (DK424 only) Remote Maintenance modem can be directly accessed by incoming ground/loop start CO lines assigned in this Program. Different alternatives are available for the system modes of DAY, DAY2, and NIGHT. If none of these are selected, the IMDU or RMDS can still be reached by dialing a modem [DN] with the DISA feature or by a Ring Transfer from the DSS console attendant or any other station. The IMDU or RMDS modem must be enabled with Program 77-1, LED 14-ON.

Feature 6: Built-in Auto Attendant CO Line Assignment

This feature selects ground/loop start CO lines for Auto Attendant operation. There is no limit to the number of lines which can be assigned with Auto Attendant. Different alternatives are available for system modes DAY, DAY2, and NIGHT.

Built-in Auto Attendant is not available for Tie, DID, ANI or DNIS lines on DK40i or DK424 and is not available on any line of DK14.

Note Auto Attendant assignments 61~63 have priority over ACD assignments in Program 14-0.

System & Station

Program 79 – Door Phone Ringing

Program 79 – Door Phone Ringing

Processor Type: DK14, DK40i, All RCTUs

Program Type: Station

Initialized Default: All LEDs are OFF

* # * # 1 * 2 * 3 - Spkr 7 9 Hold - Spkr # Hold - Spkr # # Hold - Spkr # # Hold

SELECT = Port Number

Light the LED Buttons that are marked with an X in the table below.

Enter the port number having Door Phone Ringing assigned.

To specify a port range, enter XXX*XXX (low port * high port).

Processor	Port Range
DK14	000-009
DK40i	000-027
RCTUA	000-031

Processor	Port Range
RCTUBA/BB	000-079
RCTUC/D	000-239
RCTUE/F	000-335

Feature	LED	Ports													
Muted ring to busy DKT/EKT	20														
	19														
	18														
	17														
	16														
	15														
	14														
	13														
Door phone 4C Ring DP12	12														
Door phone 4B Ring DP11	11														
Door phone 4A Ring DP10	10														
Door phone 3C Ring DP9	9														
Door phone 3B Ring DP8	8														
Door phone 3A Ring DP7	7														
Door phone 2C Ring DP6	6														
Door phone 2B Ring DP5	5														
Door phone 2A Ring DP4	4														
Door phone 1C Ring DP3	3														
Door phone 1B Ring DP2	2														
Door phone 1A Ring DP1	1														

DP = Door Phone Program

Program 79 Overview

This program assigns the door phone ringing feature to ports.

LED 20: Muted Ring to Busy Electronic and Digital Telephone

If all electronic and digital telephones are busy and a door phone button is pressed, a muted ring tone can be sent to selected digital and electronic telephones, as defined with this program. (Only the lowest port in the appropriate ringing group will mute ring.)

LEDs 01~12: Door Phone Ring

When a door phone button is pressed, selected digital and/or electronic telephones will ring as assigned with this program. See Program 77-2 for an explanation of the door phone A, B, and C numbering scheme. (Use Program *79 to assign [DN] button LEDs to flash on telephones that are assigned to ring.)

Door phones will not ring attendant consoles or standard telephones. Ringing door phones will flash on idle console's **Answer** buttons, but will not alert a console that is in the busy mode. See Program 77-1 for door phone box port assignments.

Program *79 – Door Phone to [DN] Flashing Assignments

Processor Type: DK14, DK40i, All RCTUs

Program Type: Station

Initialized Default: No [DNs] assigned to ring for any door phone

* # * # 1 * 2 * 3 - Spkr * 7 9 Hold [] [] # [] [] Spkr # # Hold - Spkr # # Hold

Door Box Number (1-4) ————
 Door Box Circuit Number (1-3) ————

Enter a [DN] Port Reference
 (Port Number of the [DN] that should flash when the door phone button is pressed.)

[DN] = [PDN] or [PhDN] port (see Legend below)

Processor	[PDN] Port Range	[PhDN] Port Range
DK14	000-009	500-509
DK40i	000-027	500-527
RCTUA	000-031	500-531

Processor	[PDN] Port Range	[PhDN] Port Range
RCTUBA/BB	000-079	500-579
RCTUC/D	000-239	500-739
RCTUE/F	000-335	500-835

Door Phone Number/Location	Door Phone Box Number	Door Box Circuit Number	[DN] Port Reference Number
1	1	1	
2		2	
3		3	
4	2	1	
5		2	
6		3	
7	3	1	
8		2	
9		3	
10	4	1	
11		2	
12		3	

Program *79 Overview

This program assigns door phones to ring Directory Number buttons ([PDNs]/[SDNs] [PhDNs]) when pressed and flash the [DN]’s LED. Each door phone can be assigned to flash one [DN]’s LED and the [DN] can be assigned to appear and ring on up to 120 telephones.

Program 79 must be used in conjunction with Program *79 to ring a telephone with a flashing [DN], when the door phone button is pressed. See Program 77-1 for door phone control box port assignments.

Important! *To allow a door phone to flash and ring, you must assign the [DN] to flash in Program *79 and the telephone on which it appears must be assigned to ring in Program 79.*

Program 80 – EKT and DKT Ringing Tones (CO Line Calls)

Processor Type: DK14, DK40i, All RCTUs

Program Type: Station

Initialized Default: Tone 1 is assigned to all ports

##1*2*3 - Spkr 8 0 Hold - Spkr [][] # [] Hold - Spkr # # Hold - Spkr # # Hold

SELECT = Station Logical Port Number

Enter the telephone port number for which the ringing tone is being defined.

To specify a port range, enter XXX*XXX (low port * high port).

Ringing Tone Code

- 1 = Tone Option 1
- 2 = Tone Option 2
- 3 = Tone Option 3

Ring Tone Option	1	2	3
Incoming Line Call*	500/640 Hz	1200/1500 Hz	800/1000 Hz
Transferred Line Call	540/760 Hz	1300/1780 Hz	880/1180 Hz

*Incoming Line Call distinctive ring tones apply to DID, ground, and loop start CO lines.

Ring tone for internal or [DN] calls, and Tie line incoming calls is

Processor	Port Range
DK14	000-009
DK40i	000-027
RCTUA	000-031

Processor	Port Range
RCTUBA/BB	000-079
RCTUC/D	000-239
RCTUE/F	000-335

Port Number	Ringing Tone (Code)		
	Tone 1 (1)	Tone 2 (2)	Tone 3 (3)

Port Number	Ringing Tone (Code)		
	Tone 1 (1)	Tone 2 (2)	Tone 3 (3)

Port Number	Ringing Tone (Code)		
	Tone 1 (1)	Tone 2 (2)	Tone 3 (3)

Program 80 Overview

External speakers and all electronic and digital telephones are paged by dialing: [DN] + #39. The **All Call Page (AC)** button is used to page all digital and electronic telephones only; external speakers are not included when using the button.

PESU/PEKU can be in any universal slot assigned in Program 19-1.

CAUTION! To prevent system malfunction, **DO NOT** install the PESU in slot 18 of the DK40i system.

Program *80 – Call Forward Station Ring Assignment

Processor Type: All RCTUs with Release 3.2 and above

Program Type: Station

Initialized Default: LED 01, 04, and 07 ON for all lines

* # * # 1 * 2 * 3 - Spkr * 8 0 Hold - Spkr [] [] # [] Hold - Spkr # # Hold - Spkr # # Hold

SELECT = CO Line Number

LED buttons = ringing assignment in which calls should Call Forward

To specify a CO line range, enter XXX*XXX (low line * high line).

Processor	CO Line Range
DK14	NA
DK40i	NA
RCTUA	001-016

Processor	CO Line Range
RCTUBA/BB	001-048
RCTUC/D	001-144
RCTUE/F	001-200

System Ring Mode	Call Forward Station Ring Assignment	LED	CO Lines													
Night	Delay 2 (89)	09														
	Delay 1 (88)	08														
	Immediate (87)	07														
Day 2	Delay 2 (86)	06														
	Delay 1 (85)	05														
	Immediate (84)	04														
Day	Delay 2 (83)	03														
	Delay 1 (82)	02														
	Immediate (81)	01														

Program *80 Overview

Sets the Call Forward (CF) ringing assignment for ground/loop CO line calls. The station that controls CF should be the only station programmed to ring in the appropriate Ringing Assignment Programs (81~89). This program does not apply to Tie, DID, DNIS, or ANI lines.

Example application: A CO line call rings a CO line button on multiple stations, then Call Forwards. CO line 001 is programmed to ring station 200, then after 12 secs., it delay rings stations 201 and 202 (12 secs.). Then, CO line 001 will CF per station 203's CF setting. If station 203 has CF-No Answer, CO line 001 will ring station 203, and then CF. If station 203 has CF-All Calls, CO line 001 will not ring station 203, but will forward immediately.

Programming for the above example:

Program 39 - Put CO line 001 button on stations 200~203.

Program 81 - Set CO line 001 to ring station 200 immediately.

Program 82 - Set CO line 001 to Delay Ring station 201 and 202

Program 83 - Set CO line 001 to Delay 2 Ring station 203.

Program *80 - Set CO line 001 to CF during Delay 2 Ring assignment (LED 03 ON).

Set station 203 to CF to Voice Mail. When CO line 001 rings, the call will forward per station 203's CF (All Calls, No Answer, etc.) setting during the Delay 2 ring period. Note that only station 203 can be set to ring in the Delay 2 (Program 83) ring assignment to allow CF to operate. VM will receive station 203's VMID (set via code #656).

Programs 81~89 – Ground/Loop Start/CO Line Station Ringing

Processor Type: DK14, DK40i, All RCTUs

Program Type: System

Initialized Default: All LEDs ON for Port 000 (81), Port 001 (87), all other LEDs OFF



SELECT = 1-9 (for type of ringing)
 SELECT = Station or DH port (see legend below)

LED Buttons = CO line assigned to ring selected station port or DH Group number(s).

Press **Scroll** to advance or **Page** to go back.

Selected trunks ring selected station ports as follows:

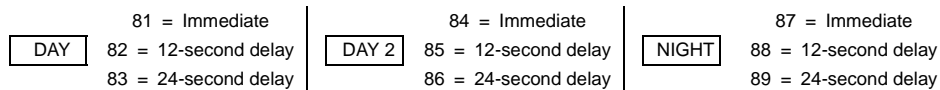

Processor	Station Port Range	DH Port	CO Line
DK14	000-009	900-909	001-004
DK40i	000-027	900-915	001-012
RCTUA	000-031	900-915	001-016

Processor	Station Port Range	DH Port	CO Line
RCTUBA/BB	000-079	900-915	001-048
RCTUC/D	000-239	900-915	001-144
RCTUE/F	000-335	900-915	001-200

CO Line	LED	Station or DH Port											
	20												
	19												
	18												
	17												
	16												
	15												
	14												
	13												
	12												
	11												
	10												
	09												
	08												
	07												
	06												
	05												
	04												
	03												
	02												
	01												

System & Station

Program 81~89 Overview

Programs 81~89 assign telephones or a Distributed Hunt group to each CO line that will ring.

Use Programs *81, *84 and *87 to assign which [PDN] and/or [PhDN] buttons flash when a call comes in on various CO lines.

- ♦ If the telephone has a specific CO **Line** button or **Pooled Line Grp** button, do not use Programs *81, *84 or *87 to assign [DN] LEDs to flash. This will cause both the CO line and [DN] button to flash on the telephone when the CO line rings on an incoming call.
- ♦ Programs *81, *84, and *87 data should be blank for CO lines that ring Voice Mail (VM) ports. Always check these programs because *81 and *87 default to port 000 and 001 and CO lines 18~200.

► To assign CO line ringing ports to station LEDs

1. On the record sheet on the previous page, enter the port numbers in the grey boxes in the top row.
2. Enter the CO Line numbers in the left column.
3. Mark “X’s” in the boxes indicating which LED should be lit when a CO Line call comes in on a particular port.

Auto Attendant

Use Programs 81~89 to set-up DK424 built-in Auto Attendant delay ring feature per the guide on the next page.

CO lines to Ring Station [PDN] Ports and/or Distributed Hunt (DH) Group Ports

CO lines that must ring DH groups must be assigned to ring the specific DH group number (900~915). If the CO **Line** button or **Pooled Line Grp** buttons must appear on the DH group member telephones, Program *81, *84 and *87 assignments are not necessary. Do not assign DH group member station ports in Program 81~89.

Station Ringing Modes

Important! *120 telephones maximum can be programmed to ring in any one mode (Day/Day2/Night) per CO line.*

The delay functions are mainly used in Centrex application, but can be used for other situations. If delayed ringing occurs, the station that initially rings will continue to ring with subsequent delayed ring stations. A wide variety of line ringing to stations can be programmed into the system.

There are nine categories:

Ringling Mode	Comments
Day Immediate	Ring assigned telephones on first ring from CO line (second ring to Caller ID lines).
Day Delay1	Delay1 is a 12-second delay of ringing signal to a standard, electronic, or digital
Day Delay2	Delay2 is a 24-second ring delay.
Day2 Immediate	Same as Day Immediate except during Day2 NT mode.
Day2 Delay1	Same as Day Delay 1 except during Day 2.

Ringling Mode	Comments
Day2 Delay2	Same as Day Delay 2 except during Day 2.
Night Immediate	Same as Day Immediate except during Day2 NT mode.
Night Delay1	Same as Day Delay 1 except during Day 2 NT mode.
Night Delay2	Same as Day Delay 1 except during Day 2 NT mode.

Day, Day2, Night refer to the **Night Transfer** button's three modes.

Attendant Console (DK424 only)

Programs 81~89 are used to ring individual attendant consoles and/or to enable attendant console incoming CO line call load sharing. (See “Auto Attendant Delay Ring” and “PC and Conventional Attendant Console Programming Overview” in Chapter 5 – Station Apparatus of the *Strata DK Installation and Maintenance Manual*.)

Attendant Console Load Sharing

In Programs 81, 84, and 87, assign all CO lines (ground, loop, and DID) that should alternately ring multiple attendant consoles to the respective Load Share console ports (see “Attendant Console Load Share Programming Example” on page 5-21 of the *Strata DK Installation and Maintenance Manual*.)

On DID lines, when the digits assigned to console ports in Program *09 are dialed on incoming calls, the calls will alternately ring the Load Share consoles.

Auto Attendant Delay Ring

► To set Auto Attendant Delay Ring operation

Note If the Auto Attendant must answer calls on the first ring, do not assign CO lines to ring telephones in Programs 81~89.

- Assign CO lines to ring the Auto Attendant (AA) in Program 78.
 - Program 78-61: AA DAY
 - Program 78-62: AA DAY 2
 - Program 78-63: AA NIGHT
- Assign stations that should ring (immediately for 12 seconds) before the AA answers to the AA CO lines in Program 81 (84 – Day 2, 87 – Night). Also assign the [DN] that should flash when the CO lines ring with Program *81 (*84 – Day 2, *87 – Night). As an option, the station can be equipped with the appropriate CO **Line** or **Pooled Line Grp** buttons in which case you should not program a [DN] to flash with Program *81.
 - ✦ Stations assigned in Program 81 and the [DN] assigned in Program *81 – ring immediate for 12 seconds and then stop ringing unless they are also assigned to ring in Program 82. Assign [DN] for the appropriate CO **Line** or **Pooled Line Grp** buttons to these ports using Program 39.
- Assign stations that should ring (after a 12-second delay – for 12 seconds) before the AA answers to the AA CO lines in Program 82 (85 – Day 2, 88 – Night). Also assign the [DN] that should flash when the CO lines ring with Program *81 (*84 – Day 2, *87 – Night). As an option, the station can be equipped with the appropriate **CO Line** or **Pooled Line Grp** buttons in which case you should not program a [DN] to flash with Program *81.

- ♦ Station assigned in Program 82 and the [DN] assigned in Program *81 – ring after a 12-second delay for 12 seconds and then stop ringing. Assign the appropriate [DN] or **Line** or **Pooled Line Grp** buttons to these ports using Program 39.
4. Assign any station to ring the AA CO lines in Program 83 (86 – Day 2, 89 – Night). This assignment is only a flag that notifies the software to delay ring stations assigned in Program 82. Program 83 station assignments do not ring.
 - ♦ The station assigned in Program 83 will not ring because AA will answer the call after 24 seconds. Assign [DN] buttons that flash/ring on this station port using Program 39.
 - ♦ No Delay: If AA line(s) are assigned to ring stations in Program 81, but no stations are assigned in Programs 82 or 83, AA will answer the call immediately (no delay ring).
 - ♦ 12 Second Delay: If AA line(s) are assigned to ring stations in Programs 81 and 82 but no stations are assigned in Program 83, stations assigned in Program 81 will ring immediately for 12 seconds and then the AA will answer (stations assigned in Program 82 will not ring).
 - ♦ 24 Second Delay: If AA CO line(s) are assigned to ring stations in Programs 81, 82, and 83, then the following ringing occurs:
- Note** The Auto Attendant Answers after stations assigned in Program 81 and 82 stop ringing (24 seconds from start of call).
5. Use Program 39 to assign the [DN] button that should flash and ring before the AA answers. The [DN] button, or buttons for multiple [PDNs], must be assigned on all station ports assigned to ring in Programs 81-89 only if the stations that must ring before AA answers do not have the appropriate CO **Line** or **Pooled Line Grp** buttons.

Auto Attendant Program Example

- ♦ CO lines 1~5 should ring [PhDN] 500 on station 200 immediately for 24 seconds (6 rings).
- ♦ CO lines 1~5 should delay ring [PhDN] 500 on station 208 after ringing [PhDN] on station 200 for 12 seconds.
- ♦ The Auto Attendant should answer CO 1~5, 24 seconds after station 200 started ringing and 12 seconds after station 208 started ringing. Stations 200 and 208 stop ringing when auto attendant answers.

► To program the example

1. Assign lines 001~005 to AA in Program 78-61.
2. Assign lines 001~005 to ring station 200 in Program 81.
3. Assign lines 001~005 to ring station 208 in Program 82.
4. Assign lines 001~005 to ring any installed RSTU, PDKU, or PEKU port that has a telephone or does not have a telephone connected in Program 83 (Program 83 assignment is used only to enable Program 82 delay ring stations to ring. Assign [PhDN] 500 button on this port using Program 39).
5. Assign lines 001~005 to flash [PhDN] 500 in Program *81.
6. Assign the [PhDN] 500 button to station 200 and 208 using Program 39.
7. Make sure [PhDN] is assigned to an owner telephone (200 or 208) in Program *33.
8. Using Program 39, assign [PhDN] button 500 on stations 200 and 208.

Programs *81, *84 and *87 Overview

Ground/loop start CO lines can be assigned to ring and flash specific Directory Number buttons, including [PDNs], [SDNs] or [PhDNs]. These programs assign which [DN] will flash when a ground/loop start CO line rings a direct incoming call to the DK system.

Programs 81~89 must be used in conjunction with Programs *81, *84, and *87 to ring the telephone on which the flashing [DN] appears. Refer to the CO **Line**/[DN] button LED control logic diagrams that follow these record sheets for more information.

Each ground/loop start CO line can be assigned to flash one [DN], but that [DN] button can be assigned to up to 120 telephones. The assigned [DN] LED will flash as 1 Hz rate when CO line call rings into the DK424.

If a specific CO **Line** or **Pooled Line Grp** button is programmed to appear on a telephone (in Program 39), do not assign a [DN] to flash on that telephone with Programs *81, *84, and *87.

Important! *If CO lines direct ring voice mail (VM) ports in Programs 81~89, the data for those CO lines in Programs *81, *84, and *87 must be blank.*

Program *81

Assigns which [DN] flashes when the CO line rings during the system Day mode.

Program *84

Assigns which [DN] flashes when the CO line rings during the system Day2 mode.

Program *87

Assigns which [DN] flashes when the CO line rings during the system Night mode.

Programs 81, 82, 83

Assign Immediate Ring, 12-second delay Ring, 24-second delay Ring in the Day mode, respectively, to telephones with [DNs] assigned to flash in Program *81

Programs 84, 85, 86

Assign Immediate Ring, 12-second delay Ring, 24-second delay Ring in the Day2 mode, respectively, to telephones with [DNs] assigned to flash in Program *84

Programs 87, 88, 89

Assign Immediate Ring in the Night mode, 12-second delay Ring, 24-second delay Ring, respectively, to telephones with [DNs] assigned to flash in Program *87.

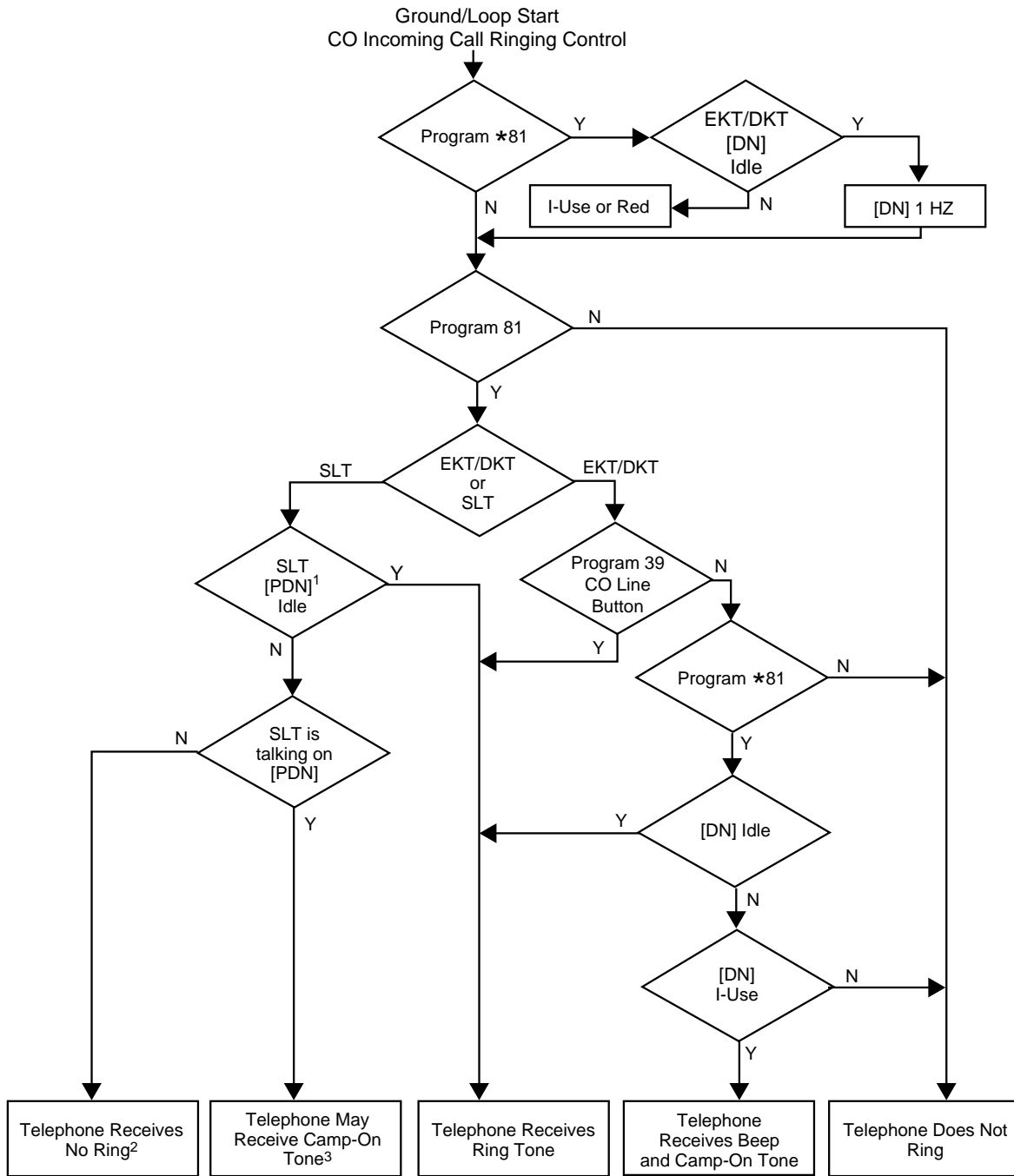

System & Station

1. [PDN] belongs to Standard Telephone.
2. If a digital/electronic telephone has an SLT [PDN] on their telephone and if that telephone is currently using the SLT [PDN], the SLT will not receive camp-on tone.
3. See Program *34.

Figure 3-2 Strata DK CO Line Button/Directory Number [DN] Button Ringing Control Logic Diagram

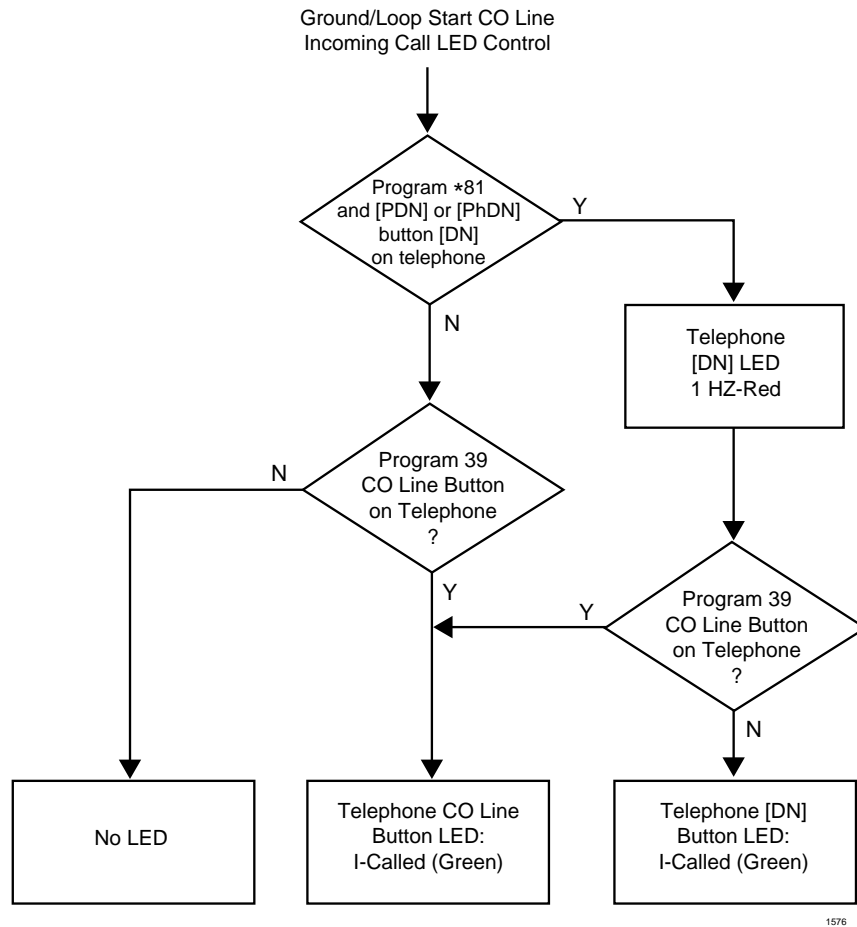

Figure 3-3 Strata DK CO Line Button/Directory Number LED Flash Control Logic Diagram

Program *81 CO Line to Station [DN] LED flashing Control Logic also applies to Programs *84 and *87.

Program 81 CO Line to Station Ringing Control Logic also applies to Programs 82~89.

Important! *System Record Sheets for Programs 90, 91, and 92 appear in the beginning of this section because they must be executed prior to running any other programs.*

Program 93 – CO Line Identification

Processor Type: *DK14, DK40i, All RCTUs*
Program Type: *System*
Initialized Default: *Blank*



SELECT = 1
 LED Button for CO line being named.
 To advance the line range, press Scroll.
 CO Line Identification
 Enter the CO line identification. (See next page for data entry procedures.)

Processor	CO Line Range
DK14	001-004
DK40i	001-012
RCTUA	001-016

Processor	CO Line Range
RCTUBA/BB	001-048
RCTUC/D	001-144
RCTUE/F	001-200

LED	Line	CO Line Identification (16 Characters Max. Enter One per Rectangle)																	
20																			
19																			
18																			
17																			
16																			
15																			
14																			
13																			
12																			
11																			
10																			
09																			
08																			
07																			
06																			
05																			
04																			
03																			
02																			
01																			

Program 93 Overview

Assigns alphanumeric names (such as “WATS BAND 5”, “FX TO NY,” “MR JONES,” etc.) to lines. The names can be up to 16 characters each, and display when the line is being used by an LCD station. When programmed to display, Caller ID, DNIS, ANI, and ACD call information will display in place of CO line Alpha identification data.

► **To enter CO line identification**

1. Enter Program 93 and select the desired CO line.
2. Using the guide below enter the CO line identification information.

Numeric Mode

0~9 are treated as numerals.

Dial pad starts in numeric mode. Press # to switch to alpha mode.

Alpha Mode

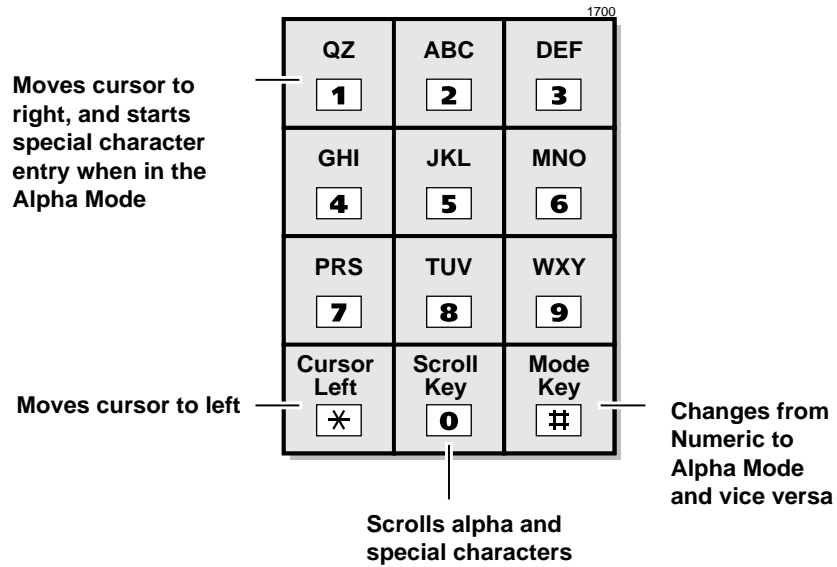

Alpha Entry (Example):

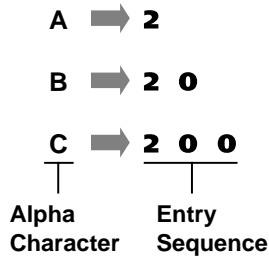

Special Character Entry:

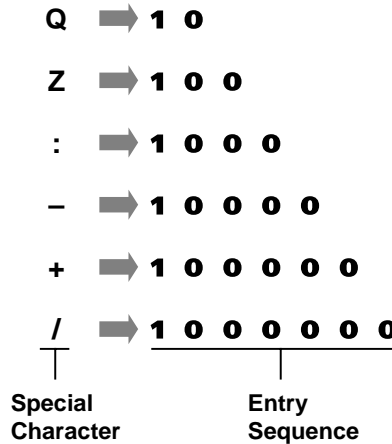

Program 97 – Printing Program Data through SMDR

Processor Type: DK14, DK40i, All RCTUs

Program Type: System

Initialized Default: Prints out customer database

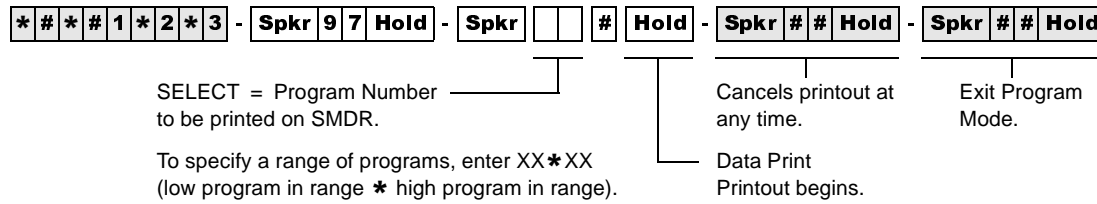

Program 97 Overview

Contents of each program can be sent to the SMDR port for a hard copy printout.

System & Station

Program 97 – Printing Program Data through SMDR

This chapter gives you an overview of the Toll Restriction feature and step-by-step instructions to fill in the Toll Restriction System Record Sheets for DK14, DK40i, and all RCTUs.

Toll Restriction Methods

Toll Restriction screens and selectively restricts outgoing calls using three different methods. Each type of restriction can be programmed for individual stations. Toll Restriction can also be enabled/disabled for each outgoing line in the system.

Important! *Strata DK requires that a “1” be dialed before an area code to provide simple, three, or six-digit toll restriction.*

Simple Toll Restriction

Only involves the first digit dialed. The system can be programmed to reject outgoing calls beginning with 0 or 1 (see Program 48).

Three-digit Toll Restriction

Involves the system analyzing the area code dialed, and selectively allowing/disallowing outgoing calls following the criteria defined in Area Code Tables (see Program 46, Codes 2~4).

Six-digit Toll Restriction

Involves the system analyzing the area code and the office code, and selectively allowing/disallowing outgoing calls following the criteria defined in Area Code Tables and Office Code Tables (see Program 46, codes 2~4 and 6~8).

Note Standard telephones that are Toll Restricted should always be forced to use Least Cost Routing (LCR) to place outside calls. This prevents Toll Restriction defeat when the RRCS, K4RCU3, K5RCU or QRCU3 circuit times out.

Toll Restriction Features

For description purposes, Toll Restriction is divided into several components, or subfeatures. The subfeatures operate independently of the restriction methods just described, although they may employ these methods.

Station Priority Classes 1~8

Eight classes of Toll Restriction can be defined to assign different levels of priority to individual stations with RCTUC/D and RCTUE/F.

Four classes are supported with DK14, DK40i, RCTUA, and RCTUBA/BB.

Classes can be defined so each is progressively more restrictive by allowing or denying specific area or office codes, calls to long distance information, international calls, and operator assisted calls (Programs 46-10~80).

Office Code Exception Tables

Class 1~8 restrictions can be further modified by defining as many as eight exception tables to allow or deny access to specific office codes that fall within previously restricted area codes (Program 47). Exception office code access is accomplished with the Six-digit Toll Restriction method described earlier.

Emergency, Information, and Toll-free Long Distance Toll Restriction Override

Toll Restricted stations may be allowed to dial special codes such as 911 or Enhanced 911 (E911) for emergency response, 1-411 or 411 for information, or 800 prefix toll-free calls (see Program 46 for normal 911 and *10 for E911).

Important! *Always be sure to provide access to emergency numbers such as 911.*

Toll Restriction Override by System Speed Dial

System Speed Dial numbers can be programmed to override Toll Restriction (see Basic System Features, Program 10-1).

Toll Restriction/Traveling Class Override Codes

Up to two Toll Restriction Override Codes can be defined. When dialed at a toll restricted station, these codes enable the station user to override toll restrictions defined at the station (Program 44-1~8 or 45-8~9). Codes may be changed by stations chosen in programming (see Basic System Features, Program 30). Also, Verified Account Codes (Forced or Voluntary) can be used to override or change a telephone's toll restriction class on a call by call basis (see Programs 69 and 70).

Special Common Carrier Authorization

Toll Restriction can be programmed to recognize Other Common Carrier (OCC) telephone numbers, directory numbers, authorization codes, and Centrex/PBX access codes. The system starts inspecting numbers for Toll Restriction purposes after the recognizable code is dialed (Program 45-3~6). This does not apply to 10XXX or 101XXX carrier access codes which are always restricted to stations that are toll restricted in any class in Program 48.

Completing the Toll Restriction System Record

The following instructions explain how to complete System Record Sheets used to program the Toll Restriction feature. They are arranged in the same order in which the tables appear in the Toll Restriction System Record Sheets. The following instructions are intended to give a concise general definition of the programming characteristics defined by each record sheet.

Note On each record sheet, mark an X in the space provided to indicate that a choice is selected. Unless otherwise specified, this indicates the LED is lit. When appropriate, indicate digits to be entered using the station dialpad.

Program 40 – Station CO Line Access

Processor Type: DK14, DK40i, All RCTUs

Program Type: Toll Restriction

Initialized Default: All LEDs ON for all CO lines (all stations can access all lines)

* # * # 1 * 2 * 3 - Spkr 4 0 Hold - Spkr [] [] # [] Hold - Spkr # # Hold - Spkr # # Hold

SELECT = Station Logical Port Numbers

To add a port range, enter XXX*XXX (low port * high port).

Press **Scroll** to advance or **Page** to go back.

LED Buttons = CO Lines

Light LEDs for the port(s) that are allowed access.

To turn all CO LEDs ON or OFF, after the port number and # is entered, press **Vol▲** (all LEDs ON) or **Vol▼** (all LEDs OFF).

To check a particular CO line, after the port number is entered, press **Mode** and enter the CO line number, then use the # button to display and advance.

Processor	CO Line Range	[PDN] Port Range	DISA Port
DK14	001-004	000-009	10
DK40i	001-012	000-027	035
RCTUA	001-016	000-031	039

Processor	CO Line Range	[PDN] Port Range	DISA Port
RCTUBA/BB	001-048	000-079	089
RCTUC/D	001-144	000-239	249
RCTUE/F	001-200	000-335	344

CO Line	LED	Port											
	20												
	19												
	18												
	17												
	16												
	15												
	14												
	13												
	12												
	11												
	10												
	09												
	08												
	07												
	06												
	05												
	04												
	03												
	02												
	01												

Program 40 Overview

This program is used to allow or deny each station and/or DISA to use CO lines on a line by line basis. This applies to all analog and digital line types.

Any station can have access to as many lines as desired. Any station denied access (either to make a call or to answer a call) to a line cannot seize it by dialing either an access or pickup code or by using a CO line button. This also denies access via Least Cost Routing. Also, use this program to divide lines for Tenant Service. Use Program 40 to deny CO line call pickup. If only outgoing access is to be prevented but answering incoming calls should be allowed, use Program 41, not Program 40 to deny CO line access.

Program 40 does not deny access to answer transferred calls. If the LED for a CO line is OFF in this program, access to the line on direct incoming or outgoing calls is denied.

Important! *If the DISA port is denied, CO line access in Program 40, DISA callers cannot access outgoing CO lines when calling in on DISA lines. Also, External Call Forward will be blocked on the denied lines. (See DISA port legend.)*

Program 41 – Station Outgoing Call Restriction

Processor Type: DK14, DK40i, All RCTUs

Program Type: Toll Restriction

Initialized Default: All LEDs OFF for all CO lines (all stations can access all lines)

##1*2*3 - Spkr 4 1 Hold - Spkr [] [] # [] Hold - Spkr # # Hold - Spkr # # Hold

SELECT = Station Logical Port Numbers

To add a port range, enter XXX*XXX (low port * high port).

Press **Scroll** to advance or **Page** to go back.

After programming, press:

- **Vol▲** to turn all LEDs ON
- **Vol▼** to turn all LEDs OFF
- **Mode** + CO line number, then **#** to display and advance

LED Buttons = CO Lines

Light LEDs for the port(s) that are allowed access.

Processor	CO Line Range	[PDN] Port Range	DISA Port
DK14	001~004	000~009	010
DK40i	001~012	000~027	035
RCTUA	001~016	000~031	039

Processor	CO Line Range	[PDN] Port Range	DISA Port
RCTUBA/BB	001~048	000~079	089
RCTUC/D	001~144	000~239	249
RCTUE/F	001~200	000~335	344

CO Line	LED	Port											
	20												
	19												
	18												
	17												
	16												
	15												
	14												
	13												
	12												
	11												
	10												
	09												
	08												
	07												
	06												
	05												
	04												
	03												
	02												
	01												

Program 41 Overview

Program 41 restricts each station (or Direct Inward System Access (DISA) CO line) from outgoing access to each line. If restricted, that station can still answer a ringing line or pick up a call on hold but cannot directly access a line for an outgoing call by pressing the line button or dialing the line access code. All Call Pickup functions operate normally. This does not deny access via LCR.

Notes

- Automatic Busy Redial (ABR) overrides Program 41.
- To deny a CO line to be accessed for DISA tandem connection or external call forward, turn its LED ON (see DISA ports legend).

Program 42-0 – CO Line to PBX/Centrex Connection & Access Codes

Processor Type: DK14, DK40i, All RCTUs

Program Type: Toll Restriction

Initialized Default: All LEDs OFF for all CO lines. Assigns no access codes to PBX groups.

* # * # 1 * 2 * 3 - Spkr 4 2 Hold - Spkr 0 Hold - Spkr # # Hold - Spkr # # Hold

SELECT = 0

Press **Scroll** to advance or **Page** to go back.

After programming, press:

- **Vol▲** to turn all LEDs ON
- **Vol▼** to turn all LEDs OFF
- Mode and CO line number, then **#** to display and advance

Specify CO Lines by setting LED Buttons as defined by the table below.

Processor	CO Line Range
DK14	001~004
DK40i	001~012
RCTUA	001~016

Processor	CO Line Range
RCTUBA/BB	001~048
RCTUC/D	001~144
RCTUE/F	001~200

Button LED	Line (Trunk)	Set Button LEDs	
		Centrex/PBX Connection (LED ON)	Normal (LED OFF)
20			
19			
18			
17			
16			
15			
14			
13			
12			
11			
10			
09			
08			
07			
06			
05			
04			
03			
02			
01			

Program 42-0 Overview

Use this program to allow Centrex/PBX (after flash) features to operate. Do not use this program when the Centrex feature (assume 9) is used and the DK LCR is activated (see notes below).

The Strata DK System recognizes PBX/Centrex access codes via Programs 42-1~8. Program 42-0 informs the software which lines are connected to a PBX or to Centrex. This combination allows Toll Restriction and Speed Dialing to function properly.

Notes

- If the CO line is programmed for behind Centrex/PBX (LED ON), reseed guard time is 1.5 seconds. If CO line is programmed for normal operation guard time is 0.45 seconds. See Program 10-1, Button/LED 02.
- Do not use this program when using LCR behind Centrex/PBX; use Program *45-2 instead. Also, do not use this program if installing CO lines behind “assume-9” Centrex.

Program 42-1~8 – PBX/Centrex Access Codes

Processor Type: DK14, DK40i, All RCTUs

Program Type: Toll Restriction

Initialized Default: Assigns no access codes to PBX groups

* # * # 1 * 2 * 3 - Spkr 4 2 Hold - Spkr [] [] Hold - Spkr # # Hold - Spkr # # Hold

SELECT = 1~8 PBX Access Code Group
Enter the PBX Group Number 1~8 that needs
an access code assigned.

ACCESS CODE = Enter a 2-digit access code for the group,
as defined by the table below.

- If access code is single digit, enter the first digit and press LED Button 01 as second digit.
- Press LED Button 01 to delete digit.
- Press LED Button 02 for Wild Card digit (any digit, 0~9). For example, pressing 8 + LED Button 02 allows 80~89.

PBX/Centrex Access Code Number	PBX/Centrex Outgoing CO Line Access Code(s)	
	1st Digit	2nd Digit
1		
2		
3		
4		
5		
6		
7		
8		

Program 42-1~8 Overview

The Centrex access code(s) used to make out-of-centrex calls (usually 9) is entered in this table.

Use this program to allow correct Toll Restriction and Centrex/PBX transfer operation.

Do not use this program when using LCR behind Centrex/PBX; use Program *45-2 instead. Also, do not use this program if installing CO lines behind “assume-9” Centrex.

Program 43 – 0 + Credit Card Dialing Option

Processor Type: DK14, DK40i, All RCTUs

Processor Type: Toll Restriction

Initialized Default: All LEDs OFF

* # * # 1 * 2 * 3 - Spkr 4 3 Hold - Spkr [] [] # [] Hold - Spkr # # Hold - Spkr # # Hold

SELECT = Station Logical Port Numbers
 Press **Scroll** to advance or **Page** to go back.

LED Buttons = CO lines
 Assigned to allow dial 0+ calls with selected stations.

After programming, press:

- **Vol▲** to turn all LEDs ON
- **Vol▼** to turn all LEDs OFF
- **Mode** + CO line number, then **#** to display and advance

Processor	CO Line Range	[PDN] Port Range
DK14	001~004	000~009
DK40i	001~012	000~027
RCTUA	001~016	000~031

Processor	CO Line Range	[PDN] Port Range
RCTUBA/BB	001~048	000~079
RCTUC/D	001~144	000~239
RCTUE/F	001~200	000~335

CO Line	LED	Port											
	20												
	19												
	18												
	17												
	16												
	15												
	14												
	13												
	12												
	11												
	10												
	09												
	08												
	07												
	06												
	05												
	04												
	03												
	02												
	01												

Toll Restriction

Program 43 Overview

This program enables selected station users to bypass their normal Toll Restriction assignments by dialing “0” immediately after seizing a CO line. Both the station and the line must be enabled for this feature with this program.

After seizing the line, the station user is required to dial a specific number of digits, which includes the leading 0. This digit-length requirement forces the user to dial a telephone number or a telephone number plus a credit card number. As a result, these calls are billed to the credit card, and operator-placed calls are not billed to the line. The digit length, 1~30 numbers, is set in Program 60-7. This length is determined by the system’s call routing method.

If the number of digits set in Program 60-7 are not dialed, the call will be cut off 20 seconds after the last digit is dialed.

When not dialing via LCR, the digit length should usually be 25 which is the sum of the digits in the telephone (11) and credit card (14) numbers. When using LCR, a digit length of 11 is recommended.

Stations that are enabled with 0 + credit card calling should not be restricted for dialing 0 or 01 in Programs 46 (10~80) and 48.

Important! *More digits than the length set in Program 60-7 are allowed to be dialed; there is no limit to the amount of digits that can be dialed.*

Program 44-1~8 – Toll Restriction/Traveling Class Override Codes

Processor Type: DK14, DK40i, All RCTUs

Program Type: Toll Restriction

Initialized Default: All Classes Blank (no code)



SELECT = Toll Restriction Class 1~8 DATA = Toll Restriction Code for Selected Class (1~4 digits)

Processor	Toll Restriction Class
DK14	1~4
DK40i	1~4
RCTUA	1~4

Processor	Toll Restriction Class
RCTUBA/BB	1~4
RCTUC/D	1~8
RCTUE/F	1~8

Toll Restriction Class SELECT =	DATA = (1~4 Digit Code)
1	
2	
3	
4	
5	
6	
7	
8	

Program 44-1~8 Overview

This program enables you to assign a code for each of the Toll Restriction classes established in Program 46. If one of these codes is entered at a station, the station assumes the code's class for that call. When the call is complete, the station returns to its regular class assigned in Program 48. The Traveling Class code data is not sent out the SMDR port and does not print out on station call records. Account Codes (Forced or Voluntary) can also be used for this function, in which case the Account Code will print out on SMDR (see Programs 69 and 70).

Notes

- Stations selected in Program 30, LED 16 ON, can add, change, or delete the codes set in Program 44-1~8.
- When the Toll Restriction Override code is dialed, the station's class (defined in Program 48) changes to the class assigned to the code in Program 44-1~8.
- Do not use the same codes set in Program 45 (8 and 9).
- Stations enabled in Program 30, Button/LED 16 ON, are allowed to enter and change Toll Restriction Class (1~8) override codes.

Program 44-91~93 – Emergency Bypass of Forced/Verified Account Codes

Processor Type: DK14, DK40i, All RCTUs

Program Type: Toll Restriction

Initialized Default: Code 91 = 911, Codes 92 and 93 are blank



SELECT = 91~93 to set Emergency Number 1~3
 DATA = Emergency Telephone Number (1~4 digits)
 To enter blanks, press LED Button 01.

Emergency Number (1~3) SELECT =	DATA = (1~4 Digit Telephone Number)
91	911 (default)
92	
93	

If CO lines are behind PBX or Centrex, program the PBX/Centrex outside CO line access code. Example: “9”. A pause is automatically inserted following the first 9.

See Programs *45-2 to assign the CO line and access code for behind PBX/Centrex operation.

Also, if the system CO lines are behind Centrex/PBX, the Centrex/PBX CO line access codes must be programmed in front of the emergency telephone number. Example: If the Centrex/PBX access code is “9”, then enter 9911 in Program 44-91.

Program 44-91~93 Overview

This program exempts as many as three special numbers, each up to four digits (such as the emergency 911 number), from Verified Account Code dialing restrictions. When dialed, these numbers are sent out immediately, bypassing any Verified Account Code dialing restrictions set in Programs 69 and 30, button/LEDs 8 and 14, respectively. If Verified Account Codes assigned in Program 69 conflict (duplicate) with emergency or other type telephone numbers set in Program 44-91~93, Program 44-91~93 has priority.

If lines are behind Centrex or PBX, program the appropriate one- or two-digit Centrex/PBX line access code in front of the emergency number.

Notes

- Do not use this program with ABR and DISA.
- This program does not override Toll Restriction. Emergency numbers must be put in “allowed” tables in the normal Toll Restriction programming procedures.
- If Enhanced 911 (E911) is required, use E911 Programs in place of 44-91~93.

Program 45-1 – LCR/Toll Restriction Dial Plan

Processor Type: DK14, DK40i, All RCTUs

Program Type: Toll Restriction

Initialized Default: Assigns Dial Plan 7 to the system (current North American Numbering Plan)

* # * # 1 * 2 * 3 - Spkr 4 5 Hold - Spkr 1 Hold - Spkr # # Hold - Spkr # # Hold

SELECT = 1 DATA = Plan 1-9
Enter Codes 1-9 to indicate the dial plan for the system.

X	Plan	Toll Restriction/LCR Dial Plans
	9	(101XXXX)+1+NXX+NXX/NXX
	8	(101YXXX)+1+NXX+NXX/NXX
	7	(10XXX)+1+NXX+NXX/NXX
	6	For UK only.
	5	0+ (0+ and universal (Codes 5 and 4) are not used in USA.)
	4	Universal (0+ and universal (Codes 5 and 4) are not used in USA.)
	3	(10XXX)+1+AC+NXX/NXX
	2	(10XXX)+1+AC+NXX/1+NNX
	1	(10XXX)+AC+NXX/1+NNX

Where:

In NXX and NNX,
X = 0~9
N = 2~9
NXX = Office code (interchangeable with area and office codes; second digit can be 0~9)
NNX = Office code (not interchangeable; second digit cannot be 1 or 0)
AC = Area Code
1+ NNX = 1 may be dialed before office codes
10XXX = old 5-digit Carrier Access Codes
101YXXX/101XXXX = new 7-digit Carrier Access Codes
Y = 0, 5 or 6

Program 45-1 Overview

This program enables you to define a dial plan for the Toll Restriction software to recognize the typical dialing sequence of long distance/local calls made from the system's home area code, and to identify area and office codes. The dialing plan defines several components of a telephone number for long distance calling

Notes

- Setting the proper dialing plan in this program is also required for the Least Cost Routing feature to function properly.

- The Strata DK System automatically restricts direct dialing of 10XXX+1 and 10XXXXX+1 access codes to any station that is toll restricted. These codes are allowed in system speed dial and LCR modified digit tables. This is necessary to control Long-Distance-Carrier access. 10XXX+0 and 10XXXXX+0 are allowed/denied depending on the station's class and Program 46 (10~80) button/LED 01 assignment.

Pre-January 1995 North American Numbering Plan (NANP)

Plans 1~6 use numbering plans for systems that do not use the NANP established January, 1995. DK14, DK40i, and all DK424 RCTUs provide plans 1~9.

Long Distance Prefix 1 in most areas must be the first digit dialed for long distance calling. In such areas, the area code is dialed right away. The dial plan defines whether the prefix 1 is required for a particular installation's long distance calling.

Area/Office Code Numbering Schemes—In most places, the middle digit of an area code is 0 or 1, and the middle digit of an office code is 2~9. Toll Restriction examines the first three-digit sequence dialed and determines whether it is an area code or an office code.

- ♦ If the middle digit is 0 or 1, then the sequence is an area code.
- ♦ If the middle digit does not equal 0 or 1, then the sequence is an office code, and the office code parameters of the selected dialing plan apply.

An exception to this rule exists. In some places, area and office codes are interchangeable. The middle digit is always 0 or 1 (see Code 3 selection). In such a case, the system only knows that three digits dialed are an area code if 1 is dialed before them. If 1 is not dialed first, the system knows the three digits are an office code. The dial plan defines the numbering scheme applicable to the installation site.

Special Common Carrier Number and Digit Length - for SPCC numbers of the form 950-XXXX, this program can allow credit card calling but will restrict the maximum number of digits dialed to prevent defeat of Toll Restriction.

Plan 1

Older Strata DK Systems use Plan 1 for dialing plan AC+NXX/1+NNX if the installation is in a location where a user places a long distance call to a destination outside the area code without dialing 1 before dialing the area code. The user places a long distance call to a destination in the same area code by dialing 1 directly before the office code.

- ♦ The first three digits of a ten-digit number is an area code if the middle digit is 0 or 1.
- ♦ Pressing the first three digits immediately after a 1 in an eight-digit string is an office code
- ♦ A seven-digit string starting with an office code is a local call.

Plan 2

- ♦ Plan 2 is 1+AC+NXX/1+NNX. Use this plan where a user places a long distance call to a destination outside the area code by dialing a 1 before dialing the area code. The user places a long distance call to a destination in the same area code by dialing a 1 directly before the office code
- ♦ When using this plan, the system recognizes the following:
 - ♦ The first three digits following a 1 in an 11-digit number are an area code, if the middle digit is 0 or 1.
 - ♦ The first three digits dialed immediately after a 1 in an eight-digit string is an office code.

Plan 3

- Plan 3 is 1+AC+NXX/NXX. Use this plan where a user places a long distance call to a destination outside the area code by dialing a 1 before dialing the area code. The user places a long distance call to a destination in the same area code by simply dialing the number, without a 1 in front. The office codes are interchangeable. The system differentiates between them whenever it sees the digit 1 dialed.

When using this plan, the system recognizes the following:

- If 1 is the first number entered in an 11-digit string, the next three digits are an area code.
- A 10-digit string is not recognized.
- The first three digits in a seven-digit string are an office code. (There is no distinction between local call dialing and long distance dialing within the area code.)
- Digits 5~7 in an 11-digit string may be an interchangeable office code as well.

Plans 4~6

Not used in the United States.

Post 1995 North American Numbering Plan (NANP)

Plans 7~9 use the NANP established January 1995. DK14, DK40i, and all DK424 RCTUs provide plans 7~9.

- Prefix 1 is used only when followed by an area code. The area code can be the home area code, depending on the telephone company’s plan in that state.
- Area/Office code numbering schemes – All area codes and office codes will have the format NXX, making the new plan have both interchangeable area codes as well as interchangeable office codes.
- Intra-area code toll calls can be according to a seven-digit only plan in some states. In this case, a seven-digit call may be a local call or a toll call. Therefore, only particular office codes can determine a toll call for a seven-digit call, not the dial plan in 45-1.

Changing System Dialing Plan for NANP from a Station

For NANP upgraded SW version, the dial plan can also be changed from the station port 000 (default station 10, 100, or 200).

► To change the System Dialing Plan for the North American Dialing Plan

1. With the handset on-hook, press a [DN] + #650 .	You hear a confirmation tone. X is the current system dialing plan 1, 2, 3, 7, 8, or 9.	NANP=X KEY CODE=
2. Enter 6267 .	You hear a confirmation tone.	CODE=6267 NANP=
3. Enter the one-digit (X) for the system dialing plan (X = 1, 2, 3, 7, 8, or 9).	You hear a confirmation tone.	CODE=6267 NANP=X

Toll Restriction

4. Press **Redial** or **RDL**.

The telephone returns to the idle mode.

DATA PROGRAMMED

5. Press **Spkr**.

Plan 7 - (10XXX)+1+NXX+NXX/NXX

The Strata DK systems in this Programming Manual default to this plan. Used when dialing 1 before the long distance number. Call is placed to a destination outside the area code by dialing a 1 before dialing the area code.

The user places a local code plus distance call to a destination in the same area code by simply dialing the number, without a 1 in front. The area and office codes may be interchangeable. The system differentiates between them whenever it sees the digit 1 dialed. This plan supports five-digit Carrier Access (CA) codes (10XXX) compared to seven-digit CA codes.

When using this plan, the system recognizes the following:

- ♦ If 1 is the first number dialed in an 11-digit string, the next three digits are an area code (**1** + **AC** + 7 digit number). A ten-digit string is not recognized (**AC** + 7 digit number).
- ♦ Digits 2~4 and 5~7 in an 11-digit string are NXX format and are interchangeable.
- ♦ The first three digits in a seven-digit string are an office code. (There is no distinction between local call dialing and long distance dialing within the area code.)
- ♦ If 16-digit dialing (Area Code + 7 digits) is required to be unrestricted and routed over the local LCR route, program the Area Code in Program 46-2~4 and Program *45-2.

Plan 8

Same as Plan 7 except a new 7-digit carrier access code must be 101YXXX format (where Y is 0, 5 or 6; X is 0 to 9).

Plan 9

Same as Plan 7 except a new 7-digit carrier access code must be 101XXXX format (where X is 0 to 9).

Area codes and office codes in XXX format (where X is 0 to 9) are allowed to be programmed in the area code and office code tables for Toll Restriction and Least Cost Routing purposes.

Only area codes formatted N(0/1)X and office codes formatted NNX are valid on call processing for the old dial plans 1, 2, 3.

New area codes NXX are valid only in NANP dialing plans 7, 8, 9.

Office codes of the form NNX and NXX are valid on call processing for the old dialing plans 1, 2, 3, and new dialing plans 7, 8, 9, respectively. For international calls, area code 011 and office codes XXX (as country codes) are valid on the call processing for all dialing plans.

Program 45-2 – Toll Restriction Disable

Processor Type: DK14, DK40i, All RCTUs

Program Type: Toll Restriction

Initialized Default: All LEDs OFF for all CO lines (all lines apply Toll Restriction)

* # * # 1 * 2 * 3 - Spkr 4 5 Hold - Spkr 2 Hold - Spkr # # Hold - Spkr # # Hold

SELECT = 2

Press **Scroll** to advance or **Page** to go back.

After programming, press:

- **Vol▲** to turn all LEDs ON
- **Vol▼** to turn all LEDs OFF

LEDs/Buttons

Specify CO lines by setting LED Buttons as defined by the table below. All LEDs with an X should be lit when finished.

ON = Disable Toll Restriction

Processor	CO Line Range
DK14	001~004
DK40i	001~012
RCTUA	001~016

Processor	CO Line Range
RCTUBA/BB	001~048
RCTUC/D	001~144
RCTUE/F	001~200

LED	CO Line	X
20		
19		
18		
17		
16		
15		
14		
13		
12		
11		
10		
09		
08		
07		
06		
05		
04		
03		
02		
01		

LED	CO Line	X
20		
19		
18		
17		
16		
15		
14		
13		
12		
11		
10		
09		
08		
07		
06		
05		
04		
03		
02		
01		

LED	CO Line	X
20		
19		
18		
17		
16		
15		
14		
13		
12		
11		
10		
09		
08		
07		
06		
05		
04		
03		
02		
01		

Toll Restriction

Program 45-2 Overview

This program enables you to program lines be exempt from any Toll Restrictions defined in this section. Mark the exempt lines with an X on the record sheet. Toll Restrictions disabled in this program override Station Toll Restrictions defined in Program 48.

Program 45-3~6 – Special Common Carrier Numbers and Authorization Code Digit Length

Processor Type: DK14, DK40i, All RCTUs

Program Type: Toll Restriction

Initialized Default: Assigns blank data to Items 3 and 5 and "00" data to Items 4 and 6.

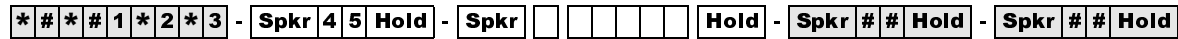

SELECT = Item 3-6
Enter the Item number
3-6 from the table below.

DATA =
First five digits of the SPCC number, or digit length
specified in the table below.

When editing:

- Press # to move cursor.
- Press LED Button 01 to delete or leave a blank.
- Press LED Button 02 to allow all digits to work.

Item	Description	DATA = 1st five digits (SPCC Number or Digit Length)
3	SPCC1 Telephone Number	
4	Allowed Digit Length (00~99)	
5	SPCC2 Telephone Number	
6	Allowed Digit Length (00~99)	

Program 45-3~6 Overview

This program notifies the system of how many digits to ignore before it applies Toll Restriction. It allows the system to use Special Common Carrier (SPCC) authorization codes to modify restrictions when the station user is dialing a long distance carrier. The user enters a telephone number to access the carriers. Original restrictions re-activate after the carrier number is dialed.

The sequence is: the first five digits of the SPCC Number (950XXXX) + Telephone Number + Credit Card Authorization Code.

SMDR prints out the following: SPCC Number + ---- + Telephone Number (the Authorization Code does not print out. If the SPCC access code is a 1+800 number, the dialed SPCC code will overwrite the actual telephone number dialed on the SMDR report.

Do not set 10XXX or 101XXXX Carrier Access Codes (CACs) in this program. The DK Strata system automatically treats CACs as special codes and applies Toll Restriction and LCR as follows:

- ♦ For stations that are Toll Restricted, 10XXX+1/101XXXX+1 are restricted for manual dialing but are allowed in system speed dial and LCR modified digit tables.
- ♦ 10XXX+0/101XXXX+0 are allowed or denied depending on the station's class and 46 (10-80) Key 01 assignment.
- ♦ LCR always routes 10XXX and 101XXXX via the local route plan, if not restricted.

There are two elements Toll Restriction software must verify for a user to successfully complete long distance calling:

- ♦ The first five digits of the number dialed to access the long distance special common carrier (SPCC).
- ♦ The total number of digits allowed following the SPCC number.

Items 3 and 5

Enter the first five digits of the SPCC telephone number in the spaces labeled SPCC1 Telephone Number (Item 3) or SPCC2 Telephone Number (Item 5) on the record sheet. The initialized state assigns “00000” to Items 3 and 5.

Items 4 and 6

The allowed digit length is the total number of digits allowed to be dialed after the SPCC Number and before Toll Restriction Digit Restriction activates. This can be 00~99 digits. In most cases, 99 digits should be allowed for voice mail applications. Do not enter a digit length greater than necessary or users may be able to override Toll Restriction.

Initialized data assigns “00” to items 4 and 6. Enter two digits on the record sheet.

A restricted station is not able to place a toll call through a long distance carrier by dialing the SPCC1 or SPCC2 telephone number if the station is denied from that number in other toll restriction programs. Upon recognizing the first five digits dialed, Toll Restriction software is notified to allow the number of digits programmed in items 4 or 6 (00~99, following the including the dialed SPCC1 or 2 number).

The system interprets data to be a seven-digit local call or 1-800 number to an SPCC. Only five digits are entered; therefore, the last digits are “wild card” digits; any number dialed that has the same first five digits as the carrier’s SPCC number, the system will assume the SPCC is being called.

Program 45-8~9 – Toll Restriction Override Code

Processor Type: DK14, DK40i, All RCTUs

Program Type: Toll Restriction

Initialized Default: Leaves code assignments blank

* # * # 1 * 2 * 3 - Spkr 4 5 Hold - Spkr [] [] [] [] Hold - Spkr # # Hold - Spkr # # Hold

SELECT = Item 8 or 9
 Enter 8 to select Code 1.
 Enter 9 to select Code 2.

DATA = Code
 Enter 1 to 4-digit code from the table below.
 Press LED Button 01 to delete or leave a blank.
 Press LED Button 02 to allow all digits to work.

SELECT =	Description	DATA = (1 to 4 Digits)
8 (Code 1)		
9 (Code 2)		

Program 45-8~9 Overview

This program enables selected stations in the system to alter the override code. These stations are defined by their users - specified in Program 30, Button/LED 09.

Two different codes can be dialed by any station user to override station-specific restrictions. These codes will not register on SMDR.

To change the codes from selected stations:

Code 1: [PDN] + **#654** + code + **Redial**

Code 2: [PDN] + **#655** + code + **Redial**

Notes

- Do not use the same four-digit codes set in Program 44-1~8, Toll Restriction/Traveling Class Override codes.
- Program 45 (8~9) overrides Program 44-1~8 if the same codes are used.
- Electronic telephone users can use the **#** button instead of the **Redial** button.
- Verified Account Codes (Forced or Voluntary) can also be used to override Toll Restriction on a call by call basis. When used for this function, the account code will register on the SMDR report (see Programs 69 and 70).

Program *45-1 (1~4) – Toll Restriction for Office Codes

Processor Type: DK14, DK40i, All RCTUs

Program Type: Toll Restriction

Initialized Default: Assigns 976 to first office code - blank for other three office codes

* # * # 1 * 2 * 3 - Spkr * 4 5 Hold - Spkr 1 [] [] [] Hold - Spkr # # Hold - Spkr # # Hold

SELECT = 1 DATA = Office Code (3 digits)
 SELECT = 1~4 Press LED Button 01 to delete a digit.

SELECT =	DATA = Office Code
1	976
2	
3	
4	

Program *45-1 Overview

This program enables you assign up to four office codes to be restricted within all area codes. This program only applies to telephone users which belong to toll restriction classes (assigned via Program 48). If a telephone user does not belong to any class, he/she is not subject to any of the restricted office codes assigned in this program.

The restricted office codes are verified when a user dials a seven-digit local call (in home area code) or a “1” plus ten-digit long distance call (in any area code).

Notes

- Use this program with Program 45 Dial Plan 7, 8, or 9 only.
- This table applies to all stations with Program 48 TR Codes 03~10 only (TR classes 1~8); not to stations with Program 48 TR Codes 00, 01, or 02.

Toll Restriction

Program *45-2 (1~6) – LCR/Toll Restriction Bypass for Special Numbers that Do Not Begin with */#

Processor Type: DK14, DK40i, All RCTUs

Program Type: Toll Restriction

Initialized Default: All data blank



SELECT = 2 DATA = 1~5 Digit Code
 (that are not subject to toll restriction)

First Digit: 0~9 only
 Non-first Digits: 0~9, *, #

When editing:

- Press LED Button 01 to delete or leave a blank.
- Press LED Button 02 to allow all digits to work.

SELECT =	DATA = 1~5 Digits
1	
2	
3	
4	
5	
6	

Program *45-2 Overview

Use this program to allow special CO Area Codes and Centrex feature access codes or extension numbers to bypass toll restriction and route over the local LCR route - if using LCR. (Toll Restriction is always applied after dialing the special numbers assigned to this table.

Codes programmed in this table will bypass Toll Restriction, and will be sent to the CO local route if using LCR. Calls subject to toll restriction are normally restricted if “*” or “#” is pressed during toll restriction digit analysis. However, in some special applications (e.g., the Strata DK System is connected behind a PBX/Centrex, or assume_9 Centrex dialing), “*” and/or “#” may be required within the first four digits or the last digit.

If the digit string containing */# matches with any of the six programmed digit strings of this program, toll restriction is applied after the matched digit string. This program can also be used for special area code dialing plans where the digit “1” is not dialed before the area code. See example on the Program *45-2 Examples.

Notes

- If using LCR behind Centrex, enter the Centrex trunk access code (such as “9” entered in the example below). If “9” is entered in this table, the user must dial 9 + 9 + 911 for an emergency call when using LCR.
- The record sheet above allows up to 5-digit numbers. If the number to be entered is less than 5 digits, enter Blanks (Button 01) for all digits less than 5 digits.

Example (Centrex assume 9)

If using LCR behind “assume 9” Centrex, and restricted stations (1+AC not allowed) must dial 12XX# and 13XX# as Centrex station numbers (# is the Centrex end-of-dialing code for extension numbers) enter **1 + 2 + Button 02 + Button 02 + #** and

1 + 3 + Button 02 + Button 02 + # as data in Programs *45-21 and *45-22, respectively.

This will allow Centrex station numbers (1200#~1299# and 1300#~1399#) to be dialed - overriding Toll Restriction. The call will route out the local LCR route immediately after the # is dialed.

Use this record sheet to assign area codes in 10-digit dialing areas. If some non-toll numbers require 10-digit dialing: Area Code (AC) + Office Code (OC) + YYYY dialing (no digit “1” before the area code) enter the area code in this table if dialing through LCR. Area codes entered in this table (without the long distance “1” prefix) will be routed over the LCR local call route when dialed with the AC + OC + YYYY format (YYYY = 4-digit CO extension number).

Example (10-digit Dialing)

If area code 817 is a local area code that must be dialed without the prefix digit “1”, enter: **8 + 1 + 7 + Button 01 + Button 01** in Program *45-2X. With this entry, LCR will route 817 calls over the local route immediately after dialing: **817 XXX XXXX** (10 digits).

This table applies to all stations with Program 48 TR Codes 03~10 only (TR classes 1~8); not to stations with Program 48 TR Codes 00, 01, or 02.

Notes

- When editing the data field, use Button/LED 01 to end the digit string, Button/LED 02 to assign a wild card value (0~9, *, #).
- See Program 46 (10~80) Button/LED 04 should be OFF when dialing codes containing * and/or #.

Toll Restriction

Program *45-3 (1~9) – LCR/Toll Restriction Bypass For Special Numbers that Begin with */#

Program *45-3 (1~9) – LCR/Toll Restriction Bypass For Special Numbers that Begin with */#

Processor Type: DK14, DK40i, All RCTUs

Program Type: Toll Restriction

Initialized Default: All data blank



- SELECT = 3
 SELECT = 1-9
 DATA = Digit String (1~3 digits)
 When editing:
 • Press LED Button 01 to end the digit string.
 • Press LED Button 02 to allow all digits to work.
 Do not enter * or #.
- OPTION = 0~4 (R4.15)
 0 = Code is not valid in ISDN; is valid in analog line
 1 = Privacy Change for ISDN; valid analog line
 2 = Privacy Change for ISDN; not valid analog line
 3 = No Privacy Change for ISDN; valid analog line
 4 = No Privacy Change for ISDN; analog line not valid
- OPTION = 0~3
 0 = No Toll Restriction after Special Code
 1 = Toll Restriction after Special Code
 2 = Special Code Restricted
 3 = LCR + Toll Restriction after Special Code (R3.2)

SELECT = (1~9)	DATA =	OPTION =	OPTION =
1			
2			
3			
4			
5			
6			
7			
8			
9			

Program *45-3 Overview

Codes programmed in this record sheet are ignored by Toll Restriction and sent to the appropriate route if using LCR. Calls started with "*" or "#" are normally not allowed. However, in some special applications (e.g., Caller ID blocking), "*" or "#" might be the first digit before dialing the actual destination's telephone number. This program assigns up to nine such codes for toll restriction bypass.

Digits dialed after the code starting with "*" or "#" are analyzed for toll restriction depending on the option (0~3) assigned following the digit code. The option value 0 indicates that no Toll Restriction applies to the telephone number dialed after the code is entered. The option value 1 indicates that Toll Restriction is applied as normal after the code entry. The option value 2 indicates that the call is restricted when the code is entered. The option value 3 applies LCR and TR after the code entry.

Use this program to allow special CO or Centrex access codes that begin with the * or # prefix. Assign them in this table if it is required to bypass Toll Restriction and/or route over the local LCR route, if using LCR. (T.R. options 0~3 will be applied after dialing the special numbers assigned in this table).

In the “Data = Digit String” part of the programming sequence, note that for two digit codes, such as 87, 82, 67, Key (LED Button 01) must be pressed to get to the following “Option=” section. For example, enter ***45 Hold Spkr 3 1 67_** (_ = Press LED Button 01) + **00**.

The Privacy Change option (0~4) enables the telephone user to override the setting for their own telephone. For instance, if Privacy Change is enabled, then a user can press ***67** to allow their Caller ID to be shown on the caller’s LCD.

Example 1

If using LCR behind Centrex and you must dial Centrex speed dial numbers ***700~*799**, enter **7 + Button 02 + Button 02 + 00** in Program *45-31. In this case, Toll Restriction will not be applied after the Centrex speed dial number (***7XX**) is sent to the Centrex because Option “0” is set.

Example 2

If you are dialing out and you wish to block the Caller ID feature, you must dial ***67** or the appropriate provider's code (e.g., ***82, *85**). In this case, enter **6 + 7 + Button 01 + 3** in Table *45-31. In this case, if the user dials ***67** + telephone number, then Toll Restriction and LCR is applied to the telephone number after ***67** is dialed because Option “3” is set. Also, if you want to override Privacy Change, for the fourth entry, Option “4”, enter a **1**.

In this case, enter **6 + 7 + Button 01 + 3** in Table *45-31. In this case, if the user dials ***67** + telephone number, then Toll Restriction and LCR is applied to the telephone number after ***67** is dialed because Option “4” is set.

To allow ***** or **#** to be entered as a first digit, a number must be entered in at least one table of Program *45-3X; do not enter ***** and **#** as the first digit of any number in Program *45-3X; Toll Restriction assumes the number entered in this table begins with a ***** or **#**.

Important! *To allow */# to be dialed as a first digit, at least one number must be entered in Program *45-3X.*

Program *45-4 – Special Code Dialing Sequence with LCR

Processor Type: DK424, all RCTUs (Release 4.1 and higher)

Program Type: Toll Restriction and LCR

Initialized Default: All LEDs OFF

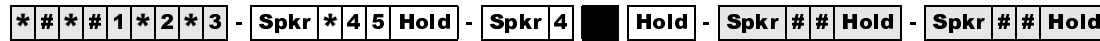

SELECT = 4 Light the LED Buttons that are marked with an X in the table below.

Button/LED	X	LED ON	LED OFF
20~3		Not used.	Not used.
02		Sends the digits from Program *45-3 before the Programs 55-1 Modified Digits Table (MDT) digits.	Sends the Programs 55-1 Modified Digits Table (MDT) digits before the digits from Program *45-3.
01		Inserts a pause into the dialing sequence.	Does not insert a pause into the dialing sequence.

Program *45-4 Overview

When LCR is used to make calls, this program determines if the codes set in Program *45-3 are sent before or after the digits that are set in the modified digits table (MDT). See Programs 55-1 and 55-0.

Program *45-4 only works when the code of Program *45-3x is dialed. The length of the pause inserted is determined by the timer setup in Program 12-3 (unit pause length of 1.5 or 3 seconds). This program has no effect on outgoing calls without Program *45-3 codes.

The digit deletion function of the modified digits table (Program 55-0) applies to the digits that immediately follow the Front Modified Digits Table (F-MDT).

LED 01: Pause following Program *45-3 code

If LED 01 is ON, a pause is inserted after the digits from Program *45-3 are sent; if LED 01 is OFF, a pause is not inserted.

LED 02: Order of LCR bypass code and MDT

If LED 02 is ON, the code from Program *45-3 is inserted before the Front Modified Digits Table (F-MDT) digits; if LED 02 is OFF, code from Program *45-3 is inserted after the F-MDT digits. (See example on Page -28.)

If LED 02 is ON, digits are not deleted from the Program *45-3 code per Program 55-0; if LED 02 is OFF, digits are deleted from the Program *45-3 code per Program 55-0.

LCR Example

The table below shows the actual dial output digits at the time that LCR sends them. These output digits are determined by the settings for LEDs 01 and 02. In this example, the user dials 9 + code + telephone number.

Program *45-4	LED 02 ON	LED 02 OFF
LED 01 ON	Code + Pause + F-MDT + number + E-MDT	F-MDT + Code + Pause + number + E-MDT
LED 01 OFF	Code + F-MDT + number + E-MDT	F-MDT + Code + number + E-MDT

- F-MDT = Added digits in Front of number dialed (Program 55-1)
E-MDT = Added digits at the End of number dialed (Program 55-2)
Code = Digits programmed in Program *45-3
Number = Dialed telephone number
9 = LCR access code
Pause = Pause time determined in Program 12-3

Program 46-2~4 – Toll Restriction Allowed/Denied Area Codes by Class

Processor Type: DK14, DK40i, All RCTUs

Program Type: Toll Restriction

Initialized Default: Includes all area codes in all classes

* # * # 1 * 2 * 3 - Spkr 4 6 Hold - Spkr [] [] [] [] Hold - Spkr # # Hold - Spkr # # Hold

SELECT = Toll Restriction Class
(see Legend below)

Enter: 2, 3, 4# _____
 2 = add to memory
 3 = Delete from memory
 4# = Display allowed codes in memory (press # to scroll)

DATA = Area Codes
Enter or display area codes.

To add a range, enter XXX*XXX (low area code * high area code).

Several ranges or individual area codes may be entered by separating them with the # button.

Processor	Toll Restriction Class
DK14	1~4
DK40i	1~4
RCTUA	1~4

Processor	Toll Restriction Class
RCTUBA/BB	1~4
RCTUC/D	1~8
RCTUE/F	1~8

Class: (Check one) Allowed Denied

DATA = Area Codes						

Class: (Check one) Allowed Denied

DATA = Area Codes						

- † Tables with deny box checked do not represent memory. All area codes in memory are allowed.
- † International calls may be allowed/denied by entering 011 as the area code. See Program 47 for International Call Restriction by Country Codes.

Program 46-2~4 Overview

Each class area code provides for a different combination of restrictions.

The tables in this program define the area codes allowed or denied for each Toll Restriction class. The tables (in memory) operate as allow tables. If an area code exists in a table (displays with 4#), then it is allowed. Anything not displaying is not allowed. Initialized data allows all area codes for each class (all codes are in all tables). All allowed area codes can be displayed (4#) for each class.

For each class, choose whether the record table is used to record allowed area codes in memory (allowed) or denied area codes not in memory (denied). Enter the area codes that define the set.

Program 46-6~8 – Toll Restriction Allowed/Denied Local Office Codes Assigned by Class

Processor Type: DK14, DK40i, All RCTUs

Program Type: Toll Restriction

Initialized Default: Includes all office codes in all classes



SELECT = Toll Restriction Class
(see Legend below)

Enter: 6, 7, 8#
6 = add to memory
7 = Delete from memory
8# = Display allowed codes in memory (press # to scroll)

DATA = Office Codes
Enter or display office codes.

To add a range, enter XXX*XXX (low office code * high office code).

Several ranges or individual office codes may be entered by separating them with the # button.

Processor	Toll Restriction Class
DK14	1-4
DK40i	1-4
RCTUA	1-4

Processor	Toll Restriction Class
RCTUBA/BB	1-4
RCTUC/D	1-8
RCTUE/F	1-8

Class: (Check one) Allowed Denied

DATA = Office Codes						

Class: (Check one) Allowed Denied

DATA = Office Codes						

- ♦ Tables with deny box checked do not represent memory. All office codes in memory are allowed.
- ♦ International calls may be allowed/denied by entering 011 as the area code. See Program 47 for International Call Restriction by Country Codes.

Toll Restriction

Program 46-6~8 Overview

This program defines the office codes allowed or denied for each Toll Restriction Class within the home area code. Office code tables for each class can each describe office codes allowed or denied for the class. The tables (in memory) operate as allow tables. If an office code exists in a table (displays with 8#), then it is allowed. Anything not displaying is not allowed. Initialized data allows all office codes in the home area code for each class.

For each class, choose whether the record table is used to record allowed office codes in memory (allowed) or denied office codes not in memory (denied). Enter the office codes that define the set.

Programs 46-10~80 – Toll Restriction Class Parameters

Processor Type: DK14, DK40i, All RCTUs

Program Type: Toll Restriction

Initialized Default: All LEDs OFF



Select Class from Legend below. Turn LEDs 01, 02, 03, or 04 ON to select restriction option.

Processor	Toll Restriction Class
DK14	1-4
DK40i	1-4
RCTUA	1-4

Processor	Toll Restriction Class
RCTUBA/BB	1-4
RCTUC/D	1-8
RCTUE/F	1-8

Class Number	Button 01 LED		Button 02 LED		Button 03 LED		Button 04 LED	
	ON	OFF	ON	OFF	ON	OFF	ON	OFF
	Dial 0 Restricted	Dial 0 Allowed	Dial 01 Restricted	Dial 01 Allowed	A/C+555 or 1+A/C+555 Allowed for all A/Cs	555 Allowed or Denied per A/C Restriction Table	Restrict Numbers that contain * or # within the first 4 digits	Allow Numbers that contain * or # within the first 4 digits
1								
2								
3								
4								
5								
6								
7								
8								

Programs 46-10~80 Overview

This program defines parameters of each Toll Restriction class, including dialing plan restrictions and exceptions to previous restrictions. This program also relates to Program 47. See Program 47 for more explanation.

Run these programs for dial 0, 01, */# restriction and long distance information (555) assignments.

Toll Restriction exceptions and dialing plan restrictions may be defined for each class.

- ♦ Programs 46-10 and 46-11 assign Class 1 restriction exceptions and parameters
- ♦ Programs 46-20 and 46-21 assign Class 2
- ♦ Programs 46-30 and 46-31 assign Class 3; etc.

LED 01: 0 Restricted

Mark an X next to LED 01 if operator or operator-assisted calls are restricted for the class being defined. To allow 0 + dialing LED 01 must be OFF. Allowing 0 + dialing allows operator-assisted toll calls. If a station is allowed 0 + Credit Card calling in Program 43, LED 01 must be OFF. Program 43 will restrict operator assisted calls.

LED 02: 01 Restricted

Mark an X next to LED 02 if overseas operator or unassisted overseas operator calls are restricted for the class being defined. If a station is allowed 0 + Credit Card calling in Program 43, LED 02 must be OFF. Program 43 will restrict 01 operator assisted calls.

LED 03: 1+AC+555 and AC+555 Allowed

Mark an X next to LED 03 to allow the particular class to call all restricted area codes plus the office code of 555, including out-of-area directory assistance calls. Turning the LED off does not necessarily deny information calls. This may also be accomplished in the office code table and/or the area/office code exception tables.

LED 04: Restrict Numbers Containing * or # Within the First Four Digits

Numbers set in Program *45-2X override the #/* restriction function of Program 46 (10~80) Button LED 04. LED 04 applies only to the first four digits of a dialed number when no digit restriction (Code 0) is set for the station Toll Restriction class in Program 48.

Turn LED 04 ON only if Strata DK CO lines are connected to a Central Office that absorbs * and # digits. The first four digits that contain # and * digits can be restricted (LED 04 ON). For example: if LED 04 is ON, 17# is restricted when the # is dialed but 1751# is allowed because “#” comes after the fourth digit dialed.

Turn LED 04 OFF if the telephone numbers that contain * and # after the first digit should be allowed (see Programs *45-2 and *45-3).

Programs 46-11~46-81 – Toll Restriction Class (1~8) Parameters

Processor Type: DK14, DK40i, All RCTUs

Program Type: Toll Restriction

Initialized Default: Leaves all LEDs OFF



Select Class from Legend below.

Light LED Buttons as required to assign Table to Class.

Processor	Toll Restriction Class	Exception Table
DK14	1~4	8
DK40i	1~4	8
RCTUA	1~4	8

Processor	Toll Restriction Class	Exception Table
RCTUBA/BB	1~4	8
RCTUC/D	1~8	16
RCTUE/F	1~8	16

LED	X	LED ON	LED OFF
20~17		Not Used	
16		Table 16 Area/Office Exception	Not Selected
15		Table 15 Area/Office Exception	Not Selected
14		Table 14 Area/Office Exception	Not Selected
13		Table 13 Area/Office Exception	Not Selected
12		Table 12 Area/Office Exception	Not Selected
11		Table 11 Area/Office Exception	Not Selected
10		Table 10 Area/Office Exception	Not Selected
9		Table 09 Area/Office Exception	Not Selected
8		Table 08 Area/Office Exception	Not Selected
7		Table 07 Area/Office Exception	Not Selected
6		Table 06 Area/Office Exception	Not Selected
5		Table 05 Area/Office Exception	Not Selected
4		Table 04 Area/Office Exception	Not Selected
3		Table 03 Area/Office Exception	Not Selected
2		Table 02 Area/Office Exception	Not Selected
1		Table 01 Area/Office Exception	Not Selected

Programs 46-11~46-81 Overview

Run these programs for area/office code exception table assignments.

Refer to the legend above the record sheet for exception tables and classes. Exception tables for both area and office codes will be defined in Program 47. Each class can be assigned any or all of the available office code exception tables.

Toll Restriction

Program 47 Overview

This program defines exceptions to previously defined office code restrictions for up to 16 area codes, allowing six-digit Toll Restriction. Office codes entered in Tables 01~16 are opposite of what is defined for the area code by Program 46-2~4. For instance, if Program 46 denies area code 714, entering office codes 530 and 555 into an exception table for area code 714 will allow 714 to be dialed only with office codes 530 and 555. Conversely, if 714 is allowed in Program 46, then 714 + 530 or 714 + 555 will be restricted.

Each area code with exception office codes requires a table. Each table may hold up to 800 exception office codes.

Enter the area code and required office codes on the record sheet.

For International Call Restriction by country codes, enter 011 for the area code, and Restricted country code(s) in the office table(s). To fully restrict a 2-digit country code, also Restrict the imaginary third digit of that country code.

For example, to Restrict country code 81, you must Restrict 10 country codes 810 to 819.

Program 48 Overview

This program assigns a combination of Digit Restriction and Station Restriction to each station port defined in the system.

Digit Restriction

If Digit Restriction is enabled for a particular station, the station is able to dial the number of digits defined in the Program 45-1 Toll Restriction dialing plan.

- ♦ Enter 1 in the Digit Restriction column to enable Digit Restriction for the selected station. This prevents a user from dialing a second call when dial tone is returned from a CO after the outside party disconnects.
- ♦ Enter 0 in the Digit Restriction column to disable Digit Restriction for the selected station. This allows toll restricted users to dial any number of digits (e.g., to an external voice mail device, computer, etc.).
- ♦ In systems prior to the DK280 Release 3.1 and in DK40i, digit restriction is always applied to restricted stations after dialing a number using system speed dial. With DK424 RCTU PCBs, digit restriction after dialing a number using system speed dial will only be applied to stations with digit restriction (Code 1) in this program.

Station Restriction

Station Restriction assigns Toll Restriction to individual station ports, in addition to previous restrictions. It includes eleven different choices (described below). One of the choices must be entered for each port. Station restrictions are overridden by lines disabled as defined in Program 45-2. If a station port has appearance of a line with restrictions disabled, the restrictions will be removed from the station on an individual line basis through Program 45-2.

Enter one of the following codes in the Station Restriction column:

Enter	Function	Description
00	No Station Toll Restriction (default)	
01	Area Code Toll Restriction	This restricts a station from dialing all area codes.
02	Area Code Toll Restriction and "0" or "1" as a first or second digit (for old plan 1, 2 or 3 or new plan 7, 8 or 9 - as defined in Program 45-1).	This prevents the station from making any long distance calls or operator-assisted calls, in addition to outgoing calls outside the home area code. In applicable areas, this prevents long distance office codes from being dialed (if 1+NNX).
03	Class 1 Toll Restriction	Class 1 area and office code restrictions are defined in Program 46, and exception office code tables in 46-10.
04	Class 2 Toll Restriction	Class 2 area and office code restrictions are defined in Program 46, and exception office code tables in 46-20.
05	Class 3 Toll Restriction	Class 3 area and office code restrictions are defined in Program 46, and exception office code tables in 46-30.
06	Class 4 Toll Restriction	Class 4 area and office code restrictions are defined in Program 46, and exception office code tables in 46-40.
07	Class 5 Toll Restriction	Class 5 area and office code restrictions are defined in Program 46, and exception office code tables in 46-50.
08	Class 6 Toll Restriction	Class 6 area and office code restrictions are defined in Program 46, and exception office code tables in 46-60.
09	Class 7 Toll Restriction	Class 7 area and office code restrictions are defined in Program 46, and exception office code tables in 46-70.
10	Class 8 Toll Restriction	Class 8 area and office code restrictions are defined in Program 46, and exception office code tables in 46-80.

Toll Restriction

Program 48 – Station Toll Restriction Classification

The following provides you an overview of the Least Cost Routing (LCR) feature and step-by-step instructions to fill in the Least Cost Routing System record sheets. The quantities of LCR plans, CO line groups, etc. vary between processors. This chapter and the LCR record sheets note these differences when they exist.

LCR enables the system to automatically route each outgoing voice call over common carriers and selected lines. The customer chooses these lines for the specific time of day, and for system users with varying priorities. If the system is programmed properly, LCR can select the most economical route. If the best routes are unavailable, users with priority can access more expensive outgoing routes. Several elements of LCR must be defined in programming.

For LCR to function properly:

- ♦ line groups must be created in Program 16;
- ♦ line restrictions must be set in Programs 40 and 41; and
- ♦ the area dialing plan must be assigned in Program 45-1.

LCR Features

Parameters

Enables LCR features, including a warning tone for last choice route number, a comfort dial tone during LCR processing, and the Long Distance Information dialing plan.

Home Area Code

Notifies LCR software of the area code of the installation site.

Special Codes

Notifies LCR of special emergency and operator codes that will be automatically routed as a local call, without unnecessary delay.

Long Distance Information Plan Number

Notifies LCR software how to route a long distance information call.

Local Call Plan Number

Notifies LCR software which call routing plan is designed to handle local and special calls.

Timeout after 0 (Zero)

Notifies the system of the time delay to the user after dialing a 0, before a regular operator is accessed.

Area Code and Office Code Exceptions

Separate area code tables and office code exception tables (quantity listed below) can be defined - one for each available call routing plan. Each table defines the area codes that are handled by the particular routing plan. According to the tables defined, specific exception office codes can be routed through a different call plan than the overall area code plan.

Processor	Area Code and Office Code Exception Tables	Call Routing Plans
DK14	8	8
DK40i	8	8
RCTUA	8	8

Processor	Area Code and Office Code Exception Tables	Call Routing Plans
RCTUBA/BB	8	8
RCTUC/D	16	16
RCTUE/F	16	16

Schedule Assignments Call Routing Plans

These plans (quantity listed above) can send the outgoing calls of different groups of stations according to a time schedule, and call route definitions.

Route Definitions

Groups of CO lines assigned to special common carriers, foreign exchange lines, or other special services can be specified as call routes.

LCR Modified Digit Assignments

Carrier codes can be programmed to dial automatically when a call is placed over the appropriate route. Digits can be added to the front or back of special common carrier codes or other access numbers to make placing calls an invisible process for the user. Digits may also be deleted from the front of the dialed number.

LCR Station Access Priority Assignments

Each station port defined in the system may be assigned to one of four station priority groups. The groups can have varying access to the defined call routes at different times of day. Each group is partitioned from the other groups.

LCR Conditions

If a station has direct line appearances, or Pooled CO Line buttons programmed to allow direct outgoing line access, LCR is bypassed using the **Pooled Line** or a **CO Line** button. LCR accommodates special code dialing, such as 911 for emergency response, 1-411 or 411 for information, or 800 area code toll-free numbers. These calls can be directed to the local call route (see Program 50-31~35).

Important! *Always provide emergency service access for numbers such as 911.*

Standard telephones that are Toll Restricted should be required to use LCR to place outgoing calls. This prevents Toll Restriction defeat when the K4RCU or RRCS times out.

LCR CO Line Programming Reference Table

1. Use Program 16 to assign CO lines in groups per the reference table below.

Processor	CO Line Group
DK14	1~4
DK40i	1~8
RCTUA	1~8

Processor	CO Line Group
RCTUBA/BB	1~8
RCTUC/D	1~16
RCTUE/F	1~16

Line Group	CO Line in Group	CO Line Type/Comments
01		
02		
03		
04		
05		
06		
07		
08		
09		
10		
11		
12		
13		
14		
15		
16		

2. Use Program 40 to allow CO line access to stations using LCR for outgoing calls.
3. Use Program 41 to deny outgoing CO line access, except for LCR access.

Important! *Area code and office code structure must be defined by Toll Restriction Dial Plan for LCR to work properly.*

4. Use Program 45-1 to enable the dial plan that is appropriate for the area where the LCR calls will originate.
5. Under the column labeled “CO Line Type/ Comments,” enter the service type, the common carrier name, or the line type for each line group, e.g., local line, Foreign Exchange (FX) to 818 (LA), WATS (out of state), etc.
6. Refer to the Program 40 to restrict stations from incoming and outgoing access of lines, including using LCR. All stations that must use LCR to make outgoing calls must *not* be restricted in this program. These restrictions do apply to LCR.
7. Refer to Program 41, to restrict stations from accessing outgoing lines, except through LCR. All stations that must use LCR for outgoing calls must be restricted from line access in this program.

Program 50-1 – LCR Parameters

Processor Type: DK14, DK40i, All RCTUs

Program Type: Least Cost Routing

Initialized Default: All LEDs OFF

* # * # 1 * 2 * 3 - Spkr 5 0 Hold - Spkr 1 Hold - Spkr # # Hold - Spkr # # Hold

SELECT = 1  Press LED Buttons for each LCR parameter

LED	ON		OFF	
01		Enable System LCR		No LCR
02		Not Used		Not Used
03		555 LDI Route per Program 50-4		Per Area Code Table
04		Dial Tone After LCR Access		Silent
05		Warning Tone Last Choice Route Number		No Warning Tone
10		No CO Dial Tone After Line Access		CO Dial Tone (R4.15)

Program 50-1 Overview

This program defines general operating parameters for LCR software.

- Program 40 denies CO line access via LCR, but denies all other access methods.
- Program 41 allows CO line access via LCR, but denies all other outgoing access methods: (#7001~#7200, 801~816, Line button).
- Toll Restricted standard telephones should be forced to dial outgoing calls via LCR. This is to prevent Toll Restriction defeat when the QRCU3, K4RCU3, K5RCU or RRCS times out.

LED 01: Enable System LCR

LED 01 ON: LCR software is enabled system-wide. For the Hospitality Management Information System (HMIS), this LED must always be set to ON.

LED 01 OFF: LCR software is disabled. None of the LCR programming referred to by this section is recognized. Dial 9 access assigned in Program 16 is enabled.

LED 02: Not used

LED 03: 555 LDI Route Per Program 50-4

LED 03 ON: LCR routes long distance information (LDI) calls over the plan number specified in Program 50-4.

LED 03 OFF: LCR routes LDI calls using area codes specified in route plans in the following table, as it would for any other call.

Processor	Route Plans Supported
DK14	8
DK40i	8
RCTUA	8

Processor	Route Plans Supported
RCTUBA/BB	8
RCTUC/D	16
RCTUE/F	16

LED Button 04: Dial Tone After LCR Access

LED 04 ON: Station users hear a simulated dial tone immediately after dialing the access LCR code (typically 9), until the first digit of the phone number is dialed. The dial tone is simulated to assure the user of the system’s proper operation, but it is not a functional dial tone.

For HMIS, set LED 04 ON.

If LED 04 is OFF, station users hear nothing after dialing the LCR access code until the destination rings or issues a busy signal.

LED Button 05: Warning Tone Last Choice Route Number

LED 05 ON: The user is notified with a warning tone to indicate that LCR has routed the call over the least desirable route number. The most expensive route is typically programmed to be the least desirable. A user has three choices upon hearing the warning tone:

- ♦ Ignore the tone, LCR places the call using the least desirable route.
- ♦ Hang up and try later to save money.
- ♦ Activate the Automatic Call Back feature. The appropriate line group calls the user back when a more desirable route number becomes available.

LED 05 OFF: No warning tone sounds.

Program 50-2 – LCR Home Area Code

Processor Type: *DK14, DK40i, All RCTUs*
Program Type: *Least Cost Routing*
Initialized Default: *Leaves the home area code blank*

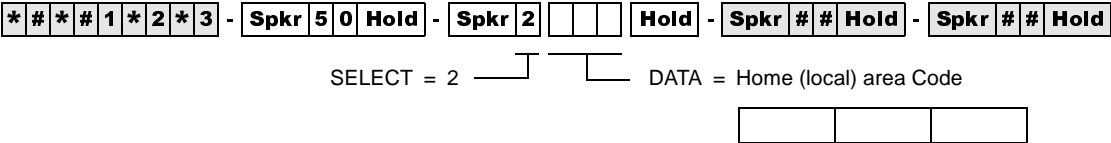

Program 50-2 Overview

LCR matches the area code entered here with the LCR route plan containing the home area code in its Area Code Table. (The home area code is later entered into one of the available LCR route plans through Program 51). Thus, LCR is informed of how to handle local calls.

Typically, systems are configured to have the LCR route plan containing the home area code as the same as the local route plan defined in Program 50-5. Typically you would program it to be Route Plan Number 1, rather than the default Plan 16.

Programs 50-3 (1~5) – LCR Special Codes

Processor Type: DK14, DK40i, All RCTUs

Program Type: Least Cost Routing

Initialized Default: 911 in 31, all other codes blank

* # * # 1 * 2 * 3 - Spkr 5 0 Hold - Spkr [] [] [] [] Hold - Spkr # # Hold - Spkr # # Hold

SELECT = 31~35
Enter 31~35 to indicate
the special code.

DATA = Special Code
Enter the code from the table below.

Key 01 = blank

SELECT =	Special Code (4 Digits)	Examples
31		911
32		411
33		
34		
35		

Programs 50-3 (1~5) Overview

This program allows special 1~4 digit codes such as 911 to be routed over the local call route immediately when dialed. If Enhanced 911 (E911) is required, E911 programs should be used instead of this program.

You can enter five special codes in the spaces provided next to 31~35. The codes can be a maximum of four digits, and should include items such as 911 for emergency calls, and 411 or 1+411 for local information, etc.

When any of these codes are dialed, LCR is flagged to treat the call as follows:

- ♦ The call is sent over the local call route plan specified in Program 50-5.
- ♦ No additional digits need to be dialed. They are not necessary. Therefore, the call is put through immediately.

Program 50-4 – LCR Long Distance Information (LDI) Plan Number

Processor Type: DK14, DK40i, All RCTUs

Program Type: Least Cost Routing

Initialized Default: See the legend below

* # * # 1 * 2 * 3 - Spkr 5 0 Hold - Spkr 4 [] [] Hold - Spkr # # Hold - Spkr # # Hold

SELECT = 4 DATA = LDI Route Plan (see Legend below)

Processor	LDI Route Plans	LDI Route Plans Default
DK14	01-08	08
DK40i	01-08	08
RCTUA	01-08	08

Processor	LDI Route Plans	LDI Route Plans Default
RCTUBA/BB	01-08	08
RCTUC/D	01-16	16
RCTUE/F	01-16	16

Program 50-4 Overview

Enter the number of the LCR route plan over which long distance information calls will be routed. Typically, long distance information calls are routed over the local call route defined in Program 50-5.

- ♦ If you choose the long distance information plan in Program 50-1, the call is routed as defined by this table.
- ♦ Typically, LDI Plan Number = Local Call Plan Number.

Program 50-5 – LCR Local Call Plan Number

Processor Type: DK14, DK40i, All RCTUs

Program Type: Least Cost Routing

Initialized Default: See the legend below

* # * # 1 * 2 * 3 - Spkr 5 0 Hold - Spkr 5 [] [] Hold - Spkr # # Hold - Spkr # # Hold

SELECT = 5 [] [] DATA = Local Call Plan (see Legend below)

Processor	Local Call Plan Number	Local Call Plan Default
DK14	01~08	08
DK40i	01~08	08
RCTUA	01~08	08

Processor	Local Call Plan Number	Local Call Plan Default
RCTUBA/BB	01~08	08
RCTUC/D	01~16	16
RCTUE/F	01~16	16

Program 50-5 Overview

The Local Call Plan handles special codes and operator calls. Of the 16 Route Plans available for LCR call processing, define one as the Local Call Plan, typically Route Plan 1. Enter the number of the plan over which local calls, operator-assisted/0+ calls, and special code calls will be routed.

Program 50-6 – LCR Dial 0 (Zero) Time-out

Processor Type: DK14, DK40i, All RCTUs

Program Type: Least Cost Routing

Initialized Default: Assigns an LCR Dial Zero Time-out value of 06

* # * # 1 * 2 * 3 - Spkr 5 0 Hold - Spkr 6 [] [] Hold - Spkr # # Hold - Spkr # # Hold

SELECT = 6 DATA = Time-out Value

Enter a time-out value from 04~10 seconds long.

Program 50-6 Overview

Enter the maximum number of seconds LCR waits for a user to dial additional digits after a 0, before it routes the call to an operator for assistance. LCR waits this number of seconds to receive additional digits that indicate charge calls, collect calls or other 0+ calls.

- ♦ The allowed range is 04~10 seconds. Always enter two digits.
- ♦ Dial 0 calls will be restricted when using 0 + Credit Card calling (Program 43) if a telephone number is not dialed after dialing 0 or if Dial 0 is restricted in Program 46 (10~80).

Overview for Programs 51~54

These programs provide the system with directions for routing all possible calls, made by all possible users at all possible times of day. Tables for Programs 51~54 appear on LCR Route Plan Numbers 1~16. The following instructions show how to fill in individual tables within the plans. Each of the following program tables must be completed for all plans.

Programs 51~54 defines LCR route plans (quantities given below):

Processor	LCR Route Plans
DK14	8
DK40i	8
RCTUA	8

Processor	LCR Route Plans
RCTUBA/BB	8
RCTUC/D	16
RCTUE/F	16

These separate plans provide the customer flexibility enough to route different area codes and exception office codes over different line groups.

Program 51 Overview

Use Program 51 to define which area code calls are placed over which LCR Plan Number (01~08 or 01~16). Therefore, calls made to all area codes are routed over route definitions defined in Program 54 for Plan 08 or 16, following the time schedule specified by Program 53 for Plan 08 or 16 (unless other assignments are made in plans 1~15).

Every route plan can be assigned to define a set of area codes and/or office codes.

011 can be entered as an Area Code into any LCR plan to route direct dial international calls via LCR.

Example

Any area code entered in a Program 51 LCR area code table for plans 1~15 is subtracted from Plan 16. An area code cannot be lost. If it is subsequently deleted from Plans 01~07 or Plans 01~15, LCR software automatically adds it to Plan 08 or 16.

Remember that LCR matches the home area code entered in Program 50-2 with the LCR route plan containing the home area code in its Area Code Table. The home area code must be entered into one of the 16 available LCR route plans through Program 51. Thus, LCR is informed of how to handle local calls.

Typically, systems are configured to have the LCR route plan containing the home area code as the same as the local route plan defined in Program 50-5. This usually is programmed by the installer to be Route Plan Number 1, rather than the default Plan 08 or 16.

HMIS Example

Plan 01 includes home area code, 800, 888. Plan 08 includes long distance area codes. Plan 16 is used for RCTUC/D and RCTUE/F processors. The following table gives you an example of how you might set up Program 51 for the HMIS:

LCR Plan: <input style="width: 50px;" type="text" value="01"/>	LCR Plan: <input style="width: 50px;" type="text" value="02"/>	LCR Plan: <input style="width: 50px;" type="text" value="08"/>	LCR Plan: <input style="width: 50px;" type="text"/>																																																																								
<table border="1" style="width: 100%; border-collapse: collapse;"> <thead> <tr><th colspan="3">Data = Area Code(s)</th></tr> </thead> <tbody> <tr><td style="text-align: center;">714</td><td></td><td></td></tr> <tr><td style="text-align: center;">800</td><td></td><td></td></tr> <tr><td style="text-align: center;">888</td><td></td><td></td></tr> <tr><td></td><td></td><td></td></tr> <tr><td></td><td></td><td></td></tr> </tbody> </table>	Data = Area Code(s)			714			800			888									<table border="1" style="width: 100%; border-collapse: collapse;"> <thead> <tr><th colspan="3">Data = Area Code(s)</th></tr> </thead> <tbody> <tr><td></td><td></td><td></td></tr> <tr><td></td><td></td><td></td></tr> <tr><td></td><td></td><td></td></tr> <tr><td></td><td></td><td></td></tr> <tr><td></td><td></td><td></td></tr> </tbody> </table>	Data = Area Code(s)																		<table border="1" style="width: 100%; border-collapse: collapse;"> <thead> <tr><th colspan="3">Data = Area Code(s)</th></tr> </thead> <tbody> <tr><td style="text-align: center;">000</td><td style="text-align: center;">713</td><td></td></tr> <tr><td style="text-align: center;">715</td><td style="text-align: center;">799</td><td></td></tr> <tr><td style="text-align: center;">801</td><td style="text-align: center;">887</td><td></td></tr> <tr><td style="text-align: center;">889</td><td style="text-align: center;">999</td><td></td></tr> <tr><td></td><td></td><td></td></tr> </tbody> </table>	Data = Area Code(s)			000	713		715	799		801	887		889	999					<table border="1" style="width: 100%; border-collapse: collapse;"> <thead> <tr><th colspan="3">Data = Area Code(s)</th></tr> </thead> <tbody> <tr><td></td><td></td><td></td></tr> <tr><td></td><td></td><td></td></tr> <tr><td></td><td></td><td></td></tr> <tr><td></td><td></td><td></td></tr> <tr><td></td><td></td><td></td></tr> </tbody> </table>	Data = Area Code(s)																	
Data = Area Code(s)																																																																											
714																																																																											
800																																																																											
888																																																																											
Data = Area Code(s)																																																																											
Data = Area Code(s)																																																																											
000	713																																																																										
715	799																																																																										
801	887																																																																										
889	999																																																																										
Data = Area Code(s)																																																																											

Least Cost Routing

Program 52 – LCR Office Code Exceptions for Specified Area Code

Program 52 – LCR Office Code Exceptions for Specified Area Code

Processor Type: DK14, DK40i, All RCTUs

Program Type: Least Cost Routing

Initialized Default: Leaves all office code tables blank and all tables assigned to LCR Plan (see legend below)

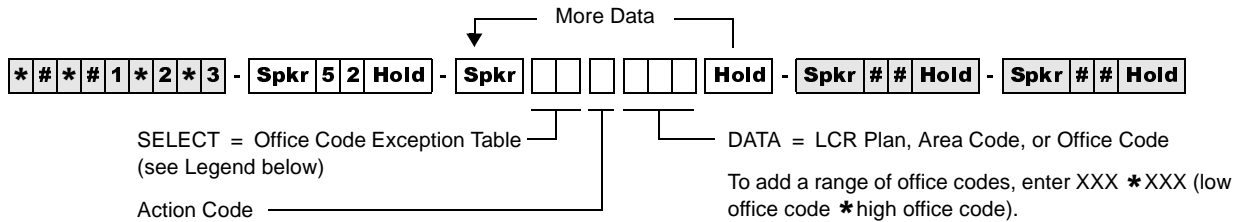

Action Code Function	Action Codes	DATA =
Assign Exception Table to LCR Plan	0	(LCR Plan 01~16):
Assign Area Code to LCR Plan	1	(3-digit Area Code):
Add Office Code to Exception Table	2	(3-digit Office Code):
Delete Office Codes from Exception Table	3	(3-digit Office Code):
Display Office Codes in Exception Table	4# more #	(3-digit Office Code):

Processor	Table Number	LCR Plan	LCR Exception Codes
DK14	01~08	01~08	8
DK40ii	01~08	01~08	8
RCTUA	01~08	01~08	8

Processor	Table Number	LCR Plan	LCR Exception Codes
RCTUBA/BB	01~08	01~08	8
RCTUC/D	01~16	01~16	16
RCTUE/F	01~16	01~16	16

Table Number: []
 Area Code: []
 LCR Plan: []

Table Number: []
 Area Code: []
 LCR Plan: []

Table Number: []
 Area Code: []
 LCR Plan: []

Table Number: []
 Area Code: []
 LCR Plan: []

Data = Office Code(s)		

Data = Office Code(s)		

Data = Office Code(s)		

Data = Office Code(s)		

Program 52 Overview

This Office Code exception table enables the user the flexibility of routing specific office codes through a different call plan than other office codes used with that area code.

- ♦ Any number of exception code tables can be assigned to each route plan, although each exception table can only be used once system-wide.
- ♦ Every route plan can be assigned to define a set of area codes and office code exceptions or a set of office code exceptions.
- ♦ This program applies to both examples listed below. In the first case, an office code exception table does not need to be defined in addition to the area codes in Program 51, but it may. In the second case, the plan only pertains to exception office codes for certain area codes.
- ♦ To route International (011) calls over any selected plan by Country Code, program 011 as the Area Code and the Country Code as the Office Code in Program 52 in any Exception Code Table. If the Country Code is two digits, add 10, 3-digit Office Codes as follows: XX0 through XX9, where XX is the Country Code.

Example 1

In the first example, office code exception tables are defined to the area code table. Use the continuation sheet to define the exception office codes. As many as 16 office code exception tables can be linked to a plan, but each exception table can only be used once. When using the continuation sheet, be sure that the same exception table is not assigned to more than one plan.

1. Turn to the continuation sheet (that follows Plan 16 record sheet).
2. Determine the plan number where the exception office codes will be routed.
3. Fill in the area code of the exception office codes in the spaces provided by the correct plan number. These office codes will be routed differently than the overall area code.
4. Enter the specific office codes that are to be routed differently.

Example 2

In the second example, the route plan only applies to office code exceptions. The first office code exception table may be documented on the LCR Plan record sheet:

1. Check the box on the record sheet next to Office Code Exception Table number.
2. Enter the number of the exception table (01~16). Make sure this table number is not entered on any other plan, or on the continuation sheet.
3. Enter the applicable area code.
4. Enter the specific office codes that are to be routed differently than the area code.

Program 53 Overview

This program assigns up to three time schedules to each plan. Each time schedule consists of four or six different route definition choices (defined in Program 54) available to the eight station groups (defined in Program 56). It may be helpful to complete Program 54 portions of the plans and Program 56 before proceeding.

If Schedules 1 & 2 start at the same time, then Time of Day schedule change does not occur, and data only needs to be entered for Schedule 1.

Typical Installation Without Time Schedule Feature

In most cases, an installation does require use of the time schedule feature. To reflect this on the record sheets for Plans 01~16:

1. Enter the same Schedule Start Times for Schedules 1 and 2. Use the military format - HH:MM (Hours:Minutes). Fill in all four digits.

Note If LCR software sees Schedules 1 and 2 have the same start times, then it only looks at Schedule 1 for route definitions.

2. Enter Route Definition numbers for Schedules 1 and 2. Four definitions (route pick or choices) can be entered for each group.
 - ✦ LCR Station (Class) Groups 1~8 are assigned in Program 56.
 - ✦ LCR Route Definition numbers 1~4 or 1~6 are defined in Program 54.
3. The order in which the route definitions are entered defines the order of LCR line selection. The most desirable route should be entered in the left-most position, and the least desirable route in the right-most position.
4. If “1” is assigned to Station Group 1, and 1 for route definition only, then those assigned will only be able to use Route Definition 1, thereby restricting them during times that route definition 1 is not allowed.
5. Keep in mind that the route definition number is being entered, not the CO line group number. The definitions are assigned in Program 54.

Installation Requiring Time Scheduling Feature

When an installation requires the time scheduling feature to be programmed, three “shifts” of route definitions can be assigned per station group. To reflect this on the record sheet, substitute Step 1 of the procedure described for the typical customer with the following:

- Enter the Schedule Start Times for Schedules 1, 2 and 3. Use military time, in the format HH:MM (Hours:Minutes). Fill in all four digits. Initialized data assigns “0000” to all times.
 - ✦ Start time for schedule 2 is the stop time for schedule 1.
 - ✦ Start time for schedule 3 is the stop time for schedule 2.
 - ✦ Start time for schedule 1 is the stop time for schedule 3.

HMIS Example

Enter LCR schedule assignments for LCR plan 01, 02 and 08/16. Stations in groups 1, 2, and 3 are controlled by HMIS. The following table gives you an example of how you might set up Program 53 for the HMIS:

Least Cost Routing

Program 53 – LCR Schedule Assignments for LCR Plans

LCR Plan 01~16	Sched. 1~3	Program 56 LCR Station Group (see legend above)	Program 54 Route Definition # (see legend above)				LCR Plan 01~16	Sched. 1~3	Program 56 LCR Station Group (see legend above)	Program 54 Route Definition # (see legend above)			
			1st Pick	2nd Pick	3rd Pick	4th Pick				1st Pick	2nd Pick	3rd Pick	4th Pick
01	1	1	1] Home Area Code	←	Guest Room with restricted calling							
		2	1			Guest Room local/800/888/911							
		3				Guest Room complete restriction/911 only							
		4	1			Hotel Administration (unrestricted)							
02	1	1	1] Local Call Route/ 911									
		2	1										
		3	1										
		4	1										
08	1	1	1] Long Distance									
		2											
		3											
		4	1										

Least Cost Routing

Program 54 – LCR Route Definition Tables

Route Definition Number

Route definitions define the CO line group and modified digit tables used for each LCR Plan. See the legend for the number of route definition numbers for your processor.

CO Line Group (assigned in Program 16)

Each line group represents a type of service, e.g., special common carrier, foreign exchange, local line group, etc. Program 40 denies incoming and outgoing line access to stations, including LCR access. Program 41 allows line access to stations using LCR only for outgoing calls when enabled.

Modified Digits Table

Refer to Programs 55-0, 55-1 and 55-2. The system handles line groups differently, according to which modified digits table was assigned in Program 54.

HMIS Example

The following table gives you an example of how you might set up Program 54 for the HMIS:

LCR Plan 01-16	Route Definition # (see legend above)	Program 16 CO Line Group (see legend above)	Program 55 Modified Digits (see legend above)	LCR Plan 01-16	Route Definition # (see legend above)	Program 16 CO Line Group (see legend above)	Program 55 Modified Digits (see legend above)
01	1	01	01	←	Local		
02	1	01	01	←	911		
08	1	01	01	←	Long Distance		

Program 55 – LCR Modified Digits Table

Processor Type: *DK14, DK40i, All RCTUs*

Program Type: *Least Cost Routing*

Initialized Default: *See each program in the Program 55-X series*

Program 55 Series Overview

This program defines call handling so the route definition used by LCR is invisible to the station user. The station user handles all calls the same way. The goal is for LCR to remember the dialing peculiarities of each call route, so the user does not need to know.

Processor	Modified/Add/Delete Digit Tables
DK14	6
DK40i	6
RCTUA	6

Processor	Modified/Add/Delete Digit Tables
RCTUBA/BB	6
RCTUC/D	12
RCTUE/F	12

Each modified digits table assigns editing steps that include:

- ♦ Deleting a pre-defined quantity of digits from the front of the number dialed (Program 55-0).
- ♦ Adding a pre-defined number to the front of the number dialed (Program 55-1).
- ♦ Adding a pre-defined number to the end of the number dialed (Program 55-2).

Program 55-0 – Delete Number of Digits From the Front of Dialed Number

Initialized Default: All tables blank

* # * # 1 * 2 * 3 - Spkr 5 5 Hold - Spkr 0 Hold - Spkr # # Hold - Spkr # # Hold

SELECT = Modified Digits Table (see Program 55 Legend) FIGURE = Quantity of Digits (00~10) to be deleted.

Program 55-0
Delete Digits Table

Table Number	Quantity of Digits (01~10 max)
01	
02	
03	
04	
05	
06	
07	
08	
09	
10	
11	
12	

Program 55-0 Overview

Enter the quantity of digits that should be deleted from the front of the number dialed for each of the Table Numbers in the Delete Digits Table. The maximum number is 10. Always make the entry two digits.

If the Delete Digits Table is activated, refer to Programs *45-3 and *45-4 if special dialing codes, such as Caller ID blocking, etc., will be used.

Program 55-1 and 2 – Add Digits Before and/or After the Dialed Number

Initialized Default: Leaves all tables blank except Delete Digits, which are all 00



SELECT = Modified Digits Table

CODE = Digits added (up to 22)

- 1 = Add digits in front of number dialed (F-MDT)
- 2 = Add digits at the end of number dialed (E-MDT)
(see Program 55 and *45-4 Legend)

Enter the digits to be added. Pauses may be coded as described in the pause entry reference table below.

Pause Entry Reference (Programs 55-1, 55-2)

Key/LED	Pause (Seconds)	Record Entry	Special Functions
08	16	P8	Key/LED 09 (R4.15) ISDN Start Key, LCD = G
07	14	P7	Key/LED 11: Clear All
06	12	P6	Key/LED 10: Convert DP to DTMF, LCD = T
05	10	P5	
04	8	P4	
03	6	P3	Key/LED 12: Code for ISDN Sub-address Separator LCD = S
02	4	P2	
01	2	P1	

Modified Digits Table (MDT) Add to FRONT of Dialed Number (Program 55-1)

Table No.	1	2	3	4	5	6	7	8	9	10	11	12	13	14	15	16	17	18	19	20	21	22	
01																							
02																							
03																							
04																							
05																							
06																							
07																							
08																							
09																							
10																							
11																							
12																							

Modified Digits Table (MDT) Add to END of Dialed Number (Program 55-2)

Table No.	1	2	3	4	5	6	7	8	9	10	11	12	13	14	15	16	17	18	19	20	21	22	
01																							
02																							
03																							
04																							
05																							
06																							
07																							
08																							
09																							
10																							
11																							
12																							

Program 55-1 and 2 Overview

Enter the digits that must be added to the front of the number dialed in the Add Digits Table. The maximum digits is 22, including pauses.

- ♦ Length of pause can be indicated by using codes (P1~P8) specified in the Pause Entry Reference Table. Each pause takes two digits of memory space.
- ♦ Try to allow for the longest wait, e.g., make the pause longer, rather than shorter, to accommodate the length of time a carrier may need to access the service tones, etc.
- ♦ If using special codes in Program *45-3, use Program *45-4 to indicate if the Program *45-3 codes should be sent before or after the Program 55-1 and 55-0 Modified Digits Table (MDT) digits. Program *45-4 also allows a pause to be inserted into the dialing sequence.

Program 56 Overview

The purpose of this program is to assign all defined station ports to one of four or eight LCR Station Groups (see Program 56, record sheet notes).

- ♦ Station groups are completely independent of one another. Therefore, each station group must be defined separately.
- ♦ Software does not automatically assign the highest, all-inclusive routing priority to Class 1 stations, making all routes available to Class 2~8 stations available to Class 1 as well.
- ♦ Instead, stations are assigned (partitioned) to independent groups. Flexible assignment of routing definitions to groups is allowed, with no one group's definition affecting another's. Each group's route definitions are specified to activate separately according to the time schedules set by Program 53. Enter the station group number next to the port number.

HMIS Example

LCR Station Group Assignments for LCR Plans 01, 02, and 08/16:

	LCR Group	Allows
Guest Rooms	01	All calls to be dialed by rooms.
	02	Local Calls, 800/888, 911 only.
	03	911 only.
Administration	04	As needed (most likely will be the same as Group 01).

This chapter provides ACD programming information for the Strata DK424 system and its stations. ACD is not available for the DK14 or DK40i.

The programs specific to ACD are listed below.

- ♦ **Program 03** – RSIU, RSSU, PIOU, or PIOUS ACD/MIS Slot Assignments
- ♦ **Program 09** – Auto Attendant Prompt/ACD Group Assignments
- ♦ **Program *09** – ACD Group DID/Tie Line Digit Assignments (use if Program 71 is not used)
- ♦ **Program 10-4** – ACD Parameters
- ♦ **Program 11** – ACD Timing Assignments
- ♦ **Program 14-0** – Loop/Ground Start CO Line Direct Ring to ACD Group Assignments
- ♦ **Program 14-1** – ACD Agent Identification Code Assignments
- ♦ **Program *14-1** – Auto Answer with Zip Tone Assigned to Agent ID
- ♦ **Program 14-2** – ACD Supervisor Passwords
- ♦ **Program *14-2** – DID/Tie/DNIS/ANI Line After Shift and Overflow Substitution Destination
- ♦ **Program 14-3** – Announcement/Music Port Assignments and Queue Pattern
- ♦ **Program 14-4** – Queue Time Out Overflow Destination
- ♦ **Program 14-5** – Overflow Point and Ring No Answer Routing Destination Assignments
- ♦ **Program 14-6** – After Shift Service Destination
- ♦ **Program 14-71** – Queue Size for Alarm (Immediate Assignments)
- ♦ **Program 14-72** – Queue Size for Alarm 1 (See also Timer Program 11-6 in *Strata DK Programming Manual*)
- ♦ **Program 14-73** – Queue Size for Alarm 2 (See also Timer Program 11-7 in *Strata DK Programming Manual*)
- ♦ **Program 14-8** – Alarm Pattern Assignments
- ♦ **Program 14-9** – Work Unit Assignments (Work Unit/Stroke Digit Length)
- ♦ **Program 15** – Ground/Loop/Tie/DID Line Options
- ♦ **Program 17** – DID/Tie Line Options
- ♦ **Program 18** – Agent ID Code Name for MIS Assignments
- ♦ **Program 35** – Station Class of Service
- ♦ **Program 39** – Flexible Button Assignments for ACD Telephones (in System and Station Chapter)
- ♦ **Program 71** – DID/Tie/DNIS/ANI Lines (use if Program *09 is not used)

Star (*) programs are the newer programs, and they are located behind the program of the same name (e.g., Program *14-2 follows Program 14-2).

Program 03 – RSIU, RSSU, PIOU, PIOUS ACD/MIS Slot Assignments

Initialized Default: *n/a*

* # * # 1 * 2 * 3 - Spkr 0 3 Hold - Spkr Hold Spkr # # Hold - Power OFF (5 sec.) then ON

PIOU, PIOUS, or RSSU Slot Number (12-78)
...or RSIU Slot Number 11

Enter 42 to assign the PIOU, PIOUS, or RSSU
TTY Port as MIS port, or enter 49 to assign RSIU
to slot 11 (see Program 76 if installing RSIU).

Program 03 Overview

This program is for specifying RSIU, RSSU, PIOU, or PIOUS ACD/MIS Slot Assignments.

If MIS output is required for ACD, set Code 42 for the slot in which the RSSU, PIOU or PIOUS is installed, or Code 49 if RSIU is installed in slot 11 (that connects to the SMIS personal computer). If you use RSIU/RSIS for MIS output, you must set the appropriate port for MIS operation/speed using Program 76.

Program 09 – Auto Attendant Prompt/ACD Group Assignments

Initialized Default: *n/a*

* # * # 1 * 2 * 3 - Spkr 0 9 Hold - Spkr # # Hold - Spkr # # Hold - Spkr # # Hold

SELECT = Dialed Digit(s)
Menu prompts offered to caller (1 or 2 digits)

AUTO ATT DIAL = ACD Group Number
Enter the ACD Group numbers which will receive Auto Attendant calls. Press * if establishing the first digit of a two digit dialing format.

Processor	ACD Group Numbers
RCTUBA/BB	01-08
RCTUC/D	01-16
RCTUE/F	01-16

Dialed Digit (Menu Prompts)	ACD Group Number	Department, Division, Etc.
0		
1		
2 ¹		
3 ¹		
4 ¹		
5		
6		
7		
8		
9		

1. Do not use digits 2, 3, and 4, unless the station numbering plan is changed. These numbers conflict with the default station [PDNs] of the system.

Program 09 Overview

Program 09 enables you to assign Auto-Attendant (AA) prompt numbers that will route calls to specific ACD Groups.

Important! *If using DK Built-in AA, program call flow assignment of DK AA per Chapter 10 – Peripheral Installation of the DK Installation and Maintenance Manual.*

► To enter one-digit dialing prompts along with their destination station numbers

1. Enter Program 09. “SELECT” appears on the LCD.
2. Press the desired prompt digit. “AUTO ATT DIAL” displays on the LCD.
3. Enter **#4XX** (XX = the destination ACD Group number associated with the prompts) and press the **Hold** button.
4. Repeat Steps 2 and 3 for more prompt-station entries.

Automatic Call Distribution

Program 09 – Auto Attendant Prompt/ACD Group Assignments

► **To enter two-digit dialing prompts along with their destination group numbers**

1. Enter Program 09. “SELECT” appears on the LCD.
2. Press the desired leading digit. “AUTO ATT DIAL” displays on the LCD.
3. Press * then the **Hold** button. The first digit will now be set.
4. Press **Spkr**, then press a second digit. “AUTO ATT DIAL” displays on the LCD. Enter **#4**.
5. Enter the destination ACD Group number assigned to the two-digit prompt, then press the **Hold** button.
6. To complete more second digit prompt-station entries, repeat Steps 4 and 5.

Notes

- When transmission and DTMF levels are lower than normal or when the digital announcement voice frequencies match DTMF digital frequencies (talk-off), AA efficiency may be improved with two-digit dialing options, instead of one-digit dialing options.
- Press button LED 01 to delete data.
- Program 78-61~63 overrides CO line assignments in Program 14-0, which means CO lines that are assigned to AA and ACD Groups will be routed to the AA.

Program *09 – ACD Group DID Line Digit Assignments

Initialized Default: See table below

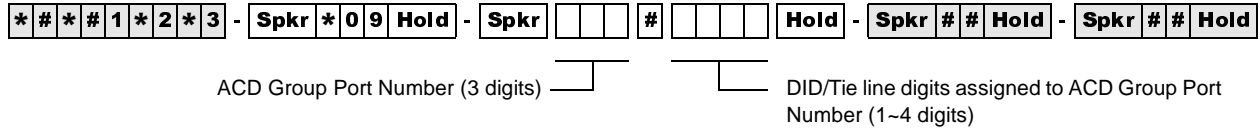

Processor	ACD Group Port Numbers	Default DID/Tie Line Digits
RCTUBA/BB	090~097	290~297
RCTUC/D	250~265	450~465
RCTUE/F	345~360	870~885

ACD Group Number	ACD Group Port Number	DID/Tie Line Digits Assigned (1~4 Digits)

Program *09 Overview

Program *09 assigns DID/Tie line incoming digits to a particular ACD Group and assigns DID digits to station ports (only if Program 71 is not used).

Related Programs

Program 04 assigns Tie line digits to station ports. (See Programs *09 and 04 in the *Strata DK Programming Manual*.)

Refer to Program 17, LED 05-for DID and Tie line options. Use Program *09 if Program 71 DID/Tie/DNIS/ANI line call routing is not being used.

If the digits assigned to the group are sent to the Strata DK System on any incoming DID or Tie line call, the call is directed to the assigned ACD Group (see Program 14-0 to assign ground and loop start lines to an ACD Group).

Note If DID/Tie/DNIS/ANI lines use Program 71 (DNIS assignments) instead of Program *09 to route callers to ACD Groups, turn on LED 05 in Program 17 for each of the appropriate DID/Tie/DNIS/ANI lines. If the line receives ANI but not DNIS, turn LED 05 OFF and 07 and 08 ON in Program 17. Use Program 71 (0~3) to make the appropriate digit and routing assignments. Refer to Programs 17 and 71.

Program 10-4 – ACD/ISDN Parameters

Initialized Default: LEDs 12 and 14 are ON

* # * # 1 * 2 * 3 - Spkr 1 0 Hold - Spkr 4 Hold - Spkr # # Hold - Spkr # # Hold

SELECT = 4  Light Button/LEDs as defined by the table below. If the X column is checked, the LED should be ON.

Button/ LED	X	LED ON	LED OFF
20			
19			
18			
17			
16			
15			
14		ISDN "Start" access code is sent when the Speed Dial (SDS) button is pressed (initialized).	ISDN Start access code is not sent.
13		Receive 3.1kHz audio calls as speech calls only if a progress indicator is sent.	Always receives 3.1kHz calls.
12		BRI T-Wait ON (initialized)	BRI T-Wait OFF
11		PRI T-Wait ON	PRI T-Wait OFF (initialized)
10			
09			
08			
07			
06			
05			
04		All Agents Unavailable Route: Per Prog. 14-5 (Overflow Point Destination)	All Agents Unavailable Route: Per Prog. 14-6 (After Shift Destination)
03		Agent receives Supervisor Monitor Tone/LCD display when being monitored	Agent does not receive Supervisor Monitor Tone/LCD display when being monitored
02			
01		ACD Mode: Most idle Agent receives next call	ACD Mode: Next Available Agent receives next call

Program 10-4 Overview

This program provides three system options. When enabled/disabled these options apply to all ACD Groups and Agents. ACD system options are set as follows:

LED 01: Set Next-Available-First or Most-Idle-First Routing

Sets which algorithm the system follows to route ACD calls.

Next-Available-First, Turn LED 01 OFF—The Agent list is searched sequentially, starting from (not including) the last found Agent, and ending with the first found available Agent. This method of searching is similar to the circular-distributed hunt method.

Most-Idle-First, Turn LED 01 ON—The Agent with the most idle time, since the last ACD call, receives the next call. If all Agents are busy and an Agent becomes available, that Agent automatically receives the next call, regardless of idle time. If that should happen, the Agent with the longest idle time may have to wait to receive a call. As Agents go idle, they are added to the end of the ACD Agent routing list.

Note During busy ACD call traffic conditions, the algorithm routes calls that have been waiting in the ACD Group queue directly to the first Agent telephone that becomes available.

LED 03: Supervisor Monitor Tone and Display

If Tone/LCD is enabled when a Supervisor monitors an Agent telephone, the Agent receives a short dial tone burst (every 15 seconds) and a steady LCD display: MONITOR BY SUPRV. The system also sends the monitor tone to the outside caller connected to the Agent. If Tone/LCD is not enabled, the Agent and outside caller has no indication that their call is being monitored by the Supervisor.

LED 04: ACD Group Unavailable Destination

When all Agents in a Group are in the Unavailable mode simultaneously, new incoming ACD calls that are normally routed to the ACD Group's call waiting queue is immediately diverted to either the Overflow-Queue-Point destination (set in Program 14-5) or to the End-of-Shift destination (set in Program 14-6), depending on the status of Program 10-4 LED 04 (see Flowchart 6-6 on Page 6-46).

LED 11: PRI ISDN Timer

The T-Wait timer is an ISDN timer that is required to reduce the potential for a network overload condition due to a large number of ISDN terminals requesting initialization at the same time (e.g., due to an area-wide power failure). This timer creates a random time interval and is called upon power up to set a value to delay the initialization process until the timer has expired. This timer is seldom used for PRI interfaces.

LED 12: BRI ISDN Timer

The T-Wait timer for BRI and PRI terminals works the same way. See LED 11 for a description. This timer should be used for BRI terminals and only disabled if the local provider instructs disabling this timer.

LED 13: 3.1kHz Audio

Calls received from the non-ISDN portion of the public network come in 3.1 kHz audio. A progress indicator is not always provided for these types of calls. Turning LED 13 OFF allows *all* calls to be received. Toshiba recommends keeping LED 13 OFF until some time in the future when the public network is updated to send a progress indicator with all calls.

LED 14: ISDN Start Button Access Code

When LED 14 is ON, the ISDN **Start** button access code is automatically sent when the **Speed Dial** (or **SDS**) button is pressed. The default is ON. If LED 14 is OFF, the number entry timer expires.

Program 11 – ACD Timing Assignments

Initialized Default: See table below



Code (1~9) ———— DATA = Time (min. or sec.)
 ACD Group Number ————
 Music Timer (1~3) ————
 (used only with Code 5, skip this entry for all other codes)

Processor	ACD Group Numbers
RCTUBA/BB	01-08
RCTUC/D	01-16
RCTUE/F	01-16

Code	Time	Initialized Data	Notes
1	0000~3600 sec.	0030 sec.	0000 = No Overflow
2	000~255 sec.	030 sec.	
3	000~255 sec.	060 sec.	
4	000~120 sec.	001 sec.	
5	000~999 sec.	030 sec.	
6	000~255 sec.	120 sec.	
7	000~600 sec.	240 sec.	
8	00~30 min.	01 min.	00 Disables Alarm Guard Timer; blocks Alarm Reset
9	00~60 min.	00 min.	00 Disables Timer

ACD Group Number	Code 1	Code 2	Code 3	Code 4	Code 5			Code 6	Code 7	Code 8	Code 9
	Queue Overflow Timer	Ring Agent Timer	Wrap-up Timer	RBT before Announce Timer	Connect to Music Timer			Call Waiting Alarm Timer 1	Call Waiting Alarm Timer 2	Alarm Guard Timer	Disconnect of ACD Call Timer
					1	2	3				
1											
2											
3											
4											
5											
6											
7											
8											
9											
10											
11											
12											
13											
14											
15											
16											

Program 11 Overview

The ACD timers listed below can be set individually for each ACD Group. ACD timers apply to loop, Tie, DID, DNIS, and ANI lines, not ground start lines.

Code 1: Time in ACD Queue Before Overflow

The time period (ranges from 0000~3600 seconds) a call(s) remains in an ACD queue pattern before it attempts to overflow to the destination set in Program 14-4. The queue timer can be set from 1 second to 3600 seconds (60 minutes) or to no overflow time out. If no overflow time out is set (Data = “0000”), then the call remains in queue or overflows per Program 14-5 operation settings (see Flowcharts 6-3 and 6-4 on Pages 6-43 and 6-44).

Code 2: Ring Agent Timer

The time period (ranges from 000 seconds to 4 minutes and 15 seconds) an ACD call will ring an idle Agent telephone. When the time expires and the call is unanswered, the system hunts and rings another idle Agent telephone from the same ACD Group for the same duration of time.

This process continues until all idle Agent telephones have been rung or the call is answered. If the call remains unanswered after ringing the last idle Agent, it is routed to the destination set in Program 14-5.

If the destination set in Program 14-5 is a [DN], the ACD line if idle rings the [DN]. If the [DN] is busy, the ACD line rings the idle or busy [DN] or CO **Line/Pooled Line Grp** button assigned to ring in Programs 81, 84, and 87 and flash in *81, *84, and *87. If a DID/Tie/DNIS/ANI line is used, the call camps on to the busy station set in Program *14-2 (see Flowchart 6-7 on Page 6-47).

Code 3: After Call Work Timer

Immediately after an Agent disconnects from an ACD call, the After Call Work Timer begins to count down (ranges from 000 seconds to 4 minutes, 15 seconds). The wrap-up count is updated to display the active condition on the Agent telephone LCD (the wrap-up time remaining counts down each second).

When an Agent telephone is in the After Call Work Time mode (wrap-up timer count down), the telephone does not receive ACD calls, but it can receive non-ACD or PBX calls. An Agent can cancel the wrap-up mode anytime by pressing the **End After Call Work Time** button, by making another call, or by going off and on-hook. After Call Work Time is not activated after the completion of PBX calls made from, or received on, the Agent telephone’s **ACD Call** button or [PhDN].

Code 4: Ring-Back-Tone (RBT) Timer

Defines the time that a new incoming ACD call receives ring back tone, if no Agents are idle and the caller must wait for the ACD queue announcement (ranges from 000~120 seconds) (Flowchart 6-1 on Page 6-41). This timer only applies to CO lines that are routed directly to the ACD Group (all types of CO lines).

If a CO line is transferred to an ACD Group by a station or DK AA and no Agents are idle, this timer does not apply. Calls immediately enter the ACD Group’s queue. If a caller hangs up while connected to the RBT timer, the call is considered unanswered and the Strata DK system does not send answer supervision (800-type calls are not billed in this case).

If the outside caller hangs up while the incoming call is connected to the RBT timer, the call is abandoned and is not considered as an answered call. No answer supervision is sent from the Strata DK System and “800” type calls will not be billed. Calls abandoned after the call is sent to the first announcement will be considered as answered and billed.

Code 5: Music Timers 1, 2, and 3

Defines the time interval that ACD callers in queue are sent music following the first, second, or third announcement. Range of each music timer is 000~999 seconds (about 5 seconds to 16 1/2 minutes).

The connection time tolerance when switching between music and announcements is 5 seconds; example, if a music timer is set for 00 seconds, the caller may still hear up to 5 seconds of music if a music source is installed.

- ♦ Timer 11-51 defines the music interval following the first announcement.
- ♦ Timer 11-52 defines the music interval between the second and third announcement on three-announcement queue patterns. Timer 11-52 is not used on one or two announcement queue patterns.
- ♦ Timer 11-53 defines the music interval following the second announcement on two-announcement queue patterns; or, the music interval following the third announcement on three-announcement queue patterns. Each music timer can be individually set from 000 seconds to 16 minutes, 39 seconds (see Flowcharts 6-8~6-10 on Pages 6-48~6-51).

Code 6: Call Waiting Alarm Timer 1

Defines the first alarm threshold time for the ACD calls waiting in queue (ranges from 000~255 seconds). If a defined number of ACD calls (per Program 14-72) are in queue longer than the time defined in Program 11-6, the ACD Supervisor telephone is sent a beeping alarm indication (2400 Hz/10 Hz, 0.75 second OFF, 0.75 second ON). Program 14-8 DATA must be set to “2” for the Call Waiting Alarm Timer 1 to operate.

Code 7: Call Waiting Alarm Timer 2

Defines the second alarm threshold time for ACD calls waiting in queue (ranges from 000~600 seconds). If a defined number of ACD calls (per Program 14-73) are in queue longer than the time defined in Program 11-7, the ACD Supervisor telephone is sent a beeping alarm indication (2400 Hz/10 Hz, one continuous sound). Program 14-8 DATA must be set to “2” for the Call Waiting Alarm Timer 2 to operate.

Code 8: Alarm Guard Timer

Defines the minimum time interval between queue alarm signals sent to the Supervisor telephone. The timer can be set from 01~30 minutes. If the timer is set to 00, the **Reset Queue Alarm** button does not function to end a queue alarm indication on the Supervisor telephone.

Example: If the queue alarm sounds at the Supervisor telephone and the Supervisor resets the alarm by pressing the flashing **Reset Queue Alarm** button, the Alarm Guard Timer begins to count down from the time set in this program. If the number of calls in the ACD queue still exceeds the queue size (set in Program 14-71, 72, or 73) after the Alarm Guard Timer expires, the alarm sounds again on the Supervisor telephone.

Code 9: Call Disconnect Timer

Defines the maximum time an ACD call can remain in queue (ranges from 01~60 minutes). This timer should be used when using loop start, Tie, or DID, DNIS, ANI on ACD lines. This prevents CO lines from being connected to an ACD queue for an indefinite period of time after the outside caller hangs up and the CO line does not provide the Calling Party Control (CPC or AR) disconnect signal. This timer only disconnects calls in queue; it does not disconnect calls that are answered by Agent telephones or other telephones/devices. If 00 data is entered, the disconnect feature is disabled.

The disconnect feature is always disabled for ground start CO lines (see Flowchart 6-2 on Page 6-42, later in this chapter).

Note 255 sec. is 4 minutes and 15 seconds.

Program 14-1 – ACD Agent Identification Code Assignments

Initialized Default: *blank*

* # * # 1 * 2 * 3 - Spkr 1 4 Hold - Spkr 1 [] [] [] [] Hold - Spkr # # Hold - Spkr # # Hold

SELECT = 1 _____ DATA = Agent ID Log in Code (0000-9999)
 SELECT = Agent ID Number (000-255) _____ DATA = ACD Group Number

Use the Record Sheet that follows Program 18.

Program 14-1 Overview

This program assigns Agent Identification (ID) codes to each ACD Group. To receive an ACD call from a specific ACD line group, the Agent must log in to the ACD Group by dialing the ID code (four digits) assigned in this program.

Note A telephone can be logged in as either an Agent or Supervisor telephone in any ACD Group, but it cannot be logged in as an Agent and a Supervisor simultaneously. Agents can only log in to one ACD Group at a time. See Program 14-2 for more information.

Program *14-1 – Auto Answer with Zip Tone Assigned to Agent ID

Initialized Default: Group Number = 01. Agent ID Code = blank. DATA 0 = No Auto Answer.

* # * # 1 * 2 * 3 - Spkr * 1 4 Hold - Spkr 1 [] [] [] Hold - Spkr # # Hold - Spkr # # Hold

SELECT = 1 _____

SELECT = Agent ID Number _____
(000~255)

Press # for single port entry. _____

DATA =

0 = No Auto Answer

1 = Auto Answer

Use the Record Sheet that follows Program 18.

Program *14-1 Overview

This program assigns Auto Answer to Agent telephones. When Auto Answer is enabled, the telephone generates a zip tone (one-half second burst of dial tone) into the handset and the Agent can automatically answer ACD calls.

If the Agent telephone is off-hook, the headset receiver or if on-hook, the telephone speaker receives zip tone when an ACD call is sent to the Agent. Auto Answer applies to direct and transferred ACD calls, but not to incoming PBX calls to the Agent **ACD Call** [PhDN] button.

► **To erase data**

- Press LED button 01.

Numeric Mode

0 to 9 are treated as numerals.

Note Dial pad starts out in Numeric Mode. Press # button to switch to Alpha Mode.

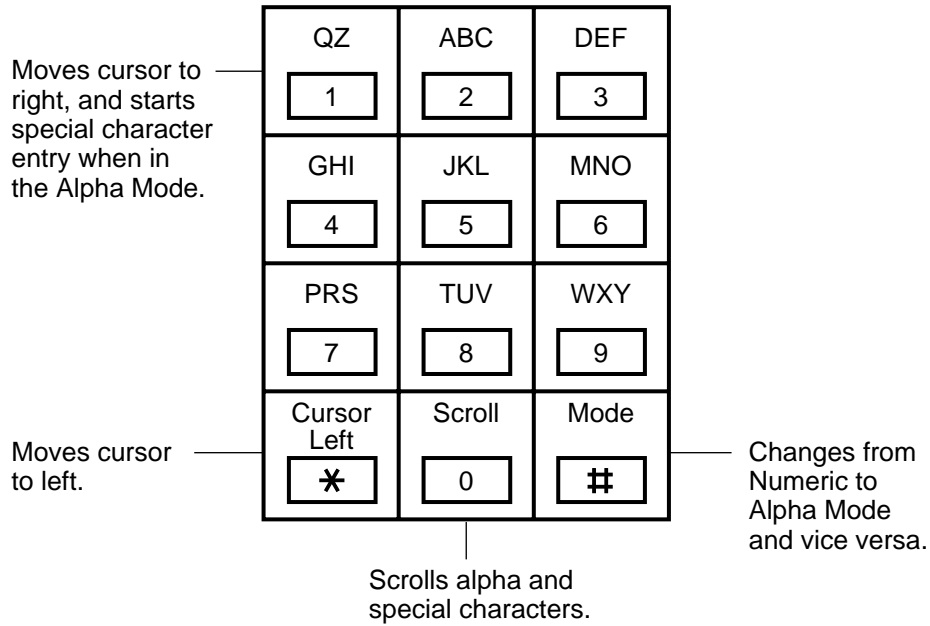

Alpha Entry (Example):

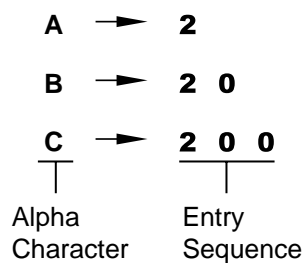

Special Character Entry:

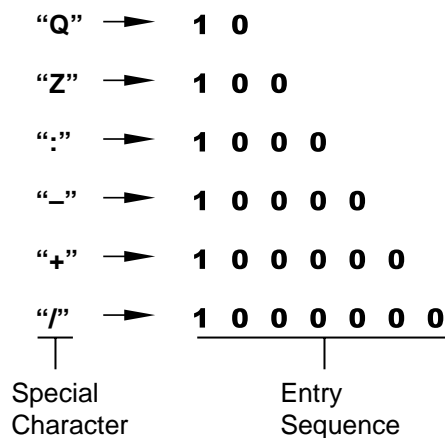

1936

Figure 6-1 Alpha Mode

Program *14-2 – DID, Tie, DNIS, ANI Line After Shift/Overflow Substitution Destinations

Initialized Default: Port 000

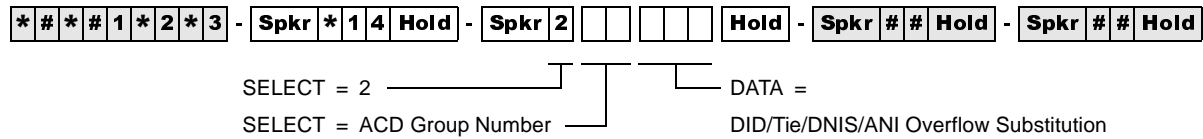

Processor	ACD Group Numbers
RCTUBA/BB	01-08
RCTUC/D	01-16
RCTUE/F	01-16

RCTUBA/BB	RCTUC/D	RCTUE/F	DID/Tie/DNIS/ANI Overflow Substitution Destination
000-079	000-239	000-335	Station or Attendant Console [PDN] Program 04 Port Number
500-579	500-739	500-835	[PhDN] Program *04 Port Number
900-915	900-915	900-915	Distributed Hunt Group Program *04 Port Number

ACD Group Number	Destination

Program *14-2 Overview

Assigns a Normal Ringing or AA substitute destination for DID and/or Tie lines.

If an ACD Group is assigned to overflow (in Program 14-4 or 14-5) or route after shift service (Program 14-6) to the DK built-in AA or to Normal Ringing assignments (code 320 or 321), these assignments only apply to loop/ground start CO line calls. DID/Tie/DNIS/ANI line calls are directed to the port assigned in this Program (*14-2).

This is because only loop and ground start CO lines (not Tie or DID lines) can be routed to DK AA and/or Normal Ringing assignments.

Notes

- If the assignments for an ACD Group: Overflow Queue Timer (Program 14-4), Overflow Queue Point (Program 14-5), and/or After Shift (Program 14-6) destinations are programmed as Normal Ringing or AA, DID/Tie/DNIS/ANI lines will be routed to the destination [DN] assigned in this program. This is because DID/Tie/DNIS/ANI lines cannot be assigned to AA or Normal CO line ringing.
- If the destination [DN] assigned in this program is busy when one of the following occurs (Ring No Answer, All Agents Unavailable, End of ACD Shift), the overflowing DID/Tie/DNIS/ANI line will camp on to the [DN]. Call Forward and/or Hunt from the destination assigned will occur if set on the destination station.
- DID, DNIS, ANI, and Tie line calls in queue do not overflow to busy ACD Groups, Intercom numbers, [PDNs], [PhDNs], or Distributed Hunt Groups; they remain in queue until the destination becomes idle.
- Call Forward No Answer will occur if set on the destination assignment. If the overflow destination is a Strata DK Attendant Console, calls will exit queue and overflow to the Attendant Console when the console is idle or busy.

Program 14-3 – Announcement/Music Port and Queue Pattern

Initialized Default: *all blanks*

* # * # 1 * 2 * 3 - Spkr 1 4 Hold - Spkr 3 [] [] [] [] Hold - Spkr # # Hold - Spkr # # Hold

SELECT = 3 ———— DATA = Port number of Music or Announcement Source
 Code (1-5) ————
 ACD Group Number ———— Enter blanks with Button/LED 01.

Processor	ACD Group Numbers	Port Numbers
RCTUBA/BB	01-08	000-079
RCTUC/D	01-16	000-239
RCTUE/F	01-16	000-335

Code 1	Enter the RSTU or RSTU2 (or equivalent) port number of the first announcement.
Code 2	Enter the RSTU or RSTU2 (or equivalent) port number of the second announcement if queue pattern has three announcements. (Enter Code 2 assignment only if there are three announcements. Skip to Code 3 if only two announcements are used for the ACD Group queue.
Code 3	Enter the second announcement port for two-announcement queue patterns or enter the third announcement port for three-announcement queue patterns.
Code 4	Enter the RSTU, RSTU2 or PEKU Music Source port number or enter 999 if the music source is a Music-on-Hold (MOH) source.
Code 5	Enter the announcement number (1~3) of the first announcement that should repeat to calls in queue.

ACD Group Number	Code 1 Announcement 1 Port	Code 2 Announcement 2 Port	Code 3 Announcement 2 or 3 Port	Code 4 Music Source Port	Code 5 Repeat Announcement Number

Program 14-3 Overview

This program is used to make announcement/music port and queue pattern assignments. All announcement devices (digital announcers) must connect to standard telephone ports (RSTU, RSTU2, RDSU/RSTS, PSTU, PESU).

The music source can be the MOH source connected to the RCTU RCA jack, another source connected to a standard telephone port or an electronic telephone port (voice pair).

Each ACD Group can have from one to three announcements and a separate music source. Announcements and/or music sources can also be shared in any combination between ACD Groups (see Flowcharts 6-8~6-10 on Pages 6-48~6-51).

Code 1: Announcement Port One

Assigns the port that will be connected to the digital announcer that should be activated first when a CO line call enters the ACD Group queue. Code 1 always assigns the first announcements in a queue pattern. Skip Code 2 and Code 3 programming if only one announcement is used for the ACD Group queue.

Code 2: Announcement Port Two

Assigns the port to which the second announcement device connects in a three-announcement queue pattern. If only two announcements are used for the ACD Group queue, skip to Code 3.

Code 3: Assigns Port for Second or Third Announcement Device

Assigns the port to which the second announcement device connects in a two-announcement queue pattern. Or, it is the port connected to the third announcement device in a three-announcement queue pattern.

Code4: ACD Queue Music Source Port

Assigns the station port or RCTU MOH jack to which the ACD queue music source is connected. The music is sent to callers in the ACD Group queue during the time intervals set in Programs 11-51, -52, and -53, or continuously until an Agent answers or the call overflows (see Non-repeating Queue Announcement following Program 14-5).

Code 5: Select Repeat Enactment for Queue Pattern

After the last music timer (11-51, -52, or -53) in the queue pattern expires, the queue pattern announcements and music can be repeated to callers starting with announcement 1, 2, or 3. Use Code 5 to select which announcement to start the repeat queue pattern process. The queue pattern is repeated until an Agent answers, the call overflows per Program 14-4, the caller hangs up, or the disconnect timer expires (Program 11-9). The queue pattern can be set to repeat or not repeat announcements, depending on the options set in Program 14-5 (see Flowcharts 6-8~6-10 on Pages 6-48~6-51).

Queue Pattern Options 1, 2, and 3 are shown in the following diagram. For more details, see Flowcharts 6-8~6-10 on Pages 6-48~6-51.

Automatic Call Distribution

Program 14-3 – Announcement/Music Port and Queue Pattern

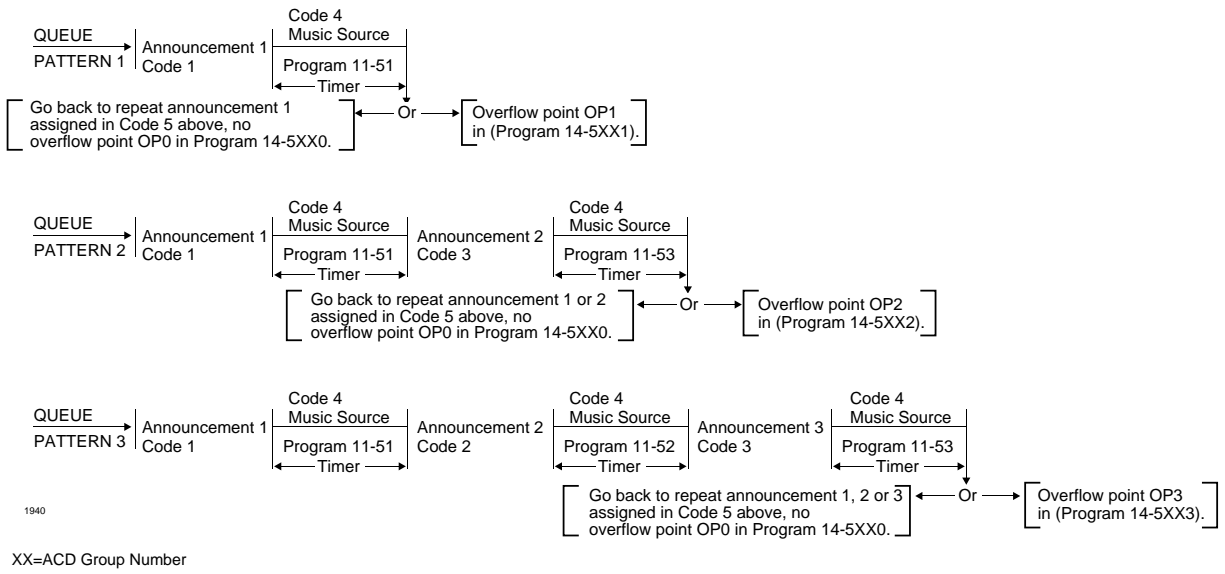

Figure 6-2 ACD Queue Announcement and Music Patterns

Program 14-4 – Queue Time Out Overflow Destination

Initialized Default: Port 000

* # * # 1 * 2 * 3 - Spkr 1 4 Hold - Spkr 4 [] [] Hold - Spkr # # Hold - Spkr # # Hold

SELECT = 4
 SELECT = ACD Group Number
 DATA = Queue Timeout Overflow Destination

Processor	ACD Group Numbers	[PDN] Port Range	[PhDN] Port Range
RCTUBA/BB	01~08	000~079	500~079
RCTUC/D	01~16	000~239	500~739
RCTUE/F	01~16	000~335	500~835

DATA	Queue Timeout Overflow Destination
See [PDN] Port Range	Station or Attendant Console (See [PDN] Port Range)
301~316	ACD Group (RCTUBA/BB, RCTUC/D)
401~416	ACD Group (RCTUE/F)
320 (RCTUBA/ RCTUBB, RCTUC/D) 420 (RCTUE/F)	Auto Attendant (DK Built-in)
321 (RCTUBA/ RCTUBB, RCTUC/D) 421 (RCTUE/F)	Normal CO line; Ring assignments not including delayed ringing assignments
See [PhDN] Port Range	[PhDN] Program *04 Port Number
900~915	Distributed Hunt Group Program *04 Port Number

ACD Group Number	Overall Queue Time Out Destination

Program 14-4 Overview

This program sets the overflow point destination for CO line calls that are in an ACD queue for longer than the queue time set in Program 11-1. Calls only overflow when the overflow destination is idle or when it becomes idle if the overflow destination is a [PDN], [PhDN], Distributed Hunt [DH] Group, port or another ACD Group (see Flowchart 6-3 on Page 6-43).

If the overflow destination is an ACD Group or a station port [DN] and it is busy, the call remains in queue.

Automatic Call Distribution

Program 14-4 – Queue Time Out Overflow Destination

If the overflow destination is to a Normal Ring assignment (Programs 81~89 and *81, *84, and *87), Attendant Console or the built-in AA, calls will exit queue and overflow if the destination is idle or busy. This assignment is not necessary if the overflow queue timer is set to infinity (infinity = 0000 in Program 11-1).

Only ground and loop start ACD calls will overflow to the Strata DK AA or Normal Ringing. DID, DNIS, and Tie lines will overflow to the assignment set in Program *14-2 if codes 320, 321, 440 or 441 is set in this program.

If the overflow destination is busy when overflow time occurs, the following options are available:

- ♦ If the call(s) should exit the ACD queue and mute ring the busy overflow station, assign Code 321 (normal ringing) in Program 14-4 and assign the ACD lines to ring the overflow station [DN] in Programs 81, 84, 87, *81, *84, and *87.

Note Delay ring assignments do not apply to Program 14-4 for delay ring.

- ♦ If the overflow destination is the DK Built-in AA or an Attendant Console, calls will always exit queue when the overflow timer expires (Program 11-1) – even if the AA or Attendant Console is busy.
- ♦ If the call(s) should remain in queue until the busy overflow station or [DN] becomes idle, assign the overflow destination [DN] or another ACD Group in Program 14-4 as the overflow point.
- ♦ If the overflow destination is a busy Distributed Hunt Group, the ACD call will not exit the ACD queue and enter the Distributed Hunt Group queue.
- ♦ If it is required to route “Queue Time Out” overflow calls to a Voice Mail box (see the Program 14-6 record sheet).

Program 14-5 – Overflow Point and Ring No Answer Routing Destination

Initialized Default: *Overflow point=0, no overflow point*

* # * # 1 * 2 * 3 - Spkr 1 4 Hold - Spkr 5 [] [] [] [] Hold - Spkr # # Hold - Spkr # # Hold

SELECT = 5 _____ DATA = Destination
 SELECT = ACD Group Number _____ SELECT = Overflow Point (1~3)
 = Queue Timer (0)

Processor	ACD Group Numbers	[PDN] Port Range	[PhDN] Port Range
RCTUBA/BB	01-08	000-079	500-079
RCTUC/D	01-16	000-239	500-739
RCTUE/F	01-16	000-335	500-835

DATA	Destination
OP0, OP1, OP2, OP3	Overflow Point (OP) Destination (Incoming Port 000). Only one OP can be programmed. For No Overflow, select DATA=0.
See [PDN] Port Range	Station or Attendant Console [PDN] Program 04 Port Number
301-316	ACD Group (RCTUBA/BB, RCTUC/D)
401-416	ACD Group (RCTUE/F)
320 (RCTUBA/BB, C/D) 420 (RCTUE/F)	Auto Attendant (DK Built-in)
321 (RCTUBA/BB, C/D) 421 (RCTUE/F)	Normal CO line; Ring assignments not including delayed ringing assignments
See [PhDN] Port Range	[PhDN] Program *04 Port Number
900-915	Distributed Hunt Group Program *04 Port Number

ACD Group Number	Overflow Point	RNA and Overflow Point Destination

ACD Group Number	Overflow Point	RNA and Overflow Point Destination

Program 14-5 Overview

There are two basic options for call overflow:

Overflow Point: Calls in queue can overflow when they reach a particular point in the queue pattern (after the first, second, or third music timer expires). DATA = 1, 2, or 3 sets the music timer overflow point.

Queue Timer Expiration: Calls can cycle in the queue pattern and the same announcement(s) and music repeats until the overall queue timer expires (no overflow point). DATA = 0 selects the queue timer expiration. (See Program 14-3, Code 5, also see Flowcharts 6-2 and 6-8 on Pages 6-42 and 6-48).

Automatic Call Distribution

Program 14-5 – Overflow Point and Ring No Answer Routing Destination

Calls in queue can overflow when they reach a particular point in the queue pattern (after the first, second, or third music timer expires) or calls can cycle in the queue pattern and the same announcement(s) and music are repeatedly sent to the destination set in Program 14-4 until the overall queue timer expires (see diagram later in this section). For further details, see Program 14-3, Code 5 or Flowcharts 6-4 and 6-8 on Pages 6-44 and 6-48.

- ♦ If all Agents are Unavailable and the LED 04 is turned ON in Program 10-4, calls route to the destination set in Program 14-5.
- ♦ If the overflow station(s) or [DNs] are busy when overflow time occurs, the following options are available:
 - ♦ If the call(s) should exit the ACD queue and mute ring the busy overflow station, assign Code 321 (normal ringing) in Program 14-5 and assign the ACD lines to ring the overflow station [DN] in Programs 81, 84, 87, *81,*84, and *87. Delay Ring assignments do not apply to Program 14-5 for delay ring.
 - ♦ If the overflow destination is the Strata DK System built-in AA or Attendant Console, calls will always exit queue when the overflow point is reached – even if the AA or Attendant Console is busy.
 - ♦ If the call(s) should remain in queue until the busy overflow destination becomes idle assign the overflow destination as a [DN] (000~239 or 500~739, except Attendant Console ports) or ACD Group (01~16) in Program 14-5.

If the Program 14-5 overflow destination is a DH Group, calls will not exit the ACD queue and enter the busy DH Group queue.

Only ground and loop start ACD calls overflow to the DK AA or normal ringing. DID, DNIS, ANI and Tie lines will overflow to the assignment set in Program *14-2 if code 320 or 321 is set in this program.

If announcements should not be repeated, see Flowcharts 6-8~6-10 on Pages 6-48~6-51 and “Non-Repeating Queue Announcement” explanation under Program 14-5.

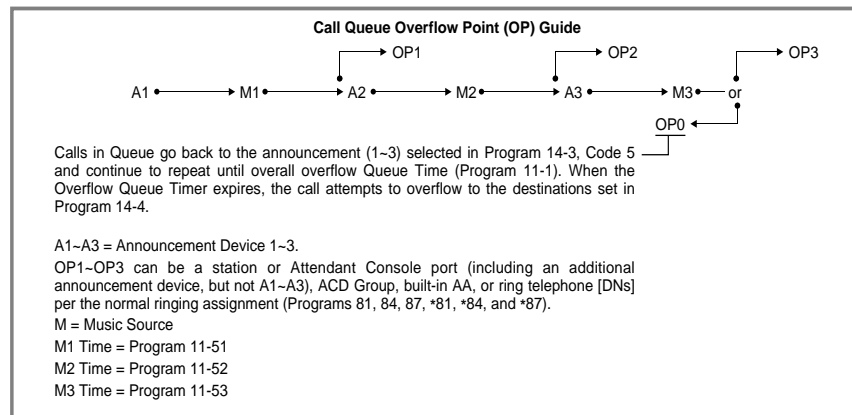

Notes

- ♦ Unanswered ACD calls to Agent telephones will be routed to the destination assigned in Program 14-5.
- ♦ If it is desired to route Overflow Point/RNA calls to a Voice Mail box, see Program 14-6 record sheet for instructions.

- ♦ If no overflow point is selected (DATA = 0) and the queue overflow time is set to infinity (Program 11-1), calls do not overflow.
- ♦ If the overflow operation is at overflow points 1, 2, or 3, assign the overflow destination in this program.
- ♦ If the overflow occurs after the queue timer expires, assign the overflow destination in Program 14-4.
- ♦ If all Agents are in the Unavailable mode, CO calls to the ACD Group can be routed to the assigned overflow destination in this program as an option (see Program 10-4 LED 04).

ACD calls that ring Agent telephones and are not answered route to the destination set in Program 14-5 (see Flowchart 6-7).

Overflow Operation

If the Program 14-5 overflow destination is a station [PDN], [PhDN], another ACD Group, or a Distributed Hunt Group and it is busy when a call overflow point is reached, the call remains in queue until the overflow point destination becomes idle. (See Flowcharts 6-2, 6-3 and 6-4.)

When the overall queue timer expires, the call also attempts to overflow to the destination set in Program 14-4. The call is sent to an idle Agent or to the overflow point set in Programs 14-4 or 14-5, whichever becomes idle first.

If the overflow destination is the Normal Ring assignment (Programs 81, 84, and 89), the DK Attendant Console, or AA, overflow occurs even if the destination is busy. See Flowchart 6-4 on Page 6-44.)

If the overflow destination is the DK AA or Normal Ringing assignments, DID/Tie/DNIS/ANI line calls overflow to Program *14-2 assignment only when the destination is idle.)

Non-Repeating Queue Announcement

Case 1—Provide callers with one announcement, followed by music until the call is answered by an Agent or until the call overflows — refer to Flowchart 6-8 on Page 6-48. (Overflow time is determined by the overall queue timer; Program 11-1, one second to one hour or no overflow.)

- ♦ Assign Announcement 1 to the appropriate digital announcer standard telephone port (Program 14-31).
- ♦ Assign Announcements 2 and 3 to any vacant PDKU or PEKU port. (Program 14-32 and 14-33 , DATA = XXX vacant port. See Notes.)
- ♦ Assign music in Program 14-34.
- ♦ See Notes, following Case 2.

Case 2—Provide the following sequence to callers: Announcement 1, followed by Music 1, Announcement 2, and then continuous music until the call is answered by an Agent or until the call overflows — refer to Flowchart 6-10 on Page 6-51. (Overflow time is determined by the overall queue timer; Program 11-1, one second to one hour or no overflow.)

- ♦ Assigns Announcements 1 and 2 to the appropriate digital announcer, standard telephone port (Programs 14-31 and 14-32).

Automatic Call Distribution

Program 14-5 – Overflow Point and Ring No Answer Routing Destination

- ♦ Assign Announcement 3 to any vacant PDKU or PEKU port (Program 14-33). XX = ACD Group number, DATA = Vacant Port Number ZZZ.
- ♦ Assign music in Program 14-34.

Notes

In both Cases 1 and 2 above:

- ♦ The vacant port is a digital or electronic telephone port. It must not be connected to a telephone when assigned as an announcement port in Program 14-3. A station PCB does not have to be installed for the vacant announcement port.
- ♦ Set overflow point to “0” and the destination to the desired Ring No Answer port XXX (Program 14-5XX-0-XXX).
- ♦ Set overall queue overflow time (Program 11-1) and the overall queue overflow destination (Program 14-4XX-YYY) as appropriate for overflow or no-overflow.

Program 14-6 – After Shift Service Destination

Initialized Default: Destination = Incoming port 000

* # * # 1 * 2 * 3 - Spkr 1 4 Hold - Spkr 6 [] [] [] Hold - Spkr # # Hold - Spkr # # Hold

SELECT = 6 ———— DATA = Destination
SELECT = ACD Group Number

Processor	ACD Group Numbers	[PDN] Port Range	[PhDN] Port Range
RCTUBA/BB	01-08	000-079	500-079
RCTUC/D	01-16	000-239	500-739
RCTUE/F	01-16	000-335	500-835

DATA	Destination
See [PDN] Port Range	Station or Attendant Console [PDN] Program 04 Port Number
301-316	ACD Group (RCTUBA/BB, RCTUC/D)
401-416	ACD Group (RCTUE/F)
320 (RCTUBA/BB, C/D) 420 (RCTUE/F)	Auto Attendant (DK Built-in)
321 (RCTUBA/BB, C/D) 421 (RCTUE/F)	Normal CO line; Ring assignments not including delayed ringing assignments
See [PhDN] Port Range	[PhDN] Program *04 Port Number
900-915	Distributed Hunt Group Program *04 Port Number

ACD Group Numbers	After Shift Destination

Automatic Call Distribution

Program 14-6 Overview

This program assigns the destination for ACD calls, or calls transferred to an ACD group, that come in after the ACD shift has ended.

After Shift begins when the Supervisor presses the **End of ACD Shift** button or when the last Agent logs off (see Flowchart 6-5 on Page 6-45).

If a station port is assigned, only one call at a time is serviced by the End of ACD Shift telephone or answering device (lowest CO line first if calls are waiting). Waiting calls camp on and receive ring-back tone.

If all Agents are in the Unavailable mode, calls to the ACD Group can be routed to the After Shift destination, set in Program 14-6, or to the queue overflow point destination set in Program 14-5 (see Program 10-4, LED 04).

If the End of ACD Shift destination is the Normal Ring assignment (Program 81~89), loop and ground start lines mute ring busy stations and DID/Tie/DNIS/ANI lines camp on to busy End of ACD Shift stations assigned in Program *14-2.

If the End of ACD Shift destination is another ACD Group, calls are directed to the Group as if they were new ACD calls to the Group.

► To Program ACD loop and/or ground start CO lines to night ring over external page

A PIOU, PEPU, or PIOUS is required.

1. Assign normal ringing (321 or 441) in Program 14-6.
2. Assign ACD lines to night ring over external page in Program 78-13.
3. Assign **Night Transfer** button to appropriate telephone(s) in Program 39.
4. Assign Night Relay operation in Program 77-1, LED 06.

If the destination port assigned in this program is busy when After Shift (or all Agents log out) is set, DID and Tie lines will camp on to the port while ground and loop start lines will busy override (mute) ring the port. If the destination station has Call Forward or Hunt set, these features will operate.

Notes

- DID, DNIS, ANI, and Tie lines cannot be directed to the Strata DK System AA or Normal ring assignments (321) if code 320, 321, 440, or 441 is assigned in Program 14-6. DID, DNIS, ANI and Tie line calls will be routed to the destination assigned in Program *14-2.
- Assign all Groups (even if not used) to a destination. This is in case a transferred call is sent to an unused ACD Group, the call will be sent to the destination assigned in Program 14-6.
- If it is required to route calls to a Voice Mail box during the After Shift mode, you may designate a Group announcement (A1~A3) port as the After Shift destination – temporarily use a standard telephone to Call Forward All Calls from the announcement port to the Voice Mail device and set the VMID code of the announcement port (#656 digits) to the desired After Shift Mailbox.
- During normal operation, the announcement port will play messages to callers in queue; during the After Shift mode, calls will forward from the announcement port to the After Shift Voice Mail box. This operation is also allowed for Programs 14-4 and 14-5 assignments.

Program 14-72 – Queue Size for Alarm 1

Initialized Default: Queue Size = 010



SELECT = 72 ————
 SELECT = ACD Group No. ————
 DATA = Queue Size

Processor	ACD Group Numbers	Queue Size
RCTUBA/BB	01~08	001~048
RCTUC/D	01~16	001~144
RCTUE/F	01~16	001~200

ACD Group Number	Queue Size

Program 14-72 Overview

The system causes the Supervisor **Reset Queue Alarm** button to flash and the Supervisor telephone to sound a one second ON, one second OFF beeping alarm when the number of calls in the ACD queue exceeds the number of calls set in this program for a time duration set in Program 11-6.

Program 14-8 DATA must be set to “2” if using this option (see Program 11-6 and Program 14-8 for more information).

Program 14-9 – Work Unit Assignments

Initialized Default: *account digits for each Group = 02*



Processor	ACD Group Numbers
RCTUBA/BB	01~08
RCTUC/D	01~16
RCTUE/F	01~16

ACD Group Number	Number of Work Unit Digits

Program 14-9 Overview

This program selects the length of the Work Unit code for each ACD Group.

Agents talking on an ACD call can press the **Work Unit** button and enter a Work Unit code (1~15 digits) for each call. The outside caller cannot hear the code, so conversation is not interrupted.

SMIS only records (Peg) one or two digit Work Unit codes. SMDR can record 1~15 digit Work Unit codes. If multiple work unit codes are entered on the same ACD call, only the last code entered will be sent to SMDR; however, SMIS will register all Work Unit codes entered.

The Strata DK SMDR data will send up to 15 Work Unit digits in the Account Code data field of the standard DK SMDR output. MIS (TTY) data will send only 1- or 2-digit Work Unit codes.

When the **Work Unit** button is pressed on the Agent telephone, the LCD shows “ENTER STRK DIAL”. The Agent must enter the number of digits assigned in this program to allow a work unit peg to be sent to SMIS. Any number of digits entered (even if less than assigned in this program) will be sent to SMDR when the ACD call is ended.

Program 15 – Ground/Loop/Tie/DID Line Options

If loop start lines are routed to ACD Groups, set each line to automatically release when the CO sends the AR signal after the outside party hangs up. Use Program 15 Code 1 and Code 3 to set auto release detection for each CO line.

See 3-44 for the programming record sheet.

Program 17 – DID/Tie Line Options

If DID/Tie lines must be routed to ACD Groups, use Program 17 to set the appropriate options for each DID/Tie line.

See 3-50 for the programming record sheet.

Program 35 – Station Class of Service

To allow Agent Help (assistance) calls to busy Supervisor telephones, enable Busy-Station-Transfer (LED 20-ON) on Agent telephones and Busy-Station-Ring (LED 19-ON) on Supervisor telephones. Supervisor telephones should have more than one [PDN] (Program 39) to receive Agent Help calls when the Supervisor telephone is busy.

See 3-97 for the programming record sheets.

Program 71 – DID/Tie/DNIS/ANI Lines

If DID/Tie/DNIS/ANI lines route to ACD Groups and provide DNIS line features (such as the DNIS name, night/day routing, etc.), use Program 71 to assign the DID/Tie/DNIS digits or ANI lines to route the appropriate ACD Group (see Program 17, LED 05).

Also see “Program 17 – DID/Tie Line Options” on Page 3-50.

Program 39 – Flexible Button Assignments for ACD Telephones

Initialized Default: Logical port number = physical port number
 Program 90, 91-1, or 91-9 initializes Program 02



SELECT = Port Number or Range.
 To add a port range, enter XXX*XXX (low port * high port)
 Press Button/LED to be defined.
 CODE =
 Enter the appropriate feature code. See the Feature Code Table below.

Processor	[PDN] Port Range	[PhDN] Port Range
RCTUBA/BB	000-079	500-079
RCTUC/D	000-239	500-739
RCTUE/F	000-255	500-835

Toshiba highly recommends that you enter the button keystrip names exactly as shown in the left column, since these button names are used in the ACD Agent and Supervisor Guides.

ACD Feature Button Designation	Feature Code	Program on Agent Telephone	Program on Supervisor Telephone	Notes
Log In/ Log Out (Agent)	451	X		Used by Agents to Log In/Out. [PhDN] + Log In/Out + ZZZZ (ZZZZ = Agent ID code)
Log in/ Log Out (Supervisor)	451		X	Used by Supervisor to Log In/Out Log In/Out + YYYY (YYYY = Agent ID code)
ACD Call	Program [PhDN] in Program 39	X		Each Agent telephone must have a unique, single-appearing [PhDN] button to receive and originate ACD calls. When the Agent logs into an ACD Group from any single-appearing [PhDN], that [PhDN] is the active ACD Button on the Agent telephone. (Supervisor telephones do not require a unique [PhDN] button unless the Supervisor telephone will be used as an Agent telephone periodically.)
Work Unit	444	X		Enables the Agent to peg an ACD call with an account number that will be sent to a SMIS personal computer and/or SMDR device.
ACD Pickup	446	X	X	Provides ACD call pickup within the Group. The Agent must be logged into the same Group in order to pick up the ACD call. The Pickup call is considered an ACD call on the MIS status report.
Unavailable	452	X		Turns the Agent's availability off and on. While in this mode, the Agent does not receive any new incoming ACD calls.

Automatic Call Distribution

Program 39 – Flexible Button Assignments for ACD Telephones

ACD Feature Button Designation	Feature Code	Program on Agent Telephone	Program on Supervisor Telephone	Notes
ACD Help	449	X		Rings a Supervisor [DN] button, enabling an Agent to request assistance while talking on an ACD call. Calls the highest numbered Supervisor telephone or [PDN]
End After Call Work Time	445	X		Manually cancels unused wrap-up time. This enables an Agent to receive another ACD call.
End Of ACD Shift	443		X	Enables the Supervisor to stop new calls from entering the ACD Group queue or from ringing Agents. The End of ACD Shift mode routes new calls to the After Shift destination set in Program 14-6. A Supervisor must be logged in to use this button.
Transfer to ACD Group	Conf/Trn + #406XX	X	X	<p>Program this Speed Dial sequence on telephones that must transfer calls to ACD Groups. This enables one-touch transfer of CO lines (ground/loop start or DID/Tie) to ACD Group XX. XX = ACD Group 01-16.</p> <p>Transfer to an ACD Group is always blind and immediate and does not recall the transferring station.</p> <p>If the ACD Group shift is ended or all Agents are unavailable, the transferred call is routed per the called Group's After Shift or All Agents Unavailable destination.</p>
Monitor ACD Call	447		X	<p>Used by Supervisor to monitor Agent calls (Supervisor telephone only). Enables the Supervisor to listen to any Agent's ACD calls (not non-ACD or PBX calls) by pressing the Monitor ACD Call button and then entering the Agent's ID code.</p> <p>During Agent monitoring, a one-way talk path enables the Supervisor to listen to the Agent/outside party conversation without the Agent/caller hearing the Supervisor.</p> <p>An optional "Call Monitor" tone (dial tone burst) can be sent to the Agent/caller every 15 seconds (see Program 10-4, LED 03) while the Supervisor is monitoring the ACD call. The Agent LCD displays MONITOR BY SUPRV when this option is enabled.</p>
Queue Status	[PDN] + #404XX		X	<p>Program these speed dial buttons on the Supervisor's telephone to enable quick access to Queue Status, Agent Status, and one-touch Supervisor log in.</p> <p>(XX = ACD Group 01-16)</p>
Agent Status	[PDN] + #405XX		X	
Reset Queue Alarm	448		X	Used to reset a queue alarm that is sent to the Supervisor telephone when the number of calls in queue exceeds the limits of queue alarm parameters (see Programs 14-71-73, 14-8, 11-6, and 11-7 for queue alarm parameters).

ACD Feature Button Designation	Feature Code	Program on Agent Telephone	Program on Supervisor Telephone	Notes
Supervisor Call	Program [PDN] in Program 39		X	<p>This is the [PDN] of the Supervisor telephone. Supervisor telephones do not require a unique [PhDN] like Agent telephones.</p> <p>Toshiba recommends programming more than one [PDN] onto Supervisor telephones to enable Agent Help (assistance) calls to ring busy Supervisor telephones.</p> <p>Also program Agents with Busy Station Transfer and Supervisors with Busy Station Ring (see Program 35 BST and BSR).</p>

Speed Dial Codes	Speed Dial Code	Program on Agent Telephone	Program on Supervisor Telephone	Notes
RCTUBA/BB, C/D (station)	* 10~* 49	X	X	All of the above ACD Features can be programmed onto SD buttons or onto speed dial codes. This table shows the range of Station and System Speed Dial Codes by processor.
RCTUBA/BB, C/D (system)	* 600~* 699	X	X	
RCTUE/F (station)	* 100~* 139	X	X	
RCTUE/F (system)	* 200~* 999	X	X	

Program 39 Overview

This program assigns ACD Agent and Supervisor buttons for Toshiba digital and/or electronic telephones. All other button codes (see Program 39 Record Sheet in Chapter 10—Record Sheets in this manual) are allowed on Agent and Supervisor telephones. Telephones can be programmed with both Agent and Supervisor buttons to enable dual functions, however, a telephone cannot function as a Supervisor and Agent station simultaneously.

If both Agent and Supervisor buttons are assigned to a telephone, the type of log in code (Agent or Supervisor) determines how the telephone will function (see Program 14-1 and 14-2).

Agent and Supervisor Telephone Programming Considerations

ACD Agent telephones must be programmed with a [PhDN] button (called the **ACD Call** button) to receive ACD calls. This button must be a unique [PhDN] that appears only on that Agent telephone.

The **ACD Call** button is used to originate and receive PBX calls that register on SMIS when the Agent is logged into an ACD Group with the **ACD Call** button. PBX calls are calls that originate from or ring the Agent **ACD Call** button when the **ACD Call** button [PhDN] is dialed or when a CO line is programmed to ring the **ACD Call** button [PhDN].

If the Agent's telephone is not logged into an ACD Group, calls originated or received by the **ACD Call** button are considered non-ACD calls.

Do not program ACD CO **Line** or **Pooled Line Grp** buttons on Agent telephones. Supervisor telephones do not require an ACD [PhDN].

If the ACD call is placed on hold while the Supervisor is monitoring it, there is only silence until the Agent takes the call off-hold and monitoring resumes. The Supervisor telephone is busy to new calls when in the Monitor mode. (Busy Override, Off-hook Call Announce, and Camp-on are available to callers that call a Supervisor in the Monitor or Verify Status mode.)

Important! *The Monitor mode is automatically cancelled if an Agent transfers an ACD call.*

Related Programs

- ♦ Programs ground/loop start CO line ringing assignments (Programs 81~89) for use with Overflow/After Shift destinations in Programs 14-4, 14-5, and 14-6.
- ♦ Programs CO line Group assignments (Program 16) for lines that are assigned to an ACD Group in Program 14-0.

Flowchart 6-1 ACD Group Call Routing

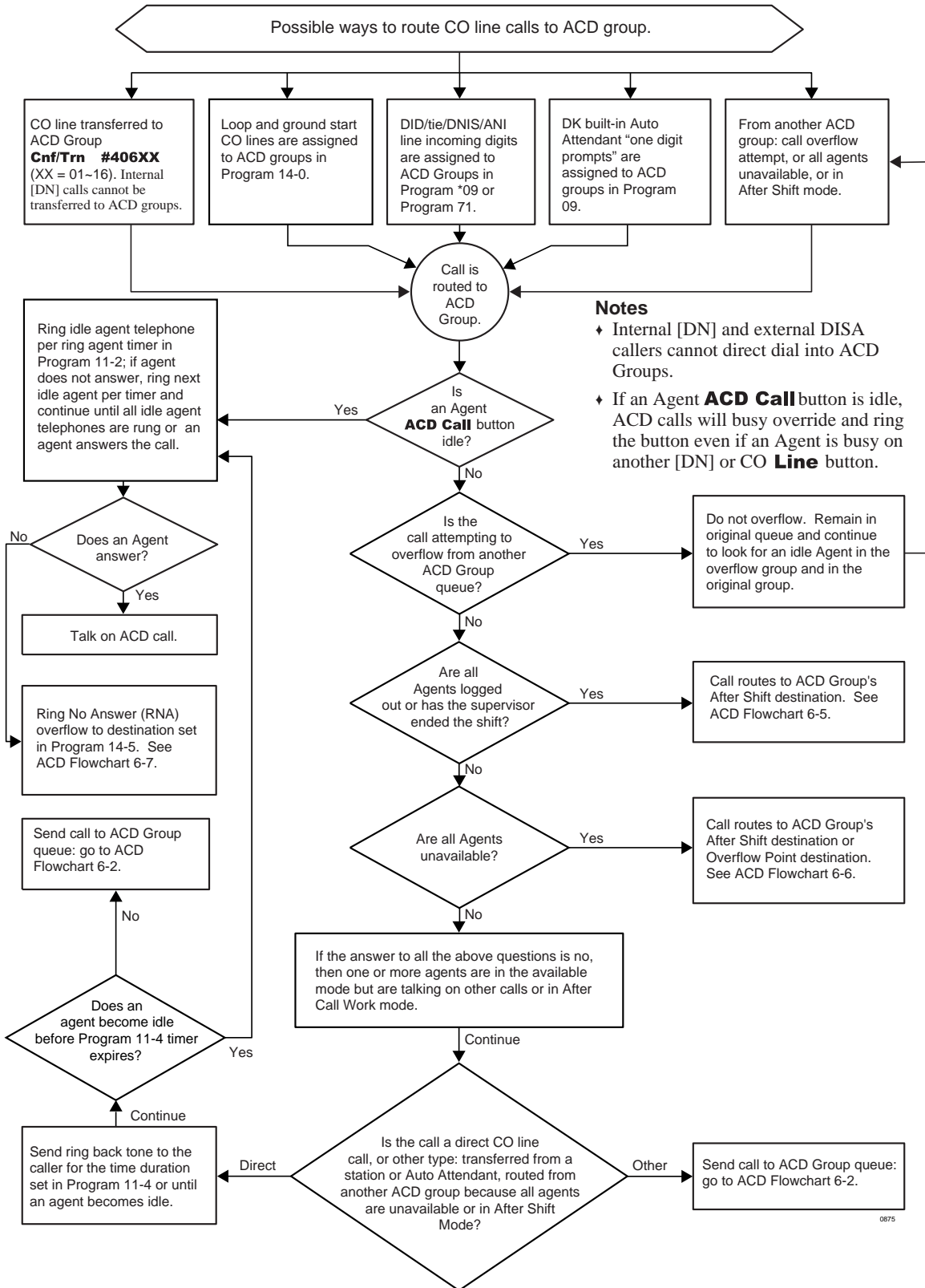

Flowchart 6-2 ACD Group Queue/Overflow Operation

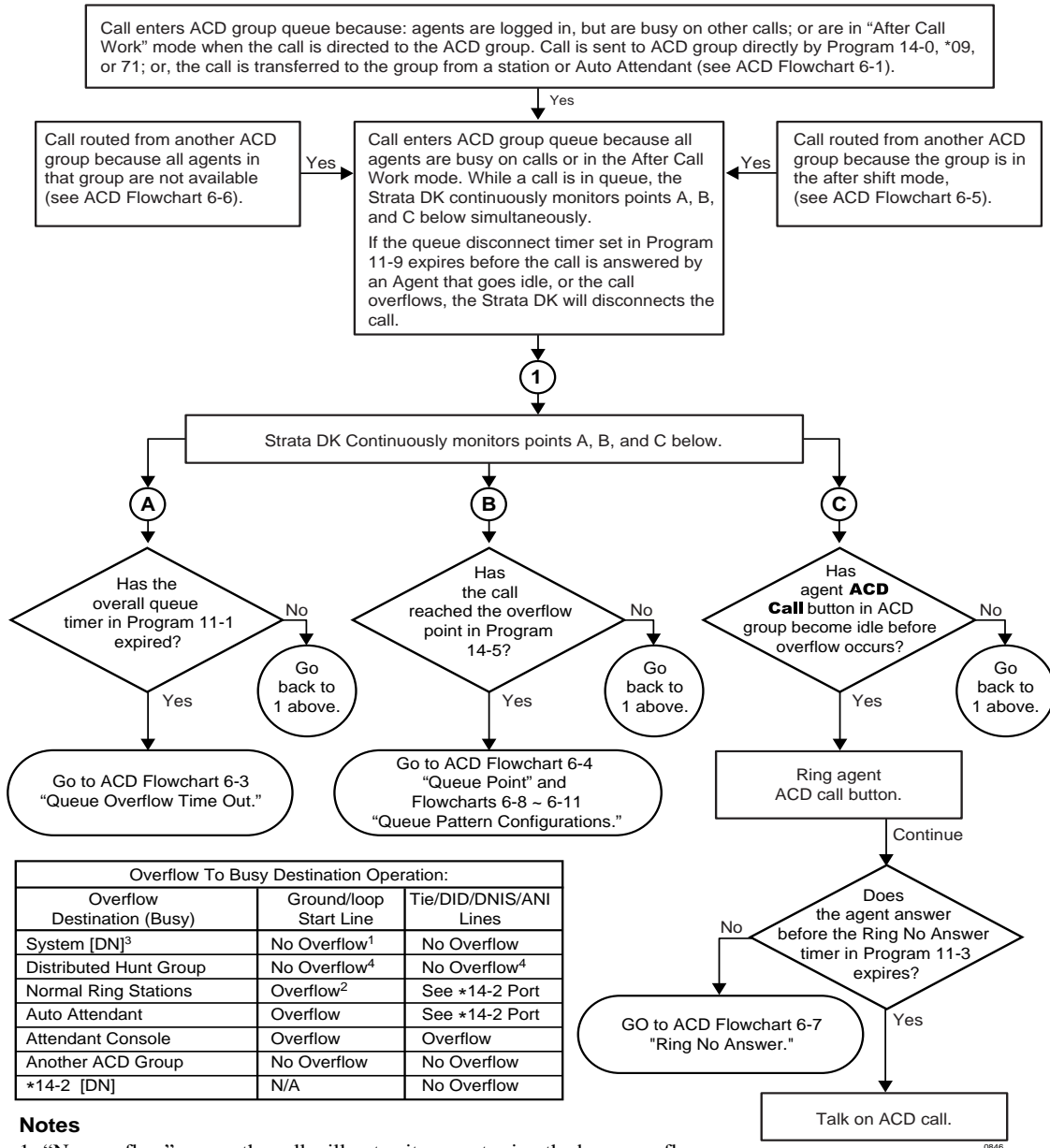

Flowchart 6-3 ACD Time Out Overflow

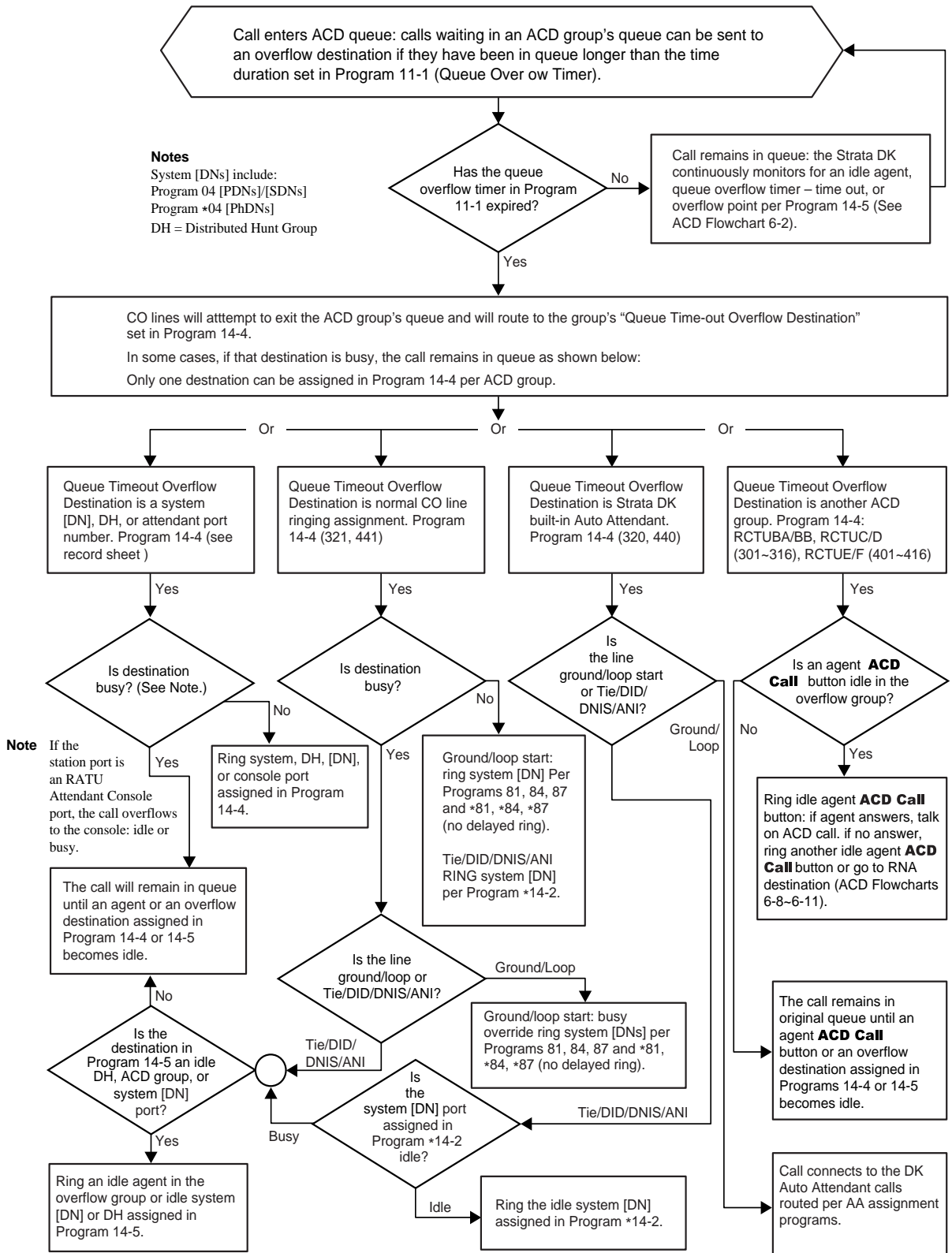

Flowchart 6-4 ACD Overflow Point

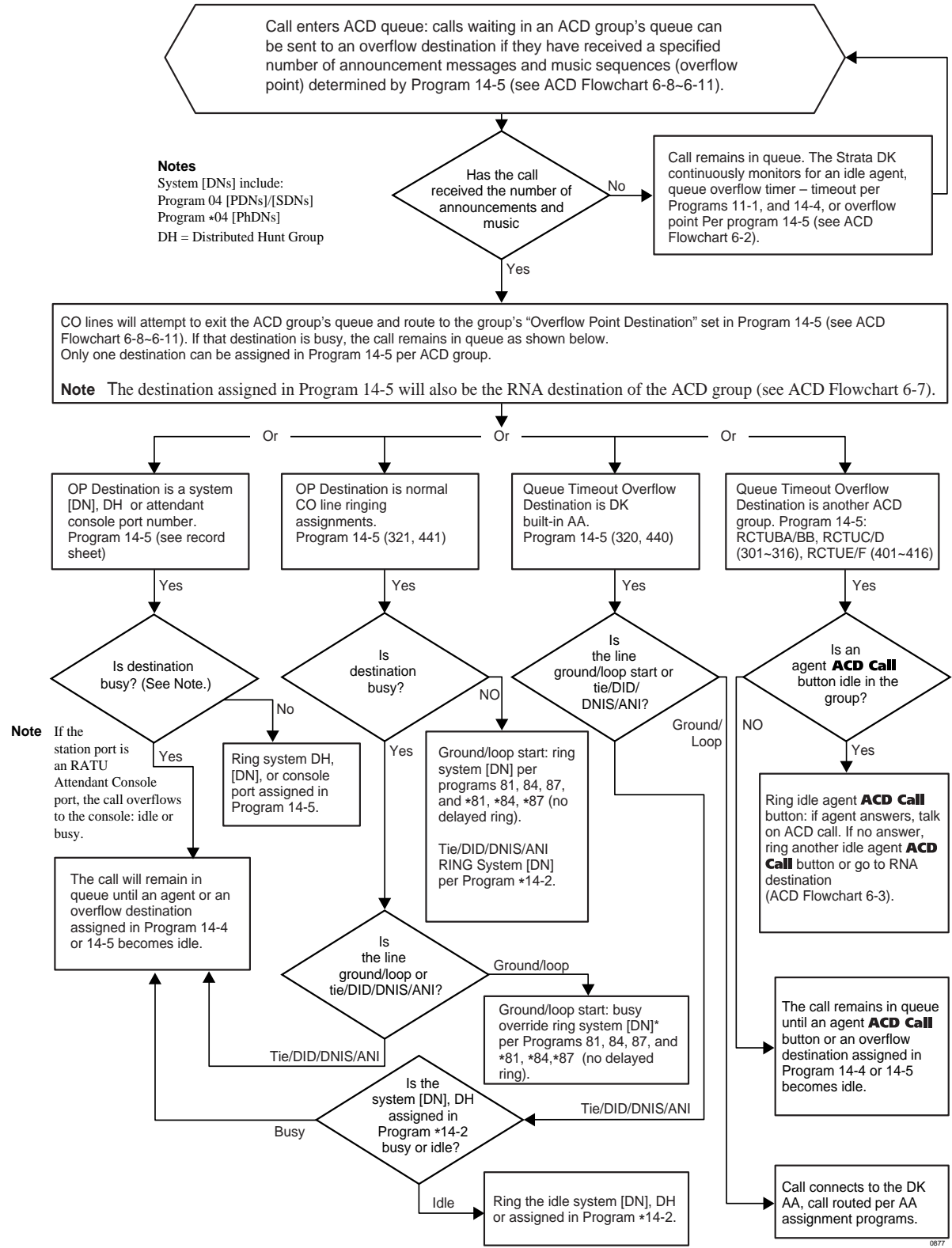

Flowchart 6-5 After Shift Operation

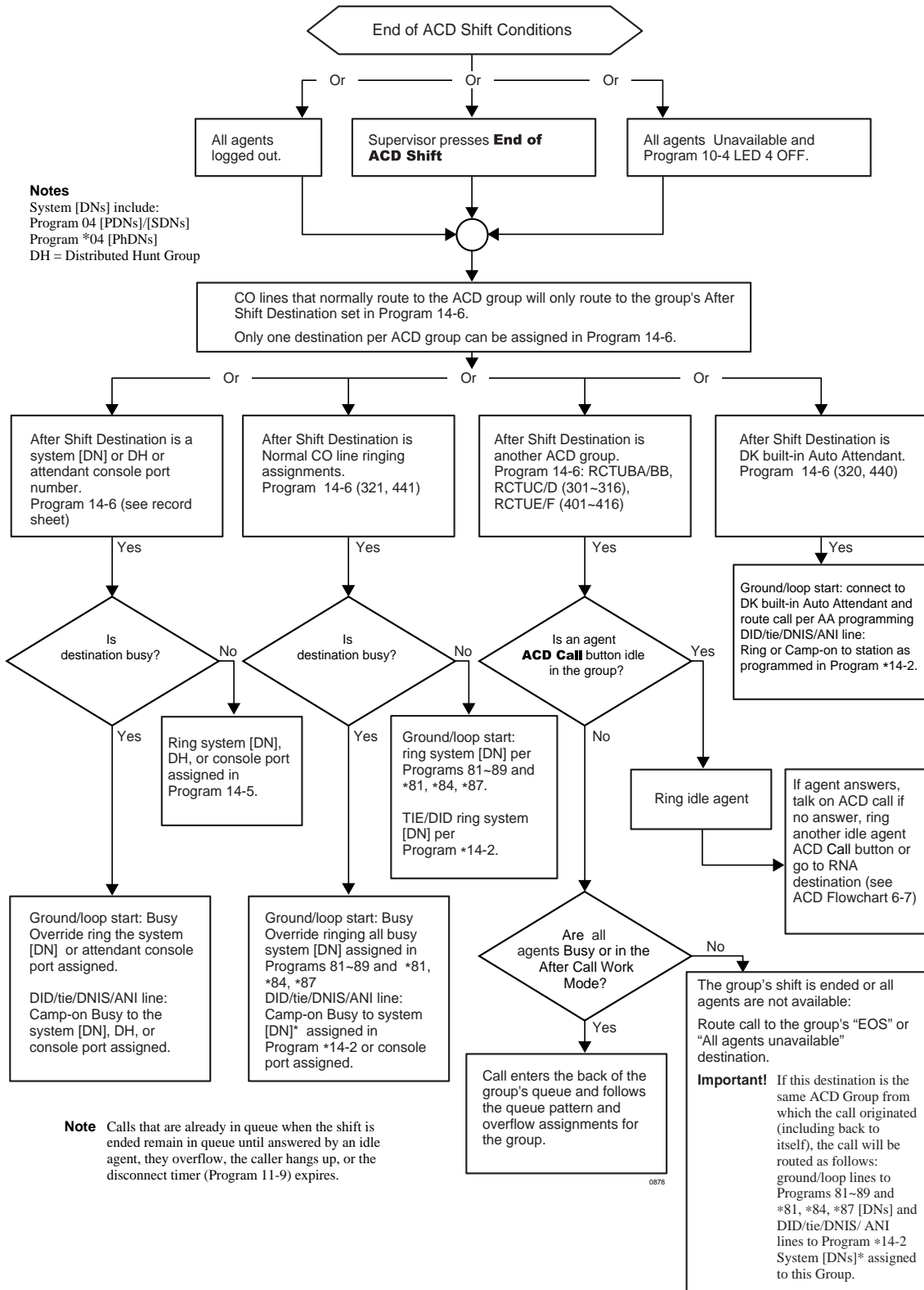

Flowchart 6-6 All Agents Unavailable Operation

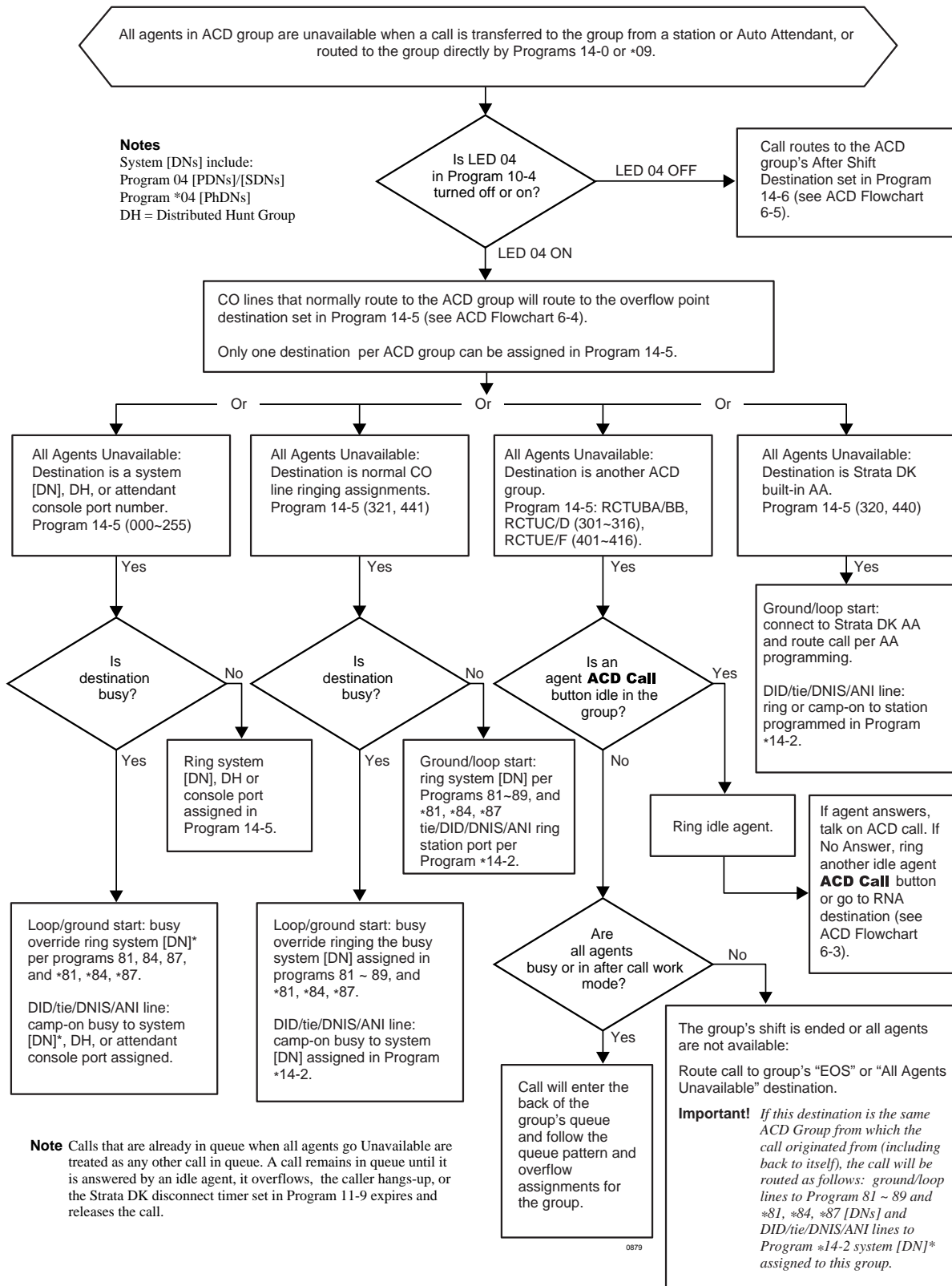

Flowchart 6-7 Agent Telephone Ring No Answer Operation

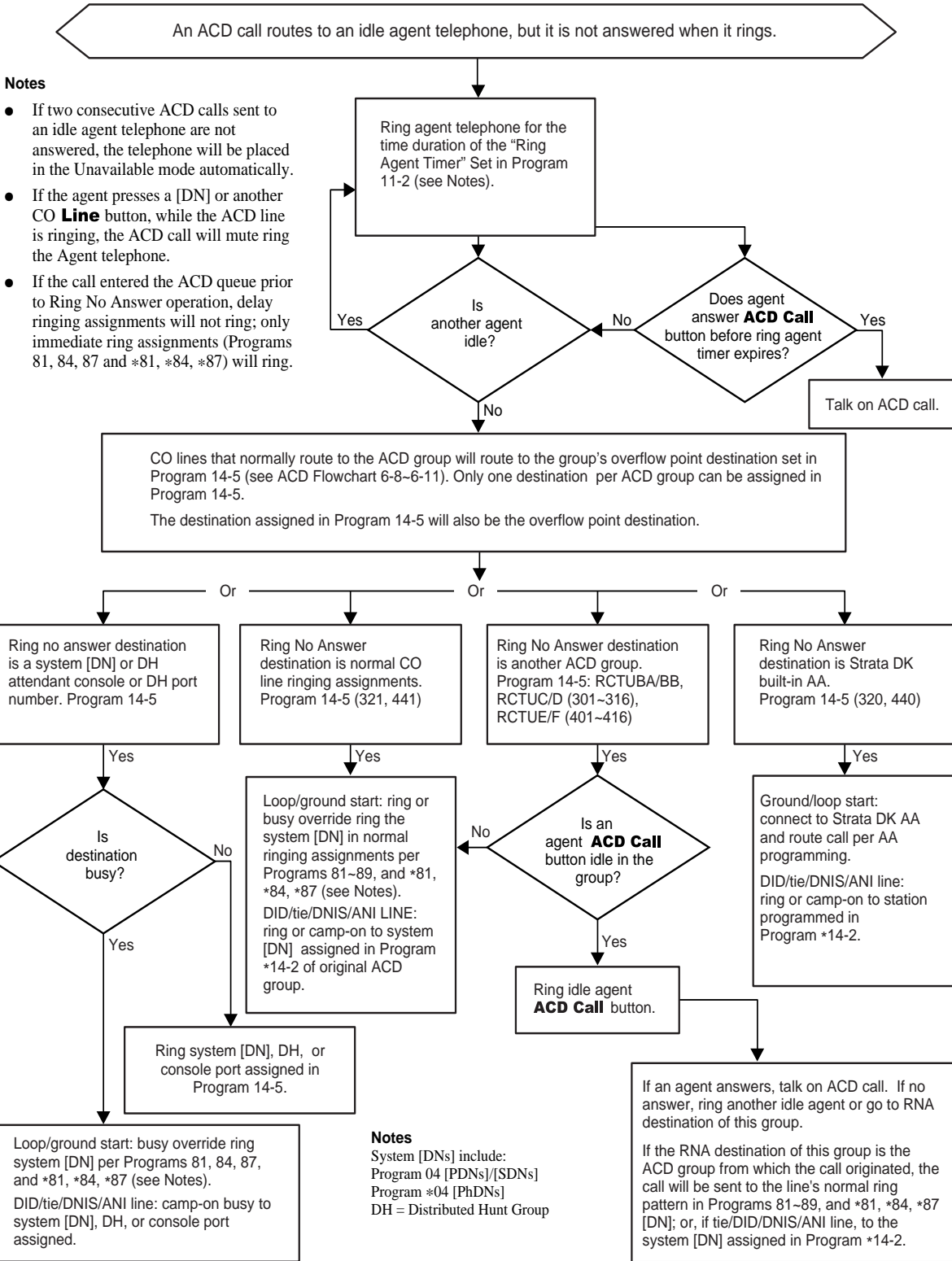

0880

Flowchart 6-8 ACD Queue Pattern Configuration – One Announcement Only

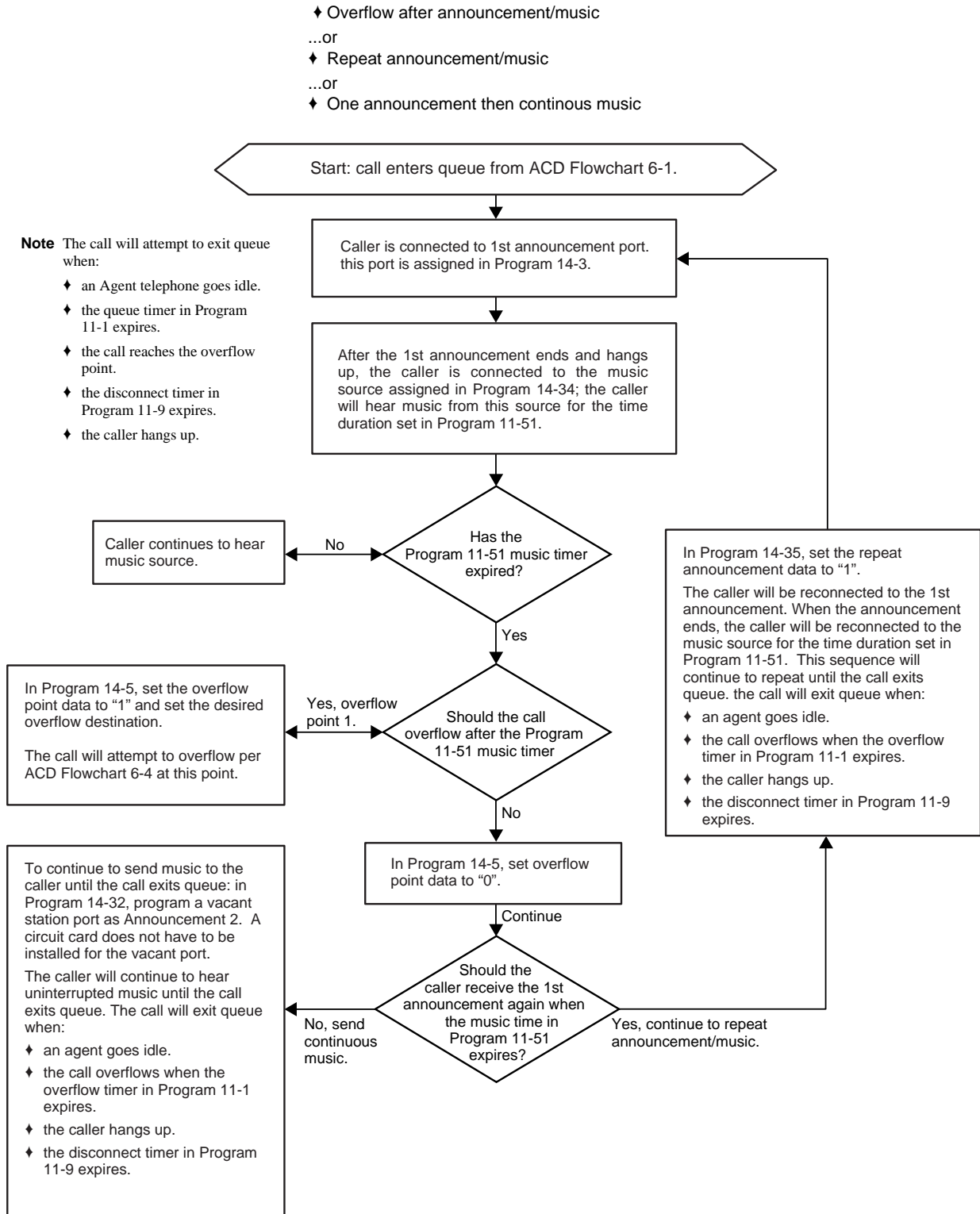

0881

Flowchart 6-9 ACD Queue Pattern Configuration – Two Announcements

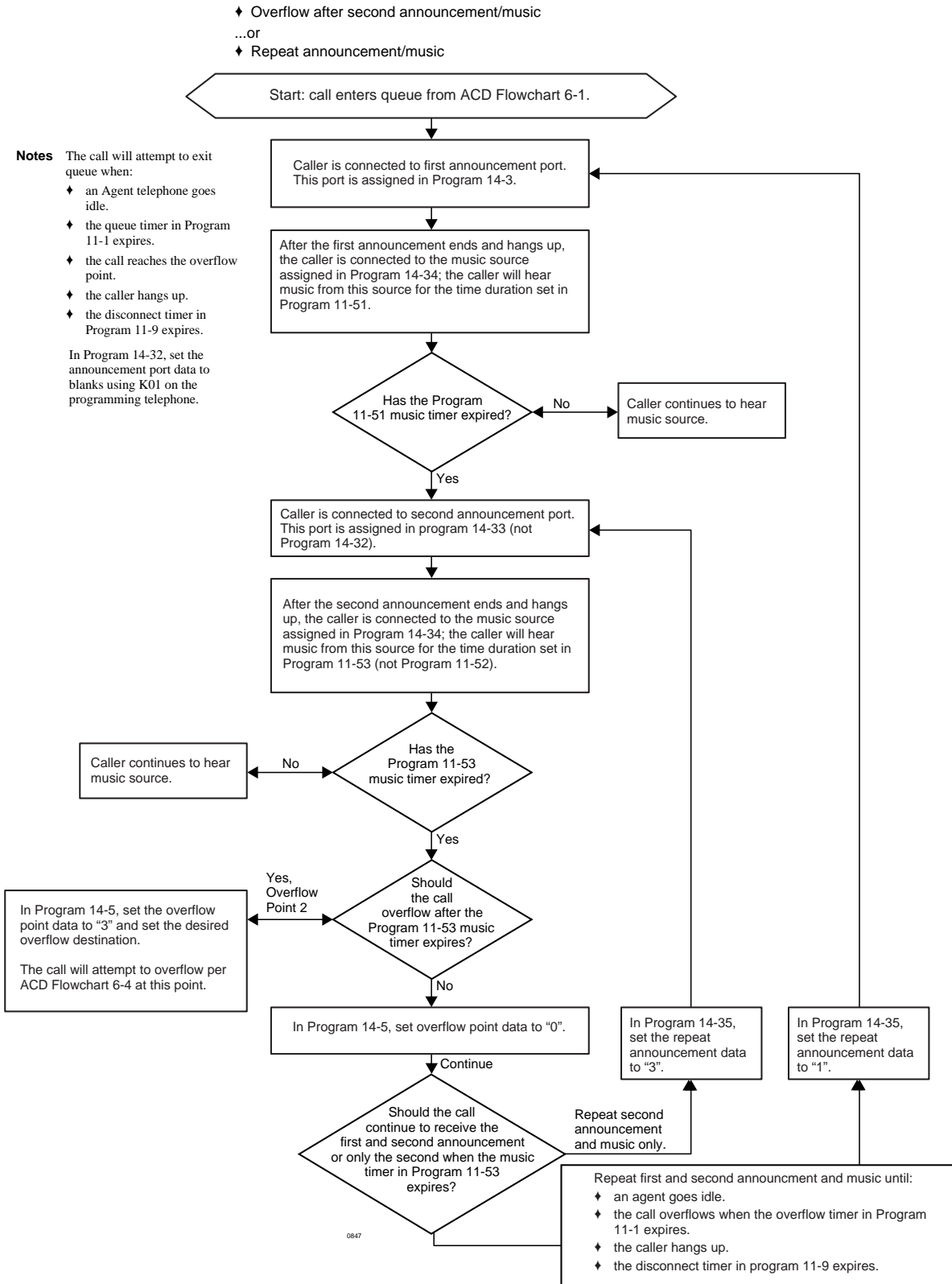

ACD Queue Pattern Configuration – Two Announcements (continued)

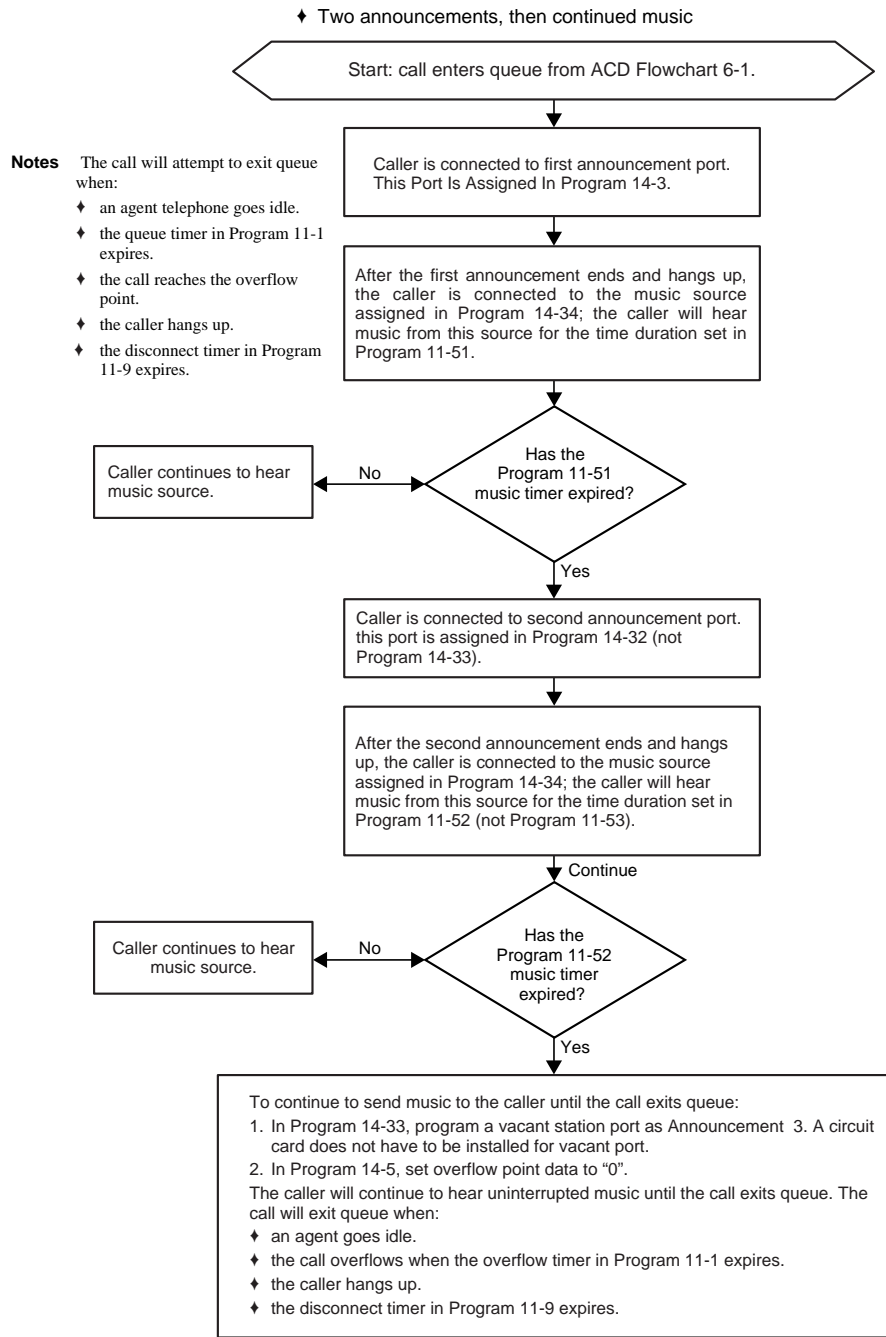

0848

Flowchart 6-10 ACD Queue Pattern Configuration – Three Announcements

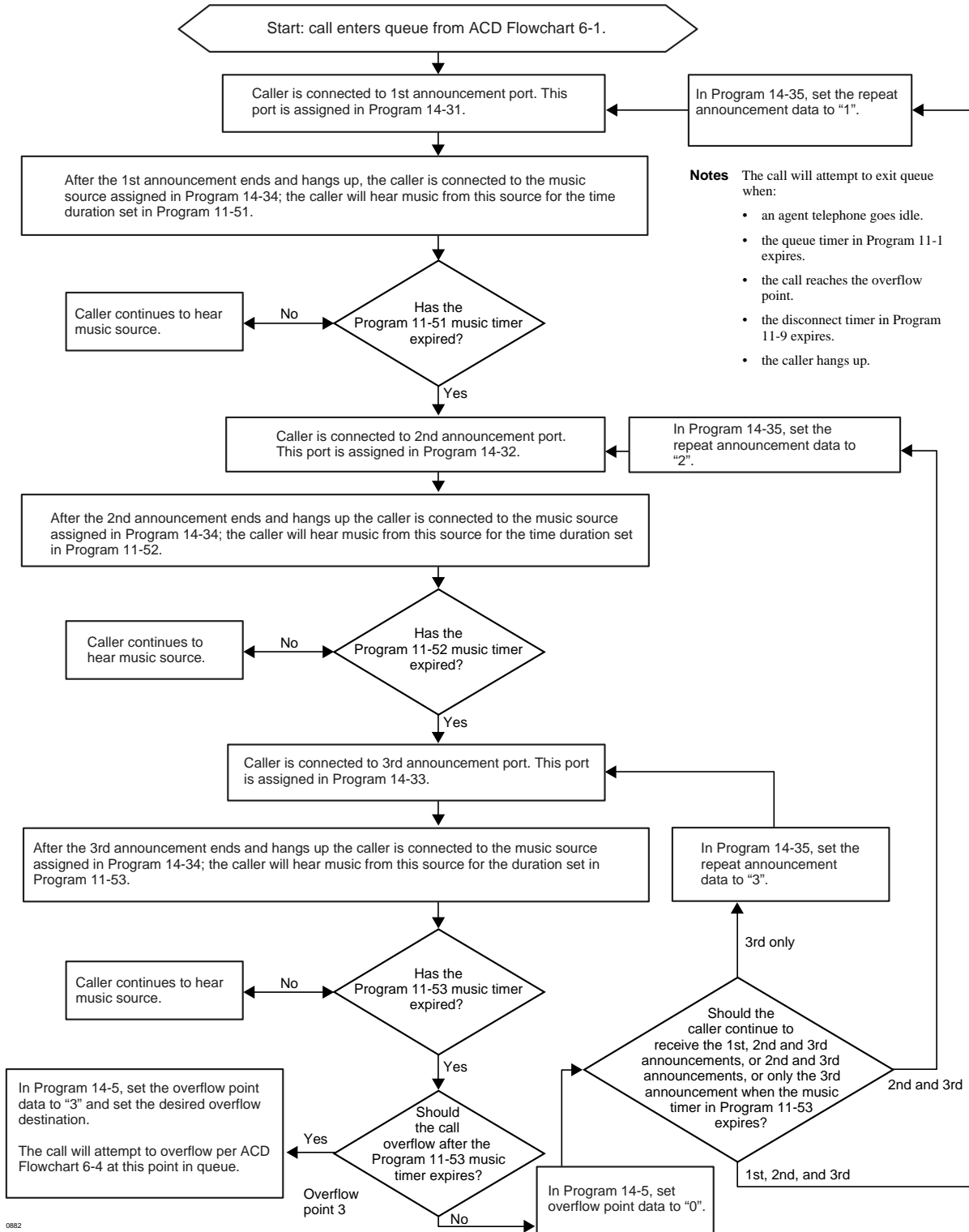

0882

Automatic Call Distribution

Program 39 – Flexible Button Assignments for ACD Telephones

This chapter provides you with an overview of Integrated Systems Digital Networking (ISDN) and provides step-by-step instructions to fill in the ISDN record sheets. Included is an overview of system and trunk programming for ISDN.

System Programs Overview

System programming for ISDN has some commonalities with T1 programming. ISDN programming follows two different paths, depending on whether Basic Rate Interface (BRI) or Primary Rate Interface (PRI) is being installed. Refer to Flowchart 7-1 and the following steps for an overview of each program's purpose.

ISDN features can be programmed onto the following systems as described:

- ♦ DK40i and DK424 – support BRI S/T
- ♦ DK40i and DK424 – will support BRI U basic features in Release 4.2
- ♦ DK424 supports PRI

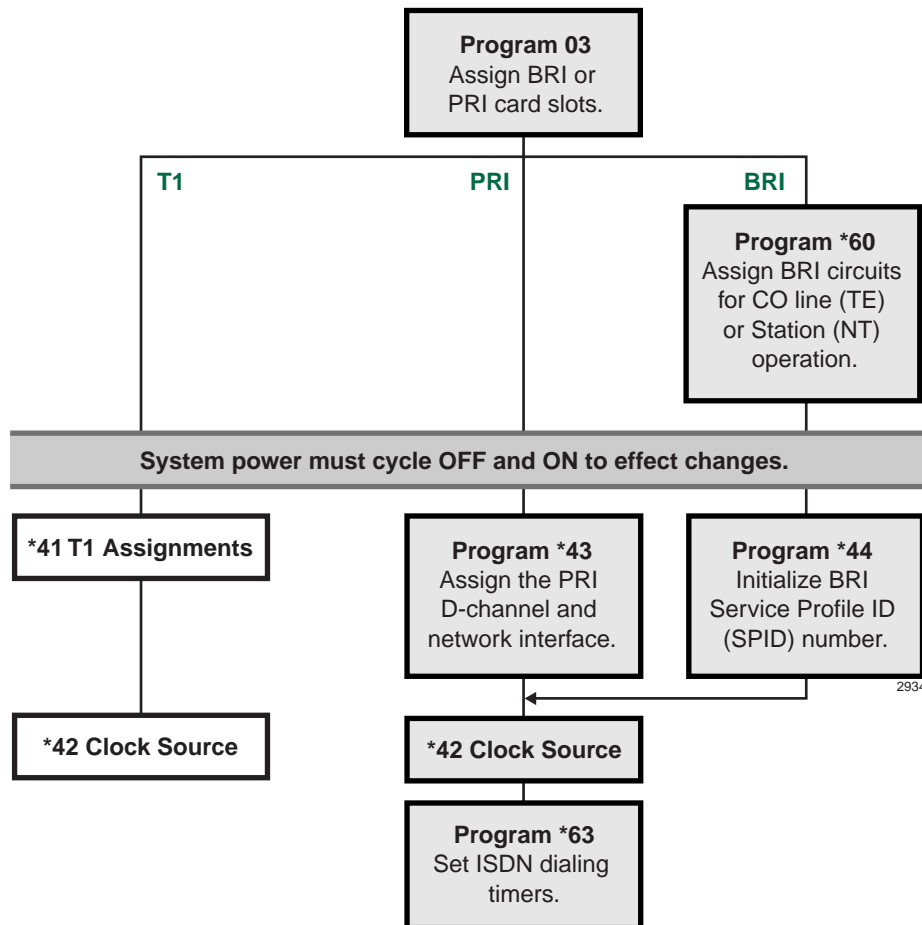

Flowchart 7-1 ISDN System Programs

► To record and enter the data for ISDN system programs

1. Run Program 03-Assign the RPTU (PRI) PCB slot position as type 79. (See “Program 03 for DK424 – Flexible PCB Cabinet Slot Assignments” on Page 3-6.) Assign the RBSU without the RBSS piggy-back board as type 77 and the RBSU with the RBSS piggy-back as type 78.
2. For BRI, run Program *60 to assign each circuit for CO line (TE) or Station (NT) operation.
3. Turn system power supply OFF (five seconds) and ON to activate Program 03 and *60 program data.

Note These are the only programs relating to RPTU operation that require system power to be cycled OFF and ON.

4. For PRI, run Program *43 to assign which channel on the PRI link is used for the D-channel. The second assignment specifies the card slot of additional PRI links that are dependent on the master D-channel PRI. The third assignment sets the ID code for the PRI link. For BRI, skip to Step 5.

5. For BRI, run Program *44 to initialize the Service Profile Identifier (SPID) interface. The TE initializes the SPID and sends it to the network. Once the SPID is confirmed from the CO, it does not have to be sent to the switch again.
6. For BRI and PRI, run Program *42 to assign the PRI or BRI, or T1, circuits to be used for Primary and Secondary Clock Source. To enter the program, enter the card slot number followed by the circuit number. When using the RPTU PRI or RDTU T1 interface then the circuit number is always 1.
7. For BRI and PRI, run Program *63 to assign the timer for sending dialed digits. Also use this program to enable sub-address dialing. (*63-1 is not zero).
8. See the following section, “ISDN Related Programs”, and make the appropriate programming assignments.

ISDN Related Programs

- ♦ **Program 10-1–System Assignments:** LED 16 determines the initialization process for BRI lines connected to the ISDN network (see 3-27).
- ♦ **Program 10-4–ACD/ISDN Parameters:** LEDs 11 and 12 set the T-Wait ISDN PRI and BRI timers, respectively. T-wait timers are used for reducing overloading ISDN terminals during concurrent initialization, such as following a wide-area power failure. LED 13 specifies whether or not 3.1 kHz audio calls can be received as speech calls. LED 14 enables the ISDN “Start” code to be sent when the Speed Dial button is pressed (see 6-6).
- ♦ **Program 39–Telephone Feature Buttons and Program 59–Attendant Console Feature Buttons:** A new button is provided called the **Start** button in both Program 39 (see 3-135) and 59 (see 3-111) to defeat the timeout when dialing is complete. Also a **Sub** button is provided for entering sub-address information.
- ♦ **Programs 55-1 and 55-2–Least Cost Routing Modified Digits:** Enables a sub-address separator (see 5-21).
- ♦ **Program 30 – Station Class of Service:** LED 12 defines whether the # button is used for dialing a sub-address or as a dialing separator. When LED 12 is ON, only the standard stations are affected. The DKT and EKT ports are ignored (see 3-73).

If the first dialed digit is #, the # will be treated as a feature access code. If # is entered at any point after that (in other words, as long as it is not the first digit dialed), then the system will treat the following numbers as a subaddress. A second # should then be entered to indicate the end of the subaddress.

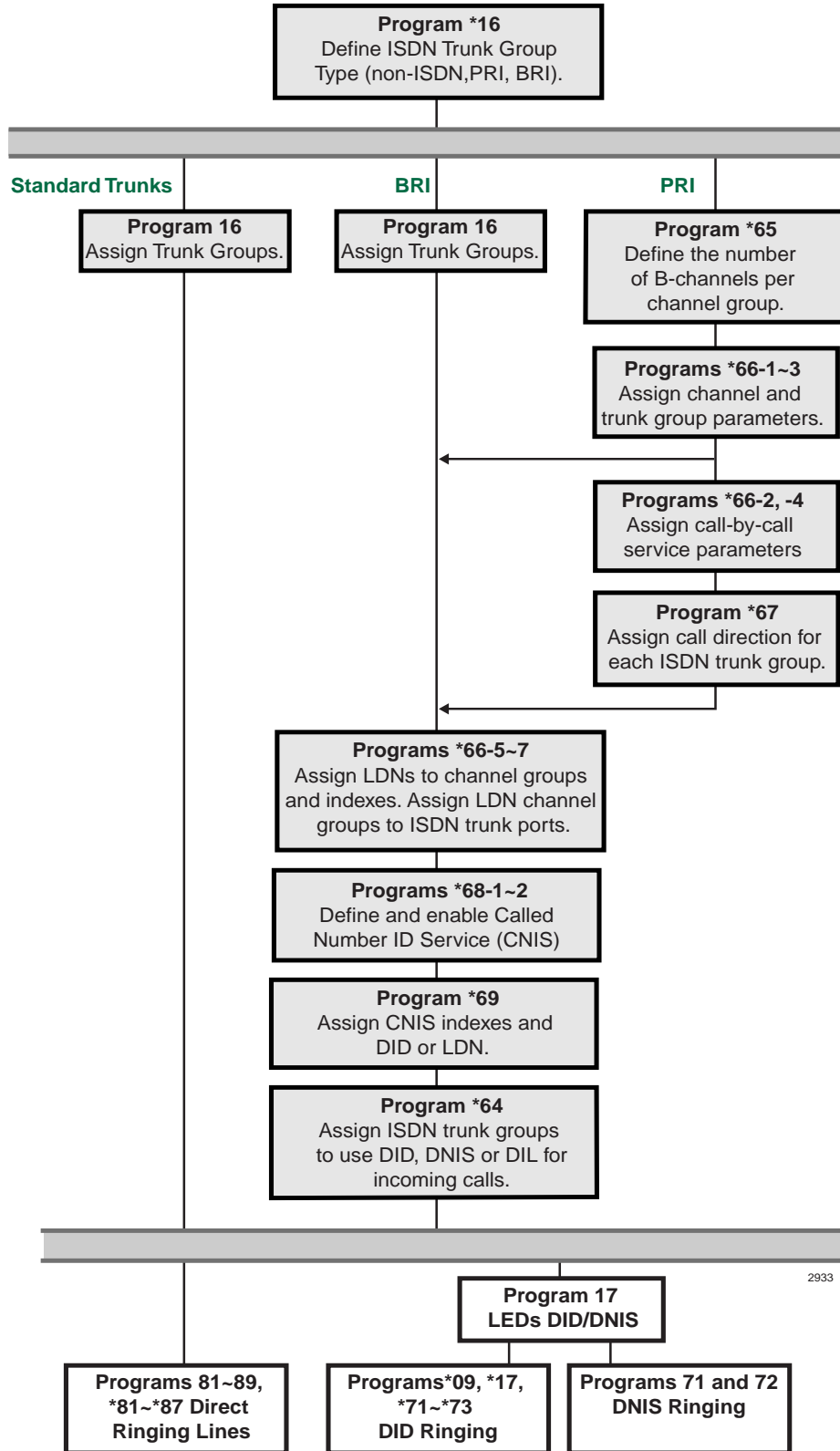

Flowchart 7-2 ISDN Trunk Programs

Trunk Programs Overview

See Flowchart 7-2 for an overview of the ISDN trunk programming procedure.

- ♦ If you are installing all standard trunk groups, skip Program *16 (the default is for all standard TGs).
- ♦ If you are installing BRI ISDN, use Program *16 to assign BRI type and Program 16 to assign BRI CO lines into trunk groups.
- ♦ If you are installing PRI, use Program *16 to assign PRI types. Do not use Program 16. Do *not* change settings in Program 16 for trunk groups marked for PRI.

Primary Rate Interface (PRI) Programming

1. Run Program *16 to define the ISDN trunk group type as: non-ISDN, Primary Rate Interface (PRI), or Basic Rate Interface (BRI).
2. For BRI trunk groups, run Program 16 to assign the trunk groups. Then, skip to Step 7.
3. For PRI, run Program *65 to assign B-channels.
4. For PRI, run Programs *66-1, *66-3 to define trunk groups parameters and channels. (Program 16 will be assigned automatically.)
5. To assign Call-by-call features (PRI only), run Programs *66-2, *66-4 to assign Call-by-call trunk groups codes and network ID.
6. For PRI, run Program *67 to assign call direction for ISDN trunk groups and call type capabilities allowed for each trunk group.
7. For BRI and PRI, run Program *68 to define the parameters for Calling Number to be presented for a call depending upon whether the ISDN trunk group uses DID, private numbers or use default number programmed in *68-2.
8. For BRI and PRI, run Program *66-5 to assign Listed Directory Numbers (LDNs) to channel groups and index numbers. Then run Program *66-6 to assign LDN channel groups to ISDN trunk ports. Then run Program *66-7 to assign trunk groups to each LDN.
9. Run Program *68-2 to define whether or not the system presents a “user” Caller ID when calls are made using ISDN services. This program also enables users to dial a code to send Caller ID or to block it.
10. For BRI and PRI, run Program *69 to define the parameters for Calling Number to be presented. Each phone can present a unique Caller ID number, such as DID or a private number. If neither is chosen, the default is the Directory Number entered in Program *68-2 for outgoing calls.
11. Run Program *64 to assign each ISDN trunk group to use DID/DNIS programming, or to provide Direct in Line (DIL) ringing for incoming calls.
12. See “ISDN Related Programs” on Page 7-3, and make the appropriate programming assignments.

Program 16 – Assign CO Line Groups

This program assigns CO line groups (or Dial 9 groups). Refer to this program only for BRI lines. Do *not* make changes to trunk groups assigned in Program *16 as PRI type. These will be assigned automatically when PRI programming is entered. The system record sheet is on Page 3-48 of this manual.

Program *16 – ISDN Trunk Group Type Assignment

Processor Type: DK40i, All RCTUs (Release 4.0 or higher)

Program Type: Trunk, PRI, BRI

Initialized Default: Type 1 (non-ISDN)

* # * # 1 * 2 * 3 - Spkr * 1 6 Hold - Spkr [] [] # [] Hold - Spkr # # Hold - Spkr # # Hold

SEL = Trunk Group Number [] [] TYPE = 1~3 (see below)
 1 - non-ISDN Trunk Group (default)
 2 - PRI Trunk Group
 3 - BRI Trunk Group

Trunk Groups																Value	Trunk Group Type	
1	2	3	4	5	6	7	8	9	10	11	12	13	14	15	16			
																	1	Non-ISDN
																	2	Primary Rate Interface (PRI)
																	3	Basic Rate Interface (BRI)

Program *16 Overview

This program must be entered prior to Program 16. Each trunk group in the system must be defined whether it is used for non-ISDN trunks, PRI trunks, or BRI trunks. Do not make changes in Program 16 for PRI trunk groups. This may cause unexpected operations.



Program *42 – Clock Source

Processor Type: DK40i, All RCTUs (Release 4.0 or higher). For Release 3.1 and earlier programming, see below.

Program Type: System, T1, PRI, BRI

Initialized Default: Blank

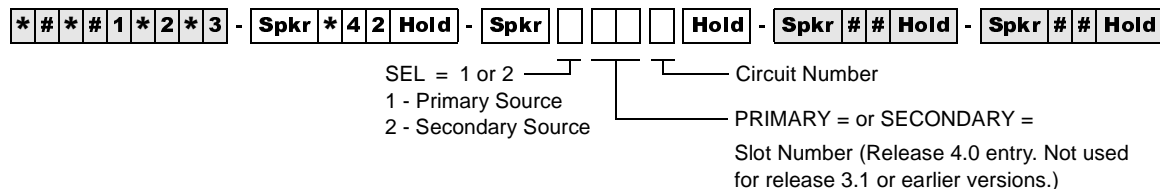

Clock Source	Slot Number	Circuit No.
Primary		
Secondary		

Program *42 Series Overview

This program assigns the T1, PRI or BRI interface RPTU PCB as a Primary or Secondary timing source. The DK424 is synchronized to the Public Network. If the Primary synchronization is lost, it switches to the secondary timing source.

When a T1 or PRI slot number is assigned, the DK424 only accepts a “1” for the circuit number. The circuit number is only used for BRI interfaces to specify which circuit is to be used for the Clock Source. If the PCB in this slot is not a T1 or ISDN PCB, the system will not accept data and any entries will be cleared.

BRI interfaces should be used as a clock source only when a T1 or PRI interface is not equipped

Set T1 parameters and assignments with the Program *41 (Part 1) and *42 (Part 2) series. See the *Strata DK Installation and Maintenance Manual* for additional T1 information. RDTU/RPTU support is as follows:

Processor	Number of RDTU/RPTU's Supported	Number of RBUU/RBUS's Supported
RCTUA	0	4
RCTUBA/BB	2	8
RCTUC/D	6	14
RCTUE/F	8	20

For proper T1 or ISDN operation, the equipment at each end of a digital T1 span line must be synchronized. The DK424 is synchronized (as slave) to the equipment on the other end of the digital line by the RDTU/RPTU, RBUU/RBUS PCB designated as the Primary Reference in Program *42-1.

If a malfunction occurs and Primary Synchronization is lost, the DK424 automatically switches modes and synchronizes to the equipment connected to the secondary PCB designated as the Secondary Reference. If the equipment on the other end of the DK424 digital lines should synchronize to the DK424 clock source, then enter blanks in Program *42-1 and 2. In this case, the DK424 clock runs free and is considered the Master Synchronization source.

Program *42-1 – Primary Timing Reference Assignments (Release 3.1 and earlier)

Initialized Default: Primary = 1, Secondary = 2

* # * # 1 * 2 * 3 - Spkr * 4 2 Hold - Spkr [] [] Hold - Spkr # # Hold - Spkr # # Hold

SEL = 1 or 2
 1 - Primary Source
 2 - Secondary Source

RDTU PCB Number (1~8)
 Enter the RDTU PCB number that is connected to the primary reference T1 (span line) clock source.
 Press LED Button 01 (blank) if the DK424 T1 is the master (free run) clock source.

Select	RDTU PCB Number
Primary	
Secondary	

Program *42-1 Overview (Release 3.1 and earlier)

Assign the Primary Timing Reference with this program.

Note RDTU No.1 is the RDTU PCB installed in the lowest slot number of all RDTU PCBs, RDTU No. 2 is the RDTU PCB installed in the next highest slot number of all RDTUs and so on.

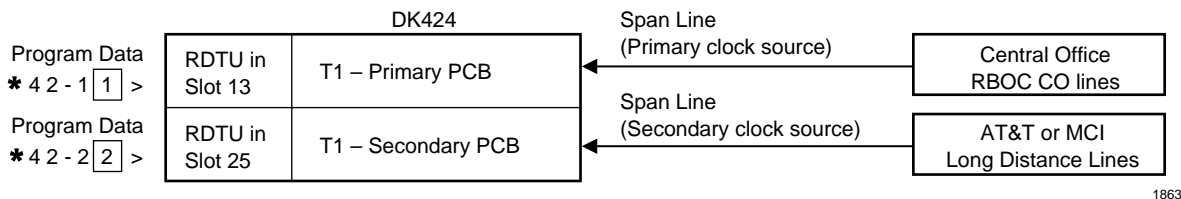

Primary/Back-Up Assignments Example

Note A second RBOC T1 span line can also be used as the secondary clock source.

DK424 Master (free run) Assignment Example

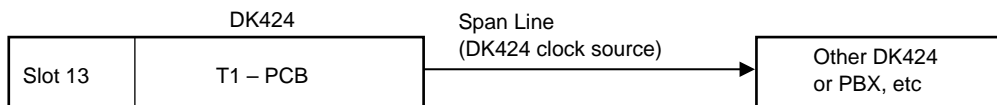

Program Data = blank button (Button 01)
 for * 4 2 - 1 and * 4 2 - 2

1864

Program *42-2 Overview (Release 3.1 and earlier)

Assign the Secondary (Backup) Timing Reference with this program.

Note To assign RDTUs as the Master Clock Reference (free run), leave Programs *42-1 and *42-2 blank. Press button/LED 01 to enter blanks.

Program *43-1~3 – D-Channel Control and NFAS Assignments

Processor Type: All RCTUs (Release 4.0 or higher)

Program Type: System, PRI

Initialized Default: Blank (see Important! below)

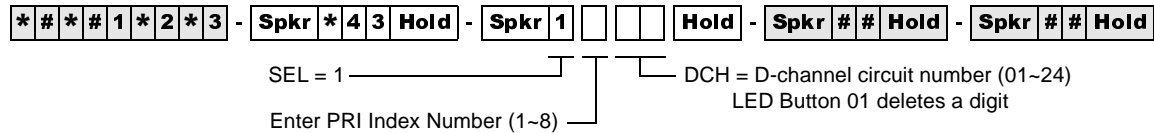

PRI Index	*43-1 D-Channel Circuit Number	*43-2 Master PRI Index	*43-3 Network PRI Interface ID Code

Program *43-1~3 Overview

Programs *43-1~3 are related in that there is a correspondence between Program *43-1 and *43-2. Program *43-1 determines which channel acts as the master. Program *43-2 points back to the master channel by using the corresponding index number.

Program *43-1 Overview

This program (*43-1) assigns which channel on the PRI link is used for D-channel (the data master control channel). The default setting is none.

Important! For most carriers, channel 24 is assigned to the D-channel (default). NFAS D-channel assignments are negotiated with the carrier.

Program *43-2 – Non-Facility Associated Signaling (NFAS) Assignment

Processor Type: All RCTUs (Release 4.0 or higher)

Program Type: System, PRI

Initialized Default: Blank (see Important! below)

* # * # 1 * 2 * 3 - Spkr * 4 3 Hold - Spkr 2 [] [] Hold - Spkr # # Hold - Spkr # # Hold

SEL = 2 —————┐
 Enter the dependent PRI Index —┐
 Number without D-channel (1-8) —┘

PRI = Master PRI Index
 Number with D-channel (1-8)

Program *43-2 Overview

This program specifies the card slot of additional PRI links that are dependent upon the D-channel of the master D-channel PRI. This setting is for Non-Facility Associated Signaling (NFAS).

Use the Record Sheet for *43-1.

Program *43-3 – Network PRI Interface Assignment

Processor Type: All RCTUs (Release 4.0 or higher)

Program Type: System, PRI

Initialized Default: Blank (see Important! below)

* # * # 1 * 2 * 3 - Spkr * 4 3 Hold - Spkr 3 Hold - Spkr # # Hold - Spkr # # Hold

SEL = 3 —————
 Enter the PRI Index Number (1~8) ————— ID = Network PRI Interface Code,
 supplied by public provider (0~19)

Program *43-3 Overview

Program *43-3 assigns each PRI interface and ID code for communicating with the ISDN provider to identify the B-channels to be used with NFAS.

Use the Record Sheet for *43-1.

Program *60 – BRI Line/Station Operation Assignment

Processor Type: DK40i, All RCTUs (Release 4.0 or higher)

Program Type: System, BRI

Initialized Default: All LEDs OFF

##1*2*3 - Spkr *60 Hold - Spkr Hold - Spkr ## Hold - Spkr ## Hold

SEL = Slot No. LEDs 1~4 = Circuits 1~4 (see legend below)

LED	RBSU Circuit	LED ON	LED OFF
1	1	CO Line (TE)	Station Operation (NT) (default)
2	2	CO Line (TE)	
3	3	—	
4	4	—	

Note Power must be cycled OFF, then ON before changes take effect.

LEDs	Slot 1				Slot 2				Slot 3				Slot 4				Slot 5				Slot 6				Slot 7			
	1	2	3	4	1	2	3	4	1	2	3	4	1	2	3	4	1	2	3	4	1	2	3	4	1	2	3	4
1																												
2																												
3																												
4																												

Program *60 Overview

This program assigns each circuit for CO Line (TE) or ISDN Station (NT) operation. Circuits 1 or 2 can be used for either CO line or ISDN station operation, while circuits 3 and 4 can only be used for ISDN station operation.

Program *63 – ISDN Dialing Parameters

Processor Type: DK40i, All RCTUs (Release 4.0 or higher)

Program Type: System, PRI and BRI

Initialized Default: 4 seconds

* * * 1 * 2 * 3 - Spkr * 6 3 Hold - Spkr Hold - Spkr # # Hold - Spkr # # Hold

SEL = 1 or 2 (see table below) DATA = Seconds (see table below)

Select	Timeout Parameter	Value	Comments
1	Sub-address dialing		Value 00 to 10 seconds (default 04)
2	Outdialing		Value 02 to 10 second (default 04)

Program *63 Overview

This program sets the timer for sending dialed digits if the user does not press the **Start** button or if the dialed number does not meet the established dialing plan number of digits.

When the sub-address dialing timer is set to 00, subaddress dialing is not supported.

Program *64-1 – Direct Inward Dialing Parameters

Processor Type: DK40i, All RCTUs (Release 4.0 or higher)

Program Type: Trunk, PRI and BRI

Initialized Default: LED 01 ON for DID or DNIS programming

* # * # 1 * 2 * 3 - Spkr * 6 4 - Hold - Spkr 1 [] [] # [] Hold - Spkr # # Hold - Spkr # # Hold

SEL = 1
 Enter the trunk group(s)
 To add a range of trunk groups, enter XX*XX (low trunk group * high trunk group)

LED 01: ON = Use DID/DNIS tables in Programs *09 or 71
 OFF = Use direct ringing tables in Programs 81~89, *81, *84, *87

LED	LED ON	LED OFF
01	Use DID/DNIS for incoming calls.	Direct ring the called station.

Trunk Groups	Ports	LEDs
		01
1		
2		
3		
4		
5		
6		
7		
8		
9		
10		
11		
12		
13		
14		
15		
16		

Program *64-1 Overview

Program *64-1 assigns each ISDN trunk group to use DID/DNIS programming or provide Direct in Line (DIL) ringing for incoming calls.

Program *64-2 – Number of DID/DNIS Digits for Trunk Groups

Processor Type: DK40i, All RCTUs (Release 4.0 or higher)

Program Type: System, PRI and BRI

Initialized Default: Blank



SEL = 2
Enter Trunk Group Number

DATA = Enter the number of digits to use for incoming call DID digits (2-5)

To add a range of trunk groups, enter XX*XX (low trunk group * high trunk group)

Trunk Groups	Number of DID Incoming Call Digits per Trunk Group
1	
2	
3	
4	
5	
6	
7	
8	
9	
10	
11	
12	
13	
14	
15	
16	



Program *64-2 Overview

This program establishes the number of digits to be used for DID or DNIS table interpretation for each ISDN trunk group.

The DK424 uses the last two to four digits of the incoming listed directory number (LDN) to determine the DID call destination. If Program 17 was assigned for DNIS, the DK424 uses the last two to five digits of an incoming LDN to determine the DNIS call destination.

Program *65 – ISDN Channel Group Assignment

Processor Type: All RCTUs (Release 4.0 or higher)

Program Type: System, PRI

Initialized Default: All LEDS OFF (see Important! below)

Note Program *65 must be assigned before entering Program*66.

* # # # 1 * 2 * 3 - Spkr * 6 5 Hold - Spkr Hold - Spkr # # Hold - Spkr # # Hold

SEL = Channel Group (1~8)

GRP = Light LEDs to select PRI B-channels for the channel group.

Press **Scroll** to advance or **Page** to go back.

ISDN B-channel Lines	RCTUA	RCTUBA/BB	RCTUC/D	RCTUE/F
PRI (T)	23	47	141	188

Channel Group	CO Line Ports (B-Channels)																			
	1	2	3	4	5	6	7	8	9	10	11	12	13	14	15	16	17	18	19	20
1																				
2																				
3																				
4																				
5																				
6																				
7																				
8																				

Program *65 Overview

This program assigns an ISDN group number and its PRI B-channel members. All B-channels assigned to an ISDN channel group must use the same D-channel. The B-channels on the same DS-1 interface can belong to different channel groups.

All ISDN connections require the active B-channels to be assigned to a channel group. The B-channels appear as CO ports assigned in sequence when the PRI card type is entered.

Note Do not include the channels used as D-channels.

Important! B-channels 1~23 are active (by default from the public carrier) in a standard PRI interface.

Program *66-1 – Channel Group Number Parameters

Processor Type: All RCTUs (Release 4.0 or higher)

Program Type: Trunk, PRI

Initialized Default: Blank

Note Program *65 must be assigned before entering Program *66. If Program *65 changes, then this program will be affected. Program *66 defaults back to the settings in Program *65.

##1*2*3 - Spkr*66 Hold - Spkr 1 Hold - Spkr## Hold - Spkr## Hold

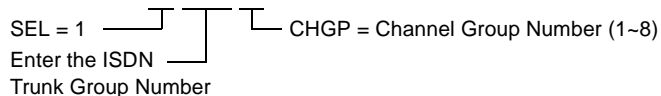

Trunk Groups															
1	2	3	4	5	6	7	8	9	10	11	12	13	14	15	16

Program *66-1 Overview

This program assigns PRI ISDN trunk groups to a channel group.

ISDN Trunk Groups are assigned based upon all available trunk groups in Program *16, identified as PRI trunk groups.

This program must be entered after Program *65 or anytime a change is made to *65.

The channels assigned in *65 will be transferred into the last trunk group entered in *66-1 for that channel group.



Program *66-4 Call-by-Call Network ID

Processor Type: All RCTUs (Release 4.0 or higher)

Program Type: Trunk, PRI

Initialized Default: Blank

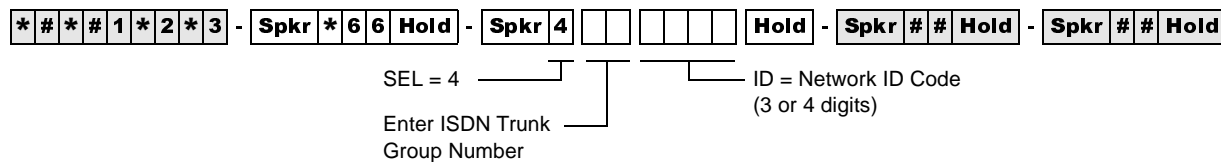

Program *66-4 Overview

Some Call-by-Call services are provided by inter-exchange carriers. These services need a network ID code for call setup. When a Network ID Code is entered, the service parameters in *66-2 must be blank.

If both the Service Parameter and the Network ID are programmed, Service Parameter has priority and Network ID will be ignored.

Record Sheet

Use the record sheet for Program *66-2.

Program *66-3 – Channel Group/Trunk Parameters

Processor Type: All RCTUs (Release 4.0 or higher)

Program Type: Trunk, PRI

Initialized Default: Blank

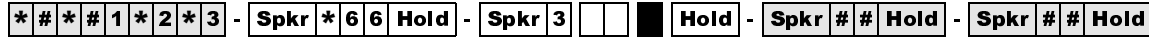

SEL = 3
Enter the ISDN Trunk Group Number (01~16)

DATA = Light LEDs to assign features. See tables below.

LEDs 03~06 specify the trunk types shown in the following table.

LEDs	POTS	FX	Tie (senderized)	Tie (cutthrough)	OutWATS (IntraLATA)	OutWATS (InterLATA)	InWATS
03		ON			ON	ON	
04			ON	ON	ON	ON	
05							ON
06				ON		ON	

LEDs	Setting	Trunk Groups																
		1	2	3	4	5	6	7	8	9	10	11	12	13	14	15	16	
01	ON: Operator Calls Allowed/ OFF: Not allowed																	
02	ON: Carrier Access allowed OFF: Not allowed																	
03	Trunk Group Type (see above table).																	
04	Trunk Group Type (see above table).																	
05	Trunk Group Type (see above table).																	
06	Trunk Group Type (see above table).																	
07~10	Not Used																	
11	ON: Called Party Number Type Unknown OFF: Standard Called Party Number Type																	
12	ON: DK sends Ringback Tone to Network OFF: No RBT to Network. (Default is ON.)																	
13	ON: DMS CO switches only OFF: Belcore (Default is OFF.)																	

Program *66-3 Overview

This program assigns special call treatment and defines the ISDN service. Call treatment includes whether or not operator calls are allowed, if carrier access is allowed, etc. The ISDN service is similar to trunk type, such as POTS, FX, Tie, outWATS and inWATS.

Program *66-4 Call-by-Call Network ID

See “Programs *66-2 and *66-4 – Call-by-Call Trunk Group Codes and Network ID” on Page 7-22. Use the record sheet for Program *66-2.

Program *67-1 – Trunk Group Call Direction

Processor Type: All RCTUs (Release 4.0 or higher)

Program Type: Trunk, PRI

Initialized Default: Both Way

* # * # 1 * 2 * 3 - Spkr * 6 7 Hold - Spkr 1 [] [] [] Hold - Spkr # # Hold - Spkr # # Hold

SEL = 1 ————
 Enter the Trunk Group (01~16) ————
 DIR = Call Direction
 1 = Incoming
 2 = Outgoing
 3 = Both Way

Value	Trunk Groups																Call Direction	
	1	2	3	4	5	6	7	8	9	10	11	12	13	14	15	16		
1																		Incoming
2																		Outgoing
3																		Both Way

Program *67-1 Overview

This program assigns the call direction for each ISDN trunk group.

Program *67-2 – Call Types for ISDN Trunk Group Supported

Processor Type: All RCTUs (Release 4.0 or higher)

Program Type: Trunk, PRI

Initialized Default: Blank

* * * * 1 * 2 * 3 - Spkr * 6 7 Hold - Spkr 2 [] [] [] [] Hold - Spkr # # Hold - Spkr # # Hold

SEL = 2 ————— Turn on LEDs 01~04 to select the call type. See table below.

Enter the Trunk Group (01~16) —————

Enter the Time Zone (1~3) —————

For Rel. 4.0, enter 1

Trunk Groups	Time Zone	Speech LED 01	3.1 kHz Audio LED 02	64 kbps. Data LED 03	56 kbps. Data LED 04
1					
2					
3					
4					
5					
6					
7					
8					
9					
10					
11					
12					
13					
14					
15					
16					

Program *67-2 Overview

This program defines the call type or “Bearer Services” allowed for each ISDN trunk group. These settings will be set for three different time zones in an upcoming release. All of the call types that will be used should be turned on. Normally, Speech and 3.1 kHz Audio (non-ISDN voice calls and fax calls), should be turned on.



Program *67-3 – ISDN Trunk Group Minimum Channel Reservation

Processor Type: All RCTUs (Release 4.1)

Program Type: Trunk, PRI

Initialized Default: Default = 00

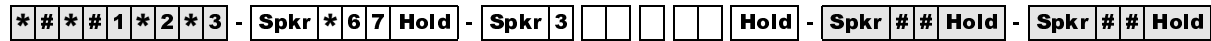

SEL = 3

Enter the Trunk Group (01-16)

Enter the Time Zone (1-3)
For Rel. 4.0, enter 1

MIN = Minimum number of B-channels reserved.
Max. 47 when sharing D-channels.

Trunk Groups	Time Zone 1 B-channels reserved		Time Zone 2 B-channels reserved		Time Zone 3 B-channels reserved	
	Min.	Max.	Min.	Max.	Min.	Max.
1						
2						
3						
4						
5						
6						
7						
8						
9						
10						
11						
12						
13						
14						
15						
16						

Program *67-3 Overview

This program defines the minimum number of B-channels reserved for this service. Each of the three time zones may have a different value.

- Enter the minimum and maximum number of B-channels reserved for each Time Zone.

Program *67-4 – ISDN Trunk Groups Maximum Channel Reservation

Processor Type: All RCTUs (Release 4.1 or higher)

Program Type: Trunk, PRI

Initialized Default: 23 maximum default channels

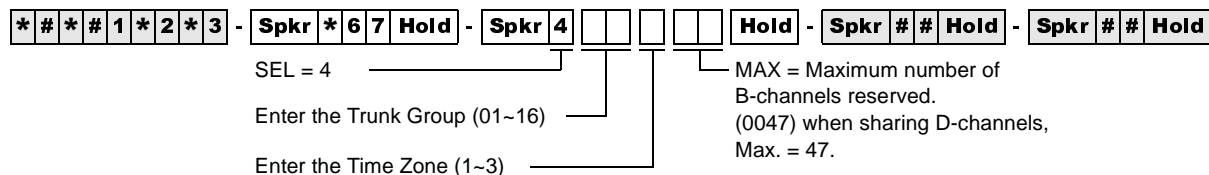

Program *67-4 Overview

This program specifies the maximum number of B-channels that can be used to carry calls with this service. Each of the three time zones may have a different value.

Use the record sheet with Program *67-3.

Program *67-5 – Multiple Time Zone Settings

Processor Type: All RCTUs (Release 4.1 or higher)

Program Type: Trunk, PRI

Initialized Default: Default = 0000

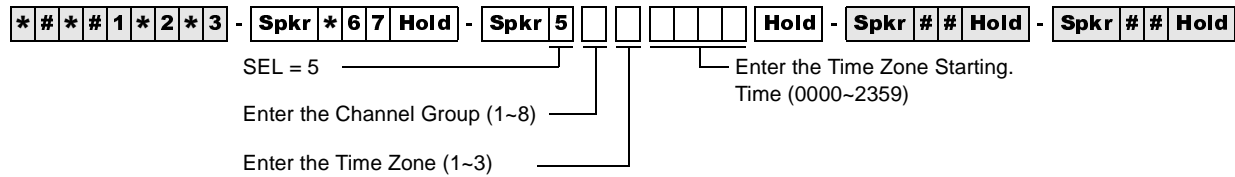

Program *67-5 Overview

This program enables setting three different time zones. In Release 4.1, the maximum number of lines that can be obtained by each trunk group and the minimum number of lines that can be secured is programmable. By programming the max. and min. number of lines that can be used by a trunk group, this prevents a trunk group from monopolizing all the lines.

Program *68-1 – Calling Number ID Presentation Parameters

Processor Type: DK40i, All RCTUs (Release 4.0 or higher)

Program Type: Trunk, PRI and BRI

Initialized Default: all LEDs OFF

* * * * 1 * 2 * 3 - Spkr * 6 8 Hold - Spkr 1 [] [] [] Hold - Spkr # # Hold - Spkr # # Hold

SEL = 1 ————
Enter the Trunk Group (01~16)

DATA = Press LED Buttons 01~03 for the desired Calling Number ID parameters. See table below.

LED	Caller ID Setting	Trunk Groups															
		1	2	3	4	5	6	7	8	9	10	11	12	13	14	15	16
1	Outgoing Caller ID (ON = Allowed / OFF = Not Allowed)																
2	Outgoing Caller ID Status Change: ON = Allowed / OFF = Not Allowed																
3	Incoming Caller ID Source: ON = Network Provided OFF = Caller Provided																

Program *68-1 Overview

This program assigns the Number Privacy feature, which allows the caller to prevent the public network from delivering the Calling Number to the called party on a per-call basis. The Public Switched Telephone Network (PSTN) may still provide a network-based Caller ID, even when the outgoing Caller ID is OFF. Only a subscription parameter can change that.

LED 01: Outgoing Caller ID

Service subscribers can request from the public network that the number be presented or not as a default.

LED 02: Outgoing Caller ID Status Change

If a public telco service allows changes to be made, then a user can enter change a code to the setting for that call after selecting a trunk group.

LED 03: Incoming Caller ID Source

When LED 03 is ON, the calling number with the call setup message is provided by the network; OFF indicates that this information is sent from the caller. The Strata DK handles the number the same way that ANI information from T1 trunks is handled. For instance, the number can display on the called telephone's LCD, or it can be used by TAPI interfaces, or it can be recorded in SMDR data records.

The PSTN may send one or two Caller ID messages for incoming calls. One message is the Caller ID supplied by the network, which is generally the billing number, while the second is the user generated number. The Strata DK will use the user-supplied number, if required.

Note Individual callers can choose to block this information, regardless of this setting.

Program *68-2 – Outbound CNIS Parameters

Processor Type: DK40i, All RCTUs (Release 4.0 or higher)

Program Type: Trunk, PRI and BRI

Initialized Default: Blank

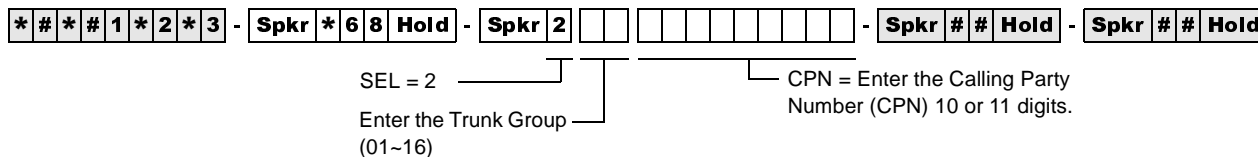

Trunk Groups	Calling Party Number
1	
2	
3	
4	
5	
6	
7	
8	
9	
10	
11	
12	
13	
14	
15	
16	

Program *68-2 Overview

This program defines the default Calling Party Number (CPN) for the ISDN trunk group used for placing a call. The PSTN uses this Calling Party Number for the user provider Caller ID and optionally may use it for billing the call.

The number sent is based on the call originator. The originator can be a tandem call, a station (with or without DID), or a station with a designated number:

- ♦ For a tandem call, the CPN digits received are the digits that will be sent.
- ♦ For a direct station call, the default number assigned to the selected service and which is programmed into the Strata DK as the CPN will be the number sent.
- ♦ For a fixed number, the system sends the number assigned in the system (in this program) or it can use the DID programming to determine the number to be sent. Program *69 (DATA=Type 1 or 2) defines whether fixed numbers from this program are sent or if DID digits from Program *09 are sent.

This chapter contains programming record sheets, along with specific instructions for programming E911 CAMA trunks.

Enhanced 911 CAMA trunks apply only to the DK424, Release 4.0. The RMCU/RCMS PCBs provide up to four CAMA trunk circuits. The RMCU/RCMS eliminates the need for adjunct terminal adapter equipment for connecting to E911 CAMA trunks. For more information on hardware, refer to the *Strata DK Installation and Maintenance Manual*.

Operation Overview

The DK424 E911 feature provides flexible dialing of 911 emergency calls. This allows users who are not familiar with DK424 dialing sequences to make an emergency call regardless of how they dial 911 from Toshiba telephones. In all of the sequences below, the DK will seize an idle CAMA trunk and send 911 plus the dialing station's Caller Emergency Service Identification (CESID) over the CAMA trunk via MF tones.

Note Once a 911 call is started, most other buttons/keys on a telephone are disabled to prevent accidentally dropping the 911 call attempt. This includes the **Hold** button, so that the 911 call cannot be put on hold.

- ♦ Press DN button and dial 911. When the user dials 911, the PDN releases from the internal connection and seizes the CAMA trunk.
- ♦ Off Hook and dial 911 (station has off hook selection of PDN in Program 32). When the user dials 911, the PDN releases from the internal connection and seizes the CAMA trunk.
- ♦ Off Hook and dial 911 (station has off hook selection of a CO line or line group in Program 32 and has a CO **Line** or **Pooled Line** buttons). When the user goes off-hook, the station will seize the normal CO line on the appropriate CO **Line/Pooled Line** button. When the user dials 911, the normal CO line is dropped and an idle PDN or CAMA CO button connects to the CAMA trunk. If an idle PDN or CAMA CO button is not available, the 911 call will be sent out the originally selected line without the station's CESID information.
- ♦ Press DN button and dial 9+911 (no LCR, 9 is line group access code, station does not have CO **Line**, **Pooled Line** or **CAMA** CO buttons). When the user dials 9, the station will seize a "dial 9" CO line on its PDN button. When the user dials 911, the 911 call will be sent one of two ways:
 - ♦ If the station does not have another idle PDN or **CAMA** CO button, the 911 call will be sent out the normal CO line in the dial 9 line group without the station's CESID.
 - ♦ If the telephone has another PDN or **CAMA** CO button, and it is idle, the first PDN will drop and the second PDN or CAMA CO button will be connected to the CAMA trunk. 911 plus the station's CESID will be sent out the CAMA trunk.

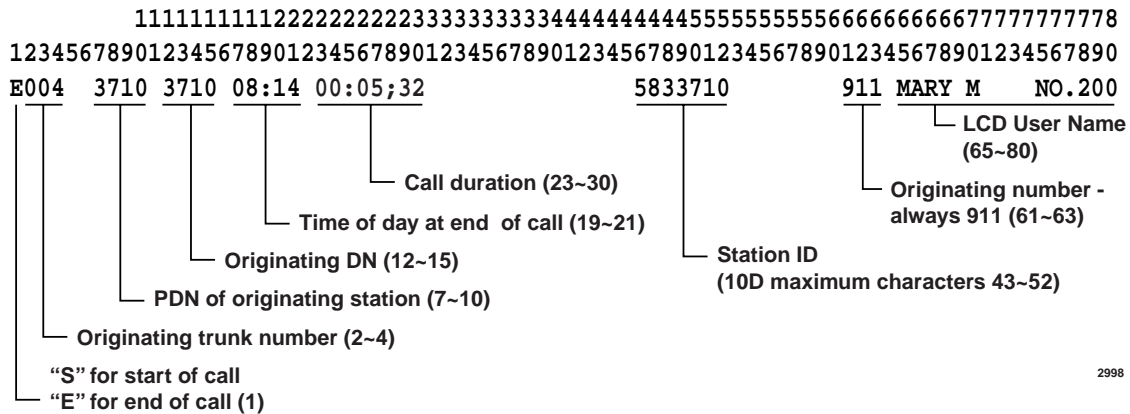

Notes

- This record is similar to a Start record except that:
- The first character “E” indicates “End of Call.”
- Call duration is provided.
- Time of day shows disconnect time.

Figure 8-2 SMDR End of Call

Programming Overview

The basic programming for the E911 CAMA trunks feature is accomplished using Programs *11, *12, and *13. Program *10 is not used for RMCU/RCMS CAMA trunks, it is only used when E911 is provided using an adjunct E911 device.

Program 39 tips:

- ♦ When a user presses a normal CO line button and dials 911, the telephone drops the normal line button and connects a CAMA trunk to an idle [PDN] or **CAMA** CO button on the telephone. Then, the DK sends 911 + plus the telephone’s CESID on the CAMA trunk. If there is no idle [PDN], 911 is sent on the originally selected CO line without CESID.
- ♦ To ensure that there is an idle PDN when a telephone is assigned to auto-off-hook, select a CO line or CO line group in Program 32. The telephone should have a button appearance of this CO (or pooled) line. Or, if the telephone does not have these line buttons it should have another [PDN] button appearance to connect to the CAMA trunk in case 911 is dialed.

Program *11-0 – E911/CAMA Trunk Assignments

Processor Type: All RCTUs (Release 4.0)

Program Type: System

Initialized Default: all LEDs OFF

* # * # 1 * 2 * 3 - Spkr * 1 1 Hold - Spkr 0 Hold - Spkr # # Hold - Spkr # # Hold

SELECT = 0 Light the LED Buttons that are marked with an X in the table below.
ON=Enabled. OFF=Disabled.

LED/ Button	X	LED ON	LED OFF
11		E911 enabled	E911 disabled
10		CAMA trunk 4 not used	CAMA trunk 4 used
09		CAMA trunk 3 not used	CAMA trunk 3 used
08		CAMA trunk 2 not used	CAMA trunk 2 used
07		CAMA trunk 1 not used	CAMA trunk 1 used
06			
05			
04			
03		No internal notification	Internal notification provided
02		CAMA trunk Control Disconnect	Normal disconnect
01		Seven CESID Digits	Ten CESID Digits

Program *11-0 Overview

This program enables E911 calls to be analyzed by the system for appropriate handling. The following assignments in Program *11-0 must be enabled to allow Enhanced 911 (E911) CAMA trunks to operate:

LED 11: CAMA Operation Enabled/Disabled

Led 11 must be turned ON to enable the E911 feature to operate.

LED 10~07: CAMA Trunk Circuits Enabled/Disabled

Up to four CAMA (RCMU/RCMS) trunks can be installed on Release 4.0 DK424 systems. Turn LEDs 07-10 ON to enable the appropriate CAMA trunks (1-4). RCMU/RCMS CAMA trunk circuit are numbered 1~4 from the bottom-up (see the front of the installed RCMU/RCMS). If only one RCMS is to be installed, place it on the bottom position of the RCMU. The Universal Slot PCB and Universal PCB Wiring chapters of the *DK14/40/424 Installation and Maintenance Manual* provides details regarding RCMU/RCMS PCB installation and circuit numbering.

LED 03: Internal Notification of E911 Calls Enabled/Disabled

To allow Attendant consoles and station DN's to be called along with the E911 CAMA trunk when a 911 call is made, LED 03 must be turned OFF. With this feature enabled, E911 calls will ring the CAMA trunk plus the Incoming Emergency (**IN-Ermg**) button on all Attendant consoles and the [DN] button ([PDN] or [PhDN]) designated in Program *11-8. The designated DN must be programmed to ring telephones in *71, *72, and *73, as required for each telephone on which the designated [DN] appears.

When this feature is used, the station or Attendant console that answers the E911 notification call will be connected in a three party conference with the E911 calling telephone and the E911 CAMA trunk (E911 dispatch person who answers the 911 call). The CESID information and user name of the 911 calling station displays on all Attendant Console monitors and E911 notification telephone LCDs when the E911 notification call rings.

LED 02: CAMA Trunk Disconnect Operation Options

After an E911 call is established, disconnecting the calling or notified telephone (or notified telephone/console) from the CAMA trunk can be controlled exclusively by the E911 trunk (dispatch person receiving the 911 call).

The disconnect operation for each option is:

- ♦ **LED 02 OFF:** Allows either the E911 call originating telephone or 911 dispatcher to disconnect the CAMA trunk. In the following example, conversation exists between originating telephone, notified telephone/console and the E911 CAMA trunk dispatch person.

E911 originator hangs up and disconnects.	The E911 notified station and the E911 CAMA trunk remain connected. The notified station can disconnect from the CAMA trunk.
E911 notified station hangs up and disconnects.	The E911 originating station and the E911 CAMA trunk remain connected. Originating station can disconnect from the CAMA trunk.
E911 dispatcher hangs up and disconnects.	All parties are disconnected, CAMA trunk goes idle.

- ♦ **LED 02 ON:** Enables E911 call disconnect to be exclusively controlled by the dispatch person receiving the call on the E911 CAMA trunk. In the following table, conversation exists between originating telephone, notified telephone/console and the E911 CAMA trunk dispatch person.

E911 originator hangs up and disconnects.	The E911 notified station cannot disconnect from the E911 CAMA trunk.
E911 notified station hangs up and disconnects.	The E911 originating station cannot disconnect from the E911 CAMA trunk.
E911 dispatcher hangs up and disconnects.	All parties are disconnected, CAM trunk goes idle.

LED 01: Number of CESID location digits sent with E911 Calls

After 911 is sent out the CAMA trunk, Automatic Number Identification (CESID) location digits are sent out the CAMA trunk to identify the location of the station. The maximum number of CESID digits sent with each E911 call can be either 7-digits (LED 01 ON) or 10-digits (LED 01 OFF). CESID location digits are individually set in Program *12 for each station. Contact your local E911 CAMA trunk provider to determine the number of CESID digits required.

Program *11-1 – CAMA Trunk Group Line Assignments

Processor Type: All RCTUs (Release 4.0)

Program Type: System

Initialized Default: all LEDs OFF

* # * # 1 * 2 * 3 - Spkr * 1 1 Hold - Spkr 1 Hold - Spkr # # Hold - Spkr # # Hold

CAMA Trunk Group (01~08)

Line circuit number of CAMA trunk: Turn ON LED of line that corresponds to the CAMA trunk position in the system.

Processor	CO Line Range
DK14	001~004
DK40i	001~012
RCTUA	001~016

Processor	CO Line Range
RCTUBA/BB	001~048
RCTUC/D	001~144
RCTUE/F	001~200

CAMA Trunk Group	CO Line Numbers of CAMA Trunks			
01				
02				
03				
04				
05				
06				
07				
08				

Program *11-1 Overview

This program assigns lines to CAMA trunk groups. Each RCMU/RMCS line used must be assigned to one of the eight CAMA trunk groups using Program *11-1. The RCMU/RMCS system line number (not the CAMA trunk number, 1~4) is entered into the appropriate CAMA trunk group in this program. If CAMA trunks are not assigned in this program, the E911 CAMA feature will not operate.

When the RCMU/RMCS PCBs are installed, they assume the next four consecutive system CO line numbers. For example if a normal ground start line PCB, RGLU, is installed in slot 12, its system line numbers are 01~04. And, if the RCMU/RMCS is installed in slot 13, its line numbers are 05~08.

This program also allows any type (ground, loop, Tie, DID) line to be assigned in CAMA Trunk Groups. This is to allow 911 calls to be routed out normal CO lines in case the CAMA trunk(s) can not be accessed (busy or out of service). If the 911 call hunts from the CAMA trunk(s) in a CAMA Trunk Group to a normal CO line in a CAMA Trunk Group, the 911digits (dial pulses or DTMF tones) will be sent out the normal line without the station CESID information digits. The normal lines assigned in CAMA trunk groups can be assigned in Program 16 line groups as well.

It is recommended to always assign normal lines in CAMA Trunk groups to back CAMA trunks.

Program *11-2 – CAMA Trunk Group Hunting Assignments

Processor Type: All RCTUs (Release 4.0)

Program Type: System

Initialized Default: Blank

* # * # 1 * 2 * 3 - Spkr * 1 1 Hold - Spkr 2 [] [] [] Hold - Spkr # # Hold - Spkr # # Hold

Hunt from CAMA Trunk Group (01-08) ——— DATA = Hunt to CAMA Trunk Group (01-08)

Hunt from CAMA Trunk Group	Hunt to CAMA Trunk Group
01	
02	
03	
04	
05	
06	
07	
08	

Program *11-2 Overview

This program enables E911 calls to hunt for an idle line in a CAMA trunk group in the order assigned in this program.

If all lines in a CAMA trunk group are in use, a new 911 call that attempts to connect to a busy trunk group can hunt to another trunk group. If that group is busy, the call will hunt to another CAMA trunk group until an idle group is found. E911 calls will hunt for an idle line in a CAMA trunk group in the order assigned in this program. Within each CAMA trunk group, E911 calls will hunt the lines in that group from the lowest numbered line to the highest numbered line. This hunting operation is true if the lines in a CAMA trunk Group are CAMA trunks or normal CO lines.

E911

Program *11-5 – CAMA Digits Sent on 911 Calls

Processor Type: All RCTUs (Release 4.0)

Program Type: System

Initialized Default: 911

* # * # 1 * 2 * 3 - Spkr * 1 1 Hold - Spkr 5 Hold - Spkr # # Hold - Spkr # # Hold

SELECT = 5 CAMA digits sent if user dials 911 (911, 11, 1)
 Use LED button 01 to blank out 9 or 91

X (choose 1)	CAMA Digits Sent
	911
	11
	1

Program *11-5 Overview

This program specifies which digits (“911” or “11” or “1”) will be sent to the to CAMA trunk, when a user dials 911 or 9+911.

When a caller dials 911, the DK can send 911, 11, or 1 out the CAMA trunk before sending the CESID location digits set in Program *12. Normally it is required to send 911, but this will vary so you must check with the CAMA trunk provider to identify what to enter into this program. Digits sent on the CAMA trunk are multi-frequency (MF) tones, so they cannot be checked with a DTMF test set.

Program *11-6 – E911 Interdigital Timer

Processor Type: All RCTUs (Release 4.0)

Program Type: System

Initialized Default: Data, 2 seconds

*	#	*	#	1	*	2	*	3	-	Spkr	*	1	1	Hold	-	Spkr	6			Hold	-	Spkr	#	#	Hold	-	Spkr	#	#	Hold
---	---	---	---	---	---	---	---	---	---	------	---	---	---	------	---	------	---	--	--	------	---	------	---	---	------	---	------	---	---	------

SELECT = 6 DATA = interdigital time delay before routing calls after 9XX (01-15 seconds).

If X=1, timer resets
 If X=0, 2-9, digits are routed/sent normally

DATA (01-15 secs.)

Program *11-6 Overview

This program assigns the amount of time allotted for the E911 interdigital timer. When the E911 feature is enabled, the DK applies the E911 interdigital timer any time a user dials “9” as the first digit. This applies to any type of call originated from a [DN] when you dial 9XX or 9 + 9XX. After 9 is dialed as the first digit, the DK will wait the number of seconds set in this program before processing the dialed digit.

If “91” or “99” is dialed as the first and second digit, the system will wait the number of seconds set in this program before processing the dialed digits. If 91X is dialed, the system will route the call out the CAMA trunk if X=1 or it will process the call as a normal call if X=0 or 2-9.



1. When the CAMA trunk is connected to the Public Switched Telephone Network:
CESID digits may be: 0-NYY-XXXX

Note The hyphens are for clarity - do not try to program them in *12

0 = Information code expected from a PBX on E911 calls. This multi-frequency (MF) “0” digit is sent automatically by the DK digits are entered for the calling port in Program *12.

NYY = Office Code

XXXX = Station Directory Number

2. When the CAMA trunk is connected directly to the Public Safety Answering Point (PSAP) the CESID digits may be: NXX-NYY-XXXX

NXX = Area Code

...or the PSAP serving multiple area codes will substitute a single digit representing an area code.

NYY = Office Code

XXXX = Station Directory Number

3. If no digits are entered for a port in Program *12, the DK sends an MF digit of “2.”

Glossary

Term	Definition
AA	Auto Attendant (built-in or external). This feature acts as an automatic operator that directs incoming callers to stations by offering a menu of dialing prompts.
ACD	Automatic Call Distribution. Allows incoming calls to be distributed to a group of ACD agents. The ACD supervisor's LCD telephone displays ACD Agent and Group information which allows the supervisor to monitor calls and assist agents.
ACD/MIS	Automatic Call Distribution (ACD) with Management Information System (MIS).
ADM	Add-on Module— <i>See DADM.</i>
Amphenol Connector	A 25-pair connector typically used on a multi-button telephone set for interfacing cables to many electronic key and PBX systems.
ANI	Automatic Number Identification—Telephone number of the calling party is sent to the Strata DK system over incoming DID or tie lines. This feature is provided by some long distance telephone service companies.
B-channel	Used in ISDN. Data or voice information is transmitted on the B-channels of an ISDN line at 64kpbs. The B-channel refers to the frequency range of transmissions on a copper pair; it is a logical, rather than a physical channel. Also see BRI and PRI.
B8ZS	Bipolar 8 Zero Substitution.
BGM	Background Music—Allows customer-supplied music to be sent to telephone speakers and external speakers.
bps	Bits Per Second—Unit of measure that refers to the transmission speed (baud rate) of electronic signals. It is used when describing data interface unit and modem operation.
BRI	Basic Rate Interface—ISDN line with 2B + 1D channel. BRI lines can have a U-interface with RJ-11 jacks and single twisted pair wiring, or RJ-45 four pair S/T interface wiring.
CAMA	Centralized Automatic Message Accounting. A special trunk provided by the phone company or the E911 Public Safety Answering Point Agency.
CESID	Caller's Emergency Service Identification—Telephone number for specific station or station location which is sent to the CAMA trunk.

Term	Definition
CCVY	Call Center Viewer “Y” Connector—Enables two-way transmissions between the Strata DK and a host PC, or SMIS equipment, and one-way transmissions to other PCs. There are four ports on the Call Center Viewer Connector for one Strata DK, another master port, and two additional ports.
CLASS	Custom Local Area Signaling Services—Defines a number of features offered by local telephone companies.
CLID or CND	Calling Line Identification or Calling Number Delivery—Telephone number or name of the calling party sent to the Strata DK system over incoming ground or loop start CO lines. This feature is one of the “CLASS” features offered by some local telephone companies.
CO	Central Office—The facility which houses switching equipment that provides telephone service (CO lines, E & M tie lines, DID lines, Centrex lines, etc.) for the immediate geographical area.
CO Line	A term used to define the Strata DK system hardware circuits that connect to the Central Office network line pair. Each CO line, DID and tie line circuit is assigned a CO line number in system software.
CODECs	Coder/Decoder—Semiconductors that allow the system to process analog-to-digital and digital-to-analog conversions.
DADM	Digital Add-on-Module—Optional device that connects to 2000-series digital telephones to provide the telephones with 20 flexible feature buttons that can be assigned individually for Direct Station Selection, System and Personal Speed Dial, and CO line access.
D-channel	Used in ISDN. This channel transmits call control information (out-of-band signaling) for B-channels. The D-channel is a logical, not a physical channel.
DDCB	Digital Door Phone/Lock Control Unit—A peripheral hardware unit compatible with designated digital telephone circuits that supports optional door phones (MDFBs) and provides door lock control.
DDSS	Digital Direct Station Selection Console—A device that helps facilitate the processing of a heavy load of incoming calls. The DDSS connects only to designated digital telephone circuits, and is associated with a digital telephone.
DIL	Direct In Line—Refers to two-way, standard CO trunk lines that are assigned to a particular extension or hunt group.
DID Line	Direct Inward Dialing line.
DISA	Direct Inward System Access—A feature that allows an outside party to access the Strata DK system internal stations or outgoing CO lines without having to go through an operator or automated attendant. An optional security code may be set to prevent unauthorized access to outgoing CO lines for through system calling.
DK	Digital Key.

Term	Definition
DKAdmin	Toshiba's customer database programming and upload/download software package for Strata DK systems.
DKBackup	Toshiba's customer database upload/download software package for Strata DK systems.
DKT	Digital Telephone.
DKT2000 series	Toshiba proprietary digital telephones consisting of four models: two 10-button models with handsfree answerback and/or LCD display and two 20 button telephones with speakerphone or a speakerphone with LCD display.
DKSU14A	Strata DK14 Key Service Unit (KSU) with power supply. Equipped with two loop start CO line circuits and four digital telephone circuits built-in. Includes external page interface, MOH/BGM interface, power failure transfer and miscellaneous relay control.
DKSUB280 or DKSUB424	Base Cabinet—Unit that houses the Common Control Unit (RCTU), as well as six universal slots for station, line, and option PCBs. The Base Cabinet also contains a power supply that provides power for all of the stations and peripherals connected to the base cabinet PCBs.
DKSUE280 or DKSUE424	Expansion Cabinet—Optional unit that has six universal slots for station, line, and option PCBs. The expansion cabinet has a power supply that furnishes power for all of the stations and peripherals connected to the expansion cabinet PCBs. As many as five expansion cabinets can be added to the system.
DKSUBI40	Strata DK40i Base Key Service Unit (KSU) with power supply and battery charger. Equipped with eight digital telephone circuits built-in, and no CO line circuits. Includes external page interface, MOH/BGM interface, power failure transfer and miscellaneous relay control.
[DN]	Directory Number.
DNIS	Dialed Number Identification Service—Telephone number of called party is sent to the Strata DK over incoming DID or tie lines. This feature is provided by some long distance telephone companies.
DPFT	Power Failure/Emergency Transfer Unit—An optional backup unit that provides emergency service during power failures by automatically connecting up to eight standard telephones to designated CO lines.
DSS	Direct Station Selection—Feature which allows a telephone user (as well as a DSS console and ADM user) to call another station with the touch of a flexible feature button.
DTMF	Dual-tone Multi-frequency—Push-button tone dialing.
DVSU	A subassembly that equips a digital telephone with the capability to receive Speaker Off-hook Call Announce (OCA) calls. DVSU is not required to receive Handset OCA (HS-OCA).

Term	Definition
E911	Enhanced 911 operation that provides more complete locator information to the responding agency.
EKT	Electronic Telephone.
ESF	Extended Super Frame.
EOCU	Off-hook Call Announce Subassembly—An optional upgrade to the Electronic Telephone Interface Unit (PEKU) or Electronic Telephone/Standard Telephone Interface Unit (PESU) that enables properly configured telephones (see HVSU2) to receive Off-hook Call Announce (OCA) calls.
FCC	Federal Communications Commission—The federal agency which regulates the telecommunication industry. All Toshiba hardware is FCC listed or approved.
HDCB	Electronic Door Phone/Lock Control Unit—A peripheral hardware unit compatible with designated electronic telephone circuits that supports optional door phones (MDFBs) and provides door lock control.
HDSS	Electronic Direct Station Selection Console—A device that helps facilitate the processing of a heavy load of incoming calls. The HDSS console connects only to designated electronic telephone circuits, and is associated with electronic telephones.
HESB	External Speaker Box—A speaker/amplifier that can be configured with the system to provide a variety of functions, such as a paging speaker and/or Background Music (BGM) speaker.
HESC-65A	A cable used to connect an HHEU-equipped digital telephone or an HHEU-equipped electronic telephone to the external speaker box (HESB) for the Loud Ringing Bell feature.
HHEU	Headset/Loud Ringing Bell Interface—Subassembly that fits inside a digital telephone or a 6500-series electronic telephone to allow a headset or an external speaker box (HESB) to be connected to the telephone.
HPFB	Optional Reserve Power Battery Charger (DK14)—One or two can be connected to the power supply to maintain normal operation during a power failure.
HVSU2	Subassembly that fits into a 6500-series electronic telephone enabling it to receive Off-hook Call Announce (OCA) calls. The telephone must be connected to an Electronic Telephone Interface Unit (PEKU) or a Standard Telephone/Electronic Telephone Interface Unit (PESU) equipped with an Off-hook Call Announce Subassembly (EOCU) to receive OCA, and must have three-pair wiring.
IMDU	Remote Maintenance Modem Subassembly—A subassembly installed on an Option Interface Unit (PIOU or PIOUS) that allows the system to be connected with a remote administration/maintenance terminal or DK Admin/DK Backup personal computer.
ISDN	Integrated Services Digital Network.

Term	Definition
K4RCU3	Dual-Tone Multi-Frequency (DTMF) Receiver/ABR Tone Detector Unit—An optional PCB installed on the TMAU motherboard. The K4RCU3A must be installed to recognize Dual-Tone Multi-Frequency (DTMF) tones generated by a standard telephone (or any other device connected to a standard telephone circuit) and it is required for Direct Inward System Access (DISA) and DID. The K4RCU3A circuits are also used to detect busy tone for the Automatic Busy Redial (ABR) feature and must be installed to allow ABR to operate.
KCDU	CO Line/Digital Telephone Interface Unit (DK40i)—The KCDU has two loop start CO line circuits and four digital telephone circuits. The KCDU digital telephone circuits can support all but one of the devices supported by either the PDKU or Base Unit integrated digital telephone circuits: digital telephones, PDIU-DIs/PDIU-D12s, PDIU-DSs, ADMs, DDCBs and RPCIs.
KKYS	Modular add-on key or integrated circuit that installs onto the K4RCU3 to add the auto attendant feature to the DK40i.
KSTU2	The optional PCB provides four standard telephone circuits and it can only be installed in the base unit. The KSTU2 supports the two-wire devices such as standard telephones, Auto Attendant devices, voice mail machines, and facsimile machines. The KSTU2 can also support an alternate Background Music (BGM) source on circuit four.
LATA	Local Access and Transport Area.
LCD	Liquid Crystal Display—The optional display on digital and electronic telephones that displays calling information.
LCR	Least Cost Routing.
LDI	Long Distance Information.
LED	Light Emitting Diode—Status indicators located on printed circuit boards (PCBs), digital telephones, and electronic telephones.
LSI	Large Scale Integration—Related to circuit design technology. Strata DK system printed circuit boards (PCBs) use LSI circuit design.
MDF	Main Distribution Frame—The wiring frame usually located in a phone closet.
MDFB	Door Phone Box—A peripheral two-way speaker box option.
MOH	Music-on-Hold—Customer-supplied music or announcements can be sent to parties on-hold on CO lines or the intercom.
NDTU	Toshiba 30-foot cable that connects the RDTU to the KSU.
NT-1	Used in ISDN. Network Termination device that powers a U-interface ISDN line and enables multiple S/T ISDN devices to connect to it. The NT-1 must be UL-listed (U.S.) or CSA-certified (Canada).
OCA	Off-hook Call Announce. There are two types: Handset OCA and Speaker OCA.

Term	Definition
OPS	Off-premises Station.
PBTC	A Toshiba-supplied cable used to connect customer-supplied batteries to a cabinet power supply in a one- or two-cabinet system for emergency reserve power for the entire system.
PBX	Private Branch Exchange—Industry-standard term which refers to a telephone switch, usually on-premises, which serves an individual company, and is connected to a public telephone exchange through the Central Office (CO).
PCB	Printed Circuit Board.
PCM	Pulse Code Modulation—A widely-used form of digital telephone switching.
PCOU	CO Line Interface Unit—An optional PCB (an older version of RCOU) that provides the system with four loop start CO lines. Supports Caller ID when used with RCIU/RCIS circuits.
PDIU-DI2	Integrated Data Interface Unit—Replaces the normal digital telephone base so that the telephone can be used for the transmission and reception of data between a terminal/personal computer connected to the telephone and devices connected to other PDIU-DIs or to modems, printers, and computers which are in turn connected to PDIU-DSs. The PDIU-DI is also used to provide personal computer auto dialing of voice calls without a modem; and, access to outside dial-up data services and/or bulletin boards via modem pooling. Note Replaced by <i>RPCI-DI</i> .
PDIU-DS	Stand-alone Data Interface Unit—Used for modem pooling, printer sharing, and accessing host/mainframe computer.
PDKU2	Digital Telephone Interface Unit—An optional PCB that provides the system with eight digital telephone circuits. In addition to digital telephones, the PDKU can support data interface units (stand-alone and integrated), a digital DSS console (DDSS), RPCI, ADM, and a digital door phone/lock control unit (DDCB).
[PDN]	Primary Directory Number.
PEKU	Electronic Telephone Interface Unit—An optional PCB that provides the system with eight electronic telephone circuits, which can support electronic telephones, a Background Music source, a door phone/lock control unit (HDCB), an electronic DSS console (HDSS), and amplifiers for two CO-line conference calls. The PEKU is also used with older Strata systems.
PEMU	E & M Tie Line Unit—An optional PCB (an older version of REMU) that provides the system with support for four E & M Type I tie lines. The PEMU is also used with older Strata systems.
PEPU	External Page Interface Unit—An optional PCB that provides support and/or circuit interface mainly for optional hardware peripherals and upgrades associated with external paging functions.

Term	Definition
PESU	Standard/Electronic Telephone Interface Unit—An optional PCB that provides the system with a combination of two standard and four electronic telephone circuits. The standard telephone circuits can support standard telephones and optional hardware peripherals, such as voice mail devices and fax machines. Except for the electronic DSS console, the PESU electronic telephone circuits can support the same stations and peripherals that the PEKU does. The PESU is also used with older Strata systems.
[PhDN]	Phantom Directory Number.
PIOU	Option Interface Unit—An optional PCB that provides support and/or circuit interface for optional hardware peripherals and upgrades.
PIOUS	The same as the PIOU, with some exceptions; most notably, the PIOUS has one external paging interface zone, while the PIOU has four.
PORT	A term used to identify a station circuit or CO line circuit location.
PBTC1A-3M	Battery cable that connects reserve power batteries to cabinet RPSU280 power supplies (102 cabinet installations).
PPTC	A Toshiba-supplied adapter—An adapter that is used to connect: an SMDR device, ASCII maintenance terminal, or remote maintenance external modem.
PPTC	A Toshiba-supplied adapter—An adapter that is used to connect: the modular SMDR, SMDI, MIS for ACD, Open Architecture (OA), maintenance ports of the PIOU, PIOUS, RSSU, RSIU, or RSIS to the DB-9 (PPTC-9) connector of a call accounting machine, DK Admin, DK Backup personal computer (PC), SMIS personal computer or Open Architecture personal computer.
PPTC-9	Designed to connect directly to the DB9 connector of PC COM ports, while PPTC connects directly to an ASCII terminal female DB25, not a PC COM port male DB25.
PPTC-25F	Used to connect a Call Center Viewer PC or SMIS PC to the RS-232 Strata DK424 MIS port on the PIOU, PIOUS, RSIU, or RSSU.
PRI	Primary Rate Interface.
PSTU2	Standard Telephone Interface Unit—An optional PCB (an older version of RSTU2) with a built-in ring generator that provides interface for eight standard telephones or optional hardware peripherals (voice mail devices, Background Music source, fax machines, etc.). The PSTU2 has a square wave ring generator that can be set for 190V peak-to-peak or 130V peak-to-peak. The PSTU2 is also used with older Strata systems.
PSTN	Public Switched Telephone Network.
QCDU2	CO Line Digital Telephone Interface Unit (DK14)—Provides one CO line (loop start) circuit and two digital telephone circuits on each PCB. The QCDU2 interfaces with digital telephones, PDIU-DIs/PDIU-DI2s/RPCI-DI, ADMs connected to the telephones and PDIU-DSSs, but does not support a DDSS or DDCB console.

Term	Definition
QKYS	Auto Attendant Feature Key (DK14)—Provides built-in Auto Attendant software without Program 03 assignments and installs directly onto the QRCU3 PCB.
QSTU2	Standard Telephone Interface Unit (DK14)—Provides two standard telephone circuits (ports) and interfaces with standard telephones, Auto Attendant devices, separate BGM source connections, voice mail machines, and facsimile machines.
QRCU2	DTMF Receiver/ABR Tone Detector Unit (DK14)—Provides three circuits to receive DTMF tones (required for DISA and devices connected to QSTU2s), and three circuits to detect busy tone (required for the ABR feature).
RAM	Random Access Memory—Refers to the type of system memory that holds individual system configuration and feature programming. RAM is read/write memory, and can be easily revised in programming.
RATU	Attendant Console Interface Unit—Optional PCB that can support up to four attendant consoles and/or PC attendant consoles.
RBDB	Battery Distribution Box—Interface used to connect reserve power batteries to systems with three or more cabinets (also provides six RBTC1A-1.5M cables to connect RBDB to cabinet RPSU280 power supplies).
RBSU	ISDN Basic Rate Interface (BRI) Unit—Provides two circuits, each of which provide two simultaneous voice and/or data connections with a single interface. BRI uses the 2B+D transmission format which is defined as two 64-kbps bearer channels and one 16-kbps data (control channel). Available for DK424 with Release 4.1.
RBSS	ISDN Basic Rate Interface (BRI) Subassembly—Attaches to the RBSU to provide two additional BRI “U” circuits that can be used to connect to Network BRI lines and/or station-side connections only. Available for DK424 with Release 4.1.
RBTC1A-2M	Battery cable that connects reserve power batteries to RBDB battery distribution box (3 or more cabinet installations).
RBUU	ISDN Basic Rate Interface (BRI) Unit—Provides two BRI “U” circuits. Each circuit provides two simultaneous voice and/or data connections with a single interface. BRI uses the 2B+D transmission format which is defined as two 64-kbps bearer channels and one 16-kbps data (control) channel. Available for DK424 with Release 4.2.
RBUS	ISDN Basic Rate Interface (BRI) Subassembly—Attaches to the RBUU to provide two additional BRI “U” circuits that can be used to connect to Network BRI lines and/or station-side connections only. An RBUU with the RBUS subassembly provides four BRI “U” circuits in one card slot. Available for DK424 with Release 4.2.
RCMS	Enhanced 911 (E911) CAMA Trunk Direct Subassembly—Enables the DK424 (Release 4.0 and above) to connect to one or two CAMA trunks. Two RCMS PCBs enable connection to four CAMA trunks.

Term	Definition
RMCU	Enhanced 911 (E911) CAMA Trunk Direct Interface—Enables connection from the DK424 (Release 4.0 and above) to E911 locator services without third-party equipment. The RMCU supports two subassemblies (RCMS) that provide a total of up to four ports.
RCCB	Conduit Connection Box—Device required for floor-mounted systems with three or more cabinets to connect AC power and reserve power battery cabling to the system. Cabling from the AC power source and from the reserve power battery source can only be installed by a licensed electrician.
RCIU2/RCIS	Four-circuit plug-in PCB/four-circuit piggy-back PCB, each of which receives and decodes FSK Caller ID (CLID or CND) information from the Central Office ground or loops Caller ID lines. Each RCIU/RCIS circuit works in conjunction with a DK424 RGLU/RCOU/RCOS line PCB circuit.
RCOS	Loop Start CO Line Interface Subassembly—Optional subassembly that attaches to the RCOU PCB to provide four additional CO analog line circuits to the PCB. Supports Caller ID when used with RCIU/RCIS circuits.
RCOU	CO Line Interface Unit—An optional PCB that provides the system with four loop start CO lines. An optional RCOS subassembly can be attached to the RCOU for four more loop start analog CO lines. Supports Caller ID when used with RCIU/RCIS circuits.
RCTU	Common Control Unit—The system's controller PCB that contains the system's main microprocessor and microprocessor bus, ROM, RAM, time switch logic, busy tone detectors, system tones and MOH/BGM Interface. RCTUs include: RCTUA, RCTUB, RCTUBA/BB, RCTUC/D, and RCTUE/F. Each RCTU supports different station and line capacities. The RCTU PCBs also provide interface for the optional RRCS PCB and RKYS key.
RDDU	Direct Inward Dialing Interface Unit—Optional PCB that provides four analog Direct Inward Dialing line circuits. Supports ANI and DNIS.
RDSU	Digital/Standard Telephone Interface Unit—Optional PCB that provides two standard telephone and four digital telephone circuits in its basic configuration. An RSTS can be attached to the RDSU for two additional standard telephone circuits.
RDTU	T1/DS-1 Interface Unit—Optional PCB that provides up to 24-digital channels that can individually be assigned for loop start CO line, ground start CO line, E & M tie line, or DID line operation. Supports ANI and DNIS.
REMU	E & M Tie Line Unit—An optional PCB that provides the system with support for four E & M Type I or Type II, Immediate or Wink Start tie lines. Supports ANI and DNIS.
RFIF	Floor Mount Installation Kit—Kit that is used to floor mount systems.
RGLU	Analog Ground/Loop Start CO Line Interface Unit—Provides four CO line circuits that can be individually configured for loop start or ground start CO line operation. Supports Caller ID when used with RCIU/RCIS circuits.

Term	Definition
RKYS	Feature Key Upgrade—Subassembly that attaches to the common control unit to provide the system with optional features. There are four versions of the RKYS: the RKYS1, the RKYS2, the RKYS3 and the RKYS4, each of which provides a distinct set of features.
RMDS	Remote Maintenance Modem Subassembly—A subassembly installed on the RSIU Optional Interface Unit that allows the system to be connected with a remote administration/maintenance terminal or DK Admin/DK Backup personal computer.
RPCI-DI	Computer Data Interface Unit—Replaces the normal telephone base and provides all the functions of PDIU-D12. In addition, it can be switched to a second mode automatically and used with a Telephone Application Program Interface (TAPI) software application.
RPTU	ISDN Primary Rate Interface (PRI) Unit—Provides 1 data (control) channel and 23 bearer channels. All B-channels appear and program as CO lines in the DK424 system and can be individually configured for local service, FX, WATS, DID, tie, etc., service operation. Supported by the RCTUBA3/BB4, RCTUC3/D4 and RCTUE3/F4.
ROM	Read Only Memory—Refers to the type of system memory that holds static software that comprises the mechanics of the features' functions. ROM is only revised by Toshiba software engineers.
RPSB (1 and 2)	Power Strip—Interface between cabinet power supplies and the commercial AC power source. The RPSB provides outlets for three power supplies. One RSPS is required for systems with three or four cabinets, two or three RSPSs for five- or six-cabinet systems.
RPSU280	Cabinet Power Supply—Furnishes power to all of the stations and peripherals connected to the cabinet PCBs. Each Base and optional expansion cabinet has a separate power supply.
RRCS	Dual-tone Multi-frequency Receiver—An optional upgrade to the system common control unit (RCTU) that provides Dual-tone Multi-Frequency (DTMF) receivers for system Direct Inward System Access (DISA) CO lines, E&M tie lines, DID, DNIS and ANI lines, Auto attendant announcement devices, remote change of call forward-external destination, DNIS external call routing, and stations and other peripherals that connect to standard telephone circuits. The RRCS comes in three models: the RRCS-4 (provides four DTMF receivers), the RRCS-8 (eight DTMF receivers), and the RRCS-12 (12 DTMF receivers).
RSIS	Optional RS-232 Serial Interface Unit—A subassembly installed on the RSIU optional interface unit that allows the system to be connected to any of the following features: voice mail SMDI, MIS for ACD, SMDR, local DK Admin/DK Backup personal computer, external maintenance modem, Open Architecture personal computer.

Term	Definition
RSIU	Optional RS-232 Serial Interface Unit—An optional PCB that provides interface to any of the following features: voice mail SMDI, MIS for ACD, SMDR, local or remote DK Admin/DK Backup Personal computer, built-in (RMDS) or external system maintenance modem, Open Architecture personal computer. By itself, the RSIU PCB provides one interface port. With up to three RSIU/RMDS subassemblies, it can provide up to four interface ports.
RSTU	Standard Telephone Interface Unit—An optional PCB (an older version of RSTU2) with a built-in ring generator that provides interface for eight-standard telephones or optional hardware peripherals (voice mail devices, Background music source, fax machines, etc.). The RSTU has a built-in 80V RMS sine wave ring generator. The RSTU also has connectors for the R48S, which extends station loop length and is described in this section.
RSTU2	Standard Telephone Interface Unit—An optional PCB functionally identical to the RSTU. RSTU2 also contains a 90-volt DC message waiting/generator/switching circuit to operate standard telephone message waiting lamps.
RWBF1	Wall bracket Fixture—Bracket that is part of an installation kit (RFIF) that is used to floor mount systems.
RWIU/WWIS	Strata AirLink Wireless System Interface Unit—A proprietary PCB that enables wireless telephone functionality to Strata DK systems.
RFMF	Floor Mount Fixture—Fixture that is part of an installation kit (RFIF) that is used to floor mount systems.
R48S	Optional 48V Power Supply—Subassembly that can be connected to the RSTU or RDSU to extend the loop length of standard telephone circuits (including the resistance of the phone) from 600 ohms to 1200 ohms.
[SDN]	Secondary Directory Number.
SF	Super Frame.
SLT	Single-line Telephone.
SMDI	Simplified Message Desk Interface: RS-232 link from PIOU, PIOUS, RSSU, RSIS, or RSIU modular jack connected to a voice mail machine to provide Strata DK voice mail integration.
SMIS	Software MIS for ACD.
SSTU	Factory-installed sub-unit board that is “piggy-backed” onto the PSTU or PSTU2.
S/T Interface	Reference interface points (“S” or “T”) of an ISDN network. S/T interfaces are RJ-45, 8-wire connection interfaces for ISDN equipment. An NT-1 is needed to network U-type BRI lines to S/T type interfaces.
TAPI	Telephone Application Programming Interface.

Term	Definition
TA	Terminal Adapter or ISDN modem that converts PC and other types of protocol into a signal that works with ISDN. Generally, TAs support RJ-11 voice ports and RS-232C or V.35 or V.449 data interfaces.
T1/DS-1	<i>See RDTU.</i>
TCIU1	Caller ID—An optional PCB that provides the Caller ID option in the Strata DK424.
TCIU2	Caller ID—An optional PCB that provides the Caller ID option in the Strata DK40i.
TCOU	Four-Circuit Loop Start CO Line Board— An optional PCB providing four loop start CO line circuits in the Strata DK40i.
TDDU	Four-Circuit DID Line Digital Telephone Interface Unit— An optional PCB providing four DID line circuits in the Strata DK40i.
TE	Terminal Equipment. This refers to devices using ISDN service (telephones, faxes, computers, etc.). TE1 supports ISDN formats with S/T or U-type interfaces.
TSPI	Telephony Service Provider Interface.
TSIU	RS-232 Ports—An optional PCB that provides up to two RS-232 interface ports (modular jacks) enabling the DK40i to connect to various hardware devices.
TTY	Flexible RS-232 port which can be used for maintenance SMDI and MIS (ACD).
U Interface	A single twisted pair of copper wire on an RJ-11 jack. The wiring is identical to POTS, with different signaling. Only one U-interface device can be attached per line.
Universal slot	Slots in a telephone KSU/cabinet that are used for a variety of optional PCBs.
WSIU	Serial Interface Board (DK14)—Provides two serial ports for either a Station Message Detail Recording (SMDR) device or a maintenance terminal or modem, or Caller ID interface.

Index

A

- alert signal
 - button assignments, [3-118](#)
 - button programming example, [3-119](#)
- alternate background music source
 - slot assignment (see Program 19)
- attendant console
 - answer button priority assignments, [3-133](#)
 - display type, [3-132](#)
 - flexible button codes (see Program 59)
 - overflow destination assignments, [3-134](#)
 - overflow timer, [3-132](#)
 - series (DK424, see Program 58)
- auto attendant
 - built-in prompt/station assignments (see Program 09)
- automatic PCB recognition and port renumber (see Program 91-1)
- automatic preference (see Program 32)

B

- backup RAM initialization (see Program 92)

C

- cabinet type identification (DK424, see Program *03)
- call forward external (remote change, security) ID code (see Program 60-8)
- call forward station ring assignment (see Program *80), [3-174](#)
- call park pickup abbreviated dialing (see Program *05)
- caller emergency service identification (CESID), [8-1](#)
- caller ID / ANI
 - abandoned call number station owner assignments (see Program *52)

- caller ID circuit assignments to CO line PCBs (see Program *50)
- CAMA trunks
 - 911 (enhanced) trunks, [8-1](#)
- CO line
 - assign groups (see Program 16)
 - special ringing assignments (see Program 78)
 - tenant assignments (see Program *15)
- CO, DID, and tie line ring transfer (see Program 37)
- computer and data interface unit configuration (see Program 20)
- computer and DIU station hunting for data calls (see Program 22)
- credit card dialing (0+) (see Program 43)

D

- data transfer
 - from temporary memory to working memory (see Program 91-2)
- date, [1-15](#)
- day, [1-15](#)
- DID intercept port number (see Program *17)
- DID/tie line options (see Program 17)
- direct inward dialing parameters (see Program *64-1)
- directory number button assignments, [3-115](#)
- distributed hunt group member assignments (DK424, see Program *40)
- [DN] to [DN], tie to [DN], and DID to [DN] ringing assignments (see Program *71~*73)
- DNIS (see Program 71)
- DNIS number network table assignments (see Program 72)

- door phone
 - busy signal/door lock assignments (see Program 77-2)
 - to [DN] flashing assignments (see Program *79)
- door phone ringing (see Program 79)

E

- E911, [8-1](#)
 - CAMA
 - digits sent on 911 calls (see Program *11-5)
 - DK424 operation overview, [8-1](#)
 - trunk group
 - line assignments (see Program *11-1)
 - trunk group hunting (see Program *11-2)
 - CESID station information (see Program *12), [8-11](#)
 - E911/CAMA trunks (see Program *11-0)
 - interdigital timer (see Program *10-91)
 - interdigital timer (see Program *11-6)
 - pause before send timer (see Program *10-92)
 - programming overview, [8-3](#)
 - SMDR, [8-2](#)
 - special [DN] notification (see Program *11-8)
 - standard telephone ports assignment (see Programs *10-11 and *10-12)
 - station to CAMA trunk group (see Program *13)
- EKT and DKT ringing tones (CO line calls) (see Program 80)
- emergency bypass of forced/verified account codes (see Program 44-91~93)
- enhanced 911 (see Program *10)
- extension assignments (see Program *09)

F

- first-time programming, [1-14](#)
- fixed call forward (see Program 36)
- flexible access code numbering (see Program 05)
- flexible button assignments (see Program 39)
- flexible PCB cabinet slot assignments
 - DK424 (see Program 03)

G

- ground/loop/tie/DID line options (see Program 15)
- group pickup assignments (see Program *31)

H

- hardware requirements (minimum), [1-14](#)
- hold recall timing (see Program 34)

I

- initialization (system), [1-14](#)
- initialize Programs 00~*99 (see Program 90)
- Integrated Systems Digital Networking (ISDN), [7-1](#)
- internal and tie line call assignments, [3-17](#)
- ISDN
 - ACD and ISDN parameters, including BRI, PRI T-Wait and 3.1k audio (see Program 10-4)
 - analog trunk services (see Program *61)
 - assign CO line groups (see Program 16)
 - BRI line/station operation (see Program *60)
 - BRI SPID parameters (see Program *44)
 - call types for ISDN trunk group (see Programs *67-2 and *67-3)
 - call types for ISDN trunk groups (see Program *67-3)
 - call-by-call trunk group codes and network ID (see Programs *66-2, *66-4)
 - calling number ID presentation parameters (see Program *68-1)
 - channel group number parameters (see Program *66-1)
 - channel group/trunk parameters (see Program *66-3)
 - channel groups (see Program *65)
 - clock source (see Program *42)
 - CNIS presentation parameters (see Program *69-1)
 - D-channel control and NFAS (see Program *43-1~3)
 - dialing parameters (see Program *63)
 - DID/DNIS digits for trunk groups (see Program *64-2)
- LDN
 - registrations (see Program *66-5)
 - trunk group (see Program *66-7)
 - trunk group to channel group (see Program *66-6)
- line directory number (see LDN)
- network PRI interface (see Program *43-3)

non-facility associated signaling (see Program *43-2)
 non-ISDN station bearer service (see Program *62)
 outbound CNIS parameters (see Program *68-2)
 related programs
 ACD/ISDN parameters (see Program 10-4)
 attendant console feature buttons (see Program 59)
 least cost routing modified digits (see Programs 55-1 and 55-2)
 station class of service (see Program 30)
 system assignments, BRI lines (see Program 10-1)
 telephone feature buttons (see Program 39)
 special number assignment (see Program *69-2)
 trunk groups
 call direction (see Program *67-1)
 maximum channel reservation (see Program *67-4)
 trunk groups (see Program *16)

K

keystrip
 assignments
 2000-series digital telephone, 3-106
 template, 1-13
 types (see Program 38)

L

LCR, 4-28
 area codes (see Program 51)
 CO line programming reference table, 5-3
 conditions, 5-2
 dial 0 (zero) time-out (see Program 50-6)
 features, 5-1
 home area code (see Program 50-2)
 local call plan number (see Program 50-5)
 long distance information (LDI) plan number (see Program 50-4)
 modified digits table (see Program 55-0)
 modified digits table (see Program 55-1)
 office code exceptions for specified area code (see Program 52)
 parameters (see Program 50-1)
 route definition tables (see Program 54)

schedule assignments for LCR plans (see Program 53)
 special codes (see Program 50-3)
 station group assignments (see Program 56)
 LCR/toll restriction
 bypass for special numbers
 (see Program *45-2 (1~6))
 (see Program *45-3 (1~9))
 dial plan (see Program 45-1)
 special code dialing sequence with LCR (see Program *45-4)
 least cost routing (see LCR)

M

message center
 defining (see Program 13)
 minimum hardware requirements, 1-14
 modem pool port assignments (see Program 21)

N

night ringing over PIOU external page zones (see Program 77-3)
 numerical program listing, 1-1

P

park recall training (see Program *37)
 PBX centrex access codes (see Program 42-1~8)
 peripheral options (door phones), RSIU / RSIS / RMDS, PIOU/PIOUS / IMDU, PEPU (see Program 77-1)
 [PhDN] owner telephone assignment (see Program *33)
 Program *03 – DK424 cabinet type identification, 3-11
 Program *04 – [PhDN] assignments for internal and tie line calls, 3-17
 Program *05 – call park pickup abbreviated dialing, 3-22
 Program *09 – [PDN], [PhDN], DH, ACD or modem DID extension assignments, 3-25
 Program *09 – ACD group DID/tie line digit assignments, 6-5
 Program *10-11 – E911 standard telephone ports assignment, 3-39
 Program *10-12
 E911 standard telephone ports assignment, 3-39
 Program *10-91 – E911 interdigital timer, 3-40

- Program *10-92 – E911 pause before send timer, [3-40](#)
- Program *10 – enhanced 911 operation, [3-39](#)
- Program *11-0 – E911/CAMA trunks, [8-4](#)
- Program *11-1 – CAMA trunk group line assignments, [8-6](#)
- Program *11-2 – CAMA trunk group hunting assignments, [8-7](#)
- Program *11-5 – CAMA digits sent on 911 calls, [8-8](#)
- Program *11-6 – E911 interdigital timer, [8-9](#)
- Program *11-8 – 911 special [DN] notification assignments, [8-10](#)
- Program *12 – CESID station information, [8-11](#)
- Program *13 – station to CAMA trunk group, [8-13](#)
- Program *14-1 – auto answer with zip tone, [6-14](#)
- Program *14-2 – DID, tie, DNIS, ANI line after shift/overflow substitution destinations, [6-18](#)
- Program *15 – CO line tenant assignments, [3-47](#)
- Program *16 – ISDN trunk group type assignment, [7-7](#)
- Program *17 – DID intercept port number (vacant or wrong number), [3-53](#)
- Program *31 – group pickup assignments, [3-86](#)
- Program *32 – RS-232 voice mail message center port, [3-89](#)
- Program *33 – [PhDN] owner telephone assignment, [3-92](#)
- Program *34 – station class of service, [3-95](#)
- Program *36 – system NT button lock password changing station assignment, [3-102](#)
- Program *37 – park recall timing, [3-104](#)
- Program *40 for DK424 – distributed hunt group member assignments, [3-120](#)
- Program *41 for DK424 – T1 assignment series (part 1), [3-122](#)
- Program *42 – clock source for T1, ISDN –
 - Program *43-1~3 – D-channel control and NFAS assignments, [7-10](#)
- Program *43-2 – non-facility associated signaling (NFAS) assignment, [7-11](#)
- Program *43-3 – network PRI interface assignment, [7-12](#)
- Program *44 – BRI service profile identifier (SPID) parameters, [7-13](#)
- Program *45-1 – toll restriction for office codes, [4-23](#)
- Program *45-2 (1~6) – LCR/toll restriction bypass for special numbers, [4-24](#)
- Program *45-3 (1~9) – LCR/toll restriction bypass for special numbers, [4-26](#)
- Program *45-4 – special code dialing sequence with LCR, [4-28](#)
- Program *50 – caller ID circuit assignments to CO line PCBs, [3-126](#)
- Program *51 – station memory allocation for store caller ID / ANI, [3-128](#)
- Program *52 – caller ID / ANI abandoned call number station owner assignments, [3-130](#)
- Program *60 – BRI Line/station operation assignment, [7-14](#)
- Program *61 – analog trunk services for ISDN, [7-15](#)
- Program *62 – non-ISDN station bearer service, [7-16](#)
- Program *63 – ISDN dialing parameters, [7-17](#)
- Program *64-1 – direct inward dialing parameters, [7-18](#)
- Program *64-2 – number of DID/DNIS Digits for trunk groups, [7-19](#)
- Program *65 – ISDN channel group assignment, [7-20](#)
- Program *66-1 – channel group number parameters, [7-21](#)
- Program *66-3 – channel group/trunk parameters, [7-24](#)
- Program *66-5 – line directory number (LDN) registrations, [7-25](#)
- Program *66-6 – LDN/trunk group to channel group assignments, [7-26](#)
- Program *66-7 – LDN/trunk group assignment, [7-27](#)
- Program *67-1 – trunk group call direction, [7-28](#)
- Program *67-2 – call types for ISDN trunk group supported, [7-29](#)
- Program *67-3 – call types for ISDN trunk groups, [7-30](#)
- Program *67-4 – ISDN trunk groups maximum channel reservation, [7-31](#)
- Program *68-1 – calling number ID presentation parameters, [7-33](#)
- Program *68-2 – outbound CNIS parameters, [7-34](#)
- Program *69-1 – CNIS presentation parameters, [7-35](#)
- Program *69-2 – special number assignment, [7-36](#)
- Program *71~*73 – [DN] to [DN], tie to [DN], and DID to [DN] ringing assignments, [3-152](#)
- Program *79 – door phone to [DN] flashing assignments, [3-172](#)

- Program *80 – call forward station ring assignment, [3-174](#)
- Program 00-part 1 – software check, [2-12](#)
- Program 00-part 2 – RCTU RAM test, [2-15](#)
- Program 01-station logical port display and/or change, [3-1](#)
- Program 02 – station physical port display and/or change, [3-2](#), [6-3](#), [6-5](#)
- Program 03 – DK424 flexible PCB cabinet slot assignments, [3-6](#)
RSIU, RSSU, PIOU, PIOUS ACD/MIS slot assignments, [6-2](#)
- Program 04 – station logical port [PDN] assignment, [3-12](#)
- Program 05 – flexible access code numbering, [3-19](#)
- Program 09 – auto attendant prompt/ACD group, [6-3](#)
built-in auto attendant prompt/station assignments, [3-23](#)
- Program 10-1 – system assignments – part 1 of 3, [3-27](#)
- Program 10-2 – system assignments – part 2 of 3, [3-30](#)
- Program 10-3 – system assignments – part 3 of 3, [3-35](#)
- Program 10-4 – ACD/ISDN parameters, [6-6](#)
- Program 11 – ACD timing assignments, [6-8](#)
- Program 12 – system assignments, basic timing, [3-41](#)
- Program 13 – defining the message center, [3-43](#)
- Program 14-0 – loop/ground start line direct to ACD group assignments, [6-12](#)
- Program 14-1 – ACD agent ID code assignments, [6-13](#)
- Program 14-2 – ACD supervisor passwords, [6-17](#)
- Program 14-3 – announcement/music port and queue pattern, [6-20](#)
- Program 14-4 – queue time out overflow destination, [6-23](#)
- Program 14-5 – overflow point and ring no answer routing destination, [6-25](#)
- Program 14-6 – after shift service destination, [6-29](#)
- Program 14-71 – queue size for alarm, immediate assignments, [6-31](#)
- Program 14-72 – queue size for alarm 1, [6-32](#)
- Program 14-73 – queue size for alarm 2, [6-33](#)
- Program 14-8 – alarm pattern assignments, [6-34](#)
- Program 14-9 – work unit assignments, [6-35](#)
- Program 15 – ground/loop/tie/DID line options, [3-44](#), [6-36](#)
- Program 16 – assign CO line groups (dial 9 or 801~816), [3-48](#)
- Program 17 – DID/tie line options, [3-50](#), [6-36](#)
- Program 18 – agent names for SMIS/MIS assignments, [6-15](#)
- Program 19 – alternate background music source slot assignment, [3-54](#)
- Program 20 – computer and data interface unit configuration, [3-55](#)
- Program 21 – modem pool port assignments, [3-58](#)
- Program 22 – computer and DIU station hunting for data calls, [3-60](#)
- Program 32 – automatic preference, [3-87](#)
- Program 33 – [PDN]/ [PhDN] station hunting (voice calls only), [3-90](#)
- Program 34 – hold recall timing, [3-94](#)
- Program 35 – station class of service, [3-97](#), [6-36](#)
- Program 36 – fixed call forward, [3-101](#), [3-109](#)
- Program 37 – CO, DID, and tie line ring transfer (camp-on) recall time, [3-103](#)
- Program 38 – digital and electronic telephone keypad type, [3-105](#)
- Program 39 – flexible button assignments, [3-111](#)
- Program 40 – station CO line access, [4-4](#)
- Program 41 – station outgoing call restriction, [4-6](#)
- Program 42-0 – CO line to PBX/centrex connection & access codes, [4-8](#)
- Program 42-1~8 – PBX/centrex access codes, [4-10](#)
- Program 43 – 0 + credit card dialing, [4-11](#)
- Program 44-1~8 – toll restriction/traveling class override codes, [4-13](#)
- Program 44-91~93 – emergency bypass of forced/verified account codes, [4-14](#)
- Program 45-1 – LCR/toll restriction dial plan, [4-14](#), [4-15](#)
- Program 45-2 – toll restriction disable, [4-19](#)
- Program 45-3~6 – special common carrier numbers & authorization code digit length, [4-20](#)
- Program 45-8~9 – toll restriction override code, [4-22](#)
- Program 46-10~80 – toll restriction class parameters, [4-33](#)
- Program 46-11~46-81 – toll restriction class (1~8) parameters, [4-35](#)
- Program 46-2~4 – toll restriction allowed/denied area codes assigned by class, [4-30](#)
- Program 47 – toll restriction exception office codes assigned by area codes (tables 1~16), [4-36](#)

- Program 48 – station toll restriction classification, [4-38](#)
 - Program 50-1 – LCR parameters, [5-4](#)
 - Program 50-2 – LCR home area code, [5-5](#)
 - Program 50-3 (1~5) – LCR special codes, [5-6](#)
 - Program 50-4 – LCR long distance information (LDI) plan number, [5-7](#)
 - Program 50-5 – LCR local call plan number, [5-8](#)
 - Program 50-6 – LCR dial 0 (zero) time-out, [5-9](#)
 - Program 51 – LCR area codes, [5-10](#)
 - Program 52 – LCR office code exceptions for specified area code, [5-12](#)
 - Program 53 – LCR schedule assignments for LCR plans, [5-14](#)
 - Program 54 – LCR route definition tables, [5-17](#)
 - Program 55-0 – LCR modified digits table, [5-19](#)
 - Program 55-1 – LCR modified digits table – add, [5-21](#)
 - Program 56 – LCR station group assignments, [5-23](#)
 - Program 58 – DK424 attendant console series (part 1), [3-132](#)
 - Program 59 – attendant console flexible button codes, [3-135](#)
 - Program 60 – SMDR data output options, [3-139](#)
 - Program 60-2~7 – SMDR output/account code digit length, [3-140](#)
 - Program 60-8 – call forward external (remote change, security) ID code, [3-142](#)
 - Program 69 – verified account codes, [3-143](#)
 - Program 70 – verified account code toll restriction assignments, [3-145](#)
 - Program 71 – DID/tie/DNIS/ANI lines, [6-36](#)
DNIS, [3-147](#)
 - Program 72 – DNIS number network table assignments, [3-154](#)
 - Program 74 – system NT button lock password, [3-156](#)
 - Program 76-1(X-Y) – TSIU and RSIU / RSIS / RMDS port assignments, [3-157](#)
 - Program 76-2 (X-Z) – TSIU and RSIU / RSIS / RMDS port assignments, [3-158](#)
 - Program 77-1 – peripheral options (door phones) – RSIU / RSIS / RMDS, PIOU/PIOUS / IMDU, PEPU, [3-159](#)
 - Program 77-2 – door phone busy signal/door lock assignments, [3-163](#)
 - Program 77-3 – night ringing over PIOU external page zones, [3-165](#)
 - Program 77-4 – RSIU open architecture (OA) data output assignments, [3-166](#)
 - Program 78 – CO line special ringing assignments, [3-168](#)
 - Program 79 – door phone ringing, [3-170](#)
 - Program 80 – EKT and DKT ringing tones (CO line calls), [3-173](#)
 - Program 90-initialize programs 00~*99, [2-4](#)
 - Program 91-1-automatic PCB recognition and port renumber, [2-6](#)
 - Program 91-2 – data transfer from temporary memory to working memory, [2-8](#)
 - Program 91-9-system initialization, [2-2](#)
 - Program 92-initializing misc. backup RAM, [2-9](#)
 - program listing
 - numerical, [1-1](#)
 - program sequence, [1-11](#)
 - programming
 - data variations, [1-12](#)
 - first-time, [1-14](#)
 - keystrip template, [1-13](#)
 - overview, [1-1](#)
 - section layout, [1-10](#)
 - programs
 - system and station, [3-1](#)
 - Programs *66-2 and *66-4-call-by-call trunk group codes and network ID, [7-22](#)
- ## R
- RAM test
 - RCTU (see Program 00)
 - RDDU, [6-1](#)
 - RSIU open architecture (OA) data output assignments (see Program 77-4)
 - RSIU, RSSU, PIOU, PIOUS ACD/MIS slot assignments (see Program 03)
- ## S
- set date, time and day, [1-15](#)
 - SMDR
 - data output options (see Program 60)
 - output/account code digit length (see Program 60-2~7)
 - software check (see Program 00)
 - special common carrier numbers and authorization code digit length (see Program 45-3~6)

station
 class of service
 (see Program *34)
 (see Program 35)
 CO line access (see Program 40)
 hunting (voice calls only, see Program 33)
 logical port
 [PDN] assignment (see Program 04)
 display and/or change (see Program 01)
 memory allocation for store caller ID/ANI (see Program *51)
 outgoing call restriction (see Program 41)
 physical port display and or change (see Program 02)
 toll restriction classification (see Program 48)
Strata AirLink
 Alert Signal, [3-118](#)
 DK424 PCB Codes, [3-7](#)
 Program 32, [3-88](#)
 Program 39, [3-112](#)
Strata DK
 how to program, [1-10](#)
 system
 and station programs, [3-1](#)
 assignments
 basic timing (see Program 12)
 part 1 of 3 (see Program 10-1)
 part 2 of 3 (see Program 10-2)
 part 3 of 3 (see Program 10-3)
 initialization, [1-14](#)
 (see Program 91-9)
 NT button lock
 (see Program *36)
 password (see Program 74)

T

T1
 assignment series
 (DK424, see Program *41)
 channel assignments, [3-123](#)
 clock source (see Program *42)
 span (RDTU) frame and line code
 assignments, [3-122](#)
 span primary timing reference assignments,
 [7-9](#)
 span receive level pad assignments, [3-125](#)
 span transmit level pad assignments, [3-124](#)
 time, [1-15](#)
 toll restriction

allowed/denied area codes assigned by class
 (see Program 46-2~4)
 allowed/denied local office codes assigned by
 class (see Program 46-6~8)
 class (1~8, see Program 46-11~46-81)
 class parameters (see Program 46-10~80)
 disable (see Program 45-2)
 exception office codes assigned by area codes
 (tables 1~16) (see Program 47)
 for office codes (see Program *45-1)
 override code (see Program 45-8~9)
 toll restriction/traveling class override codes (see
 Program 44-1~8)
 TSIU and RSIU / RSIS / RMDS port assignments
 (see Program 76-1)
 (see Program 76-2 X-Y)

V

verified account code (see Program 69)
 verified account code toll restriction assignments
 (see Program 70)
 voice mail message center port (see Program *32)

Free Manuals Download Website

<http://myh66.com>

<http://usermanuals.us>

<http://www.somanuals.com>

<http://www.4manuals.cc>

<http://www.manual-lib.com>

<http://www.404manual.com>

<http://www.luxmanual.com>

<http://aubethermostatmanual.com>

Golf course search by state

<http://golfingnear.com>

Email search by domain

<http://emailbydomain.com>

Auto manuals search

<http://auto.somanuals.com>

TV manuals search

<http://tv.somanuals.com>