

Uniden®

UBC785XLT SCANNER

**1000 Channel
memory State of the art Base station scanner**

OWNER'S MANUAL

Contents

Introduction	1
Front and Rear View	4
UBC785XLT SHORTCUTS	6
Important Notice	8
Terminology	9
What is Scanning?	9
What is Searching?	9
Feature Highlights	10
Where to Obtain More Information	11
Information on the Internet	11
Included with Your Scanner Package	12
Setup	13
Connecting an Antenna	13
Mounting an Antenna	13
Optional Antenna	13
Typical Mounting Methods	14
Mounting the Scanner in Your Vehicle	14
Applying Power for Vehicle Installation	15
Desktop Installation	16
Applying Power Using Standard AC Power	16
Connecting an External Speaker	16
Connecting an Earphone	16
Listening Safely	17
Connecting the Clone Cable	17
Connecting the Tape Recorder	17
Basic Operation	18
Turn the Scanner On	18
Setting the Squelch	18
Understanding the Menu System	19
Menu Description and Numeric Keypad Equivalents	20
Programming	24
Storing Frequencies into Channels in Menu Mode	24
Deleting a Stored Frequency	25
Editing a Stored Frequency	25
Duplicate Frequency Alert	25
Transfer Frequencies	26
Storing Text Tags	26
Beep Alert	27
Programming Tips	27
Scanning	28
Scan Hold Feature	28
RF Attenuation Feature	29
Setting the Delay Mode for Frequency	29
Channel Lockout	30
Restoring a Locked-out Channel	31
Restoring All Locked-out Channels	31
Priority Scan	32
Changing the Priority Channel	32
Priority Channel Plus Scan	32
Searching	33
Setting a Search Range	33
Starting Chain Search	34
Search Hold Feature	34
Data Skip	34
Frequency Skip	35
Storing Search Frequencies	35
Auto Storing	36
Squelch (SQ) Mode	36
Additional Menu Options for Searching	38

Air Service Search	.39
Using Aircraft Service Search	.39
Air Service Search Skip	.39
Changing the step	.39
Remote Interface	.40
PC Control Mode	.40
Clone Mode	.41
Additional Features	.44
Care and Maintenance	.46
Troubleshooting	.47
Specifications	.48
Glossary of Terms	.49
Declaration of Conformity	.55

Introduction

The UBC785XLT is a state-of-the-art with automatic scanning capabilities. It can store frequencies such as police, fire/emergency, marine, railroad, air, amateur, and other communications into 10 banks of 100 channels for a total of 1000 channels.

Use your new scanner to monitor:

- Police and Fire Departments (including rescue and paramedics)
- Business/Industrial Radio
- Utilities
- Marine and Amateur (ham radio) Bands
- Air Band
- And much more...

The scanner has three band plans, which are useful for major regions in Europe.

To change the Band Plan, press and hold the band plan number **1**, **2** or **3** while turning On the scanner,

Note: This scanner remembers the last band plan.

The chart below identifies the scanner band numbers, the frequency range, the modulation mode and the default step size settings.

<Band Plan 1>

No.	Frequency Range (MHz)	Mode	Step (kHz)
1	25.0000 - 29.9950	FM	5
2	30.0000 - 79.9875	FM	12.5
3	80.0000 - 82.9900	FM	10
4	83.0000 - 87.2875	FM	12.5
5	87.3000 - 87.9500	WFM	50
6	88.0000 - 107.9500	WFM	50
7	108.0000 - 136.9875 108.0000 - 136.9916	AM	12.5 / 8.33
8	137.0000 - 137.9950	FM	5
9	138.0000 - 157.9875	FM	12.5
10	158.0000 - 160.5900	FM	10
11	160.6000 - 162.5875	FM	12.5
12	162.6000 - 173.9900	FM	10
13	174.0000 - 215.9500	WFM	50
14	216.0000 - 224.9950	FM	5
15	225.0000 - 399.9500	AM	50
16	400.0000 - 405.9875	FM	12.5
17	406.0000 - 439.9937	FM	6.25
18	440.0000 - 465.9950	FM	5
19	466.0000 - 469.9900	FM	10
20	470.0000 - 512.0000	FM	6.25
21	806.0000 - 960.0000	FM	12.5
22	1240.0000 - 1300.0000	FM	12.5

<Band Plan 2>

No.	Frequency Range (MHz)	Mode	Step (kHz)
1	25.0000 - 49.9950	FM	5
2	50.0000 - 84.0100	FM	5
3	84.0150 - 87.2950	FM	20 with 15kHz Offset
4	87.3000 - 107.9500	WFM	50
5	108.0000 - 136.9875 108.0000 - 136.9916	AM	12.5 8.33
6	137.0000 - 143.9950	FM	5
7	144.0000 - 145.9875	FM	12.5
8	146.0000 - 155.9900	FM	10
9	156.0000 - 157.4250	FM	12.5
10	157.4375 - 160.5875	FM	12.5
11	160.6000 - 162.0250	FM	12.5
12	162.0300 - 173.9900	FM	10
13	174.0000 - 215.9500	WFM	50
14	216.0000 - 224.9950	FM	5
15	225.0000 - 399.9500	AM	50
16	400.0000 - 405.9875	FM	12.5
17	406.0000 - 439.9937	FM	6.25
18	440.0000 - 449.9937	FM	6.25
19	450.0000 - 469.9900	FM	10
20	470.0000 - 512.0000	FM	6.25
21	806.0000 - 960.0000	FM	12.5
22	1240.0000 - 1300.0000	FM	12.5

<Band Plan 3>

No.	Frequency Range (MHz)	Mode	Step (kHz)
1	25.0000 - 29.9950	FM	5
2	30.0000 - 79.9937	FM	6.25
3	80.0000 - 82.9937	FM	6.25
4	83.0000 - 87.2937	FM	6.25
5	87.3000 - 87.9500	WFM	50
6	88.0000 - 107.9500	WFM	50
7	108.0000 - 136.9875	AM	12.5
	108.0000 - 136.9916		8.33
8	137.0000 - 137.9950	FM	5
9	138.0000 - 157.9937	FM	6.25
10	158.0000 - 160.5937	FM	6.25
11	160.6000 - 162.5937	FM	6.25
12	162.6000 - 173.9937	FM	6.25
13	174.0000 - 215.9500	WFM	50
14	216.0000 - 224.9950	FM	5
15	225.0000 - 399.9500	AM	50
16	400.0000 - 405.9875	FM	12.5
17	406.0000 - 439.9937	FM	6.25
18	440.0000 - 465.9937	FM	6.25
19	466.0000 - 469.9937	FM	6.25
20	470.0000 - 512.0000	FM	6.25
21	806.0000 - 960.0000	FM	12.5
22	1240.0000 - 1300.0000	FM	12.5



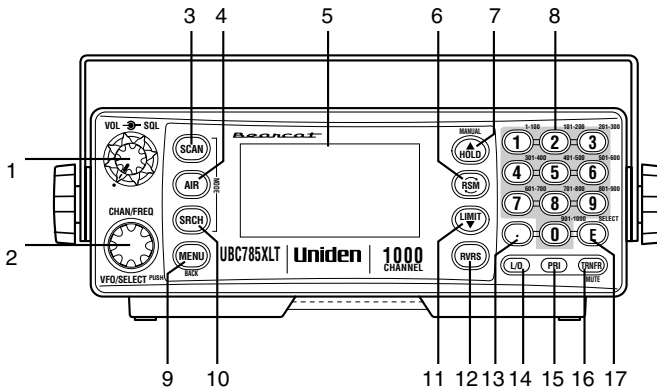

Front and Rear View

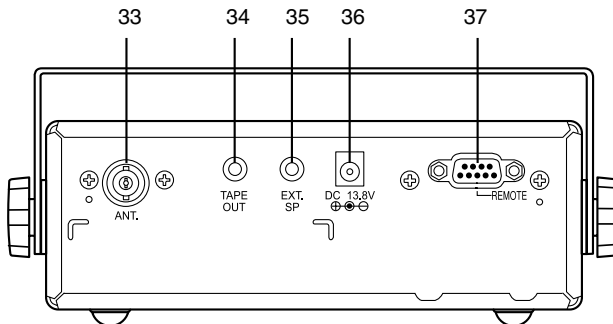

- | | |
|---|-------------------------------|
| 1. Volume/Squelch Control | 10. Search Key (SRCH) |
| 2. VFO/Select Channel/Frequency Control | 11. Limit/Down Key (LIMIT/▼) |
| 3. Scan Key (SCAN) | 12. Reverse Key (RVRS) |
| 4. Air Service Search Key (AIR) | 13. Decimal Key (.) |
| 5. Display | 14. Lockout Key (L/O) |
| 6. Resume Key (RSM) | 15. Priority Key (PRI) |
| 7. Hold/Up/Manual Key (▲/HOLD) | 16. Transfer/Mute Key (TRNFR) |
| 8. Numeric Keypad | 17. Enter/Select Key (E) |
| 9. Menu/Back Key (MENU) | |



- | | |
|-------------------------------|-----------------------------|
| 33. Antenna Connector | 35. External Speaker Jack |
| 34. Tape Recorder Output Jack | 36. DC Power Jack |
| | 37. Remote Control Terminal |

ICON	DESCRIPTION
	Priority Channel Indicator
	Lock Out Mode Indicator
	Scan/Search Direction Indicator
SRCH	Chain Search Mode Indicator
SRVC	Service Search Mode Indicator
SCAN	Scan Mode Indicator
AM,FM WFM,NFM	Receiving Mode Indicators
	Signal Meter

Uniden® and Bearcat® are registered trademarks of Uniden America Corporation.

UBC785XLT SHORTCUTS

To reduce the amount of information that is shown on the display, set up the "Screen Mask".

Press **MENU** + **3** + **2** + **1**.

To silence the keypad from sounding acknowledgement tones after each press, turn off the "Key Beep".

Press **MENU** + **3** + **3** + **2**.

To increase the backlight of the display, set the "Dimmer" to HIGH.

Press **MENU** + **3** + **1** + **1**.

To decrease the backlight of the display, set the "Dimmer" to MEDIUM.

Press **MENU** + **3** + **1** + **2**.

To prevent accidental reprogramming of frequencies lock out the keypad neat entry programming.

Press **MENU** + **3** + **4** + **1**.

To assign an alphanumeric text tag to a bank, choose the bank number; (for example; bank number 1).

Press **MENU** + **3** + **9** + **1**

then by rotating the **VFO** control to enter the text and using **▲/HOLD** or **LIMIT/▼** to the move cursor. After the text is entered, press **E**.

To reenter frequencies on a channel that had already been set;

(for example; replace the frequency on channel 5 to 155.000)

Press **SCAN** + **▲/HOLD** + **5** + **▲/HOLD** + **1** + **5** + **5** + **.** + **E**.

To receive an alert for activity on a specific channel, turn on the "Beep Alert" for that channel.

Press **MENU** + **2** + ^{select channel} + **E** + **4** + **1**.

This shortcut card is designed to assist you in getting through the menu screens using the direct entry mode for commonly used features. Please read the manual thoroughly before using this card. Be sure to back out of the menu screen after each shortcut by repeatedly pressing MENU or by pressing SCAN or SRCH keys.

UBC785XLT SHORTCUTS

To automatically store frequencies while searching, turn on "Auto Store" after setting up the search range.

Press **MENU** + **1** + **2** + **7** + **1**.

To change the alpha tag on the specific Search range of frequencies that you set, do the following:

Press **MENU** + **1** + **2** + **2** + **4**.

Rotate the **VFO** control to enter the tag and use **▲/HOLD** or **LIMIT/▼** to move the cursor forward or back and then press **E**.

To search a specific range of frequencies, set up the "Search Range".

Press **MENU** + **1** + **2** + **2**.

Then enter the lower and upper ranges and press **E** after each Frequency entered. To begin Searching between the Range, press **SRCH**.

To change the alpha tag on a specific channel, do the following:

Press **MENU** + **2** + *select channel* + **E** + **1** + **E**.

Rotate the **VFO** control to enter the tag and use **▲/HOLD** or **LIMIT/▼** to move the cursor and then press **E**.

To attenuate a specific channel that you set, do the following:

Press **MENU** + **2** + *select channel* + **E** + **5** + **1**.

To program and control your scanner remotely from a PC using Uniden's E-Scanner third party software, do the following:

Press **MENU** + **3** + **5** + *select speed*

To silence the scanner's audio output, set the scanner to "Mute On".

Press and hold **TRNFR**.

Important Notice

- The installation, possession, or use of this scanning radio in a motor vehicle may be prohibited, regulated, or require a permit in certain states, cities, and/or local jurisdictions. Your local law enforcement officials should be able to provide you with information regarding the laws in your community.
- Changes or modifications to this product are strictly prohibited or operation of this product in any way other than as detailed by this Owner's manual. Could void your authority to operate this product.
- The screen displays used in this manual are representations of what might appear when you use your scanner.

Terminology

What is Scanning?

Unlike standard AM or FM radio stations, most two-way communications do not transmit continuously. The UBC785XLT scans the Frequencies you have programmed into the Scanner's channels you program until it finds an active frequency.

Scanning stops on an active frequency and remains on that channel as long as the transmission continues. When the transmission ends, the scanning cycle resumes until another transmission is received.

What is Searching?

The UBC785XLT can search each of its 22 bands to find active frequencies. This is different from scanning because you are searching for frequencies that have not been programmed into your Scanner's channels. The scanner automatically chooses between two speeds while searching. Turbo Search can search the VHF FM bands at up to 300 steps per second (while 5 kHz only).

Feature Highlights

- **1000 Channels** – Program one frequency into each channel. You must have at least one channel programmed to use the Scan mode.
- **22 Bands** – Includes 22 bands, with aircraft and 800 MHz.
- **25 MHz-1300 MHz** – Indicates the range of frequencies that can be searched within the bands of your scanner.
Note: The frequency coverage is not continuous and excludes 512-806 MHz and 960-1240 MHz.
- **10 Priority Channels** – You can assign one priority channel in each bank. Assigning a priority channel allows you to keep track of activity on your most important channel(s) while monitoring other channels for transmissions.
- **Priority Plus Scan** – Allows you to scan only priority channels.
- **Air Band Service** – Allows you to search the aircraft frequencies at the press of a button, and to choose the step from 12.5 kHz or 8.33 kHz.
- **Unique Data Skip** – Allows your scanner to skip unwanted data transmissions and reduces birdies.
- **Memory Backup** – If power is disconnected, the frequencies programmed in your scanner are retained in memory.
- **Direct Channel Access** – Go directly to any channel without entering the Menu mode.
- **Attenuator** – Reduces the signal strength on a per frequency basis.
- **Turbo Search** – Increases the search speed to 300 steps per second. This applies only to transmission bands with 5 kHz steps.
- **Text Tags** – You can customize your scanner by storing text tags (up to 16 characters).
- **Auto Store** – The scanner automatically stores found active frequencies into an assigned bank.
- **CTCSS/DCS** – The scanner can receive and search for subaudible tones.

Where to Obtain More Information

Before using your scanner, you must program frequencies into available channels.

To obtain frequency information for your area, contact your local dealer:

Information on the Internet

If you have access to the internet, you may want to visit one of the following websites for additional information:

www.racescanner.eu

Included with Your Scanner Package

If any of these items are missing or damaged, immediately contact your place of purchase.

- UBC785XLT Scanner
- AC Adapter (AD 773)
- Cigarette Cord
- DC Cord
- Mounting Bracket
- Telescopic Antenna
- Operating Guide
- Other Printed Material

Setup

Connecting an Antenna

You must install an antenna before you can operate the scanner. You have been provided a standard telescopic antenna that works well with this scanner, but you may want to purchase another type to increase the range. To connect the telescopic antenna, simply connect it to the BNC type ANT. connector on the rear of the scanner. You can purchase a variety of scanner antennas for both mobile and base station available at a local electronics store. Choose the one that best meets your needs.

When deciding on a mobile or base station antenna and its location, consider these points.

- The antenna should be as high as possible on a vehicle or a house.
- The antenna and its cable should be as far as possible from sources of electrical noise (ignition systems, gauges, and so on).
- The antenna should be vertical for the best performance.

Mounting an Antenna

Once you choose an antenna, follow the mounting instructions supplied with the antenna. Then route the antenna cable to the scanner.

The antenna connector on your scanner makes it easy to use the scanner with a variety of antennas, such as an external mobile antenna or an outdoor base station antenna.

Always use 50 ohm coaxial cable, such as RG-58 or RG-8, to connect an outdoor antenna. For lengths over 50 feet, use RG-8 low-loss dielectric coaxial cable. If your antenna's cable does not have a BNC connector, you will also need a BNC adapter (available at a local electronics store).

Follow the Installation instructions supplied with the antenna, route the antenna cable to the scanner, then connect it to the **ANT.** jack.

Warning: Use extreme caution when you install or remove an outdoor antenna. If the antenna starts to fall, let it go! It could contact overhead power lines. If the antenna touches a power line, contact with the antenna, mast, cable, or guy wires can cause electrocution and death. Call the power company to remove the antenna. DO NOT attempt to do it yourself.

Optional Antenna

If you have chosen an optional mobile antenna, connect the antenna plug into the **ANT.** connector on the rear of the scanner. (For more information on antenna installation, please refer to the instruction guide that came with your antenna.)

Typical Mounting Methods

The UBC785XLT can be conveniently mounted on a table, bulkhead, overhead, or any other desired location (refer to figure below for typical mounting methods).

Caution: Make sure there are no hidden electrical wires or other items behind the desired location before proceeding. Check that free access for mounting and cabling is available.

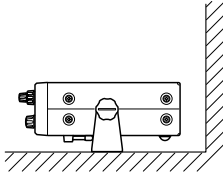

• Table top mount

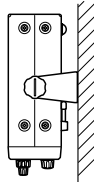

• Bulkhead mount

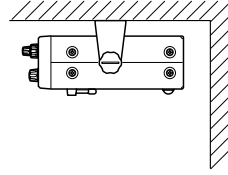

• Overhead mount

Mounting the Scanner in Your Vehicle

Before you mount the scanner, make sure you have all the necessary materials. Then confirm that the scanner fits your vehicle's mounting area. This unit requires a mounting area of 2-3/8 inch high by 6-15/16 inch wide by 6-9/16 inch deep (61 x 176.5 x 167 mm).

Caution: Be sure to avoid obstructions behind the mounting surface.

Follow these steps to mount the scanner in your vehicle.

1. Choose a mounting location, then use the supplied mounting bracket as a template to mark the positions for the mounting screw holes.
2. In the marked positions, drill holes slightly smaller than the supplied screws.
3. Attach the mounting bracket to the mounting location using the supplied screws and lock washers.
4. Attach the scanner to the mounting bracket using the supplied mounting knobs.
5. Connect the antenna's cable to the **ANT.** connector on the back of the scanner.

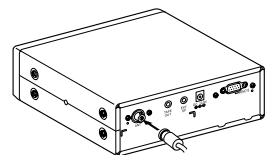
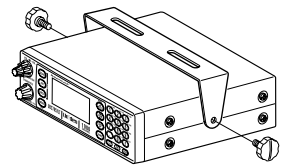
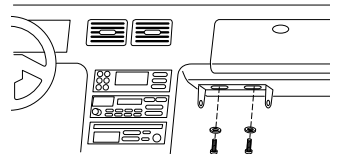

Note: If the antenna cable's connector does not fit in the **ANT.** connector, you might also need a Motorola-to BNC antenna plug adapter (available at a local electronics store).

Applying Power for Vehicle Installation

You can power your scanner using either the supplied DC power cord or your vehicle's cigarette lighter socket using DC cigarette lighter power cord.

Caution: You must use a power source that supplies 13.8 V DC and delivers at least 700 mA. Your standard 12 V car battery should be sufficient. The cord connector's center tip must be set to positive and its plug must fit the scanner's **DC 13.8 V** jack. The supplied DC power cord meets these specifications. Using a power cord that does not meet these specifications could damage the scanner or the adapter.

- Always connect the adapter or DC power cord to the scanner before you connect it to the power source. When you finish, disconnect the adapter or DC power cord from the power source before you disconnect it from the scanner.
- For added safety and to protect your scanner, disconnect the cable from your vehicle battery's negative (-) terminal before you begin.

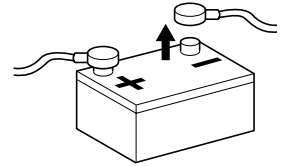

Follow these steps to connect the supplied DC power cord.

1. Connect the power cord's black wire to a chassis ground, such as a metal screw attached to a metal part of the vehicle's frame. Be sure that the screw is not insulated from the frame by a plastic part.
2. Connect the power cord's red wire (with in-line fuse) to a source of voltage that turns on and off with the ignition switch, such as a spare accessory terminal in your vehicle's fuse box.
3. Insert the power cord's barrel plug into the **DC 13.8 V** jack on the back of the scanner.
4. Reconnect the cable to the vehicle battery's negative (-) terminal.

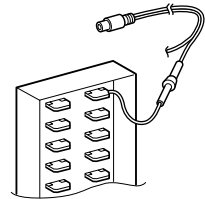

To power the scanner from a vehicle's 12 V power source (such as a cigarette-lighter socket), you need a cigarette-lighter adapter.

To connect an optional DC cigarette-lighter power cable, insert its barrel plug into the **DC 13.8 V** jack on the back of the scanner, then plug the power cable into your vehicle's cigarette lighter socket.

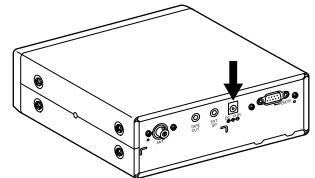

Note: If you use a cigarette-lighter power cable and your vehicle's engine is running, you might hear electrical noise from the engine while scanning. This is normal.

Desktop Installation

You can place this scanner on a desk, shelf, or table to use it as a base station.

1. Flip up the feet for desk installation.
2. Extend the antenna to full vertical position.
Adjust the angle for best reception.

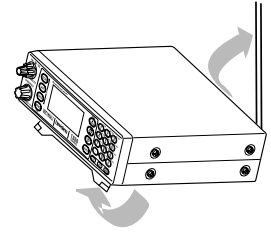

Applying Power Using Standard AC Power

To power the scanner from an AC outlet, use the provided AC adapter with a 5.5 mm outer diameter/2.1mm inner diameter tip.

Caution: You must use a Class 2 power source that supplies 13.8 V DC and delivers at least 700 mA. The cord connector's center tip must be set to positive and its plug must fit the scanner's **DC 13.8 V** jack. Using an adapter that does not meet these specifications could damage the scanner or the adapter.

- Always connect the AC adapter to the scanner before you connect it to AC power. When you finish, disconnect the adapter from the AC power before you disconnect it from the scanner.
1. Insert the adapter's barrel plug into the **DC 13.8 V** jack on the back of the scanner.
 2. Plug the adapter into a standard AC outlet.

Note: Use only the AC adapter supplied with your scanner.

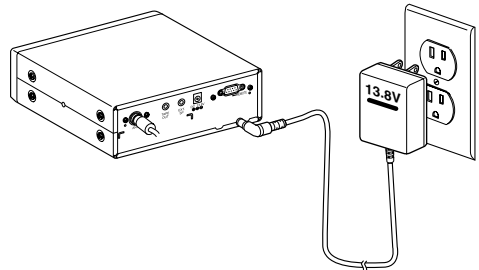

Connecting an External Speaker

In a noisy area, an external speaker (available at a local electronics store) positioned in the right place might provide more comfortable listening.

Plug the speaker cable's 1/8 inch (3.5 mm) plug into your scanner's **EXT. SP.** jack.

Note: Connecting an external speaker disconnects the scanner's internal speaker.

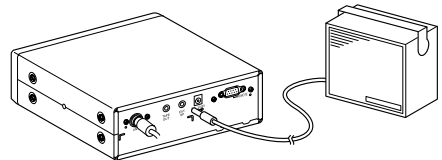

Connecting an Earphone

For private listening, you can connect an earphone with a 1/8 inch (3.5 mm) plug to the

EXT. SP. jack on the back of the scanner. **Be very careful as damage to your hearing can result if the VOL control is not set to the lowest level first.** See below for "Listening Safely" instructions. (Your local electronics store should carry a wide selection of earphones.) Once the earphone is connected, it will automatically disconnects the internal speaker.

Listening Safely

To protect your hearing, follow these guidelines when you use an earphone or headphones.

- Do not listen at extremely high volume levels. Extended high volume listening can lead to permanent hearing loss.
- Set the **VOL** to the lowest setting before you begin listening. After you begin listening, adjust the **VOL** to a comfortable level.
- Once you set the **VOL**, do not increase it. Over time, your ears adapt to the volume level, so a volume level that does not cause discomfort might still damage your hearing.

Connecting the Clone Cable

You can transfer the programmed data to and from another UBC785XLT scanner using a RS232C Cable (9 pin to 9 pin) (not supplied). Connect the cable between each scanner's **REMOTE** jacks. See "Clone Mode" on page 41. You can also upload or download the programmed data to or from a PC using an optional PC interface kit available through your local electronics store.

Connecting the Tape Recorder

You can use a standard tape recorder or a VOX (Voice Operated Control) recorder. To connect the recorder to the scanner, connect a cable with a 1/8 inch (3.5 mm) plug from the tape recorder's remote jack to the **TAPE OUT** jack on the back of the scanner. (Your local electronics store should carry a wide selection of cables and tape recorders.) Refer to the "Record" section under "Additional Features" in the manual.

Remember!

- You must mark a channel, ID, talkgroup, or bank for Recording in order for this feature to work.
- This feature does not work if your scanner is set with **MUTE ON**.

Basic Operation

Turn the Scanner On

Turn the **VOL** control clockwise out of the detent position. The scanner automatically starts scanning. Since there are no frequencies programmed in your scanner initially, you may not receive any signals. Once you set the squelch and program some frequencies, you will be hearing conversations regularly.

Setting the Squelch

To set the squelch, you must be in the hold mode, and you should not be receiving a signal on your scanner.

1. Press **▲/HOLD** until you do not hear a signal.
2. Make sure that the **VOL** is set to a comfortable listening level.
3. Think of the Squelch Control as a gate.
Turn the **SQUELCH** control fully counter-clockwise.
This raises the "Squelch Gate" so high that only very strong signals can get through.
4. Turn **SQUELCH** clockwise until you hear a hiss. This lowers the "Squelch Gate" so that everything gets through – noise, weak signals, medium signals and strong signals.

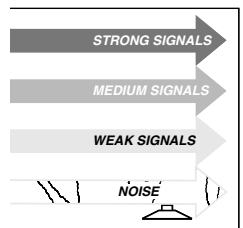
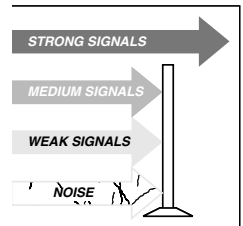

5. Turn **SQUELCH** back counter-clockwise just until the hiss stops.
Now the "Squelch Gate" allows only clear signals through.

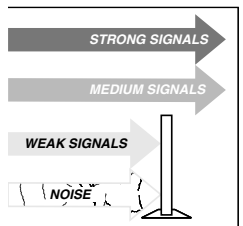

Next you must program some frequencies (page 24). It is recommended that you read the next part "Understanding the Menu System" because it will assist you in accessing and understanding many of the features. Later in a section called "Additional Features", you will find explanations on how to disable the keypad acknowledgement tones, to mute the audio, to change the appearance of the display and other general features.

Understanding the Menu System

It is very important for you to understand the Menu screen. To navigate through the Menu screen is really quite simple. Many of the features of this scanner, can only be accessed by the Menu screens. There are several ways to get through the screens. First of all, press **MENU** to get started. Anytime you want to exit this mode or simply quit from where you are, repeatedly press **MENU** until the scanner returns to the original state or you can press **SCAN** or **SRCH** to exit directly MENU MODE. Anytime you are in the Menu mode, the audio will be muted.

To assist you in understanding the Menu screen, flow charts are provided towards the back of the manual so you can follow along. Two things to remember are *rotate* the through the menu and press **E** or **VFO** to *execute* the command. For simplicity, we have chosen to rotate the **VFO** control up or down in order to *scroll* through the menu and the **E** key for *entering* or *executing* a command. Once you have pressed the **E** key and executed the final choice (for instance, **ON** or **OFF**), the display backs up to the previous level of options.

Also direct entry of the numbers in the flow chart will get you through the screens, but the other screen options are not visible. This method should be used only after you have gone through the manual at least once. Tearout shortcut cards (see pages 4 and 5) are provided to assist you in the direct entry method for commonly used features.

The illustration below shows the first level of the Menu screen. These levels are then provided in a flow chart on pages 52 to 54. You will find a description section to explain the meanings of these functions on the next pages. Then, you will be walked through all the steps of programming, scanning and searching.

Hint: You can check the options you programmed on the display when you press and hold **MENU** for 2 seconds in the following modes.

- Scan mode/Scan Hold mode.
- Chain Search mode/Chain Search Hold mode

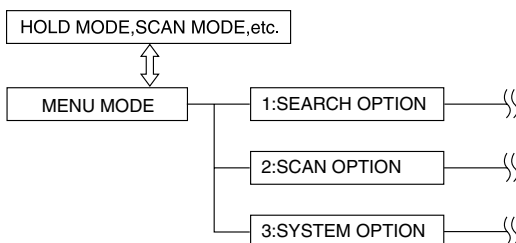

Menu Description and Numeric Keypad Equivalents

Below are the Menu screens and a brief description or purpose of the feature.

1:SEARCH OPTION

1:AIR STEP

You can select the air band step 12.5kHz or 8.33 kHz.

2:CHAIN SEARCH

1:CHAIN SEARCH

You need to turn Chain Search feature to ON if you use the Chain Search feature.

2:SEARCH RANGE

You can program up to 10 search ranges. The first time you program a range you will need to do so through the Menu. After the first time you can program a range as you do on most any other scanner, using the numeric keypad, ▲, ▼ and VFO control. Use this Menu item to select the search range that you want to program.

You can program range 1 through 10, one at a time. For each of the ranges, the following options can be modified.

1:RANGE

Enter the upper and lower frequency limits of the Search Range.

2:STEPS

You can assign a variety of step sizes to the search range.

Note: The default step is usually acceptable and is listed on page XX.

3:MODE

You can change the Auto receive mode to AM, FM, WFM and NFM.

4:ALPHA TAG

You can name to each channels and banks with up to 16 characters.

3:DELAY

Set the delay for the search ranges. This applies to all the ranges (See CHANNEL DATA-STEPS).

4:ATTENUATOR

If you are near an signal source which emits unusually strong signal, the scanner may be overloaded with its signal. Once overloaded, the scanner may keep stopping on that signal and miss other transmissions.

UBC785XLT comes with an RF Attenuation feature. It attenuates (reduces) the strength of an incoming signal in all modes to prevent stronger signals from overloading the scanner.

5:TONE DATA

The default mode is OFF. This means that you will receive all transmissions on any frequencies that are active within your search range(s). By selecting CTCSS (analog) or DCS(digital) subaudible tone you can set the radio to receive only a particular subaudible tone to be received during your search. You can also lockout a particular subaudible tone. You may wish to do this if you want to search a range but not hear transmissions on any frequency that has a particular subaudible tone.

Note: Through the System Menu you can set the radio to operate in Tone Search mode during Search as well. In this mode, the radio will automatically determine the active subaudible tone on any frequency received during the search.

6:RECORD

With this feature set to on, any frequency that is active during the search, can be recorded to an external tape recorder.

7:AUTO STORE

You can automatically store the active frequencies found during a search into the memory. You can select the bank to program. The audio will be muted.

2:SCAN OPTION

1:FREQUENCY

Allows you to program a frequency to a memory channel or edit the frequency already programmed. You can also set an alphanumeric text tag (alpha tag) for each programmed frequencies.

2:DELAY

You can set delay for the memory channel. The default delay is two seconds.

3:TONE DATA

You can set a CTCSS (analog) or DCS (digital) subaudible tone for a frequency. To do so you must have the SQ Mode in the System Menu set to Tone SQ. You can also program a subaudible tone easily by pressing the **E** key in Scan Hold mode after programming a frequency. This will bring up the Tone Data menu without having to navigate the Menu. By doing this you will receive all transmissions on the frequency, regardless of the subaudible tone, except the one which you have locked. Any transmissions with that tone will not be received.

4:BEEP ALERT

You can set a Beep Alert per channel to alert you when specific frequencies are active. For example, you may wish to be alerted anytime a mutual aid fire frequency is active. With Beep Alert, you will hear three beeps at the start of each transmission that you have flagged as such. You will also notice that as you scroll pass the flagged channel(s), you will hear three beeps.

5:ATTENUATOR

See 1: SEARCH OPTION/ 2:CHAIN SEARCH/ 4:ATTENUATOR.

6:STEPS

Your UBCD785D is programmed with default step sizes for each frequency range (see page 1). Steps are important if you are interested in using the **VFO** to tune off from a frequency programmed into memory or if you wish to program a frequency that the default step size will not accept.

7:MODE

Default Auto receive modes are also programmed into memory. AM for aircraft for example. You can change the default settings on a per-channel basis with this Menu item.

8:RECORD

You can flag any channel for recording using this menu function. Use your own recording device plugged into the jack on the back of the scanner.

3:SYSTEM OPTION

1:DIMMER

Allows you to change the brightness of the display.

2:SCREEN MASK

Screen Mask allows you to limit what appears on the display to the alpha tags that you have set for a channel along with a few function icons. Screen Mask removes the frequency, receiving mode tone data and signal strength bars. This mode is particularly useful in public safety vehicles where "information overload" is already a problem. Screen Mask does not work in Search mode.

3:KEY BEEP

Use this function to turn OFF the keypad acknowledgement beep. The default setting is ON.

4:ENTER LOCK

Use Enter Lock to prevent accidental re-programming of channels, tone (CTCSS/DCS) and talk groups entered into memory. The default setting is OFF.

5:PC CONTROL

Use this function to set the transfer speed (baud rate) at which your personal computer (PC) communicates with the scanner when downloading information into your scanner using Uniden E-Scanner software. See page 40 for details.

6:CLONE

You can clone all the programming, including frequencies and alpha tags as well as bank settings and other parameters from another UBC785XLT.

7:DATA SKIP

A scanner will normally stop on any transmission it receives. This means the UBCD785D will occasionally stop on data signals and unmodulated transmissions. You can automatically skip many of these types of transmissions during search.

8:SQ MODE

The SQ Mode allows you to set at your option, whether the scanner will stop on all active transmissions on a particular frequency or it will only respond to transmissions with a pre-set subaudible tone. This applies to both Conventional Search and Scan modes. The options are as follows:

1. CSQ - The default setting is CSQ (carrier squelch). In this mode the scanner will stop on any transmission on a programmed frequency.
2. TONE SQ - In Tone Squelch mode, if you have set a subaudible tone for a frequency, the scanner will only stop on that frequency if the transmission includes the prescribed tone.
3. TONE SEARCH - In this mode, as soon as the scanner stops on any channel, the scanner will begin to search for any subaudible tone that is being used on a transmitted frequency. The scanner will check each CTCSS tone sequentially and it will find DCS tones instantly.

9: BANK TAG

Allows you to set an alphanumeric text tag for individual banks in the scanner (1-10). (The "0" key represents Bank number 10.) For example, you may wish to set the Bank one text tag as Law Enforcement, the second bank as Fire, etc.

Programming

Before the UBC785XLT can begin conventional scanning, you must program a frequency into at least one channel.

Repeat this procedure for each channel you want to program.

Storing Frequencies into Channels in Menu Mode

1. Prepare frequencies you received from your dealer or from various sources on the internet.
2. Press **MENU**.
3. Select **2:SCAN OPTION** by rotating the **VFO** and pressing **E**.
4. Enter the channel number using the keypad, then press **E**.

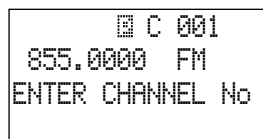

□ C 001
855.0000 FM
ENTER CHANNEL No

5. Select **1:FREQUENCY** by rotating the **VFO** and pressing **E**. Then enter the frequency.

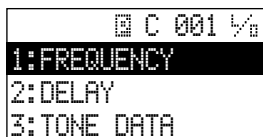

□ C 001 1/2
1:FREQUENCY
2:DELAY
3:TONE DATA

6. Enter the alpha tag and press **E**.
(See page 26.)

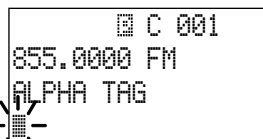

□ C 001
855.0000 FM
ALPHA TAG

7. The following display appears. Select the action by rotating **VFO**, then press **E**.

If you want to program other channel,
select **1:OTHER CHANNEL**.

If you want to set other settings for this channel,
select **2: CHANNEL OPTION**.

If you want to exit the menu, select **3:DONE**.



1:OTHER CHANNEL
2:CHANNEL OPTION
3:DONE

-  Remember! You can also use ▲ or ▼ instead of rotating the **VFO**. Also instead of pressing **E**, you can press the **VFO** control.

- Note:**
- You can also ▲ or ▼ when selecting a channel. Press and hold ▲ or ▼ for 1second to move up/down more quickly.
 - To clear a mistake while entering the frequency, press ○ (decimal key) repeatedly until the display is cleared.
 - If you enter a channel or frequency which is out of the scanner's range, a beep will sound and ERROR appears on the display.
 - For each channel, you can also change the step size or the mode. (See page 53).

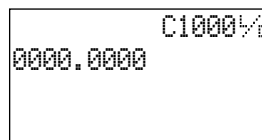
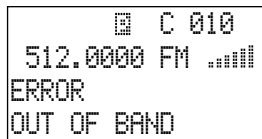
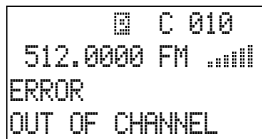

Deleting a Stored Frequency

1. Press **MENU**.
 2. Select 2:SCAN OPTION by rotating the **VFO** and pressing **E**.
 3. Select the channel number you want to edit by rotating the **VFO** and pressing **E**.
 4. Select 1:FREQUENCY using the keypad and pressing **E**.
 5. Press **0** and pressing **E**.
- ☞ Remember! You can also use ▲ or ▼ instead of rotating the **VFO**. Also instead of pressing **E**, you can press the **VFO** control.

Note: Channels with no frequencies are automatically locked out.

Editing a Stored Frequency

1. Press **MENU**.
 2. Select 2:SCAN OPTION by rotating the **VFO** and pressing **E**.
 3. Select the channel number you want to edit using the keypad and pressing **E**.
 4. Select 1:FREQUENCY by rotating the **VFO** and pressing **E**.
 5. Enter a frequency by using ○ (decimal key) and the keypad and pressing **E**.
- ☞ Remember! You can use ▲ or ▼ instead of rotating the **VFO**. Also instead of pressing **E**, you can press the **VFO** control.

Duplicate Frequency Alert

If you enter a frequency which has been stored in other channel, you will hear a beep and the scanner displays WARNING.

Press ○ (decimal key) to enter a different frequency.

— OR —

Press **E** again to store the frequency in both channels.

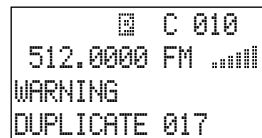

Transfer Frequencies

You can transfer a frequency that has been stored in a channel to another channel.

1. Press **▲/HOLD**.
2. Press **TRNFR**, and the smallest empty channel number along with the frequency will flash on the display.
If you want to transfer the frequency to other channel, select the channel by rotating the **VFO** or using **▲** or **▼** and pressing **E**.
3. Press **E** and the frequency can be stored in this channel.

Note: When the frequency is transferred, channel data (alpha tag, mode, attenuator, beep alert and tone data) are also transferred.

Storing Alpha Tags

You can customize your scanner by storing text tags for easy identification of banks, channel transmissions. The text tags can be set at the Menu mode. (Refer to “Understanding the Menu System” on page 19.)

Assigning a Bank Tag to a Bank

1. Press **MENU**.
2. Select **3:SYSTEM OPTION / 9:BANK TAG** by rotating the **VFO** or using **▲** or **▼** and pressing **E**.
3. Select the bank number by rotating the **VFO** or using **▲** or **▼** and pressing **E**.
4. The cursor appears on the display. Rotate the **VFO** to select the letter and then press **▲** or **▼** to move the cursor right or left. Both capital and lower case letters are available, as well as numbers and punctuation marks.
5. After entering the desired text, press **E**.

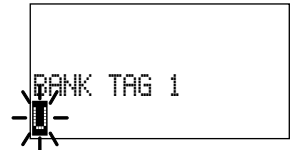

Assigning a Text Tag to a Channel

1. Press **MENU**.
2. Select **2:SCAN OPTION** by rotating the **VFO** or using **▲** or **▼** and pressing **E**.
3. Select the channel number by rotating the **VFO** and pressing **E**. You can also enter the channel number by using the keypad and pressing **E**.
4. Select **1:FREQUENCY** by rotating the **VFO** and pressing **E**.

Note: You can only assign a text tag to the channel where the frequency is stored.

5. **ALPHA TAG** and the cursor appear on the display. Rotate the **VFO** to select a letter, and press **▲** or **▼** to move the cursor right or left. Both capital and lower case letters are available, as well as numbers and punctuation marks.
6. After entering the desired text, press **E**.

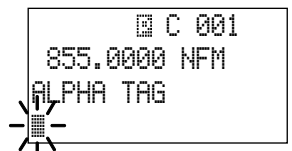

Remember! To enter a blank, press **⊙** (decimal key) twice.

Beep Alert

The scanner can alert you with three beeps at the beginning of a transmission on an assigned frequency.

Assigning the Beep Alert to a Channel

This alert can be set ON/OFF for every channel.

1. Press **MENU**.
2. Select **2:SCAN OPTION** by rotating the **VFO** and pressing **E**.
3. Select the channel number by rotating the **VFO** and pressing **E**. You can also enter the channel number by using the keypad and pressing **E**.
4. Select **4:BEEP ALERT** by rotating the **VFO** and pressing **E**.
5. Select **1:ON** or **2:OFF** by rotating the **VFO** and pressing **E**.

Note: If **NOT REGISTERED** appears, make sure a frequency is stored in the channel.

☞ Remember! You can also use **▲** or **▼** instead of rotating the **VFO**.
Also instead of pressing **E**, you can press the **VFO** control.

Programming Tips

- Group similar services into a bank. For example, program police frequencies in channels 1 through 10 and fire/emergency into channels 51 through 60, and so on.
- Put the frequency that you listen to the most or the most important frequency into a Priority channel.
- To quickly program a series of channels, start with the lowest number channel.
For example, when you are programming five new frequencies into channels 4 through 8, start with channel 4. After you finish programming a channel, rotate the **VFO** up or press **▲** to go to the next higher channel.
- Write down your programmed channels and frequencies and put them in a convenient place in case of accidental reprogramming.
- Frequencies are rounded off according to the step of each channel.
- When you are overwriting a tagged channel with a new frequency, the previous alpha tag will be deleted. Re-register the alpha tag.
- When programming frequencies, a 2 second delay is set automatically but can be changed in the menu mode.

Scanning

1. After programming frequencies, simply press **SCAN** to begin scanning. During scanning, when you rotate the **VFO**, you can select the direction (↑ or ↓) you want to scan.
2. The indicators of active banks appear on the display, and the bank being currently monitored flashes. You can deselect banks from active scanning by entering their number on your keypad. The deselected bank indicator changes to "-", and the bank's channels are not scanned.

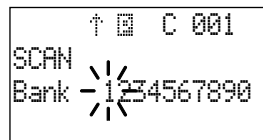

Note: At least one bank must be active. You cannot deactivate all ten banks at the same time. If you try to deselect all the banks, the first bank is automatically selected.

To restore a bank for active scanning, enter the bank's number on your keypad. The bank's indicator will be displayed again.

3. During normal scanning the scanner skips unprogrammed or locked out channels.
4. When a transmission is received, the scanner stops on that channel. When the transmission ends, scanning resumes automatically.

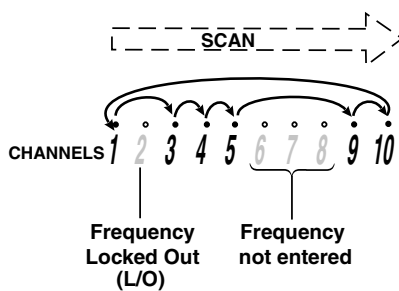

Scan Hold Feature

If you want to stop on a channel during scanning, press **▲/HOLD**.



Note: When you press and hold **SCAN** for 2 seconds, the scanner will move to the smallest empty channel.

If you want to resume scanning, press **RSM**.

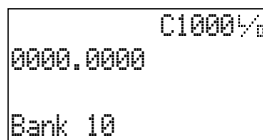

To directly access a specific channel:

There are several ways to access a specific channel quickly.

1. Press **▲/HOLD**.
2. Using the keypad, enter the channel number.
3. Press **▲/HOLD** again.

Another method is as follows:

1. Press **▲/HOLD**.
2. When the **VFO** setting is in the channel mode, rotate the **VFO** until the desired channel is displayed. The scanner will automatically go to Hold mode.

Note: When in Hold mode, you can use the **VFO** to step up or down through the channels. You can also switch from stepping up/down through channels to stepping up/down through frequencies by pressing the **VFO**.

RF Attenuation Feature

The UBC785XLT comes with an RF Attenuation feature. If you're near an unusually strong signal source, the signal may overload the scanner. The scanner may stop repeatedly on that signal and miss other transmissions.

The RF Attenuation feature works in all modes and attenuates (reduces) the incoming signal strength to prevent stronger signals from overloading the scanner.

1. Press **MENU**.
2. For Search mode, select 1: SEARCH OPTION / 2: CHAIN SEARCH / 4: ATTENUATOR by rotating the **VFO** and pressing **E**.

For Scan mode, select 2: SCAN OPTION by rotating the **VFO** and pressing **E**. Then select the channel number by rotating the **VFO** and pressing **E**. Select 5: ATTENUATOR by rotating the **VFO** and pressing **E**.

3. Select 1: ON by rotating the **VFO** and pressing **E**.

Note: Attenuation will only be active for the specified channel. In Search mode, it is applied to the Search ranges in all banks.

 Remember! You can also use ▲ or ▼ instead of rotating the **VFO**. Also instead of pressing **E**, you can press the **VFO** control.

Setting the Delay Mode for Frequency

When scan or search stops on a channel, there is a brief pause before resuming. A default delay of 2 seconds is automatically set for each frequency. If you want to change the delay period:

1. Press **MENU**.
2. For Scan mode, select 2: SCAN OPTION by rotating the **VFO** and pressing **E**.
3. Select the channel number of the stored frequency to be delayed by rotating the **VFO** and pressing **E**.
4. Select 2: DELAY and press **E**.
5. Rotate the **VFO** to select one of the delay periods and press **E**.
6. For Search mode, select 1: SEARCH OPTION / 2: CHAIN SEARCH / 3: DELAY by rotating the **VFO** and pressing **E**, then set to a delay period the same way as the Scan mode setting.

Note: The delay periods are as follows:

- None: Delay feature off
- 1 sec.: Delays for 1 sec. before re-scanning
- 2 sec.: Delays for 2 sec. before re-scanning
- 4 sec.: Delays for 4 sec. before re-scanning
- Infinite: Stays on until **RSM** is pressed
- -2 sec.: Stays for 2 sec. only before re-scanning *
- -5 sec.: Stays for 5 sec. only before re-scanning *
- -10 sec.: Stays for 10 sec. only before re-scanning *

* Setting negative delay periods are useful if you are only interested in small segments of conversations. For example: If you set a -5 second delay, you will only hear 5 seconds of the conversation and then the scanner will resume scanning, whether or not the conversation is finished.

☞ Remember! You can also use ▲ or ▼ instead of rotating the **VFO**. Also instead of pressing **E**, you can press the **VFO** control.

Channel Lockout

You can lockout any channel so it is not checked during scanning. The locked out channel can be restored.

Lockout in Hold Mode

1. Press ▲/**HOLD**.
2. Enter the channel number you want to lock out using the keypad, then press ▲/**HOLD** again.

— OR —

Rotate the **VFO** up or down to change the channel.

3. Press **L/O**. **L/O** appears on the display.

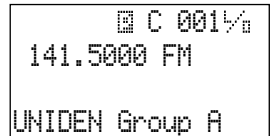

Lockout in Scanning Mode

If the scanner keeps stopping on a particular channel due to noise or frequent transmissions, you may want to keep that channel from scanning.

1. Wait until the scanner stops on the channel.
2. Then press **L/O**.
3. The scanner immediately resumes scanning because the locked out channel is no longer in the scanning sequence.

Lockout Tips Write down your locked-out channels and put in a convenient place in case you need to restore them.

Restoring a Locked-out Channel

1. Press **▲/HOLD**.
2. Select a locked out channel by using the keypad, then press **▲/HOLD**.
3. Press **L/O**. The **L/O** disappears.

Restoring All Locked-out Channels

You can restore all locked-out channels in a bank only when a bank is selected for scan. If you have deselected a bank and you want to restore all of its locked-out channels using the steps below, you must press **SCAN** and then enter the number of the bank on your keypad.

1. Press **▲/HOLD**.

Note: You must be in Hold mode before restoring all locked-out channels.

2. Press and hold **L/O** for about 2 seconds.
You will hear two beeps when all the channels have been restored.

Priority Scan

When Priority Scan is turned ON, your scanner checks the priority channel in the banks you selected every 2 seconds for activity. If a signal is present on the priority channel, your scanner monitors the channel until the transmission ends, then resumes normal scanning. You can designate one channel in each bank as a Priority Channel. By default, the first channel in each bank is the Priority Channel, but you can change this.

To activate Priority Scan (in either the Hold or Scan Mode):

1. Press **PRI** to select **PRIORITY ON**.

Note: If you have locked out the priority channel, **ERROR** appears when you select Priority mode.

2. Press **PRI** to select **PRIORITY OFF** to deactivate Priority Scan.



PRIORITY ON

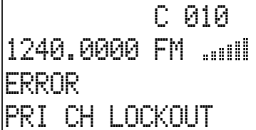

C 010
1240.0000 FM 
ERROR
PRI CH LOCKOUT

Changing the Priority Channel

You cannot eliminate the Priority Channel, but you can change it to any one of the 100 available channels in each bank.

1. Press **▲/HOLD**.
2. Select a new Priority Channel using the keypad, then press **▲/HOLD** again.
3. Press and hold **PRI** for 2 seconds to designate this channel as your new Priority Channel.
Two beeps indicates that the Priority Channel has been changed. The **F** icon appears on the display.



 C 005
512.0000 FM 
UHF TV 1
UNIDEN Group A

Priority Channel Plus Scan

You can scan only the Priority Channels (except for the locked out channels) in the banks you selected.

To activate Priority Channel Plus (Only in Scan mode):

Press **PRI** to select **PRIORITY PLUS**.

To deactivate Priority Channel Plus:

Press **PRI** to select **PRIORITY ON** or **PRIORITY OFF** on the display to deactivate Priority Channel Plus Scan.

Note: Priority or Priority Plus Scan are disabled while Search mode is selected.

Searching

Setting a Search Range

Note: First you must set the search ranges through the Menu screen prior to searching.

The UBC785XLT can search up to 10 separate frequency ranges to help you discover new stations in your area.

To set a Search Range, enter into the Menu mode.

1. Press **MENU**.
2. Select 1:SEARCH OPTION / 2:CHAIN SEARCH / 2:SEARCH RANGE by rotating the **VFO** and pressing **E**.
3. Select a range number by rotating **VFO** and pressing **E**.
4. Select 1:RANGE by rotating the **VFO** and pressing **E**. Enter the lowest frequency using the keypad and then press **E**. Then repeat the same step for the highest frequency, then press **SRCH**. The scanner starts searching. If an active search is detected, **SRCH** flashes.

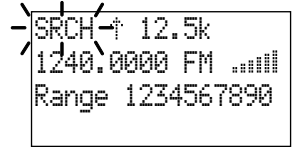

— OR —

1. Press and hold **SRCH** for 2 seconds.
 2. Select - range number - 1:RANGE and program the lowest and highest frequencies by the same way as step 3 and 4 above.
-  Remember! You can also use **▲** or **▼** instead of rotating the **VFO**. Also instead of pressing **E**, you can press the **VFO** control.

In Search Hold mode, you can change lowest and highest frequencies to the selected search range.

1. Press **▲/HOLD**.
2. Enter the lowest frequency using the keypad, then press **LIMIT/▼**.
3. Enter the highest frequency using the keypad, then press **LIMIT/▼**.
4. Press **SRCH**.

- Note:**
- The scanner can continuously search up to 10 ranges. (Chain Search)
 - You can select or deselect the search range freely by pressing the corresponding number with the keypad.
 - The scanner automatically increases its search speed from 100 to 300 steps per second for the bands having 5 kHz steps. (Turbo Search)
 - After you have set the search range through the Menu the first time for a range, you will be able to set new ranges for the same range by using the keypad and the standard direct entry method.

Caution: After you have entered the search range while still in the Menu mode, you can set your alpha tag (see page 26), change the step size of the search, or change the mode. Once the lower and upper parameters of your search are edited, the Menu screen backs up one level to allow you to modify the step size, receive mode, and alpha tag.

Select 2: STEPS for your step size choices and then press **E** or **VFO**. Select 3: MODE for the receiver mode choices and then press **E** or **VFO**.

Select 4: ALPHA TAG to enter an alpha tag using the **VFO** and then press **E**.

Starting Chain Search

1. After setting the search ranges, select 1: SEARCH OPTION / 2: CHAIN SEARCH / 1: CHAIN SEARCH by rotating the **VFO** and pressing **E**.

2. Select 1: ON by rotating the **VFO** and pressing **E**.

3. Press **SRCH** to search up to 10 ranges continuously.

☞ Remember! You can also use **▲** or **▼** instead of rotating the **VFO**. Also instead of pressing **E**, you can press the **VFO** control.

Note: • If CHAIN SEARCH is OFF, only 1 range can be searched.

- When searching stops, press **RSM** to resume searching.
- When you rotate the **VFO** while searching, you can change the search direction to up or down.
- When searching in WFM, it will stop before reaching the desired frequency if the step is other than 50 kHz or 100 kHz.

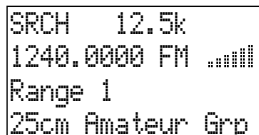

```
SRCH 12.5k
1240.0000 FM
Range 1
25cm Amateur Grp
```

Search Hold Feature

1. Press **▲/HOLD** or **LIMIT/▼** at anytime to stop the search.

2. Press **RSM** or **SRCH** to resume searching.

Data Skip

A scanner will normally stop on any transmission it receives. This means the UBC785XLT will occasionally stop on data signals and unmodulated transmissions. You can automatically skip many of these types of transmissions during search. To activate the Data Skip feature, enter into the Menu mode.

1. Press **MENU**.

2. Select 3: SYSTEM OPTION / 7: DATA SKIP by rotating the **VFO** and pressing **E**.

3. Select 1: ON by rotating the **VFO** and pressing **E**.

☞ Remember! You can also use **▲** or **▼** instead of rotating the **VFO**.

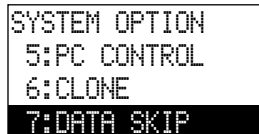

```
SYSTEM OPTION
5: PC CONTROL
6: CLONE
7: DATA SKIP
```

Also instead of pressing **E**, you can press the **VFO** control.

When Data Skip is active, your scanner may pause momentarily on an unwanted signal but will resume searching in 2 or 3 seconds. The Data Skip feature is active as well as Scan mode. Data Skip does not function during AM/WFM band Scan, Chain Search for AM/WFM band or Priority Scan.

Frequency Skip

If a particular frequency continues to interrupt search scanning, it is possible to set your scanner to skip the frequency.

To skip over a frequency, press **L/O** when stopping at the frequency you want to skip or when in Search Hold mode.

Note: • You can program up to 200 skip frequencies.

When the 201st skip frequency is programmed, the first frequency is automatically unlocked.

- If all frequencies in the search range are set to skip, a beep sounds and it moves to Search Hold mode.

To resume searching.

1) Cancel the Frequency Skip by pressing **L/O** at the frequencies you want to resume searching.

— OR —

2) Change the Search Frequency range.

To cancel all skipped frequencies, press and hold **L/O** for 2 seconds in Search Hold mode.

Storing Search Frequencies

You can quickly store any frequency you find during Search.

1. Press **▲/HOLD** or **LIMIT/▼** to stop searching, or when the scanner stops on the frequency you want to store, press **TRNFR**.
2. The smallest empty channel number flashes on the display. If you want to store the frequency to other channel, select the channel by rotating the **VFO** or using **▲** or **▼**.
3. Press **E**.

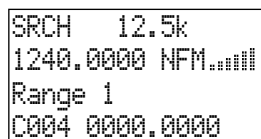

```
SRCH 12.5k
1240.0000 NFM
Range 1
0004 0000.0000
```

Note: • If the frequency you want to store exists already,

WARNING appears on the display and you will hear a beep. (See “Duplicate Frequency Alert” on page 25.)

- After storing the frequency, the scanner moves to the Search Hold mode.
 - If no free channel exists, the frequency you want to store will automatically be stored in the previous channel before you entered into Chain Search mode.
4. If you want to store other frequencies, resume search by pressing **SRCH** or **RSM**, then repeat the step 1 to 3.

Auto Storing

The scanner automatically stores active frequencies if its Auto Store feature is turned ON. But the frequencies already stored can not be stored. To make use of this feature, set a search range first (see page 33). If you start this feature without setting a search range, **NO LIMIT DATA** appears on the display.

1. Press **MENU**.
2. Select 1:SERVICE OPTION / 2:CHAIN SEARCH / 7:AUTO STORE by rotating the **VFO** and pressing **E**.
3. Select 1:ON by rotating the **VFO** and pressing **E**.

☞ Remember! You can also use ▲ or ▼ instead of rotating the **VFO**. Also instead of pressing **E**, you can press the **VFO** control.

```
AUTO STORE
SELECT BANK
12--56----
```

4. Select the bank number you want to store with the keypad. The selected bank number appears on the display.

Note: If the selected bank has no free channels to store, **CH DATA FULL** will appear on the display and you will hear a beep.

```
AUTO STORE
ERROR
CH DATA FULL
```

6. Press **SRCH** to start auto storing.
7. When the selected bank has no free channel, the scanner stop auto storing and **STORE END** appears. If you want to stop auto storing on the way, press ▲/HOLD.

```
↑ □ C 001
1245.8500 FM
Bank -12--56----
AUTO STORE
```

Squelch (SQ) Mode

The scanner has the following SQ modes.

- Carrier SQ mode (default setting)
The scanner will stop on any active frequencies or squelch opening, regardless of whether any subaudible tone has been programmed on your scanner for the channel or search range.
- Tone SQ mode
The scanner will stop on any active frequency for which you have not programmed any subaudible tone or whose subaudible tone is the same as the one you have programmed.
- Tone Search mode
When the scanner stops on an active frequency, the scanner will begin searching the subaudible tone used on the frequency one of which may also be in use. The scanner counts up through the CTCSS tones and instantly determines any possible DCS tone. See Page 51 for a listing of the tones that the UBC785XLT decodes.

Note: When Tone Search is active and the scanner finds the subaudible tone used on a frequency, **CTCSS** or **DCS** and subaudible tone flashes. You can press **E** to program that frequency with the found subaudible tone. When you change the mode to Tone SQ from Tone Search, you can confirm the frequency and subaudible tone has been programmed.

- Tone Lock (out) mode

You can lock a particular subaudible tone. The scanner won't stop on any transmissions which have the locked out subaudible tone.

To select the SQ mode:

1. Press **MENU**.
2. Select 3:SYSTEM OPTION / 8:SQ MODE by rotating the **VFO** and pressing **E**.
3. Rotate the **VFO** to select one the type from (1:CSQ, 2:TONE SQ, 3:TONE SEARCH) and press **E**.
4. To set Tone Lock mode, do the following first, then select 2:TONE SQ in step 3.
 - 1) For Scan mode, select 2:SCAN OPTION - select the channel number - / 3:TONE DATA / 1:CTCSS or 2:DCS by rotating the **VFO** and pressing **E**, than press **L/O**.
 - 2) For Search mode, select 1:SERVICE OPTION / :CHAIN SEARCH / 5:TONE DATA / 1:CTCSS or 2:DCS by rotating the **VFO** and pressing **E**, than press **L/O**.

 Remember! You can also use ▲ or ▼ instead of rotating the **VFO**. Also instead of pressing **E**, you can press the **VFO** control.

Note: • To unlock the tone, press **E** instead of pressing **L/O** on step 1) or 2).

- CTCSS: Continuous Tone Coded Squelch System.
- DCS: Digital Coded Squelch.
- When Search mode and Tone Search are selected, the display shows the frequency and tone data alternately.
- If the delay feature (-2 sec/-5 sec/-10 sec) has been set while in Tone search mode, it resumes scanning according to the delay period.

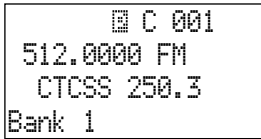

Tone SQ ON,
CTCSS 250.3 Hz setting

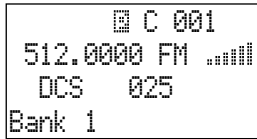

Tone SQ ON,
DCS 025 setting

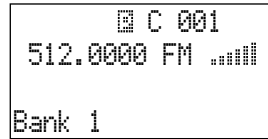

Tone SQ ON,
CTCSS & DCS
non-setting

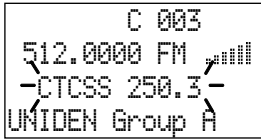

Tone Search,
CTCSS 250.3 Hz detect-
ing

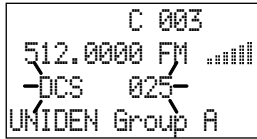

Tone Search,
DCS 023 detecting

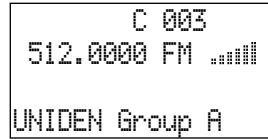

Tone Search,
no signal received

Additional Menu Options for Searching

Each of these additional menu options applies to all search ranges entered. If there is a range that you do not want an option to apply, then simply enter the range number on the numerical keypad. You will see the range number that you have selected disappears from the display. (For more information on these options refer to the "Menu Descriptions" section and "Additional Features" section.)

Options:

RECORD (for more information see page 17).

1. Press **MENU**.
2. Select 1:SERVICE OPTION / :CHAIN SEARCH / 6:RECORD by rotating the **VFO** and pressing **E**.
3. Select 1: ON by rotating the **VFO** and pressing **E**.

ATTENUATOR (for more information see page 29).

1. Press **MENU**.
2. Select 1:SERVICE OPTION / :CHAIN SEARCH / 4:ATTENUATOR by rotating the **VFO** and pressing **E**.
3. Select 1: ON by rotating the **VFO** and pressing **E**.

☞ Remember! You can also use ▲ or ▼ instead of rotating the **VFO**.
Also instead of pressing **E**, you can press the **VFO** control.

DELAY

Refer to page 29.

Air Service Search

Using Aircraft Service Search

You can search the aircraft frequencies by pressing **AIR**. If the scanner stops on an frequency, you can resume searching by pressing **RSM**.

Note: When you rotate the **VFO** while the Air Service Search is active, you can change the search direction to up or down.

Air Service Search Skip

You can set the scanner to skip the unwanted frequencies during Air Service Search. 100 skipped frequencies are programmable.

1. To skip over a frequency, press **L/O** when stopping at the frequency you want to skip.
2. To cancel a skip during search, press **▲/HOLD** or **LIMIT /▼**, select the desired frequency by rotating the **VFO** or using **▲** or **▼**, then press **L/O**.

To restore all skipped frequencies, press and hold **L/O** for 2 seconds.

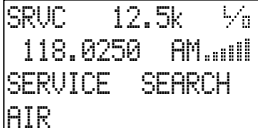

SRVC 12.5k 1/2
118.0250 AM.....
SERVICE SEARCH
AIR

Changing the step

You can choice the step of Aircraft Service Search between 12.5 kHz or 8.33 kHz.

To change the step:

1. Press [MENU].
2. Select 1:SERCH OPTION / 1:AIR STEP by rotating the **VFO** and pressing **E**.
3. Select 12.5kHz or 8.33kHz, then press **E**.

Remote Interface

You can communicate and program your UBC785XLT in numerous ways with peripheral devices using the Remote Interface Cable port (the serial cable is optional). This radio offers the following modes:

- ❖ PC Control mode
Program and control your scanner from a PC using optional ARC785 software.
- ❖ Clone mode
Clone all the frequencies into your scanner to another UBC785XLT.

PC Control Mode

To connect Scanner to PC:

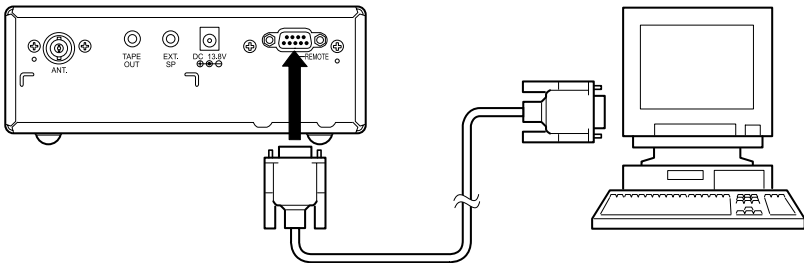

Plug the scanner end of the RS232C straight cable into the remote port which is on the rear of the scanner. Plug the other end of the cable (DB-9 serial connector) into a personal computer's serial port. A few PC's may require an adapter, most will not. Of course, make sure your PC is turned ON.

To program your scanner:

You can program and control your scanner remotely from a PC using optional ARC785 software.

After connecting the scanner to a PC, turn the scanner ON.

To use the Remote (PC Control) mode, you must install optional ARC785 software and use as directed. Make sure that your scanner is connected to the serial port of the PC using the RS232C straight cable.

Start Remote Mode and Change Transfer Speed:

Through the Menu system, select 3:SYSTEM OPTION / 5:PC CONTROL by rotating the **VFO** and pressing **E**. To start Remote mode, choose from the transfer speed list except for 5:OFF.



```
SPEED
3: 9600 bps
4: 19200 bps
5: OFF
```

A unique feature of the UBC785XLT is that all the front panel keys as well as the **VFO** on the radio remain operational in Remote mode.

For information on purchasing cables, connectors, and optional ARC785 software to program and control your UBC785XLT, please contact your distributor and / or you can contact the following :

www.racescanner.eu

PC Control Parameter

For your information:

Transfer speed : 2400/4800/9600/19200 bps (adjustable)
Start/Stop : 1 bit, 1 bit
Data Length : 8 bit
Parity bit : None
Code : ASCII code
Flow Control : None
Return Code : Carriage Return only

Clone Mode

You will need to purchase a RS232C straight cable a null modem adapter. RS232C straight cables are available as male to male or male to female. Even if the RS232C straight cable you buy already has the male to male connectors, you will still have to have the null modem adapter. On the next page you will see the pin connections that are internal to a standard device. (These items are available at your local electronics stores.)

To connect the Scanner to Scanner:

Plug the male end of the RS232C straight interface cable into the remote port on the rear of one of the two scanners. Then connect the DB-9 to DB-9 null modem adapter to the cable. Plug the other end of the null modem adapter into the other scanner. (DB9 Gender Changers are also available at your local electronics store.)

Null Modem Adapter Pin connections

Female DB9	Male DB9
1	4
2	3
3	2
4	6 & 1
5	5
6	4
7	8
8	7
9	Not used

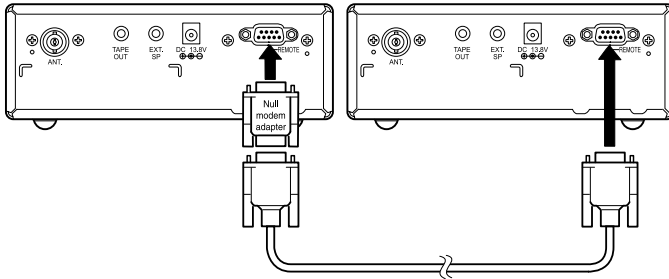

You can clone all of the programming of one UBC785XLT into another, including alpha tags, delay settings, etc. After connecting the two scanners, turn the radios ON. Prepare each scanner for clone mode as follows.

1. Press **MENU**.
2. Select 3:SYSTEM OPTION / 6:CLONE by rotating the **VFO** and pressing **E**.
3. Determine the scanner that has the frequency data that you want to transfer. This one must be set up as the "Master Unit", and the other must be set as the "Slave Unit".
4. On the scanner that is the "Master Unit", select **MASTER**, then press **E**.

```
CLONE
SELECT UNIT
MASTER
SLAVE
```

5. On the scanner that is the "Slave Unit", select **SLAVE**, then press **E**.

```
CLONE
SELECT UNIT
MASTER
SLAVE
```

6. Press **SCAN** on both scanners.
The data transfer begins from the Master Unit to the Slave Unit.
During the data transfer, both scanners show the following displays.

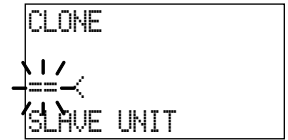
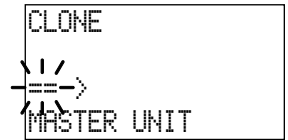

When the data transfer is complete, **COMPLETE** displays.

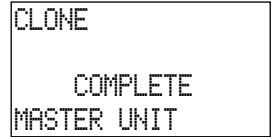

If the data transfer is not successful, the following error message will appear.

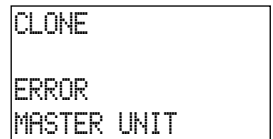

- Note:**
- To clear **ERROR**, press \ominus (decimal key).
To exit the Clone mode, press **MENU** repeatedly.
 - Once you have completed the cloning of the scanners, reset the scanners by turning the scanners OFF and then ON again. This is particularly important to know if you wish to clone another scanner right away.
-  Remember! You can also use **▲** or **▼** instead of rotating the **VFO**.
Also instead of pressing **E**, you can press the **VFO** control.

Additional Features

The following additional features are designed for you to customize your scanner. Once these features have been turned ON or OFF, they will remain as they are set until you reset them, even if you turn the scanner OFF and then ON again.

Dimmer

To change brightness of the display:

1. Press **MENU**.
2. Select **3:SYSTEM OPTION / 1:DIMMER** by rotating the **VFO** and pressing **E**.
3. Select one from **1:HIGH**, **2:MEDIUM** or **3:OFF** by rotating the **VFO** and pressing **E**.

Enter Lock

You can lockout the keypad to prevent re-programming of channels.

1. Press **MENU**.
2. Select **3:SYSTEM OPTION / 4:ENTER LOCK** by rotating the **VFO** and pressing **E**.
3. Select **1:ON** by rotating the **VFO** and pressing **E**.

Key Beep Option

To choose key beep sound **1:ON** or **2:OFF**:

1. Press **MENU**.
2. Select **3:SYSTEM OPTION / 3:KEY BEEP** by rotating the **VFO** and pressing **E**.
3. Select **1:ON** or **2:OFF** by rotating the **VFO** and pressing **E**.

Screen Mask

The frequency, receiving mode, and signal meter indications on the display are masked when this feature is activated (except while in Search mode). This feature reduces the amount of displayed information.

Note: While Screen Mask is ON, Enter Lock is active.

1. Press **MENU**.
2. Select **3:SYSTEM OPTION / 2:SCREEN MASK** by rotating the **VFO** and pressing **E**.
3. Select **1:ON** or **2:OFF** by rotating the **VFO** and then press **E**.

Note: With SCREEN MASK on, press the **VFO**, then SCREEN MASK will be off.

Reverse Mode

This key will allow you to observe the reverse frequency of the repeater. While pressing **RVRS**, the standard pair frequency will be displayed. For a list of the standard pair frequencies, refer to the table "Reverse List" in the Appendix. If the frequency that you have chosen does not have an offset frequency, the display will indicate **ERROR** and **NO REVERSE**.

Channel Step Selection

You can set frequency step, 5 kHz - 100 kHz or Auto in Chain search frequency. The default receive mode should be the proper mode setting in almost all cases. You may wish to set some VHF channels for NFM mode, depending on any adjacent channel interference problems. WFM is typically only used for broadcast frequencies, such as TV audio or FM radio.

See **STEPS** in "Menu Description" for details.

Mute On/Off

To manually turn ON the Mute function, press and hold **MUTE** until **MUTE ON** is displayed. You will not hear any audio. To turn it OFF, press and hold **MUTE** again.

Receiving Mode Selection

You can also set the receiving mode, AM or NFM in Chain Search mode.

See **MODE** in "Menu Description" for details.

Frequency and Channel Tuning with the VFO Control

The **VFO** knob can be used for stepping frequencies or through memory channels.

To switch the setting for the **VFO** control, press the **VFO**. This will change modes from Channel to Frequency or Frequency to Channel.

1. In scan hold mode, when the setting for the **VFO** is channel, rotate the **VFO** to move up (to step up through channels) or down (to step down through channels).
2. In Chain Search mode, when the setting for the **VFO** is frequency, rotate the **VFO** to move up to step up through frequencies sequentially or to down to step down through frequencies. To change the step, you will need to go into the Chain Search menu and adjust the step for the desired memory location.

 Remember! When you set Additional Features through the menu screen, you can also use **▲** or **▼** instead of rotating the **VFO**.
Also instead of pressing **E**, you can press the **VFO** control.

Care and Maintenance

General Use

- Turn the scanner OFF before disconnecting the power.
- Always write down the programmed frequencies in the event of memory loss.
- If memory is lost, simply reprogram each channel.
The display shows 000.0000 in all channels when there has been a memory loss.
- Always press each button firmly until you hear the entry tone for that key entry, unless you have turned 2:OFF the 3:KEY BEEP in the menu system.

Location

- Do not use the scanner in high-moisture environments such as the kitchen or bathroom.
- Avoid placing the unit in direct sunlight or near heating elements or vents.
- If the scanner receives strong interference or electrical noise, move it or its antenna away from the source of the noise. If possible, a higher elevation, may provide better reception.

Cleaning

- Disconnect the power to the unit before cleaning.
- Clean the outside of the scanner with a mild detergent.
To prevent scratches, do not use abrasive cleaners or solvents. Be careful not to rub the LCD window.
- Do not use excessive amounts of water.

Repairs

- Do not attempt any repair. The scanner contains no user serviceable parts. Contact the Uniden Customer Service Center or take it to a qualified repair technician.

Birdies

- All radios can receive birdies (undesired signals). If your scanner stops during Scan mode and no sound is heard, it may be receiving a birdie. Birdies are internally generated signals inherent in the electronics of the receiver.

Press **L/O** to lockout the channel, and then press **RSM** to resume scanning.

Troubleshooting

If your UBC785XLT is not performing properly, try the following steps.

Problem	Suggestion
Scanner won't work.	<ol style="list-style-type: none">1. Check the connections at both ends of the AC Adapter.2. Turn ON the wall switch of your room. You could be using an outlet controlled by the wall switch.3. Move the AC Adapter to another wall outlet.
Improper reception.	<ol style="list-style-type: none">1. Check the antenna connection.2. Move the scanner.3. You may be in a remote area which could require an optional multi-band antenna. Check with your dealer or local electronics store.
Scan won't stop.	<ol style="list-style-type: none">1. Adjust squelch threshold - refer to page 17, "Setting the Squelch".2. Check the antenna connection.3. Check to see if many of the channels are Locked Out. If so, the scanner has less chance of finding an active channel.4. Review each channels frequency to see if it is still stored in Memory and is correct.5. Its possible that none of the programmed frequencies are currently active.
Scan won't start.	<ol style="list-style-type: none">1. Press the SCAN key again.2. Adjust the SQUELCH control.3. Check to see if all channels are Locked Out.

Resetting the Scanner

If the scanner's display locks up or stops operating properly, you might need to reset the scanner.

Caution: This procedure clears all the information (except the band plan data) you have stored in the scanner. Before you reset the scanner, try turning it off and on to see if it begins working properly. Reset the scanner only when you are sure it is not working properly.

1. Turn off the scanner.
2. While holding down 2, 9, and Hold ▲, turn on the scanner. It takes about 15 seconds to initialize and `All Memory Clear Please wait` appears.

Specifications

Channel:	1000
Banks:	10 (100 channels each)
Frequency Range:	See the band plan on page 1 to 3.
Operating Temperature:	-20 °C to +60 °C (-4 °F to +140)
Scan Rate:	100 channels per second
Search Rate:	100 steps per second (Normal Search) 300 steps per second (Turbo Search)
Audio Output:	Maximum 3.0W (2.1W normal @ 10% THD)
Internal Speaker:	8 ohms (77 mm outer diameter)
Power Requirements:	AD773U AC Adapter (13.8V DC, 700mA)
Antenna:	Telescopic Antenna (included)
Antenna Jack:	BNC type
External Jacks:	External Speaker (EXT.SP.) (3.5 mm) DC 13.8 V Power Jack, (center is positive) Remote Control (REMOTE) Jack (DB-9) Tape Recorder Out (TAPE OUT) Jack (3.5 mm)
Size:	6-15/16 in. (W) x 6-1/4 in. (D) x 2-1/4 in. (H) 176.5mm (W) x 168.3mm (D) x 68.6mm (H)
Weight:	1.33 kg (46.6 oz.)

Features and specifications are all subject to change without notice.

Glossary of Terms

Alpha tag - This term refers to an alphanumeric text tag that you can enter to describe the individual frequencies that you have programmed. Rather than having to associate a specific frequency to the individuals that are using it, you can enter the actual name of the group. This will eliminate the need for memorizing the group's frequency.

Attenuator - This scanner comes with a feature to attenuate or reduce the signal strength. The built-in attenuator can be turned on specific frequencies to prevent strong signals from overloading the scanner input, possibly damaging the scanner or missing other transmissions due to the repeated stopping on the stronger signal.

Clone - This term identifies the ability to set up a duplicate scanner. This function allows you to clone all the programming information, including frequencies, talkgroups and alpha tags as well as bank settings and other parameters from one UBC785XLT to another or UBC785XLT.

CTCSS - (Continuous Tone Controlled Squelch System) refers to a system where the radio receivers are equipped with tone responsive devices which allow audio signals to appear at the audio output, select voice processing such as scrambling or control repeater functions only when a carrier modulated with a specific tone is received. This method may be used to restrict access to the repeater or receiver, or reduce interference where several stations with output frequencies in close proximity of each other make it difficult to hear the conversation you are interested in. With CTCSS squelching, you can eliminate the possibility of hearing unwanted conversations by selecting one of the 38 standard subaudible tones. You will only hear those transmissions that have been programmed on specific frequencies with the specific subaudible tone that you have selected.

DCS - (Digital Controlled Squelch) refers to a system where the radio receivers are equipped with data burst responsive devices which allow audio signals to appear at the audio output, select voice processing such as scrambling or control repeater functions only when a carrier modulated with specific data burst is received. This method may be used to restrict access to the repeater or receiver, or reduce interference where several stations with output frequencies in close proximity of each other make it difficult to hear the conversation you are interested in. With DCS squelching, you can eliminate the possibility of hearing unwanted conversations by selecting one of the 104 standard data burst subaudible tones. You will only hear those transmissions that have been programmed on specific frequencies with the specific subaudible tone that you have selected.

Enter Lock - This is the term used for locking the keypad. This prevents accidental re-programming of channels and talkgroups entered into memory. The default setting is OFF.

When ENTER LOCK is enabled, the following functions will be disabled:

- Enter or modify the Memory Channel frequency
- Enter or modify the Tone information

Key Beep - This is another term for the tone you hear as a keypad acknowledgement beep. The default setting is on.
If you have turned the Key Beep off, you now have a silent keypad. You will not hear a tone each time you press a key.

PC Control - This term is associated with the ability to program frequencies and other useful information via a computer by means of third party software. You can change the transfer speed on the scanner needed to be compatible with your PC. (See page 40)

Screen Mask - Screen Mask reduces the amount of information that appears on the display. Alpha tags that you have set for a channel along with a few function icons will appear only on the display. This mode is particularly useful in public safety vehicles where that are already overloaded with information. Screen Mask does not work in Search mode.

CTCSS Frequency List (Hz)

67.0	71.9	74.4	77.0	79.7	82.5	85.4	88.5
91.5	94.8	97.4	100.0	103.5	107.2	110.9	114.8
118.8	123.0	127.3	131.8	136.5	141.3	146.2	151.4
156.7	162.2	167.9	173.8	179.9	186.2	192.8	203.5
210.7	218.1	225.7	233.6	241.8	250.3		

DCS Tone Code

023	025	026	031	032	036	043	047
051	053	054	065	071	072	073	074
114	115	116	122	125	131	132	134
143	145	152	155	156	162	165	172
174	205	212	223	225	226	243	244
245	246	251	252	255	261	263	265
266	271	274	306	311	315	325	331
332	343	346	351	356	364	365	371
411	412	413	423	431	432	445	446
452	454	455	462	464	465	466	503
506	516	523	526	532	546	565	606
612	624	627	631	632	654	662	664
703	712	723	731	732	734	743	754

UBC785XLT Flow Charts

1	SEAECH OPTION	1	AIR STEP	1: 12.5kHz/2: 8.33 kHz			
		2	CHAIN SEARCH	1: ON /2: OFF			
		1	CHAIN SEARCH				
		2	SEARCH RANGE				
		3	DELAY	1: NONE /2: 1 SECOND 3: 2 SECONDS /4: 4 SECONDS 5: INFINITE /6: 2 SECONDS 7: 5 SECONDS /8: 10 SECONDS			
		4	ATTENUATOR	1: ON /2: OFF			
		5	STONE DATA	1: CTCSS /2: DCS /3: OFF			
		6	RECORD	1: ON /2: OFF			
		7	AUTO STORE	1: ON /2: OFF			
		1	RANGE				1: 5KHz /2: 6.25KHz /3: 7.5KHz 4: 10KHz /5: 12.5KHz /6: 20KHz 7: 25KHz /8: 50KHz /9: 100 KHz 0: AUTO
		2	STEPS				
		3	MODE				1: AM /2: FM /3: WFM /4: NFM 5: AUTO
		4	ALPHA TAG				

2	SCAN OPTION	(Select Channel)	1	FREQUENCY	(Select Frequency)	ALPHA TAG	1:OTHER CHANNEL 2:CHANNEL OPTION 3:DONE
			2	DELAY	1:NONE /2: 1 SECOND 3:2 SECONDS /4:4 SECONDS 5:INFINITE /6: -2 SECONDS 7:-5 SECONDS /8:-10 SECONDS		
			3	TONE DATA	1: CTCSS/ 2: DCS/ 3: OFF		
			4	BEEP ALERT	1:ON/2:OFF		
			5	ATTENUATOR	1:ON/2:OFF		
			6	STEPS	1:5KHz /2:7.5KHz /3:10 KHz 4:12.5 KHz /5:25 KHz /6:50 KHz 7:100 KHz /8: AUTO		
			7	MODE	1: AM/2: FM/3: WFM/4: NFM		
			8	RECORD	1:ON/2:OFF		

3	SYSTEM OPTION	1	DIMMER	1:HIGH / 2:MEDIUM / 3:OFF
		2	SCREEN MASK	1:ON / 2: OFF
		3	KEY BEEP	1:ON / 2: OFF
		4	ENTER LOCK	1:ON / 2: OFF
		5	PC CONTROL	1:2400 bps / 2: 4800 bps / 3:9600 bps / 4: 19200 bps / 5:OFF*
		6	CLONE	MASTAR / SLAVE
		7	DATA SKIP	1:ON / 2: OFF
		8	SQ MODE	1:CSQ / 2:TONE SQ / 3:TONE SEARCH
		9	BANK TAG	(Select Bank)

Declaration of Conformity

Uniden Corporation
2-12-7 Hatchobori
Chuo-Ku, Tokyo 104-8512
Japan

declare, under our sole responsibility, that this equipment “Uniden Bearcat model UBC785XLT” is in compliance with the essential requirements and other relevant provisions of the EMC, R&TTE and LVD Council Directives of the EU.

Uniden[®]

© 2006 Uniden Corporation.
UBZZ01343ZZ(0)

All rights reserved.
Printed in P.R.C. 

Free Manuals Download Website

<http://myh66.com>

<http://usermanuals.us>

<http://www.somanuals.com>

<http://www.4manuals.cc>

<http://www.manual-lib.com>

<http://www.404manual.com>

<http://www.luxmanual.com>

<http://aubethermostatmanual.com>

Golf course search by state

<http://golfingnear.com>

Email search by domain

<http://emailbydomain.com>

Auto manuals search

<http://auto.somanuals.com>

TV manuals search

<http://tv.somanuals.com>