

Start Here! **1** **2** **3**
Quick Start Guide Next Page...



Quick Start Guide

XSA 975

Digital Answering
Machine

Speakerphone

900 MHz

Caller ID

10 Number
Memory

Plus

Rocket Dial

Uniden

INSTALLATION & SAFETY

Choosing the best location for your phone.

When choosing a location for your phone there are a number of appliances the phone should not be near, and areas you should avoid.



This symbol indicates important operating and servicing instructions.



The earcap of this telephone may attract and retain small metallic objects.

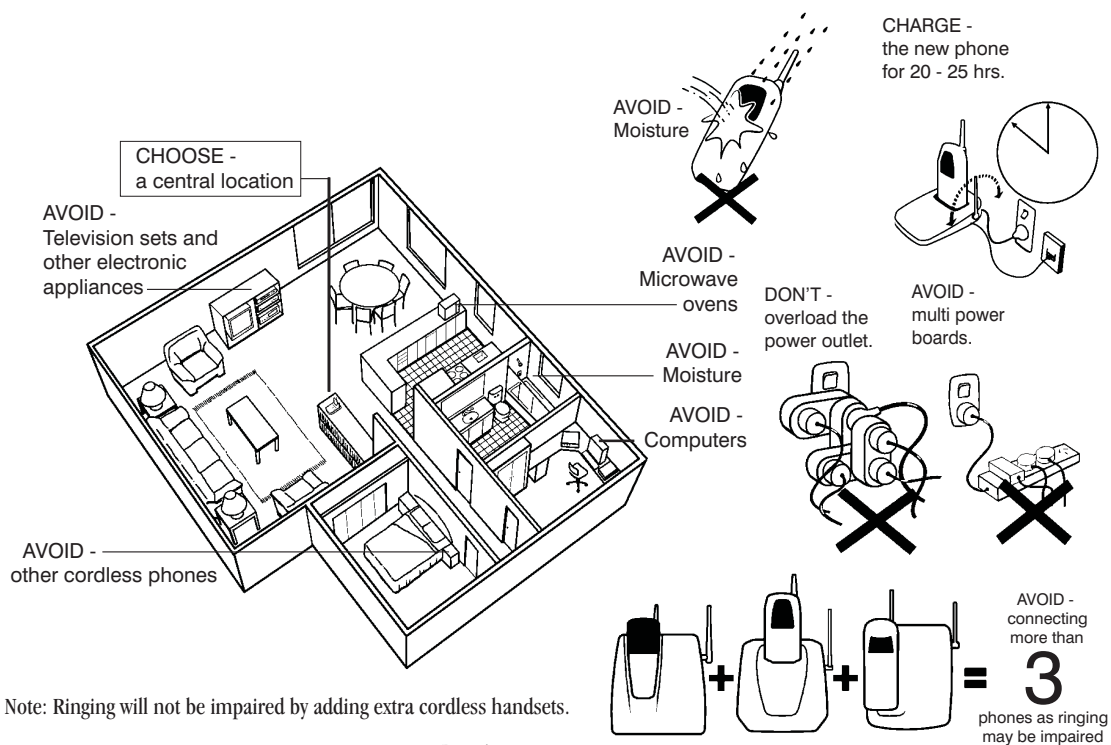

Note: Ringing will not be impaired by adding extra cordless handsets.



Make sure the AC Adaptor/s remains switched ON at all times. Use only the Uniden AC Adaptor/s supplied with this unit.

Start Here! **1** **2** **3**

This page is a very condensed version of the Owners Manual. It is designed to allow you to get your phone installed and operating as quickly as possible - however it does not attempt to explain any of the advanced features of the XSA975.

1 Installing the Base Unit

- Plug the telephone cord into the Base Unit, then into the telephone socket on the wall.
- Plug the AC Adaptor cord into the Base Unit, then the AC Adaptor into the wall power point.
- Press the AC Adaptor cord into the curved recess under the Base Unit.
- Raise the antenna.

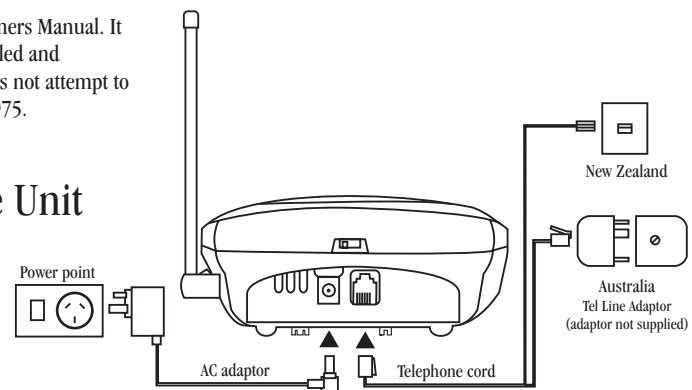

Installing the Charge Cradle

- Plug the AC Adaptor cord into the Charge Cradle, then the AC Adaptor into the wall power point.

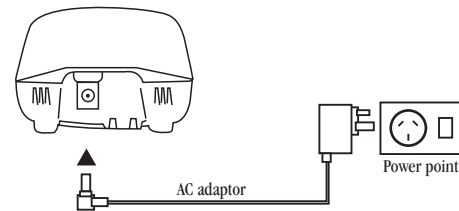



You must charge the batteries continuously for 20 hours before using the phone.

2 Installing the Handset Battery

- Press the battery cover and slide it off.

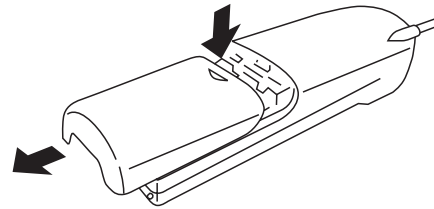

- Connect the battery plug to the socket at the rear of the battery compartment.
- Make sure the plug is the right way round.
- The RED and BLACK battery wires must match the RED and BLACK printed on the phone case for the plug to fit properly.
- Press firmly until it clicks into place.

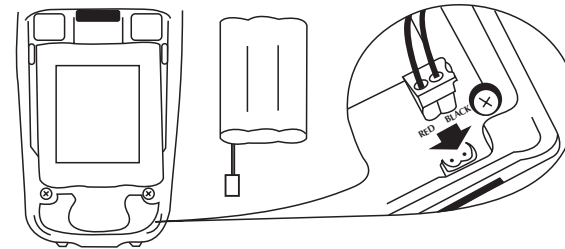

- Position the battery in the compartment and slide the cover into place.

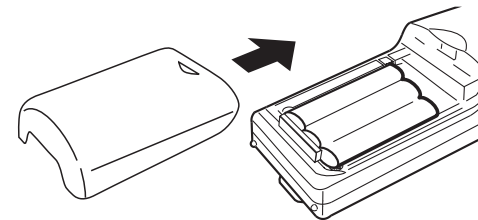

Repeat process for second handset.

- Place one handset on the main base and place the other handset in the extra charging cradle. It does not matter which handset is placed on the main base and extra charging cradle.

3 Making a Call



Registration of Dual Handset

- After fully charging the handsets, remove the handset from the extra charging cradle and place it on the main base. (The **in use/charge** LED will begin to flash indicating registration is occurring).
- Wait for at least 5 seconds before removing the extra handset from the **main** base.

The registration has been completed, and your dual handset cordless phone is ready for use.

- Pick up the handset and press **(talk)**. Dial the phone number
OR
Dial the phone number - then press **(talk)**
- To hang up - press **(end)**
OR
Place the handset on the Base Unit
- To use the speakerphone on the Base Unit press **(speaker)** then dial the phone number.

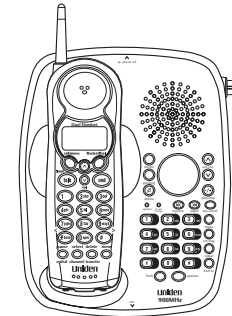

Answering a Call

- Handset on the Base Unit:
Remove the handset from the base and speak (*Autotalk on*).
- Handset off the Base Unit:
Pick up the handset, press **(talk)** and speak.
- To hang up - press **(end)**
OR
Place the handset on the Base Unit.
- If using the speakerphone on the Base Unit press **(speaker)** to answer a call and press **(speaker)** to end a call.



Your outgoing message can be recorded up to 30 seconds long.

Setting Up the Answering System

To turn the answering system on:

- Press **answer on** - the pre-recorded greeting will play and your system is ready to accept calls.

To record your outgoing message:

- Press and hold **greeting**. After you hear a short tone, release the key.
- "Record Greeting" is announced followed by a long tone.
- Record your greeting while speaking within 15cm of the base.
- When finished, press **greeting** again.

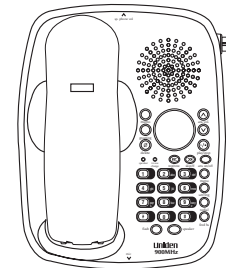

Using the Answering System

To play your message:

- Press **new messages** - new messages play first.

To repeat a message:

- Press **repeat** during playback of messages.

To skip a message:

- Press **skip** anytime during playback to skip to the next message. The system beeps and begins to play the next message.

To delete messages:

- Delete one message:
Press **delete** during a message. The system beeps and begins to play the next message.
- Delete all messages:
After reviewing all messages. Press **delete**, "To delete all messages, press delete again" is announced.
Press **delete** again.



If the transferred call is not picked up after 5 minutes, the call will be disconnected.

CALL TRANSFER

To have the ability to transfer calls from one handset to the other handset:

Initial Setup:

(Important - Please make sure you have registered your dual handset - refer to instructions on page iv).

TO TRANSFER CALLS

To transfer your call from handset 1 to handset 2:

- Press **(transfer)**.
- The call is placed on hold on the first handset, while handset 2 begins to ring. The call is transferred when the 2nd handset is answered.
- Repeat the process to transfer the call back to handset 1. Calls can be transferred from either handset.
- If the transferred call is not answered, you can retrieve the call by pressing **(talk)** or **(transfer)**.

3 Way Conference

- During Handset talk mode press the **(speaker)** button on the Base then you can talk 3 ways. If you are already using the Base speaker phone, press the **(talk)** button on one Handset.

CONTENTS

Installation & Safety	i	Caller ID	16
Quick Start Guide	ii	Caller ID	16
Contents	vii	When the Telephone Rings	16
Getting Started		Viewing the Caller ID Message List	17
Controls and Functions	1	Deleting Information from the Caller ID List	17
Welcome	3	Deleting a Caller ID Message	17
Included in your Package	4	Deleting all Caller ID Names and Numbers	17
Mounting the Base Unit on a wall	5	Calling a Party from the Caller ID List	18
Installing the Beltclip	5	Dial Edit	18
Headset Installation	5	Stored Caller ID Messages in Memory Dialing	18
Battery Maintenance	6	Answering System	
Using your Phone		Answering System	19
Setting Menu Options	7	Turning the Answering System On/Off	19
Autotalk	7	Setting the Time	20
Pop Up Name	7	Setting a Personal Security Code (PIN)	20
Making and Receiving Calls	8	Setting the Ring Time	21
Adjusting the Handset Ringer Volume and Earpiece Volume	9	Setting the Message Record Time	21
Adjusting the Speakerphone Volume	9	Announce Only Feature	22
Redial	9	Setting the Message Alert Tone	22
Travelling Out-of-Range	10	Setting Your Outgoing Message (Greeting)	23
Selecting a Different Channel	10	Setting the Base Ringer Volume	24
Find Handset	10	Adjusting the Answering System Speaker Volume Level	24
Call Waiting/Flash	10	Using Your Answering System	25
Memory Dialing		Playing Your Messages	25
Storing Phone Numbers	11	Repeating a Message	25
Making Calls with Memory Dialing	12	Skipping a Message	26
Memory Dialing from Talk Mode	12	Deleting a Message	26
Chain Dialing	12	Voice Memo	27
Editing a Stored Name and/or Phone Number	13	Remote Access Away From Home	28
Erasing a Stored Name and/or Phone Number	13	Turn on the Answering System Remotely	29
Call Transfer	14	Notes	30
Rocketdial		Remote Operation Card	31
Rocketdial	15	Troubleshooting	33
Storing and Editing the Rocketdial	15	Warranty	34
Making Calls with Rocketdial	15	Notes	35
Deleting the Rocketdial	15		

CONTROLS AND FUNCTIONS

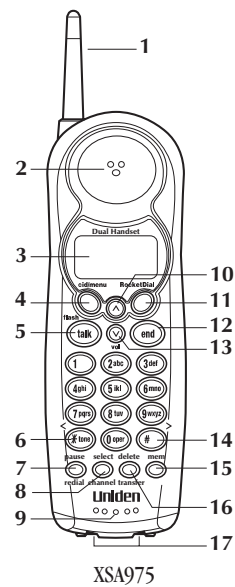

1. Handset antenna
2. Handset earpiece
3. LCD display
4. sid key
5. talk / flash key
6. * / < key
7. redial / pause key
8. select / channel key
9. Handset microphone and ringer speaker
10. ^ Volume up key
11. Back/Dial key
12. end key
13. v Volume down key
14. # / > key
15. mem key
16. delete / transfer key
17. Handset charging contacts

CONTROLS AND FUNCTIONS

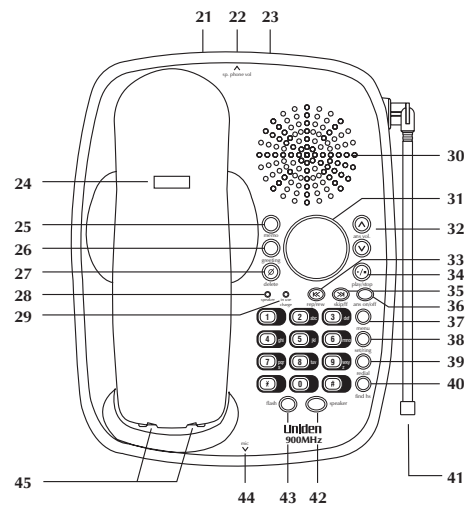

- 21. Telephone line jack
- 22. Speakerphone volume switch
- 23. AC Adaptor input
- 24. Handset retainer clip
- 25. **memo** key
- 26. **greeting** key
- 27. **Delete** key
- 28. Speaker LED
- 29. In use/charge LED
- 30. Base speaker
- 31. Message counter display
- 32. **▲/▼** Answering machine volume keys
- 33. **<<<** repeat/rew key
- 34. **▶/■** Play/Stop key
- 35. **>>>** skip/ff key
- 36. **answer on** /off key
- 37. **menu** key
- 38. **set** /ringer key
- 39. **redial** key
- 40. **find** key
- 41. Base Antenna
- 42. **speaker** key
- 43. **flash** key
- 44. Microphone
- 45. Base charging contacts

WELCOME

Congratulations on your purchase of this Uniden cordless telephone. This Product is designed for reliability, long life and outstanding performance utilising the latest in 900MHz Technology.

FEATURES

- Multiple Handsets (up to 2)
- 900MHz SCR Technology (Sound Clarity and Range)
- Caller ID Display*
- Digital Telephone Answering Device
- Pop Up Name - Caller Name Identification #
- 30 Caller ID Memories
- Alphanumeric Memory Dialing
- Super Chat Battery
- Maxi-Sound - Extra Loud Handset Volume Control
- Rocketdial - One Touch VIP Dial
- LCD Back Light
- Wall or Desk Mountable
- Page/Find Handset Feature
- AutoTalk
- 32 Digit Redial
- Pause
- Flash Button (Call Waiting Compatible)
- 2 Type Tone Ringer
- 2 Step Ringer Volume Control
- Speakerphone
- 3 Way Communication (Handset to Base to Outside Caller)

NOTES

- * Caller ID feature only works if you subscribe to the service by your local telephone company. There is usually a fee for this service.
- # Pop Up Name feature only works if you subscribe to your telephone company Caller ID service and record names into your phones memory.

INCLUDED IN YOUR PACKAGE

Make sure you have received the following items in the package. If any of these items are missing or damaged, contact the Uniden Parts Department.

Super Chat
Rechargeable Battery

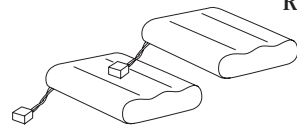

2nd Super Chat
Rechargeable Battery

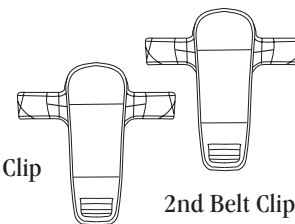

Telephone Cord

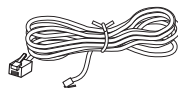

Belt Clip

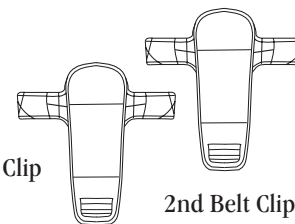

2nd Belt Clip

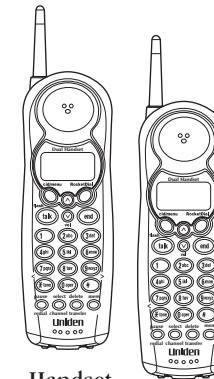

Handset

2nd Handset

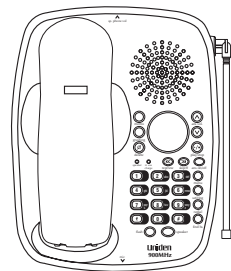

Main Base

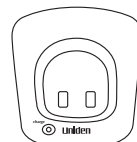

Charge
Cradle



Owners Manual

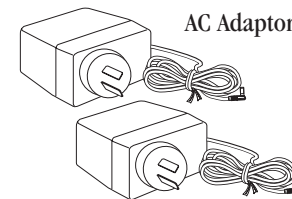

AC Adaptor

2nd AC Adaptor



If you are using an optional headset, you must still use the handset keypad for phone operations.

MOUNTING THE BASE UNIT ON A WALL

Direct Wall Mounting

You can mount your phone directly to the wall. Before doing this, consider the following:

- Avoid electrical cables, pipes or other items behind the mounting location that could cause a hazard when inserting screws into the wall.
- Mount your phone within distance of a working phone jack.
- Make sure the wall material is capable of supporting the weight of the base and handset.
- Use screws with anchoring devices suitable for the wall material where the base unit will be placed.

1. Insert two mounting screws into a wall (with their appropriate anchoring device), 85mm apart. Allow about 3mm between the wall and screw heads for mounting the phone.
2. Plug the AC adaptor into the Base Unit and then into a power point.
3. Plug the telephone cord into the Base Unit and then into the telephone socket on the wall.
4. Align the mounting slots on the base with the mounting posts on the wall.
5. Then push in and down until the phone is firmly seated.

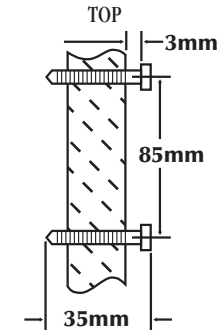

INSTALLING THE BELTCLIP

To attach the beltclip:

Insert the beltclip into the holes on each side of the handset. Press down until it clicks.

To remove the beltclip:

Pull both sides of the beltclip to release the tabs from the holes.

HEADSET INSTALLATION

Your phone may be used with an optional headset. To use this feature, simply plug the headset into the headset jack.

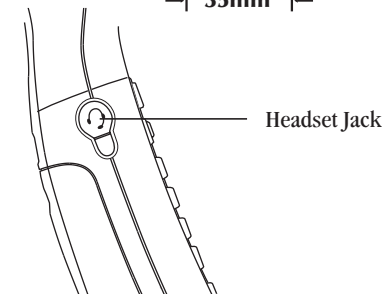

GETTING STARTED



Use only the genuine Uniden Super Chat Battery supplied with your phone. Replacement Super Chat Batteries are available through the Uniden Parts Department.

BATTERY MAINTENANCE

Battery use time (per charge)

- 10 hours continuous use
- 12 days when handset is in the standby mode

When the Battery charge becomes low

If the phone is not in use, 'Low Battery' flashes and none of the keys will operate. If the phone is in use, 'Low Battery' flashes and the handset beeps. Complete your conversation as quickly as possible and return the handset to the base unit for charging.

- You cannot overcharge the battery.
- You may return the handset to the charger after each call or when the battery is low.

Cleaning the battery contacts

To maintain a good charge, it is important to clean the battery contacts on the handset and base unit with a dry cloth or a pencil eraser about once a month. Do not use any liquids or solvents.



Genuine Handset Batteries

The high quality rechargeable batteries supplied with your phone will perform for up to two years or more. In order to enjoy the best performance from your phone, we recommend you replace your batteries every two years with a genuine Uniden battery.

Simply visit our website to order a replacement battery:

Uniden Australia PTY Limited
Service Division
www.uniden.com.au

Uniden New Zealand Limited
Service Division
www.uniden.co.nz



Functions will need to be programmed in both handsets separately.

SETTING MENU OPTIONS

Options available include AutoTalk and Pop Up Name.

AUTOTALK

AutoTalk allows you to answer the phone without pressing the **(talk)** button. If the phone rings when Autotalk is on, simply remove the handset from the base and the phone automatically answers the call. If the phone rings when Autotalk is off, you must press **(talk)** to answer the call.

POP UP NAME

If the displayed Caller ID telephone number is **exactly** the same as a number stored in memory, then the stored name will also be displayed with the caller ID telephone number.

To change your AutoTalk and Pop Up Name (Name Tag)

1. Press and hold **(end menu)**. The following screen appears.

```

1 ▶ Auto Talk :On
2 Name Tag  :On
    
```

2. Use **(^)** and **(v)** or a number key **(1)** and **(2)** to move the pointer to the selection that you would like to change. Press **(select)** to toggle between 'On' and 'Off' for AutoTalk and Pop Up Name (Name Tag).
3. Press **(end)** and return the handset to the base unit. The handset returns to the standby mode.



Refer to page 7 "Autotalk" to turn on/off the Autotalk feature.

MAKING AND RECEIVING CALLS

	Handset On Base	Handset Off Base	Base Speakerphone
To answer a call	Pick up the handset (<i>Autotalk on</i>) or pick up the handset and press (talk) (<i>Autotalk off</i>).	Press (talk) , any number, * or # (<i>Autotalk on</i>).	Press (speaker) .
To make a call	<ol style="list-style-type: none"> Pick up the handset. Press (talk). Listen for the dial tone. Dial the number. <p>OR</p> <ol style="list-style-type: none"> Pick up the handset. Dial the number, then press (talk). 	<ol style="list-style-type: none"> Press (talk). Listen for the dial tone. Dial the number. <p>OR</p> <ol style="list-style-type: none"> Dial the number, then press (talk). 	<ol style="list-style-type: none"> Press (speaker). Listen for the dial tone. Dial the number.
To hang up		Press (end) , or return the handset to the base or extra charging cradle (<i>AutoStandby</i>).	<ol style="list-style-type: none"> Press (speaker). (<i>The speaker LED will then turn off</i>)
To redial	<ol style="list-style-type: none"> Pick up the handset. Press (talk). Listen for the dial tone. Press (redial). <p>OR</p> <ol style="list-style-type: none"> Pick up the handset. Press (redial), then press (talk). 	<ol style="list-style-type: none"> Press (talk). Listen for the dial tone. Press (redial). <p>OR</p> <ol style="list-style-type: none"> Press (redial), then press (talk). 	<ol style="list-style-type: none"> Press (speaker). Listen for the dial tone. Press (redial).



Settings will need to be programmed in both handsets separately.

ADJUSTING THE HANDSET RINGER VOLUME AND EARPIECE VOLUME

Handset ringer tone and volume

Press **▲** or **▼** in standby mode to select one of five ringer tones and volume combinations. The telephone will keep this setting for all future calls.

Earpiece Volume

Pressing **▲** or **▼** during a call will change the earpiece volume of the handset. The telephone will keep this setting for all future calls.

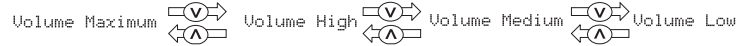

Ringer Mute

You can temporarily mute the ringer tone. When the handset is off the base and the phone is ringing, press **end**. The ringer tone will return to normal with the next incoming call.

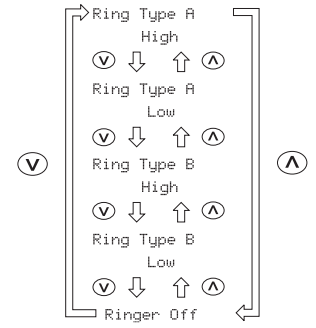

ADJUSTING THE SPEAKERPHONE VOLUME

To adjust the Speakerphone Volume move the Speakerphone Volume Switch to either Lo, Mid or Hi.

REDIAL

The **redial** key redials the last number dialed. The redialed number can be up to 32 digits long.

1. Press **talk**.
2. Press **redial**. The last number dialed will be called.

To redial on the speakerphone.

1. Press **speaker**.
2. Press **redial**. The last number dialed will be called.

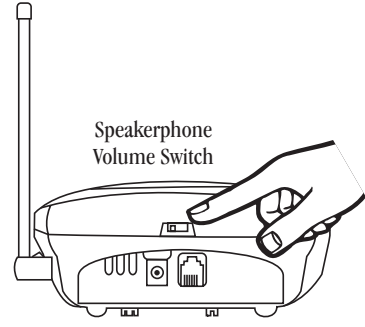



NOTE
You must subscribe through your local telephone company to receive Call Waiting services.

TRAVELLING OUT-OF-RANGE

During a call, noise will increase if you move your handset too far from your base unit. If the range limit of your base unit is exceeded, your call will terminate within five minutes.

SELECTING A DIFFERENT CHANNEL

If you encounter interference while using your phone, you can manually change the phone's channel for clear operation. This function works only when the phone is in use.

- Press **channel**/select. 'Scanning' appears on the display, indicating the phone is changing to another channel.

FIND HANDSET

To locate the handset (while it's off the base), press **find** on the base. The handset beeps for 60 seconds.

Both handsets will ring when paged. Paging is cancelled by pressing any key on either handset.

CALL WAITING/FLASH

If the call waiting tone sounds during a call:

AUSTRALIA: Press **talk**/flash, then **2** to switch between callers.

NEW ZEALAND: Press **talk**/flash on the handset or **flash** on the base speakerphone to switch between callers.

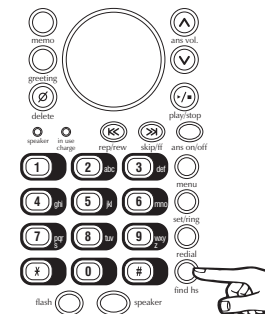



NOTE
In memory dialling operation, you must press a key within 30 seconds or the phone will return to standby.



NOTE
The pause feature is useful for long distance calling, credit card dialling or sequences of numbers that require a pause between digits.



NOTE
There is no memory store in the Base Speakerphone.

STORING PHONE NUMBERS

Memory Dialing allows you to dial a number using just a few key presses. Your XSA975 stores up to 10 names/numbers in each handset.

1. Press and hold **(mem)**, 'Memory Store' is displayed.
2. Press **(^)** or **(v)** or enter a number (**(0)** - **(9)**) to select the memory location where you would like to store the number.
3. Press **(select)**, 'Store Name' is displayed on the screen and a cursor flashes indicating that the display is ready for a name to be entered.

If the screen shown to the right appears, the selected memory location is already stored. Then you must either edit the entry in this location, delete the entry in this location (page 13) or select "Go Back" to choose another location.

4. Use the Alpha Numeric keys to enter a name. The name cannot exceed 14 characters.
 - Use **(←)** and **(→)** to move the cursor to the desired location.
 - Use **(delete)** to delete characters as needed.
 - Press and hold **(delete)** to delete all the characters.
 - If a name is not required, go to step 5.
5. Press **(select)**, 'Store Number' is displayed. The cursor flashes indicating that the display is ready for the number to be entered.
6. Use the number keys to enter the phone number. The phone number cannot exceed 20 digits. Use the **(redial)**/pause to enter a pause in the dialing sequence if required. The display shows a 'P'. Each pause counts as one digit and represents a two second delay of time between the digits. Use **(delete)** to delete digits as needed.
7. Press **(select)**, you will hear a confirmation tone, and the following screen appears. Memory storage is complete. For example, if you store a number into the memory location number 1, the display shows 'Memory 1 Stored'. After about 2 seconds, 'Memory Store' is displayed. Repeat steps 2-7 to store more numbers.
8. Press **(end)** to return to standby mode.

```
Memory Store
1 ▶
2
```

```
Store Name
█
```

```
▶ Edit Memory 1
Delete Memory 1
Go Back
```

```
Store Number
█
```

```
Store Number
8002971023
```

```
Memory 1 Stored
```

```
Memory Store
1 ▶ UNIDEN AUS
2 <Memory 2>
```



Numbers stored in one handset can not be accessed from the other.

MAKING CALLS WITH MEMORY DIALING

Memory dialing from Standby Mode.

1. Press **(mem)**. The handset displays your programmed memory locations.
2. Press **(^)** or **(v)**, or enter the number **(0 - 9)** to select the memory location you would like to dial.
3. Press **(talk)** 'Talk' and the volume settings are displayed. Then the displayed number is dialed.

```

1 ▶ UNIDEN AUS
2  JOE BLOGGS
3  JOHN DOE
    
```

```

Talk
0800123456789
    
```

Display a Programmed Number

Press **(mem)**. The handset displays your programmed memory locations. Use **(>)** and **(<)** to toggle between the names and numbers displayed.

```

1 UNIDEN AUS
2 JOE BLOGGS
3 ▶ JOHN DOE
    
```

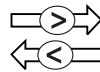

```

1 0800123456789
2 5452980
3 ▶ 6567988
    
```

MEMORY DIALING FROM TALK MODE

1. Press **(talk)**. 'Talk' and the volume setting appears.
2. Press **(mem)**.
3. Enter a number **(0 - 9)** to select the memory location of the desired phone number. The selected phone number is displayed. Then the number is dialed. If the memory location selected does not have a number stored, a series of beeps is sounded.
4. To hang up, press **(end)**.

CHAIN DIALING

On certain occasions after dialing a number, you may be required to enter an access code such as your account number for phone banking. You can enter this number into a memory location for later use by doing the following:

1. Store the access code into one of the memory locations **(0 - 9)** following the steps on page 11.
2. Dial the party or service main number.
3. When you need to enter the special number, press **(mem)** followed by the memory location **(0 - 9)**.

EDITING A STORED NAME AND/OR PHONE NUMBER

1. Press and hold **(mem)**. 'Memory Store' is displayed.
2. Press **(▲)** or **(▼)**, or enter a number **(0 - 9)** to select the memory location you would like to edit.
3. Press **(select)**. The edit screen is displayed.
4. Press **(select)** again to select 'Edit Memory X'. The cursor flashes indicating that the display is ready for the name to be edited.
5. Use the number keys, **(←)**, **(→)**, or **(delete)** to edit the name. To edit only the phone number, skip this step.
6. Press **(select)**. The cursor flashes indicating that the display is ready for the number to be edited.
7. Use the number key, **(redial)/pause** and **(delete)** to edit the phone number. The phone number cannot exceed 20 digits. If you don't want to change the phone number, skip this step.
8. Press **(select)**. You hear a confirmation tone. Memory Storage is complete. For example, if you store a name and number into memory location number 1, the display shows 'Memory 1 Stored'.
9. Press **(end)** to return to standby mode.

ERASING A STORED NAME AND/OR PHONE NUMBER

1. Press and hold **(mem)**. 'Memory Store' is displayed.
2. Press **(▲)** or **(▼)** or enter a number **(0 - 9)** to select the memory location you would like to erase.
3. Press **(select)**. The edit screen is displayed with the memory location number that you have selected.
4. Press **(▼)** to move the pointer down to 'Delete Memory X'.
5. Press **(select)**.
6. Press **(▲)** to move the pointer to 'Yes'.
7. Press **(select)** or **(delete)**. A confirmation tone is sounded, and 'Memory X Deleted' is displayed.
8. After about 2 seconds, 'Memory Store' is displayed. You may delete the information in another memory location (return to step 2) or press **(end)** to return to standby mode.



Call Transfer is only available from handset to handset.

MEMORY DIAGRAM

CALL TRANSFER

To have the ability to transfer calls from one handset to the other handset:

Initial Setup:

(Important - Please make sure you have registered your dual handset - refer to instructions on page iv).

TO TRANSFER CALLS

To transfer your call from handset 1 to handset 2:

- Press **transfer**.
- The call is placed on hold on the first handset, while handset 2 begins to ring. The call is transferred when the 2nd handset is answered.
- Repeat the process to transfer the call back to handset 1. Calls can be transferred from either handset.
- If the transferred call is not answered, you can retrieve the call by pressing **talk** or **transfer**.



The Memory Location for Rocketdial is independent from the memory location used for memory dialling.



If the Rocketdial does not have a stored number, the handset will beep rapidly and the phone will not dial.

ROCKETDIAL

You can store your most frequent dialed number in the Rocketdial location. The Rocketdial allows you to dial a number with one key press (there is no need to press **(talk)**. The phone will automatically dial the number stored).

STORING AND EDITING THE ROCKETDIAL

- When the phone is in standby mode, press and hold **(Rocket Dial)**. 'Store Number' is displayed.
If the screen shown to the right appears, there is a number already stored. Press **(select)** to select 'Edit Number'.
- Store the number by following step 6 under "Storing Phone Numbers" on page 11.
- Press **(select)**. A confirmation tone sounds. Memory storage is complete. 'Number Stored' is displayed.

Store Number
■

► Edit Number
Delete Number
Go Back

Store Number
800 ■

MAKING CALLS WITH ROCKETDIAL

When the phone is in the standby mode, simply press **(Rocket Dial)**. The number stored in the Rocketdial memory location is instantly dialed.

DELETING THE ROCKETDIAL

- When the phone is in the standby mode, press and hold **(Rocket Dial)**. The following display appears.
- Press **(V)** to select 'Delete Number'.
- Press **(select)**. The following display appears.
- Press **(^)** to move the pointer to 'Yes'.
- Press **(select)** or **(delete)**. 'Number Deleted' is displayed and a confirmation tone sounds. After 2 seconds, the handset returns to standby mode.

► Edit Number
Delete Number
Go Back

Delete Number?
► Yes
No

Number Deleted



If you answer a call before the Caller ID message is received (i.e. before the second ring), the Caller ID message will not appear.

CALLER ID

You must subscribe to a Caller ID service to use these facilities. When the telephone rings, the Caller ID feature allows you to view the caller's name and phone number on the display before you answer the telephone. The handset displays the phone number of the incoming call, the name, time and number of calls. Additionally, you can dial the displayed number and store the information for memory dialing.

WHEN THE TELEPHONE RINGS

When the Caller ID message is received, the display shows the caller's phone number along with the date and time. The incoming call information is stored in the Caller ID record. If the Caller ID service includes the caller's name, the caller's name appears on the display (currently not supported in Australia or New Zealand).

The date and time received	21/12 12:30PM
Caller's name	JIM STATEN
Caller's phone number	0295979035

Here are some typical displays:

When the mobile phone number and date are received.

21/12 12:30PM Mobile 0295979035

When invalid data is received.

Incomplete Data

When a private number is received.

21/12 12:30PM Private

When an unknown number is received.

21/12 12:30PM Unavailable

When a call is coming from a payphone (Australia only).

21/12 12:30PM Payphone



In Caller ID operation, if no key is pressed for more than 30 seconds, an error tone sounds and the telephone returns to the standby mode.



If you get an incoming call or page, the deleting operation is cancelled so you can answer the call or page.



Caller ID numbers need to be deleted from each handset separately.

VIEWING THE CALLER ID MESSAGE LIST

The Caller ID list stores information for up to 30 incoming calls - even unanswered calls.

1. Press . The summary screen appears. The screen shows the number of new messages and total messages.
2. Press to display the latest Caller ID message.
3. Press to see the next message. Or press to see the previous message.
4. Press to return to standby mode.

DELETING INFORMATION FROM THE CALLER ID LIST

The XSA975 stores up to 30 messages. If the phone receives the 31st message, the oldest one in the list is automatically deleted. Caller ID data can also be deleted manually.

DELETING A CALLER ID MESSAGE

1. Press . Display the message to be deleted from the Caller ID list by pressing or .
2. Press .
3. Press or to select 'Yes' or 'No'.
4. Press or .

When the pointer is at 'Yes':

A tone sounds and the Caller ID message is deleted. The next Caller ID message is then displayed.

When the pointer is at 'No':

The display returns to Caller ID message.

DELETING ALL CALLER ID NAMES AND NUMBERS

1. Press .
2. Press .
3. Press or to select 'Yes' or 'No'.
4. Press or .

When the pointer is at 'Yes':

A tone sounds all stored Caller ID messages are deleted.

When the pointer is at 'No':

The display returns to the summary screen.



New Zealand:
Calling from the
Caller ID list may
not be functional.



You cannot store a
Caller ID message
if no phone
number appears
in the message.

CALLING A PARTY FROM THE CALLER ID LIST

You can place a call from the Caller ID list.

1. Press **cid** **menu**. Select the phone number that you want to dial by pressing **V** or **^**.
2. Press **talk**. The displayed phone number dials automatically.

DIAL EDIT

You can temporarily edit the Caller ID number that is displayed by pressing **select**. A cursor appears in the display. Press **delete** to move the cursor left, make your changes and then press **talk**. This will not change the number in the Caller ID list memory.

STORED CALLER ID MESSAGES IN MEMORY DIALING

Messages shown in the Caller ID list can be stored in memory dialing. Using the incoming call information (i.e., Caller ID list), the phone number of the party on the Caller ID can be stored in memory.

1. Press **cid** **menu**. Select the phone number to be stored from the Caller ID list by pressing **^** or **V**.
2. Press **mem**.
3. Press **^** or **V** or enter a number **(0 - 9)** to select the memory location to be stored.
4. Press **select**. A confirmation tone sounds and the number is stored in memory. The display returns to the Caller ID list.
5. Press **end** to return to standby mode.

If a message has already been stored in the selected memory number location, a confirmation screen is displayed. Press **^** to select 'Yes'. Press **select** to replace. The display returns to the Caller ID list.

ANSWERING SYSTEM

You can use your answering systems to leave a voice memo message for others who use the phone, or to announce a special message to callers when you're away from your phone.

FEATURES

- Digital Tapeless Recording
- Call Screening
- Time and Day Announcement
- Toll Saver
- 13 minutes of Recording Time
- Selecting Outgoing Messages
- Remote Message Retrieval
- Voice Memo

Digital Tapeless Recording allows you to quickly review, save or delete the messages you choose. You will never have to worry about a tape wearing out, jamming or resetting improperly. The Integrated Answering System is easy and convenient to use, but **please read** through all of the instructions carefully.

TURNING THE ANSWERING SYSTEM ON/OFF

1. To turn the answering system on, press **answer on**. The current greeting message will be played and you will hear a confirmation tone. The message counter displays the number of messages stored in memory. If the display flashes, then there are new messages waiting for you.
2. To turn the answering system off, press **answer /off**. 'Answer Off', is announced and the message counter display will no longer be illuminated.

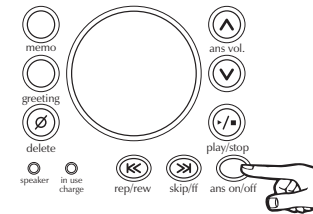



Press and hold 'Skip/ff' or 'Repeat/rew' to quickly scroll through the numbers on the display.



The PIN code is set to '80' when you purchase the XSA975.

SETTING THE TIME

1. Press **menu**. 'Time' is announced along with the current time. The message counter displays the current numbers [1] through [7] indicating the day of the week.
2. Press **>>>** or **<<<** until the correct day is announced. The numbers [1] through [7] are displayed on the base.
3. Press **set**.
4. The current recorded hour is announced. Press **>>>** or **<<<** until you hear the correct hour setting. The numbers [1] through [12] are displayed on the base as each hour is announced.
5. Press **set**.
6. The current recorded minute is announced. Press **>>>** or **<<<** until you hear the correct minute setting. The numbers [00] through [59] are displayed on the base as each minute is announced.
7. Press **set**.
8. The current recorded AM or PM setting is announced. Press **>>>** or **<<<** until you hear the correct AM or PM setting. The message counter displays [A] or [P].
9. Press **set**. A confirmation tone sounds, then the announcement 'Time' and the time and day are announced for your review. The base LED displays the number that corresponds with the day of the week.
10. Press **play/stop** to exit menu options.

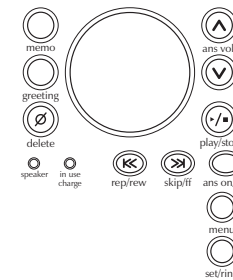

SETTING A PERSONAL SECURITY CODE (PIN)

To play your messages from a remote location, you will need to enter a two-digit Personal Identification Number (PIN) code (00-99). To select a PIN, perform the following steps:

1. Press **menu** twice. 'Security Code' and the current PIN code is announced as it is displayed on the base.
2. Press **>>>** or **<<<** until the desired number appears.
3. Press **set** to select the PIN code. A confirmation tone sounds, then the announcement 'Security Code' and the new PIN code is announced.
4. Press **play/stop** to exit menu options.
5. Record your PIN number on pages 31 and 35 for future reference.



When using the Announce Only feature, you may want to change your outgoing message, if the message prompts the caller to leave a message. The prerecorded message changes automatically.

SETTING THE RING TIME

The ring time setting allows you to set the number of rings the caller hears before your answering system plays the outgoing message. You can set the ring time to answer after six, nine or twelve rings. Setting ± 5 (Toll Saver), the answering system picks up after six rings if you have new messages, and after nine rings if there are none. This way, if you make a long distance call to check your messages, you can hang up after the seventh ring to avoid billing charges.

1. Press **menu** three times. You hear 'Ring Time' and the current ring time ([6] 6, [9] 9, [12] 12, [± 5] Toll Saver), and it is displayed on the base.
2. Press **>>>** or **<<<** until the desired ring time appears.
3. Press **set** /ringer to select the new ring time, a confirmation tone sounds, then the announcement 'Ring Time' and the new ring time is announced.
4. Press ***/#** to exit menu options.

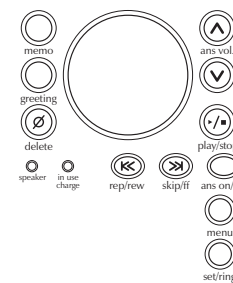

SETTING THE MESSAGE RECORD TIME

You have three record time options. The options '1 minute' or '4 minutes' set the duration for recording incoming messages. 'Announce Only' answers the call with the preset greeting or your personal greeting but prevents the caller from leaving a message.

1. Press **menu** four times. 'Record Time' is announced and the current recording time ([1] 1 minute, [4] 4 minutes, [A] Announce Only) and it is displayed on the base.
2. Press **>>>** or **<<<** until the desired time appears.
3. Press **set** to select the new recording time, a confirmation tone sounds, then the announcement 'Record Time' and the new recording time is announced.
4. Press ***/#** to exit menu options.

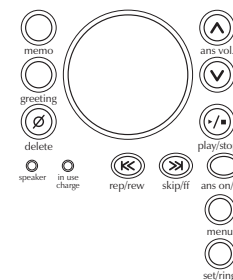

ANNOUNCE ONLY FEATURE

The 'Announce Only' feature plays a prerecorded outgoing message, "Hello, no one is available to take your call. Please call again," but it will not allow the caller to leave a message.

SETTING THE MESSAGE ALERT TONE

The Message Alert feature lets you know that you have new messages by sounding a short beeping tone. If the Message Alert has been set to 'On' and a new message has been received, the alert tone will sound every 15 seconds. Set the Message Alert tone to 'On' or 'Off' by using the following procedure:

1. Press **menu** five times. 'Message Alert' is announced and the current setting ([OFF] Off or [ON] On), and it is displayed on the base.
 2. Press **>>** or **<<** to select.
 3. Press **set** to select the new setting, a confirmation tone sounds, then the announcement 'Message Alert' and the current setting you have selected is announced. When the first new message is received, the beeping tone will begin to sound.
 4. Press **<D** /stop to exit menu options.
- To quickly turn 'Message Alert' tone off, press any key on the base unit and the tone will automatically deactivate. To reset, go back into the menu setup mode.
 - When all new messages are played using the remote playback feature (page 28) the 'Message Alert' tone will automatically deactivate.

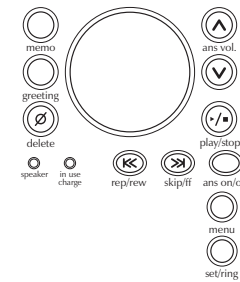



To delete the personal greeting, press **(delete)** during the announcement and the system announces "Greeting has been deleted."

SETTING YOUR OUTGOING MESSAGE (GREETING)

When you receive a call, the answering system automatically plays either a preset message or your own greeting.

Preset Message

The following message is prerecorded, "Hello, no one is available to take your call. Please leave a message after the tone."

Recording A Personal Outgoing Message (Greeting)

1. Press and hold **(greeting)**. 'Record Greeting' is announced and a confirmation tone is heard. [- -] flashes on the message counter. Release key.
2. Start recording your message. You have 30 seconds, and the message counter starts to count down [30] to [1] every second.
3. When you are finished recording your greeting, press **(greeting)**, a confirmation tone sounds, and then your greeting plays back for you.

Choosing Between the Two Outgoing Messages

Press **(greeting)** once quickly. Then press **(greeting)** again when the outgoing message is played. This switches between the prerecorded greeting or the personal greeting. After finishing playing back the message, a confirmation tone is heard.

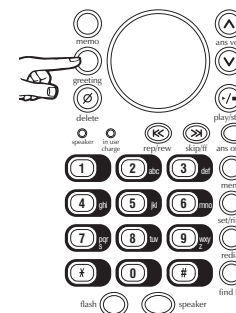



When you have set the base ringer to off and the handset is on the base, you will still hear the ringer from the handset.



When you press **▲** at 9 or **▼** at 0, an error tone sounds.

SETTING THE BASE RINGER VOLUME

You have three ringer options. One allows you to turn the ringer off. The other two are volume levels.

1. Press **set** /ringer. You hear the ringer at the current volume level ([Hi] High, [Lo] Low, [Off] Off) (if you set the base ringer volume to off, 'Off' is announced) and it is displayed on the base.
2. Press **set** /ringer while the current ring volume is being played until the desired ringer option appears.
3. The system displays new ringer volume.

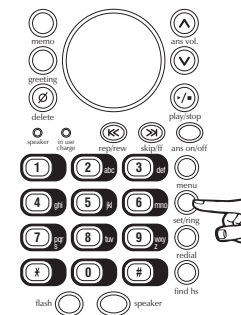

ADJUSTING THE ANSWERING SYSTEM SPEAKER VOLUME LEVEL

You can adjust the volume of the Answering System speaker by pressing the 'Volume' keys on the base. Press **▲** for softer or **▼** for louder while the base speaker is being used.

The numbers 0-9 are displayed on the base indicating the volume levels. 0 being the softest and 9 being the loudest.

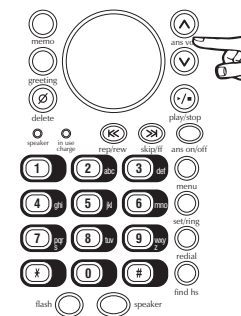



NOTE
When the answering system is full, 'FL' is displayed on the base, and the system announces "No Remaining Time". You should delete some messages so that the system can record new messages.



NOTE
To stop playing your messages, press at any time.

USING YOUR ANSWERING SYSTEM

The message counter displays the number of messages stored in memory. If the display flashes, then there are new messages waiting for you. The flashing number represents the number of new messages, not total messages. After you play all your new messages, you can then play your old messages.

PLAYING YOUR MESSAGES

1. Press . The system announces the number of new and old messages. The LED displays the number of new messages. The day and time that each message was received is announced after the message is played. The message counter displays the number of current messages stored.

When all new messages have been played, a confirmation tone sounds and "End of Messages" is announced. The system returns to standby.

2. After you have reviewed your new messages, you can play your old messages by again pressing . Once you have listened to a new message, it becomes an old message. The old messages will be played in the order in which they were received.

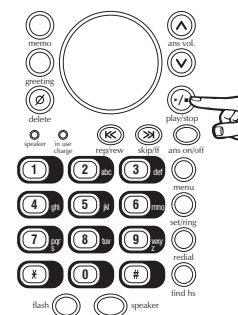

REPEATING A MESSAGE



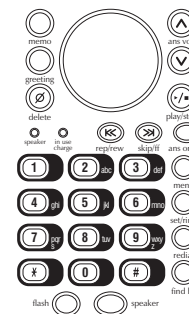

1. While a message is being played, press to replay the message. If you have several messages, press repeatedly until you return to the message you want to replay.
2. Press at any time to stop reviewing messages and return to standby. The message counter shows the number of messages stored in memory.

To quickly scroll backwards through a message, press and hold .



NOTE
 When you press  you are permanently deleting the message. Once deleted, the message cannot be replayed.



SKIPPING A MESSAGE

1. Press  to review your messages. The number of messages is announced.
2. Press  at anytime to skip to the next message. Each time  is pressed, the system scans forward one message. If you have several messages, press  to find the message you want to play.
3. Press , at any time to stop reviewing your messages and return to standby. The message counter shows the number of messages stored in memory.



To quickly scroll forwards through a message, press and hold .

DELETING A MESSAGE

To maintain maximum recording time, delete any old messages.

1. Press  to review your messages.
2. Press  anytime during the message to delete.
3. A confirmation tone sounds after the message has been deleted.

You can also delete all the messages.

1. Press . "To delete all messages, press delete again" is announced.
2. Press  again. A confirmation tone sounds after all the messages have been deleted.

If you try to delete all messages without first listening to your new messages, you will hear several short beeps followed by the announcement "Please playback all messages". This protects you from accidentally erasing messages you have not yet reviewed.

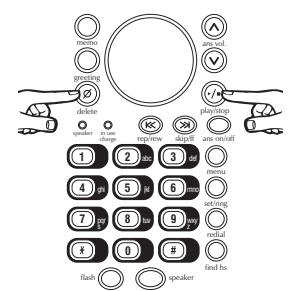
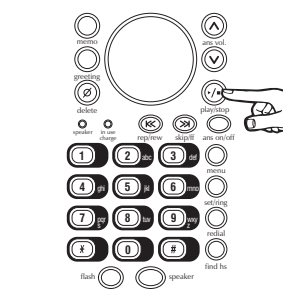



The voice memo function is completely independent of the greeting message.

The voice memo messages are recorded as incoming messages.

VOICE MEMO

The voice memo function allows the user to record messages (up to 10 minutes).

1. Press and **hold** . "Record memo message" is announced and a confirmation tone sounds. [- -] flashes on the message counter.
2. Start your recording.
3. When you have finished, press or to stop recording. A confirmation tone sounds and the system returns to standby.

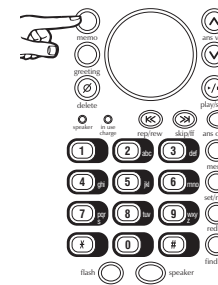



You must enter a command within 15 seconds of entering command waiting mode or the answering system automatically hangs up and returns to standby.

ANSWERING SYSTEM

REMOTE ACCESS AWAY FROM HOME

You can operate your answering system from a remote location using any touch-tone telephone. Use this function to check for recorded messages, to play or delete messages, even to record a new greeting message.

1. Call your telephone number.
2. During the greeting message, press **#** and enter your PIN code (Factory Setting: 80). (See "Setting a Personal Security Code", page 20)
3. The answering system announces the current time and the number of messages stored in memory. Then you hear "To play incoming messages, press **# 2**". For help, press **# 0**".
4. You may continue to listen to the Help Guidance, or you may select a command from the following chart:

Command	Function	Command	Function
# then 1	Repeat a Message	# then 6	Answering System On
# then 2	Playing Incoming Messages	# then 7	Memo Record/Stop*
# then 3	Skipping a Message	# then 8	Greeting Message Record/Stop*
# then 4	Deleting a Message	# then 9	Answer System Off
# then 5	Stop Operation	# then 0	Help Guidance

*For Memo Record and Greeting Message Record function, the first time you enter the corresponding command, it starts the Recording function. If you want to stop the recording, enter the command again.

5. After all of the Help Guidance prompts have played, you hear intermittent beeps indicating that the system is in the command waiting mode. You may enter another command at this time from the chart.
6. When you are finished, hang up to exit the system. The answering system automatically returns to standby.

TURN ON THE ANSWERING SYSTEM REMOTELY

If you have forgotten to turn on your answering system, you can turn it on remotely from any touch-tone telephone.

1. Call your telephone number.
2. After 15 rings, the system will answer. A tone sounds.
3. Press **#** and then enter your PIN code. The answering system announces the number of messages stored in memory. You hear "To play incoming messages, press **# 2**. For help press **# 0**."
4. Press **#** then **6** to turn the answering system on. You will hear the outgoing message and a confirmation tone sounds.
5. Hang up the phone and subsequent calls will be answered by the system.

ANSWERING SYSTEM

NOTES

REMOTE OPERATION CARD

Handy wallet sized instructions for easy use of remote answer machine functions.

Remote Operation Card - Uniden XSA975

PIN Code: /

Remote access away from home:

1. Call your telephone number.
2. During the greeting message, press **#** and enter your PIN code.
3. The answering system announces the current time and the number of messages stored in memory. Then you hear "To play incoming messages, press **# 2**". For help, press **# 0**".
4. You may continue to listen to the Help Guidance, or you may select a command from the chart.

*For Memo Record and Greeting Message Record function, the first time you enter the corresponding command, it starts the Recording function. If you want to stop the recording, enter the command again.

Remote Operation Card - Uniden XSA975

PIN Code: /

Remote access away from home:

1. Call your telephone number.
2. During the greeting message, press **#** and enter your PIN code.
3. The answering system announces the current time and the number of messages stored in memory. Then you hear "To play incoming messages, press **# 2**". For help, press **# 0**".
4. You may continue to listen to the Help Guidance, or you may select a command from the chart.

*For Memo Record and Greeting Message Record function, the first time you enter the corresponding command, it starts the Recording function. If you want to stop the recording, enter the command again.

Remote Operation Card - Uniden XSA975

PIN Code: /

Remote access away from home:

1. Call your telephone number.
2. During the greeting message, press **#** and enter your PIN code.
3. The answering system announces the current time and the number of messages stored in memory. Then you hear "To play incoming messages, press **# 2**". For help, press **# 0**".
4. You may continue to listen to the Help Guidance, or you may select a command from the chart.

*For Memo Record and Greeting Message Record function, the first time you enter the corresponding command, it starts the Recording function. If you want to stop the recording, enter the command again.

Remote Operation Card - Uniden XSA975

PIN Code: /

Remote access away from home:

1. Call your telephone number.
2. During the greeting message, press **#** and enter your PIN code.
3. The answering system announces the current time and the number of messages stored in memory. Then you hear "To play incoming messages, press **# 2**". For help, press **# 0**".
4. You may continue to listen to the Help Guidance, or you may select a command from the chart.

*For Memo Record and Greeting Message Record function, the first time you enter the corresponding command, it starts the Recording function. If you want to stop the recording, enter the command again.

REMOTE OPERATION CARD

Handy wallet sized instructions for easy use of remote answer machine functions.

Command	Function	Command	Function
# then 1	Repeat a Message	# then 1	Repeat a Message
# then 2	Playing Incoming Messages	# then 2	Playing Incoming Messages
# then 3	Skipping a Message	# then 3	Skipping a Message
# then 4	Deleting a Message	# then 4	Deleting a Message
# then 5	Stop Operation	# then 5	Stop Operation
# then 6	Answering System On	# then 6	Answering System On
# then 7	Memo Record/Stop*	# then 7	Memo Record/Stop*
# then 8	Greeting Message Record/Stop*	# then 8	Greeting Message Record/Stop*
# then 9	Answer System Off	# then 9	Answer System Off
# then 0	Help Guidance	# then 0	Help Guidance

Command	Function	Command	Function
# then 1	Repeat a Message	# then 1	Repeat a Message
# then 2	Playing Incoming Messages	# then 2	Playing Incoming Messages
# then 3	Skipping a Message	# then 3	Skipping a Message
# then 4	Deleting a Message	# then 4	Deleting a Message
# then 5	Stop Operation	# then 5	Stop Operation
# then 6	Answering System On	# then 6	Answering System On
# then 7	Memo Record/Stop*	# then 7	Memo Record/Stop*
# then 8	Greeting Message Record/Stop*	# then 8	Greeting Message Record/Stop*
# then 9	Answer System Off	# then 9	Answer System Off
# then 0	Help Guidance	# then 0	Help Guidance

TROUBLESHOOTING

The in use/charge LED wont illuminate when the handset is placed on the base.	<ul style="list-style-type: none"> • Make sure the AC adaptor is plugged into the base and wall outlet • Make sure the handset is properly seated in the base. • Make sure the charging contacts on the handset and base are clean.
The audio sounds weak and/or scratchy	<ul style="list-style-type: none"> • Move the handset and/or base to a different location away from metal objects or appliances and try again. • Make sure that you are not too far away from the base. • Press (select)/channel while on a call to change the operating channel.
Can't make or receive calls.	<ul style="list-style-type: none"> • Check both ends of the telephone cord are plugged in firmly • Make sure the AC adaptor is plugged into the base and wall outlet. • Disconnect the AC adaptor for a few minutes, then reconnect it. • Make sure that you are not too far from the base. • Charge the handset.
The handset doesn't ring or receive a page.	<ul style="list-style-type: none"> • The battery pack may be weak. Charge the battery for 20-25 hours. • The handset may be too far away from the base unit. • Place the base unit away from appliances or metal objects.
Handset number 1 or number 2 not working	<ul style="list-style-type: none"> • Place one handset at a time on the main base for 5 seconds each.
If you still have a problem.	Australia: www.uniden.com.au New Zealand: www.uniden.co.nz

WARRANTY**One Year Limited Warranty**

Important: Evidence of original purchase is required for warranty service.
Warrantor: Uniden Australia Pty Limited A.B.N. 58 001 865 498
Uniden New Zealand Limited

ELEMENT OF WARRANTY: Uniden warrants to the original retail owner for the duration of this warranty, its XSA975 (herein after referred to as the Product), to be free from defects in materials and craftsmanship with only the limitations or exclusions set out below.

WARRANTY DURATION: This warranty to the original retail owner only, shall terminate and be of no further effect 12 months after the date of original retail sale. This warranty will be deemed invalid if the product is; (A) Damaged or not maintained as reasonable and necessary, (B) Modified, altered or used as part of any conversion kits, subassemblies, or any configurations not sold by Uniden. (C) Improperly installed, (D) Repaired by someone other than an authorised Uniden Repair Agent for a defect or malfunction covered by this warranty. (E) Used in conjunction with any equipment or parts or as part of a system not manufactured by Uniden, (F) Warranty is only valid in original country of purchase.

PARTS COVERED: This warranty covers for one (1) year, the Base Unit and Handset only. All accessories (AC Adaptor etc) are covered for 90 days only.

STATEMENT OF REMEDY: In the event that the product does not conform to this warranty at any time while this warranty is in effect, the warrantor at its discretion, will repair the defect or replace the product and return it to you without charge for parts or service. THIS WARRANTY DOES NOT COVER OR PROVIDE FOR THE REIMBURSEMENT OR PAYMENT OF INCIDENTAL OR CONSEQUENTIAL DAMAGES. THIS GUARANTEE IS IN ADDITION TO AND DOES NOT IN ANY WAY AFFECT YOUR RIGHTS UNDER THE CONSUMER GUARANTEE ACT.

PROCEDURE FOR OBTAINING PERFORMANCE OR WARRANTY: In the event that the product does not conform to this warranty, the Product should be shipped or delivered, freight pre-paid, with evidence of original purchase (eg. a copy of the sales docket), to the warrantor at:

UNIDEN AUSTRALIA PTY LIMITED
SERVICE DIVISION
345 Princes Highway,
Rockdale NSW 2216
Fx (02) 9599 3278
www.uniden.com.au

UNIDEN NEW ZEALAND LIMITED
SERVICE DIVISION
150 Harris Road,
East Tamaki, Auckland
Fx (09) 274 4253
www.uniden.co.nz

Customers in other states should ship or deliver the Product freight pre-paid to their nearest Uniden Authorised Repair Centre (Contact Uniden for the nearest Warranty Agent to you).

NOTES

NOTES

For your future reference, please fill in the panel below and attach your Purchase Receipt/Sales Docket.

Serial: _____
(found on the bottom of the product or on the box)

Date of Purchase: _____

Name & Address of Dealer: _____

PIN Code: _____

THANK YOU

FOR PURCHASING A UNIDEN PRODUCT

Uniden

© Uniden Australia Pty Limited
Uniden New Zealand Limited

Printed in China

UCZZ01428ZA

Free Manuals Download Website

<http://myh66.com>

<http://usermanuals.us>

<http://www.somanuals.com>

<http://www.4manuals.cc>

<http://www.manual-lib.com>

<http://www.404manual.com>

<http://www.luxmanual.com>

<http://aubethermostatmanual.com>

Golf course search by state

<http://golfingnear.com>

Email search by domain

<http://emailbydomain.com>

Auto manuals search

<http://auto.somanuals.com>

TV manuals search

<http://tv.somanuals.com>