

Start Here!

1

2

3

Quick Start Guide Next Page...



Quick Start Guide

XSR 917/918

**900 MHz
Caller ID
10 Number Memory
Rocketdial
plus
Clock/Alarm
Radio**

Uniden

INSTALLATION & SAFETY

Choosing the best location for your phone.

When choosing a location for your phone there are a number of appliances the phone should not be near, and areas you should avoid.



This symbol indicates important operating and servicing instructions.



The earcap of this telephone may attract and retain small metallic objects.

AVOID - other cordless phones

AVOID - Television sets and other electronic appliances

CHOOSE - a location next to your bed

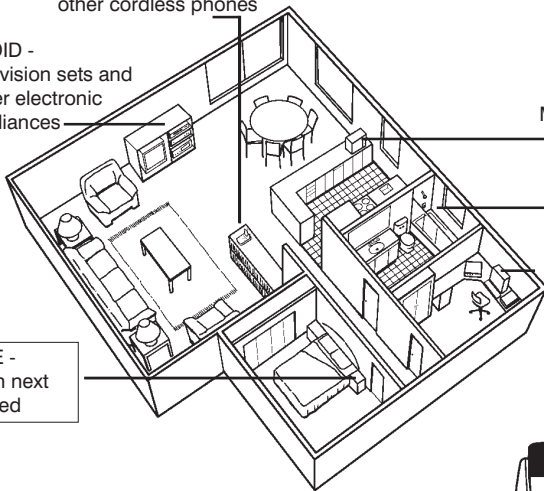

AVOID - Moisture



AVOID - Microwave ovens

AVOID - Moisture

AVOID - Computers

CHARGE - the new phone for 20 - 25 hrs.

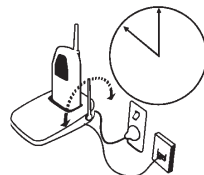

DON'T - overload the power outlet.

AVOID - multi power boards.

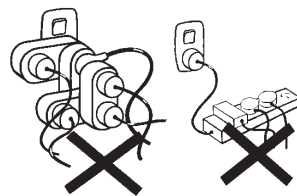

Note: Ringing will not be impaired by adding extra cordless handsets.

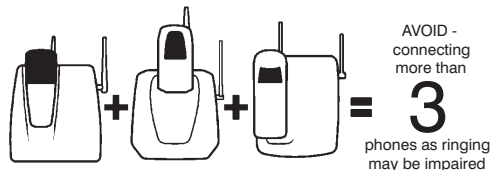

Start Here!

1

2

3

1 Installing the Base Unit

- Plug the telephone cord into the Base Unit, then into the telephone socket on the wall.
- Plug the AC Adaptor cord into the Base Unit, then the AC Adaptor into the wall power point.
- Press the AC Adaptor cord into the curved recess under the Base Unit.

• Radio Antennae:

The AM antenna is built into the main base.

The FM antenna is the thin wire located at the rear of the main base. Unwind the antenna wire, keep straight and extended for radio use.

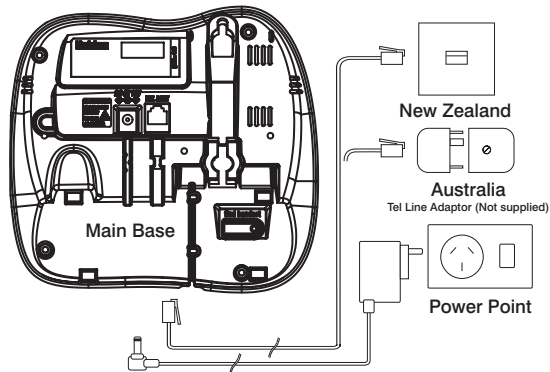

Installing the Charge Cradle (XSR918 only)

- Plug the AC Adaptor cord into the Charge Cradle, then the AC Adaptor into the wall power point.

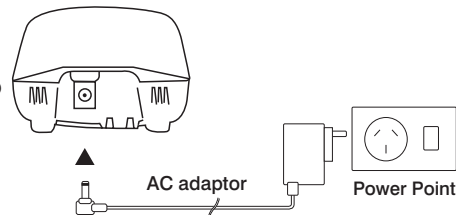

2 Installing the Handset Battery

- Press the battery cover and slide it off.

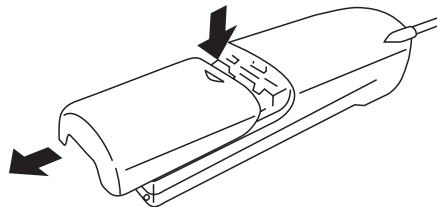

- Connect the battery plug to the socket at the rear of the battery compartment.
Make sure the plug is the right way round.
 The RED and BLACK battery wires must match the RED and BLACK printed on the phone case for the plug to fit properly. Press firmly until it clicks into place.

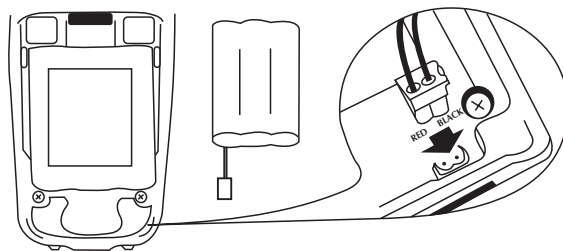

- Position the battery in the compartment and slide the cover into place.

Repeat process for second handset (XSR918 only)

- Place one handset on the main base and place the other handset on the extra charging cradle. It does not matter which handset is placed on the main base and extra charging cradle.

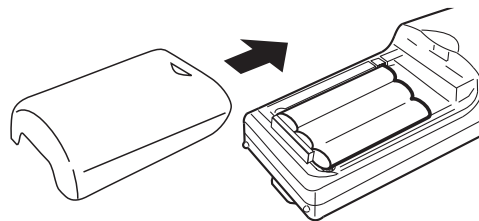

Charging the handset

- Charge the handsets uninterrupted for 20-25 hours each.

3 Making a Call

Registering Your 2nd Handset Before Using (XSR918 only)

After fully charging the handsets, remove the handset from the extra charging cradle and place it on the main base. (The **status** LED will begin to flash indicating registration is occurring).

Wait for at least 5 seconds before removing the extra handset from the **main** base.

The registration has been completed, and your dual handset cordless phone is ready for use.

- Pick up the handset and press **(talk)**. Dial the phone number
OR
Dial the phone number - then press **(talk)**
- To hang up - press **(end)**
OR
Place the handset on the Base Unit.

Call Transfers

TO TRANSFER CALLS (XSR918 only)

To transfer your call from handset 1 to handset 2:

- Press **(transfer)**.
- The call is placed on hold on the first handset, while handset 2 begins to ring.
- The call is transferred when the 2nd handset is answered.
- Repeat the process to transfer the call back to handset 1. Calls can be transferred from either handset.







Answering a Call

- Handset on the Base Unit:
Remove the handset from the base and speak (*Auto Talk*).
- Handset off the Base Unit:
Pick up the handset, press any key and speak.
- To hang up - press **(end)**
OR
Place the handset on the Base Unit.



If the transferred call is not picked up after 5 minutes, the call will be disconnected.

4 Using the Radio







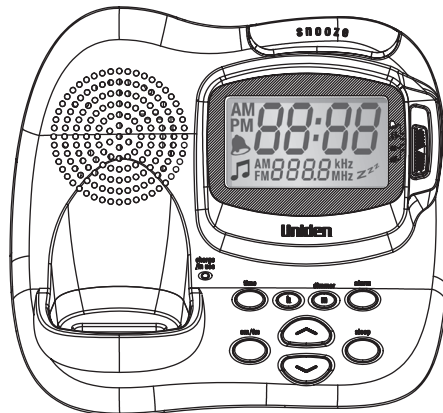

- To turn ON the radio, move the slide switch to the 'on' position.
- Select modulation by pressing 
- Search for the desired station frequency by pressing Channel  or 
- You can automatically search for the next available station frequency by pressing Channel  or  for 1 second.
- Press  to search for a higher frequency and  to search for a lower frequency.
- The radio's volume can be adjusted using the Volume knob on the side of the base.

For Radio Reception;

- AM Radio: The AM antenna is built into the main base, simply rotate the base for clearest reception.
- FM Radio: The FM Antenna is the thin wire located at the rear of the main base. Unwind the antenna wire. Keep the antenna wire straight and adjust the position for clearest reception.
- To turn OFF the radio, move the slide switch to the 'off' position.



5 Setting the Clock

- To change the hour setting, press  while pressing .
- Each press of  while pressing  increments the hour display by one hour. PM displays for an afternoon time. AM is not displayed.
- To change the minute setting, press  while pressing .
- Each press of  while pressing  increments the minute display by one minute.

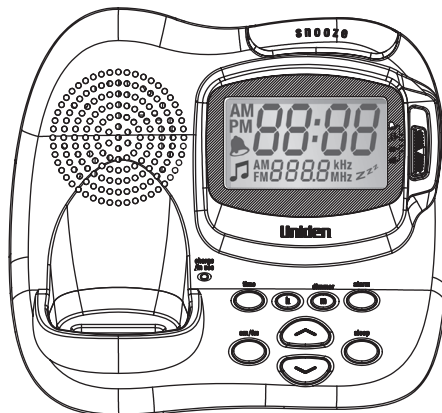

CONTENTS

Installation & Safety	i	Memory Dialing from Talk Mode	12
Quick Start Guide		Chain Dialing	12
Installing the Base Unit	ii	Editing a Stored Name and/or Phone Number	13
Installing the Handset Battery	iii	Erasing a Stored Name and/or Phone Number	13
Making a Call	iv	Call Transfer	14
Answering a Call	iv	Rocketdial	
Call Transfers	iv	Rocketdial	15
Using the Radio	v	Storing and Editing the Rocketdial	15
Setting the Clock	vi	Making Calls with Rocketdial	15
Contents	vii	Deleting the Rocketdial	15
Getting Started		Caller ID	
Controls and Functions	1	Caller ID	16
Uniden Company Philosophy	3	When the Telephone Rings	16
Welcome/Features	3	Viewing the Caller ID Message List	17
Included in your Package	4	Deleting Information from the Caller ID List	17
Mounting the Base Unit on a wall	5	Deleting a Caller ID Message	17
Battery Maintenance	6	Deleting all Caller ID Names and Numbers	17
Installing the Beltclip	6	Calling a Party from the Caller ID List	18
Headset Installation	6	Dial Edit	18
Using your Phone		Storing Caller ID messages in Memory Dialing	18
Setting Menu Options	7	Using your Radio	19
Auto Talk	7	Setting the Clock	20
Pop Up Name	7	Setting the Alarm/Buzzer	20
Making and Receiving Calls	8	Using the Snooze Function	22
Adjusting the Handset Ringer Volume and Earpiece Volume	9	Using the Sleep Function	22
Redial	9	Display Brightness	23
Traveling Out-of-Range	9	Troubleshooting	24
Selecting a different channel	10	Memo	25
Find Handset	10	Warranty	27
Call Waiting/Flash	10		
Memory Dialing			
Storing Phone Numbers and Names	11		
Making Calls with Memory Dialing	12		



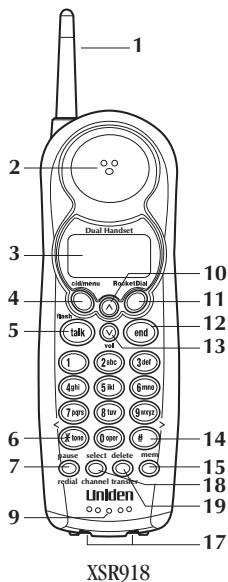
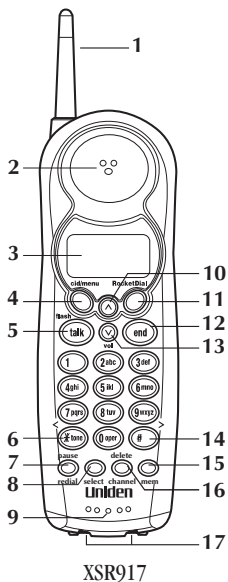





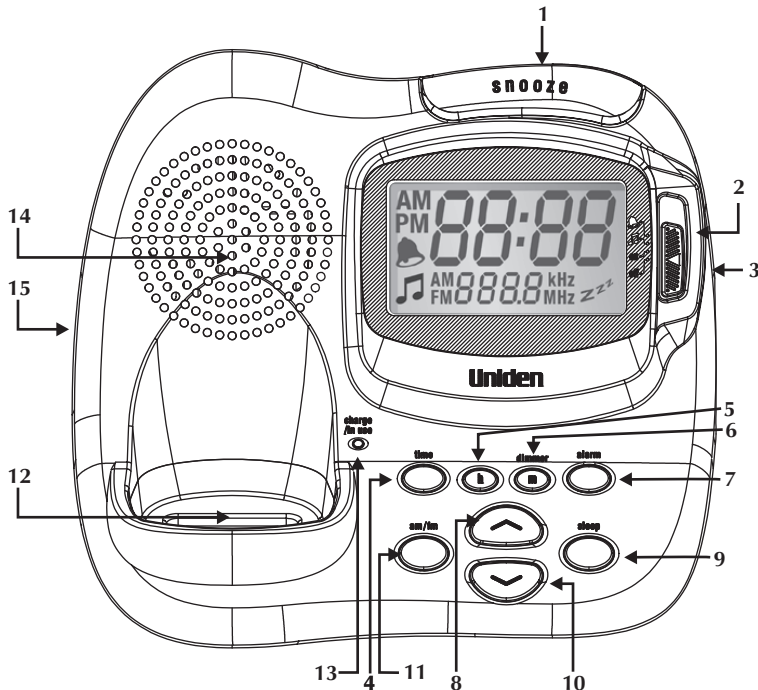



CONTROLS AND FUNCTIONS



1. Handset antenna
2. Handset earpiece
3. LCD display
4. **cid**/menu key
5. **talk**/flash key
6. *****/**<** key
7. **redial**/pause key
8. **select** key (XSR917 only)
9. Handset microphone and ringer speaker
10. **^** Volume up key
11. **Stacked Dial** key
12. **end** key
13. **v** Volume down key
14. **#**/**>** key
15. **mem** key
16. **delete**/channel key (XSR917 only)
17. Handset charging contacts
18. **select**/channel key (XSR918 only)
19. **erase**/delete key (XSR918 only)

CONTROLS AND FUNCTIONS



- 1 Snooze 
- 2 Slide Switch 
- 3 Volume Knob 
- 4 Time Key 
- 5 Hour Key 
- 6 Minute/Dimmer Key 
- 7 Alarm (alarm) Key 
- 8 Channel  Key
- 9 Sleep Key 
- 10 Channel  Key
- 11 AM/FM  Key
- 12 Base Charging Contacts
- 13 Charge/In use LED 
- 14 Base Speaker
- 15 Find handset Key (at underside)

UNIDEN COMPANY PHILOSOPHY

To bring outstanding wireless communication products to people's lives throughout the world.

WELCOME

Congratulations on your purchase of this Uniden cordless telephone. This is designed for reliability, long life and outstanding performance utilising the latest in 900MHz Technology.

FEATURES

- Multiple Handsets (up to 2 with XSR918)
- 900MHz SCR Technology (Sound Clarity and Range)
- Caller ID Display*
- Pop Up Name - Caller Name Identification #
- 30 Caller ID Memories
- Alphanumeric Memory Dialing
- Super Chat Battery - 10 Hours Talk Time
- Maxi-Sound - Extra Loud Handset Volume Control
- Rocketdial - One Touch VIP Dial
- 12 Days Standby Time XSR918, 20 Days XSR917
- LCD Back Light
- Wall or Desk Mountable
- Page/Find Handset Feature
- AutoTalk
- 32 Digit Redial
- Pause
- Flash
- 2 Type Tone Ringer
- 3 Step Ringer Volume Control
- Clock/Radio
- Alarm with Snooze

NOTES

- * Caller ID feature only works if you subscribe to the service by your local telephone company. There is usually a fee for this service.
- # Pop Up Name feature only works if you subscribe to your telephone company Caller ID service and record names into your phones memory.

INCLUDED IN YOUR PACKAGE

Make sure you have received the following items in the package. If any of these items are missing or damaged, contact the Uniden Parts Department.

XSR917 only includes one(1) item of each shown below, except for the charge cradle which is not included.

Super Chat
Rechargeable Battery

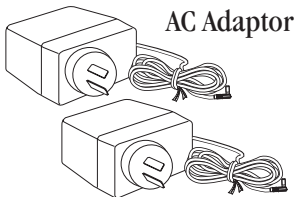
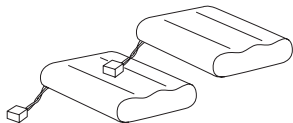

AC Adaptor

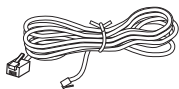

Telephone Cord



Charge Cradle

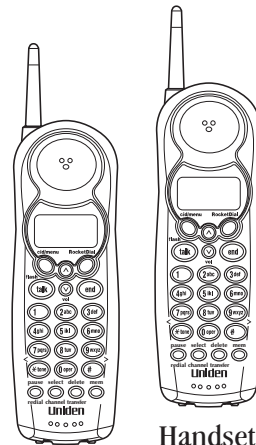

Handset

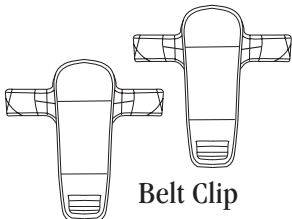

Belt Clip



Owners Manual



Base Unit

MOUNTING THE BASE UNIT ON A WALL

Direct wall mounting

You can mount your phone directly to the wall. Before doing this, consider the following:

- Avoid electrical cables, pipes or other items behind the mounting location that could cause a hazard when inserting screws into the wall.
 - Mount your phone within distance of a working phone jack.
 - Make sure the wall material is capable of supporting the weight of the base and handset.
 - Use screws with anchoring devices suitable for the wall material where the base unit will be placed.
1. Insert two mounting screws into a wall (with their appropriate anchoring device), 10cm apart. Allow about 3mm between the wall and screw heads for mounting the phone.
 2. Plug the AC adaptor into the Base Unit and then into a power point.
 3. Plug the telephone cord into the Base Unit and then into the telephone socket on the wall.
 4. Align the mounting slots on the base with the mounting posts on the wall.
Then push in and down until the phone is firmly seated.

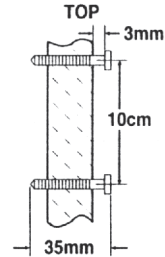



Use only the genuine Uniden Super Chat Battery supplied with your phone. Replacement Super Chat Batteries are available through the Uniden Parts Department.



If you are using an optional headset, you must still use the handset keypad for phone operations.

BATTERY MAINTENANCE

Battery use time (per charge)

- 10 hours continuous use
- 12 days when handset is in the standby mode.XSR918, 20 Days XSR917.

When the Battery charge becomes low

If the phone is not in use, the 'Low Battery' flashes and none of the keys will operate. If the phone is in use, the 'Low Battery' flashes and the handset beeps. Complete your conversation as quickly as possible and return the handset to the base unit for charging.

- You cannot overcharge the battery.
- You may return the handset to the charger after each call or when the battery is low.

Cleaning the charging contacts

To maintain a good charge, it is important to clean the charging contacts on the handset base unit and additional charge cradle with a dry cloth or a pencil eraser about once a month. Do not use any liquids or solvents.

INSTALLING THE BELTCLIP

To attach the beltclip:

Insert the beltclip into the holes on each side of the handset. Press down until it clicks.

To remove the beltclip:

Pull both sides of the beltclip to release the tabs from the holes.

HEADSET INSTALLATION

Your phone may be used with an optional headset. To use this feature, simply plug the headset into the headset jack.

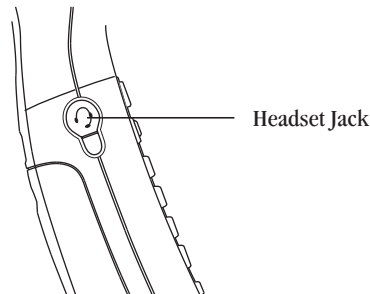



NOTE

Functions will need to be programmed in both handsets separately.
(XSR918 only)

SETTING MENU OPTIONS

Options available include AutoTalk and Pop Up Name.

AUTOTALK

AutoTalk allows you to answer the phone without pressing the **(talk)** button. If the phone rings when Autotalk is on, simply remove the handset from the base and the phone automatically answers the call. If the phone rings when Autotalk is off, you must press **(talk)** to answer the call.

POP UP NAME

If the displayed Caller ID telephone number is **exactly** the same as a number stored in memory, then the stored name will also be displayed with the caller ID telephone number.

To change your Auto Talk and Pop Up Name (Name Tag)

1. Press and hold **(cid)/menu**. The following screen appears.

```

1 ▶ Auto Talk :On
2 Name Tas  :On
    
```

2. Use **(^)** and **(v)** or a number key **(1)** and **(2)** to move the pointer to the selection that you would like to change. Press **(select)** to toggle between 'On' and 'Off' for Auto Talk and Pop Up Name (Name Tag).
3. Press **(end)** and return the handset to the base unit. The handset returns to the standby mode.



Refer to page 7 "Setting Menu Options" to turn on the Autotalk feature if desired.

MAKING AND RECEIVING CALLS

	Handset On Base	Handset Off Base/Charger
To answer a call	Pick up the handset (<i>Autotalk on</i>) or pick up the handset and press (talk) .	Press (talk) , any number, (*) or (#) (<i>Autotalk on</i>).
To make a call	<ol style="list-style-type: none"> Pick up the handset. Press (talk). Listen for the dial tone. Dial the number. <p style="text-align: center;">OR</p> <ol style="list-style-type: none"> Pick up the handset. Dial the number, then press (talk). 	<ol style="list-style-type: none"> Press (talk). Listen for dial tone. Dial the number. <p style="text-align: center;">OR</p> <p>Dial the number then press (talk).</p>
To hang up	Press (end) , or return the handset to the base/charger (<i>Auto Standby</i>).	Press (end) , or return the handset to the base/charger (<i>Auto Standby</i>).
To redial	<ol style="list-style-type: none"> Pick up the handset. Press (talk). Listen for the dial tone. Press (redial). <p style="text-align: center;">OR</p> <ol style="list-style-type: none"> Pick up the handset. Press (redial), then press (talk). 	<ol style="list-style-type: none"> Press (talk). Listen for the dial tone. Press (redial). <p style="text-align: center;">OR</p> <p>Press (redial), then press (talk).</p>

ADJUSTING THE HANDSET RINGER VOLUME AND EARPIECE VOLUME



The transfer ring tone and volume can not be adjusted.





Settings will need to be programmed in both handsets separately. (XSR918 only)

Handset ringer tone and volume

Press **(^)** or **(v)** in standby mode to select one of five ringer tones and volume combinations. The telephone will keep this setting for all future calls.

Earpiece Volume

Pressing **(^)** or **(v)** during a call will change the earpiece volume of the handset. The telephone will keep this setting for all future calls.

Volume Maximum  Volume High  Volume Medium  Volume Low

Ringer Mute

You can temporarily mute the ringer tone. When the handset is off the base and the phone is ringing, press **(end)**. The ringer tone will return to normal with the next incoming call.

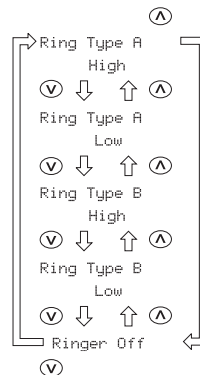

REDIAL

The **(redial)** key redials the last number dialed. The redialed number can be up to 32 digits long.

1. Press **(talk)**.
2. Press **(redial)**. The last number dialed will be called.

or

Press **(redial)**, then **(talk)**. The last number dialed will be called.

TRAVELLING OUT-OF-RANGE

During a call, noise will increase if you move your handset too far from your base unit. If the range limit of your base unit is exceeded, your call will terminate within five minutes.



You must subscribe through your local telephone company to receive Call Waiting services.

SELECTING A DIFFERENT CHANNEL

If you encounter interference while using your phone, you can manually change the phone's channel for clear operation. This function works only when the phone is in use.
Press **(select)**/channel (for XSR918) or **(delete)**/channel (for XSR917). 'Scanning' appears on the display, indicating the phone is changing to another channel.

FIND HANDSET

To locate a handset/s (while it's off the base), press  under the base. The handset/s beeps for 60 seconds.

Handset/s will ring when paged. Paging is cancelled by pressing any key on either handset.

OR Press  again to cancel paging.

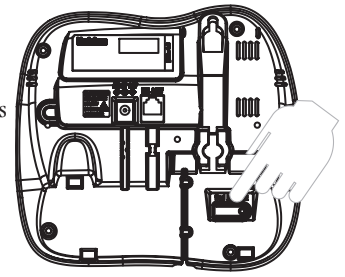

CALL WAITING/FLASH

If the call waiting tone sounds during a call:

AUSTRALIA: Press **(talk)**/flash, then **(2)** to switch between callers.

NEW ZEALAND: Press **(talk)**/flash to switch between callers.

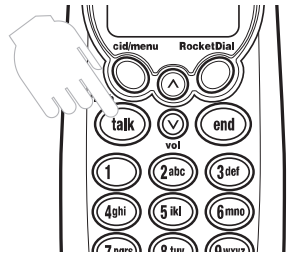



In memory dialling operation, you must press a key within 30 seconds or the phone will return to standby.



The pause feature is useful for long distance calling, credit card dialling or sequences of numbers that require a pause between digits.

STORING PHONE NUMBERS AND NAMES

Memory Dialing allows you to dial a number using just a few key presses. Your XSR917/918 stores up to 10 names/numbers in each handset.

1. Press and hold **(mem)**, 'MemoryStore' is displayed.
2. Press **(^)** or **(v)** or enter a number (**(0)** - **(9)**) to select the memory location where you would like to store the number.
3. Press **(select)** 'StoreName' is displayed on the screen and a cursor flashes indicating that the display is ready for a name to be entered.

If the screen shown to the right appears, the selected memory location is already stored. Then you must either edit the entry in this location, delete the entry in this location (page 13) or select "GoBack" to choose another location.

4. Use the Alpha Numeric keys to enter a name. The name cannot exceed 14 characters.
 - Use **(left)** and **(right)** to move the cursor to the desired location.
 - Use **(transfer/delete)** to delete characters as needed.
 - Press and hold **(transfer/delete)** to delete all the characters.
 - If a name is not required, go to step 5.
5. Press **(select)**, 'StoreNumber' is displayed. The cursor flashes indicating that the display is ready for the number to be entered.
6. Use the number keys to enter the phone number. The phone number cannot exceed 20 digits. Use the **(redial/pause)** to enter a pause in the dialing sequence if required. The display shows a 'P'. Each pause counts as one digit and represents a two second delay of time between the digits. Use **(transfer/delete)** to delete digits as needed.
7. Press **(select)**, you will hear a confirmation tone, and the following screen appears. Memory storage is complete. For example, if you store a number into the memory location number 1, the display shows 'Memory 1 Stored'. After about 2 seconds, 'MemoryStore' is displayed. Repeat steps 2-7 to store more numbers.
8. Press **(end)** to return to standby mode.

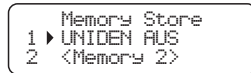
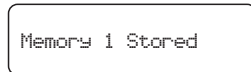
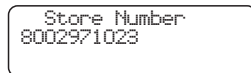
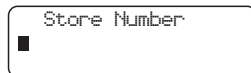
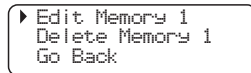
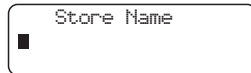
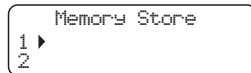



NOTE

Numbers stored in one handset can not be accessed from the other.

MAKING CALLS WITH MEMORY DIALING

Memory dialing from Standby Mode.

1. Press **(mem)**. The handset displays your programmed memory locations.
2. Press **(^)** or **(v)**, or enter the number **(0 - 9)** to select the memory location you would like to dial.
3. Press **(talk)** 'Talk' and the volume settings are displayed. Then the displayed number is dialed.

1	▶ UNIDEN AUS
2	JOE BLOGGS
3	JOHN DOE

Talk	
0800123456789	

Display a Programmed Number

Press **(mem)**. The handset displays your programmed memory locations.

Use **(>)** and **(<)** to toggle between the names and numbers displayed.

1	UNIDEN AUS
2	JOE BLOGGS
3	▶ JOHN DOE



1	0800123456789
2	5452930
3	▶ 6567983

MEMORY DIALING FROM TALK MODE

1. Press **(talk)**. 'Talk' and the volume setting appears.
2. Press **(mem)**.
3. Enter a number **(0 - 9)** to select the memory location of the desired phone number. The selected phone number is displayed. Then the number is dialed. If the memory location selected does not have a number stored, a series of beeps is sounded.
4. To hang up, press **(end)**.

CHAIN DIALING

On certain occasions after dialing a number, you may be required to enter an access code such as your account number for phone banking. You can enter this number into a memory location for later use by doing the following:

1. Store the access code into one of the memory locations **(0 - 9)** following the steps on page 11.
2. Dial the party or service main number.
3. When you need to enter the special number, press **(mem)** followed by the memory location **(0 - 9)**.

EDITING A STORED NAME AND/OR PHONE NUMBER

1. Press and hold **(mem)**. 'Memory Store' is displayed.
2. Press **(^)** or **(v)**, or enter a number (**(0)** - **(9)**) to select the memory location you would like to edit.
3. Press **(select)**. The memory location is displayed.
4. Press **(select)** to select 'Edit Memory'. The cursor flashes indicating that the display is ready for the name to be edited. When a name has not been stored, the cursor appears at the beginning of the second line.
5. Use the number keys, **(←)**, **(→)**, or **(trans)**/delete to edit the name. To edit only the phone number, skip this step.
6. Press **(select)**. The cursor flashes indicating that the display is ready for the number to be edited.
7. Use the number key, **(redial)**/pause and **(trans)**/delete to edit the phone number. The phone number cannot exceed 20 digits. If you don't want to change the phone number, skip this step.
8. Press **(select)**. You hear a confirmation tone. Memory Storage is complete. For example, if you store a name and number into memory location number 1, the display shows 'Memory 1 Stored'. After about 2 seconds, 'Memory Store' is displayed.
9. Press **(end)** to return to standby mode.

ERASING A STORED NAME AND/OR PHONE NUMBER

1. Press and hold **(mem)**. 'Memory Store' is displayed.
2. Press **(^)** or **(v)** or enter a number (**(0)** - **(9)**) to select the memory location you would like to erase.
3. Press **(select)**.
4. Press **(v)** to move the pointer down to 'Delete Memory'.
5. Press **(select)**.
6. Press **(^)** to move the pointer to 'Yes'.
7. Press **(select)**. A confirmation tone is sounded.
8. After about 2 seconds, 'Memory Store' is displayed. You may delete the information in another memory location (return to step 2) or press **(end)** to return to standby mode.

CALL TRANSFER (XSR918 only)**CALL TRANSFERS**

To have the ability to transfer calls from one handset to the other handset:

Setup:

- Remove the first handset from the main base unit.
- Place the second handset on the main base unit for 5 seconds to initiate the automatic digital security code setting.

TO TRANSFER CALLS

To transfer your call from handset 1 to handset 2:

- Press *transfer* / Delete.
- The call is placed on hold on the first handset, while handset 2 begins to ring. The call is transferred when the 2nd handset is answered.
- Repeat the process to transfer the call back to handset 1. Calls can be transferred from either handset.



Memory Location for Rocketdial is independent from memory location for memory dial.



If the Rocketdial does not have a stored number, the handset will beep rapidly and the phone will not dial.

ROCKETDIAL

You can store your most frequent dialed number in the Rocketdial location on each handset. The Rocketdial allows you to dial a number with one key press (there is no need to press **(talk)**. The phone will automatically dial the number stored).

STORING AND EDITING THE ROCKETDIAL

1. When the phone is in standby mode, press and hold **(Rocket Dial)**. The following 'Store Number' display appears.
If the following 'Edit Number' screen appears, there is a number already stored. Press **(^)** to **(v)** to select 'Edit Number' then press **(select)**.
2. Store the number by following step 6 under "Storing Phone Numbers and Names" on page 11.
3. Press **(select)**. A confirmation tone is sounded, and 'Number Stored' appears. Memory storage is complete.

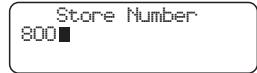
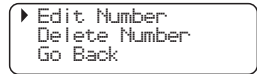
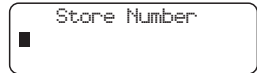

MAKING CALLS WITH ROCKETDIAL

When the phone is in the standby mode, simply press **(Rocket Dial)**. The number stored in the Rocketdial memory location is instantly dialed.

DELETING THE ROCKETDIAL

1. When the phone is in the standby mode, press and hold **(Rocket Dial)**. The following display appears.
2. Press **(^)** or **(v)** to select 'Delete Number'.
3. Press **(select)**. The following display appears.
4. Press **(^)** to move the pointer to 'Yes'.
5. Press **(select)**. A confirmation tone is sounded, and the following display appears. After about 2 seconds, the handset returns to standby mode.

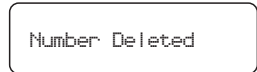
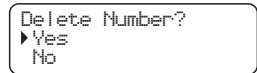
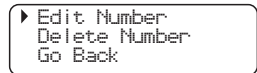

CALLER ID

You must subscribe to a Caller ID service to use these facilities. When the telephone rings, the Caller ID feature allows you to view the caller's name and phone number on the display before you answer the telephone.

The handset displays the phone number of the incoming call, the name, time and number of calls. Additionally, you can dial the displayed number and store the information for memory dialing.

WHEN THE TELEPHONE RINGS

When the Caller ID message is received, the display shows the caller's phone number along with the date and time. The incoming call information is stored in the Caller ID record. If the Caller ID service includes the callers name, the caller's name appears on the display (currently not supported in Australia or New Zealand).



If you answer a call before the Caller ID message is received (Example: before the second ring), the Caller ID message will not appear.

The date and time received — 21/12 12:30PM
Caller's name — JIM STATEN
Caller's phone number — 0295979035

Here are some typical displays:

When the mobile phone number and date are received.

21/12 12:30PM
Mobile
0295979035

When invalid data is received.

Incomplete Data

When a private number is received.

21/12 12:30PM
Private

When an unknown number is received.

21/12 12:30PM
Unavailable

When a call is coming from a payphone (Australia only).

21/12 12:30PM
PayPhone



In Caller ID operation, if no key is pressed for more than 30 seconds, an error tone sounds and the telephone returns to the standby mode.



If you get an incoming call or page, the deleting operation is cancelled so you can answer the call or page.



Caller ID numbers need to be deleted from each handset separately.

VIEWING THE CALLER ID MESSAGE LIST

The Caller ID list stores information for up to 30 incoming calls - even unanswered calls.

1. Press **(cid)/menu**. The summary screen appears. The screen shows the number of new messages and total messages.
2. Press **(V)** to display the latest Caller ID message.
3. Press **(V)** to see the next message. Or press **(^)** to see the previous message.
4. Press **(end)** to return to standby mode.

DELETING INFORMATION FROM THE CALLER ID LIST

The XSR917/918 stores up to 30 messages. If the phone receives the 31st message, the oldest one in the list is automatically deleted. Caller ID data can also be deleted manually.

DELETING A CALLER ID MESSAGE

1. Press **(cid)/menu**. Display the message to be deleted from the Caller ID list by pressing **(^)** or **(V)**.
2. Press **(transfer)/delete**.
3. Press **(^)** or **(V)** to select 'Yes' or 'No'.
4. Press **(select)** or **(transfer)/delete**.

When the pointer is at 'Yes':

A tone sounds and the Caller ID message is deleted. The next Caller ID message is then displayed.

When the pointer is at 'No':

The display returns to Caller ID message.

DELETING ALL CALLER ID NAMES AND NUMBERS

1. Press **(cid)/menu**.
2. Press **(transfer)/delete**.
3. Press **(^)** or **(V)** to select 'Yes' or 'No'.
4. Press **(select)** or **(transfer)/delete**.

When the pointer is at 'Yes':

A tone sounds all stored Caller ID messages are deleted.

When the pointer is at 'No':

The display returns to the summary screen.

CALLING A PARTY FROM THE CALLER ID LIST

You can place a call from the Caller ID list.

1. Press **(cid)/menu** . Select the phone number that you want to dial by pressing **(V)** or **(^)** .
2. Press **(talk)** . The displayed phone number dials automatically.

DIAL EDIT

You can temporarily edit the Caller ID number that is displayed by pressing **(select)** . A cursor appears in the display. Press **(number)/delete** to move the cursor left, make your changes and then press **(talk)** . This will not change the number in the Caller ID list memory.

STORED CALLER ID MESSAGES IN MEMORY DIALING

Messages shown in the Caller ID list can be stored in memory dialing. Using the incoming call information (i.e., Caller ID list), the phone number of the party on the Caller ID can be stored in memory.

1. Press **(cid)/menu** . Select the phone number to be stored from the Caller ID list by pressing **(^)** or **(V)** .
2. Press **(mem)** .
3. Press **(^)** or **(V)** to enter a number **(0) - (9)** to select the memory location to be stored.
4. Press **(select)** . You hear a confirmation tone and the number is stored in memory. The display returns to the Caller ID list.
5. Press **(end)** to return to standby mode.

If a message has already been stored in the selected memory number location, a confirmation screen is displayed. Press **(^)** to select 'Yes'. Press **(select)** to replace. The display returns to the Caller ID list.



You cannot store a Caller ID message if no phone number appears in the message.

USING YOUR RADIO

To turn ON the radio

Move the slide switch to the on position.
The current frequency (station) is displayed under the clock display.

The station frequency shown will be the same as the one used last time.
kHz is displayed while receiving AM and **MHz** is displayed while receiving FM.

To turn OFF the radio

Move the slide switch to the off position.
The frequency will disappear from the display.

To change bands (AM-FM)





Press  to toggle. The station frequency shown will be the same as the one used last time.

Volume & Frequency

The radio's volume can be adjusted using the Volume knob.







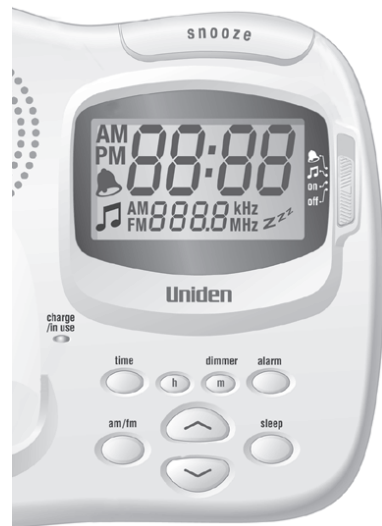

The receiving frequency can be changed by pressing  or . The frequency steps are +/- 9kHz for AM and +/- 0.1MHz for FM.



CH (Channel) Search

You can automatically search for the next available station or channel frequency by pressing  or  for 1 second. Press  to search for a higher frequency and  to search for a lower frequency.







SETTING THE CLOCK

To change the hour setting, press  while pressing . Each press of  while pressing  increments the hour display by one hour (12 hour clock). PM displays for afternoon time. AM is not displayed. To change the minute setting, press  while pressing . Each press of  while pressing  increments the minute display by one minute.

For quick step up & cycle, press and hold  or  while pressing  for more than 1 seconds.





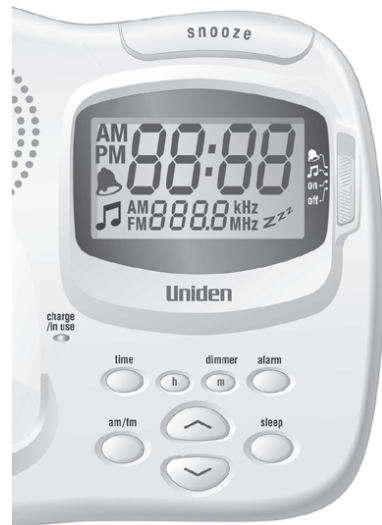

The current time will display with flashing colon

SETTING THE ALARM/BUZZER TIME

To set the Alarm time, press  or  while pressing . The operation is the same as setting the Clock time above. You can check the Alarm time by pressing .



SETTING THE ALARM/BUZZER ON

To set the Alarm/Buzzer ON, move slide switch to  or  position. The  position is for Buzzer and the  icon shows on the display. The  position is for Alarm and the  icon shows on the display.

Once turned on the Alarm/Buzzer will trigger once the current time matches the Alarm/Buzzer time.



The Alarm (radio) will activate using the radio station frequency used last.

The volume of the Alarm depends on the radio volume set (see Using Your Radio - Volume & Frequency, page 19)

The Buzzer volume is constant.

The Alarm will activate for 10 minutes and the Buzzer will activate for 5 minutes. After this time they will deactivate and the set mode will continue.

TURNING THE ALARM/BUZZER OFF

To turn off the Alarm or Buzzer, move slide switch to 'on' or 'off' position. If slide switch is moved to  or  position then activation will change to the selected setting and the activation time (5 or 10 minutes) will restart.



NOTE

When alarm/buzzer activates only the (Snooze), (find handset) and slide sw are usable.



USING THE SNOOZE FUNCTION

The Snooze function stops the Alarm/Buzzer momentarily. The Alarm/Buzzer starts again after 10 minutes.

When the Alarm/Buzzer activates you can select the Snooze function by pressing the  button.



You can keep selecting the Snooze function up to 6 times. When you select Snooze for the 6th time the Alarm/Buzzer deactivates and Alarm set mode starts.

Moving the slide switch to the 'on' or 'off' position cancels Snooze function.

USING THE SLEEP FUNCTION

The Sleep function allows you to set a time delay to turn the radio off. The available sleep times (delayed turn off) are 60,45,30 & 15 minutes.

To Set Sleep Time

The Sleep function can be set up in any slide sw position except 'on'. Press  to enter Sleep mode. Press  repeatedly to select desired time delay. The sleep time (60,45,30,15) will display during selection.

The display shows Zzz to indicate Sleep function set. You can check the remaining time by pressing .

Move the slide sw to any position to turn off the Sleep function.



DISPLAY BRIGHTNESS

The brightness of the LCD can be set as High, Low or Off.
Press  to select the desired brightness.



TROUBLESHOOTING

The charge/Inuse LED won't illuminate when the handset is placed on the base.	<ul style="list-style-type: none"> ● Make sure the AC adaptor is plugged into each base and wall outlet. ● Make sure the handset is properly seated in the base. ● Make sure the charging contacts on each handset and base are clean.
The cordless phone audio sounds weak and/ or scratchy.	<ul style="list-style-type: none"> ● Move the handset and/or base to a different location away from metal objects or appliances and try again. ● Press (select)/channel while on a call to change the operating channel. ● Make sure that you are not too far away from the base.
Can't make or receive calls.	<ul style="list-style-type: none"> ● Check both ends of the telephone line cord are plugged in firmly. ● Make sure the AC adaptor is plugged into the base and wall outlet. ● Disconnect the AC adaptor for a few minutes, then reconnect it. ● Make sure that you are not too far from the base. ● Charge the handset.
The handset doesn't ring or receive a page.	<ul style="list-style-type: none"> ● The battery pack may be weak. Charge the battery for 20-25 hours. ● The handset may be too far away from the base unit. ● Place the base unit away from appliances or metal objects.
Handset number 1 or number 2 not working.	<ul style="list-style-type: none"> ● Place one handset at a time on the main base for 5 seconds each.
The Caller ID does not display.	<ul style="list-style-type: none"> ● The handset was picked up before the second ring. ● The call was placed through a switchboard. ● Call your local telephone company to verify your Caller ID service is current.
The radio/clock/alarm does not function.	<ul style="list-style-type: none"> ● Make sure the AC adaptor is plugged into the base. ● Adjust the volume control knob. ● For AM radio simply rotate the base for clearest reception. ● For FM radio keep the antenna wire straight and adjust the position for clearest reception.
If you still have a problem.	Australia: www.uniden.com.au New Zealand: www.uniden.co.nz

MEMO

MEMO

MEMO

MEMO

WARRANTY

One Year Limited Warranty

Important: Evidence of original purchase is required for warranty service.
Warrantor: Uniden Australia Pty Limited A.B.N. 58 001 865 498
Uniden New Zealand Limited

ELEMENT OF WARRANTY: Uniden warrants to the original retail owner for the duration of this warranty, its XSR917/918 (herein after referred to as the Product), to be free from defects in materials and craftsmanship with only the limitations or exclusions set out below.

WARRANTY DURATION: This warranty to the original retail owner only, shall terminate and be of no further effect 12 months after the date of original retail sale. This warranty will be deemed invalid if the product is; (A) Damaged or not maintained as reasonable and necessary, (B) Modified, altered or used as part of any conversion kits, subassemblies, or any configurations not sold by Uniden. (C) Improperly installed, (D) Repaired by someone other than an authorised Uniden Repair Agent for a defect or malfunction covered by this warranty, (E) Used in conjunction with any equipment or parts or as part of a system not manufactured by Uniden, (F) Warranty is only valid in original country of purchase.

PARTS COVERED: This warranty covers for one (1) year, the Base Unit and Handset only. All accessories (AC Adaptor etc) are covered for 90 days only.

STATEMENT OF REMEDY: In the event that the product does not conform to this warranty at any time while this warranty is in effect, the warrantor at its discretion, will repair the defect or replace the product and return it to you without charge for parts or service. **THIS WARRANTY DOES NOT COVER OR PROVIDE FOR THE REIMBURSEMENT OR PAYMENT OF INCIDENTAL OR CONSEQUENTIAL DAMAGES. THIS GUARANTEE IS IN ADDITION TO AND DOES NOT IN ANY WAY AFFECT YOUR RIGHTS UNDER THE CONSUMER GUARANTEE ACT.**

PROCEDURE FOR OBTAINING PERFORMANCE OR WARRANTY: In the event that the product does not conform to this warranty, the Product should be shipped or delivered, freight pre-paid, with evidence of original purchase (eg. a copy of the sales docket), to the warrantor at:

UNIDEN AUSTRALIA PTY LIMITED
SERVICE DIVISION
345 Princes Highway,
Rockdale NSW 2216
Fx (02) 9599 3278
www.uniden.com.au

UNIDEN NEW ZEALAND LIMITED
SERVICE DIVISION
150 Harris Road,
East Tamaki, Auckland
Fx (09) 274 4253
www.uniden.co.nz

Customers in other states should ship or deliver the Product freight pre-paid to their nearest Uniden Authorised Repair Centre (Contact Uniden for the nearest Warranty Agent to you).

THANK YOU

FOR PURCHASING A UNIDEN PRODUCT

Uniden

© 2004 Uniden Australia Pty Limited

Uniden New Zealand Limited

Printed in China

UCZZ01438ZZ

Free Manuals Download Website

<http://myh66.com>

<http://usermanuals.us>

<http://www.somanuals.com>

<http://www.4manuals.cc>

<http://www.manual-lib.com>

<http://www.404manual.com>

<http://www.luxmanual.com>

<http://aubethermostatmanual.com>

Golf course search by state

<http://golfingnear.com>

Email search by domain

<http://emailbydomain.com>

Auto manuals search

<http://auto.somanuals.com>

TV manuals search

<http://tv.somanuals.com>