

Start
Here!

1

2

3

Quick Start Guide Next Page...



Quick Start Guide

DSS
2455/
2465

Digital Spread
Spectrum provides
the longest range,
the clearest sound
and the best privacy.

Uniden®

INSTALLATION & SAFETY

Choosing the best location for your phone.

When choosing a location for your phone there are a number of appliances the phone should not be near, and areas you should avoid.



- This symbol indicates important operating and servicing instructions.

- The earcap of this telephone may attract and retain small metallic objects.

AVOID -
Television sets and
other electronic
appliances

AVOID -
Microwave ovens

AVOID -
moisture

AVOID -
Moisture

CHARGE -
the new phone
for 17 - 20 hrs.

CHOOSE -
a central location

AVOID -
other cordless
telephones

Don't -
overload the
power outlet.

AVOID -
multi power boards.

AVOID -
Computers

Note: Ringing will not be impaired by
adding extra cordless handsets.

AVOID -
connecting
more than
3
phones as ringing
may be impaired

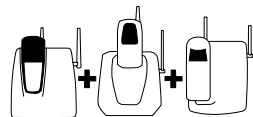
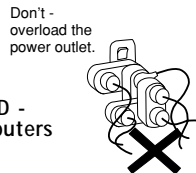
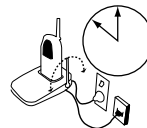
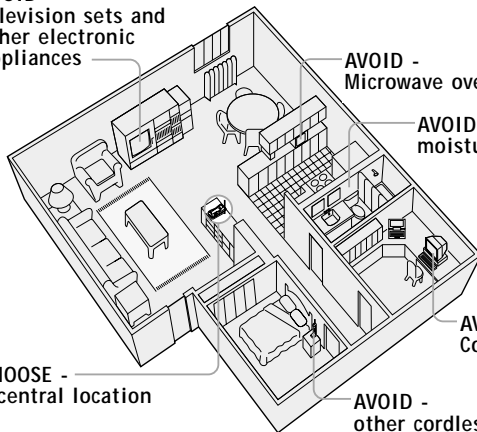

Start Here!

1

2

3

QUICK START GUIDE

The Quick Start Guide is a very condensed version of the Owner's Manual. It is designed to allow you to get your phone installed and operating as quickly as possible - however it does not attempt to explain any of the advanced features of the DSS2455 and DSS2465 series.

1 Installing the Base Unit

- 1) Install the desk top/wall mount bracket into the notches on the base top for desk top mounting.
For wall mounting, see "Mounting the Base Unit on a Wall" on page 6.

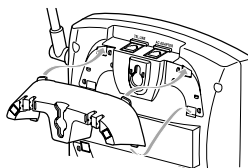

- 2) Connect the AC adapter to the **AC ADAPTER** jack and to a standard AC wall outlet.

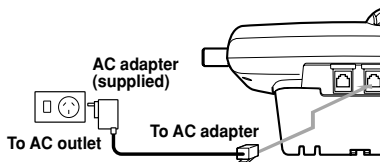

- 3) Connect the telephone line cord to the **TEL LINE** jack and to a telephone socket on the wall.

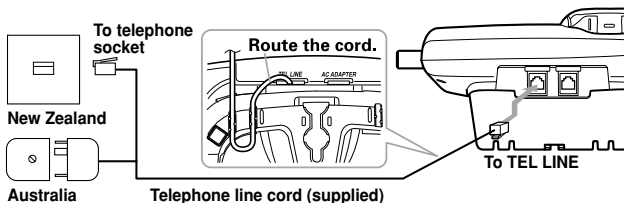

Make sure the AC Adapter/s remains switched ON at all times. Use only the Uniden AC Adapter/s supplied with this unit.

- 4) Set the base on a desk or tabletop.
- 5) Rise the antenna to a vertical position.

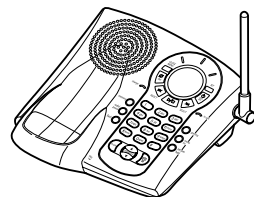

Connecting the charger - DSS2465 only

- 1) Connect the AC adapter into the charging cradle and to a AC wall outlet.
- 2) Set the charger on a desk or tabletop, and place the handset in the charger with the keypad facing forward (see "Installing the AA batteries" below to install the batteries).

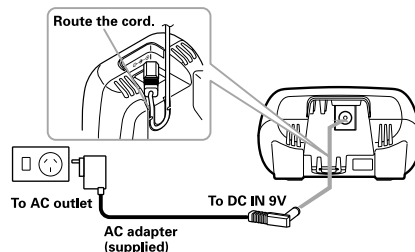

- Use only "AA" rechargeable Ni-MH batteries. Do Not use Alkaline, Lithium, or non-rechargeable batteries. Using incorrect batteries could damage or limit the performance of this unit.
- Recharge your phone on a regular basis by returning the handset to the charger after each phone call.



Installing the AA batteries

- 1) Press down on the battery cover release and slide the cover down until it comes off.
- 2) Install the batteries supplied with your phone, observing correct + - polarity.

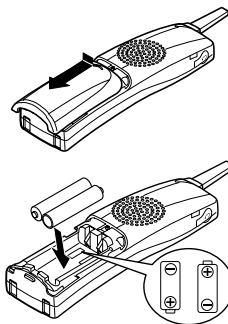

- Securely close the battery compartment cover by sliding it up until it snaps into place.

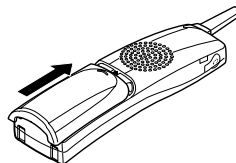

3 Charging the handset

- Place the handset in the charging cradle with the keypad facing up.

The DSS2455 and DSS2465 series will only work with "AA" Ni-MH rechargeable batteries. If you use any other type of batteries, the display will show "Use rechargeable battery only".



- Make sure the **charge** LED illuminates. If the LED does not illuminate, check to see that the AC adapter is plugged in and switch on. Clean the handset and base charge contacts with a pencil eraser.

- After installing the batteries in the handset, charge your handset at least **17-20 hours**.



During a power cut or if the AC Adapter is switched off, this telephone will not operate.

CONTENTS

INSTALLATION & SAFETY

QUICK START GUIDE

CONTENTS

GETTING STARTED

| | |
|----------------------------------|----|
| Controls and Functions | 1 |
| Uniden Company Philosophy | 3 |
| Welcome | 3 |
| Features | 4 |
| Checking the Package Contents | 5 |
| Terminology | 5 |
| Mounting the Base Unit on a Wall | 6 |
| Battery Maintenance | 6 |
| Installing the Beltclip | 7 |
| Headset Installation | 8 |
| Display and Icons | 8 |
| About Soft Key Function | 9 |
| DSS2455/DSS2465 Flow Chart | 10 |
| About the Menu | 12 |
| Setting up the Menu | 15 |

BASICS

| | |
|---|----|
| Making and Receiving Calls | 23 |
| Placing a Call on Hold | 24 |
| Redialing a Call | 24 |
| Adjusting the Earpiece and Handset Speaker Volume | 26 |
| Clarity Booster | 26 |
| Ringer Mute (temporarily) | 27 |
| Mute Microphone | 27 |
| Traveling Out-of-Range | 27 |
| Flash and Call Waiting | 28 |
| New Message LED | 28 |

PHONEBOOK

| | |
|--|----|
| Storing Phone Numbers, Names, Distinctive Rings, and Speed Dial | 29 |
|--|----|

| | | |
|-----------|--|-----------|
| i | Steps for Entering Names and Special Characters | 31 |
| ii | Viewing the Phonebook | 33 |
| v | Making Calls Using the Phonebook | 34 |
| 1 | Speed Dialing | 34 |
| 1 | Editing or Erasing a Stored Name, Phone Number, Distinctive Ring, and Speed Dial | 35 |
| 3 | Chain Dialing | 36 |
| 3 | Memory Dialing (base only) | 36 |
| 5 | CALLER ID | 37 |
| 5 | Viewing the Caller ID List | 38 |
| 6 | Deleting Information from the Caller ID List | 39 |
| 6 | Using the Caller ID Message List | 40 |
| 7 | THE INTEGRATED ANSWERING DEVICE | 41 |
| 8 | Turning the Answering System On/Off | 42 |
| 8 | Setting up your Answering System | 42 |
| 9 | Using your Answering System | 49 |
| 10 | Remote Operation | 52 |
| 12 | EXPANDING YOUR PHONE | 55 |
| 15 | Connecting the Charger | 55 |
| 23 | Register the Handset | 56 |
| 23 | Using Two Way Communication between the Handsets Anywhere without the Base (DirectLink) | 57 |
| 24 | 3-Way Conferencing | 58 |
| 24 | 4-Way Conferencing | 58 |
| 26 | Intercom/Call Transfer Feature | 59 |
| 27 | ADDITIONAL INFORMATION | 61 |
| 27 | Changing the Digital Security Code | 61 |
| 27 | Note on Power Sources | 62 |
| 28 | TROUBLESHOOTING | 63 |
| 28 | INDEX | 66 |
| 29 | REMOTE OPERATION CARD | 67 |
| | WARRANTY | 69 |

CONTROLS AND FUNCTIONS

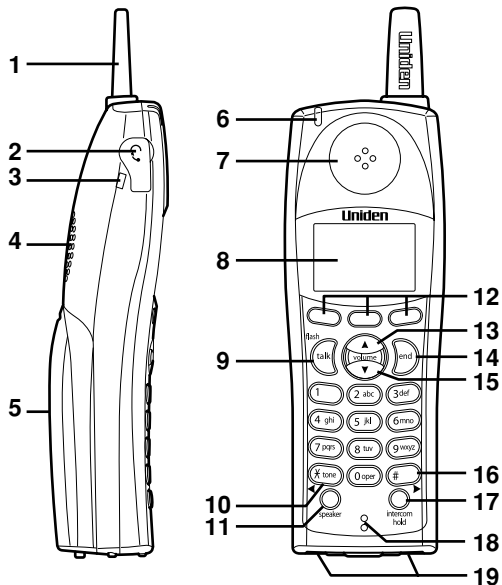

1. Handset Antenna
2. Headset Jack Cover
3. Beltclip Hole
4. Hands Free Speaker
5. Handset Battery Compartment
6. New Message LED
7. Handset Earpiece
8. LCD Display
9. talk/flash Key
10. $\text{(*)}/\blacktriangleleft$ Key
11. speaker Key
12. Soft Keys
13. volume/ \blacktriangle (up) Key
14. end Key
15. volume/ \blacktriangledown (down) Key
16. $\text{#}/\blacktriangleright$ Key
17. intercom/hold Key
18. Handset Microphone
19. Handset Charging Contacts

- 20. Base Speaker
- 21. (KK) (repeat)/SELECT Key
- 22. (del) (delete) Key
- 23. (CLOCK/MENU) Key
- 24. Message Counter Display
- 25. (SET) Key
- 26. (ans on) (answer on) Key
- 27. Charge LED
- 28. (memory) Key
- 29. (redial/pause) Key
- 30. (flash) Key
- 31. (X) Key
- 32. (mute) Key
- 33. Base Charging Contacts
- 34. Base Antenna
- 35. (SKIP) (skip)/SELECT Key
- 36. In use LED
- 37. (play/stop) Key
- 38. (greeting) Key
- 39. (memo rec) (record) Key
- 40. (int'com/hold) Key
- 41. (#) Key
- 42. (talk) Key/speaker LED

- 43. (ringer/vol) (volume) / ▲ (up) Key
- 44. (ringer/vol) (volume) / ▼ (down) Key
- 45. Microphone
- 46. Telephone Input
- 47. DC Power Input
- 48. Charging Contacts (DSS2465 only)
- 49. Charge LED (DSS2465 only)
- 50. DC Power Input (DSS2465 only)

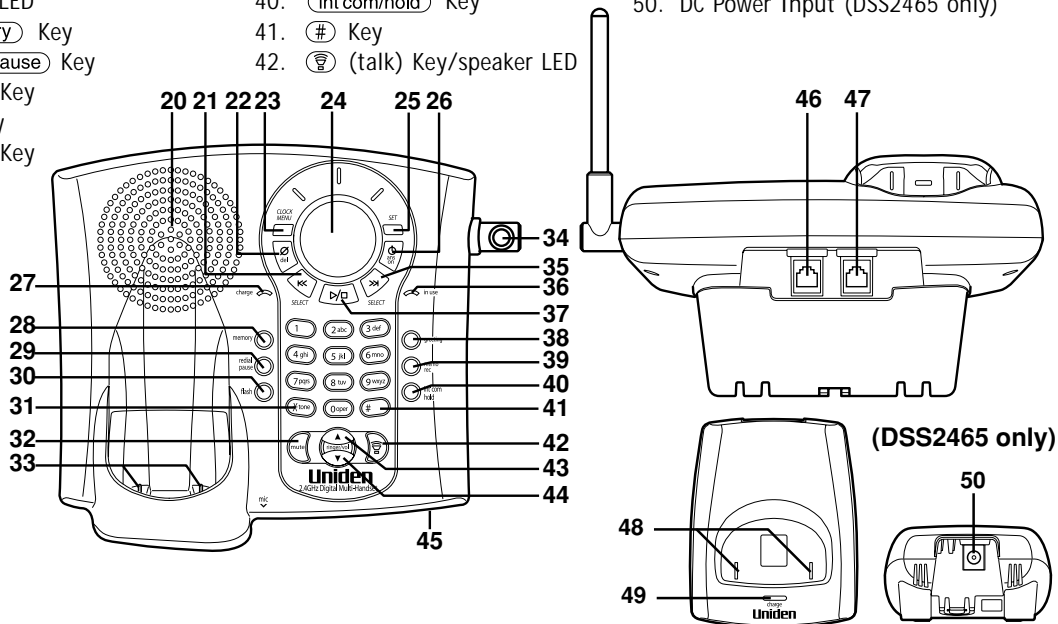

UNIDEN COMPANY PHILOSOPHY

To bring outstanding wireless communication products to people's lives throughout the world.

WELCOME

Congratulations on your purchase of this Uniden DSS2455 or DSS2465 series Multi Handset Cordless System telephone. This unit is different from conventional cordless telephones. It can support up to 4 handsets. Using extra handsets (optional), you can establish a 4-way conference call (2 handsets-Base Speaker Phone-an outside line, or 3 handsets-an outside line). Additionally, with 4-way conference using 2 handsets, another 2 handsets can establish an intercom call. You can now place a fully featured cordless handset anywhere in your home or office where AC power is available to connect the handset chargers.

Note: Some illustrations in this manual may differ from the actual unit for explanation purposes.

FEATURES

Great features of this cordless phone include:

- Designed and Engineered in Japan
- 2.4GHz Digital Spread Spectrum
- Integrated Digital Answering Machine
- Multi (4) Handset Capable (2 handsets Included (DSS2465 only))
- Long Range (up to 1km) #
- Dual Keypad (Backlit on Handsets)
- Digital Duplex Speakerphones on Handset and Base

Advanced Alpha Display Caller ID Features:

- Alpha Memory Dialling
- POP ID - Caller Name Identification*
- 16 Individual Caller Tone Allocation (8 Rings/8 Melodies)
- 100 Caller ID * Memories with Phonebook
- 4 Line Backlit Full Dot Matrix LCD Display with Clock
- Maxi-Sound - Extra Loud Handset Volume Control
- Intercom/Announce Call Transfer
- Handset Conferencing (for example, 2 handsets + Base + Outside Call)
- Two-Way Communication between Handsets Anywhere without the Base
- Conversation Record
- And More!

* Caller ID and POP ID features work only if you subscribe to the service provided by your local telephone company. There is usually a fee for this service.

Range may vary depending on environmental and/or topographical conditions.

CHECKING THE PACKAGE CONTENTS

Make sure you have received the following items in the package. If any of these items are missing or damaged, contact your retailer.

- Base unit (1)
- Handset [DSS2455 (1) / DSS2465 (2)]
- AC adapter [DSS2455 (1) / DSS2465 (2)]
- Rechargeable batteries [DSS2455 (2) / DSS2465 (4)]
- Telephone cord or adapter (1) (Australia)
- Telephone cord (1) (New Zealand)
- Beltclip [DSS2455 (1) / DSS2465 (2)]
- Charger (1) [DSS2465 only]

Also included:

- This Owner's Manual
- Other Printed Material

Uniden Australia Pty Limited Service Division
Ph : 1300 366 895

We can also be reached
at www.uniden.com.au

Uniden New Zealand Limited Service Division
Ph : 0800 4 UNIDEN
(0800 4864 336)

We can also be reached
at www.uniden.co.nz

TERMINOLOGY

Throughout this manual, terms such as Standby and Talk Mode are used. Below is the terminology explanation.

Standby Mode - The handset is not in use, is off the cradle, and **talk**/flash or **speaker** has not been pressed. A dial tone is not present.

Talk Mode - The handset is not in the cradle and **talk**/flash or **speaker** has been pressed enabling a dial tone. "TALK" appears on the display.

DirectLink - Two way communication between the handset anywhere without the base.

MOUNTING THE BASE UNIT ON A WALL

You can mount your base directly to the wall. Before doing this, consider the following:

- Avoid electrical cables, pipes, or other items behind the mounting location that could cause a hazard when inserting screws into the wall.
- Mount your phone within distance of a working phone jack.
- Make sure the wall material is capable of supporting the weight of the base and handset.
- Use screws with anchoring devices suitable for the wall material where the base unit will be placed.

- 1) Insert two mounting screws into the wall (with their appropriate anchoring device), 10cm apart. Allow about 3mm between the wall and screwheads for mounting the phone.
- 2) Snap the desk top/wall mount bracket into the notches on the base bottom.
- 3) Plug the AC adapter into the **AC ADAPTER** jack on the telephone and then into a Standard AC wall outlet.
- 4) Plug the telephone line cord into the **TEL LINE** jack on the telephone and then into the telephone socket on the wall.
- 5) Align the mounting slots on the base with the mounting posts on the wall.
- 6) Then push in and down until the phone is firmly seated.

This phone also can be mounted on any standard telephone wall plate (for Australia).

- 1) Snap the desk top/wall mount bracket into the notches on the base bottom.
- 2) Refer to step 3 through 6 to mount the base.

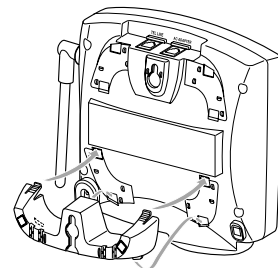
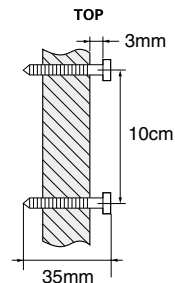

BATTERY MAINTENANCE

Battery use time (per charge)

Fully charged (17-20 hours charge time)

- Up to 7 hours continuous use (up to 5 hours when the clarity booster is on)
 - Up to 14 days when the handset is in the standby mode (up to 24 hours when in DirectLink mode)
- Recharge your phone on a regular basis by returning the handset to the charger after each phone call.

Low battery alert

When the batteries are very low and need to be charged, the phone is programmed to eliminate functions in order to save power.

The batteries need to be charged when:

- The empty battery icon  appears.
- "Low Battery" appears in the display.

If the phone is in the standby mode, none of keys will operate. If you are on a call, complete your conversation as quickly as possible, and return the handset to the cradle.

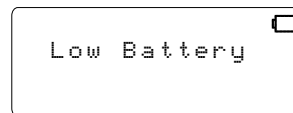

Cleaning the battery charging contacts

To maintain a good charge, it is important to clean the charging contacts on both the handset and the base unit once a month. Use a dry cloth or pencil eraser to clean.

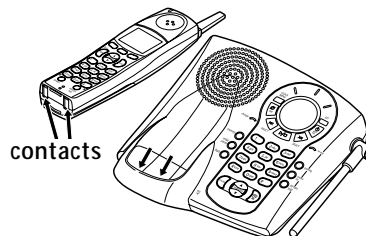

Battery replacement and handling

When the operating time becomes short, even after a battery is recharged, please replace the battery. Please use only "AA" rechargeable Ni-MH batteries.

Caution

- Use only "AA" rechargeable Ni-MH batteries.
- Do not remove the batteries from the handset to charge them.
- Never throw the batteries into a fire, disassemble them, or heat them.
- Do not remove or damage the battery casing.



To avoid the risk of personal injury or property damage from fire or electrical shock, only use the Uniden adapter model specifically designated for this product, and "AA" rechargeable Ni-MH batteries.

INSTALLING THE BELTCLIP

To attach the beltclip

Insert the beltclip into the holes on each side of the handset. Press down until it clicks into place.

To remove the beltclip

Pull both sides of the beltclip to release the tabs from the holes.



HEADSET INSTALLATION

Your phone may be used with an optional headset, the Uniden HS910. To use this feature, insert the headset plug into the headset jack. Your phone is ready for hands-free conversations.



DISPLAY AND ICONS

Example of the standby mode display

Ringer off icon (when the ringer is Off)

Day of the week and time (hh:mm/A/P)

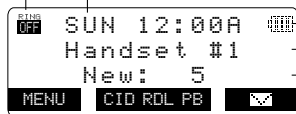







Battery icon

Handset ID and Banner

Number of new Caller ID calls received

Soft keys

(These will not be displayed while the handset is charging in the cradle.)

| ICON | STATUS | DESCRIPTION |
|---|--------------|---|
|  | Standby/Talk | Battery icons indicate the handset battery status. This icon cycles depending on the battery status (empty, low, medium, and full).  indicates that the batteries installed are not for use with this phone, remove the batteries immediately. |
|  | Standby | Ringer off icon indicates that ringer is set to Off. |
|  | Standby | Handset Remote soft key is used to play an incoming message remotely. |
|  | Talk | Mute icon appears when you mute the handset. |
|  | Talk | Speaker icon appears when the handset speaker phone is used. |
|  | Talk | Recording icon appears while recording a conversation. |

ABOUT SOFT KEY FUNCTION

In the standby mode



In the talk mode
(Australia model)

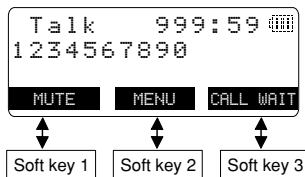

(New Zealand model)

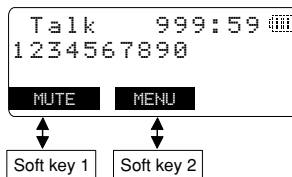

Soft key functions consists of soft key icons and soft keys (No. 1, 2, and 3). Each soft key corresponds to the icon displayed above, and each icon will be changed depending on the operation. Press the corresponding soft key to enter a menu, or select an item. In this manual, we refer to this combination of icons and keys as the soft key.

For example, you will use the soft keys when you want to:

- Access the main menu
- Access Caller ID messages stored
- Store or edit phone numbers
- Redial one of the last three numbers dialed from the handset
- Etc....

Note: The soft key icons will not appear while charging the handset.

DSS2455/DSS2465 FLOW CHART

• From the standby mode

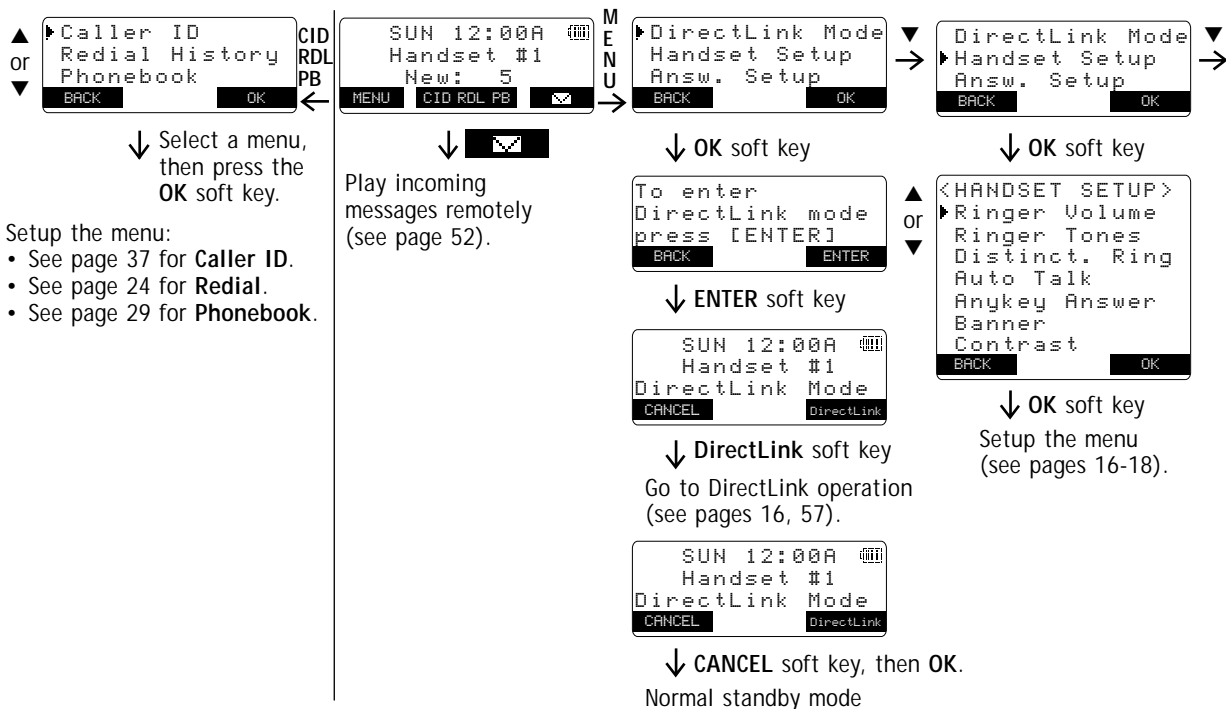

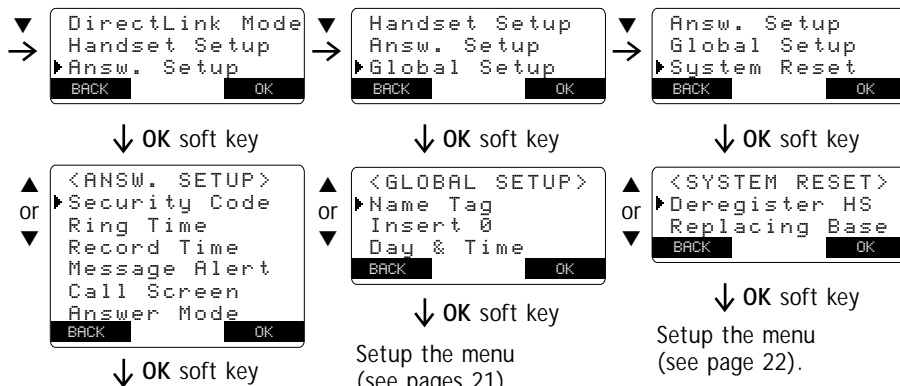

NOTE "Insert Ø" is available only for New Zealand model.

• From the Talk mode

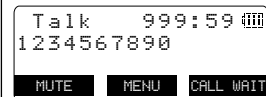

- Press the **MUTE** soft key to mute a call (see page 27).
- Press the **MENU** soft key, then select:
 - "Booster On" to improve the sound quality (see page 26).
 - "Recording" to record the conversation (see page 51).
 - "Caller ID" to view Caller ID list (see page 38).
 - "Phonebook" to view phonebook locations (see page 33).
 - "Redial History" to view the last three numbers dialed (see page 24).
- Press the **CALL WAIT** soft key to access the Call Waiting (see page 28) (Australia only).



For Answ. Setup, Global Setup, and System Reset (Deregister HS) menu, make sure the line is not in use, and the handsets are within the range limits of the base.

ABOUT THE MENU

Most of the handset settings are set from the menu. The menu has 5 main menus (**DirectLink Mode, Handset Setup, Answ. Setup, Global Setup, and System Reset**) and submenus respectively.

Summary of the Main Menu and Submenu

Two Way Communication between the Handsets Anywhere without the Base (DirectLink)

Select this menu to enter the Two Way Communication between the Handsets Anywhere without the Base (DirectLink) mode. If you have 2 or more handsets, a pair of handsets work as transceivers. Use them at a shopping mall to stay in contact with family and friends. To use this feature, you must set the two handsets to the DirectLink mode first (see page 16).



DirectLink menu only applies when you have 2 or more handsets.

Handset Setup

All settings must be set separately for each handset in the Handset Setup menu.

| Submenu name | Description |
|-----------------------------------|--|
| Ringer Volume | Adjust the ringer volume (see page 16). |
| Ringer Tones | Adjusting the ringer tone (see page 17). |
| Distinct. Ring (Distinctive ring) | Set the distinctive ring (see page 17). "Distinctive Ring" allows you to preset memory locations with a designated ring tone. When an incoming call is received and the Caller ID information matches the information in one of the memory locations, the distinctive ring that has been stored for that particular Caller will sound. If you have set multiple memory locations with distinctive rings, switching the setting to "Distinctive Off" will result in no distinctive ringing. All incoming calls will have a normal ring tone. Switching to "Distinctive On" will activate all programmed distinctive ring memory locations. |

| Submenu name | Description |
|---------------|--|
| Auto Talk | Allows you to answer the phone without pressing (talk) /flash or (speaker) . When the AutoTalk is set to On, simply remove the handset from the cradle and the phone automatically answers the call (see page 17). |
| Anykey Answer | Allows you to answer the phone without pressing (talk) /flash or (speaker) . When the Anykey Answer is On, you can answer a call by pressing any number key, (*) /◀, or (#) /▶ on the handset (see page 18). |
| Banner | Customize the name of your handset, and display it in the LCD in the standby mode. For example, you can name the handset "John" (see page 18). |
| Contrast | Adjust the handset LCD brightness for better viewing (10 levels) (see page 18). |

Answering Setup

This menu allows you to set up Answering Machine settings from your handset. You can also set these setup menus from the base (see page 44).

| Submenu name | Description |
|---------------|---|
| Security Code | Select a two-digit Personal Identification Number (PIN) code. A PIN code is required to play your messages from a remote location, you will need to enter a two-digit PIN code (see page 19). |
| Ring Time | Allows you to set the number of rings the caller hears before your answering system plays the outgoing message. You can set the ring time to answer after 4, 6, or 9 rings. Setting "TS" (Toll Saver), the answering system picks up after 6 rings if you have new messages, and after 9 rings if there are none (see page 19). |
| Record Time | Set the duration for recording the incoming messages. You have three record time options. The options "1 minute" or "4 minutes" set the duration for recording the incoming messages. "Announce only" answers the call with the preset greeting or your personal greeting but prevents the caller from leaving a message (see page 19). |
| Message Alert | Lets you know when you have a new incoming message by sounding a short alert tone (see page 20). |
| Call Screen | Set the call screening feature to On or Off (see page 20). |
| Answer Mode | Set your answering system to On or Off (see page 20). |

Global Setup

If you change the setting in one of the handsets, you change the settings for all handset(s) in the Global Setup menu. Only one handset can change a setting at a time.

| Submenu name | Description |
|--------------------------------|--|
| Name Tag (POP ID) | Display the stored name with the Caller ID telephone number, if the displayed Caller ID telephone number is exactly the same as a number stored in the phone book (see page 21). |
| Insert 0 (New Zealand only) | Add "0" or "00" to the number, when you receive the Caller ID message (see page 21). |
| Day & time | Set the day and time of your display (see page 21). |

System Reset

This menu is used to clear the handset ID from the base, or the base ID from the handset.

| Submenu name | Description |
|----------------|--|
| Deregister HS | Clear the handset ID from the base. Use this menu, for example when you change the digital security code (see page 22). |
| Replacing Base | Clear the base ID. Use this menu, for example, if you wish to deregister the base to use the handset with another base of the DSS series (DSS2415/DSS2455/DSS2465 series) (see page 22). |

SETTING UP THE MENU

Entering the Menu

- 1) Press the **MENU** soft key in the standby mode.
- 2) Use **(volume)** / ▲ or ▼ to move the pointer to a desired main menu (**DirectLink Mode**, **Handset Setup**, **Answ. Setup**, **Global Setup**, and **System Reset**).
- 3) Press the **OK** soft key to enter the menu. To return to the previous screen, press the **BACK** soft key.
- 4) Use **(volume)** / ▲ or ▼ to select a desired submenu, then press the **OK** soft key to enter.

In the submenu, **(volume)** / ▲ or ▼ is used to select an item. Press the **OK** soft key to confirm your selection. To return to the previous screen, press the **BACK** soft key. For detailed instructions, see the following sections for the desired submenu.

- 5) To exit the menu, press **(end)**.

- If any of the following occurs during the menu operation, the operation will be cancelled.
 - Press **(end)**.
 - Press **(talk)**/flash or **(speaker)**.
 - Charge the handset.
 - Receive an outside/intercom call or page.
- If the handset remains idle for 30 seconds, the phone will return to the standby mode.

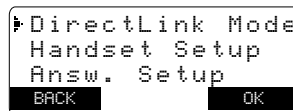
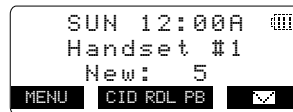

For Answering Setup menu, you can also set them from the base (see page 44).



- If you select “Ringer Volume Off”,  icon appears in the display.

DirectLink Mode

Entering the Two Way Communication between the Handsets Anywhere without the Base

- 1) Enter the “DirectLink Mode” menu (see “Entering the Menu” on page 15).
- 2) Press the **ENTER** soft key to enter the DirectLink mode. You will hear a confirmation tone, and “DirectLink Mode Complete” appears.
- 3) To return back to the normal mode, exit the DirectLink mode. To exit the DirectLink mode, press the **CANCEL** soft key, then the **OK** soft key, or return the handset to the cradle.

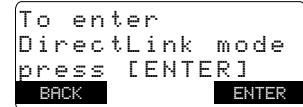

```
To enter
DirectLink mode
press [ENTER]
BACK      ENTER
```

Handset Setup

Setting a Ringer Volume

- 1) Enter the “Handset Setup” menu, then the “Ringer Volume” submenu (see “Entering the Menu” on page 15).
- 2) Press **(volume)** / ▲ or ▼ to adjust the ringer settings (Ringer Volume Off, Ringer Volume Low, or Ringer Volume High). You will hear a ringer or melody at the Selected volume (if you select “Ringer Volume Off”, no ringer or melody will sound).
- 3) Press the **OK** soft key. You will hear a confirmation tone.

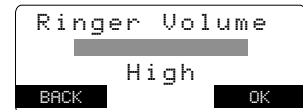

```
Ringer Volume
High
BACK      OK
```

Selecting a Ringer Tone

- 1) Enter the "Handset Setup" menu, then the "Ringer Tones" submenu (see "Entering the Menu" on page 15).

You can choose from 8 ringers or 8 melodies:

- Ringers [Flicker, Clatter, Soft Alert, Wake Up, Light Bug, Beep Boop, Tone Board, Chip Chop]
- Melodies [Beethoven's Symphony #9 (Beethoven9), For Elise (Elise), We Wish You A Merry Christmas (Merry-Xmas), Home Sweet Home (Hm Swt Hm), Lorri Song #6 (Lorri Song), When the Irish Eyes Are Smiling (Irish Eyes), Aura Lee, Let Me Call You Sweet Heart (Sweetheart)]

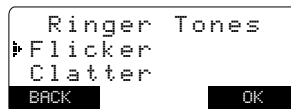

- 2) Press **(volume)** / ▲ or ▼ to move the pointer. You will hear the ringer or melody as you scroll through the options.
- 3) Press the **OK** soft key. You will hear a confirmation tone.

Distinctive Ringer Setup

- 1) Enter the "Handset Setup" menu, then the "Distinct. Ring" submenu (see "Entering the Menu" on page 15).
- 2) Press **(volume)** / ▲ or ▼ to select "On" or "Off".
- 3) Press the **OK** soft key. You will hear a confirmation tone.

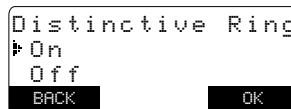

Setting the Auto Talk

- 1) Enter the "Handset Setup" menu, then the "Auto Talk" submenu (see "Entering the Menu" on page 15).
- 2) Press **(volume)** / ▲ or ▼ to change the selection, "On" or "Off".
- 3) Press the **OK** soft key. You will hear a confirmation tone.

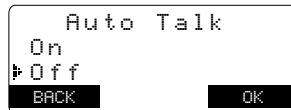

If you set the ringer volume to Off **(OFF)**, the ringer tone will not sound.



If you don't enter a banner, the phone will use the handset ID for the banner (for example: Handset #1).

Setting the Anykey Answer

- 1) Enter the "Handset Setup" menu, then the "Anykey Answer" submenu (see "Entering the Menu" on page 15).
- 2) Press **(volume)** / ▲ or ▼ to change the selection, "On" or "Off".
- 3) Press the **OK** soft key and you will hear a confirmation tone.

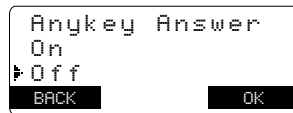

Setting the Banner

- 1) Enter the "Handset Setup" menu, then the "Banner" submenu (see "Entering the Menu" on page 15).
- 2) Use the number keypad (0-9), (*)/◀, (#)/▶, or the **DELETE** soft key to enter or edit the name. To delete all characters, press and hold the **DELETE** soft key, then enter the new name.
- 3) Press the **OK** soft key. You will hear a confirmation tone.



Adjusting the LCD Contrast

- 1) Enter the "Handset Setup" menu, then the "Contrast" submenu (see "Entering the Menu" on page 15).
- 2) Press **(volume)** / ▲ or ▼ to adjust the contrast of the LCD (10 levels).
- 3) Press the **OK** soft key. You will hear a confirmation tone.



Answering System Setup

Setting a PIN Code

- 1) Enter the "Answ. Setup" menu, then the "Security Code" submenu (see "Entering the Menu" on page 15).
- 2) Enter a two-digit PIN code (01-99) using the number keypad (0-9).
- 3) Press the **OK** soft key. You will hear a confirmation tone.

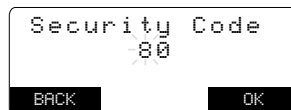

Setting the Ring Time

- 1) Enter the "Answ. Setup" menu, then the "Ring Time" submenu (see "Entering the Menu" on page 15).
- 2) Press **(volume)** / **▲** or **▼** to select a Ring Time (Toll Saver, 4 Times, 6 Times, or 9 Times).
- 3) Press the **OK** soft key. You will hear a confirmation tone.

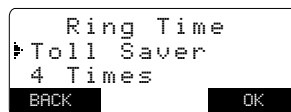

Setting the Record Time

- 1) Enter the "Answ. Setup" menu, then the "Record Time" submenu (see "Entering the Menu" on page 15).
- 2) Press **(volume)** / **▲** or **▼** to select Record Time (1 Minute, 4 Minutes, or Announce Only).
- 3) Press the **OK** soft key. You will hear a confirmation tone.

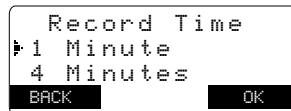

For Answering Setup menu, you can also set them from the base (see page 44).

Setting the Message Alert On or Off

- 1) Enter the "Answ. Setup" menu, then the "Message Alert" submenu (see "Entering the Menu" on page 15).
- 2) Press **(volume)** / ▲ or ▼ to choose "On" or "Off".
- 3) Press the **OK** soft key. You will hear a confirmation tone.

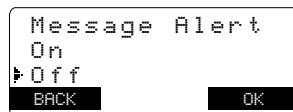

Setting the Call Screen

- 1) Enter the "Answ. Setup" menu, then the "Call Screen" submenu (see "Entering the Menu" on page 15).
- 2) Press **(volume)** / ▲ or ▼ to choose "On" or "Off".
- 3) Press the **OK** soft key. You will hear a confirmation tone.

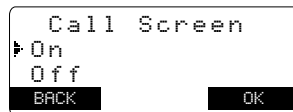

Setting the Answer Mode

- 1) Enter the "Answ. Setup" menu, then the "Answer Mode" submenu (see "Entering the Menu" on page 15).
- 2) Press **(volume)** / ▲ or ▼ to choose "On" or "Off".
- 3) Press the **OK** soft key. You will hear a confirmation tone.

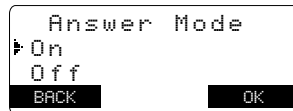

Global Setup

Setting Name Tag (POP ID)

- 1) Enter the "Global Setup" menu, then the "Name Tag" submenu (see "Entering the Menu" on page 15).
- 2) Press **(volume)** / ▲ or ▼ to change the selection, "On" or "Off".
- 3) Press the **OK** soft key. You will hear a confirmation tone.

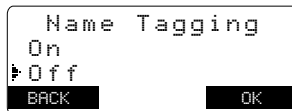

Setting Insert Zero (New Zealand only)

- 1) Enter the "Global Setup" menu, then the "Insert 0" submenu (see "Entering the Menu" on page 15).
- 2) Press **(volume)** / ▲ or ▼ to change the selection, "On" or "Off".
- 3) Press the **OK** soft key. You will hear a confirmation tone.

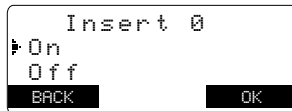

Setting Day and Time

- 1) Enter the "Global Setup" menu, then the "Day & Time" submenu (see "Entering the Menu" on page 15).
- 2) Press **(volume)** / ▲ or ▼ to select the day of the week, then press the **NEXT** soft key.
- 3) Press the number keypad (**0** - **9**) to set the time, then press the **NEXT** soft key.
- 4) Press **(volume)** / ▲ or ▼ to choose "AM" or "PM", then press the **OK** soft key. You will hear a confirmation tone.

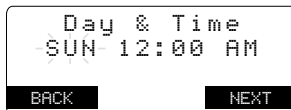

- When a Global setting is changed from one handset, this affects all registered handsets.
- For setting the Day and Time, the idle time-out is extended to 2 minutes.

System Reset

Deregister the Handset

1) Enter the "System Reset" menu, then the "Deregister HS" submenu (see "Entering the Menu" on page 15).

2) Press **(volume)** / ▲ or ▼ to select the handset ID to be deregistered from the list, then press the **OK** soft key.

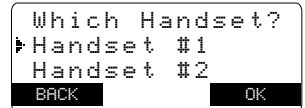

3) Press the **OK** soft key. You will hear a confirmation tone.

When deregistration is complete, "Deregistration Complete" appears.

4) After deregistering the handset, move to "Deregister the Base Setting" below.

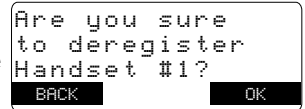

Deregister the Base Setting

1) Enter the "System Reset" menu, then the "Replacing Base" submenu (see "Entering the Menu" on page 15). "Do you want to replace Base?" appears.

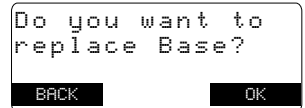

2) Press the **OK** soft key. You will hear a confirmation tone. The base information will be deleted.

When replacing the base is complete, "Please Register" appears, register the handset(s) to the new base (see page 56).

MAKING AND RECEIVING CALLS

On the handset, you may also use the speakerphone while talking to an outside call. Using the handset speakerphone is called “hands-free conversation”. This feature allows you to easily communicate while performing other tasks, such as cooking.

☎ appears on the handset display during hands-free conversations.

You can easily switch a call from normal conversation to “hands-free conversation”. To switch a call, press **(speaker)** during the call.

| | From the Handset | | From the Base |
|--|--|--|--|
| | Normal conversation | Hands-free conversation | |
| To answer a call | <p>Handset On the Cradle Pick up the handset (AutoTalk) or pick up the handset and press (talk)/flash .</p> <p>Handset Off the Cradle Press any number key, (*)/◀, or (#)/▶ (Anykey Answer), or press (talk)/flash .</p> | <p>Handset Off the Cradle Press (speaker) .</p> | Press (talk) (talk). |
| To make a call | <p>Handset Off the Cradle 1) Press (talk)/flash . 2) Listen for the dial tone. 3) Dial the number. OR Dial the number, then press (talk)/flash .</p> | <p>Handset Off the Cradle 1) Press (speaker) . 2) Listen for the dial tone. 3) Dial the number. OR Dial the number, then press (speaker) .</p> | <p>1) Press (talk) (talk). 2) Listen for the dial tone. 3) Dial the number.</p> |
| To hang up | Press (end) , or return the handset to the cradle (Auto Standby). | | Press (talk) (talk). |
| To enter a pause within the dialing sequence | When you dial the number in the standby mode, press the PAUSE soft key. “P” appears in the display, which represents a pause. | | Press (talk) (talk). When you dial the number, press (redial/pause) . |



- To set “Auto talk”, see page 17 or “Anykey Answer”, see page 18.
- The handset microphone is located at the bottom of the handset (see “Controls and Functions” on page 1). Position yourself as near to the handset as possible and speak clearly.
- If the line is in use by another handset(s), “Line In Use” appears in all registered handset’s display, that are not in use.
- The base microphone is located under the base. Position yourself as near to the base as possible and speak clearly.

PLACING A CALL ON HOLD

- 1) During a call, press **(intercom/hold)** (or **(int'com/hold)** on the base).



Once 10 seconds has passed or when you press **(end)**, the call will be put on hold.

- 2) To talk to the caller, press **(talk)/flash** or **(speaker)** on a handset (or **(☎)** (talk) on the base). The phone will return back to the call.



You can hold a call for 5 minutes, when 5 minutes has passed, the call is disconnected and the phone returns to the standby mode.

```
Hold, to transfer
▶Handset #2
  Handset #3
BACK          OK
```

```
Line On Hold [grid]
  Handset #1
    New: 1
MENU  CID RDL PB  [envelope]
```

NOTE

- If you press **(end)**, the operation is canceled.
- When the telephone is automatically redialing a number, the speaker function is disabled for a few seconds.

REDIALING A CALL

The last three phone numbers dialed can be quickly redialed.

Redialing from Standby Mode

- 1) Press the **CID RDL PB** soft key in the standby mode.
- 2) Press **(volume) / ▲ or ▼** to select "Redial History", then press the **OK** soft key. The phone number that was last dialed appears in the display.
- 3) Press **(volume) / ▲ or ▼** to toggle through the last three phone numbers dialed.
- 4) Press **(talk)/flash** or **(speaker)**. The selected number is dialed.
- 5) To hang up, press **(end)**.

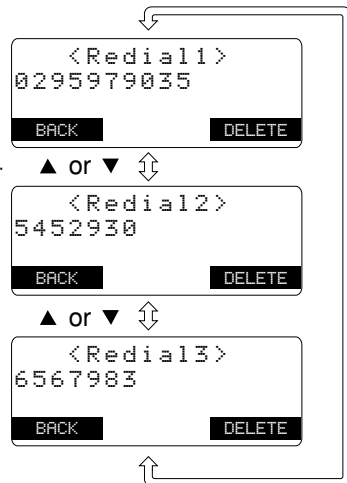

Redialing from Talk Mode

- 1) Press **(talk)**/flash or **(speaker)**, then press the **MENU** soft key.
- 2) Select the number you dialed by following steps 2-3 in "Redialing from Standby Mode".
To return to go back, press the **BACK** soft key.
- 3) Press the **DIAL** soft key.
- 4) To hang up, press **(end)**.

Redialing from the Base

- 1) Press **(talk)**.
- 2) Press **(redial/pause)** on the base. The last number dialed from the base is redialed.
- 3) To hang up, press **(talk)**.

Deleting a Redial Record

- 1) In the standby mode, recall the desired number by following steps 1-3 in "Redialing from Standby Mode".
- 2) Press the **DELETE** soft key.
- 3) Press **(volume) / ▲** or **▼** to choose "Yes".
- 4) Press the **OK** soft key. The redialed number is deleted.

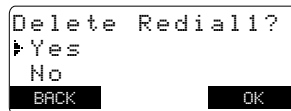



- To adjust the base ringer or speaker volume, see page 43-44.

ADJUSTING THE EARPIECE AND HANDSET SPEAKER VOLUME

You can select different volume levels for the handset earpiece and the handset speaker (4 levels: Low to Max). The volume can only be adjusted during a call. Press **(volume)** / ▲ or ▼ to select the volume settings. When you hang up, the phone keeps the last volume setting selected.



- If you press **(volume)** / ▲ in the maximum volume level or **(volume)** / ▼ in the lowest volume level, you will hear a beep.
- **CALL WAIT** soft key appears only for Australia model.

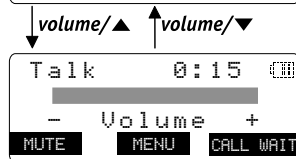

CLARITY BOOSTER

If you encounter interference while using your phone, you can manually improve the sound quality for clear operation. This works only when you make an outside call.

- 1) Press the **MENU** soft key.
- 2) Select "Booster On", then the **OK** soft key.
"Clarity Booster" appears in the display.

To turn Off the Clarity Booster, press the **MENU** soft key, select "Booster Off", then press the **OK** soft key again.

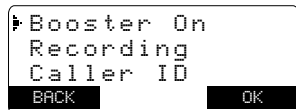

- Normally, the talk time duration is 7 hours, however, when the Clarity Booster is On, the talk time duration will be up to 5 hours with fully charged batteries.
- Clarity booster automatically turns off after each call.

RINGER MUTE (temporarily)

You can temporarily mute the handset and the base ringer tone. To mute the handset ringer tone, when the handset is off the cradle and the phone is ringing, press the **MUTE** soft key. To mute the base ringer tone, press  on the base. The ringer tone will return to the previous setting starting with the next incoming call.



MUTE MICROPHONE

With the handset



You can temporarily turn Off the microphone so that the person you are talking with cannot hear you.

During a telephone call, press the **MUTE** soft key to turn Off the microphone. "Mute" and  appear in the display. Press the **MUTE OFF** soft key to cancel muting.

With the base

While using the base speakerphone, press  on the base to turn Off the microphone. Press  again, or press  (talk) to cancel muting.

TRAVELING OUT-OF-RANGE

During a call, as you begin to move your handset too far from your base unit, noise may increase. If you pass the range limits of the base unit, you will hear a beep and "Out of Range" appears, then the handset returns to the standby mode. You may return back to the call if you move your handset within the range limits of the base, and press /flash or  within 30 seconds.



If you press  to cancel muting, the call is disconnected and the phone will return to the standby mode.



You must subscribe through your local telephone company to receive Call Waiting Service.

FLASH AND CALL WAITING

If the call waiting tone sounds during a call:

AUSTRALIA: Press the **CALL WAIT** soft key.

NEW ZEALAND: Press **(talk)**/flash to switch between callers.

To return to the original caller, press **(talk)**/flash again.

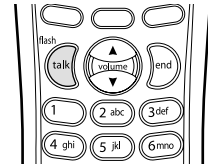

NEW MESSAGE LED

The **new message** LED on the handset is designed to work with your answering system. The LED flashes when you have new messages in your answering system.

The LED stops flashing when all new messages are played back (see "Using your Answering System" on page 49).

PHONEBOOK

Phonebook allows you to dial a number using just a few key presses. Your phone stores names/numbers in the phonebook memory location, and you can search names in alphabetical order. You have a total of 100 locations that can be used for the phonebook (including the Speed dials) and Caller ID messages.



- If any of the following occurs during a phonebook operation, the operation will be canceled.
 - Press **(end)**. The phone will return to the standby mode (or the call will be disconnected).
 - Press **(talk)/flash** or **(speaker)**.
 - Receive an outside/intercom call or page.
 - Charge the handset
- If the handset remains idle for 30 seconds, the phone will return to the standby mode (or back to the call).

STORING PHONE NUMBERS, NAMES, DISTINCTIVE RINGS, AND SPEED DIAL

- 1) When the phone is in the standby mode, press the **CID RDL PB** soft key.
- 2) Press **(volume) / ▲ or ▼** to move pointer to "Phonebook", then press the **OK** soft key. The handset displays the following items:
 - (1st line) The number of the phonebook locations used
 - (2nd line) How to search (press the number keypad, **(volume) / ▲ or ▼**)
 - (3rd line) How to enter the storing operation (press the **STORE** soft key)
 - (4th line) The **BACK** and the **STORE** soft keys.

```
Phonebook : 50
Search [A-Z/↑/↓]
Store [STORE]
BACK STORE
```



You have a total of 100 locations. However, Caller ID messages and Phonebook share the memory locations.

PHONEBOOK



- When the memory is full, you will hear a beep and “Memory Full” appears. You cannot store names and numbers.
- The pause key counts as one digit. Pressing the **PAUSE** soft key more than once increases the length of the pause between numbers. Each pause represents a 2 second delay.
- Distinctive ringing will only operate if you subscribe to the Caller ID service.
- Selecting a speed dial location where a number is already stored, releases the old number's speed dial setting. The new number will be stored in the speed dial location.

3) Press the **STORE** soft key, “Store/Edit Name” appears.

4) Enter the name (up to 16 characters) by using the number keypad (see the “Steps for Entering Names and Special Characters” on page 31).

If a name is not required, go to step 5. <No Name> will be used as the name.



5) Press the **OK** soft key to store the name, “Store/Edit No.” appears.



6) Press the number keypad to enter the phone number (up to 20 digits), press the **OK** soft key to store the number.

7) “Distinctive Ring” appears. Press **(volume)** / ▲ or ▼ to move the pointer to one of the Distinctive Ring options, then press the **OK** soft key.

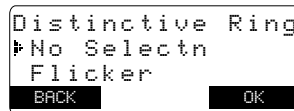

If you choose not to store a “Distinctive Ring”, simply select the “No Selectn” option.

8) “Speed Dial” appears. Press **(volume)** / ▲ or ▼ to move the pointer to select the Speed dial location (10 locations: SPD1-SPD0).



If you choose not to store the name/number as a Speed Dial, simply select the “No Selectn” option.

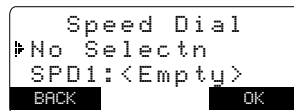

9) Press the **OK** soft key. You will hear a confirmation tone and “Done!” appears in the display.



STEPS FOR ENTERING NAMES AND SPECIAL CHARACTERS

Refer to the letters on the number keys to select the desired characters. With each press of a number key (①-⑨), the displayed character appears in the following order: Upper case letters first, lower case letters next and finally the number corresponding to the key.

| | Number of times key is pressed | | | | | | | | |
|--------|--------------------------------|---|---|---|---|---|---------|---|---|
| keys | 1 | 2 | 3 | 4 | 5 | 6 | 7 | 8 | 9 |
| ① | i | | | | | | | | |
| ② abc | A | B | C | a | b | c | 2 | | |
| ③ def | D | E | F | d | e | f | 3 | | |
| ④ ghi | G | H | I | g | h | i | 4 | | |
| ⑤ jkl | J | K | L | j | k | l | 5 | | |
| ⑥ mno | M | N | O | m | n | o | 6 | | |
| ⑦ pqrs | P | Q | R | S | P | q | r | s | 7 |
| ⑧ tuv | T | U | V | t | u | v | 8 | | |
| ⑨ wxyz | W | X | Y | Z | w | x | y | z | 9 |
| ⑩ oper | & | < | > | < | > | / | (blank) | - | _ |
| | . | , | : | ? | ! | @ | ' | " | * |
| | # | 0 | | | | | | | |



If the next character uses the same number key, you must press **(#)/▶** to move the cursor over. Otherwise the next time you press the number key, it changes the character that was previously set.

If you make a mistake while entering a name

Use **(X)/◀** or **(#)/▶** to move the cursor to the incorrect character. Press the **DELETE** soft key to erase the wrong character, then enter the correct character. To delete all characters, press and hold the **DELETE** soft key.

For example, to enter **Movies**:

- 1) When the phone is in the standby mode, recall the "Phonebook" menu by following steps 1-2 in "Storing Phone Numbers, Names, Distinctive Rings, and Speed Dial" on page 29.
- 2) Press the **STORE** soft key, "Store/Edit Name" appears.
- 3) Press **6** once to select "M", then press **(#)/▶** to move the cursor to the right.
- 4) Press **6** six times to select "o".
- 5) Press **8** six times to select "v".
- 6) Press **4** six times to select "i".
- 7) Press **3** five times to select "e".
- 8) Press **7** eight times to select "s".
- 9) When finished, press the **OK** soft key.

To continue to store the telephone number, proceed to step 6 on page 30.

VIEWING THE PHONEBOOK

Your phone stores names/numbers in the phonebook memory locations, and you can search names in alphabetical order. You can view the phonebook even while the phone is in use.

- 1) Press the **CID RDL PB** soft key (or the **MENU** soft key during a call).
- 2) Press **(volume) / ▲** or **▼** to move the pointer to "Phonebook", then press the **OK** soft key.

If you recall the phonebook during a call, the following screen appears.

```
Phonebook : 50
Search [A-Z/↑/↓]
Store [STORE]
BACK STORE
```

```
Phonebook : 50
Search [A-Z/↑/↓]
BACK
```

- 3) Press **(volume) / ▲** or **▼**, or the number keypad to scroll through the phonebook locations. Phonebook locations appear in alphabetical order (from first to last when you press **(volume) / ▼**, from last to first when you press **(volume) / ▲**).

Or, refer to the letters on the number keys to select the first letter of the desired name. Press a number key (**2**-**9** and **0**) once for the first letter, press twice for the second letter, and so on. The first location that begins with the letter you entered appears.

For example, to search for "Movies", press **6** once.

Press **(volume) / ▲** or **▼** until the phonebook location is displayed.

- 4) To finish the viewing operation, press the **BACK** soft key repeatedly or **(end)**.



- "/>SPDn" appears when you view a speed dial.

```
Movies
0800123456789
Flicker /SPD2
BACK DELETE EDIT
```

- During a call, don't press **(end)** or the call will be disconnected.



While the telephone is automatically dialing a number from speed dial memory, the speaker phone function is disabled for a few seconds.

MAKING CALLS USING THE PHONEBOOK

From Standby Mode

- 1) When the phone is in the standby mode, view the phonebook location to dial (see “Viewing the Phonebook” on page 33).
- 2) Press **(talk)**/flash or **(speaker)**. The displayed number is dialed.
- 3) To hang up press **(end)**.



From Talk Mode

- 1) Press **(talk)**/flash or **(speaker)**.
- 2) View the phonebook location to dial (see “Viewing the Phonebook” on page 33).
- 3) Press the **DIAL** soft key. The number in the displayed phonebook location is dialed.
- 4) To hang up press **(end)**.

SPEED DIALING

If you store a phone number in a speed dial memory location (10 locations: SPD1 - SPD0), you can use the speed dialing feature. When the phone is in the standby mode, press and hold a number key (**(0)** - **(9)**) associated with the speed dial until the phone number appears, then press **(talk)**/flash or **(speaker)**. The number stored in the speed dial (SPD1 - SPD0) is dialed.

EDITING OR ERASING A STORED NAME, PHONE NUMBER, DISTINCTIVE RING, AND SPEED DIAL

- 1) When the phone is in the standby mode, press the **CID RDL PB** soft key.
- 2) Press **[volume]** / ▲ or ▼ to move the pointer to "Phonebook", then press the **OK** soft key.
- 3) Press **[volume]** / ▲ or ▼, or the number keypad to view the phonebook locations (see "Viewing the Phonebook" on page 33).

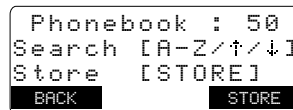

a. Editing the Stored Data

- 1) When the phonebook location to be edited appears, press the **EDIT** soft key. "Store/Edit Name" appears.
- 2) Follow the steps 4 to 8 under "Storing Phone Numbers, Names, Distinctive Rings, and Speed Dial" on page 30 to complete the editing operation.
- 3) Press the **OK** soft key. You will hear a confirmation tone.



b. Deleting the Stored Data

- 1) When the phonebook location to be deleted appears, press the **DELETE** soft key. "Delete Memory?" appears.
- 2) Press **[volume]** / ▲ to move the pointer to "Yes".
- 3) Press the **OK** soft key. You hear a confirmation tone. "Deleted!" appears in the display.

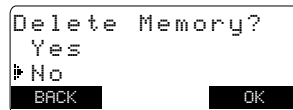

CHAIN DIALING

The memory locations in the handset are not limited to phone numbers. You can also store a group of numbers (up to 20 digits), that you need to enter once your call connects. This is referred to as Chain Dialing.

An example of this is a bank account number. Store a special number in the phonebook location (refer to “Storing Phone Numbers, Names, Distinctive Rings and Speed Dial” on page 29). Once you have called your bank, and when you are prompted to enter the account number, just as you do when viewing the phonebook location, view the special number, then press the **DIAL** soft key.



- The 10 memory locations in the base are independent from the handset.
- If you have not pressed any key for 30 seconds, the phone returns to the standby mode.
- If you make or receive a call, the operation is canceled.

MEMORY DIALING (base only)

You can store 10 phone numbers in the base, and make calls with memory dialing from the base.

Storing Phone Numbers

- 1) Press **(memory)** in the standby mode.
- 2) Enter the number you wish to store. (The number cannot exceed 20 digits.)
- 3) Press **(memory)**. Enter the memory location number (**0-9**) on the keypad.
You will hear a confirmation tone.

Deleting the Stored Data

- 1) Press **(memory)** in the standby mode.
- 2) Press **(memory)** again.
- 3) Enter the memory location number (**0-9**) you wish to delete.
You will hear a confirmation tone.

Making Calls with Memory Dialing

- 1) Press **(talk)** in the standby mode.
- 2) Press **(memory)**. Enter the memory location number (**0-9**) to dial the number.

CALLER ID

You must subscribe to Caller ID service to use this feature.

When the telephone rings, the Caller ID feature allows you to view the caller's name and phone number in the display before you answer the phone. Additionally, you can dial the displayed number and store the information for memory dialing.

Important:

Memory locations for Caller ID messages and Phonebook locations (including Speed Dials) are common, you can store up to 100 in total. A Caller ID message is not stored when you have stored 100 of the phonebook locations. The earliest Caller ID message is overwritten when you have stored 100 of the phonebook locations and Caller ID messages in total.



- If any of the following occurs during Caller ID operation, the operation will be canceled.
 - Press **end**. The phone will return to the standby mode (or the call will be disconnected).
 - Press **talk**/flash or **speaker**.
 - Receive an outside/intercom call or page.
 - Charge the handset.
- If the handset remains idle for 30 seconds, the phone will return to the standby mode (or back to the call).

1) When the Caller ID message is received, the display shows the caller's phone number along with the date and time. The incoming call information is stored in the Caller ID record.

The current telephone network in Australia and New Zealand does not show the caller name.

The date and time received

Caller's name

Caller's phone number

Soft keys

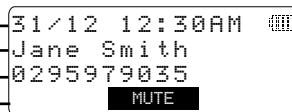

- If you answer a call before the Caller ID message is received (Example: before the second ring), the Caller ID message will not appear.
- When the call is received via a telephone company that does not offer Caller ID service, the caller's phone number does not appear. (This includes some international calls.)
- When the call is via a private branch exchange (PBX), the caller's phone number may not appear.



- The number of calls from the same Caller ID appears next to the received time. Once you have reviewed the new message, the number will be cleared and disappears.

- During a call, don't press **(end)** or the call will be disconnected.

You may receive any one of the following messages:

When invalid data is received

"Incomplete Data"

When a private name or number is received

"Private"

When an unknown name or number is received

"Unavailable"

When the mobile phone number and date are received

"Mobile"

When a call is coming from a payphone (Australia only)

"Payphone"

When an overseas call is received (New Zealand only)

"OVERSEAS CALL"

- 2) When you pick up the phone, the display changes to "Talk" (AutoTalk feature is set to on).

VIEWING THE CALLER ID LIST

The Caller ID list stores information for incoming calls – even unanswered calls.

You can store 100 of the Caller ID messages and Phonebook locations (including Speed Dials) in total. You can view the Caller ID list during a call or when the phone is in the standby mode.

- 1) Press the **CID RDL PB** soft key in the standby mode (or the **MENU** soft key during a call).
- 2) Press **(volume) / ▲** or **▼** to move the pointer to "Caller ID", then press the **OK** soft key. The screen shows the number of new messages and the total number of messages.
- 3) To view the Caller ID messages in historical order (from new to old or from old to new), repeatedly press **(volume) / ▼** to scroll through the messages from the latest to the earliest, or **(volume) / ▲** to scroll back through the messages.

Or, to view the Caller ID messages with alphabetical search, press the number key pad (**(2) - (9)** and **(0)**) with the letter associated with the first letter of the desired message.



Once you view the Caller ID list with alphabetical search, you cannot switch back to historical order (from new to old or from old to new) unless you exit and re-enter the operation.

- 4) To finish the viewing operation, press the **BACK** soft key repeatedly or **(end)**.

DELETING INFORMATION FROM THE CALLER ID LIST

Deleting a Caller ID message

- 1) When the phone is in the standby mode, view the Caller ID information to be deleted (see "Viewing the Caller ID List" on page 38).
- 2) Press the **DELETE** soft key.
"Delete Caller ID" appears.
- 3) Press **(volume) / ▲ or ▼** to choose "Yes".
- 4) Press the **OK** soft key. You will hear a confirmation tone.

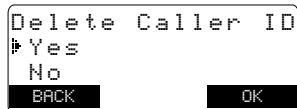

Deleting all Caller ID names/numbers

- 1) When the phone is in the standby mode, press the **CID RDL PB** soft key.
- 2) Press **(volume) / ▲ or ▼** to move the pointer to "Caller ID", then press the **OK** soft key.
The number of new and total records appear.
- 3) Press the **DELETE** soft key.
- 4) Press **(volume) / ▲ or ▼** to choose "Yes".
- 5) Press the **OK** soft key. You will hear a confirmation tone.

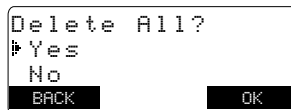
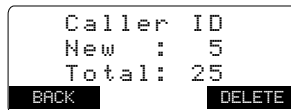

Once the Caller ID data has been deleted, the information cannot be retrieved.



- You cannot make a call from the Caller ID list if your phone is connected to a private branch exchange (PBX).
- If a call comes in via a telephone system that does not offer Caller ID service, no information is stored.
- If the Caller ID message was received as a private/unknown number, or the message does not have the number, you cannot store the message in the Phonebook.
- Even if the 100 memory locations are full, the message will be stored in the Phonebook. However, the message will be erased from the Caller ID list.

USING THE CALLER ID MESSAGE LIST

Calling a party from the Caller ID list From Standby mode

- 1) When the phone is in the standby mode, view the Caller ID message (see “Viewing the Caller ID List” on page 38).
- 2) Press **(talk)**/flash or **(speaker)**. The displayed phone number dials automatically.

| |
|--|
| 12/12 12:30AM |
| Jane Smith |
| 0295979035 |
| BACK DELETE STORE |

From Talk mode

- 1) Press **(talk)**/flash or **(speaker)**.
- 2) View the Caller ID message you want to dial (see “Viewing the Caller ID List” on page 38).
- 3) Press the **DIAL** soft key. The displayed phone number will be dialed.

Adding Zero to Caller ID message (New Zealand only)

While you review Caller ID information while the Insert Zero option is set to On, “0” is inserted. Refer to page 21 “Setting Insert Zero (New Zealand only)” to set the Insert Zero option to On or Off. New Zealand Telecom customers should leave Insert Zero to On. Other New Zealand companies may require Insert Zero set to Off.

Storing Caller ID messages in the Phonebook

Messages shown in the Caller ID list can be stored in the phonebook. Using the incoming call information (i.e., Caller ID list), the phone number and name of the party on the Caller ID list can be stored in memory.

- 1) When the phone is in the standby mode, view the Caller ID message to be stored. Then press the **STORE** soft key. “Store/Edit Name” appears.
- 2) To complete the setting, follow the steps 5-9 in “ Storing Phone Numbers, Names, Distinctive Rings, and Speed dial” on page 30.

THE INTEGRATED ANSWERING DEVICE

The phone has a built-in answering system that answers and records incoming calls. You can also use your answering system to record a conversation, leave a voice memo message, or to announce a special outgoing message to callers when you're away from your phone.

Features

- Digital Tapeless Recording
- Call Screening On/Off
- Voice Prompts for Menu Setup Guidance
- Remote Message Retrieval
- Conversation Recording
- Remote Operation from the Handset
- Approx. 14 Minutes of Recording Time
- Selectable Outgoing Messages
- Time and Day Announcement
- Toll Saver
- Voice Memo
- Message Alert

Digital Tapeless Recording allows you to quickly review, save, or delete the messages you choose. You will never have to worry about a tape wearing out, jamming, or resetting improperly.

The Integrated Answering System is easy and convenient to use, but **please read** through all of the instructions carefully.

THE INTEGRATED
ANSWERING DEVICE



NOTE

- When the answering system is full, "FL" appears on the base. You should delete some messages so that the system can record new messages.

- Position yourself as near to the base as possible and speak clearly when recording your outgoing message.
- If you make an outside call, or a call is received on this base during the operation, the operation is canceled.

TURNING THE ANSWERING SYSTEM ON/OFF

- 1) To turn the answering system On, press **(ans on)** in the standby mode. After the announcement "Answering System is on", the current greeting message will be played and you will hear a confirmation tone. The message counter displays the number of messages stored in memory. If the display flashes, then there are new messages waiting for you.
- 2) To turn the answering system Off, press **(ans on)**. After the announcement "Answering System is off", the message counter display will no longer be illuminated.

You can also turn the Answering System On or Off from the handset using the menu mode (see page 20).

SETTING UP YOUR ANSWERING SYSTEM

Setting your outgoing message (Greeting)

When you receive a call, the answering system automatically plays either the pre-recorded message or your own greeting.

Pre-recorded message

The following message is pre-recorded:

"Hello, no one is available to take your call. Please leave a message after the tone."

Recording a personal outgoing message (Greeting)

You can record a greeting up to 30 seconds long (must be more than 2 seconds long).

- 1) When the phone is in the standby mode, press and hold **(greeting)**.
- 2) Start your recording after the announcement "Record greeting". The message counter displays "30", then begins to count down.
- 3) When you have finished recording your greeting, press **(greeting)**, **(▶/□)** or **(SET)**. You will hear a confirmation tone and your recorded greeting plays back for you.

Choosing between the two outgoing messages

When the phone is in the standby mode, press **(greeting)**. Press **(greeting)** again when the outgoing message is played. Each time **(greeting)** is pressed, the outgoing message is switched between the pre-recorded and the personal outgoing message.

Deleting an outgoing message

To delete the personal outgoing message, press **(del)** while the message is playing. The system announces "Greeting has been deleted".

Setting the base ringer volume

You have four ringer volume options. One allows you to turn the base ringer off. The other three are volume levels.

- 1) When the phone is in the standby mode, press **(ringer/vol)** / ▲ or ▼. You hear the ringer at the current volume level ("3" High, "2" Medium, "1" Low, or "0" Off) (if you set the base ringer volume to off "Ringer Off" is announced), and it appears on the base.
- 2) Press **(ringer/vol)** / ▲ or ▼ repeatedly until the desired ringer volume appears. You will hear a ringer at the selected volume level. The system returns to the standby mode.

You can also set the base ringer volume while the phone is ringing. Press **(ringer/vol)** / ▲ or ▼ repeatedly to select the desired ringer volume.



- If an outside call is received during this operation, the operation is canceled.
- If you press **(ringer/vol)** / ▲ in the maximum volume level (3) or **(ringer/vol)** / ▼ in the ringer off (0), you will hear a beep.



Press and hold **(ringer/vol)** / ▲ or ▼ on the base to scroll quickly through the volume levels.

Adjusting the speaker volume level

When the base speaker is in use, press **(ringer/vol)** / ▲ or ▼ on the base to adjust the volume. Press **(ringer/vol)** / ▲ for louder or **(ringer/vol)** / ▼ for softer.

The numbers 1-10 appear on the base indicating the volume levels. 1 being the softest and 10 being the loudest.

Using the menu mode

The Menu mode allows you to set the following Answering System functions.

- To scroll through the menu options, repeatedly press **(CLOCK/MENU)** on the base in the standby mode. The system returns to standby after the last menu option. A confirmation tone sounds to indicate the standby mode.
- If you press **(▷/◻)**, the operation is canceled.
- If the system remains idle for about 5 seconds after the announcement, the system returns to standby. Once **(>>)/SELECT** or **(<<)/SELECT** is pressed, the idle time is extended to 10 seconds.
- If there is an incoming call, the operation is canceled.
- When you have completed the setting, press **(▷/◻)** to exit the menu mode, or **(CLOCK/MENU)** to move to the next menu option.
- You can also set these menus from the handset. See "Answering System Setup" on page 19 for instructions.

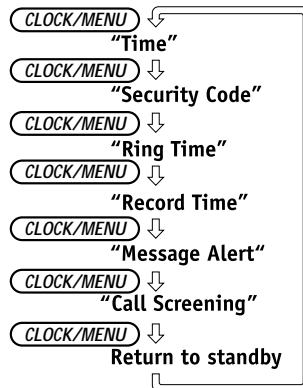

For your convenience, voice prompts will guide you through the menu setup mode.

Setting the Time

Follow these steps to set the clock on the answering system to the correct time.

- 1) Press **CLOCK/MENU**.
- 2) Press **▶▶** /SELECT or **◀◀** /SELECT until the correct day is announced and the corresponding number (from "1" Sunday to "7" Saturday) appears.
- 3) Press **SET** to select the day.
- 4) Press **▶▶** /SELECT or **◀◀** /SELECT until you hear the correct hour setting. The numbers "1" through "12" appear on the base as each hour is announced.
- 5) Press **SET** to select the hour.
- 6) Press **▶▶** /SELECT or **◀◀** /SELECT until you hear the correct minute setting. The numbers "00" through "59" appears on the base as each minute is announced.
- 7) Press **SET** to select the minute.
- 8) Press **▶▶** /SELECT or **◀◀** /SELECT until you hear the correct AM or PM setting. The message counter displays "A" or "P".
- 9) Press **SET** to select the AM/PM setting. A confirmation tone sounds, the day and time you set are announced for your review.

Setting a PIN code

To play your messages from a remote location, you will need to enter a two-digit Personal Identification Number (PIN) code (00-99). To select a PIN code, perform the following steps:

- 1) Press **CLOCK/MENU** twice. The current PIN code appears on the base and it is announced.
- 2) Press **▶▶** /SELECT or **◀◀** /SELECT until the desired number appears. Press and hold **▶▶** /SELECT or **◀◀** /SELECT to quickly scroll through the numbers on the display.
- 3) Press **SET** to select the PIN code. A confirmation tone sounds, the system announces the new PIN code.



- Normally, if the system remains idle for 10 seconds after **▶▶** /SELECT or **◀◀** /SELECT is pressed, the system will return to standby. However, for setting the time, the idle time is extended to 2 minutes.
- Press and hold **▶▶** /SELECT or **◀◀** /SELECT to quickly scroll through the numbers on the display.
- Time stamp will not be heard until you have set the time.

Setting the ring time

The ring time setting allows you to set the number of rings the caller hears before your answering system plays the outgoing message. You can set the ring time to answer after four, six, or nine rings. Setting "TS" (Toll Saver), the answering system picks up after six rings if you have new messages, and after nine rings if there are none. This way, if you make a long distance call to check your messages, you can hang up after the sixth ring to avoid billing charges.

- 1) Press **CLOCK/MENU** three times.

The current ring time setting ("4" 4, "6" 6, "9" 9 or "TS" Toll saver) appears on the base and it is announced.

- 2) Press **➤** /SELECT or **⏪** /SELECT until the desired ring time appears.
- 3) Press **SET** to select the new ring time.

A confirmation tone sounds, the system announces the new ring time.

Selecting the message record time

You have three record time options. The options "1 minute" or "4 minutes" set the duration for recording the incoming messages. "Announce only" answers the call with the preset greeting or your personal greeting but prevents the caller from leaving a message.

- 1) Press **CLOCK/MENU** four times.

The current recording time ("1" 1 minute, "4" 4 minutes, "R" Announce only No recording) appears on the base and it is announced.

- 2) Press **➤** /SELECT or **⏪** /SELECT until the desired message record time appears.
- 3) Press **SET** to select the new recording time.

A confirmation tone sounds, the system announces the new record time.

Announce only feature

The Announce only feature plays a pre-recorded outgoing message “Hello, no one is available to take your call. Please call again.”, and it will not allow the caller to leave a message. To set “Announce only”, follow the steps on page 46. The outgoing message automatically switches to announce only message. To choose between the pre-recorded message or your own personal greeting, press **(greeting)**, when the outgoing message is played.

If you want to use your own greeting, or want to change your greeting to omit the prompt to leave a message, refer to “Recording a personal outgoing message (Greeting)” on page 42.

Setting the message alert

Message Alert feature lets you know when you have a new incoming message by sounding a short alert tone.

If you set the Message Alert On, and when a new message is received, the alert tone will sound every 15 seconds.

- 1) Press **(CLOCK/MENU)** five times. The current setting (On or Off) appears on the base and it is announced.
- 2) Press **(>>X) /SELECT** or **(<<) /SELECT** to choose “On” or “Off”.
- 3) Press **(SET)**.

A confirmation tone sounds, the system announces the current setting you have selected.

When the first new message is received, the alert tone will begin to sound.

Turning the message alert tone Off by pressing any key

To quickly turn Message Alert tone Off, press any key on the base unit and the tone will automatically deactivate.

Turning the message alert tone Off when you are away from your phone

When all new messages are played back using the remote playback feature (see pages 52-54) the Message Alert will automatically deactivate. The tone will not deactivate until all new messages are played back.

Setting the call screen

You can screen calls when the Call Screen function is set to On.

1) Press **(CLOCK/MENU)** six times.

The current Call Screen setting (On or Off) appears on the base.

2) Press **(>>)** /SELECT or **(<<)** /SELECT to choose "On" or "Off".

3) Press **(SET)**. A confirmation tone sounds, and the system announces the new setting.

You can mute the Call Screen temporarily. When the system is answering, press **(▶/□)**.

The Call Screen function resumes when the system is no longer in answering mode.

Additionally, to adjust the volume, press **(ringer/vol)** / ▲ or ▼.



If you set the answering system to Off, you cannot screen a call.

Screening a call

To screen an incoming call, do the steps as follows:

After the answering system answers, the base speaker will let you hear the calls as the machine records the message.

To answer the call, press **(☎)** (talk) or pick up the handset from the base (when AutoTalk is set to On). If the handset is away from the base, press **(talk)/flash**, **(speaker)** or any number key, **(*)**, or **(#)** (when Anykey Answer is set to On). The answering system will disconnect automatically.

USING YOUR ANSWERING SYSTEM

The message counter displays the number of messages stored in memory. If the display flashes, then there are new messages waiting for you. The answering system is designed to play your new messages first. After you play all your new messages, you can then play your old messages.

Playing your messages

- 1) When the phone is in the standby mode, press **(▶/□)**.

The system announces the number of new and old messages while the message counter displays only the number of new messages. The time and day that each message was received is announced after the message is played.

- 2) When all new messages have been played, you hear a confirmation tone and the system announces "End of message". The system returns to standby. After you have reviewed your new messages, you can play your old messages by again pressing **(▶/□)**.

Once you have listened to a new message, it then becomes an old message. The old messages will be played in the order in which they were received.

Repeating a message

- 1) Press **(▶/□)** to review your messages. The number of stored messages is announced.
- 2) To repeat the current message, press **(◀◀) /SELECT** after a few seconds of beginning the message. To quickly scroll backwards through a message, press and hold **(◀◀) /SELECT**. To repeat the previous message, press **(◀◀) /SELECT** within a few seconds (about 4 seconds during remote operation) after a message begins playing. If you have several messages, press **(◀◀) /SELECT** repeatedly until you return to the message you want to replay. If the current message is the first new message, the system plays back from the beginning of the current message (it does not go back into the old message group).
- 3) Press **(▶/□)** at any time to stop reviewing messages and return to standby. The message counter shows the number of messages stored in memory.



- If an outside call is received during this operation, the operation is canceled.

- To stop playing your messages, press **(▶/□)** again at any time.
- When the answering system is full, "FL" appears on the base. You should delete some messages so that the system can record new messages. (Refer to "Deleting a message" on page 50.)

Skipping a message

- 1) Press **[▶/□]** to review your messages. The number of stored messages is announced.
- 2) Press **[>X]** /**SELECT** at anytime to skip to the next message.
Each time **[>X]** /**SELECT** is pressed, the system scans forward one message. If you have several messages, press **[>X]** /**SELECT** repeatedly to find the message you want to play. To quickly scroll through a message, press and hold **[>X]** /**SELECT**. The system advances through the playback at double speed.
- 3) Press **[▶/□]** at anytime to stop reviewing your messages and return to standby. The message counter shows the number of messages stored in memory.

Deleting a message

To maintain maximum record time, delete the old messages.

- 1) Press **[▶/□]** to review your messages.
- 2) Press **[∅ del]** at anytime during the message to delete the message.
You hear a confirmation tone and the message is deleted.
To delete all messages, press **[∅ del]** in the standby mode. Press **[∅ del]** again after the announcement "To delete all message, press delete again".

When you try to delete all messages without first listening to your new messages, you hear several short beeps followed by an announcement "Please playback all messages". This protects you from accidentally erasing messages you have not yet reviewed.

Important:

When you press **[∅ del]**, you are permanently deleting the message. Once deleted, the message cannot be replayed or retrieved.

Voice memo

The voice memo function allows the user to record messages (more than 2 seconds and within 4 minutes).

- 1) Press and hold **(memo rec)** . You hear a beep.
- 2) Start your recording after the announcement "Record Memo Message" and a confirmation tone. The message counter displays "--".
- 3) When you have finished, press **(memo rec)** , **(▶/□)** , or **(SET)** to stop recording. The system returns to standby.



- The voice memo messages are recorded as an incoming messages.
- When the answering system is full, "FL" appears on the display and recording is terminated.
- If an outside call is received during the operation, the operation is canceled.

Recording a conversation

You can record a conversation from the handset or the base (more than 2 seconds and within 10 minutes).



- A recorded conversation is treated as an incoming message and will be added to the stored messages.
- You cannot record 3-way or intercom conversations.
- When the answering system becomes full, "FL" appears on the display and recording is terminated.

From the handset

- 1) During a conversation, press the **MENU** soft key on the handset.
- 2) Press **(volume)** / **▲** or **▼** to select "Recording", then press the **OK** soft key. **(memo rec)** appears on the handset, and "--" flashes on the base.
A tone, that can be heard by both parties, sounds during recording.
- 3) Press the **STOP** soft key to finish recording. You will hear a confirmation tone.

From the base

- 1) During a conversation using the base speaker phone, press and hold **(memo rec)** on the base until you hear a confirmation tone. The unit begins recording and "--" flashes on the display.
A tone, that can be heard by both parties, sounds during recording.
- 2) To stop recording, press **(▶/□)** or **(memo rec)** . You hear a confirmation tone.



For your convenience a remote operation card is provided for you to use while away from home (refer to page 67).

REMOTE OPERATION

You can operate your answering system from a remote location using any touch-tone telephone or the handset.

Remote access away from home

You can check, play, or delete messages, even record a new greeting message when you are away from home. Additionally, you can turn On or Off your answering system from a remote location.

- Time stamp will not be heard until you have set the time. See “Setting the Time” on page 45.
- The system will only playback messages for four minutes and then it returns to the command waiting mode. To continue playing your messages, press # then 2 again within 15 seconds.
- If you enter an incorrect PIN code three times, you will hear a beep and the system will return to standby.
- During the remote operation, “Lr” appears on the base.



- 1) Call your telephone number and wait for the system to answer. If the answering system is off, it will answer after about 15 rings and sounds a series of beeps.
- 2) During the greeting message (or a series of beeps when the answering system is off), press # and enter your PIN code within 2 seconds (see “Setting a PIN Code” on page 19 or 45).
- 3) The answering system announces the current time and the number of messages stored in memory. You hear “To play incoming messages, press pound two. For help, press pound-zero”. You will hear a beep.
- 4) Enter a command within 15 seconds, each command there after must be entered within 2 seconds. You may select a command from the following chart:

| Command | Function | Command | Function |
|----------|---------------------------|----------|---------------------------------|
| # then ① | Repeat a Message* | # then ⑥ | Answering System On |
| # then ② | Playing incoming Messages | # then ⑦ | Memo Record/Stop ** |
| # then ③ | Skipping a Message | # then ⑧ | Greeting Message Record/Stop ** |
| # then ④ | Deleting a Message | # then ⑨ | Answer System Off |
| # then ⑤ | Stop Operation | # then ⑩ | Help Guidance |

- * For Repeat a Message function, press # then ① within about four seconds to repeat the previous message, or press # then ① after about four seconds to repeat the current message.
- ** For Memo Record and Greeting Message Record function, the first time you enter the corresponding command, it starts the Recording function. If you want to stop the recording, press # then ⑦ or ⑧.
- 5) After the command has finished, you hear intermittent beeps indicating that the system is in the command waiting mode. You may enter another command at this time from the chart above.
- 6) When you are finished, hang up to exit the system. The answering system automatically returns to standby.

Remote access with the handset

You can check your new incoming messages, skip, repeat, or delete your incoming messages with the handset. For example, you can install the answering system in the living room, and check your incoming message from a bedroom with the handset. You can also use speakerphone on the handset for remote operation (see "Making and receiving calls" on page 23).



- If you press (end) before the answering system answers, the phone will return to standby.
- When the answering system does not answer within 6 seconds, you hear a beep and the phone will return to standby.
- The base's keypad is disabled during remote operation.
- When you receive a call, the remote operation is canceled.
- You can change the handset volume during a remote operation.
- During the remote operation "rP" appears on the base.





- If you have new messages and old messages, only the new messages will be played. After you have reviewed your new messages, you can play your old messages by again pressing the  soft key. Once you have listened to a new message, it then becomes an old message.
- If you have new messages and old messages, only the new messages will be repeated.
- If you press the  soft key while the earliest message is playing, you can repeat only the current message.

Playing incoming messages

- 1) When the phone is in the standby mode, press the  soft key on the handset. “Remote Playback” appears on the handset display. The answering system announces the current time and the number of messages stored in the memory. Messages will be played in the order in which they were received. The time and day that each message was received is announced after the message is played.
- 2) When you are finished, hang up to exit the system. The answering system automatically returns to standby.

When the last message has been played, the system announces “End of messages”. And the system returns to standby.

Repeating a message

After a message begins playing, press the  soft key within about four seconds to repeat the previous message, or press the  soft key after about four seconds to repeat the current message.

Skipping a message

While the message is playing, press the  soft key on the handset. Each time the  soft key is pressed, the system scans forward one message.

Deleting a message

While the message is playing, Press the **DELETE** soft key on the handset. The message playing is deleted.

EXPANDING YOUR PHONE

Your phone supports up to 4 handsets (including the handset(s) supplied with your phone). You can now place a fully featured cordless handset anywhere AC power is available to connect the handset charger.

Effective combinations, for example:

- 4-way conferencing (the base, 2 handsets, and one outside line), while on an intercom call using the other 2 handsets, or
- 4-way conferencing (3 handsets and an outside line)

IMPORTANT:

- If you purchase a DSS2405 extra handset, please register the handset to the DSS2455 or DSS2465 series base before use. The DSS2405 will not operate until it is registered.
- If you change a setting of the Global Setup and Answering Setup menu in one of the handsets, you change settings for all the handsets. For all other features they must be set separately through each handset.

CONNECTING THE CHARGER

- 1) Connect the AC adapter into the charging cradle and to a AC wall outlet.
- 2) Set the charger on a desk or tabletop, and place the handset in the charger with the keypad facing forward (see "Installing the AA batteries" on page iii to install the batteries).

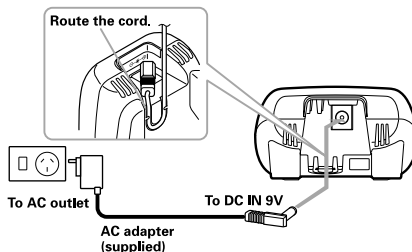

- To use the DSS2405, register it to the DSS2455 or DSS2465 series base.
- Save this manual for detailed operation.
- All of the handsets ring when a call is received.

REGISTER THE HANDSET

If you purchase an extra handset, you need to register the handset to the main base before use. Only one handset can be registered at a time.

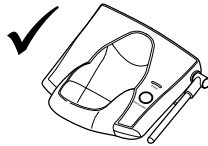

DSS2415
Main Base



DSS2455/2465
Main Base



Charger

The handset ID for the supplied handset(s) was assigned at the factory, which has #1 (#1 and #2 for DSS2465) in the display. When you register additional handset to the base, the handset ID will be assigned.



An extra handset can be registered when the base is in the standby mode.

- 1) Before registering the extra handset, charge the phone's battery for 10 minutes.
- 2) Place the extra handset in the main base unit to begin registration.
- 3) While the handset is registering, "Handset Registering" will appear in the LCD. When "Registration Complete" is displayed, the handset has been registered to the base. If "Registration Failed" appears, please try these steps again.
- 4) Place the handset back in the charging cradle and fully charge the phone's battery for 17 to 20 hours.

USING TWO WAY COMMUNICATION BETWEEN THE HANDSETS ANYWHERE WITHOUT THE BASE (DIRECTLINK)

To use this feature, you must enter the two handsets into the DirectLink mode first.

To enter the DirectLink mode ⇒ See page 16



- During DirectLink mode, batteries use time when fully charged is as follows:
 - Up to 7 hours continuous use.
 - Up to 24 hours in the standby mode.
- Placing the handset in the cradle causes the handset to exit the DirectLink mode.

DirectLink call

- 1) When the phone is in the DirectLink standby mode, press the **DirectLink** soft key (example of DirectLink from handset #1).
- 2) Select the party by pressing the number keys (1-4). Your handset will page the other handset.
- 3) On the receiving handset, press **(talk)**/flash or the **ANSWER** soft key, or if Anykey Answer is On, press any number key, **(*)**/**←**, or **(#)**/**→**.
- 4) When you finish your conversation, press **(end)** or **END** soft key on either handset. Return the handset to the cradle, or press the **CANCEL** soft key then the **OK** soft key to return to normal mode.

SUN 12:00A
Handset #1
DirectLink Mode
CANCEL DirectLink

To DirectLink
press 1-4
BACK

DirectLink
from Handset #1
ANSWER

3-WAY CONFERENCING

The phone permits 3-way conversations between the handset, base, and an outside line.

When speaking on the handset

- 1) Press **(talk)** on the base to initiate the 3-way conversation.
- 2) To hang up, press **(talk)** on the base. The handset will still be connected to the call.

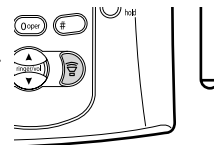

When speaking on the base

- 1) Press **(talk)/flash** or **(speaker)** on the handset to initiate the 3-way conversation.
- 2) To hang up, return the handset to the cradle, or press **(end)** on the handset. The base will still be connected to the call.



For DSS2455, if you purchase a DSS2405 extra handset, the phone permits 4-way conversation, see "4-way Conferencing" below for details.

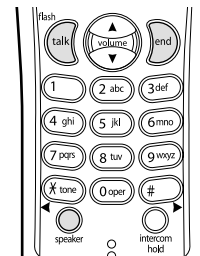

4-WAY CONFERENCING

Fourth person, at either the handset or the base, may be added to the conference call.

For example, to add a fourth party to an ongoing conference call at the base or another handset, press **(talk)/flash** on the fourth party's handset (or **(talk)** on the base). To remove either caller from your conversation, press **(end)** on the party's handset (or **(talk)** on the base). The other parties will still be connected to the call.

INTERCOM/CALL TRANSFER FEATURE

Intercom and Call Transfer features are available for your phone.



- If the party is busy or out of range, you will hear a beep and the handset returns to the standby mode.
- If any of the following occurs, the operation will be canceled.
 - Press **(talk)/flash** or **(speaker)** on the handset, and **(talk)** on the base.
 - Receive an outside/intercom call or page (while selecting the other handset).
- When the party does not answer within 1 minute, Intercom or Call Transfer is canceled.

Intercom

From handset to handset or to the base

- 1) Press **(intercom/hold)** in the standby mode.
- 2) Select the base or the handset you want to talk with from the selection list within 30 seconds. To select the handset (or the base), press **(volume)/▲** or **▼**, then press the **OK** soft key.

If you select "All", all handsets will be paged. An intercom tone sounds.

- 3) On the receiving handset (or the base), to answer the call, press **(talk)/flash**, **(intercom/hold)**, or the **ANSWER** soft key (or **(int'com/hold)** or **(talk)** on the base). Or press any number key, **(*)/◀**, or **(#)/▶** (when Anykey Answer is On), or pick up the handset from the cradle (when AutoTalk is On).
- 4) To hang up the intercom call, press **(end)** or the **END** soft key on either handset (or press **(int'com/hold)** on the base).

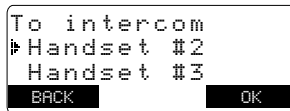

From the base to a handset

- 1) Press **(int'com/hold)** on the base in the standby mode.
- 2) Select the handset you want to talk with by pressing the number key (1-4).
To page all the handsets press **(*)**.
- 3) Follow the steps 3-4 under "From handset to handset or to the base".

Call Transfer Feature

From handset to handset or to the base

- 1) During a call, press **(intercom/hold)** on the handset.
- 2) Select a handset or the base to transfer the call to within 10 seconds (refer to step 2 under "From handset to handset or to the base" in the intercom section). The call will automatically be placed on hold, and an intercom tone sounds. To cancel the transfer, press the **CANCEL** soft key, **(talk)/flash**, **(speaker)** or the **BACK** soft key on the initiating handset.
- 3) On the receiving handset, to answer the page, press **(talk)/flash**, **(intercom/hold)**, or the **ANSWER** soft key (or **(int'com/hold)** or **(☎)** (talk) on the base). Or press any number key, **(*)/◀**, or **(#)/▶** (when Anykey Answer is On), or pick up the handset from the cradle (when AutoTalk is On). The intercom mode is activated, but the caller is still on hold.
- 4) To speak to the caller, press **(talk)/flash** or **(speaker)** on the receiving handset (or **(☎)** (talk) on the base).

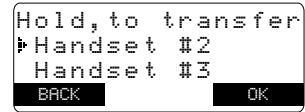

From the base to a handset

- 1) During a call, press **(int'com/hold)** on the base. The call will automatically be placed on hold.
- 2) Select the handset you want to talk with by pressing the number key (1-4). To page all the handsets press **(*)**. An intercom tone sounds. To cancel the transfer, press **(int'com/hold)** or **(☎)** (talk) on the base.
- 3) On the receiving handset, to answer the page, press **(talk)/flash**, **(intercom/hold)**, or the **ANSWER** soft key. Or press any number key, **(*)/◀**, or **(#)/▶** (when Anykey Answer is On), or pick up the handset from the cradle (when AutoTalk is On). The intercom mode is activated, but the caller is still on hold.
- 4) To speak to the caller, press **(talk)/flash** or **(speaker)** on the receiving handset

CHANGING THE DIGITAL SECURITY CODE

The digital security code is an identification code used to connect the handset and the base unit. Normally, setting the code is not necessary. In the rare situation that you suspect another cordless telephone is using the same security code, you can change the code. To change the digital security code:

1. Perform the "System Reset" menu options ("Deregister the Handset" and "Replacing the Base Setting") for all the handsets you have (see page 14).
 2. To register all the handsets do the following steps:
 - 1) Place a handset, one at a time in the base.
 - 2) Registration starts automatically.
While registering "Handset Registering" appears in the display.
 - 3) When the registration is complete, "Registration Complete" appears in the display.
 - 4) Repeat steps 1 - 3 for another handsets.
- If the registration fails, "Registration Failed" appears in the display. Try the steps above again.

NOTE ON POWER SOURCES

Battery replacement and handling

When the operating time becomes short, even after a battery is recharged, please replace the battery. Please use only "AA" rechargeable Ni-MH batteries.

Warning

To avoid the risk of personal injury or property damage from fire or electrical shock, only use the Uniden adapter model specifically designated for this product, and "AA" rechargeable Ni-MH batteries.

Caution

- Use only "AA" rechargeable Ni-MH batteries.
- Do not remove the batteries from the handset to charge them.
- Never throw the batteries into a fire, disassemble them, or heat them.
- Do not remove or damage the battery casing.

TROUBLESHOOTING

If your phone is not performing to your expectations, please try these simple steps first.

| Symptom | Suggestion |
|--|--|
| The charge LED won't illuminate when the handset is placed in the cradle. | <ul style="list-style-type: none">• Make sure the AC adapter is plugged into the base (or the charger (for DSS2465 only)) and wall outlet.• Make sure the handset is properly seated in the cradle.• Make sure the charging contacts on the handset and the base (or the charger (for DSS2465 only)) are clean. |
| The audio sounds weak and/or scratchy. | <ul style="list-style-type: none">• Move the handset and/or base to a different location away from metal objects or appliances and try again.• Make sure that you are not too far from the base. |
| Can't make or receive calls. | <ul style="list-style-type: none">• Check both ends of the base telephone line cord.• Make sure the AC adapter is plugged into the base and wall outlet.• Disconnect the AC adapter for a few minutes, then reconnect it.• Remove the base ID (see "Deregister the Base Setting" on page 22) and register the handset to the base (see "Register the Handset" on page 56).• Make sure that you are not too far from the base.• If an outside call is already established, you may not be able to make another outside call. |
| Can't make an internal call. | <ul style="list-style-type: none">• Make sure that the receiving handset is not already in use.• Make sure that the handset or the base is in the standby mode.• When a handset is recording a conversation, an intercom call from or to the base is not available. Make sure a handset is not recording a conversation. |

| Symptom | Suggestion |
|---|--|
| The handset or the base doesn't ring or can't receive an intercom call. | <ul style="list-style-type: none"> • Charge the batteries in the handset for 17-20 hours by placing the handset on the base or charging cradle. • The handset may be too far away from the base unit. • Place the base unit away from appliances or metal objects. • Remove the base ID (see "Deregister the Base Setting" on page 22) and register the handset to the base (see "Register the Handset" on page 56). • If more than 3 handsets are in use, you may not be able to page. |
| "Unavailable" appears in the display. | <ul style="list-style-type: none"> • Make sure that another handsets or the base is not in use, and try the phone again. • Make sure that you are not too far from the base. |
| Severe noise interference. | <ul style="list-style-type: none"> • Keep the handset away from microwave ovens, computers, remote control toys, wireless microphones, alarm systems, intercoms, room monitors, fluorescent lights, and electrical appliances. • Move to another location or turn off the source of interference. |
| The Caller ID does not display. | <ul style="list-style-type: none"> • The handset was picked up before the second ring. • The call was placed through a switchboard. • Call your local telephone company to verify your Caller ID service is current. |
| You cannot register the handset at the base. | <ul style="list-style-type: none"> • Please make sure your batteries are charged at least 10 minutes (see "Register the Handset" on page 56). • Remove the base ID (see "Deregister the Base Setting" on page 22) and register the handset to the base (see "Register the Handset" on page 56). • Only 4 handsets can be registered to the base. |
| The handset doesn't communicate with the base or other handsets. | <ul style="list-style-type: none"> • Remove the base ID (see "Deregister the Base Setting" on page 22) and register the handset to the base (see "Register the Handset" on page 56). • Make sure that you have registered all handsets. |

| Symptom | Suggestion |
|---|---|
| The handset or the base can't join the conversation. | <ul style="list-style-type: none"> • Make sure that more than 3 handsets (or 2 handsets when the base is used for the conference) are not in use. • When recording a conversation, the 2nd handset (or the base) cannot join the conversation. |
| The answering system does not work. | <ul style="list-style-type: none"> • Make sure the base unit is plugged in. • Make sure that the answering system is turned On. • Make sure that the message record time is not set to Announce only (see page 47). |
| Messages are incomplete. | <ul style="list-style-type: none"> • The incoming messages may be too long. Remind callers to leave a brief message. • The memory may be full. Delete some or all of the saved messages. |
| After a power failure, the outgoing message is deleted. | <ul style="list-style-type: none"> • Record your greeting again. The default message should remain. |
| No sound on the base unit speaker during call monitoring or message playback. | <ul style="list-style-type: none"> • Adjust the speaker volume on the base unit. • Make sure the call screen feature is set to On. |
| Cannot access remote call-in features from another touch-tone phone. | <ul style="list-style-type: none"> • Make sure you are using the correct PIN number. • Make sure that the touch-tone phone you're using can transmit the tone for at least two seconds. If it cannot, you may have to use another phone to access your phone. |
| Time stamp cannot be heard. | <ul style="list-style-type: none"> • Make sure you have set the time (see "Setting Day and Time" on page 21 or "Setting the Time" on page 45). |
| If you still have a problem. | <ul style="list-style-type: none"> • Call our customer Service Division at 1300 366 895 (Australia) or 0800 4864 336 (New Zealand). |

INDEX

0 - 9

- 3-way conferencing58
- 4-way conferencing58
- 16 ring options17

A

- Announce only feature47
- Answering system
 - Deleting a message50
 - Playing your messages49
 - Recording a conversation51
 - Remote access52
 - Repeating a message49
 - Skipping a message50
 - Turning On/Off42
- Anykey answer18
- AutoTalk17

B

- Banner18
- Base speaker volume44
- Battery
 - Preparing and chargingiv
 - Replacement and handling7
- Beltclip7
- Booster26

C

- Caller ID
 - Caller ID service37
 - Calling40
 - Call Waiting28

- Deleting39
- Storing40
- Using40
- Viewing38
- Call transfer feature60
- Chain dialing36
- Clock45
- Conversation, recording51

D

- Deregister the handset22
- Digital security code61
- Distinctive ringer17

E, F, G, H

- Earpiece volume26
- Expanding your phone55
- Hands-free conversation23
- Headset installation8

I, J, K, L

- Intercom59
- LCD contrast18

M, N, O

- Making a call23
- Memory dialing36
- Mute27
- New Message LED28
- Outgoing Message42
- Overseas Calls38

P, Q

- Package contents5
- Phonebook29
 - Editing35
 - Erasing35
 - Making calls34
 - Storing29
 - Viewing33

R

- Receiving a call23
- Redialing a call24
- Register the handset56
- Remote access
 - away from home52
 - from your handset53
- Ringer volume16

S

- Setting up
 - base unitii
 - handsetiii
- Soft key function9
- Speed dialing34

T, U, V, W, X, Y, Z

- Transferring a call60
- Troubleshooting63
- Voice memo51
- Warranty69

REMOTE OPERATION CARD

CUT

REMOTE OPERATION CARD

Uniden®

Remote access away from home

1. Call your phone number from a touch-tone phone.
2. During the outgoing message, press **#** and enter your PIN code. The answering system announces the number of messages stored in memory and the help guidance.
3. To quit, hang up the phone.

Turn on the answering system remotely

1. Call your phone and let it ring 15 times until you hear a beep.
2. Press **#** and then enter your PIN code.
3. Press **#** then 5 to stop the announcement.
4. Press **#** then 6 to turn the answering system on.

CUT

| Task | Key |
|------------------------------|---------------------|
| Repeat a Message | # 1 |
| Playing incoming Messages | # 2 ^{abc} |
| Skipping a Message | # 3 ^{def} |
| Deleting a Message | # 4 ^{ghi} |
| Stop Operation | # 5 ^{jkl} |
| Answering System On | # 6 ^{mno} |
| Memo Record/Stop | # 7 ^{pqrs} |
| Greeting Message Record/Stop | # 8 ^{tuv} |
| Answer System Off | # 9 ^{wxyz} |
| Help Guidance | # 0 ^{oper} |

WARRANTY

One Year Limited Warranty

Important: Evidence of original purchase is required for warranty service.

Warrantor: Uniden Australia Pty Limited A.B.N. 58 001 865 498
Uniden New Zealand Limited

ELEMENT OF WARRANTY: Uniden warrants to the original retail owner for the duration of this warranty, its DSS2455/DSS2465 (herein after referred to as the Product), to be free from defects in materials and craftsmanship with only the limitations or exclusions set out below. Warranty is only valid in the original country of purchase.

WARRANTY DURATION: This warranty to the original retail owner only, shall terminate and be of no further effect 12 months after the date of original retail sale. This warranty will be deemed invalid if the product is;

- (A) Damaged or not maintained as reasonable and necessary,
- (B) Modified, altered or used as part of any conversion kits, subassemblies, or any configurations not sold by Uniden,
- (C) Improperly installed,
- (D) Repaired by someone other than an authorized Uniden Repair Agent for a defect or malfunction covered by this warranty,
- (E) Used in conjunction with any equipment or parts or as part of a system not manufactured by Uniden.

PARTS COVERED: This warranty covers for one (1) year, the Base Unit and Handset only. All accessories (AC Adapter etc) are covered for 90 days only.

STATEMENT OF REMEDY: In the event that the product does not conform to this warranty at any time while this warranty is in effect, the warrantor at its discretion, will repair the defect or replace the product and return it to you without charge for parts or service. THIS WARRANTY DOES NOT COVER OR PROVIDE FOR THE REIMBURSEMENT OR PAYMENT OF INCIDENTAL OR CONSEQUENTIAL DAMAGES. THIS GUARANTEE IS IN ADDITION TO AND DOES NOT IN ANY WAY AFFECT YOUR RIGHTS UNDER THE CONSUMER GUARANTEE ACT.

PROCEDURE FOR OBTAINING PERFORMANCE OR WARRANTY: In the event that the product does not conform to this warranty, the Product should be shipped or delivered, freight pre-paid, with evidence of original purchase (eg. a copy of the sales docket), to the warrantor at:

UNIDEN AUSTRALIA PTY LIMITED SERVICE DIVISION

345 Princes Highway, Rockdale NSW 2216

Ph 1300 366 895 Fx (02) 9599 3278

We can also be reached on the

www.uniden.com.au

UNIDEN NEW ZEALAND LIMITED SERVICE DIVISION

150 Harris Road, East Tamaki, Auckland

Ph 0800 4 UNIDEN (4 864 336) Fx (09) 274 4253

We can also be reached on the

www.uniden.co.nz

Customers in other States should ship or deliver the Product freight pre-paid to their nearest Uniden Authorized Repair Centre (Contact Uniden for the nearest Warranty Agent to you).

Additional Handset & Charger

Expand Your System!

DSS2405 HANDSET & CHARGER

Easily expand your cordless phone system by adding the DSS2405 Handset and Charger*. The DSS2405 gives you the mobility you need to stay connected with friends and family. Place this handset and charger in any convenient location, no need for an extra phone jack! Another innovation from Uniden, the company that bring outstanding wireless communication products to people's lives throughout the world.

* Operates with
Multi Handset
Cordless Systems:
DSS2415
DSS2455/2465



Uniden®

**Optional 2.4 Ghz
Cordless Handset and
Charging Cradle**

**For use with Multi
Handset Cordless
Systems: DSS2415,
DSS2455/2465**

Digital Spread Spectrum

Call Transfer

Caller ID

No Phone Jack Needed

© 2003

Uniden Australia Pty Limited
Uniden New Zealand Limited
Printed in China
UPZZ01308BZ

AVAILABLE AT PARTICIPATING RETAIL STORES

Free Manuals Download Website

<http://myh66.com>

<http://usermanuals.us>

<http://www.somanuals.com>

<http://www.4manuals.cc>

<http://www.manual-lib.com>

<http://www.404manual.com>

<http://www.luxmanual.com>

<http://aubethermostatmanual.com>

Golf course search by state

<http://golfingnear.com>

Email search by domain

<http://emailbydomain.com>

Auto manuals search

<http://auto.somanuals.com>

TV manuals search

<http://tv.somanuals.com>