

**Uniden** | A World Without Wires®

UNIDEN  
CORDLESS  
PHONES



# DCT756 SERIES

OWNER'S MANUAL

DCT756 &  
DCT7565

## Contents

<b>Welcome</b> .....	5
Accessibility .....	5
Terminology used in this Manual .....	5
<b>Product Overview</b> .....	6
<b>DCT756 and DCT7565 - Parts of the Handset</b> .....	7
<b>DCT756 - Parts of the Base</b> .....	8
<b>DCT7565 - Parts of the Base</b> .....	9
<b>Handset Icons</b> .....	10
<b>Using the Interface</b> .....	11
Using the Four-way Function Key .....	11
Using the Handset Menus .....	11
Entering Text from Your Handset .....	12
<b>Installing the Phone</b> .....	13
Choosing the Best Location .....	13
Wall Mounting the Base (DCT7565 Only) .....	14
Direct Wall Mounting (DCT7565 Only) .....	15
Installing the Rechargeable Battery .....	16
Connecting the Base and Charging the Handset .....	17
Installing the Belt Clip .....	18
Connecting to the Phone Line .....	18
Testing the Connection .....	18
Changing the Dial Mode .....	19

<b>Basic Setup</b> .....	19
Selecting a Language .....	19
Setting the Day and Time .....	19
Activating Caller ID on Call Waiting and Call Waiting Deluxe .....	20
Activating Personal Ring .....	20
Activating the Key Touch Tone .....	21
Setting up Voice Mail .....	21
Setting the Voice Mail Signaling Tone .....	21
Programming One-Touch Voice Mail Access .....	22
Resetting the Voice Message Waiting Indicator .....	22
<b>Adding Extra Handsets</b> .....	23
Compatible Handsets .....	23
Charging the Accessory Handset .....	23
<b>Registering Accessory Handsets</b> .....	24
Registering DCX750 Handsets .....	24
Registering DCX640 and DCX700 Handsets .....	24
Resetting Handsets .....	25
<b>Setting Up the Phonebook</b> .....	25
Creating Phonebook Entries .....	25
Programming Base Speed Dial Numbers (DCT7565 Only) .....	27
Deleting Base Speed Dial Numbers .....	27

Finding a Phonebook Entry .....	27	<b>Redialing a Number</b> .....	37
Editing an Existing Phonebook Entry.....	28	Deleting a Redial record .....	37
Storing Caller ID or Redial Numbers in the Phonebook.....	28	<b>Adjusting the Ringer, Handset Earpiece, and Base Speaker Volume</b> .....	37
Deleting Phonebook Entries .....	28	Adjusting the Ringer Volume .....	37
Deleting All the Phonebook Entries at Once .....	29	Adjusting the Handset/Base Volume .....	38
Copying Phonebook Entries to Another Handset .....	29	Adjusting the Audio Tone and Clarity Boost .....	38
<b>Customizing Your Phone</b> .....	30	<b>Finding a Lost Handset</b> .....	38
Changing the Handset Banner .....	30	<b>Using Hold, Conference, and Transfer</b> .....	39
Selecting Ring Tones (Handset Only) .....	31	Placing a Call on Hold .....	39
Activating AutoTalk (Handset only) .....	32	Conferencing .....	39
Activating Any Key Answer (Handset only) .....	32	Transferring a Call .....	40
<b>Using Your Phone</b> .....	33	Answering a Transferred Call .....	40
Making a Call from the Phonebook.....	34	<b>Using Special Features</b> .....	41
Making a Call with Speed Dial and with Base Speed Dial (DCT7565 Only).....	34	Do Not Disturb (All Calls) (DCT7565 Only).....	41
Switching to the Handset Speakerphone During a Call .....	34	Muting the Ringer (One Call Only).....	41
Using Caller ID, Call Waiting.....	34	Muting the Handset Microphone.....	41
Using the Caller ID List .....	35	Muting the Base Microphone (DCT7565 only).....	41
Making a Call from a Caller ID Record .....	35	Privacy Mode .....	41
Deleting Caller ID Numbers .....	35	<b>Seven-Digit Dialing</b> .....	42
Using Call Waiting and Call Waiting Deluxe .....	35	<b>Using the DirectLink Feature</b> .....	42
		Making a DirectLink Call .....	43
		Exiting DirectLink Operation .....	43
		<b>Making an Intercom Page</b> .....	43

Answering An Intercom Page .....	44
<b>Room/Baby Monitor</b> .....	44
<b>Tone Dialing Switch Over</b> .....	45
<b>Installing the Optional Headset</b> .....	45
<b>Maintenance</b> .....	46
Battery Replacement and Handling .....	46
Battery Contact Maintenance .....	46
Low Battery Alert.....	47
Talk Time, Standby Time, and Storing the Handset on the Base.....	47
<b>Troubleshooting</b> .....	47
Resetting the Handset .....	47
Resetting the Handset without the Base .....	48
Changing the Digital Security Code.....	49
Traveling Out of Range.....	49
<b>Common Issues</b> .....	49
<b>Liquid Damage</b> .....	51
<b>Rechargeable Nickel-Metal-Hydride</b>	
<b>Battery Warning</b> .....	52
The FCC Wants You To Know .....	54
<b>I.C. Notice</b> .....	55
<b>One Year Limited Warranty</b> .....	56
<b>Index</b> .....	57
<b>Specifications</b> .....	58

## Welcome

Thank you for purchasing a Uniden Multi-Handset phone.

Note: Illustrations in this manual are used for explanation purposes. Some illustrations in this manual may differ from the actual unit.

As an Energy Star® Partner, Uniden has determined that this product or product models meets the Energy Star® guidelines for energy efficiency. Energy Star® is a U.S. registered mark.

Uniden is a registered trademark of Uniden America Corporation. AutoStandby, DirectLink, Integri-Sound and Random Code are trademarks of Uniden America.



## Accessibility

Uniden provides a customer service hotline for accessibility questions. If you have a disability and need customer service assistance or if you have any questions about how Uniden's products can accommodate persons with disabilities, please call the accessibility voice/TTY line: 1-800-874-9314

A representative is available to talk to you M-F, 8:00 am to 5:00 pm, CST. After hours, you can leave us a message, and we will call you back. Information is also available on our website, [www.uniden.com](http://www.uniden.com), under the "Accessibility" link.

## Terminology used in this Manual

<b>Base</b>	The main part of the phone that connects to your phone line and lets you make and receive calls.
<b>CID</b>	Caller ID is available from your telephone provider. With this service, you can see the name and number of incoming callers.
<b>CID Deluxe or Call Waiting Deluxe</b>	Caller ID on Call Waiting Deluxe features are offered by your telephone provider. This service gives you different options when you have a waiting call. See <i>Using Call Waiting and Call Waiting Deluxe</i> on page 35.
<b>CID/CW or CIDCW</b>	Caller ID on Call Waiting is available from your telephone provider. With this service, you can see incoming caller information while on another call.

<b>Charger</b>	A cradle that comes with an accessory handset and charges the handset battery. It connects to power but does not connect to a phone line.
<b>DirectLink</b>	If you have accessory handsets on your system, you can use two handsets as 2-way radios.
<b>Extra or Accessory Handset</b>	This phone system is expandable and will support a total of four handsets to one base. The extra, or accessory handset, is a handset that is compatible with this model.
<b>Global Settings</b>	Apply to registered handsets and the base. If you change something under the global menu, you change it for all handsets and the base. Only one handset can change global settings at a time, and the phone must be in standby.
<b>Standby</b>	The handset is not in use. If it is off the cradle, no line has been activated. No dial tone is present.
<b>Station</b>	Any handset or the base.
<b>Talk</b>	A telephone line has been activated on the handset or the base, enabling a dial tone.

## Product Overview

### DCT7565/DCT756 Features:

- 2.4GHz Digital Expandable System
- Expands up to 4 Handsets
- Caller ID/Call Waiting Deluxe
- Base Keypad (DCT7565 model only)
- 100 shared Phonebook Entries/Caller ID Numbers
- DirectLink™
- Room/Baby Monitoring
- 20 Ringer Options (10 Tones/10 Melodies)
- Personalized Ring by Party
- 10 Speed Dial Locations
- Last 3 Number Redial
- Copy Phonebook Entries to Another Handset
- Trilingual Menu Displays (English, Spanish, and French)
- Call Transfer
- Conferencing
- Intercom
- Handset Speakerphone
- Base Speakerphone (DCT7565 Model only)

## DCT756 and DCT7565 - Parts of the Handset

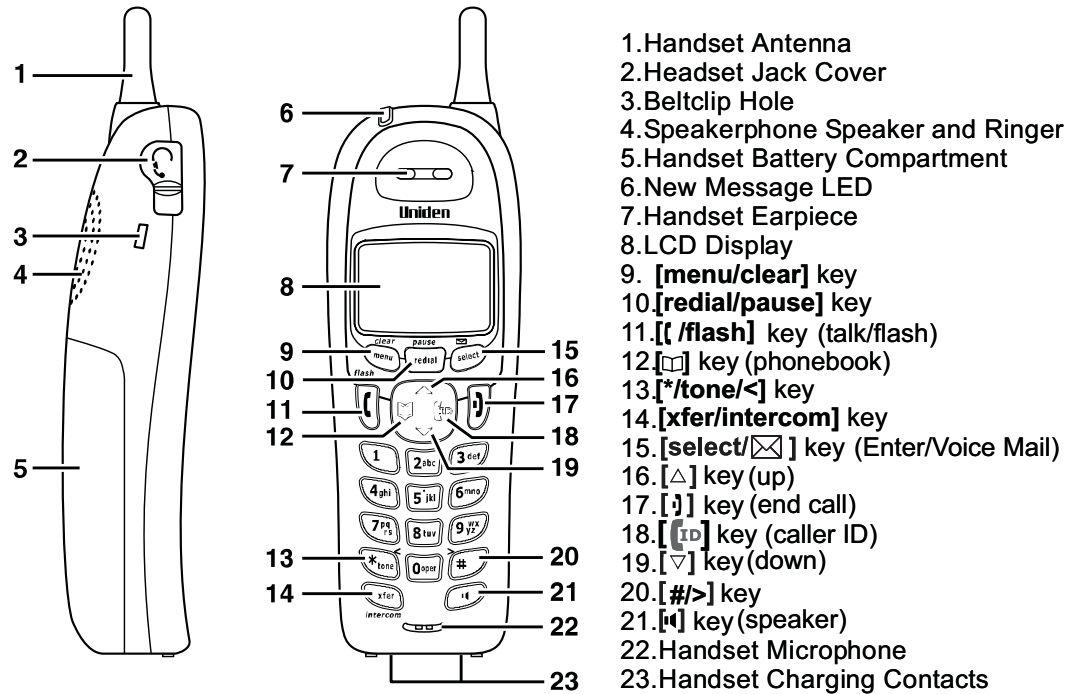

# DCT756 - Parts of the Base

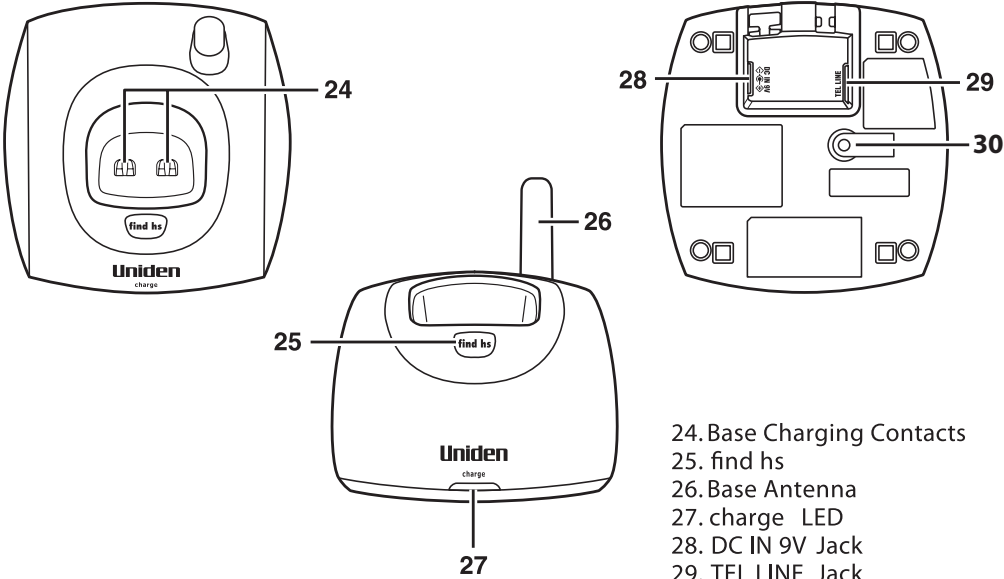

- 24. Base Charging Contacts
- 25. find hs
- 26. Base Antenna
- 27. charge LED
- 28. DC IN 9V Jack
- 29. TEL LINE Jack
- 30. Registration button**



## DCT7565 - Parts of the Base

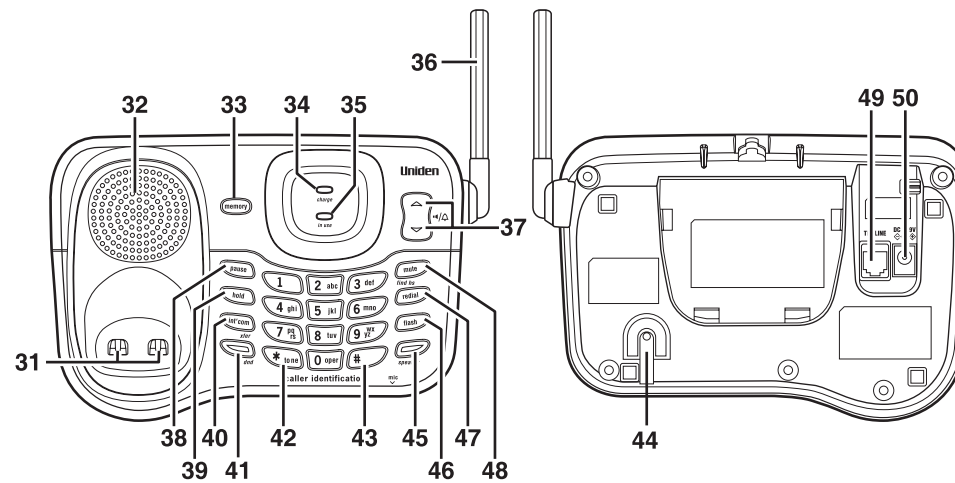







- 31. Base Charging Contacts
- 32. Base Speaker
- 33. **[memory]** key
- 34. charge LED
- 35. in use LED
- 36. Base Antenna
- 37. **[Δ/▽/▲/△]** (Volume Up/Down)
- 38. **[pause]** key

- 39. **[hold]** key
- 40. **[int'com/xfer]** key (intercom/transfer)
- 41. **[dnd]** key and LED (do not disturb)
- 42. **[\*/tone]** key
- 43. **[#]** key
- 44. Base Microphone

- 45. **[speaker]** key and speaker LED (speaker)
- 46. **[flash]** key
- 47. **[redial]** key
- 48. **[mute/find hs]** key (find handset)
- 49. DC IN 9V Jack
- 50. TEL LINE Jack

## Handset Icons

ICON	STATUS	DESCRIPTION
	Standby/Talk	The <b>Battery</b> icon indicates the handset battery status: empty, low, medium, and full
	Standby	The <b>Ringer Off</b> icon indicates that the ringer is turned off.
	Talk	The <b>Mute</b> icon appears when you mute the handset.
	Talk	The <b>Boost</b> icon appears when <b>Clarity Boost</b> is enabled.
	Talk	The <b>Speaker</b> icon appears when the handset speakerphone is in use.
	Talk	The <b>Privacy</b> icon appears when <b>Privacy Mode</b> is enabled.

## The Standby Screen

When the phone is in standby, the handset display shows the following items:

	— Ringer off icon (when the ringer is off) / Day of the week and time / battery icon
Handset #1	— Handset ID and Banner
New CID: 5	— Number of new Caller ID calls received

## Using the Interface

### Using the Four-way Function Key

Your handset has a four-way function key that allows you to move the cursor on the display and access the most commonly used features at the touch of a button. By moving this key to the left, you open the Phonebook. Move the key to the right to access Caller ID information. To use this four-way key, place your thumb over the key on the handset and move to the four positions to get the feel of how it moves and operates.

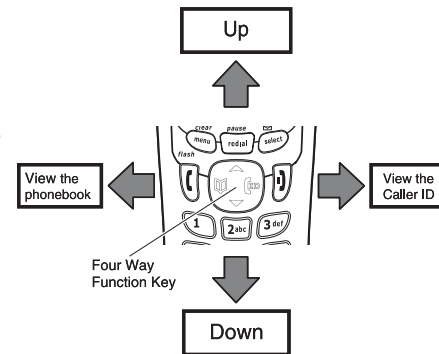

### Using the Handset Menus

To open the menu, press **[menu/clear]**. Select the option you want by pressing the four-way function key up or down. This moves the cursor; the option currently selected has a triangle beside it. Select the option by pressing **[select/☒]**. To exit the menu and return to standby, press **[1]** on the handset.

If you do not press a key within 30 seconds, the phone times out and exits the menu. When setting Day and Time, the time-out period is extended to two minutes.

## Entering Text from Your Handset

You can use the number keypad on your phone to enter text by referring to the letters printed on each number key. When you press the number key in a text entry field, the phone displays the first letter printed on the number key. Press the number key twice to display the second letter and three times to display the third. Capital letters are displayed first, then lower case letters, then the number on the key.

If two letters in a row use the same number key, enter the first letter, then use the **[#/ >]** key to move the cursor to the next position to enter the second letter.

For example, to enter Movies:

1. Press **6** once to enter M.
2. Use **[#/ >]** key to move the cursor to the right.
3. Press **6** six times to enter o.
4. Press **8** six times to enter v.
5. Press **4** six times to enter i.
6. Press **3** five times to enter e.
7. Press **7** eight times to enter s.
8. Press **[select/☒]** to end your text entry.

If you make a mistake while entering a name, use **[\*/tone/<]** or **[#/ >]** to move the cursor to the incorrect character. Press **[menu/clear]** to erase the wrong character, and then enter the correct character. To delete all characters, press and hold **[menu/clear]**.

	Number of times key is pressed								
keys	1	2	3	4	5	6	7	8	9
1	1								
2 abc	A	B	C	a	b	c	2		
3 def	D	E	F	d	e	f	3		
4 ghi	G	H	I	g	h	i	4		
5 jkl	J	K	L	j	k	l	5		
6 mno	M	N	O	m	n	o	6		
7 pqrs	P	Q	R	S	P	q	r	s	7
8 tuv	T	U	V	t	u	v	8		
9 wxyz	W	X	Y	Z	w	x	y	z	9
0 oper	&	<	>	<	>	/	(blank)	-	_
	.	,	=	?	!	@	'	"	*
	#	0							

## **Installing the Phone**

### **Choosing the Best Location**

When choosing a location for your new phone, here are some important guidelines you should consider:

- The location should be close to both a phone jack and a power outlet that is not connected to a wall switch.
- The base and handset should be kept away from sources of electrical noise such as motors, microwave ovens, and fluorescent lighting.
- For better reception, place the base as high as possible.
- The base should be placed in an open area for optimum range and reception.
- If your home has specially wired alarm equipment connected to a phone line, be sure that installing the system does not disable your alarm equipment. If you have questions about what will disable alarm equipment, contact your telephone company or a qualified installer.

## Wall Mounting the Base (DCT7565 Only)

This phone can be mounted on any standard wall plate.

1. Snap the wall mount adapter into the notches on the base top.
2. Plug the AC adapter into the **DC IN 9V** jack.
3. Route the AC adapter cord through the molded wiring channel as shown.
4. Plug the AC adapter into a standard 120V AC wall outlet.
5. Plug the telephone line cord into the **TEL LINE** jack.
6. Plug the telephone line cord into the telephone outlet.
7. Align the mounting slots on the base with the mounting posts on the wall. Then push in and down until the phone is firmly seated.

**DO NOT** use an AC outlet controlled by a wall switch.

Notes:

- The DCT756 base is not wall mountable.
- **Use only the supplied AD-800 AC adapter with DCT7565 Base.**  
**Do not use any other AC adapter.**

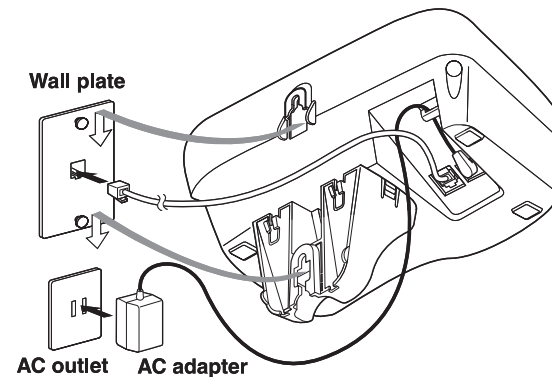
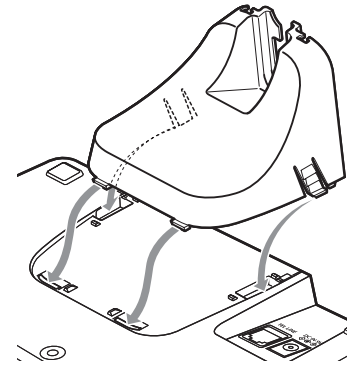

## Direct Wall Mounting (DCT7565 Only)

If you don't have a standard wall plate, you can mount your phone directly to the wall. Before doing this, consider the following:

- Avoid electrical cables, pipes, or other items behind the mounting location that could cause a hazard when inserting screws into the wall.
  - Try to mount your phone within 5-feet of a working phone jack to avoid excessive wire lengths.
  - Make sure the wall material is capable of supporting the weight of the base and handset.
  - Use #10 screws with a minimum length of 1-3/8 inches, with anchoring devices suitable for the wall material where the base unit will be placed.
1. Insert two mounting screws into the wall, using the appropriate anchoring device, 3-15/16 inches apart. Allow about 1/8 inch between the wall and screw heads for mounting the phone.
  2. Refer to the steps on page 14 to complete the mounting process.

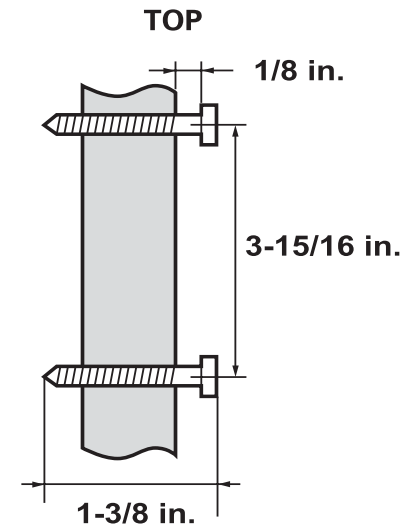

## Installing the Rechargeable Battery

Use only the Uniden BT-909 rechargeable battery pack supplied with your cordless telephone.

Follow the steps below to install a battery.

1. Press in on the handset battery case cover (use the finger indentation for a better grip) and slide the cover downward to remove.
2. Place the battery pack in the battery compartment with the connectors on the battery and on the compartment aligned.
3. Place the battery case cover back on the handset and slide it upwards until it clicks into place.

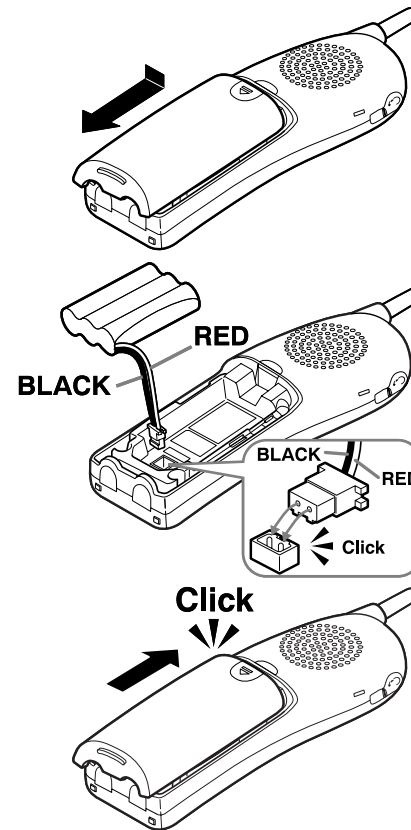



## Connecting the Base and Charging the Handset

1. Connect the AC adapter to the **DC IN 9V** jack.
2. Connect the AC adapter to a wall outlet that is not controlled by a switch.
3. Place the handset in the base with the LCD screen facing forward.
4. Make sure that the charge LED illuminates. If the LED does not illuminate, check to see that the AC adapter is plugged in and the handset makes good contact with the base charging contacts.
5. Charge your handset at least 15-20 hours before plugging into the phone line.

**Note: Use only the supplied AD-800 AC adapter with your phone.  
Do not use any other AC adapter.**

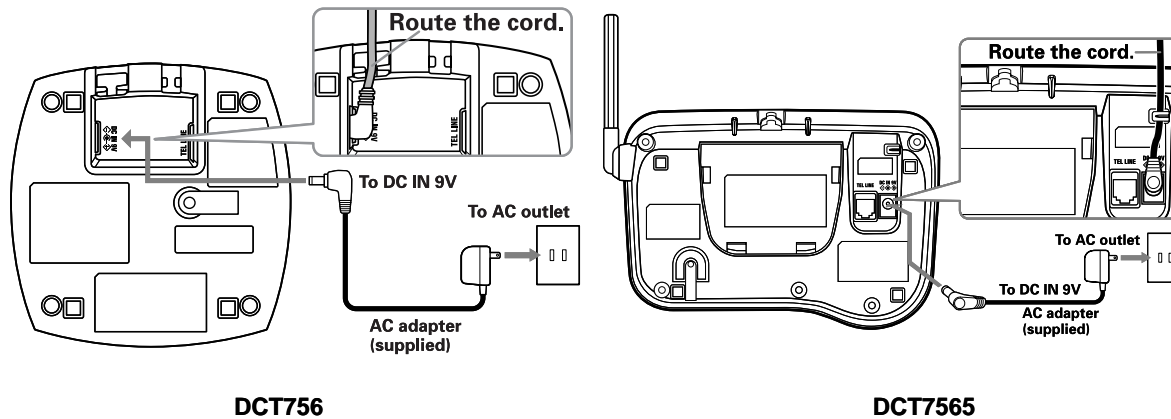

## Installing the Belt Clip

1. Line up the holes on each side of the handset. To attach the belt clip, insert into the holes on each side of the handset. Press down until it clicks.
2. To remove the belt clip, pull either side of the belt clip to release the tabs from the holes.

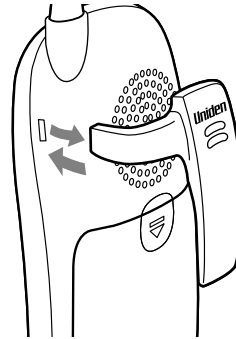

## Connecting to the Phone Line

Once the handset battery pack is fully charged, connect the telephone line cord to the **TEL LINE** jack and to a standard telephone wall outlet.

### Testing the Connection

To test your connection try making a call. If your call connects, the settings are fine. If your call does not connect check the following:

1. Check the AC adapter cord. Make sure it is securely connected to the DC IN 9V connector and to a standard AC power outlet.
2. Check to make sure the battery is fully charged. (If you don't see the "battery full" icon, check to make sure the battery is properly connected).
3. Change "dial mode" (instructions follow).

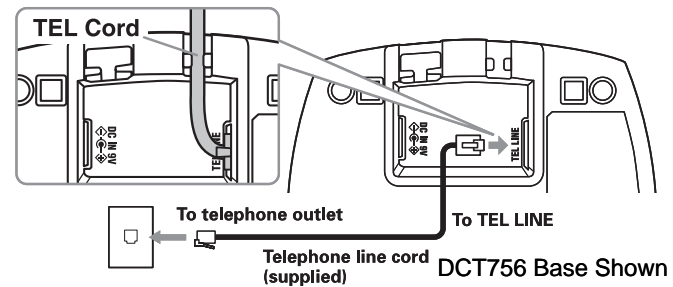

## Changing the Dial Mode

Your phone can communicate with the telephone network in two different ways: tone dialing or pulse dialing. These days, most phone networks use a method called tone dialing, so your phone comes programmed for tone dialing. If your phone company uses Pulse dialing, you will need to change your phone's dial mode. If you cannot connect to the telephone network, please follow the steps below to modify your phone's settings:

1. Press **[menu/clear]**. Select the GLOBAL SETUP menu, and then the DIAL MODE submenu.
2. Scroll [**∇**] to select PULSE. (The initial setting is TONE).
3. Press **[select/☒]**. You hear a confirmation tone.

```
Dial Mode
▶ Tone
Pulse
```

If you need to change the dial mode back to Tone, follow the same procedure, but select TONE in step 2.

## Basic Setup

### Selecting a Language

Your phone supports three languages: English, French and Spanish. Once you select a language, the menus on the handset will display in that language. The default language is English.

1. Press **[menu/clear]**. Select the HANDSET SETUP menu, and then the LANGUAGE submenu.
2. Move the cursor to choose ENGLISH, FRANÇAIS (French), or ESPAÑOL (Spanish).
3. Press **[select/☒]**. You hear a confirmation tone.

```
Language
▶ English
Français
```

### Setting the Day and Time

To change the day and time shown in the display, follow the steps below.

Note: If you don't press any keys for two minutes when setting the day and time, the phone exits the menu.

```
Day & Time
SUN 12:00 AM
[↑/↓/SELECT]
```

1. Press **[menu/clear]**. Select the GLOBAL SETUP menu, then the DAY & TIME submenu option.
2. Move the cursor to select the day of the week, then press **[select/☒]**.
3. Move the cursor to set the hour, then press **[select/☒]**.
4. Move the cursor to set the minute, then press **[select/☒]**.
5. Move the cursor to choose AM or PM, then press **[select/☒]**. You hear a confirmation tone.

### Activating Caller ID on Call Waiting and Call Waiting Deluxe

Your phone supports Caller ID on Call Waiting (CIDCW), so you see the name and number of someone who calls when you're already on the line. Your phone also supports Call Waiting Deluxe (CWDX), which gives you a choice of how you want to handle a waiting call. You need to subscribe to these features with your phone company before you can use them. To let your phone support these features, follow the steps below:

```

          CIDCW
    CW On /CWDX On
▶ CW On /CWDX Off
  
```

See page 35 for instructions on using Call Waiting Deluxe.

1. Press **[menu/clear]**. Select the GLOBAL SETUP menu, then the CIDCW submenu.
2. Move the cursor to select CW (Call Waiting) ON/CWDX (Call Waiting Deluxe) ON, CW ON/CWDX OFF, or CW OFF/CWDX OFF.
3. Press **[select/☒]**. You hear a confirmation tone.

### Activating Personal Ring

You can assign special ringer tones to anyone in your phonebook. When your phone gets a call, it looks up the Caller ID information in your phonebook. If you've assigned a personal ringer to that number, the phone uses it so you know who is calling. To turn on personal ring, follow these steps:

1. Press **[menu/clear]**. Select the HANDSET SETUP menu, and then the PERSONAL RING submenu.
2. Move the cursor to select ON or OFF.
3. Press **[select/☒]**. You will hear a confirmation tone.

## Activating the Key Touch Tone

Key Touch Tone is the tone your keypad makes when keys are pressed. You can turn this tone on or off.

1. Press **[menu/clear]**. Select the HANDSET SETUP menu, then the KEY TOUCH TONE submenu.
2. Move the cursor to select ON or OFF.
3. Press **[select/☒]**. You hear a confirmation tone.

## Setting up Voice Mail

If you subscribe to a voice mail service, you can use your phone to access your voice mailbox. The new message LED flashes whenever you have messages waiting in your voice mailbox. If you have programmed your access number into your phone, you can simply press **[select/☒]** to access your voice mail. When you subscribe to the service, your voice mail provider provides you with the access number and the required voice mail signaling tone.

## Setting the Voice Mail Signaling Tone

Your telephone service provider should provide you with the specifics of your voice mail service upon your enrollment. If you are having trouble with your message waiting indicator on your phone not illuminating when you have waiting messages, you will need to contact your service provider and inquire as to which type of message notification signal--either Frequency Shift Keying (FSK) or Stutter Dial Tone (SDT)--their service uses.

If your voice mail service uses an FSK message signal to alert you of a new voice mail message, you must turn off the Voice Mail Tone. If your voice mail service uses an SDT message signal to alert you of new voice mail messages, you can leave the Voice Mail Tone on.

Follow the instructions below to set up your cordless phone settings:

1. Press **[menu/clear]**. Select the GLOBAL SETUP menu, then the VOICE MAIL TONE submenu.
2. Move the cursor to set the voice message indication (SDT message signal) to ON or OFF.
3. Press **[select/☒]**. You hear a confirmation tone.

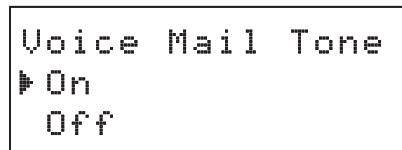

## Programming One-Touch Voice Mail Access

You can program your voice mail access number to the Voice Mail key [**select/☒**] on each handset so you can get your messages at the touch of a button. Your voice mail service provider will supply you with the access number. This number may be simply a phone number.

To edit the voice mail number, follow the steps below:

1. Press [**menu/clear**].
2. Move the cursor to HANDSET SETUP menu and press [**select/☒**].
3. Move the cursor to EDIT VOICE MAIL and press [**select/☒**].
4. Enter your personal access number (up to 20 digits).
5. If you need to have the phone wait before sending the next digits, press [**redial/pause**] to insert a two-second pause in the dialing sequence. For a longer pause, press [**redial/pause**] multiple times. A **P** appears in the display each time you press [**redial/pause**] and each pause counts as one digit.
6. Press [**select/☒**] when you are finished.

## Resetting the Voice Message Waiting Indicator

When you receive a new voice mail message, the LED on the top of the handset flashes. In the event your message alert tone gets out of sync with your phone company's voice messaging system, you can reset back to its original "no messages waiting" state. To reset, press and hold [**find hs**] on the DCT756 base or [**mute/find hs**] on the DCT7565 base for 5 seconds. A beep sounds and the message alert tone is reset.

## Adding Extra Handsets

Your phone supports up to four handsets, including any handsets supplied with your phone. Accessory handsets do not need to be connected to a phone jack. You can now place a fully-featured cordless handset anywhere AC power is available to connect the handset charger. The accessory handsets connect to the base to make and receive calls just like the handset that came with the main base. All the handsets ring when you receive a call.

### Compatible Handsets

Your phone is compatible with the following Uniden 2.4 GHz Digital Accessory Handsets: DCX640, DCX700, and DCX750. (Please visit our website at [www.uniden.com](http://www.uniden.com) for the most up-to-date list of compatible handsets.) If you purchase an accessory handset, you must register the handset to the main base before use. Accessory handsets will not operate until they are registered.

### Charging the Accessory Handset

The handset is powered by a rechargeable battery pack. The battery recharges automatically when the handset is placed in the charger.

1. Connect the AC adapter to the **DC IN 9V** jack and to a standard 120V AC wall outlet. Use only AC adapter Model Number AD-0005.
2. Set the charger on a desk or tabletop, then place the handset in the charger with the keypad facing forward.
3. Make sure that the **charge** LED illuminates. If the LED does not illuminate, check that the AC adapter is plugged in and the handset makes good contact with the base charging contacts.
4. Charge the handset battery pack for at least 15-20 hours before using your new cordless telephone for the first time.

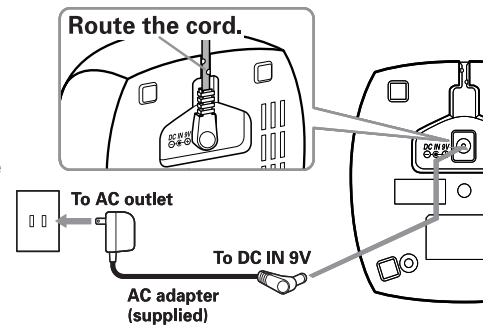

## Registering Accessory Handsets

If you purchase an accessory handset, you need to register the handset before use. Only one handset can be registered at a time. Handsets supplied with the phone are registered to the base by the factory. When charged, pre-registered handsets display a handset ID number. Handsets that have not been registered display MODELS VARY! CHARGE HANDSET ON THE BASE FOR REGISTRATION OR REFER TO OWNER'S MANUAL. (If an accessory handset has ever been registered to a base, you must reset the handset before you can register it to a new base. See Resetting Handsets on page 25.)

When you register an extra handset to the base, the handset ID will be assigned.

### Registering DCX750 Handsets

1. Before registering the **DCX750** accessory or extra handset, the battery pack **MUST** be charged for 15-20 hours.
2. Place the extra handset in the main base unit to begin registration.
3. While the handset is registering, **HANDSET REGISTERING** appears on the LCD display. When **REGISTRATION COMPLETE** appears, the handset has been registered to the base. If **REGISTRATION FAILED** appears, please try these steps again.

### Registering DCX640 and DCX700 Handsets

1. For the DCT756, press and hold the registration button on the bottom of the base. For the DCT7565 dual-keypad base, press and hold **[flash]** until the charge LED starts to flash.
2. On the handset, press and hold **[#]** until you hear a beep.
3. While the handset is registering, **HANDSET REGISTERING** appears on the LCD display. When **REGISTRATION COMPLETE** appears, the handset has been registered to the base. If **REGISTRATION FAILED** appears, please try these steps again.



## Resetting Handsets

If you want to register a handset to a different base or replace a handset with another one, you must first clear the registration information from the base and the handset.

1. Press and hold **[\*]** and **[#>]** on the handset for at least 5 seconds until the SYSTEM RESET menu appears. Select the DEREGISTER HS submenu. WHICH HANDSET? appears.
2. Move the cursor to select the handset ID to be de-registered from the list, and then press **[select/☒]**. DEREGISTER HS appears.
3. The phone asks you to confirm the deregistration. Move the cursor to select YES, then press **[select/☒]**. A confirmation tone sounds. The handset clears the registration information from the base and then deletes its own link to the base. The handset now displays MODELS VARY! CHARGE HANDSET ON THE BASE FOR REGISTRATION OR REFER TO OWNER'S MANUAL. To register the handset to a base see page 24.

```
Deregister HS
Yes
▶No
```

## Setting up the Phonebook

Your phone lets you store up to 100 names and numbers in your phonebook in the handset. Your phone shares memory between your phonebook and CID entries. Once you store 100 phonebook entries, CID information is not stored and only appears during a new incoming call. When phonebook and CID entries are full, a beep sounds and MEMORY FULL appears. You cannot store any additional names and numbers unless you delete some of the existing ones.

You can also use the phonebook to store a group of numbers (up to 20 digits) that you may need to enter once your call connects. This is referred to as *chain dialing*.

## Creating Phonebook Entries

To store names and numbers in your phonebook, follow these steps:

1. When the phone is in standby mode, press **[☐]**.
2. To create a new phonebook entry, move the cursor to select STORE NEW.
3. Press **[select/☒]**. STORE/EDIT NAME appears.
4. Enter the name for this entry (STORE/EDIT NAME). Use the

```
Phonebook : 50
Dial/Edit
▶Store new
```

```
Store/Edit Name
◀▶▲▼■
```

```
Store/Edit No.
8007303456■
```

keypad to enter a name for this entry; the name can contain up to 16 characters. (See page 12 for entering text instructions.) If you do not want to enter a name for this entry, your phone stores this entry as <No Name>. Press **[select/☒]** when you are finished.

5. Enter the number for this entry (STORE/EDIT NO.). Once you have stored a name, STORE/EDIT NO. appears. Use the number keypad to enter the phone number; the phone number can contain up to 20 digits. If you need the phone to pause between digits when it's dialing (for example, to enter an extension or an access code), press **[redial/pause]** to insert a two-second pause. A **P** appears on the display. You can also use more than one pause together if two seconds is not long enough. Each pause counts as one digit.
6. Assign a personal ring tone for this entry (PERSONAL RING). You can attach a personalized ring tone to each phonebook entry; the phone uses this ring tone when this person calls. See page 31 for a selection list.
7. Move the cursor to select one of the 20 different ring tone options. As you select each ring tone, a sample of that tone sounds. When you hear the ring tone you want to use, press **[select/☒]**.

If you do not want to use a personal ring tone for this phonebook entry, select the NO SELECTN option, and the phone uses your standard ring tone setting.

8. Your phone handset has 10 speed dial numbers, **[0]** to **[9]**. Move the cursor to select the speed dial number you want to assign to this phonebook entry, and press **[select/☒]**. Select NO SELECTN if you do not want to assign this entry to a speed dial number.

A tone sounds confirming that the new phonebook entry has been stored, and DONE! appears the display.

```
Personal Ring
▶No Selectn
Flicker
```

```
Speed Dial
▶No Selectn
SPD1:<Empty>
```

## Programming Base Speed Dial Numbers (DCT7565 Only)

The DCT7565 dual-keypad phone can store 10 speed dial numbers, [0] to [9]. Follow the steps below to store new speed dial numbers in the base. (Handset speed dial numbers are stored as part of a phonebook entry. See *Creating Phonebook Entries* on page 25 for information on programming handset speed dial numbers.)

1. With the phone in standby, press **[memory]**.
2. Use the number keypad to enter the phone number; the phone number can contain up to 20 digits. If you need the phone to pause between digits when it is dialing, such as the need to enter an extension or an access code, press **[pause]** to insert a two-second pause. You can also use more than one pause if two-seconds is not long enough. Each pause counts as one digit.
3. Press **[memory]** again, and then press the number key [0] to [9] where you want to store this phone number. A confirmation tone sounds.

## Deleting Base Speed Dial Numbers

1. With the phone in standby, press **[memory]** twice.
2. Press the number key, [0] to [9] that contains the phone number you want to delete. A confirmation tone sounds.

## Finding a Phonebook Entry

Press [☐] to open the phonebook. Then, select DIAL/EDIT. Phonebook entries are stored in alphabetical order. To scroll through the phonebook from A to Z, press [▽]. To scroll through the phonebook from Z to A press [△].

You can also use the letters on the number keys to jump to a name that starts with that letter. Press a number key ([2] to [9] and [0]) once for the first letter, twice for the second letter, and so on. The phonebook jumps to the first entry that begins with the letter you entered; you can then use [▽] or [△] to scroll to other entries. For example, to search for an entry beginning with the letter M, press [6] once. To close the phonebook, press [⏏]. If you are looking up a phonebook entry during a call, press [☐] again instead of [⏏] to close the phonebook.

## Editing an Existing Phonebook Entry

1. With the phone in standby, press [☰] to open the phonebook.
2. Select DIAL/EDIT.
3. Use [▽] or [△] to scroll through the phonebook entries. When you come to the entry you want to edit, press [select/☒].
4. Follow the steps for *Creating a Phonebook Entry* on page 25. If you do not wish to change the information at any step, simply press [select/☒] to go to the next step.

## Storing Caller ID or Redial Numbers in the Phonebook

You can store Caller ID records or redial numbers in the phonebook so you can use them later.

Note: If the Caller ID information did not include the number, then you will not be able to store it.

1. When the phone is in standby, press [CID] to open the Caller ID list or [redial/pause] to open the redial list.
2. Use [▽] or [△] to scroll through the Caller ID records or redial numbers. When you come to the information you want to store, press [select/☒]. STORE/EDIT NAME appears.
3. If the phone number is already stored in memory, a beep sounds, and THIS DATA IS ALREADY STORED! appears in the display. The number will not be stored.

Follow the steps for *Creating Phonebook Entries* on page 25.

## Deleting Phonebook Entries

To erase individual phonebook entries or erase all the phonebook entries at once follow the steps below.

1. When the phone is in standby, press [☰].
2. To delete a single phonebook entry, move the cursor to select DIAL/EDIT, then press [select/☒].
3. Use [▽] or [△] to select the desired phonebook entry, then press [menu/clear].
4. DELETE MEMORY? appears in the display. Select YES, then press [select/☒]. A confirmation tone sounds, and DELETED! appears in the display.

### Deleting All the Phonebook Entries at Once

1. When the phone is in standby, press [📖].
2. Move the cursor to select DELETE ALL, and press [select/☒]. DELETE ALL? appears in the display.
3. Select YES, then press [select/☒]. A confirmation tone sounds, and DELETED! appears in the display.

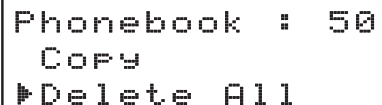

```
Phonebook : 50
COPY
Delete All
```

### Copying Phonebook Entries to Another Handset

If you have more than one handset, you can transfer stored phonebook entries from one handset to another without having to re-enter names and numbers. You can transfer one phonebook entry at a time or all phonebook entries at once.

1. When the phone is in standby, press [📖].
2. Move the cursor to select COPY, and then press [select/☒]. Move the cursor to select the handset to which you want to transfer the phonebook entries, then press [select/☒].
3. Move the cursor to select ONE MEMORY or ALL MEMORY, then press [select/☒].
4. If you select ALL MEMORY, ARE YOU SURE? appears. Move the cursor to select YES, then press [select/☒]. If you select ONE MEMORY, select the phonebook entry you want to transfer and then press [select/☒].
5. The phonebook entries will be transferred to the designated station. During the copy process, the receiving handset shows RECEIVING and the Banner name of the sending handset.
6. When the transfer is completed, DONE! appears on the handset.



```
COPY Phonebook
One Memory
All Memory :xxx
```

#### Notes:

- If your phonebook contains 100 entries, you cannot store any new phonebook entries. A beep sounds, and MEMORY FULL appears on the display.
- If the selected handset is out of range or data transfer is canceled, UNAVAILABLE appears in the display. Phonebook listings are not transferred.

## Customizing Your Phone

### Changing the Handset Banner

Each handset displays the banner name once it is registered to the base. The default banner is HANDSET #1, HANDSET #2, etc. You can change the name your phone displays by changing the banner display. If you have more than one handset, you can use the banner name to identify your handset during handset-to-handset functions like intercom and DirectLink. The banner lets you customize the name your handset displays. The name is displayed on the LCD screen during Standby, Intercom, Intercom Hold, Room/Baby Monitor, and Copy Phonebook operations. The banner name is displayed on the receiving handset as well.

1. Press **[menu/clear]**.
2. Select the HANDSET SETUP menu, then the BANNER submenu.
3. Use the keypad to enter or edit the banner name. (See page 12 for detailed instructions on entering text.) Press **[select/☒]**. A confirmation tone sounds.



### Selecting Ring Tones (Handset Only)

You may choose from 10 melodies or 10 tones for your phone's primary ring tone. Each station can use a different ring tone or melody. The available ring tones are listed below:

Melodies	Ringers
Beethoven's Symphony #9 [Beethoven9]	Flicker
For Elise [Elise]	Clatter
We Wish You A Merry Christmas [Merry- Xmas]	Soft Alert
Home Sweet Home [Hm Swt Hm]	Wake Up
Lorri Song #6 [Lorri Song]	Light Bug
When Irish Eyes Are Smiling [Irish Eyes]	Beep Boop
Aura Lee [Aura Lee]	Tone Board
Let Me Call You Sweet Heart [Sweetheart]	Chip Chop
Star Spangled Banner [Star Spngl]	Party Clap
Old MacDonald [Old MacDld]	Reminder

1. Press **[menu/clear]**.
2. Select the HANDSET SETUP menu, and then the RINGER TONES submenu.
3. Move the cursor to a ring tone. As each ring tone is selected, you will hear a sample of the ring tone.
4. When you hear the tone you want to use, press **[select/☒]**. You will hear a confirmation tone.

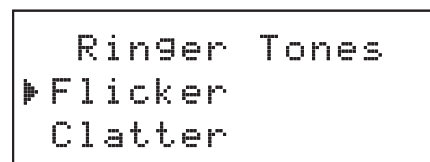

### Activating AutoTalk (Handset only)

AutoTalk allows you to answer the phone simply by removing the handset from the cradle. You do not have to press any buttons to answer the call.

1. Press **[menu/clear]**.
2. Select the HANDSET SETUP menu, then the AUTO TALK submenu.
3. Select ON or OFF, and press **[select/☒]**. You hear a confirmation tone.

```
AutoTalk
On
▶ Off
```

### Activating Any Key Answer (Handset only)

Any Key Answer allows you to answer the phone by pressing any key in the twelve-key pad.

1. Press **[menu/clear]**.
2. Select the HANDSET SETUP menu, and then the ANY KEY ANSWER submenu.
3. Select ON or OFF, then press **[select/☒]**. You hear a confirmation tone.

```
Any Key Answer
On
▶ Off
```



## Using Your Phone

	From a cordless handset	From a handset speaker phone	From the base speaker phone - DCT7565 only
<b>Making a Call</b>	<ol style="list-style-type: none"> <li>1. Remove the handset from the charging cradle.</li> <li>2. Press [ <b>flash</b> ].</li> <li>3. Listen for the dial tone</li> <li>4. Dial the number.</li> </ol> <p style="text-align: center;">OR</p> <ol style="list-style-type: none"> <li>1. Remove the handset from the charging cradle.</li> <li>2. Dial the number.</li> <li>3. Press [ <b>flash</b> ].</li> </ol>	<ol style="list-style-type: none"> <li>1. Remove the handset from the charging cradle.</li> <li>2. Press [ <b>speaker</b> ].</li> <li>3. Listen for the dial tone.</li> <li>4. Dial the number</li> </ol> <p style="text-align: center;">OR</p> <ol style="list-style-type: none"> <li>1. Remove the handset from the charging cradle.</li> <li>2. Dial the number.</li> <li>3. Press [ <b>speaker</b> ].</li> </ol>	<ol style="list-style-type: none"> <li>1. Press [ <b>speaker</b> ]</li> <li>2. Listen for the dial tone.</li> <li>3. Dial the number.</li> </ol>
<b>Answering a Call</b>	<ol style="list-style-type: none"> <li>1. Pick up the handset. If AutoTalk is on, the phone answers when you remove the handset from the charging cradle.</li> <li>2. Press [ <b>flash</b> ]. If Any Key Answer is on, you can also press any number keypad.</li> </ol>	<ol style="list-style-type: none"> <li>1. Pick up the handset. If AutoTalk is on, the phone answers when you remove the handset from the charging cradle.</li> <li>2. Press [ <b>speaker</b> ].</li> </ol>	Press [ <b>speaker</b> ]
<b>Hanging Up</b>	Press [ <b>end call</b> ] or return the handset to the cradle	Press [ <b>end call</b> ] or return the handset to the cradle	Press [ <b>speaker</b> ]

### **Making a Call from the Phonebook**

1. When the phone is in standby, press [☐] to open the phonebook.
2. Move the cursor to select DIAL/EDIT, and then press [select/☒].
3. Find the phonebook entry you want to call (see *Finding a Phonebook Entry* on page 27).
4. Press [\*/flash] or [📞] on the handset to dial the number.

Note: You can also press [\*/flash] before you open the phonebook.

### **Making a Call with Speed Dial**

1. When the phone is in standby, press and hold the number key ([0] - [9]) until the assigned phonebook entry appears in the display.
2. Press [\*/flash] or [📞] on the handset to dial the number.

### **Making a Call with Base Speed Dial (DCT7565 Only)**

1. When the phone is in standby, press [speaker].
2. Press [memory].
3. Press the number key ([0] through [9]) where the desired speed dial number is stored. The phone dials the programmed number.

### **Switching to the Handset Speakerphone During a Call**

To switch a normal call to the speakerphone, press [📞] on the handset. To switch from a speaker phone call to a normal call, press [📞].

### **Using Caller ID, Call Waiting**

If you subscribe to Caller ID from your phone company, your phone shows you the caller's phone number and name (if available) whenever a call comes in. If you subscribe to both Call Waiting and Caller ID, the phone also shows you the name and the number of any call that comes in while you're on the line.

## Using the Caller ID List

You can store up to 100 Caller ID numbers in each handset. Your phone shares memory between your Phonebook and Caller ID entries. Once you reach your maximum phonebook entries of 100, Caller ID information will not be stored (but it will still display when the call comes in).

To open the Caller ID list, press **[CID]** (on the right side of the four-way key). The phone shows the total number of stored Caller ID records. Use **[▽]** or **[△]** to scroll through the list, or enter a letter on the keypad to jump to the first caller ID name that starts with that letter.

## Making a Call from a Caller ID Record

1. When the phone is in standby, press **[CID]** to open the Caller ID list.
2. Use **[▽]** or **[△]** to find the Caller ID record you want to dial.
3. To add (or delete) a "1" at the beginning of the displayed phone number, press **[\*/tone/<]**. To add (or remove) the stored area code to the displayed phone number, press **[#/>]**.
4. Press **[/flash]** or **[11]** to dial the number.

Note: You can also press **[/flash]** before you open the Caller ID list.

## Deleting Caller ID Numbers

To delete only one Caller ID number, go to the Caller ID list and select the number you want to delete. Press **[menu/clear]**. When the phone asks you to confirm, select YES.

To delete all the Caller ID numbers, press **[CID]** (on the right side of the four-way key) and then **[menu/clear]**. Select YES when asked if you want to DELETE ALL.

**Warning:** When you delete a Caller ID number, you delete it permanently.

## Using Call Waiting and Call Waiting Deluxe

You must subscribe through your telephone service provider to receive Call Waiting and Call Waiting deluxe services.

If you have Call Waiting service and a second call comes in when you are on the phone, a call waiting tone sounds. Press **[/flash]** on the handset or **[flash]** on

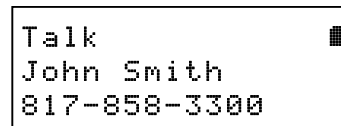

the dual-keypad base, to accept the waiting call. There is a short pause, then you hear the new caller. To return to the original caller, press **[flash]** or **[flash]** again.

If you have Call Waiting Deluxe Service, your phone gives you new options. At the touch of a button, you can place the caller on hold, send them to your voice mail service, or conference them into your current call. You must subscribe to both Call Waiting and Call Waiting Deluxe services to use these features. Not all features are available in all areas. Check with your telephone provider for details.

1. When you receive a Call Waiting call, press **[menu/clear]**.
2. Move the cursor to select CW Deluxe, and then press **[select/☒]**
3. Move the cursor or use the number keypad **[1]** to **[7]** to select an option.

```
1▶ Ask to Hold
2 Tell Busy
3 Forward Call
```

**Ask to Hold** — A prerecorded message states that user will be available shortly, and the call is placed on hold.

**Tell Busy** — A prerecorded message tells the caller you are busy, and the waiting call is disconnected.

**Forward Call** — The caller is sent to your voice mail box, if available.

**Answer/Drop 1** — Disconnects the first call, and connects to the new caller.

**Conference** — Starts a conference call with your first and second callers.

**Drop First/Drop Last** — During a conference call, allows you to choose to drop the first or last caller.

4. Press **[select/☒]**. You hear a confirmation tone, and the phone returns to the call.

## Redialing a Number

You can quickly redial the last 3 numbers dialed on each handset.

From the base DCT7565 only	From the handset
<ol style="list-style-type: none"> <li>1. Press [<b>speaker</b>]</li> <li>2. Then press [<b>redial</b>]</li> </ol>	<ol style="list-style-type: none"> <li>1. With the phone in standy, press [<b>redial/pause</b>] to open the redial list.</li> <li>2. Use [▽] or [△] to scroll through the redial list.</li> <li>3. When you find the number you want to dial, press [(/flash) or [⏏] to dial the number.</li> </ol> <p>OR</p> <ol style="list-style-type: none"> <li>1. Press [(/flash) or [⏏].</li> <li>2. Press [<b>redial/pause</b>]. The last number dialed will be displayed.</li> </ol>

## Deleting a Redial Record

If you want to delete a phone number from the redial list, follow the steps below:

1. With the phone in standby, press [**redial/pause**].
2. Use [▽] or [△] to scroll through the redial list.
3. When you find the redial number you want to delete, press [**menu/clear**].
4. Select YES, and press [**select/☒**] or [**menu/clear**]. The redialed number is deleted.

## Adjusting the Ringer, Handset Earpiece, and Base Speaker Volume

### Adjusting the Ringer Volume

You can choose from three ringer volume settings on the handset (off, low, and high) and four options (off, low, medium, and high) on the DCT7565 base. With the phone in standby, use [▽] or [△] on the handset or [△ 🔊/△] or [▽ 🔊/△] on the DCT7565 base to adjust the ringer volume.

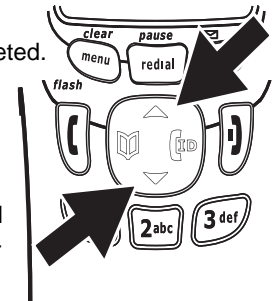

## Adjusting the Handset/Base Volume

**Earpiece:** You can choose from six volume levels for the earpiece. To adjust the earpiece volume while on a call, press [▲] to make it louder or [▼] to make it softer.

**Handset Speaker:** You can choose from six volume levels for the handset speaker. To adjust the speaker volume while on a call, press [▲] to make it louder or [▼] to make it softer.

**Base Speaker:** You can choose from ten volume levels for the base speakerphone. To adjust the speaker volume while on a call, press [▲] to make it louder or [▼] to make it softer. This applies to dual-keypad models only.

## Adjusting the Audio Tone and Clarity Boost

If you aren't satisfied with the audio quality of your phone, you can adjust the Audio Tone of the earpiece while on a call. Your phone gives you three audio tone options: low, natural, and high; the default setting, Natural Tone, is recommended for hearing aid users. Audio tone adjustments only apply to the earpiece, not the speakerphone. To adjust the audio tone:

1. With the phone in talk mode, press [select/☒] to cycle through the three audio tone options.
2. When the desired option appears on the display, stop.
3. After two seconds, the displayed audio tone is set, and the display returns to normal.

If you encounter interference while using your phone, you can manually improve the sound by setting the Clarity Boost to on. **This works only when the phone is in use**, so while you are on a call:

1. Press [menu/clear].
2. Move the cursor to CLARITY BOOST, and then press [select/☒]. BOOST ON and B appear on the display.  
Use the same procedure to turn off Clarity Boost. BOOST OFF appears.

## Finding a Lost Handset

With the phone in standby, press [find hs] on the base or [mute/find hs] on the dual-keypad base. All registered handsets will beep for 60 seconds, and PAGING appears on the handset display. To cancel paging, press any key on the found handset or press [find hs] (or [mute/find hs] for the dual-keypad model) on the base.

## Using Hold, Conference, and Transfer

### Placing a Call on Hold

1. During a call, press **[xfer/intercom]** on the handset (or **[hold]** on the DCT7565 base) to place the caller on hold. If you leave a caller on hold for more than ten seconds, the display screen will read LINE ON HOLD.
2. To return to the party on hold, press **[ /flash ]** or **[ ]** on a handset or **[speaker]** on the DCT7565 base. The phone returns to the holding party.

Notes:

- You can only place a caller on hold for 5 minutes. Once 5 minutes has passed, that party's line is disconnected and the phone returns to standby.
- While a call is on hold, Caller ID and Call Waiting can not be used.

### Conferencing

If you have more than one handset, up to three people can participate in a conference call on the DCT756 and up to four people on the DCT7565. A three-way conference call consists of an outside line and two handsets. A four-way conference call consists of one outside line, two handsets, and the base speakerphone. You can easily join a call already in progress.

1. Press **[ /flash ]** or **[ ]** on the handset or **[speaker]** on the DCT7565 base to join the call.
2. To hang up, return the handset to the cradle or press **[ ]** on the handset. From the base, press **[speaker]**. The other station will still be connected to the call.

## Transferring a Call

You can transfer a call from one station to another.

From the base - DCT7565 only	From the handset
<ol style="list-style-type: none"> <li>1. During a call, press <b>[int'com/xfer]</b>.</li> <li>2. The call is automatically placed on hold. Select the handset you want to talk with by pressing <b>[1]</b> to <b>[4]</b>. To page all the registered handsets, press <b>[*/tone/&lt;]</b>. A paging tone sounds. To cancel the transfer, press <b>[int'com/xfer]</b> or <b>[speaker]</b>.</li> <li>3. When another station accepts the transferred call, you will be disconnected. If you want to rejoin the call, press <b>[speaker]</b> again.</li> </ol>	<ol style="list-style-type: none"> <li>1. During a call, press <b>[xfer/intercom]</b>.</li> <li>2. Use <b>[▽]</b> or <b>[△]</b> to select the station you want to transfer the call to, then press <b>[select/☒]</b>. The call will be automatically be placed on hold, and a paging tone sounds. To cancel the transfer, press <b>[/flash]</b> or <b>[🔊]</b>.</li> <li>3. When another station accepts the transferred call, you will be disconnected. if you want to rejoin the call, press <b>[/flash]</b> or <b>[🔊]</b> again.</li> </ol>

## Answering a Transferred Call

When a station receives a call transfer, it sounds a paging tone and shows the ID of the station that is paging.

To accept the call transfer:

1. Press **[/flash]** or **[xfer/intercom]** from the handset or **[int'com/xfer]** or **[speaker]** on the DCT7565 base.
2. To speak to the caller, press **[/flash]** on the receiving handset or **[speaker]** on the DCT7565 base.
3. Only the first station to answer the transfer page will be connected to the call. If the transfer page is not picked up within one minute, the operation will be canceled.



## Using Special Features

### Do Not Disturb (All Calls) (DCT7565 Only)

DND allows you to mute the ringer of all handsets and the base. With the phone in standby, press and hold **[dnd]** on the base. A confirmation tone sounds and the **[dnd]** LED illuminates. To cancel, press **[dnd]** again. You can also mute the ringer tone while the phone is ringing by pressing **[dnd]** on the DCT7565 base.

### Muting the Ringer (One Call Only)

While a handset is ringing, press **[j]** on the handset to mute the ringer for this call. The phone rings again on the next call.

Note:

The handset must be off the cradle to mute the ringer.

### Muting the Handset Microphone

Mute turns off the microphone so the caller can't hear you. The display shows  while the microphone is muted.

1. While you are on a call, press **[menu/clear]**.
2. Move the cursor to MUTE and then press **[select/☒]**.  appears in the display and remains while MUTE ON disappears in several seconds. To cancel muting, repeat the procedure.

### Muting the Base Microphone (DCT7565 only)

1. During a call, press **[mute/find hs]** to turn off the microphone.
2. To cancel muting, press **[mute/find hs]** again or press **[speaker]**.

### Privacy Mode

If you don't want other station to interrupt you while on a call, you can turn on privacy mode. As long as your station is in privacy mode, other stations won't be able to join your call or make any calls of their own.

1. While on a call, press **[menu/clear]**.
2. Move the cursor to PRIVACY MODE, and press **[select/☒]**. PRIVACY MODE ON appears in the display for 2 seconds, but **P** appears and remains in the display until the feature is turned off. Other handsets will not be able to make a call and their display will list UNAVAILABLE when they try to join the call.

To turn privacy off, repeat the procedures listed above.

## Seven-Digit Dialing

If you can make a local call by dialing only 7 digits instead of 10, you can program your local area code in your phone. If you get a call from within your area code, you will only see the 7-digit phone number. If you get a call from outside your area code, you will see all 10 digits. To enter an area code, follow the steps below:

1. Press **[menu/clear]**. Select the GLOBAL SETUP menu, and then the AREA CODE submenu.
2. Use the number keypad **[0]** to **[9]** to enter a 3-digit area code. If an area code has already been stored, it will appear in the display. Press **[menu/clear]** to delete the stored code, and then enter a new one.
3. Press **[select/☒]**. A confirmation tone sounds.

NOTE: Do not program an area code if you must dial all 10 digits to make a local call.

## Using the DirectLink Feature

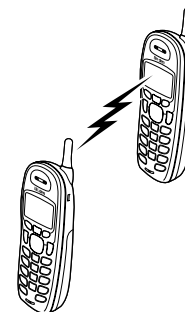

Using the DirectLink feature, a pair of handsets can function as two-way radios. You can have up to two pairs of handsets using DirectLink at a time. DirectLink communication does not interfere with the main base's ability to make or receive telephone calls. You must set both handsets to use DirectLink communication to activate this feature. Other handsets can be used while two handsets are in DirectLink communication; however, the two handsets in DirectLink operation are not able to make or receive calls until DirectLink communication is canceled.

1. Press **[menu/clear]** and move the cursor to the DIRECTLINK MODE menu.
2. Press **[select/☒]**. The display shows TO ENTER DIRECTLINK MODE PRESS SELECT.
3. Press **[select/☒]**. A confirmation tone sounds, and DIRECTLINK MODE COMPLETE appears in the display.



```
To enter  
DirectLink mode  
Press [SELECT]
```

## Making a DirectLink Call



1. To call another handset with DirectLink communication, press **[/flash]**. The display shows TO DIRECTLINK A HANDSET PRESS [1-4].
2. Press the number of the handset you want to call. If the handset is out of range or not using DirectLink communication, the display shows UNAVAILABLE. To answer a DirectLink call, press **[/flash]** or if Any Key Answer is on, press any key of the twelve-key pad.
3. To exit the DirectLink call, press **[\*]**.

## Exiting DirectLink Operation

To exit DirectLink communication and return to normal standby, press **[menu/clear]** and then press **[select/**] or return the handset to the cradle. DIRECT LINK MODE CANCEL appears in the display.

## Making an Intercom Page

You can use the intercom to talk to another station without using the phone line.

From the base - DCT7565 only	From the handset
<ol style="list-style-type: none"> <li>1. With the phone in standby, press <b>[int'com/xfer]</b>.</li> <li>2. Select the handset you want to talk with by pressing <b>[1]</b> to <b>[4]</b>. To page all registered handsets, press <b>[*/tone/&lt;]</b>. A paging tone sounds.</li> <li>3. To cancel the intercom page, press <b>[int'com/xfer]</b>.</li> </ol>	<ol style="list-style-type: none"> <li>1. With the phone in standy, press <b>[xfer/intercom]</b>.</li> <li>2. Use <b>[</b>] or <b>[</b>] to select the station you want to talk with, then press <b>[select/</b>]. If you select ALL, all other stations will be paged.</li> <li>3. To cancel the intercom page, press <b>[*]</b>.</li> </ol>

Notes: Intercom paging will be cancelled if any of the following things occur:

- You receive an outside call or an intercom page while selecting the other handset.
- You do not select a handset within 30 seconds.
- The party does not answer the page within one minute.
- The party is busy.
- The party is out of range (UNAVAILABLE appears on the display).

## Answering an Intercom Page

When the intercom page tone sounds, the display shows the ID of the station that is paging.

From the handset, press **[\*/flash]** or **[xfer/intercom]**. If AutoTalk is on, the handset automatically answers the page when you remove the handset from the cradle.

From the DCT7565 base, press **[int'com/xfer]**, or **[speaker]**.

To hang up an intercom page from the handset, press **[\*]**. To hang up an intercom page from the DCT7565 base, press **[int'com/xfer]**.

To intercom	
▶ Handset	#2
Handset	#3

## Room/Baby Monitor

This feature allows you to monitor sounds in another room. Place a handset (or the DCT7565 base) in the room you wish to monitor; it will function as a microphone. Another station can be set to function as a remote speaker, allowing you to monitor sounds in the room.

1. Press **[menu/clear]** and enter the ROOM MONITOR menu. TO ROOM MONITOR appears.
2. Select the station you want to monitor by using **[▽]** or **[△]**.
3. Press **[select/✉]**. ROOM MONITOR appears, and you hear sounds in the room where the station is installed.
4. To turn off the Room Monitor, press **[\*]** or return the handset to the cradle.

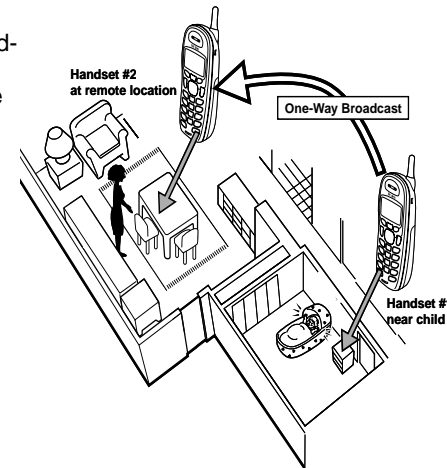

Notes:

- This feature only works when both handsets are within the range of the base.
- If the party is out of range, UNAVAILABLE appears in the display, and the operation is canceled.
- While a pair of handsets is in Room/Baby Monitoring, they cannot be used to make or receive calls. Other handsets can still make and receive calls.

## Tone Dialing Switch Over

If your telephone company requires pulse dialing, you can switch to tone dialing after the call connects. This feature is useful when you need tone dialing to use automated menu systems, such as telephone bank tellers, telephone prescription refills, customer support menus, etc. If your phone is set to pulse dialing, make your call normally. Once your call connects, press **[\*/tone/<]** on the handset (or **[\*/tone]** on the DCT7565 base). Any digits you enter from then on will be sent as tone dialing. When this particular call ends, the phone automatically returns to pulse dialing.

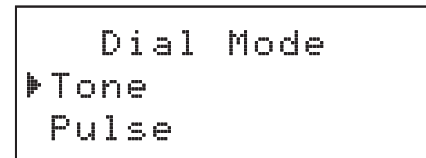

## Installing the Optional Headset

Your phone may be used with an optional headset. To use this feature, insert the headset plug into the headset jack. Your phone is ready for hands-free conversations. (Headsets may be purchased by calling the Uniden Parts Department. See the back cover page for contact information.)

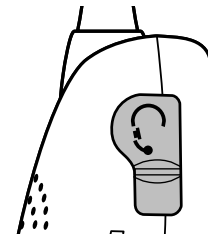

## Maintenance

### Battery Replacement and Handling

With average use, your phone's battery should last approximately one year. To order replacement batteries, please contact Uniden's Parts Department. The contact information is on the back cover page.

### Battery Contact Maintenance

To maintain a good charge, clean the charging contacts on the handset once each month. Dampen a cloth with plain water. Gently rub the damp cloth over the charging contacts until all visible dirt is removed. Dry the contacts thoroughly before returning the handset to the charging cradle.

**Caution:** Do not use paint thinner, benzene, alcohol, or any other chemical products. Doing so may discolor the surface of the telephone and damage the finish.

### Warning

To avoid the risk of personal injury or property damage from fire or electrical shock, use only Uniden AD-800 (DCT7565) and AD-0005 (DCT756, DCX750) AC adapters and Uniden BT-909 battery pack with your phone.

**Caution:**

- Do not remove the batteries from the handset to charge them.
- Never throw the battery into a fire, disassemble, or heat them.
- Do not remove or damage the battery casing.
- A replacement Uniden adapter or battery may be purchased by calling Uniden's Parts department (see the back cover page).



## Low Battery Alert

When the battery pack is very low, the phone is programmed to eliminate functions in order to save power.

The battery pack needs to be charged when the empty battery icon appears.

When LOW BATTERY appears in the display and the phone is in standby, none of the keys will operate. If you are on a call, complete your conversation as quickly as possible, and return the handset to the charging cradle.

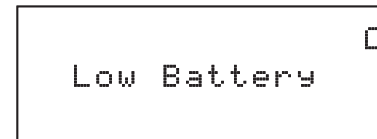

## Talk Time, Standby Time, and Storing the Handset on the Base

With average use, your battery provides approximately 5 hours of talk time and approximately 7 days of standby time. However, even when the battery pack is not being used, it gradually discharges over a long period of time. Therefore, you can achieve optimum performance if you return the handset to the cradle after each call. If the handset is left off of the base, the actual talk time duration will be reduced respective to the amount of time the handset is off the cradle.

## Troubleshooting

### Resetting the Handset

You may need to reset your handset in the following instances:

- You lose a handset and purchase a new one.
- When you try and register to your existing base, you see REGISTRATION FAILED on the menu display.
- You are unable to register any handsets to the base.
- You had a base which needed to be exchanged by the manufacturer.
- When you register your existing handsets to the base, and the handset IDs do not match. (For example, the handset registers as Handset #4, but you only have two handsets.)
- When you are instructed to by the one of the manufacturer's call center representatives.

To reset the handset, do the following:

1. Press and hold **[\*]** and **[#>]** for at least 5 seconds until the SYSTEM RESET menu appears. Select DEREGISTER HS submenu. WHICH HANDSET? appears.
2. Move the cursor to select the handset ID to be deregistered from the list, and then press **[select/☒]**. DEREGISTER HS appears.
3. The phone will ask you to confirm the deregistration. Move the cursor to YES, and then press **[select/☒]**. You will hear a confirmation tone. the handset will delete its own base information without trying to contact the base. When the base information is deleted, the handset displays MODELS VARY! CHARGE HANDSET ON THE BASE FOR REGISTRATION OR REFER TO OWNER'S MANUAL.

If the handset cannot contact the base, it displays UNAVAILABLE. Make sure the handset is in range of the base and the base is connected to power.

Note: It is also possible to reset the handset back to its original factory settings. All changes including phone-book entries and Caller ID information will be erased. For more information on resetting the handset back to factory settings and when you need to do this, see [www.uniden.com](http://www.uniden.com) or call our Customer Service Hotline (For contact information, see the back page).

## Resetting the Handset without the Base

If your original base is not available for some reason (for example, it is lost or somehow incapacitated), you can still reset the handset and use it with another base.

1. Press and hold **[\*]** and **[#>]** for at least 5 seconds until the SYSTEM RESET menu appears.
2. Move the cursor to select the REPLACING BASE submenu, and then press **[select/☒]**. REPLACE BASE appears.
3. Move the cursor to select YES, and then press **[select/☒]**. A confirmation tone sounds. The handset deletes its own base information without trying to contact the base. When the base information is deleted, the handset displays MODELS VARY! CHARGE HANDSET ON THE BASE REGISTRATION OR REFER TO OWNER'S MANUAL. To register the handset to the new base, see page 24.

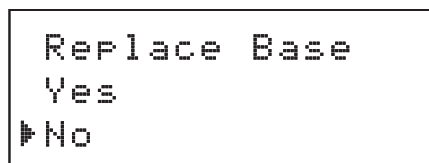



## Changing the Digital Security Code

The digital security code is an identification code used to connect the handset and the base unit. Your unit ships from the manufacturer with a preset security code. Resetting this code is not normally necessary. In the rare situation that you suspect another cordless telephone is using the same security code or if you are instructed to change this code by a manufacturer's Call Center Representative, you can change the code. To change the digital security code:

1. Reset all handsets (see page 25).
2. Re-register each handset by following the steps on page 24.

## Traveling Out of Range

During a call, as you begin to move your handset too far from your base unit, noise may increase. If you pass the range limits of the base unit, you hear a beep and see OUT OF RANGE on the display, and then the handset returns to standby. You may return to the call if you move your handset within the range limits of the base and press **[flash]** or **[MUTE]** within 30 seconds.

## Common Issues

If your phone is not performing to your expectations, please try these simple steps first. If these steps do not solve your problem, please call our Customer Hotline (see back cover for contact information).

Symptom	Suggestion
The charge LED fails to light when the handset is placed in the cradle.	<ul style="list-style-type: none"><li>• Make sure the AC adapter is plugged into the base or the charger (if you have more than one handset) and wall outlet.</li><li>• Make sure the handset is properly seated in the cradle.</li><li>• Make sure the charging contacts on the handset are clean.</li></ul>
The audio sounds weak.	<ul style="list-style-type: none"><li>• Move the handset and/or base away from metal objects or appliances and try again.</li><li>• Make sure you are not too far from the base.</li></ul>

Symptom	Suggestion
Can't make or receive calls.	<ul style="list-style-type: none"> <li>• Make sure you are not too far from the base.</li> <li>• Make sure the line is not in use. If an outside call is already using a line, you cannot use that line to make another outside call.</li> <li>• Check both ends of the base telephone line cord.</li> <li>• Make sure the AC adapter is plugged into the base and wall outlet.</li> <li>• Disconnect the AC adapter and reconnect.</li> <li>• Change the Digital Security Code (see page 49).</li> </ul>
The handset doesn't ring or receive a page.	<ul style="list-style-type: none"> <li>• Make sure that you are not too far from the base.</li> <li>• Charge the battery in the handset for 15 to 20 hours by placing the handset on the base or charging cradle.</li> <li>• Change the Digital Security Code (see page 49).</li> </ul>
Severe noise interference.	<ul style="list-style-type: none"> <li>• Keep the handset away from microwave ovens, computers, remote control toys, wireless microphones, alarm systems, intercoms, room monitors, fluorescent lights, and electrical appliances.</li> <li>• Move to another location or turn off the source of interference.</li> </ul>
The Caller ID does not display.	<ul style="list-style-type: none"> <li>• The call was placed through a switchboard.</li> <li>• Call your telephone provider to verify your Caller ID service is correct. There may be a problem with your Caller ID service.</li> </ul>
You cannot register the handset at the base.	<ul style="list-style-type: none"> <li>• Charge the battery pack in the handset for at least 15 to 20 hours.</li> <li>• Change the Digital Security Code (see page 49).</li> </ul>
The handset doesn't communicate with other handsets.	<ul style="list-style-type: none"> <li>• Change the Digital Security Code (see page 49).</li> <li>• Make sure you have registered all handsets.</li> </ul>
An extra handset can't join the conversation.	<ul style="list-style-type: none"> <li>• Make sure there are not 2 handsets already using the conference feature.</li> <li>• Make sure that another handset is not in privacy mode.</li> </ul>

Symptom	Suggestion
The Room Monitor feature does not work.	<ul style="list-style-type: none"> <li>• Make sure to place the handset(s) within the range of the base.</li> </ul>
The Voice Message Waiting LED flashes, but there are no new messages.	<ul style="list-style-type: none"> <li>• Reset the Voice Message Waiting Indicator (see page 22).</li> </ul>

## Liquid Damage

Moisture and liquid can damage your cordless phone. Follow the suggestions below if your phone gets wet:

### Exterior

If the handset or base is exposed to moisture or liquid, but only the exterior plastic housing is affected, wipe off the liquid, and use as normal.

### Interior

If moisture or liquid has entered the plastic housing (i.e. liquid can be heard in the phone or liquid has entered the handset battery compartment or vent openings on the base):

#### Handset:

1. Remove the battery cover and leave it off for ventilation.
2. Disconnect the battery pack. Leave the battery cover off and the battery pack disconnected for at least 3 days.
3. Once the handset is completely dry, reconnect the battery pack and the battery cover.
4. Recharge the handset's battery pack for 15 to 20 hours before using.

**IMPORTANT:** You must unplug the telephone line while recharging the battery packs to avoid charge interruption.

**Base:**

1. Disconnect the AC adapter from the base, cutting off electrical power.
2. Disconnect the telephone cord from the base.
3. Let dry for at least 3 days.

**CAUTION: DO NOT** use a microwave oven to speed up the drying process. This will cause permanent damage to the handset, base and the microwave oven. After following these steps, if your cordless telephone does not work, please call our Customer Service Hotline (see back page).

## **Precautions!**

Before you read anything else, please observe the following:

### **Warning!**

Uniden America Corporation DOES NOT represent this unit to be waterproof. To reduce the risk of fire, electrical shock, or damage to the unit, DO NOT expose this unit to rain or moisture.

## **Rechargeable Nickel-Metal-Hydride Battery Warning**

- This equipment contains a rechargeable Nickel-Metal-Hydride battery.
- The rechargeable batteries contained in this equipment may explode if disposed of in a fire.
- Nickel is a chemical known to state of California to cause cancer.
- Do not short-circuit the battery.
- Do not charge the rechargeable battery used in this equipment in any charger other than the one designed to charge this battery as specified in the owner's manual. Using another charger may damage the battery or cause the battery to explode.

**Rechargeable Batteries Must Be Recycled or Disposed of Properly.**



The exclamation point within an equilateral triangle is intended to alert the user to the presence of important operating and maintenance (servicing) instructions in the literature accompanying the appliance.

Uniden works to reduce lead content in our PVC coated cords in our products and accessories.

**Warning!**

The cords on this product and/or accessories contain lead, a chemical known to the State of California to cause birth defects or other reproductive harm. Wash hands after handling.

**Important Safety Instructions**

When using your telephone equipment, basic safety precautions should always be followed to reduce the risk of fire, electric shock and injury to persons, including the following:

1. Do not use this product near water, for example, near a bath tub, wash bowl, kitchen sink or laundry tub, in a wet basement or near a swimming pool.
2. Avoid using a telephone (other than a cordless type) during an electrical storm. There may be a remote risk of electric shock from lightning.
3. Do not use the telephone to report a gas leak in the vicinity of the leak.
4. Use only the power cord and batteries indicated in this manual. Do not dispose of batteries in a fire. They may explode. Check with local authorities for possible battery disposal instructions.
5. Do not disassemble any component of this product.

## SAVE THESE INSTRUCTIONS

### CAUTION

Risk of explosion if battery is replaced by an incorrect type. Dispose of used batteries according to the instructions. Do not open or mutilate the battery, and disconnect the battery before shipping this product.

### The FCC Wants You To Know

This equipment complies with Part 68 of the FCC rules and the requirements adopted by the ACTA. On the bottom of this equipment is a label that contains, among other information, a product identifier in the format US:AAAEQ##TXXXX. If requested, this number must be provided to the telephone company.

An applicable Universal Service Order Codes (USOC) certification for the jacks used in this equipment is provided (i.e., RJ11C) in the packaging with each piece of approved terminal equipment. A plug and jack used to connect this equipment to the premises wiring and telephone network must comply with the applicable FCC Part 68 rules and requirements adopted by the ACTA. A compliant telephone cord and modular plug is provided with this product. It is designed to be connected to a compatible modular jack that is also compliant. See installation instructions for details.

The REN is used to determine the number of devices that may be connected to a telephone line. Excessive RENs on a telephone line may result in the devices not ringing in response to an incoming call. In most but not all areas, the sum of RENs should not exceed five (5.0). To be certain of the number of devices that may be connected to a line, as determined by the total RENs, contact the telephone provider. For products approved after July 23, 2001, the REN for this product is part of the product identifier that has the format US:AAAEQ##TXXXX. The digits represented by ## are the REN without a decimal point (e.g., 03 is a REN of 0.3). For earlier products, the REN is separately shown on the label.

If this equipment causes harm to the telephone network, the telephone company will notify you in advance that temporary discontinuance of service may be required. But if advance notice isn't practical, the telephone company will notify the customer as soon as possible. Also, you will be advised of your right to file a complaint with the FCC if you believe it is

necessary.

The telephone company may make changes in its facilities, equipment, operations or procedures that could affect the operation of the equipment. If this happens the telephone company will provide advance notice in order for you to make necessary modifications to maintain uninterrupted service.

Please follow instructions for repairing, if any (e.g. battery replacement section); otherwise do not substitute or repair any parts of the device except as specified in this manual. Connection to party line service is subject to state tariffs. Contact the state public utility commission, public service commission or corporation commission for information. This equipment is hearing aid compatible.

Should you experience trouble with this equipment, please contact Uniden customer service at 800-297-1023. If the equipment is causing harm to the telephone network, the telephone company may request that you disconnect the equipment until the problem is resolved.

NOTICE: According to telephone company reports, AC electrical surges, typically resulting from lightning strikes, are very destructive to telephone equipment connected to AC power sources. To minimize damage from these types of surges, a surge arrester is recommended.

Changes or modifications to this product not expressly approved by Uniden, or operation of this product in any way other than as detailed by the owner's manual, could void your authority to operate this product.

This device complies with part 15 of the FCC rules. Operation is subject to the following two conditions: (1) This device may not cause harmful interference, and (2) This device must accept any interference received, including interference that may cause undesired operation. Privacy of communications may not be ensured when using this phone.

To insure the safety of users, the FCC has established criteria for the amount of radio frequency energy various products may produce depending on their intended usage. This product has been tested and found to comply with the FCC's exposure criteria. For body worn operation, the FCC RF exposure guidelines were also met when used with the Uniden accessories supplied or designed for this product. Use of other accessories may not ensure compliance with FCC RF exposure guide-

lines and should be avoided.

### **Radio Interference**

Radio interference may occasionally cause buzzing and humming in your cordless handset, or clicking noises in the base. This interference is caused by external sources such as TV, refrigerator, vacuum cleaner, fluorescent lighting, or electrical storm. Your unit is NOT DEFECTIVE. If these noises continue and are too distracting, please check around your home to see what appliances may be causing the problem. In addition, we recommend that the base not be plugged into a circuit that also powers a major appliance because of the potential for interference. Be certain that the antenna on the unit is fully extended when needed. In the unlikely event that you consistently hear other voices or distracting transmissions on your phone, you may be receiving radio signals from another cordless telephone or other source of interference. If you cannot eliminate this type of interference, you need to change to a different channel.

Finally, it should be noted that some cordless telephones operate at frequencies that may cause interference to nearby TVs and VCRs. To minimize or prevent such interference, the base of the cordless telephone should not be placed near or on top of a TV or VCR. If interference is experienced, moving the cordless telephone farther away from the TV or VCR will often reduce or eliminate the interference.

### **Cordless Telephone Privacy**

Cordless telephones are radio devices. Communications between the handset and base of your cordless telephone are accomplished by means of radio waves which are broadcast over the open airways. Because of the inherent physical properties of radio waves, your communications can be received by radio receiving devices other than your own cordless telephone unit. Consequently, any communications using your cordless telephone may not be private.

### **I.C. Notice**

#### **Terminal Equipment**

**NOTICE:** This equipment meets the applicable Industry Canada Terminal Equipment Technical Specifications. This is confirmed by the registration number. The abbreviation, IC, before the registration number signifies

that registration was performed based on a Declaration of Conformity indicating that Industry Canada technical specifications were met. It does not imply that Industry Canada approved the equipment.

**NOTICE:** The Ringer Equivalence Number (REN) for this terminal equipment is marked on the equipment itself. The REN assigned to each terminal equipment provides an indication of the maximum number of terminals allowed to be connected to a telephone interface. The termination on an interface may consist of any combination of devices subject only to the requirement that the sum of the Ringer Equivalence Numbers of all the devices does not exceed five.

#### **RADIO EQUIPMENT**

The term "IC:" before the radio certification number only signifies that Industry Canada technical specifications were met.

Operation is subject to the following two conditions: (1) this device may not cause interference, and (2) this device must accept any interference, including interference that may cause undesired operation of the device. "Privacy of communications may not be ensured when using this telephone."

## One Year Limited Warranty

Important: Evidence of original purchase is required for warranty service. WARRANTOR: UNIDEN AMERICA CORPORATION ("Uniden") ELEMENTS OF WARRANTY: Uniden warrants, for one year, to the original retail owner, this Uniden Product to be free from defects in materials and craftsmanship with only the limitations or exclusions set out below. WARRANTY DURATION: This warranty to the original user shall terminate and be of no further effect 12 months after the date of original retail sale. The warranty is invalid if the Product is (A) damaged or not maintained as reasonable or necessary, (B) modified, altered, or used as part of any conversion kits, subassemblies, or any configurations not sold by Uniden, (C) improperly installed, (D) serviced or repaired by someone other than an authorized Uniden service center for a defect or malfunction covered by this warranty, (E)

used in any conjunction with equipment or parts or as part of any system not manufactured by Uniden, or (F) installed or programmed by anyone other than as detailed by the owner's manual for this product. STATEMENT OF REMEDY: In the event that the product does not conform to this warranty at any time while this warranty is in effect, warrantor will either, at its option, repair or replace the defective unit and return it to you without charge for parts, service, or any other cost (except shipping and handling) incurred by warrantor or its representatives in connection with the performance of this warranty. Warrantor, at its option, may replace the unit with a new or refurbished unit. THE LIMITED WARRANTY SET FORTH ABOVE IS THE SOLE AND ENTIRE WARRANTY PERTAINING TO THE PRODUCT AND IS IN LIEU OF AND EXCLUDES ALL OTHER WARRANTIES OF ANY NATURE WHATSOEVER, WHETHER EXPRESS, IM-

PLIED OR ARISING BY OPERATION OF LAW, INCLUDING, BUT NOT LIMITED TO ANY IMPLIED WARRANTIES OF MERCHANTABILITY OR FITNESS FOR A PARTICULAR PURPOSE. THIS WARRANTY DOES NOT COVER OR PROVIDE FOR THE REIMBURSEMENT OR PAYMENT OF INCIDENTAL OR CONSEQUENTIAL DAMAGES. Some states do not allow this exclusion or limitation of incidental or consequential damages so the above limitation or exclusion may not apply to you.

LEGAL REMEDIES: This warranty gives you specific legal rights, and you may also have other rights which vary from state to state. This warranty is void outside the United States of America and Canada. PROCEDURE FOR OBTAINING PERFORMANCE OF WARRANTY: If, after following the instructions in the owner's manual you are certain that the Product is defective, pack the Product carefully (preferably in its original packaging). Disconnect the battery from the Product and separately secure the battery in its own separate packaging within the shipping carton. The Product should include all parts and accessories originally packaged with the Product. Include evidence of original purchase and a note describing the defect that has caused you to return it. The Product should be shipped freight prepaid, by traceable means, to warrantor at:

### **Uniden America Service**

4700 Amon Carter Blvd.  
Fort Worth, TX 76155



## Index

### A

Adjusting Audio Tone .....	38
Answering a Call.....	33
Any Key Answer .....	32
AutoTalk.....	32

### B

Battery Contact Maintenance .....	46
Battery Replacement and Handling .....	46

### C

Caller ID on Call Waiting .....	20
Call Waiting Deluxe .....	20
Clarity Boost .....	38
Controls Part of the Handset .....	7

### D

Day and Time .....	19
Deleting a Redial Record.....	37
Deleting Caller ID Numbers.....	35
Dial Mode .....	19
Digital Security Code .....	49
DirectLink.....	42
Do Not Disturb .....	41

### E

Earpiece Volume .....	38
Entering Text from the Handset..	12

### F

Four Way Function Key .....	11
-----------------------------	----

### H

Handset Banner.....	30
Hanging Up.....	33

### I

Important Safety Instructions.....	53
Installing the Belt Clip .....	18
Installing the Phone .....	13
Installing the Rechargeable Battery .....	16

### K

Key Touch Tone .....	21
----------------------	----

### L

Low Battery Alert .....	47
-------------------------	----

### M

Maintenance .....	46
Making a Call.....	33
Making a call from a Caller ID Re- cord .....	35
Making a call with Speed Dial.....	34
Muting the Microphone .....	41
Muting the Ringer .....	41

### O

Optional Headset.....	45
Out of Range .....	49

### P

Personal Ring .....	20
Phonebook .....	25
Placing a Call on Hold .....	39
Privacy Mode.....	41
Product Overview .....	6

### R

Redialing a Number.....	37
Resetting Handsets .....	25
Ringer Tones .....	31
Ringer Volume .....	37
Room/Baby Monitor.....	44

**S**

Speaker Volume .....	38
Speed Dial .....	26

**T**

Talk and Standby Time .....	47
The FCC Wants You To Know ....	54

**V**

Voice Mail .....	21
Voice Mail Programming.....	22
Voice Mail Tone .....	21
Voice Message Waiting Indicator	22

**Specifications**

Operating Temperature	0° C to 50° C (32° F to 122° F)
AC Adapter Part Number	Base: AD-800 Charging Cradle: AD-0005
Input Voltage	Base: 120V AC, 60 Hz Charging Cradle: 120V AC, 60 Hz
Output Voltage	Base: 9V DC @ 350mA Charging Cradle: 9V DC @ 210mA
Battery Part Number	BT-909
Capacity	3.6V DC @ 600mAh

## Notes:

- Use only the supplied AD-800 and AD-0005 AC adapters.
- Do not use any other AC adapter.
- Do not place the power cord where it creates a trip hazard or where it could become chafed and create a fire or electrical hazard.
- Do not place the base in direct sunlight or subject it to high temperatures.

## At Uniden, we'll take care of you!

Thank you for purchasing a Uniden product. If you have any questions or problems, **please do not return this product to the place of purchase.**

**Having Trouble?** Our customer care specialists are here to help you! Visit our website at **www.uniden.com** or call our Customer Service Hotline at **1-800-297-1023**, Monday through Friday, 7 AM to 7 PM or Saturday/Sunday, 9 AM to 5 PM, CST. The Customer Service Hotline is closed on holidays.

**Need A Part?** To order headsets, additional handsets, replacement batteries, or other accessories, visit our website at **www.uniden.com** or call **1-800-554-3988**, Monday through Friday, 8 AM to 5 PM, CST.

**Help For Our Customers with Special Needs** If you need special assistance due to a disability, or have questions on the accessibility features of this product, please call **1-800-874-9314 (voice or TTY)**.



May be covered under one or more of the following U.S. patents:

4,797,916	5,381,460	5,426,690	5,434,905	5,491,745	5,493,605
5,533,010	5,574,727	5,581,598	5,650,790	5,660,269	5,661,780
5,663,981	5,671,248	5,696,471	5,717,312	5,732,355	5,754,407
5,758,289	5,768,345	5,787,356	5,794,152	5,801,466	5,825,161
5,864,619	5,893,034	5,912,968	5,915,227	5,929,598	5,930,720
5,960,358	5,987,330	6,044,281	6,070,082	6,125,277	6,253,088
6,314,278	6,418,209	6,618,015	6,671,315	6,714,630	6,782,098
6,788,920	6,788,953	6,839,550	6,889,184	6,901,271	6,907,094
6,914,940					

**Uniden** | A World Without Wires®

**VISIT  
WWW.UNIDEN.COM  
TO REGISTER YOUR  
PRODUCT**

© 2006 Uniden America Corporation, Fort Worth, Texas. Contains additional foreign articles. Printed in China.

UPZZ01392BZ[0]

## Free Manuals Download Website

<http://myh66.com>

<http://usermanuals.us>

<http://www.somanuals.com>

<http://www.4manuals.cc>

<http://www.manual-lib.com>

<http://www.404manual.com>

<http://www.luxmanual.com>

<http://aubethermostatmanual.com>

Golf course search by state

<http://golfingnear.com>

Email search by domain

<http://emailbydomain.com>

Auto manuals search

<http://auto.somanuals.com>

TV manuals search

<http://tv.somanuals.com>