

Uniden



900 MHz CORDLESS

with extended range

owner's manual



EXP2900



Welcome

The Uniden EXP2900 Series 900 MHz cordless phones are designed and engineered to exacting standards for reliability, long life, and outstanding performance.

Note: Some illustrations in this manual may differ from the actual unit for explanation purpose.

Features

- 900 MHz Extended Range Technology
- 3 One-Touch Priority Keys
- 7 Hour Talk Time/14 Day Standby Time
- 10 Number Memory Dialing
- 30 Channel Autoscan
- 32 Digit Redial
- AutoStandby™
- AutoTalk™
- Handset Earpiece and Ringer Volume Control
- Hearing Aid Compatible
- Page/Find
- Tone/Pulse Dialing

The EXP2900 Series features include **AutoTalk™** and **AutoStandby™**. *AutoTalk* allows you to answer a call by just removing the handset from the base so you don't have to waste time pushing buttons or flipping switches. *AutoStandby* allows you to hang up by simply returning the handset to the base.

The **UltraClear Plus™** true compander circuitry virtually eliminates background noise. This innovative technology, together with 30 different channels, provides you with the best possible reception during all your conversations.

To protect you against misbilled calls which might result from your phone being activated by other equipment, the EXP2900 Series has **Random Code™** digital security which automatically selects one of over 65,000 digital security codes for the handset and base. Also, the **AutoSecure™** feature electronically locks your phone when the handset is in the base.

Be sure to visit our web site: www.uniden.com

Uniden® is a registered trademark of Uniden America Corporation.

AutoTalk, AutoStandby, UltraClear Plus, Random Code, and AutoSecure are trademarks of Uniden America Corporation.

Contents

Welcome/Features			
Controls and Functions	2	Memory Dialing	
Getting Started		Storing a Phone Number in Memory	15
Checking the Package Contents	3	Dialing a Stored Number	16
Setting up the Phone	4	Chain Dialing	17
Mounting the Base Unit on a Wall	9	Erasing a Stored Number from Memory	17
Basics		Additional Information	
Making and Receiving Calls	11	Changing the Digital Security Code	18
Terminology	12	Note on Power Sources	19
Adjusting Ringer and Earpiece Volume	12	Maintenance	19
Redial	12	Troubleshooting	20
Tone Dialing Switch-over	13	General Information	22
Traveling Out-of-Range	13	Technical Information	23
Selecting a Different Channel	14		
Page	14		
Flash and Call Waiting	14		

Controls and Functions

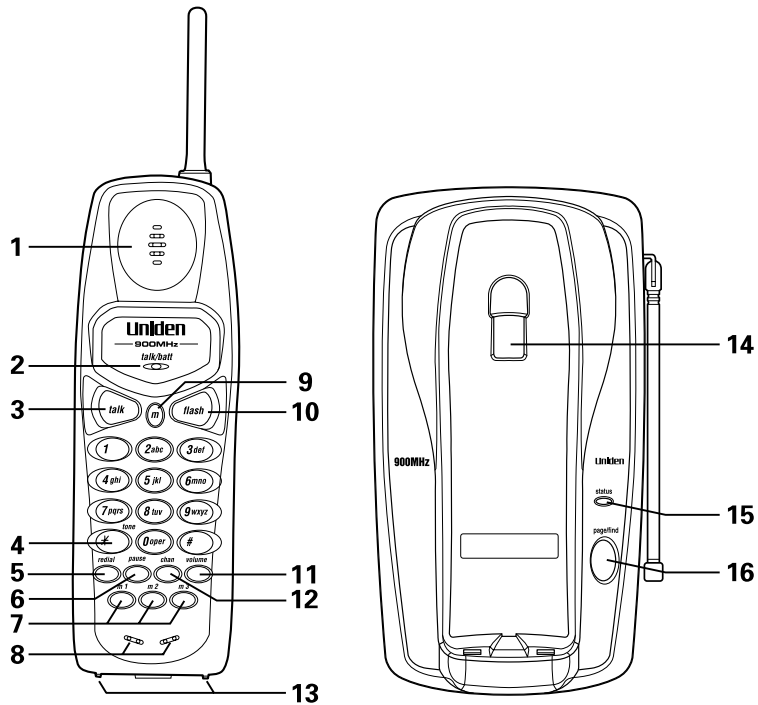

1. Handset earpiece
2. Talk/batt LED
3. Talk key
4. * /tone key
5. Redial key
6. Pause key
7. One-Touch Priority
(m1, m2, and m3) keys
8. Handset microphone and ringer speaker
9. Memory (m) key
10. Flash key
11. Handset ringer tone and earpiece
volume key
12. Channel (chan) key
13. Handset charging contacts
14. Handset retainer clip
15. Status LED
16. Page/find key

Checking the Package Contents

Make sure you have received the following items in the package. If any of these items are missing or damaged, contact the Uniden Parts Department (see below).

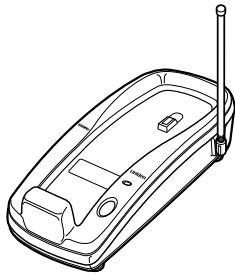

• Base unit



• Handset

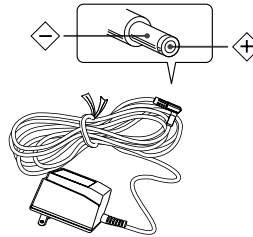

• AC adapter

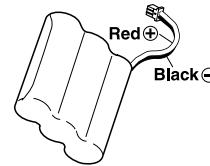

• Rechargeable battery

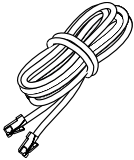

• Telephone cord

Also included:

- This Owner's Manual
- Precautions and Important Safety Instructions/Warranty Information

Uniden Parts Department at (800) 554-3988
Hours: M-F 7:00 a.m. to 5:00 p.m. CST. We can also be reached on the web at www.uniden.com

Setting up the Phone

Do the following steps:

- A. Choose the best location
- B. Install the battery pack
- C. Connect the base unit
- D. Choose the dialing mode

A. Choose the best location

Before choosing a location for your new phone, read the INSTALLATION CONSIDERATIONS included in the PRECAUTIONS AND IMPORTANT SAFETY INSTRUCTIONS brochure. Here are some important guidelines you should consider:

Avoid heat sources, such as radiators, air ducts, and sunlight

Avoid television sets and other electronic equipment

Choose a central location

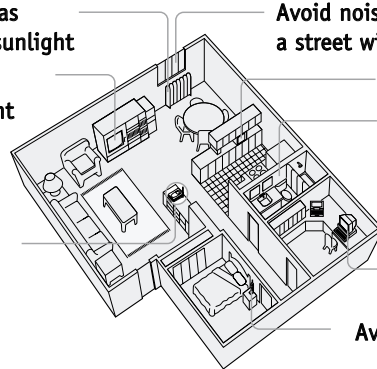

Avoid noise sources such as a window by a street with heavy traffic

Avoid microwave ovens

Avoid excessive moisture, extremely low temperatures, dust, mechanical vibration, or shock

Avoid personal computers

Avoid other cordless telephones

- The location should be close to both a phone jack and a continuous power outlet which is not switchable.
- Keep the base and handset away from sources of electrical noise such as motors, microwave ovens, and fluorescent lighting.
- Be sure there is sufficient space to raise the base antenna to a vertical position.
- The base can be placed on a desk, tabletop, or mounted on a standard wall plate.

B. Install the battery pack

Charge the battery pack for at least 12-15 hours before plugging the phone line into your phone.

- 1) Press in on the battery cover release and slide the cover down until it comes off.
- 2) Connect the battery pack connector observing correct polarity (black and red wires) to the jack inside the battery compartment.

Do not exert any force on this connection. It could cause damage to the battery or handset. The plastic connector will fit together only one way. Once you are certain that you have made a good connection, then insert the battery pack into the battery compartment. Do not pinch the wires.

- 3) Securely close the battery compartment cover by sliding it up until it snaps into place.
- 4) Place the handset on the base.

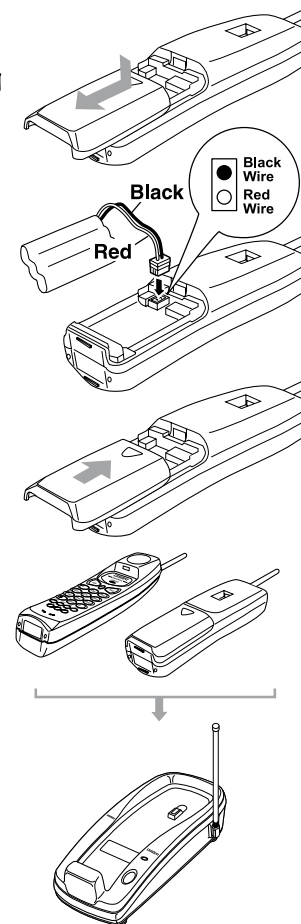

Use only the Uniden battery (BT-905) supplied with your phone. Replacement batteries are also available through the Uniden Parts Department (see page 3).



- Even when the battery pack is not being used, it will gradually discharge over a long period of time. For optimum performance, be sure to return the handset to the base unit after each telephone call .
- If you must replace the battery pack during a telephone call, complete the replacement within 30 seconds, and you can return to the original call.

Battery use time (per charge)

From fully charged

- Seven hours continuous use
- Fourteen days when the handset is in the standby mode

Low Battery Alert

When the battery pack is very low and needs to be charged, the phone is programmed to eliminate functions in order to save power. If the phone is not in use, the **talk/batt** LED flashes when the battery pack is low.

If the phone is in use, the **talk/batt** LED flashes and the handset beeps. Complete your conversation as quickly as possible and return the handset to the base for charging.



The last number dialed in the redial memory and the numbers stored in the memory locations are retained for up to 1 minute while you replace the battery pack.

Cleaning the Battery Charging Contacts

To maintain a good charge, it is important to clean the battery contacts on the handset and base unit with a dry cloth or a pencil eraser about once a month. Do not use any liquids or solvents.

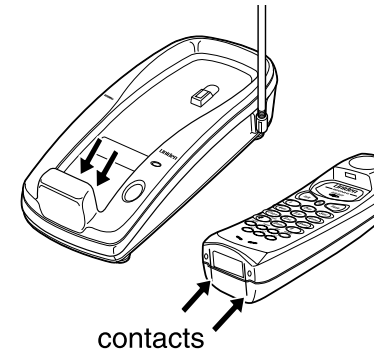

C. Connect the base unit

- 1) Connect the AC adapter to the **DC IN 9V** jack and a standard 120V AC wall outlet.
- 2) Set the base on a desk or tabletop, and place the handset on the base unit as shown. (For wall mounting, see "Mounting the Base Unit on a Wall", on page 9.)
- 3) Then raise the antenna to a vertical position.
- 4) Make sure the **status** LED lights. If the LED does not light, check to see that the AC adapter is plugged in and the handset makes good contact with the base charging contacts.

note

- Use only the supplied AD-310 AC adapter. Do not use any other AC adapter.
- Connect the AC adapter to a continuous power supply.
- Place the base unit close to the AC outlet so that you can unplug the AC adapter easily.

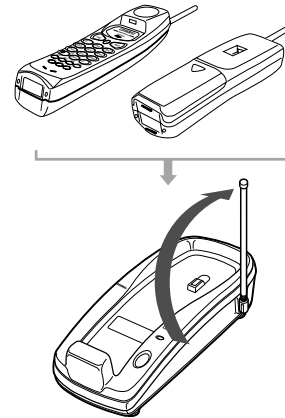
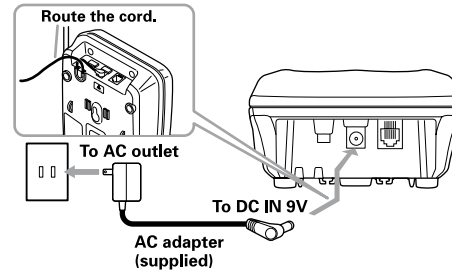

Place the power cord so that it does not create a trip hazard or where it could become chafed and create a fire or electrical hazard.



The handset can be placed face up or face down in the base for charging.

After installing the battery pack in the handset, charge your handset at least **12-15 hours before plugging into the phone line**. Once the handset battery pack is fully charged, connect the telephone line cord to the base and telephone wall outlet.

5) Connect the telephone line cord to the **TEL LINE** jack and a telephone outlet once the handset is fully charged.



If your telephone outlet isn't modular, contact your telephone company for assistance.

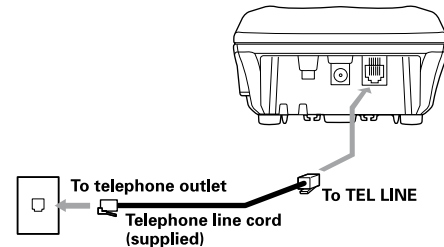

Make sure your battery pack is fully charged before choosing the dial mode.

D. Choose the dialing mode

Most phone systems use tone dialing which sends DTMF tones through the phone lines. However some phone systems still use pulse dialing such as in rural areas. The default setting is tone dialing. Depending on your dialing system, set the mode as follows:

- 1) Press and hold **flash** until you hear a confirmation tone.
- 2) To set the dial mode for pulse dialing, press **#**.
Or to set the dial mode for tone dialing, press ***/tone**.
A confirmation tone sounds to indicate the setting is complete.

- If you are not sure of your dialing system, set for tone dialing. Make a trial call. If the call connects, leave the setting as is, otherwise set for pulse dialing.
- If your phone dialing system requires pulse dialing and you need to send DTMF tones for certain situations during a call, you may "switch-over" to tone dialing. (Refer to "Tone Dialing Switch-over" on page 13.)

Mounting the Base Unit on a Wall

Setting the handset retainer clip for wall mounting

- 1) On the base unit, pull the handset retainer clip out of the slot and rotate it clockwise 180 degrees.
- 2) Flip the retainer clip from front to back. Slide it back into the slot so that the lip of the retainer is up and the ▼ is down. The retainer holds the handset in place.

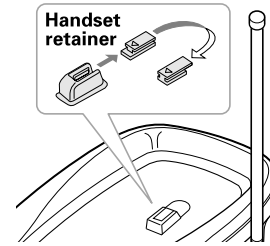

Standard wall plate mounting

This phone can be mounted on any standard wall plate.

- 1) Plug the AC adapter into the **DC IN 9V** jack.
- 2) Wrap the AC adapter cord inside the molded wiring channel as shown.
- 3) Plug the AC adapter into a standard 120V AC wall outlet.
- 4) Place the handset on the base unit and charge for 12-15 hours.
- 5) Plug the telephone line cord into the **TEL LINE** jack. Wrap the cord inside the molded wiring channel as shown.
- 6) Plug the telephone line cord into the telephone outlet.

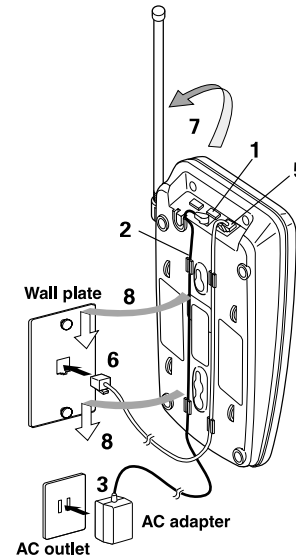

DO NOT use an outlet controlled by a wall switch.

- 7) Raise the antenna to a vertical position.
- 8) Align the mounting slots on the base with the mounting posts on the wall. Then push in and down until the phone is firmly seated.

Direct wall mounting



If you don't have a standard wall plate, you can mount your phone directly to the wall. Before doing this, consider the following:

- Avoid electrical cables, pipes, or other items behind the mounting location that could cause a hazard when inserting screws into the wall.
- Try to mount your phone within 5 feet of a working phone jack to avoid excessive lengths.
- Make sure the wall material is capable of supporting the weight of the base and handset.
- Use #10 screws (minimum length of 1-3/8 inches) with anchoring devices suitable for the wall material where the base unit will be placed.

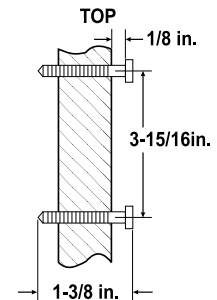
- 1) Insert two mounting screws into the wall, (with their appropriate anchoring device), 3-15/16 inches apart. Allow about 1/8 of an inch between the wall and screw heads for mounting the phone.
- 2) Set the retainer clip if necessary.
- 3) Refer to steps 1 through 8 on pages 9 and 10 to mount the telephone.

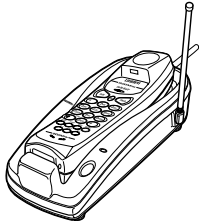

Making and Receiving Calls

	Handset On Base	Handset Off Base
		
To answer a call	When the phone rings, remove the handset from the base. (AutoTalk)	Press talk .
To make a call	<ol style="list-style-type: none"> 1) Remove the handset from the base and press talk. 2) The talk/batt LED flashes. 3) Listen for the dial tone. 4) Dial the number. 	<ol style="list-style-type: none"> 1) Pick up the handset and press talk. 2) The talk/batt LED flashes. 3) Listen for the dial tone. 4) Dial the number.
To hang up	Return the handset to the base. (AutoStandby)	Press talk .
To redial	<ol style="list-style-type: none"> 1) Remove the handset from the base and press talk. 2) Listen for the dial tone. 3) Press redial to dial the last number dialed. 	<ol style="list-style-type: none"> 1) Pick up the handset and press talk. 2) Listen for the dial tone. 3) Press redial to dial the last number dialed.

Terminology

Throughout this manual, terms such as Standby and Talk Mode are used. Below is the terminology explanation.

- **Standby Mode** -The handset is not in use, off the base, and *talk* has not been pressed. A dial tone is not present.
- **Talk Mode** -The handset is off the base and *talk* has been pressed enabling a dial tone.

Adjusting the Ringer and Earpiece Volume

Ringer tone and volume

When the phone is in standby mode, pressing the *volume* key on the handset selects the handset ringer volume and tone. There are two ringer tones each with two volume levels. Continue pressing the *volume* key to listen to all tones and volume levels. The phone keeps the last ringer tone and volume setting selected.

Earpiece volume

The handset earpiece volume settings (Normal, High and Loud) can only be adjusted during a call. Press *volume* repeatedly to select Normal, High or Loud. When you hang up, the phone keeps the last volume setting selected.

Redial

The *redial* key redials the last number dialed. The redialed number can be up to 32 digits long.

Tone Dialing Switch-over

Some telephone companies use equipment that require pulse dialing (sometimes referred to as rotary dialing). If you need to enter tone dialing digits, you can switch-over to tone dialing during the call. An example of this could be entering your bank account number after you have called your bank. The digits of your bank account can be sent using DTMF tones.

Initially make your call with the pulse dialing mode. Once your call connects, press ***/tone**. Enter the desired number (like in the example above the bank account number). These digits will be sent as tone dialing. This special number can be stored in a memory location. This is referred to as Chain Dialing (See page 17.). Once the call ends, the tone mode is canceled and pulse dialing mode resumes.

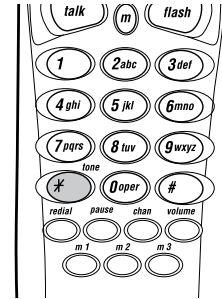

The tone feature only applies when the dial mode is set to pulse.

Traveling Out-of-Range

During a call, as you begin to move your handset too far from your base unit, noise increases. If you pass the range limits of the base unit, your call will terminate within 30 seconds.



If you press **talk** during paging, the handset will be placed in the talk mode.

Selecting a Different Channel

If you encounter interference while using your phone, you can manually change the phone's channel for clear operation. Interference can come from appliances or other phones in your home. This function works only when the phone is in use.

During the course of a conversation, if you hear static or noise which makes it difficult to hear, press **chan**. The **talk/batt** LED flashes, indicating the phone is changing to another channel. For more information on interference, refer to "Technical Information" on page 23.

Page

To locate the handset (while it's off the base), press **page/find** on the base. The handset beeps for 60 seconds.

Paging is canceled when pressing any key, **page/find** on the base or return the handset to the base.

Flash and Call Waiting

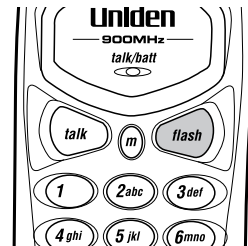

If you have "call waiting" service and a call waiting tone sounds while you are on a call, press **flash** to accept the waiting call. There is a short pause, then you will hear the new caller. To return to the original caller, press **flash** again.



You must subscribe through your local telephone company to receive Call Waiting Service.

Storing a Phone Number in Memory

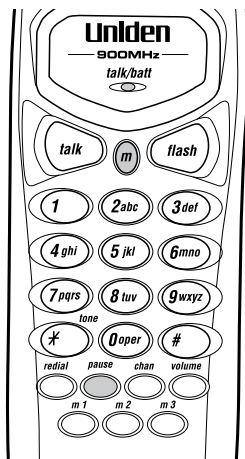

Your EXP2900 Series phone has 10 memory locations for storing important telephone numbers.

- 1) Remove the handset from the base.
- 2) Press *m*. The *talk/batt* LED flashes.
- 3) Enter the phone number, up to 16 digits. If a pause is needed during the dialing sequence, press *pause* to insert a pause. Each pause counts as a digit and represents a two second delay in time between digits as they are sent.
- 4) Press *m* again.
- 5) Enter the memory location (0-9) on the keypad. A tone indicates that the number is stored. If you enter a number in a location that has a previously stored number it will overwrite the existing number without warning.



- The pause button counts as one digit. Pressing *pause* more than once increases the length of pause between numbers.
- You have 20 seconds after pressing *m* to enter the number you wish to store. Otherwise, an error tone will sound.
- You cannot store numbers in *m1*, *m2*, or *m3*. (See "One-touch priority dialing", on page 16.)

Dialing a Stored Number

Using the memory location features

- 1) Press *talk*, then press *m*.
- 2) Enter the memory location (0-9) on the keypad. The stored number automatically dials.



If you select a memory location that does not have a stored number, the handset will beep rapidly and the phone will not dial.

One-touch priority dialing

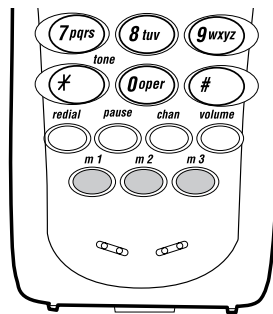

Your phone is equipped with three "One-touch priority dial" keys for instant dialing. You cannot store phone numbers directly into *m1*, *m2*, or *m3*. They are only used to dial the phone numbers stored into memory locations 1, 2, and 3. (See "Storing a Phone Number in Memory," page 15.)

To instantly dial phone numbers stored in memory locations 1, 2, or 3, simply press *m1*, *m2*, or *m3*. (There is no need to press *talk*. The phone will automatically dial.)

If you press *m1*, *m2*, or *m3*, and no phone number was stored in memory locations 1, 2, or 3, the phone will beep rapidly but will not dial.

Chain Dialing

The 10 memory locations on the handset are not limited to phone numbers. You may want to store in memory a group of numbers (up to 16 digits) that you need to enter once your call connects. This is referred to as Chain Dialing.

An example of this is a bank account number. Once you have called your bank, when you are prompted to enter the account number, simply press *m* and then the location where the special number has been stored.

Store your special number in memory as you would a phone number. (Refer to "Storing a Phone Number in Memory" on page 15.)

Enter a "pause" in the sequence as necessary. A "pause" counts as one digit and represents a two second delay in time between digits as they are sent.

Erasing a Stored Number from Memory

- 1) Remove the handset from the base unit.
- 2) Press *m* twice.
- 3) Press the memory location (0-9). A tone indicates that the stored number is erased from memory.



You cannot erase the phone numbers by using *m1*, *m2*, or *m3*. These are the numbers stored in memory location 1, 2, and 3.



If the handset battery pack is completely discharged or the battery pack is removed, the digital security code will be lost. If this happens, a new security code is set automatically next time the battery pack is charged.

Changing the Digital Security Code

The digital security code is an identification code used to connect the handset and the base unit. Normally, setting the code is not necessary.

The first time you charge your handset, the security code is automatically set. In the rare situation that you suspect another cordless telephone is using the same security code, you can change the code.

- 1) Place the handset on the base unit, and press *page/find*.
The handset beeps.
- 2) Remove the handset from the base unit.
- 3) Place the handset back on the base unit. A new random security code is set.

Note on Power Sources

Battery replacement and handling

When the operating time becomes short, even after a battery is recharged, please replace the battery.

With normal usage, your battery should last about one year. Please contact your place of purchase or the Uniden Parts Department for a replacement battery.

Power Failure

During the period that the power is off, you will not be able to make or receive calls with the telephone.

Caution

- Use the specified battery pack.
- Do not remove the battery from the handset to charge it.
- Never throw the battery into a fire, disassemble it, or heat it.
- Do not remove or damage the battery casing.

Maintenance

When slightly dirty

Wipe with a soft, dry cloth.

When very dirty

Wipe with a soft cloth that has been dampened with diluted, neutral detergent. Dry with a dry cloth.

When the charging terminals become dirty

Wipe with a dry cloth or a pencil eraser, if necessary.

RECYCLING NICKEL-CADMIUM BATTERIES



**NICKEL-CADMIUM BATTERIES
MUST BE DISPOSED OF
PROPERLY.**

Nickel-cadmium cells are used in the battery pack. Please take your used nickel-cadmium battery packs to a store that recycles nickel-cadmium batteries.

Caution

Do not use paint thinner, benzene, alcohol, or other chemical products. Doing so may discolor the surface of the telephone and damage the finish.

Troubleshooting

If your phone is not performing to your expectations, please try these simple steps first.

Symptom	Suggestion
The <i>status</i> LED won't light when the handset is placed in the base.	<ul style="list-style-type: none">• Make sure the AC adapter is plugged into the base and wall outlet.• Make sure the handset is properly seated in the base.• Make sure the charging contacts on the handset and base are clean.
The audio sounds weak and/or scratchy.	<ul style="list-style-type: none">• Make sure that the base antenna is in a vertical position.• Move the handset and/or base to a different location away from metal objects or appliances and try again.• Press <i>chan</i> to help eliminate background noise.• Make sure that the handset is not too far from the base.
Can't make or receive calls.	<ul style="list-style-type: none">• Check both ends of the base telephone line cord.• Make sure the AC adapter is plugged into the base and wall outlet.• Disconnect the AC adapter for a few minutes, then reconnect it.• Reset the digital security code (See page 18).• Make sure that the handset is not too far from the base.

Symptom	Suggestion
The handset doesn't ring or receive a page.	<ul style="list-style-type: none"> • The battery pack may be weak. Charge the battery on the base unit for 12-15 hours. • The handset may be too far away from the base unit. • Place the base unit away from appliances or metal objects. • Reset the digital security code (See page 18).
Severe noise interference.	<ul style="list-style-type: none"> • Keep the handset away from microwave ovens, computers, remote control toys, wireless microphones, alarm systems, intercoms, room monitors, fluorescent lights, and electrical appliances. • Move to another location or turn off the source of interference.
If you still have a problem.	<ul style="list-style-type: none"> • Call our customer hot line at 1-800-297-1023.

General Information

The phone complies with FCC Parts 15 and 68.

Operating temperature: 0° to 50°C (+32°F to +122°F)

AC Adapter Information

AC Adapter part number: AD-310
Input Voltage: 120V AC 60Hz
Output Voltage: 9V DC 210 mA

Battery Information

Battery part number: BT-905
Capacity: 600 mAH, 3.6V
Battery use time (per charge)
From fully charged
Talk mode duration: 7 hours
Standby mode duration: 14 days



If the handset is left off of the base, the actual Talk mode duration will be reduced respective to the amount of time the handset is off the base.

Recharge your phone on a regular basis by returning the handset to the base after each phone call. When the operating time becomes short, even after the battery is recharged, please replace the battery. With normal usage, the battery should last about one year.

Replacement batteries may be purchased at your local Uniden dealer or by contacting the Uniden Parts Department (800) 554-3988. Hours are from 7:00 a.m. to 5:00 p.m. Central Time, Monday through Friday. We can also be reached on the web at www.uniden.com

Specifications, features, and availability of optional accessories are all subject to change without prior notice.

Technical Information

The FCC wants you to know!

Changes or modifications to this product not expressly approved by Uniden, or operation of this product in any way other than as detailed by the owner's manual, could void your authority to operate this product. The equipment cannot be used on public coin phone service provided by the telephone company. Connection to party line service is subject to state tariffs. (Contact the state public utility commission, public service commission or corporation commission for information.)

Below is some information that might concern you while using your new phone.

Range

Your new phone is designed to achieve the maximum possible range by transmitting and receiving according to the highest specifications set forth by the FCC. We have rated this phone to operate at a maximum distance with the qualification that the range depends upon the environment in which the telephone is used. Many factors limit range, and it would be impossible to include all the variables in our rating. The Maximum Range rating of this phone is meant to be used as a means of comparison against other range claims.

Telephone Line Problems

The FCC has granted the telephone company the right to disconnect service in the event that your phone causes problems on the telephone line. Also, the telephone company may make changes in facilities and services which may affect the operation of your unit. However, your telephone company must give adequate notice in writing prior to such actions to allow you time for making necessary arrangements to continue uninterrupted service.

If you are having trouble with your telephone service, you must first disconnect your phone to determine if it is the cause of your problem. If you determine that it is the cause, you must leave it disconnected until the trouble has been corrected.

Radio Interference

Radio interference may occasionally cause buzzing and humming in your cordless handset, or clicking noises in the base. This interference is caused by external sources such as TV, refrigerator, vacuum cleaner, fluorescent lighting, or electrical storm. Your unit is NOT DEFECTIVE. If these noises continue and are too distracting, please check around your

home to see what appliances may be causing the problem. In addition, we recommend that the base not be plugged into a circuit that also powers a major appliance because of the potential for interference. Be certain that rise the antenna to a vertical position when needed.

In the unlikely event that you consistently hear other voices or distracting transmissions on your phone, you may be receiving radio signals from another cordless telephone or other source of interference. If you cannot eliminate this type of interference, you need to change to a different channel.

Finally, it should be noted that some cordless telephones operate at frequencies that may cause interference to nearby TVs and VCRs. To minimize or prevent such interference, the base of the cordless telephone should not be placed near or on top of a TV or VCR. If interference is experienced, moving the cordless telephone farther away from the TV or VCR will often reduce or eliminate the interference.

More Than One Cordless Telephone

If you want to use more than one cordless telephone in your home, they must operate on different channels. Press the channel key to select a channel that provides the clearest communication.

Cordless Telephone Privacy

Cordless telephones are radio devices. Communications between the handset and base of your cordless telephone are accomplished by means of radio waves which are broadcasted over the open airways. Because of the inherent physical properties of radio waves, your communications can be received by radio receiving devices other than your own cordless telephone unit. Consequently, any communications using your cordless telephone may not be private.

At Uniden, we'll take care of you!

If you need any assistance with this product, please call our Customer Hotline at

1-800-297-1023

PLEASE DO NOT RETURN THIS PRODUCT TO THE PLACE OF PURCHASE.

Our Uniden representatives will be happy to help you with any matters regarding the operation of this unit, available accessories, or any other related matters.

Thank you for purchasing a Uniden product.
Hours: M-F 7:00 AM to 7:00 PM CST.

A World Without Wires | **Uniden**[®]

Covered under one or more of the following U.S. patents:

4,511,761	4,523,058	4,595,795	4,797,916	5,381,460	5,426,690
5,434,905	5,491,745	5,533,010	5,574,727	5,650,790	5,660,269
5,661,780	5,663,981	5,671,248	5,717,312	5,754,407	5,768,345
5,787,356	5,838,721	5,864,619	5,893,034	5,912,968	5,915,227
5,929,598	5,930,720	5,960,358	5,987,330		

© 2001 Uniden America Corporation, Fort Worth, TX
All rights reserved.

Printed in China
UCZZ01309ZZ

Free Manuals Download Website

<http://myh66.com>

<http://usermanuals.us>

<http://www.somanuals.com>

<http://www.4manuals.cc>

<http://www.manual-lib.com>

<http://www.404manual.com>

<http://www.luxmanual.com>

<http://aubethermostatmanual.com>

Golf course search by state

<http://golfingnear.com>

Email search by domain

<http://emailbydomain.com>

Auto manuals search

<http://auto.somanuals.com>

TV manuals search

<http://tv.somanuals.com>