



Model APS-620N Installation Manual

**This Remote Start System is designed to be used with
Automatic Transmission- Fuel Injection Vehicles Only!**

COMPONENTS:

Control Module	2 Pin Door Lock/Unlock Harness
2 Four Button RF Transmitters	3 Pin Parking Light/Ground Harness
Antenna/Receiver	2 Pin LED Assembly
1 1" X 1.75" Foam Pad	2 Pin Push-Button Valet/Program Switch
6 Pin Main Power Harness	3 Pin Antenna Receiver Harness
7 Pin Accessory Harness	4 Pin Auxiliary Output Harness
1 Hood Pin Switch	Installation/Owners Guide

FEATURES:

Selectable Ignition Lock & Unlock
Selectable Door Lock/Unlock Output Timing
Safe Start (Requires double push of the start button to engage the remote start function)
On Board Parking Light Relay
Trunk Release Output
Horn Chirp Output With Selectable Duration
Selectable RF Start Chirp
Car Finder Mode (Can elect to have horn beep along with parking lights if connected)
Selectable Run Times 5, 10, 15, or 20 Minutes
Selectable Gas or Diesel
Automatic Start Timer (Can be set to start your car automatically at 2 or 4 hour intervals)
4 Negative Pulsed Aux Outputs Before Start, After Start, During Crank, After Shut Down
(To aid installation in many vehicles with factory alarm systems)

FCC NOTICE

This device complies with part 15 of the FCC rules. Operation of this device is subject to the following conditions:

- (1) This device may not cause harmful interference, and
- (2) This device must accept any interference received, including interference that may cause undesired operation.

Caution: Changes or modifications not expressly approved by the party responsible for compliance voids the users authority to operate this device.

INSTALLATION OF THE MAJOR COMPONENTS:

CONTROL MODULE:

Select a mounting location inside the passenger compartment (up behind the dashboard). The mounting location selected must be within 24" of the ignition switch wiring harness to allow connection of the 6 pin main wiring harness.

Be certain that the chosen location will not interfere with proper operation of the vehicle. Avoid mounting the module to or routing the wiring around the steering shaft/column, as the module or wiring may wrap around or block the steering wheel preventing proper control of the vehicle. Secure the module in the chosen location using cable ties or screws as necessary.

Do Not Mount The Module In The Engine Compartment, as it is not waterproof.

DASH MOUNTED LED:

The small LED included in the kit will serve as a visual indicator of the system's status and provide a visual deterrent to a potential thief. The LED also provides important feedback information during the transmitter and feature program modes. The LED should be installed in the dash in an area highly visible so that it may be seen from the driver's seat as well as from outside the vehicle. Inspect behind the chosen location to insure that the drill will not penetrate any existing factory wiring or fluid lines. Carefully drill a 1/4" hole in the desired location and pass the connector end of the LED through the hole and toward the control module. Press the LED firmly into place until it is fully seated in the mounting hole.

THE RECEIVER/ANTENNA ASSEMBLY:

The Superheterodyne Receiver Antenna Assembly provided with this unit allows routing from below the dash board for maximum operating range. Choose a location above the belt line (dashboard) of the vehicle for best reception. Special considerations must be made for windshield glass as some newer vehicles utilize a metallic shielded window glass that will inhibit or restrict RF reception. In these vehicles, route the antenna toward a rear window location for best reception. Secure the antenna with double stick tape provided. After securing the antenna with tape, we advise also securing a section of the antenna cable to a fixed support. This will prevent the antenna from dropping down in case the double stick tape is exposed to extreme heat which may loosen its gummed surface. Route the connector toward the control module using caution not to pinch the cable as this will cause poor or no RF reception to the control module.

VALET/PROGRAM/MANUAL OVERRIDE SWITCH :

Select a mounting location that is easily accessible to the operator of the vehicle. It is not necessary to conceal the switch. However, concealment is recommended as it offers a higher level of security. The switch can be mounted to the lower dash panel in the driver's area. Inspect behind the chosen location to insure that adequate clearance is allowed for the body of the switch, and also that the drill will not penetrate any existing factory wiring or fluid lines. Drill a 9/32" hole in the desired location and mount the switch by passing it through the panel from the underside. Secure the switch using the nut, star washer. Route the switch's connector toward the control module.

NOTE: During the program sequence, there are times when this switch and the ignition switch will be used simultaneously. We recommend that the pushbutton switch be mounted on the left side of the ignition switch to facilitate this operation.

HOOD PIN SWITCH:

The pin switch included in this package are intended for protecting the hood area of the vehicle. In all cases, the switch must be mounted to a grounded metal surface. When the pin switch is activated, (hood/trunk open), it will supply a ground to the input wire activating the alarm. In addition, the hood switch is required for the safety shut down of

the remote start unit. If the vehicle is being worked on, this hood switch prevents the remote start activation even if the RF command to start is issued. **This switch must be installed in all applications. Failure to do so may result in personal injury or property damage.**

Mount the switch in the hood locations away from water drain paths. If necessary, a bracket may be used to move the switch away from rain gutters or allow mounting to the firewall behind the hood seal. In both cases the switch must be set up to allow the hood to depress the switch at least 1/4 inch when the hood is closed and fully extended when the hood is opened. For direct mounting, a 1/4 inch hole must be drilled. Carefully check behind the chosen location to insure the drill will not penetrate any existing factory wiring or fluid lines.

Drill a 1/4" hole in the desired location and thread the pin switch into it using a 7/16" nut driver or deep well socket. If using the mounting bracket, first secure the bracket to the desired location and secure the pin switch in the pre-threaded mounting bracket hole.

DO NOT PLUG THE SIX PIN MAIN POWER HARNESS OR THE MULTI PIN INPUT / OUTPUT HARNESS INTO THE CONTROL MODULE UNTIL ALL CONNECTIONS TO THE VEHICLE HAVE BEEN MADE. AFTER SELECTING YOUR TARGET WIRES AS DEFINED BELOW, DISCONNECT THE NEGATIVE BATTERY CABLE FROM THE VEHICLE BATTERY PRIOR TO MAKING ANY CONNECTIONS.

Note: Do not remove the fuse holders from this wire harness. Fuses must be used and located as close as possible to the power source for adequate protection of the vehicle.

WIRING THE 6 PIN MAIN POWER HARNESS Connector "C":

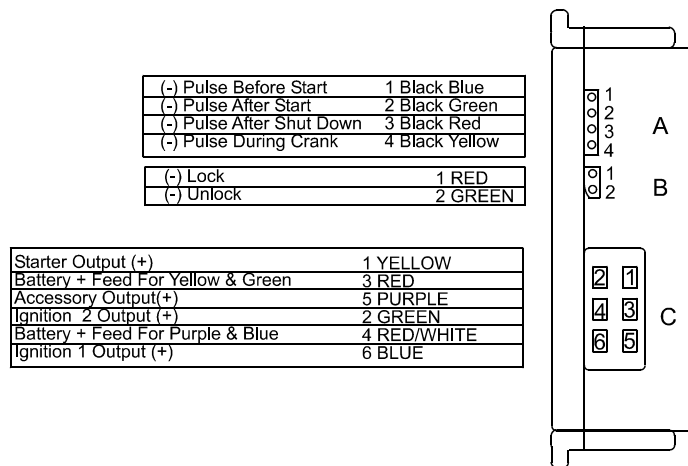

Fused RED w/ WHITE TRACE WIRE: + 12 volt Battery 1 Source 20A Max

Locate the vehicle battery wire(s) at the ignition switch. Verification: These wires will register voltage in all positions of the ignition switch. Connect the Red w/White wire to the vehicle's battery wire. This wire provides power for the control circuit as well as the ignition 1 and ignition 2 relays.

Fused RED WIRE: + 12 Volt Battery 2 Source 20A Max

Locate the vehicle battery wire(s) at the ignition switch. Verification: These wires will register voltage in all positions of the ignition switch. Connect the Red wire to the vehicle's battery wire. This wire provides power for the start relay and the accessory relay.

YELLOW Wire: Starter Output

Careful consideration for the connection of this wire must be made to prevent the vehicle from starting while in gear. Understanding the difference between a mechanical and an electrical Neutral Start Switch will allow you to properly identify the circuit and select the correct installation method. In addition you will realize why the connection of the safety wire is required for all mechanical switch configurations.

Failure to make this connection properly can result in personal injury and property damage. In all installations it is the responsibility of the installing technician to test the remote start unit and ensure that the vehicle cannot start via RF control in any gear selection other than park or neutral.

In both mechanical and electrical neutral start switch configurations, the connection of the Yellow wire will be made to the low current start solenoid wire of the ignition switch harness. This wire will have +12 volts when the ignition switch is turned to the start (crank) position only. This wire will have 0 volts in all other ignition switch positions.

BLUE Wire: Ignition 1 Output

Connect this wire to the ignition 1 wire from the ignition switch. This wire will show +12 volts when the ignition key is turned to the "ON" or "RUN" and the "START" or CRANK" positions, and will have 0 volts when the key is turned to the "OFF" and "ACCESSORY" positions.

GREEN Wire: Ignition 2 Output

Connect this wire to the ignition 2 wire from the ignition switch. This wire will show + 12 volts when the ignition key is turned to the "ON" or "RUN" position and in some cases the "START" or CRANK" position. This wire will show 0 volts when the key is turned to the "OFF" and "ACCESSORY" positions.

NOTE: See programming information (Bank 3 Selection # 6) concerning this wire to allow output during the "START" mode.

VIOLET Wire: Accessory Output

Connect this wire to the Accessory wire from the ignition switch. This wire will show + 12 volts when the ignition switch is turned to the "ACCESSORY" or "ON" and "RUN" positions, and will show 0 volts when the key is turned to the "OFF" and "START" or "CRANK" positions.

Wiring The 2 Pin Door Lock/Unlock Harness Connector "B":

The Red & Green Door Lock/Unlock output wires provide a pulsed ground output to control the vehicle door lock / unlock circuits. The output of these wires has a maximum switching capability of 250 mA. Many vehicles today have factory door lock relays which can be connected directly to these outputs, however always confirm that the factory relays in your particular vehicle do not exceed the rated 250mA output of the units door lock/unlock circuit. Plug the 2 pin connector of the door lock/unlock harness into the mating connector shell of the control module. Determine the door lock circuit of the vehicle you are working on and wire according to the diagrams shown.

3 Wire Ground Switched Door Lock Circuits:

In this application, the Red wire of the 2 pin harness provides a ground pulse during the arming sequence, or pulsed ground lock output. Connect the Red wire to the low current ground signal wire from the factory door lock switch to the factory door lock relay.

The Green wire of the 2 pin harness provides a ground pulse during the disarming sequence, or pulsed ground unlock output. Connect the Green wire to the low current ground signal wire from the factory door unlock switch to the factory door unlock relay.

Negative Type Door Lock Circuits

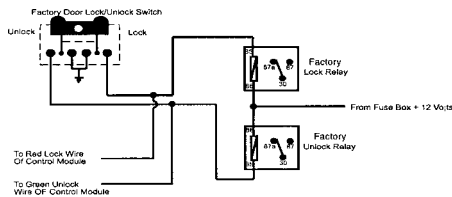

Negative Door Locks More Than 250mA

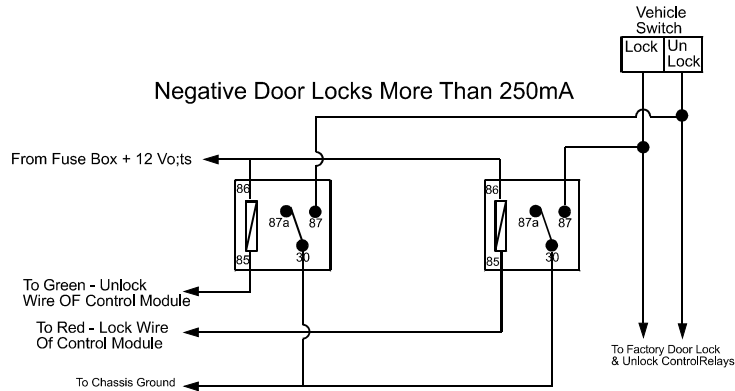

Positive Door Locks

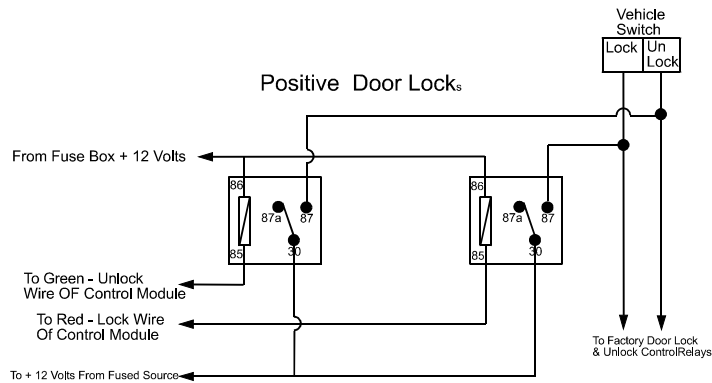

5 Wire Polarity Reversal Door Locks

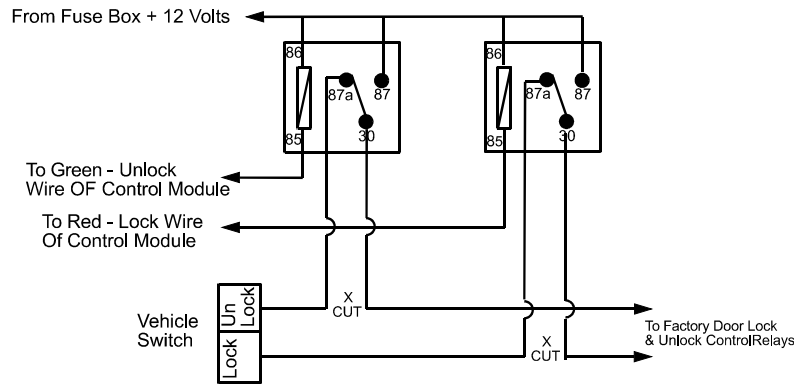

Adding A Door Lock Actuator

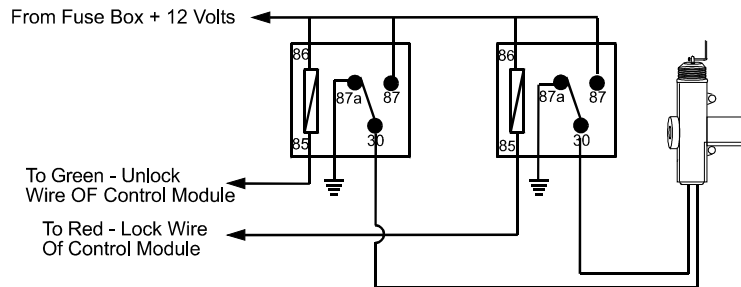

Wiring The 4 Pin Auxiliary Output Harness, Connector "A"

The auxiliary 4 pin connector provides low current outputs to control various functions in the vehicle during different stages of the Remote Start unit's operation. Understanding these outputs and the time in which they occur will allow you to determine if they are needed for the particular vehicle you are working on as well as how to use them.

Black w Blue Trace Wire: Pulsed Ground Output Before Start

The Black w/ Blue Trace wire will provide a 1 second 250 mA pulsed ground output 1.5 second before the remote start unit activates as well as when the transmitter is used to disarm the system. Typical use for this output would be to disarm a factory theft deterrent system to prevent false triggering of the factory alarm when the remote start unit engages or when the transmitter is used to unlock the doors.

Black w/ Light Green Trace Wire: Pulsed Ground Output After Start

The Black w/ Light Green Trace wire will provide a 1 second 250mA pulsed ground output after the vehicle is started under control of the remote start unit. Typically this wire will be used to re-lock the vehicle doors if the doors unlock automatically when the factory anti-theft system is disarmed.

Black w/ Red Trace Wire: Pulsed Ground Output After Shutdown

The Black w/ Red Trace wire will provide a 1 second 250 mA pulsed ground output after the remote start unit shuts down. This output will occur regardless of whether the circuit times out or is manually terminated. Typically this output will be used to re-lock the vehicle doors if the doors unlock automatically when the ignition circuit transitions to off.

Black w/ Yellow Trace Wire: Ground Output During Start (Crank)

The Black w/ Yellow Trace wire will provide a 250 mA ground output while the starter output of the remote start unit is active. This output can be used to activate the Crank Low/Bulb Test wire found in some GM vehicles. This wire is also referred to as the ECM wake up wire in some Chrysler vehicles.

NOTE: The outputs above are low current outputs and must be used with a relay if the circuit's requirement is more than 250 mA.

RF 5V (+)	1 Black/White
RF Data	2 Black
RF Gnd	3 Black
4 Pin Data Port Connector For Use With Proprietary Audiovox Data Bus Modules	
Ground	1 BLK
Valet Enable	2 BLK/WHT or Gray
(+) Shut Down Brake Input	1 Brown/Black
(-) Shut Down Hood Input	2 Gray/Black
Lock or Injector Input	3 Green/Orange
(-) 3rd Channel Output	4 Blue
(-) Horn Output	5 Black/White
(-) Gnd While Running Output	6 Light Blue
(-) Dome Light Output	7 Green/White
LED (-)	1 Blue
LED (+)	2 Red
Park Light Output	1 White
Park Light Input (15A Max)	2 White, Red
Ground	3 Black

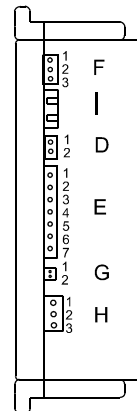

2 Pin Valet/Program/Override Push-Button Switch, Connector “D”

The Black & Grey twin lead wires loaded in the two pin blue connector are the ground supply and program/valet/override input of the Remote Start unit. Route the two wires from the previously installed Push-Button switch to the mating connector on the control module.

3 Pin Antenna/Receiver, Connector "F"

Route the 3 pin connector from the previously installed antenna receiver assemble to the mating connector on the control module. This connector supplies 5 volts, ground and RF data from the antenna receiver to the remote start module. Be certain this connector is firmly seated making good contact to the control unit.

2 Pin LED Harness, Connector "G"

Route the twin lead Red and Blue wires from the LED to the remote start control unit and plug the two pin connector into the mating white mini connector on the control module. these wires control the anode and cathode of the dash mounted LED.

3 Pin Parking Light Input/Output & Ground Harness, Connector "H"

Black Wire: Chassis Ground Source

Connect the Black wire to a known vehicle ground source or to a solid clean metal part of the chassis. Be certain to remove any paint or grease and secure this wire with a self tapping screw and ring terminal.

White w/ Red Trace Wire: Parking Light Flasher Feed

This wire is the common contact of the on board parking light flasher relay. If the vehicle you are working on has +12 volt switched parking lights, connect this wire to a fused + 12 volt source. (Max. 15 Amps)

NOTE: If the vehicle's parking lights are ground switched, connect this wire to chassis ground.

White Wire: Parking Light Flasher Output

This wire is the normally open contact of the on board parking light flasher relay. Connect this wire to the vehicle parking light feed wire.

7 Pin Accessory Input/Output Harness, Connector "E"

Brown w/ Black Trace Wire: Positive Inhibit Input

The Brown w/ Black Trace wire provides an instant shutdown for the Remote Start Control module whenever it gets + 12 volts. If the Brake lights switch in the vehicle switches + 12 volts to the brake light circuit, connect the Brown w/ Black trace wire to the output side of the brake switch. This will allow the Remote Start to shut down if an attempt is made to operate the vehicle without the key while running under the control of the Remote Start. In most vehicles, in order to shift into gear, the brake pedal must be depressed. The brake input will in turn cause the remote start unit to shut off.

Grey w/ Black Trace Wire: Negative Inhibit Input

The Grey w/ Black Trace wire provides an instant shutdown for the Remote Start Control Module whenever it is grounded. Connect the Grey w/ Black trace wire to the hood pin switch previously installed. This wire must be routed through a grommet in the firewall and connected to the hood pin switch. If the pin switch is to be used with an alarm system, connect this wire using a diode assembly.

DO NOT RELEASE THIS VEHICLE TO THE CONSUMER UNTIL YOU CONFIRM THE OPERATION OF THE HOOD PIN SAFETY SHUT DOWN FEATURE.

IMPORTANT! This connection is a safety wire and must be connected to a hood pin switch and tested as described. Failure to do so may result in personal injury or property damage. This wire may also be used if the vehicle brake light circuit switches ground to the brake lights. An isolation diode must be used for ground switched brake light circuits and must be connected to the output of the brake switch.

To test this circuit, while the vehicle is running under control of the remote start unit, open the vehicle's hood. The remote start unit should shut down immediately. If not, check the wiring to the control module and the under hood pin switch.

DO NOT RELEASE THE VEHICLE TO THE CONSUMER IF THIS CIRCUIT DOES NOT PERFORM AS SPECIFIED.

Green w/ Orange Trace Wire: Tachometer Input Signal

This wire will continually monitor the engine's tach rate while the unit is under power of the Remote Start module. This wire will be routed to the vehicle ECM tach input or through the firewall into the engine compartment and connect to the negative side of the ignition coil. This Remote Start unit learns the tach rate of the vehicle and in most cases will operate properly from one multi coil pack regardless of the number of cylinders. If the vehicle has a single coil unit for each cylinder, it may be necessary to connect this wire to more than one cylinder for proper tach reference. See multi coil wiring detail below.

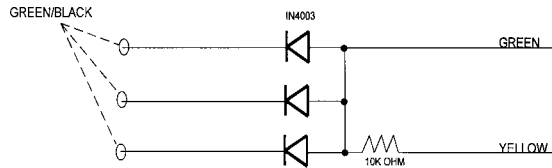

IF THE FIRING ORDER IS 1,5,6,3,4,2,7,8

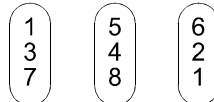

CONNECT TO CYLINDERS 1,3,7 OR 5,4,8 OR 6,2,1

IF THE FIRING ORDER IS 1,8,4,3,6,5,7,2

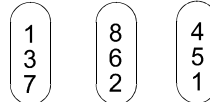

CONNECT TO CYLINDERS 137, OR 862, OR 451

Dark Blue Wire: Delayed 250mA Pulsed Channel 3 Output

The Dark Blue wire supplies a 250mA ground pulsed output whenever channel three of the receiver is accessed. Pressing the pre-programmed transmitter button for three seconds will access channel two. This is a low current output and must be connected to a relay to supply power to the trunk release or the circuit you wish to control. Connect the Dark Blue wire to terminal # 86 of a VF45F11 P&B relay or equivalent. Connect terminal # 85 of the relay to a fused + 12 volt source. Connect the common, normally open, and normally closed contacts of the relay to perform the selected function of channel 3.

Black w/ White Trace Wire : 250 mA Horn Output

The black w/ white trace wire is provided to beep the vehicle's horn. This is a transistorized low current output, and should only be connected to the low current ground output from the vehicle's horn switch. If the vehicle uses a + 12 VDC horn switch, then connect the black w/ white trace wire to terminal 86 of the AS 9256 relay (or an equivalent 30 Amp automotive relay), and connect relay terminal 85 to a fused + 12 VDC battery source. Connect relay terminal 87 to the vehicle's horn switch output, and connect relay terminal 30 to a fused + 12 VDC battery source.

Light Blue Wire: Ground Output While Running Under Remote Start Control

This wire provides a 300mA ground output that becomes active 3 seconds before the Remote Start Unit initializes and remains grounded while running plus an additional 4 seconds after the Remote Start Unit turns off. In all of the applications described below, a relay will be required.

The Light Blue wire can be used to accommodate the following situations:

A. Shock Sensor By Pass:

B. Additional Ignition Output:

C. GM VATS Key Override:

Green w/ White trace Wire: Entry Illumination Ground Output

This wire provides a 30 second ground output (300 mA Max.) whenever the remote is used to disarm the alarm or to unlock the doors and provides a continuous pulsed output whenever the alarm is triggered. This wire should be connected to an external relay and wired to the vehicles interior entry lighting whenever the optional Interior Illumination circuit is desired.

Programming Tach Rate:

NOTE: All applications require that tach be programmed.

The unit will not operate unless tach is programmed. If an attempt is made to start the vehicle via the remote start without first programming tach, the unit will flash the parking lights 7 times indicating tach has not been learned and stored. If the tach rate is not properly programmed to the specific vehicle, the unit may not realize that the vehicle is running in certain instances reengage the starter motor.

The Remote Start Unit will learn the tach rate of most vehicle's single coil, multiple coil packs, or single injector. To learn tach:

1. Turn the ignition key to the On position.
2. Press and release the valet/program push button switch 3 times.
3. Immediately turn the ignition key Off.
4. Press and hold the valet/program push button switch, then start the vehicle using the key.
5. When the unit senses the tach signal, the parking lights will begin to flash.
6. Release the valet/program pushbutton switch. The parking lights will turn on for three seconds to indicate that the learned tach signal is stored and the unit is out of the tach learn mode.

NOTE: If the unit fails to learn tach rate due to an improper tachometer connection or a poor tach source, the parking lights will not flash. To correct this situation, locate and connect the Green/Orange wire to the proper tach signal, and then repeat the tach learn routine.

Diagnostics:

Enter Bank 3 and turn on selectable feature # 7 as described in the feature selection and setting section.

Exit the feature selection mode then press and hold the pushbutton valet/program switch and then turn the ignition switch to on position.

NOTE: Diagnostic mode is a temporary mode. Once you have accessed the diagnostic mode, the unit will pause for two seconds then begin to flash the last stored shut down code. This code will be displayed three times in succession, then the unit will automatically exit the diagnostic mode.

The parking lights will flash a number of times indicating the reason for the last remote start shutdown. The light flash indications are as follows:

- | | |
|-----------|--|
| 1 Flash | Run timer expired |
| 2 Flashes | Low or no tach signal (RPM) |
| 3 Flashes | Positive inhibit wire activation |
| 5 Flashes | RF shutdown signal received, or manual start trigger wire reactivated. |
| 6 Flashes | High tach signal (RPM) |
| 7 Flashes | Tach signal has not been learned |
| 8 Flashes | Negative inhibit wire activation |

Setting Up The System Programming Features:

Bank 1 Transmitter Channels

Start with the system disarmed, turn the ignition switch to the on position then:

1) Press and release the push button valet/program switch 3 times.

Siren Chirps once and or Lights flash one time indicating the transmitter program mode successfully entered.

See Owners Manual for transmitter programming.

Turn the ignition switch off then on to access Bank 2 Keyless/Alarm feature selections.

1 Flash when the ignition transitions off, followed by 2 chirps/Light flashes when the key is turned on indicates that you are in feature selection of bank 2.

Press the pushbutton switch:

1 time to access the first selection as shown below. Use the lock button of the transmitter to change the feature selection or press the pushbutton to advance to the next selectable feature.

Bank 2

Feature	1 Chirp/Flash	2 Chirp/Flash	3 Chirp/Flash	4 Chirp/Flash	5 Chirp/Flash	6 Chirps/Flash	Default
1stDoor Lock/UL	1S/1S	3.5 S/3.5S	1 S/Dbl 1 S.	Dbl 1/1 S	Dbl 1/Dbl 1	1S L/350mS ul	1S/1S.
2nd Accy Lock	Auto Lock On	Auto Lock Off					Auto Lock Off
3rd Accy. UL	Auto UL On	Auto UL Off					Auto UL Off
4th Horn Chirp	10mS	16mS	30mS	40mS	50mS		16mS
5 th Chp Del TX	On	Off					Off

When finished setting the keyless/alarm selectable features, turn the ignition off then on to advance to Bank 3, Remote Start Selectable Features.

1 Flash when the key transitions off and 3 chirps/light flashes when the key transitions on.

Press the pushbutton switch one time to access the first selection as shown below. Use the lock button of the transmitter to change the feature selection or press the pushbutton to advance to the next selectable feature.

Bank 3

Feature	1 Chirp/Flash	2 Chirp/Flash	3 Chirp/Flash	4 Chirp/Flash	5 Chirp/Flash	6 Chirps/Flash	Default
1 RF Start Chirp	Off	On					On
2 Run Time	5 Min.	10 Min.	15Min.	20 Min.			10 Min
3 Park Lights	On Steady	Flash					Steady
4 Input Check	Voltage	Tach	DBI Tach				Tach
5 Voltage Level	> 0.5V B4 Start	< 0.5V B4 Start					> 0.5
6 Ign. 2 Select	Off With Crank	On With Crank	Same As Accy				On With Crank
7 Diagnostics	Off	On					Off
8 Crank Time	0.8Sec	1.0 Sec	1.5 Sec	2.0 Sec			1.0
9 Gas/Diesel	Gas	Diesel 10	Diesel 15	Diesel 20			Gas
10 Blk/Blue (Aux O/P)	Single Pulse	As D/L Pulse					Single
11 Time Start	2 Hours	4 Hours					4 Hours

4 PIN IN VEHICLE DATA BUS PORT (DBI Port)

The 4 pin port located on the side of this module is for proprietary Audiovox data bus interface modules. These modules are used to access a variety of features in the vehicle which can be as simple as door trigger inputs, to more complex door locks outputs, or transponder interfaces for remote starting. DO NOT connect anything to this port other than the Audiovox IDB modules or damage to the Remote Start module will occur. All installation instructions for the IDB modules will be packaged with the individual component along with the proper 4 pin wiring harness requires to access the data transmit & receive as well as the proper voltage levels for the interface.

COMPLETING THE INSTALLATION:

After you have confirmed the operation of the Audiovox Remote Start unit and tested all the safety features of the system:

1. Mount the control module up and behind the dash securing it in place with cable ties or screws. Be certain that the chosen mounting location will not inhibit any of the controls of the vehicle.
2. Securely harness and tie all wiring up and away from all hot and moving parts that they may come in contact with under the dash board or in the engine compartment areas.

CAUTION: Particularly avoid the area around the steering shaft and column, as wires can wrap around these mechanisms and impair the safe operation of the vehicle.

3. Apply the Caution Labels supplied with this kit to a conspicuous area in the engine compartment. Make sure to clean the surface before affixing the label.
4. Check the vehicle's wipers, lights, horn, etc.... to insure proper operation.
5. Replace all panels that were removed during installation, and retest the system.
6. Explain all activated features and safety systems associated with Remote Start Unit installed to the customer.
8. Place the Remote Start / Valet Control Switch Tag on their respective switches and point these out to the customer.

Free Manuals Download Website

<http://myh66.com>

<http://usermanuals.us>

<http://www.somanuals.com>

<http://www.4manuals.cc>

<http://www.manual-lib.com>

<http://www.404manual.com>

<http://www.luxmanual.com>

<http://aubethermostatmanual.com>

Golf course search by state

<http://golfingnear.com>

Email search by domain

<http://emailbydomain.com>

Auto manuals search

<http://auto.somanuals.com>

TV manuals search

<http://tv.somanuals.com>