

Use and Care

Use and Care

In normal daily use, the TERK SIR6 Outdoor Home Antenna is a rugged, high-performance antenna that does not require any special attention.

Troubleshooting

Symptom	Solutions
SIRIUS radio displays "Antenna Error" or "Check Antenna" message	Check antenna connections to the SIRIUS receiver and splitter if using a dual input receiver.
SIRIUS radio displays "No Signal" or "Acquiring Signal" message	The satellite signal maybe obstructed by a structure, trees or located in the wrong location. Please refer to "Placing the Antenna" on page 3.
Other symptoms	Call TERK for help at 1-800-942-TERK (8375) on any business day, between 9 a.m. and 5:30 p.m., EST and ask for Technical Support.

Limited Warranty

TERK Technologies Corp. (TERK) warrants this product against defects in materials or workmanship for one (1) year from the date of purchase. During this warranty period, this product will be replaced without charge. This warranty does not cover any damage due to acts of nature, commercial use, accident, misuse, abuse or negligence. This warranty is only valid in the USA. Replacement as provided under this warranty is the exclusive remedy of the consumer. TERK shall not be liable for any incidental or consequential damages for breach of any express or implied warranty on this product, except to the extent that limitations of this sort are prohibited by applicable law.

THERE ARE NO IMPLIED WARRANTIES OF MERCHANTABILITY OR FITNESS FOR A PARTICULAR PURCHASE EXCEPT TO THE EXTENT THAT IMPLIED WARRANTIES OF EITHER SORT ARE REQUIRED BY APPLICABLE LAW, AND IN SUCH CASE, EACH WARRANTY IS LIMITED IN DURATION TO ONE YEAR.

About SIRIUS Satellite Radio
For more information about SIRIUS Satellite Radio service, visit www.Siriusradio.com

To activate your Sirius service
please call 1-888-539-7474

SIR6

Owner's Manual



For more information, visit www.terk.com or
for technical support, call 1.800.942.TERK(8375)

117P006A

TERK is a registered trademark. The TERK Logo is a trademark of TERK Technologies Corp.

SIR6

Outdoor Satellite Radio Home Antenna

TERK

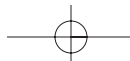

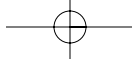

Table of Contents

SIR6

- About Installation 2
- Introduction 2
- Applications 2
- Box Contents 3
- Placing the Antenna 3
- Installation 4
- Adjustments 6
- Cable Installation 6
- Specification 7
- Use and Care 8
- Troubleshooting 8
- Limited Warranty 8
- About SIRIUS Satellite Radio 8

About Installation

Installation of antennas can require extensive experience with a variety of mechanical and electrical procedures. Although the instructions in this guide explain how to install the TERK SIR6 Outdoor Satellite Radio Home Antenna in a general sense, they do not show the exact installation methods for every home and/or building.

IMPORTANT: If you are not comfortable performing a complex installation, you may want to seek a professional for installation.

Introduction

The TERK SIR6 Outdoor Satellite Radio Home Antenna is a high-performance antenna designed specifically for SIRIUS home receivers and SIRIUS Plug & Play systems.

The package includes all the necessary mounting hardware, to attach to a wall, roof or mast on your home or building. Remember to save your sales receipt and this guide so both are available for future reference.

NOTE: To achieve best SIRIUS Satellite Radio reception, also refer to your SIRIUS radio owner's manual.

Applications

The TERK SIR6 Outdoor Satellite Radio Home Antenna can be installed on a variety of homes and buildings in a number of different mounting options as shown in the installation section on pages 4 and 5.



Box Contents

SIR6

Parts for the TERK SIR6 Outdoor Satellite Radio Home Antenna

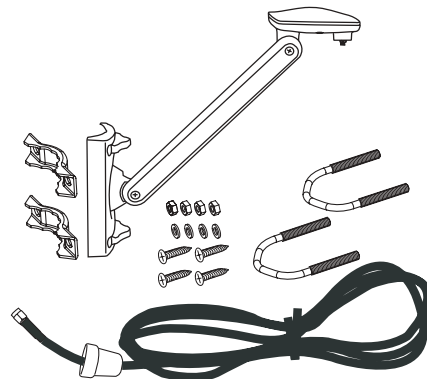

- 1 SIR6
- 1 30' cable
- 2 U-bolts, 2 mount brackets, 4 washers, 4 nuts
- 4 (#10) screws

Verify that your TERK SIR6 package includes the above items

Placing the Antenna

For best reception of the satellite signal, it is important to make sure the antenna is mounted in the proper location on your house and facing the correct direction towards the satellites.

Due to the paths of SIRIUS satellites over the US, the best location for the antenna will depend on what part of the country you live in, the orientation of your home, and the locations of any obstructions that could prevent the satellite signal from reaching the antenna. Use the map shown below as a general placement guide for your antenna. The location of the "X" on the map must be visible to the antenna. It is recommended that, before mounting the antenna, you hold the antenna in the desired mounting location with the SIRIUS system set-up and on to make sure that the system works with the antenna in that location. You may need to try several locations to determine the optimal mounting spot. Once this has been determined, please proceed to installation. When facing the antenna towards the satellites, face the side of the antenna that has the TERK logo on it; this is the front of the antenna.

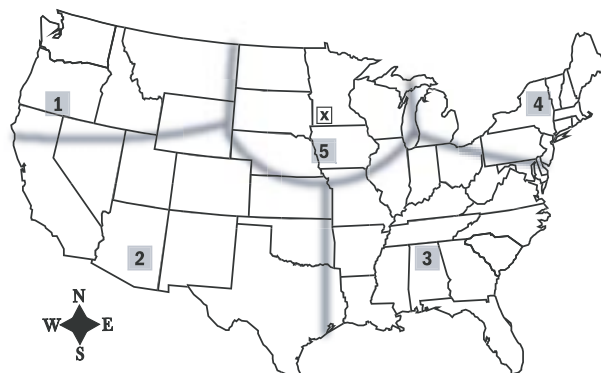

2

3

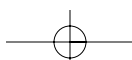

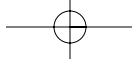

Placing the Antenna

SIR6

- Section 1: Antenna should be mounted facing EAST or NORTHEAST
- Section 2: Antenna should be mounted facing NORTH or NORTHEAST
- Section 3: Antenna should be mounted facing NORTH or NORTHWEST
- Section 4: Antenna should be mounted facing WEST or NORTHWEST
- Section 5: Place the antenna ONLY ON THE ROOF or MAST ON THE ROOF

NOTE: To achieve best SIRIUS Satellite Radio reception, also refer to your SIRIUS radio owner's manual.

Installation

Now that you have determined where to place the antenna, you have three different mounting options. Each option is described below.

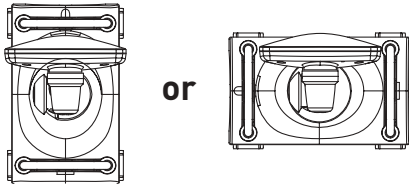

Wall Mount

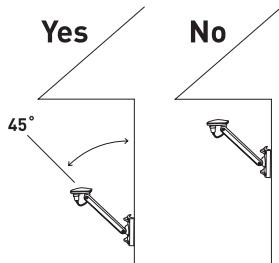

We recommend mounting the bracket horizontally if mounting to a non-flat surface like vinyl siding. Once the mounting location has been determined, take a pencil and mark through the bracket, onto the house wall, the four screw locations. Then set the mounting bracket down and pre-drill holes in the four locations you just marked (drill bit size 3/32 is recommended with #10 screws). Position the mounting bracket over the four pre-drilled holes and screw in the top two #10 screws, that are included with this package through the mounting bracket into the wall of the house. Then screw in the bottom two. At this point, move onto the Adjustment section of the owner's manual on page 6.

Roof Mount

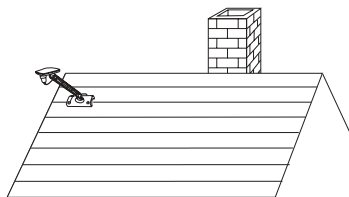

4



Installation

SIR6

We recommend mounting the bracket vertically on a roof as high up as possible as shown on page 4. The antenna should not be blocked by an obstruction like trees or a chimney. Once you have determined your mounting location, place the mounting bracket on that location on the roof. Take your drill and pre-drill holes, using a 3/32 drill bit, through the top two holes on the mounting bracket. Screw in two of the #10 screws included with this package, through the mounting bracket into the pre-drilled holes in the roof. Repeat this step for the bottom two holes. At this point, move onto the Adjustment section of the owner's manual on page 6.

Mast Mount

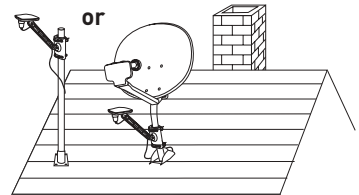

The SIR6 can be mounted to most masts. We recommend mounting the antenna to a mast on the roof or on the mast of a satellite TV dish. You will need the 2 U-bolts, 2 mount brackets, 4 washers and 4 nuts for this installation. Once you have determined where on the mast you wish to mount the antenna, place the mounting bracket in that location against the mast. Put one of the U-bolts through the top two holes on the mounting bracket. Take one of the mount brackets and insert it through the two ends of the U-bolt on the other side of the mast. Make sure the inside of the curve of the mount bracket is towards the mast. Using one hand to hold the mounting bracket, U-bolt and U-bolt bracket take your other hand and place one washer and nut on one end of the U-bolt, then turn the nut four or five complete rotations and then place one washer and nut on the other end of the U-bolt, turn the nut four or five complete rotations. Make sure the mounting bracket is in the desired location and tighten both nuts until the mounting bracket is secure on the mast. Repeat these steps for the second U-bolt. Once complete, move to the Adjustment section of the owner's manual on page 6.

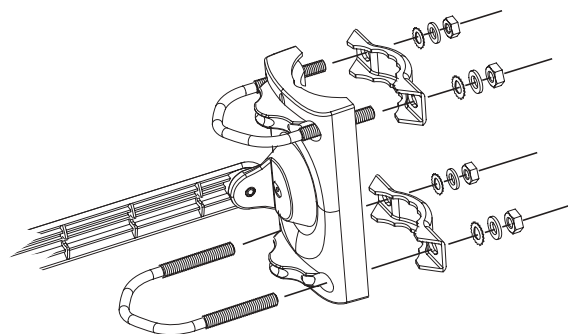

5

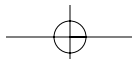

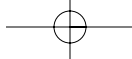

Adjustments

SIR6

There are three areas of adjustments on the antenna, antenna arm and mounting bracket. Please use these areas to adjust the antenna so that it is level. You will have to loosen the Phillips screws to rotate and adjust. Once the adjustment has been made to the desired position, tighten the Phillips screw. Be careful not to over tighten. We recommend that you make the adjustments, if needed, to each area in the order that is shown below.

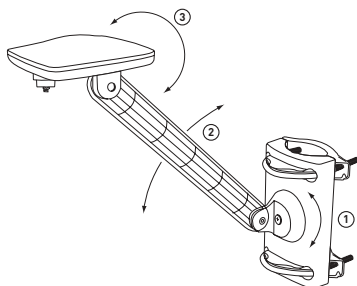

Cable Installation

At this point you are ready to attach the cable. The connectors at each end of the cable are different. Find the connector that has the threads on the inside, then screw this connector onto the bottom of the antenna as shown below. Screw the connector on by hand as far as it can go. It is not necessary to use any special tools for this.

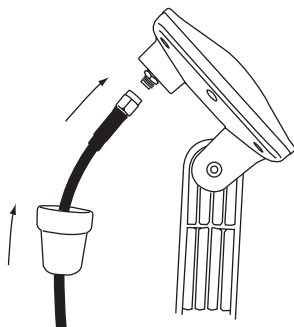

Once the cable is secured onto the antenna, slide the attached rubber bottom onto the antenna as shown. Uncoil the remaining cable. On one side of the mounting bracket arm is a cable track with five cable clips. For improved cable routing, snap the cable into the cable clips as shown below.

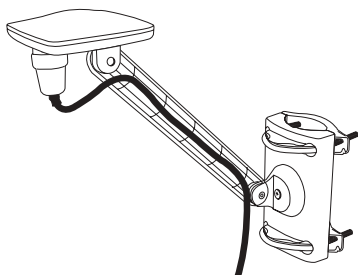

6



Cable Installation

SIR6

At this point, please determine the best way to route the rest of the cable into your home to the SIRIUS home receiver or SIRIUS Plug & Play system. If the included cable is not long enough to reach your receiver, you will have to purchase a TERK 50' extension kit (SIR-EXT50)-sold separately.

Specifications

Electrical Specifications

Antenna	
Frequency:	2320 to 2332.5 MHz
Gain:	1 dBic, 45°-90° elevation
Bandwidth:	12.5 MHz
Impedance:	50 ohms
Polarization:	LHCP (Circular)

LNA	
Gain:	42 dB, typical
Noise Figure :	0.7 dB, typical
Current Drain:	160 mA, maximum

Mechanical Specifications

Antenna Dimensions:	
Radome:	3 1/4" x 3 1/4" x 8"
Arm Length:	4 3/4" x 2 7/8"
Mounting bracket:	
Material:	Xenoy and AES

Cable Type:	RG-58 coaxial
Cable Length:	30 feet

Connectors Antenna:	SMA
Connectors Cable:	SMA and SMB

Mounting Hardware	
Nuts and Washers:	Stainless Steel
Screws and U-Bolts:	Stainless Steel
Weight including cable:	1.75 lbs

Other Specifications

Temperature:	-40 °F to +185 °F, operating
--------------	------------------------------

Quality and Performance Tests

SIRIUS Approved:	Per Specification RX000002H-010000
TERK Approved:	Per Environmental Specification TERK TRK- 10011-SIR6

7

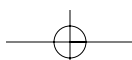

Free Manuals Download Website

<http://myh66.com>

<http://usermanuals.us>

<http://www.somanuals.com>

<http://www.4manuals.cc>

<http://www.manual-lib.com>

<http://www.404manual.com>

<http://www.luxmanual.com>

<http://aubethermostatmanual.com>

Golf course search by state

<http://golfingnear.com>

Email search by domain

<http://emailbydomain.com>

Auto manuals search

<http://auto.somanuals.com>

TV manuals search

<http://tv.somanuals.com>