

XMp3i

ADDITIONAL HOME KIT

User Guide



SIRIUS  | **((XM))**
S A T E L L I T E R A D I O

Table of Contents

Introduction	5
Features	6
Safety and Care Information	7
What's in the Box?	8
Home Dock	9
Remote Control Functions	10
Home Installation	11
Step 1: Connect the Home Dock	12
Step 2: Install the Indoor/Outdoor Home Antenna	16
Troubleshooting	21
Product Specifications	25
Patent Information	27
Environmental Information	27

Introduction

Features

Congratulations on your purchase of the XMp3i™ Additional Home Kit!

Your new Home Kit lets you play your XMp3i™ or Pioneer XMp3™ Radio through another stereo system or a set of powered speakers.

- **Add Satellite Radio to another room:** No need for a second subscription. Just connect this Kit with another stereo system or set of powered speakers - in the den, the kitchen, a bedroom, or at the office - and then simply move your Radio between the two.
- **Listen with any system:** Works with any stereo system or set of powered speakers that have audio input jacks.
- **Easily change channels and volume:** Included Remote Control lets you turn your XMp3i™ Radio on or off, change channels, adjust the volume, and more, even from across the room.
- **Stay charged:** Charges your Radio while you listen.

And for the latest information about this and other SIRIUS|XM products and accessories, visit xmradio.com or your favorite retailer.

Please read the entire User Guide before installing your Home Kit!

Safety and Care Information



IMPORTANT! Always read and understand all the instructions to avoid injury to yourself and/or damage to your device. SIRIUS XM Radio Inc. disclaims all responsibility for damage from data loss due to breakdown, repair, or other causes.

- Do not expose to extreme temperatures (above 140°F or below -4°F, or above 60°C or below -20°C).
- Do not expose to moisture. Do not use device near or in water. Do not touch the device with wet hands.
- Do not let any foreign matter spill into device.
- Do not store in dusty areas.
- Do not expose to chemicals such as benzene and thinners. Do not use liquid or aerosol cleaners. Clean with a soft damp cloth only.
- Do not expose to direct sunlight for a prolonged period of time, and do not expose to fire, flame, or other heat sources.
- Do not try to disassemble and/or repair device yourself.
- Do not drop your device or subject it to severe impact.
- Do not place heavy objects on device.
- Do not subject device to excessive pressure.

WARNING!

- Opening the case may result in electric shock.
- Make sure that you insert the Home Power Adapter's plug all the way into the outlet.

Introduction

What's in the Box?

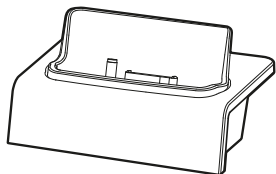

Home Dock

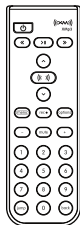

Remote Control

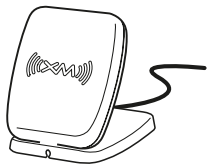

Indoor/Outdoor
Home Antenna

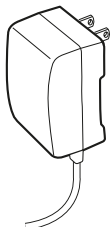

Home Power
Adapter

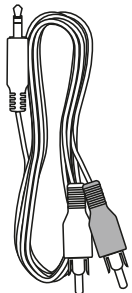

Stereo Audio
Cable

Home Dock

Color-Coded Connections

The Color-Coded Home Dock makes it simple to connect.

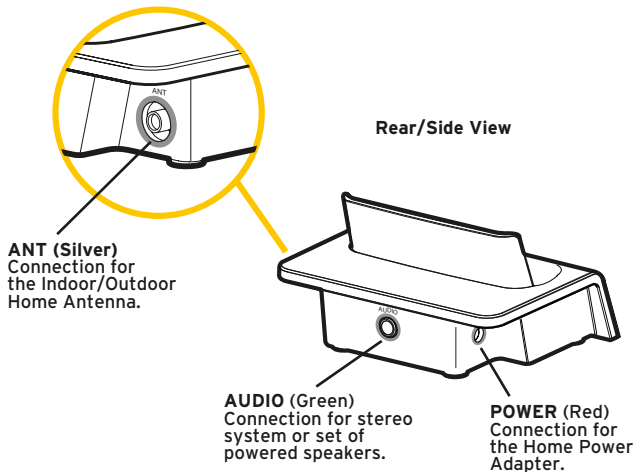

Remote Control Functions

Power Button

30-Minute Replay Buttons
Pause and replay up to 30 minutes of Satellite Radio programming.

Select Button
Press to confirm highlighted selections.

Menu
Go to Satellite Radio, My Music Library, Auto Recordings, or Settings.

Number Keys
Enter a channel number directly to tune to the channel.

Jump
Switches between current channel and previously tuned channel.

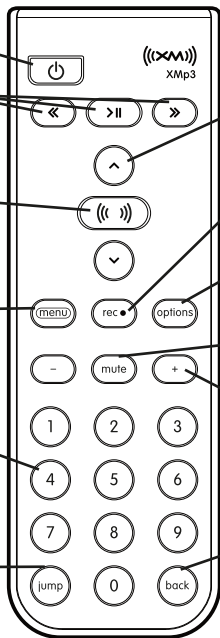

Arrow Buttons
Navigates through lists and highlights list items.

Record
Record a song or a channel. Also schedule a recording and set channel to auto record.

Options
Displays a menu in context according to what you are doing.

Mute
Silences the audio.

+ and -
Change channels or control volume for audio system (sold separately).

Back
Return to previous screen. Press and hold to return to the previous channel.

Home Installation

Home Installation

Just like when you first set up the Home Kit that came with your XMp3i™ or Pioneer XMp3™ Radio, there are two parts to setting up this Additional Home Kit. First, connecting the Home Dock to your stereo system or set of powered speakers, then placing and aiming the Indoor/Outdoor Home Antenna. Let's start with getting your Home Dock set up.

Step 1: Connect the Home Dock

When setting up the Home Dock in your home or office, choose a location in close proximity to your stereo system or powered speakers, and also where the cable from the Indoor/Outdoor Home Antenna can reach the Home Dock. The location should be easily accessible and provide good visibility of the display, but should not be located where it will be in direct sunlight, which will affect the visibility of the display screen.

You will also need to decide whether you will be connecting your Home Dock to your stereo system using the provided Stereo Audio Cable, or directly to a set of powered speakers.

Connect the Indoor/Outdoor Home Antenna

Once you have selected a location, connect the antenna to the **silver ANT** connector at the right side of the Home Dock. (After completing a few additional steps, we will work on the location of the antenna.)

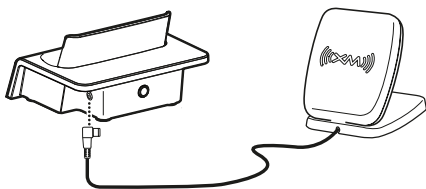

Connect the Home Power Adapter

Connect the Home Power Adapter to the **red POWER** connector at the left side of the Home Dock, and plug it into a wall outlet.

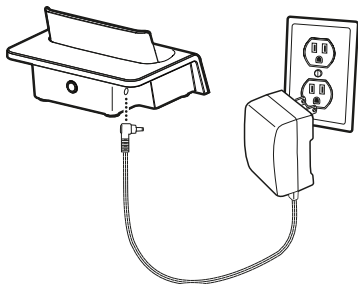

Connect the Home Dock to a Stereo System or Powered Speakers

The Home Dock can be connected to your stereo system, or to a set of powered speakers. If you are connecting to a stereo system, see the following section. If you are connecting to a set of powered speakers, see "To Connect the Home Dock to Your Powered Speakers" on page 15.

Home Installation

To Connect the Home Dock to Your Stereo System

The Home Dock can be connected to your stereo system through the **AUX In** or **LINE In** audio input jacks of your stereo system, using the provided Stereo Audio Cable.

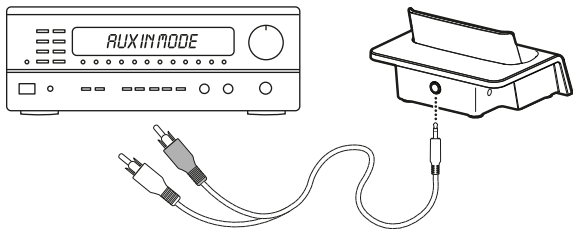

- 1** Take the included Stereo Audio Cable and connect the single 1/8" (3.5 mm) connector to the **green AUDIO** connector at the rear of the Home Dock.
- 2** Connect the white left and red right Stereo Audio Cable connectors to any available input other than PHONO on your stereo system. (If your stereo's inputs are marked red and black, simply connect the white plug to the black input.)
- 3** Turn the stereo system On, and make sure you select the correct input on your stereo system for the **AUX In** or **LINE In** audio input you selected, or whatever input you have selected.

To Connect the Home Dock to Your Powered Speakers

The Home Dock can be connected directly to a set of powered speakers.

- 1 Connect the 1/8" (3.5 mm) connector from the powered speakers to the **green AUDIO** connector at the rear of the Home Dock.

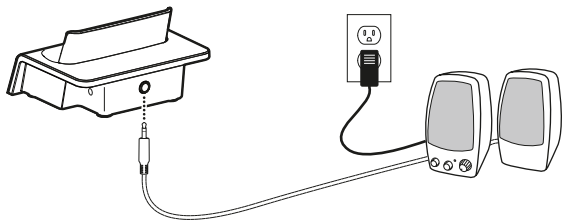

- 2 Plug the powered speakers into a standard power outlet.
- 3 Turn On the powered speakers.

Dock Your Radio

Place your XMp3i™ or Pioneer XMp3™ Radio into the Home Dock as shown, and turn your Radio On sliding the **Power/Lock** switch down.

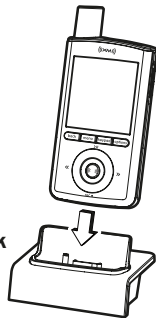

Home Installation

Step 2: Install the Indoor/Outdoor Home Antenna

To begin, try experimenting with the Indoor/Outdoor Home Antenna to get a feel for the reception in your location. Move the antenna around the room or from room to room. Aim it from different windows. In major metropolitan areas, you might find that you get great reception in several locations without worrying too much about aim and placement.

Access the Antenna Aiming screen of your Radio to see a visual indication of signal strength:

- 1 Press **menu**.
- 2 Turn the **Control Wheel** to highlight **Settings** and press **Select**.
- 3 Turn the **Control Wheel** to highlight **Antenna Aiming** and press **Select**.

If you're receiving good Satellite and Terrestrial signal strength, you're done. If not, try some of the suggestions which follow.

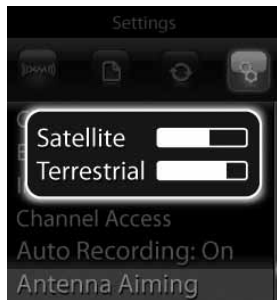

Other Indoor/Outdoor Home Antenna Installation Suggestions

If you find you are getting a signal, but it's inconsistent, try moving the Indoor/Outdoor Home Antenna closer to a window, ideally one that is facing due south.

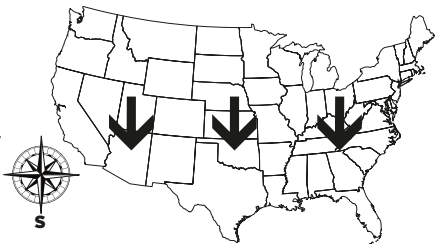

Not sure which way is south? Think about where the sun rises (in the east) and sets (in the west). Then stand so that east is to your left and you'll be facing south. Is there a window in the direction you're facing? Move the antenna closer to the window.



TIP! Still not sure which way is south or where to place your Indoor/Outdoor Home Antenna? Look up your location on an online mapping website that offers satellite views of street addresses where you can easily see which way is south, and what windows may offer an unobstructed view of the sky.

Another easy method is to start at any window, then work from window to window in a simple pattern to find the window gives the best signal strength. Note that the antenna must also have an unobstructed view, with no trees or buildings blocking its aim. If the antenna is aimed through a window, be aware that blinds, screens, or any other non-glass elements such as thermal insulation can sometimes cause reception issues. If this is the case, you may want to use another window or place the antenna outside of the window.

If you find a window that gives you good signal strength, you can place the antenna on the windowsill. The antenna may need to be placed on something to raise it above the level of the window frame.

If you don't have a window where you receive a consistent signal, or placing the antenna in a window is not a practical solution for you, **BETTER** reception can

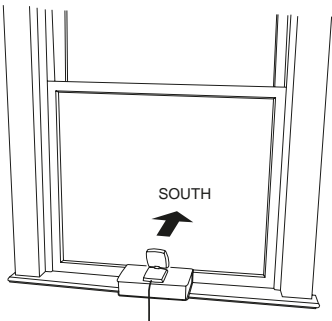

Home Installation

be achieved by placing the antenna outside on a window ledge, porch, table, or patio. The location you choose should provide the antenna with a clear view of the southern sky.

If none of the previous solutions work for you, then the **BEST** reception can be achieved by mounting the antenna outdoors, with a clear view of the southern sky.

Note that you will want to consider any potential hazards when you choose the mounting location, and possibly consider professional installation. SIRIUS XM Radio Inc. is not liable for any damages.

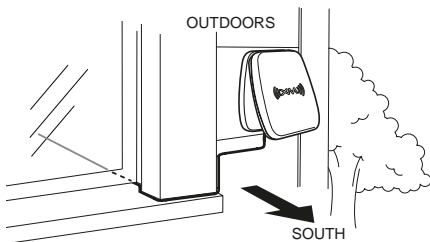
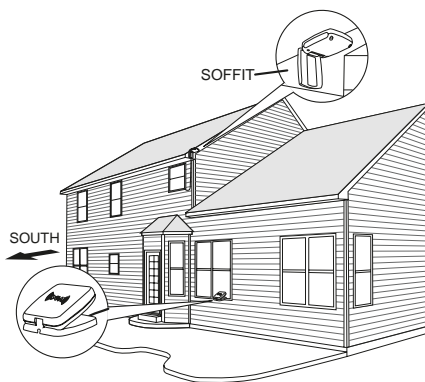

To mount the antenna, you will need four screws (not included) with a 1/4" head (e.g., an M3 screw), and that are suitable for the material onto which you are affixing the antenna, (e.g., wood, metal, etc.). The screws should be spaced 1-3/8" apart horizontally and 1-1/8" vertically. Refer to the template on "Indoor/Outdoor Home Antenna Template" on page 32.

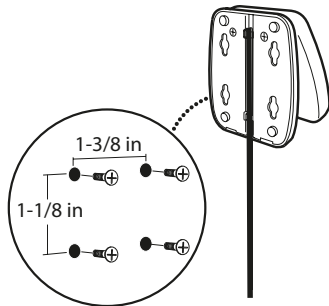

Once you have found a suitable location for the antenna, route the antenna cable to the Home Dock. Be sure you avoid any obstructions that could crimp, kink, or twist the cable. Use protective grommets wherever rough openings are encountered. If the antenna is installed outdoors, route the cable from the antenna location to the interior of the home or office, working the cable through the basement, under a window sill, etc., and make adjustments to take up cable slack as necessary.



TIP! If your Indoor/Outdoor Home Antenna's cable isn't long enough, visit xmradio.com/accessories, or your favorite retailer, and consider a 50 ft. Indoor/Outdoor Home Antenna Extension Cable or a Wireless Home Signal Repeater.

If the signal is good for either Satellite or Terrestrial (or both), and you are hearing the audio from your Radio, the installation is complete.

If the signal reception is low, or intermittent, try another location for the antenna. Verify that the antenna is pointed south, and that the antenna's view of the sky is not blocked by a tree, a building, a bridge, or anything else. Adjust until you are receiving a good signal.

Home Installation

The Indoor/Outdoor Home Antenna's reception can also be tweaked by opening or closing the antenna clamshell, and turning the antenna. While observing the signal strength, make small adjustments to the angle of tilt of the clamshell until the highest possible signal strength is achieved. If you have not wall-mounted the antenna, turn the antenna slightly to the right or left and observe if the signal strength increases. For each tweak, allow a few seconds in each position to determine if the signal strength increases.

If the signal reception is good, but there is no audio, verify your audio connection.

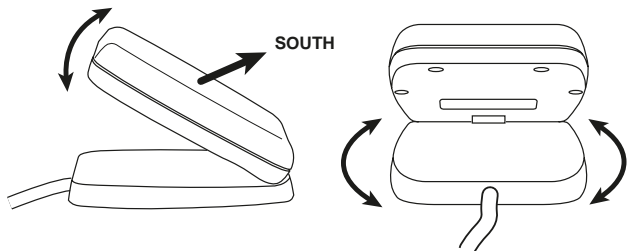

- If you are connected to a stereo system, be sure the stereo system is set to the same **AUX In** or **LINE In** audio input source you chose and that the Stereo Audio Cable is fully connected. If you still have no audio, try choosing a different input source.
- If you are connected to powered speakers, be sure the speakers are plugged into an outlet, and are turned On.

- The audio level of your Satellite Radio can also be increased. Refer to the User Guide which accompanied your Radio and increase the audio level.

If you still have questions, for example, 'Are there any other options/things I should consider?', etc., refer to "Troubleshooting" on page 24.

Troubleshooting

Troubleshooting

Your Home Kit has been designed and built to be trouble-free, but if you experience a problem, try this:

- Check that all connections are firm and secure.
- Make sure you have connected the Home Dock as described in this User Guide. Verify that the power outlet is working.

If you see this on the screen:	Try this:
Acquiring Signal	<ul style="list-style-type: none">• Move the antenna to a south-facing window. Not sure which way is south? Think about where the sun rises (in the east) and sets (in the west). Then stand so that east is to your left and you'll be facing south. Is there a window in the direction you're facing?• You may need to find a better location for the antenna. Refer to "Step 2: Install the Indoor/Outdoor Home Antenna" on page 16.
Check Antenna	<ul style="list-style-type: none">• Make sure that the Indoor/Outdoor Home Antenna cable is firmly and securely plugged into the Home Dock. Make sure the cable is not bent or broken.• Turn the Satellite Radio off, then on, to reset this message.
Channel Off Air	<ul style="list-style-type: none">• The channel you've selected is not currently broadcasting. Tune to another channel.
Loading	<ul style="list-style-type: none">• Your Satellite Radio is acquiring audio or program information. This message usually goes away in a few seconds.

If you see this on the screen:	Try this:
Updating	<ul style="list-style-type: none"> • Your Satellite Radio is being updated with the latest encryption code. Wait until the update is done. • You may be trying to tune to a channel that is blocked or unavailable. Tune to another channel.
–	<ul style="list-style-type: none"> • No program information, such as artist name, song title, or channel exists.
If this happens:	
You do not receive all the channels to which you subscribed	<ul style="list-style-type: none"> • If you have not yet activated your service, refer to the Activation section in the User Guide which accompanied your Satellite Radio.
No audio	<ul style="list-style-type: none"> • Check all cables between your Satellite Radio and your stereo system or powered speakers for a firm and secure connection. • Ensure you have selected the proper input source on your stereo system, or try another source. • Increase the audio level of the Radio. Refer to the User Guide which accompanied your Radio for instructions.
Audio sounds too soft	<ul style="list-style-type: none"> • Raise the volume of your stereo system or powered speakers, or increase the audio level of your Satellite Radio until the sound quality improves. Refer to the User Guide which accompanied your Radio for instructions.

Troubleshooting

If this happens:	Try this:
Audio fades or has static when listening	<ul style="list-style-type: none">• Check all cables for a firm and secure connection.
No song title or artist name is displayed	<ul style="list-style-type: none">• The information may not be available or updates may be in progress.
Traffic and Weather channels sound different from other channels	<ul style="list-style-type: none">• These channels use a different audio technology than other channels so they often sound different from other channels.
The Satellite Radio shuts off unexpectedly	<ul style="list-style-type: none">• If Power Off is set, the Radio will turn off after the selected length of time in the Home Dock. Set Power Off to Off.
The demo is playing	<ul style="list-style-type: none">• Your Indoor/Outdoor Home Antenna is not connected or you are not receiving the signal. Check that the Indoor/Outdoor Home Antenna is connected properly and is not obstructed.

Product Specifications

Product Specifications

System

Power Requirements	5.2V DC, 1.0 A (max)
Operating Temperature	-4°F to +140°F (-20°C to +60°C)
Audio Output	1.8Vrms (max)

Home Dock

Dimensions	2.7 in (W) X 1.4 in (H) X 2.1 in (D) (69.6 mm (W) X 35.1 mm (H) X 53.2 mm (D))
Weight	2.5 oz (71 g)
Audio Connector	1/8 in (3.5 mm) female
Antenna Connector	SMB male
Power Connector	Female

Home Power Adapter

Input	100 - 240 VAC, 50 - 60 Hz, 0.4 A
Output	5.2 V DC, 1.6 A

Home Antenna

Type	XM Indoor/Outdoor
Connector	SMB female, right angle
Cable Length	20 ft (6.1 m)

Stereo Audio Cable

Connectors	1/8 in (3.5 mm) stereo male to RCA left & right
Cable Length	3 ft 4 in (1 m)

Remote Control

Dimensions	1.6 in (W) x 4.7 in (H) x 0.6 in (D) (40 mm (W) x 119 mm (H) x 14 mm (D))
Weight	1.4 oz (40 g)
Battery	CR2032 (3 V)

Patent and Environmental Information

Patent Information

It is prohibited to, and you agree that you will not, copy, decompile, disassemble, reverse engineer, hack, manipulate, or otherwise access and/or make available any technology incorporated in this product. The music, talk, news, entertainment, data, and other content on the Services are protected by copyright and other intellectual property laws and all ownership rights remain with the respective content and data service providers. You are prohibited from any export of the content and/or data (or derivative thereof) except in compliance with applicable export laws, rules and regulations. The user of this or any other software contained in a SIRIUS|XM radio is explicitly prohibited from attempting to copy, decompile, reverse engineer, hack, manipulate or disassemble the object code, or in any other way convert the object code into human-readable form.

Environmental Information

Follow local guidelines for waste disposal when discarding packaging and electronic appliances.

Your Home Kit is packaged with cardboard, polyethylene, etc., and does not contain any unnecessary materials.

FCC Statement

The user is cautioned that changes or modifications not expressly approved by SIRIUS XM Radio Inc. can void the user's authority to operate this device.

This device complies with Part 15 of the FCC Rules. Operation is subject to the following two conditions:

1. This device may not cause harmful interference.
2. This device must accept any interference received, including interference that may cause undesired operation.

This equipment has been tested and found to comply with the limits for a Class B digital device, pursuant to Part 15 of the FCC Rules. These limits are designed to provide reasonable protection against harmful interference in a residential installation.

This equipment generates, uses, and can radiate radio frequency energy and, if not installed and used in accordance with the installation instructions, may cause harmful interference to radio communications. However, there is no guarantee that interference will not occur in a particular installation. If this equipment does cause harmful interference to radio or television reception, which can be determined by turning the equipment off and on, the user is encouraged to try to correct the interference by one or more of the following measures:

- Reorient or relocate the receiving antenna of the affected receiver.
- Increase the separation between the SIRIUS|XM equipment and the affected receiver.
- Connect the SIRIUS|XM equipment into an outlet on a circuit different from that to which the affected receiver is connected.
- Consult the dealer or an experienced radio/TV technician for help.

WARNING! The FCC and FAA have not certified Satellite Radio Receiver use in any aircraft (neither portable nor permanent installation). Therefore, SIRIUS XM Radio Inc. cannot support this type of application or installation.

Copyrights and Trademarks

Hardware and subscription sold separately. Activation fee, other fees, and taxes required. Installation required with some equipment. Except as specifically provided, SIRIUS and XM Radios and Accessories are compatible only with their respective subscription service. Subscriptions are governed by, as applicable, SIRIUS Terms & Conditions available at sirius.com or XM Customer Agreement available at xmradio.com.

SIRIUS|XM U.S. Satellite Service available only to those at least 18 years of age in the 48 contiguous USA and DC, with SIRIUS available in PR too (with coverage limitations). Service available in Canada; see www.siriuscanada.ca or www.xmradio.ca

© 2010 SIRIUS XM Radio Inc. SIRIUS, XM and all related marks and logos are trademarks of SIRIUS XM Radio Inc. and its subsidiaries. All other trademarks, service marks and logos are the property of their respective owners. All rights reserved.

WARNING: This product contains chemicals known to the State of California to cause cancer and birth defects or other reproductive harm.

Indoor/Outdoor Home Antenna Template

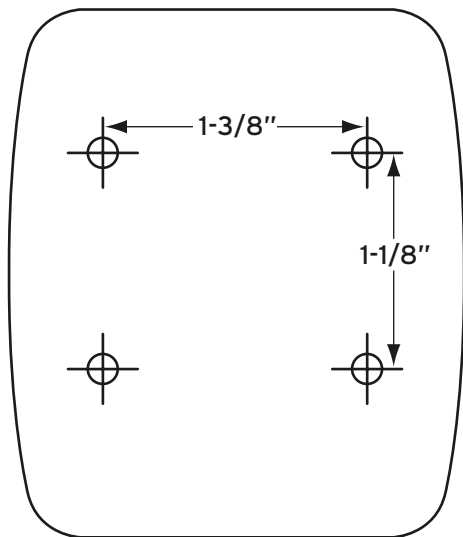

xmradio.com

SIRIUS XM Radio Inc.
1221 Avenue of the Americas
New York, NY 10020

1.800.967.2346

© 2010 SIRIUS XM Radio Inc.

XMp3i™ Additional Home Kit User Guide (XMP3IHKUG0210) 021710

Free Manuals Download Website

<http://myh66.com>

<http://usermanuals.us>

<http://www.somanuals.com>

<http://www.4manuals.cc>

<http://www.manual-lib.com>

<http://www.404manual.com>

<http://www.luxmanual.com>

<http://aubethermostatmanual.com>

Golf course search by state

<http://golfingnear.com>

Email search by domain

<http://emailbydomain.com>

Auto manuals search

<http://auto.somanuals.com>

TV manuals search

<http://tv.somanuals.com>