

RAMPAGE
BY AUDIOVOX

OWNER'S MANUAL

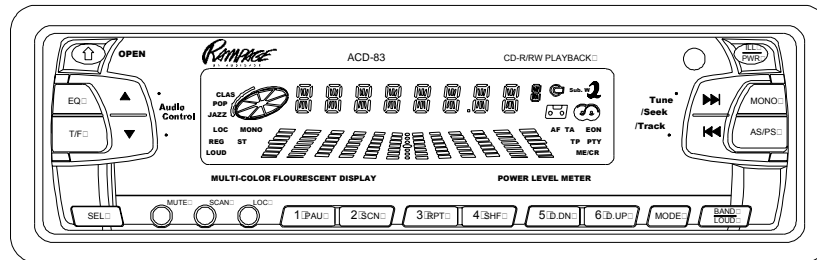

ACD-83

**AM/FM/MPX RADIO WITH
FOLD-DOWN DETACHABLE FRONT PANEL,
COMPACT DISC PLAYER,
CD CHANGER CONTROLS,
WIRELESS REMOTE CONTROL
AND QUARTZ CLOCK**



128-6003A
1 of 20

INSTALLATION INSTRUCTIONS

This unit is designed for installation in cars, trucks, and vans with an existing radio opening. In many cases, a special installation kit will be required to mount the radio to the dashboard. These kits are available at electronics supply stores and car stereo specialist shops. Always check the kit application before purchasing to make sure the kit works with your vehicle. If you need a kit but cannot find it available, call our toll-free "HELP" line at **1-800-645-4994**.

UNIVERSAL INSTALLATION PROCEDURE USING MOUNTING SLEEVE

1. Open, fold down and remove the detachable front panel, if it is attached to the chassis, by grasping the grooved center portion and pulling the panel assembly straight out. Slide the mounting sleeve off of the chassis. If it is locked into position, use the removal tools (supplied) to disengage it.
2. Check the dashboard opening size by sliding the mounting sleeve into it. If the opening is not large enough, carefully cut or file as necessary until the sleeve easily slides into the opening. Do not force the sleeve into the opening or cause it to bend or bow. Check that there will be sufficient space behind the dashboard for the radio chassis.
3. Locate the series of bend tabs along the top, bottom, and sides of the mounting sleeve. With the sleeve fully inserted into the dashboard opening, bend as many of the tabs outward as necessary so that the sleeve is firmly secured to the dashboard.
4. Place the radio in front of the dashboard opening so that the wiring can be brought through the mounting sleeve. Follow the wiring diagram carefully and make certain all connections of the wiring harness are secure and insulated with wire nuts or electrical tape to insure proper operation of the unit. After completing the wiring connections, attach the front panel and turn the unit on to confirm operation (ignition switch must be "on"). If unit does not operate, re-check all wiring until problem is corrected. Once proper operation is achieved, turn off the ignition switch and proceed with final mounting of the chassis.
5. Carefully slide the radio into the mounting sleeve making sure it is right-side-up until it is fully seated and the spring clips lock it into place.
6. Attach one end of the perforated support strap (supplied) to the screw stud on the rear of the chassis using the hex nut provided. Fasten the other end of the perforated strap to a secure part of the dashboard either above or below the radio using the screw and hex nut provided. Bend the strap to position it as necessary.
CAUTION: The rear of the radio must be supported with the strap to prevent damage to the dashboard from the weight of the radio or improper operation due to vibration.
7. Re-attach the front panel to the chassis and test radio operation by referring to the Operating Instructions for the unit.

INSTALLATION USING KITS

1. If your vehicle requires the use of an installation kit to mount this radio, follow the instructions included with the installation kit to attach the radio to the mounting plate supplied with the kit.
2. Wire and test the radio as described in Step 4 above.
3. Install the radio/mounting plate assembly to the sub-dashboard according to the instructions of the installation kit.
4. Attach the support strap to the radio and dashboard as described in Step 6 above.
5. Replace the dashboard trim panel.

ISO INSTALLATION PROCEDURE

This unit has threaded holes in the chassis side panels which may be used with the original factory mounting brackets of some Toyota, Nissan, Mitsubishi, Isuzu, Hyundai and Honda vehicles to mount the radio to the dashboard. Please consult with your local car stereo specialist shop for assistance on this type of installation.

1. Remove the existing factory radio from its dashboard or center console mounting. Save all hardware and brackets as they will be used to mount the new radio.
2. Carefully un-snap the plastic frame from the front of the new radio chassis. Remove and discard the frame.
3. Remove the factory mounting brackets and hardware from the existing radio and attach them to the new radio.
CAUTION: DO NOT EXCEED M5 X 8 MM MAXIMUM SCREW SIZE. LONGER SCREWS MAY TOUCH AND DAMAGE COMPONENTS INSIDE THE CHASSIS.
4. Wire the new radio to the vehicle as per step 4 above.
5. Mount the new radio assembly to the dashboard or center console using the reverse procedure of step 1.

TOLL-FREE INSTALLATION ASSISTANCE

The installation and wiring connections for this unit are so simple, we doubt you'll need our help, but, if you do, we're here to help you. Just call our toll-free telephone assistance line at **1-800-645-4994** during the days and hours shown (U.S.A. and Canada only).

DAY	TIME ZONE			
	PACIFIC	MOUNTAIN	CENTRAL	EASTERN
MON. - FRI.	5:30AM - 4PM	6:30AM - 5PM	7:30AM - 6PM	8:30AM - 7PM
SATURDAY	6AM - 2PM	7AM - 3PM	8AM - 4PM	9AM - 5PM

UNIVERSAL INSTALLATION USING MOUNTING SLEEVE

FASTEN THIS END TO SECURE PART OF DASHBOARD. DRILL HOLE IF NECESSARY.

EXISTING DASH OPENING FILE EDGES TO FIT IF NECESSARY - DO NOT OVERFILE NOTE: IF DASH IS SOLID, USE REAR SIDE (WITHOUT THE LIP) OF MOUNTING SLEEVE AS A TEMPLATE & CUT OPENING

CAUTION: FOR PROPER OPERATION OF THE CD PLAYER, THE CHASSIS MUST BE MOUNTED WITHIN 20° OF HORIZONTAL. MAKE SURE THE UNIT IS MOUNTED WITHIN THIS LIMITATION.

20° MAX.

FOLD-DOWN DETACHABLE FRONT PANEL

ISO INSTALLATION

REMOVE THE PLASTIC FRAME FROM THE FRONT OF THE CHASSIS BY CAREFULLY UN-SNAPPING IT.

UN-SNAP AT 2 PLACES EACH ON TOP AND BOTTOM

PLASTIC FRAME

TYPICAL INSTALLATION

MAXIMUM SCREW SIZE M5 x 8

MAXIMUM SCREW SIZE M5 x 8

FACTORY MOUNTING BRACKETS

RADIO WIRING

REFER TO PAGE 5 FOR SPEAKER WIRING

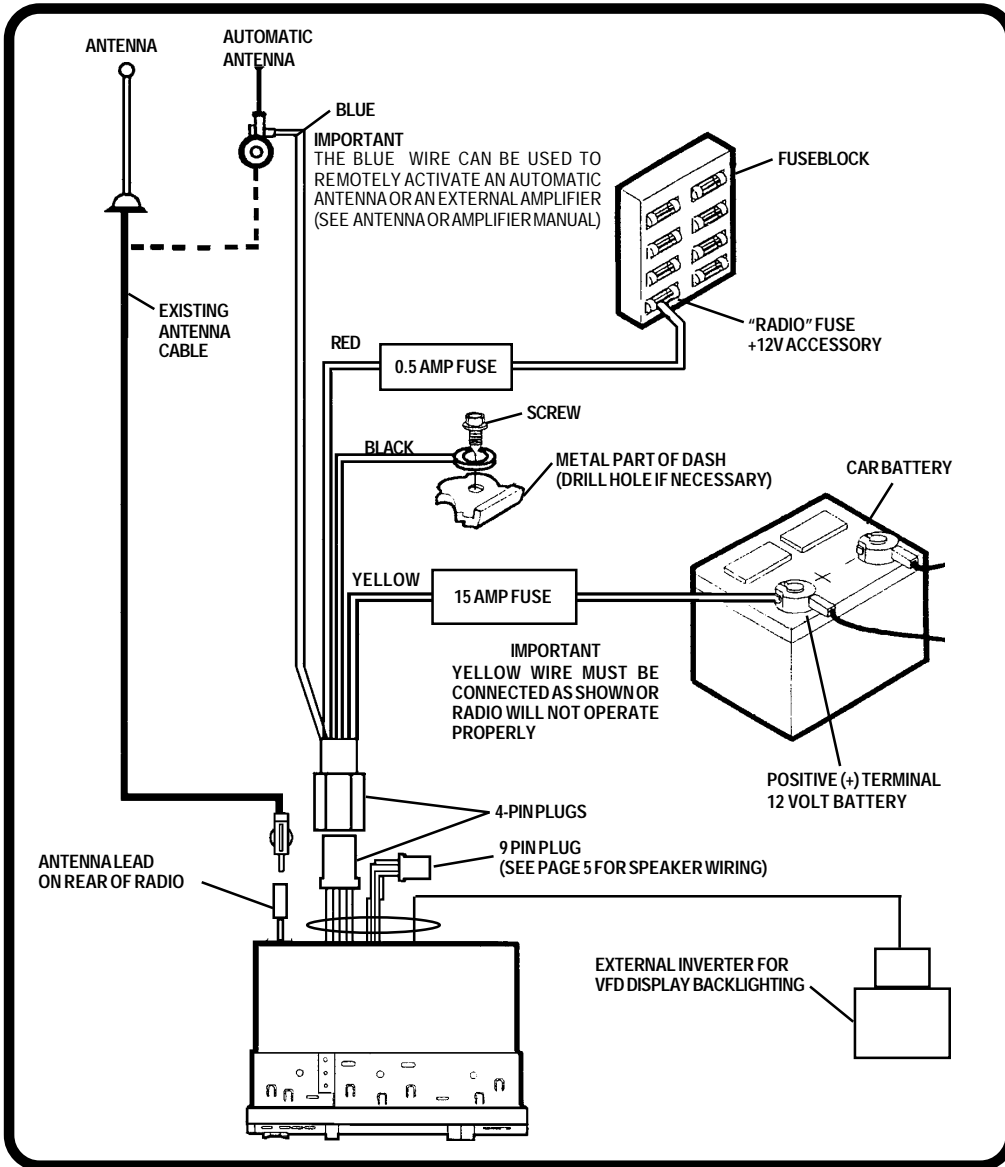

SPEAKER WIRING

REFER TO PAGE 4 FOR RADIO WIRING

WARNING!

- THE AMPLIFIERS IN THIS RADIO ARE **ONLY** DESIGNED FOR USE WITH 4 SPEAKERS.
- **NEVER** COMBINE (BRIDGE) OUTPUTS FOR USE WITH 2 SPEAKERS.
- **NEVER** GROUND NEGATIVE SPEAKER LEADS TO CHASSIS GROUND.
- FAILURE TO WIRE EXACTLY AS SHOWN BELOW MAY CAUSE ELECTRICAL

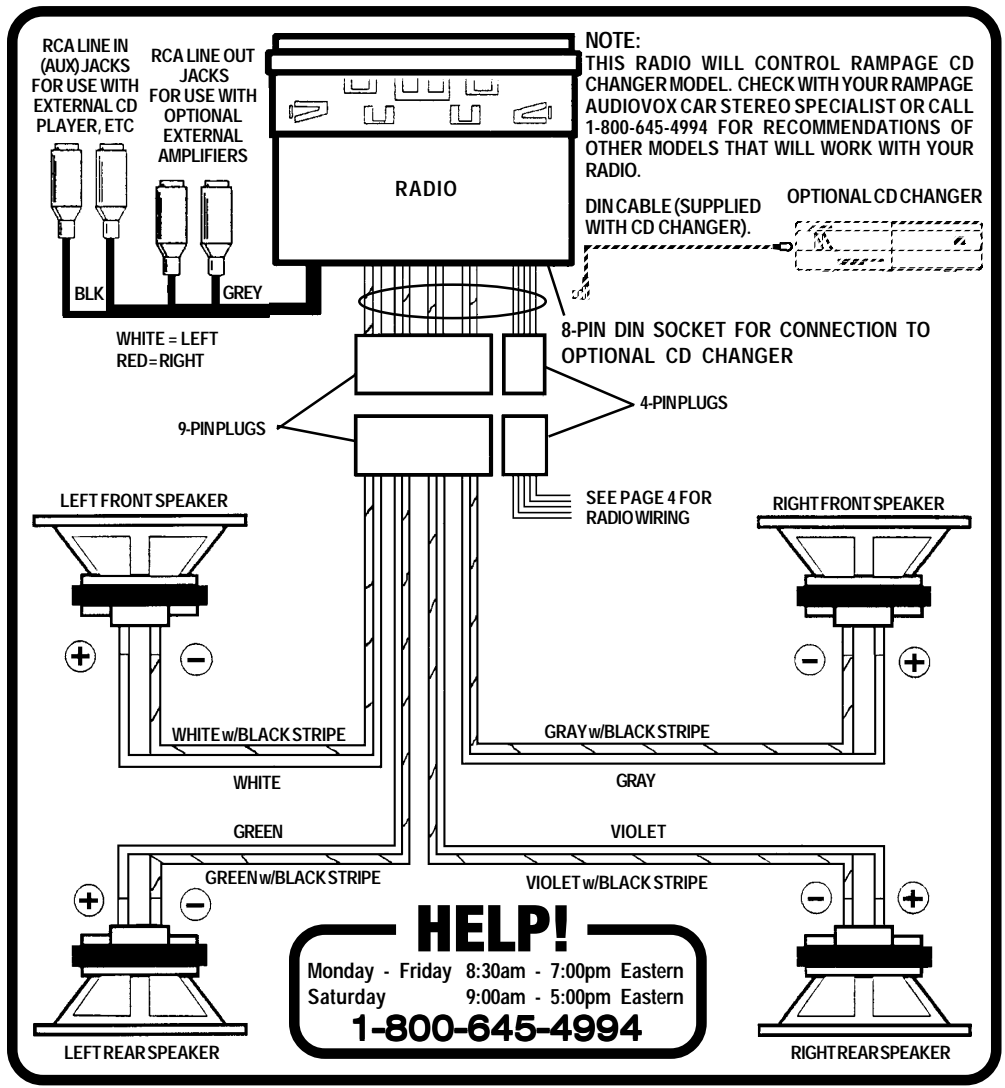

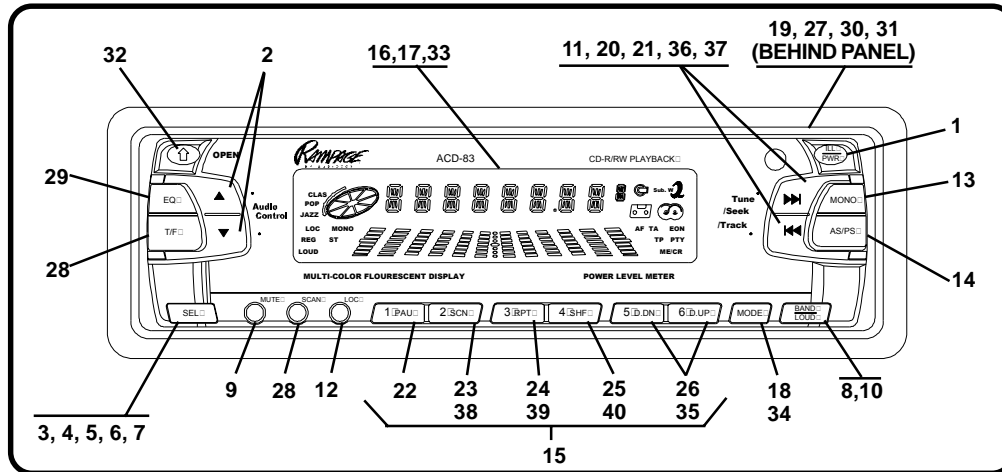

① POWER/ILL BUTTON (PWR)

Press this button to turn the unit on or off. If the ignition switch is "on", the unit will also turn on automatically when a compact disc is inserted, or if any other button is pressed. When the radio is on, each time the button is momentarily pressed and released, the VFD display panel back-lighting intensity will change from low-to-medium-to-high, and then back to low, thereby providing three different intensity settings.

② AUDIO CONTROL (▲ / ▼) SELECT

To increase the volume level, press the ▲ button. The volume will increase and the level will shown on the display panel from a minimum of **VOL 00** to a maximum of **VOL 100**. To decrease the volume level, press the ▼ button. The display will automatically return to the normal indication 5 seconds after the last volume adjustment or when another function is activated. These control buttons are also used in conjunction with the Select (SEL) button ③ to adjust the bass, treble, balance and fader levels as described in ④, ⑤, ⑥ and ⑦.

③ PUSH SELECT CONTROL (SEL)

This button is used to select the audio function (volume, bass, treble, balance, or fade) whose setting is adjusted using the AUDIO CONTROL buttons ②. Pressing the SEL button once will set the unit for volume adjustment (**VOL** on the display). Additional presses will set the unit for bass adjustment (**BAS** on the display panel), treble adjustment (**TRB** on the display), balance (**BAL**), or fader (**FAD**). The display will automatically return to the normal indication 5 seconds after the last adjustment or when another function is activated.

NOTE: If the BAS or TRE functions are set while the Equalizer function ⑨ is active, the Equalizer function will automatically revert to the **FLAT** setting.

④ BASS CONTROL

To adjust the bass level, first select the Bass mode by pressing the SEL button ③ so the **BAS** indication appears on the display panel. Within 5 seconds of choosing the Bass mode, press the ▼ AUDIO CONTROL ②

button to decrease the bass response, or the ▲ AUDIO CONTROL button to increase it as desired. The level will be shown on the display panel from a minimum **BAS --10** to a maximum of **BAS 10** (**BAS 00** indicates flat response). The display will automatically return to the normal indication 5 seconds after the last adjustment or when another function is activated.

⑤ TREBLE CONTROL

To adjust the treble level first select the Treble mode by pressing the SEL button ③ so the **TRB** indication appears on the display panel. Within 5 seconds of choosing the Treble mode, press the ▼ AUDIO CONTROL button ② to decrease the treble response or the ▲ AUDIO CONTROL button to increase it as desired. The level will be shown on the display panel from a minimum **TRB --10** to a maximum of **TRB 10** (**TRB 00** indicates flat response). The display will automatically return to the normal indication 5 seconds after the last adjustment or when another function is activated.

⑥ LEFT/RIGHT BALANCE CONTROL

To adjust the left-right speaker balance, first select the Balance mode by pressing the SEL button ③ so the **BAL** indication appears on the display panel. Within 5 seconds of choosing the Balance mode, press the ▼ AUDIO CONTROL button ② to adjust the stereo balance to the left channel speakers or the ▲ AUDIO CONTROL button to adjust it to the right channel speakers. The balance position will be shown on the display panel from **BAL 10L** (full left) to **BAL 10R** (full right). When the volume level between the left and right speakers is equal, **BAL L=R** will be shown on the display panel. The display will automatically return to the normal

indication 5 seconds after the last adjustment or when another function is activated.

⑦ FRONT/REAR FADER CONTROL

To adjust the front-rear speaker balance, first select the Fader mode by pressing the SEL button ③ so the **FAD** indication appears on the display panel. Within 5 seconds of choosing the Fader mode, press the ▼ AUDIO CONTROL button ② to adjust the front-rear speaker balance to the front speakers or the ▲ AUDIO CONTROL button to adjust it to the rear speakers. The fader position will be shown on the display panel from **FAD 10R** (full rear) to **FAD 10F** (full front). When the level between the front and rear speakers is equal, **FAD F=R** will be shown on the display panel. The display will automatically return to the normal indication 5 seconds after the last adjustment or when another function is activated.

⑧ LOUDNESS CONTOUR (LOUD)

When listening to music at low volume levels, this feature will boost the bass and treble ranges to compensate for the characteristics of human hearing. Press and hold the BAND/LOUD button for more than 2 seconds to activate this feature; the **LOUD ON** indication will appear on the display panel for 5 seconds, and **LOUD** will also appear and remain. Pressing the button again for more than 2 seconds will deactivate the feature (**LOUD OFF** indication will appear on the display panel for 5 seconds, and **LOUD** will also disappear).

⑨ AUDIO MUTE SELECTOR (MUTE)

Press this button momentarily to mute the volume from the system (**MUTE** will appear blinking on the display panel). Pressing the

button again or adjusting the AUDIO CONTROL ② level will return to the volume level setting in use before the Mute function was activated.

During disc play, pressing this button will mute disc audio and disc play will be paused. During this time, the \ominus indication will remain on the display panel to show that a disc is still loaded in the unit.

⑩ AM/FM BAND SELECTOR (BAND)

Each time this button is pressed, the radio band is changed. The indication **AM**, **F1**, **F2** or **F3** will appear on the display panel according to your selection.

⑪ UP/DOWN TUNE/SEEK/TRACK (▶▶/◀◀) BUTTONS

To manually select a radio station, momentarily press the Up Tuning (▶▶) button to tune the unit higher, or the Down Tuning (◀◀) button to tune lower within the selected band. The radio will automatically tune to the next strong station and stop on this frequency. If the LOCAL mode is in effect, the radio will seek the next local station and stop at that frequency.

Pressing either button for longer than 2 seconds will cause **MANUAL** to appear on the display, accompanied by a beep tone, thereby entering the seek mode. Pressing a button in this mode will cause the radio to rapidly tune in the up or down direction and stop when the button is released. The radio will then remain at that frequency. Five seconds after Manual tune is inactive, **AUTO** will momentarily appear for 2 seconds, thereby reverting to the normal tuning mode.

⑫ LOCAL BUTTON

This feature is used to select the strength of the signals at which the radio will stop during Manual Seek Tuning. Pressing and holding the button will select the Local setting (**LOCAL** will appear on the display panel for 5 seconds and **LOC** will remain in the lower left corner) and only strong (local) stations will be received. Pressing and holding the button again will select the Distant setting (**Dx** will appear on the display panel for 5 seconds) and the radio will stop at a wider range of signals, including weaker (more distant) stations.

⑬ FM MONO/STEREO BUTTON (MONO)

During FM radio operation, this button is used to select monaural or stereo reception of the broadcast signal. Under normal reception conditions, the unit should be left in the stereo mode as indicated by the **ST** indication on the display panel when tuned to an FM stereo signal. If the stereo signal is too noisy for comfortable listening, press the MONO button to switch to monaural reception (the **ST** indication will disappear from the display panel and **MONO** will appear). To return to stereo reception mode, press the button again so that the **ST** indication appears on the display panel.

⑭ PRE-SET SCAN (PS) AUTO-STORE TUNING (AS)

Press this button momentarily to scan the stations pre-set into the six memories of the current band in use. The unit will stop at each pre-set station for 5 seconds before continuing to the next pre-set station (the pre-set frequency on the display panel will flash during Pre-Set Scan operation). Press the button again momentarily to stop Pre-Set Scan operation and remain on the

selected frequency. If no buttons are pressed during the scan, the unit will return to the original station before the scan started.

Pressing and holding the button for longer than 2 seconds will activate the Auto-Store Tuning feature which will automatically scan and enter up to 6 stations into the pre-set memories on each FM band. If you have already set the pre-set memories to your favorite stations, activating the Auto-Store Tuning feature will erase those stations and enter the new ones. This feature is most useful when traveling in a new area where you are not familiar with the local stations.

⑮ STATION PRE-SET MEMORIES

To set any of the 6 pre-set memories in each band, use the following procedure:

1. Turn the radio on and select the desired band.
2. Select the first station to be pre-set using the TUNE/SEEK/TRACK Controls ⑩.
3. Press the pre-set button to be set and continue to hold it in for approximately 2 seconds. The pre-set number will appear on the display panel (accompanied by a beep) indicating that the station is now set into that pre-set memory position. The station can now be recalled at any time by pressing that button.
4. Repeat the above procedure for the remaining 5 pre-sets on that band and for the other 3 bands on the unit.

⑯ VACUUM FLOURESCENT DISPLAY (VFD)

The Vacuum Fluorescent Display (VFD) panel displays the frequency, time, and activated functions using one of three

illumination levels as selected by the PWR/ILL button ①.

⑰ POWER LEVEL METER DISPLAY



This display consists of a left and right six-bar graph which provides a visual representation of the audio signal level applied to the left and right channels. The illuminated segments of the left and right channel bar graphs increase and decrease as a function of the audio signal strength applied to the left and right channels. As the signal increases, the number of illuminated segments will increase and vice-versa.

⑱ MODE SELECTOR (MODE)

This button is used to select the radio, CD player, CD changer (if installed) or auxiliary (AUX) input playback mode. Each press of the button will select a different mode as indicated on the display panel.

During CD player operation, this button may be used to change to radio, AUX input (MP3 or external CD player) or CD changer mode without ejecting the disc. The  indication will remain on the display panel to show that the CD player or changer is operating. Press the button again to return to CD player mode and resume play of the disc from the beginning of the current track.

⑲ DISC SLOT

With the front panel in the fold-down position, gently insert the disc into the slot (label surface facing up) until the soft-loading mechanism engages and pulls the disc in. The **S--CDP** indication will appear on the display panel for 5 seconds. The  indication illuminates and becomes animated, the  symbol lights, and the track number and elapsed time will appear on the display panel.

CAUTION: This unit is designed for play of standard 5" (12cm) compact discs ONLY. Do not attempt to use 3" (8cm) CD-Singles in this unit, either with or without an adapter, as damage to the player and/or disc can occur. Such damage will not be covered by the Warranty on this product.

20 TRACK SELECT (▶▶/◀◀)

The Track Select function of the TUNE/SEEK/TRACK buttons are used to quickly access the beginning of a particular track when a disc is in play. Each time the Forward TRACK Select (▶▶) side of the button is pressed, the next higher track number will be selected as shown on the display panel. Similarly, each time the Backward TRACK Select (◀◀) side of the button is pressed, the next lower track number will be selected as shown on the display panel.

21 CUE/REVIEW FUNCTIONS (▶▶/◀◀)

High-speed audible search to any section of the disc can be made by the Cue and Review functions. Press and hold the Cue (▶▶) button to advance rapidly in the forward direction (the advancing disc playing time will be shown on the display panel), or the Review (◀◀) button to advance rapidly in the backward direction (the decreasing disc playing time will be shown on the display panel). During either function, the elapsed time within each track will automatically be shown on the display panel.

22 DISC PAUSE (PAU)

The Pause function is used to pause disc play, whether it be the CD Player or the optional CD Changer; **S--PAUSE** will appear on the display. When pressed again, disc play will

resume from the point it was stopped and **S--PAUSE** will disappear.

23 TRACK SCAN SELECTOR (SCN)

During disc play, press this button to play the first 10 seconds of each track on the disc (**S--SCAN**) will appear on the display panel). When a desired track is reached, press the SCN button again to cancel the function (**S--SCAN** will disappear from the display panel) and play of the selected track will continue. Scan mode will also be canceled by activating the Repeat Play 24, or Shuffle Play 25 functions.

24 REPEAT PLAY SELECTOR (RPT)

During disc play, press this button to repeat the play of the selected track (**S--RPT** will appear on the display panel). Play of the track will continue to repeat until the button is pressed again and the **S--RPT** indication disappears from the display panel. Repeat Play mode will also be canceled by activating the Track Scan 23 or Shuffle Play 25 functions.

25 SHUFFLE PLAY SELECTOR (SHF)

During disc play, press this button to play the tracks on the disc in a random shuffled order (**S--SHF** will appear on the display panel). In Shuffle Play mode, the TRACK Select function will also select tracks in the random order instead of the normal progression. The Shuffle Play mode can be canceled by pressing the button again (**S--SHF** indication will disappear from the display panel) or by activating the Repeat Play 24 or Track Scan 23 functions.

26 DISC SELECT UP/DOWN (D.UP/D.DN)

These buttons are used to select the desired disc for play during optional CD changer operation. To advance to a higher number disc, press

the D.UP button, and to return to a lower number disc, press the D.DN button. The number of the disc in play will be shown on the display panel.

⑳ DISC EJECT (▲)

Disc play is stopped and the disc is ejected when the front panel is folded down and this button on the rear of the panel is pressed. Radio operation will automatically resume. If the disc is not removed from the unit within 15 seconds of being ejected, it will automatically be re-loaded into the unit to prevent it from being accidentally damaged (⊖ will appear on the display panel to indicate that a disc is loaded in the player). Play of the disc can be resumed by using the MODE button ㉑ to choose the CD player function.

㉑ TIME/FREQUENCY SELECTOR (T/F)

During radio, CD Player or optional CD Changer operation, press this button to call the time display on the incorporated quartz clock. The current time will appear together with an **A** or **P** indication. The display will return to the radio frequency indication after 5 seconds.

㉒ EQUALIZER BUTTON (EQ)

The EQ button applies preset sound effects to the unit's audio output signal. The EQ button, when pressed, will activate one of five operating modes (**CLASSICS**, **POP**, **JAZZ**, **DSP OFF** or **FLAT**). Even though the Equalizer function is active, as displayed on the panel, if the bass and/or treble level is set, the Equalizer function automatically returns to the **FLAT** mode. Conversely, when the Equalizer function is not active, the unit returns to the user set bass and treble levels.

㉓ THEFT-DETERRENT LED

Located on the chassis behind the front panel, a light-emitting diode (LED) will flash when the panel is physically removed. The flashing light serves as a visual warning to the would-be thief that the unit has been disabled by removal of the front panel.

㉔ RESET BUTTON

The RESET button is located above and to the right of the theft deterrent LED. The reset circuitry should only be activated under the following circumstances as it will erase the time and pre-set memories:

1. Upon initial installation after all wiring is completed.
2. If there is a malfunction of any of the switches on the unit, pressing the RESET button may clear the system and return to normal operation.

㉕ FRONT PANEL RELEASE BUTTON (OPEN)

This button is used to release the mechanism that holds the front panel to the chassis. To detach the front panel, press the button so that the panel drops to the lowered position. Grasp the panel at the middle and pull it off of the chassis mounting plate. To re-attach the panel, press it straight onto the chassis mounting plate until the mechanism locks it into place.

㉖ REMOTE SENSOR

The sensor to detect the infrared signal from the wireless remote control is located behind the VFD display lens. For optimum operation of the remote control, always aim the control at the VFD display.

NOTES ON USE OF FRONT PANEL:

1. Make sure the front panel is positioned correctly when attaching it to the chassis as it cannot be attached when up-side down. Use moderate pressure to fully seat the panel into position.
2. To verify correct panel installation, swing the panel assembly up into position until it locks easily into place. If any resistance is encountered, re-check panel orientation in chassis mounting plate.
3. When taking the front panel with you, please use the supplied carrying case to protect the panel from dirt and damage. Make sure there is no dust or dirt on the electrical terminals on the back of the panel as this could cause intermittent operation or other malfunctions.

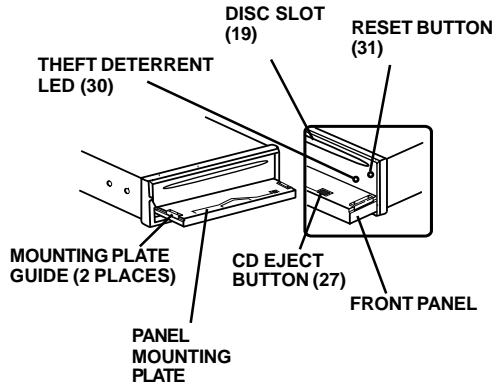

SETTING THE CLOCK

1. Switch the vehicle ignition and radio “on”.
2. Press the Time/Frequency (T/F) button to call the time display.
3. Within 10 seconds, press and hold the T/F button until a single beep sounds and the time display flashes.
4. With the display flashing, press the Up TUNE/SEEK/TRACK (▶▶) button to adjust the hours and **A/P** indication, or the Down TUNE/SEEK/TRACK (◀◀) button to adjust the minutes to the correct time.
5. Five seconds after the last hour or minute adjustment is made, the time will be set in the unit and the display will return to the normal indication.

CD PLAYER ERROR CODES

If a problem should develop while operating the CD player, an error code (**ER-1**, **ER-2**, **ER-3**, etc.) may appear on the display panel. This can indicate a number of problems with the unit, including a mechanical error or an error in the microprocessor control of the player. If an error code should appear, try ejecting and re-loading the disc into the player. While the disc is out of the unit, make sure it is clean, undamaged, and loaded correctly (label surface up). You may also try activating the RESET button (31) on the unit, but this will also erase the time and pre-set memories.

If the suggested measures do not solve the problem, contact an approved warranty station near you for further assistance.

SPECIFICATIONS

Size:	7" W x 2" H x 6-5/16" D 178 mm x 50 mm x 160 mm
Operating Voltage:	12 volts DC, negative ground
Fuse Ratings:	Constant (Yellow wire): 15 AMP. Switched (Red wire): 0.5 AMP.
Output Power:	160 watts maximum (40 watts x 4 channels)
Output Wiring:	Floating-ground type designed for 4 speaker use. Front and rear channels CANNOT be combined (bridged) for use with 2 speakers. RCA low-level outputs (front and rear channels).
Output Impedance:	Compatible with 4 – 8 ohm speakers.
Low-Level Output:	500 mv.
Tuning Range:	AM: 530 – 1,720 kHz. (10 kHz. step) FM: 87.5 – 107.9 MHz. (200 kHz. step)
Sensitivity:	AM: 20 uv. FM: 1.5 uv.
FM Stereo Separation:	>20 dB
CD Frequency Response:	17 – 20 kHz. +0/-3 dB
CD Signal/Noise Ratio:	>65 dB
CD Channel Separation:	>60 dB
CD Distortion:	0.2%

*Specifications are subject to change without notice.

CD-R AND CD-RW PLAYBACK CAPABILITY

This model can play most CD-R and CD-RW media that contains audio programs. Playback of both CD-R and CD-RW depends on the conditions of the recording equipment and the CD-R or CD-RW disc quality. In some cases, a CD-R or CD-RW disc cannot be played on this unit.

CD CHANGER CONTROLS

Built into this radio are controls to operate an optional CD changer. Please check with your Rampage/Audiovox car stereo specialist or call 1-800-645-4994 for recommendations of the models that will work with this radio.

Adjustment of the audio functions (volume, tone, balance, and fader) for the CD changer operate in the same manner as they do for radio play. The following controls will operate the CD changer when it is installed and connected to this radio. Refer to the owner's manual included with the CD changer for instructions on the installation and correct loading and use of the CD magazine.

34 CD CHANGER MODE SELECTOR (MODE)

During radio or CD play, press this button to select operation of the CD changer as shown by **CDC** on the display panel. Disc play will begin and the disc and track number will be shown on the display panel. When the magazine is loaded into the changer, play will begin from the first track of the first disc in the magazine.

35 DISC SELECT (D.UP/D.DN)

These buttons are used to select the desired disc for play. To advance to a higher number disc, press the **D.UP** button. To return to a lower number disc, press the **D.DN** button. The number of the disc in play will be shown on the display panel.

36 TRACK SELECT (▶▶/◀◀)

The Track Select functions are used to quickly access the beginning of a particular track. Each time the Forward Track Select (▶▶) side of the button is pressed, the next

higher track number will be selected as shown on the display panel. Similarly, each time the Backward Track Select (◀◀) button is pressed, the next lower track number will be selected as shown on the display panel.

37 CUE/REVIEW FUNCTIONS(▶▶/◀◀)

High-speed audible search to any section of the disc can be made by the Cue and Review functions. Press and hold the Cue (▶▶) side of the button to advance rapidly in the forward direction (disc play symbol rotation on the display panel will increase) or the Review (◀◀) side of the button to advance rapidly in the backward direction.

38 TRACK/DISC SCAN SELECTOR (SCN)

When the SCN button is pressed, the **SCN** indication will appear on the display panel, and the first 10 seconds of each track on the disc will be played in order. When a desired track is reached, press the SCN button again and play of the selected track will continue (**SCN** will disappear from the display panel). The Track Scan mode will also be canceled by activating the Repeat or Shuffle Play function.

When the Scan button is pressed and held for more than 2 seconds, the **DSN** indication will appear on the display panel with the disc number, and the first 10 seconds of the first track on each disc in the magazine will be played. When a desired disc track is reached, press the SCN button again and play of the selected disc will continue (**DSN** will disappear from the display panel, and be replaced by **CDC** and the disc/track number). The Disc Scan mode will also be canceled by activating the Repeat or Shuffle Play function.

③⑨ DISC/TRACK REPEAT PLAY (RPT)

When the RPT button is pressed, the **RPT** indication will appear on the display panel and play of the selected track will be continually repeated until the Track Repeat mode is canceled by pressing the RPT button again or by activating the Scan or Shuffle Play functions.

When the RPT button is pressed and held for more than 2 seconds, the **DRT** indication will appear on the display panel and play of the selected disc will be continually repeated until the Disc Repeat mode is canceled by pressing the RPT button again or by activating the Scan or Shuffle Play functions.

④① DISC/TRACK SHUFFLE PLAY (SHF)

When the SHF button is pressed, the **SHF** indication will appear on the display panel

and the tracks on the disc will be played in a random, shuffled order. The Track Select button will also select tracks in the shuffled order instead of the normal progression. The Shuffle Track mode can be canceled by pressing the SHF button again or by activating the Scan or Repeat Play functions.

When the SHF button is pressed and held for at least 2 seconds, the **DSF** indication will appear on the display panel and the discs in the magazine will be played in a random, shuffled order, as well as the tracks on each disc. After playing the tracks at random from a disc in the magazine, the unit will select another disc at random and play all the tracks on it in a random shuffled order. This will continue from disc-to-disc until the Shuffle Disc mode is canceled by pressing the SHF button again or by activating the Scan or Repeat Play functions.

CD CHANGER ERROR CODES

If a problem should develop while operating the CD changer, the following error codes may appear on the display panel.

ER-1: Indicates that there is no magazine loaded in the CD changer.

ER-2: Indicates a problem with the magazine eject function.

ER-3: Indicates an error in the disc loading function.

ER-4: Indicates an error in the disc un-loading function.

ER-5: Indicates an error in the magazine position.

ER-6: Indicates an error in the laser pick-up position.

ER-7: Indicates an error in the laser focus on the disc.

In any of the above situations, try ejecting the CD magazine from the changer and make sure the discs are clean, undamaged, and loaded correctly (refer to the Owner's Manual of the CD changer). Re-load the magazine and check for proper operation. You may also try activating the **RESET** button ③ on the unit, but this will also erase the time and pre-set memories.

If the suggested measures do not solve the problem, contact an approved warranty station near you for further assistance.

WIRELESS REMOTE CONTROL OPERATION

The wireless remote control supplied with this model is capable of operating most of the features of the unit from a remote location. Each button on the remote control functions in the same way as the referenced button on the main unit. For optimal operation of the remote control, always aim it toward the Remote Sensor (33) on the front panel of the main unit.

- ① **PWR ON/OFF** - See Main Unit ①.
- ② **INFRARED SENDER** - Emits infrared signal to radio which is detected by the sensor ③.
- ③ **MODE SELECTOR (MODE)** - See Main Unit ⑱ and ⑳.
- ④ **TIME/FREQUENCY (T/F) SET** - See Main Unit ⑳.
- ⑤ **AM/FM BAND SELECTOR (BAND)** - See Main Unit ⑩.
- ⑥ **UP/DOWN TUNING** - See Main Unit ⑪.
- AUTOMATIC SEEK TUNING** - See Main Unit ⑪.
- CD TRACK SELECT** - See Main Unit ⑳ and ㉓.
- CD CUE/REVIEW** - See Main Unit ㉑ and ㉒.
- ⑦ **TRACK/DISC SCAN (SCN)** - See Main Unit ㉓ and ㉔.

- ⑧ **TRACK/DISC REPEAT (RPT)** - See Main Unit ㉔ and ㉕.
- ⑨ **RADIO PRE-SET MEMORY 1-6** - See Main Unit ⑮.
- ⑩ **DISC UP SELECT (D.UP)** - See Main Unit ㉖.

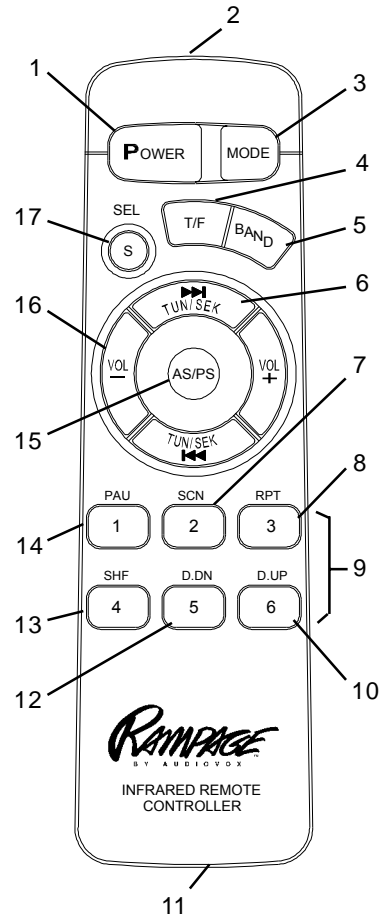

- ⑪ **BATTERY COMPARTMENT** - Holds two AAA batteries for remote wireless control operation.
- ⑫ **DISC DOWN SELECT (D.DN)** - See Main Unit ⑳.
- ⑬ **TRACK/DISC SHUFFLE (SHF)** - See Main Unit ㉕ and ④⑩.
- ⑭ **PAUSE (PAU)** - See Main Unit ㉒.
- ⑮ **AUTO STORE/PRESET SCAN (AS/PS)**- See Main Unit ⑭.
- ⑯ **AUDIO CONTROL**- See Main Unit ②, ③ ④, ⑤, ⑥, and ⑦ except press **VOL +** to increase level, and press **VOL -** to decrease level.
- ⑰ **SELECT BUTTON (SEL)** - See Main Unit ③, ④, ⑤, ⑥, and ⑦.

CARE AND MAINTENANCE

The radio section of your new sound system does not require any maintenance. We recommend you keep this manual for reference on the many features found in this unit as well as how to set the clock.

The compact disc player section also requires no routine maintenance, but proper understanding of its use and handling will help you obtain maximum enjoyment of its capabilities. The following points should be observed:

- When cleaning the interior of the vehicle, do not get water or cleaning fluids on the unit.
- The CD player is a precision instrument and will not operate properly in extreme hot or cold. In case of such conditions, wait until the interior temperature of the vehicle reaches a normal temperature before using the player.
- If the temperature inside the player gets too hot, a protective circuit will automatically stop play of the disc. In this case, allow the unit to cool off before operating the player again.
- Never insert anything other than a 5" (12 cm) compact disc into the player as the mechanism can be damaged by foreign objects.
- Do not attempt to use 3" (8 cm) CD-Single discs in this unit, either with or without an adaptor, as damage to the player and/or disc may occur. Such damage will not be covered by the Warranty on this product.
- When not using the disc player, always remove the compact disc.

- When the vehicle warms up during cold weather or under damp conditions, moisture may condense on the lens of the disc player. Should this occur, the player will not operate properly until the moisture has evaporated.
- The unit is designed with a vibration dampening CD mechanism to minimize interruption of disc play due to normal vibration in a moving vehicle. When driving on very rough roads, however, occasional sound skips may occur. This will not scratch or damage the disc and normal play will resume when the rough conditions cease.

HANDLING COMPACT DISCS

Dirt, dust, scratches, and warpage can cause skips in the playback and deterioration of sound quality. Please follow these guidelines to take care of your compact discs:



- Use only compact discs with the mark: 
- Fingerprints, dust, and dirt should be carefully wiped off the disc's playing surface (shiny side) with a soft cloth. Wipe in a straight motion from the inside to the outside of the disc.
- Never use chemicals such as record sprays, household cleaners or thinner to clean compact discs. Such chemicals can irreparably damage the disc's surface.
- Discs should be kept in their storage cases when not in use.
- Do not expose discs to direct sunlight, high temperatures or high humidity for extended periods.
- Do not stick paper, tape, or labels on the disc surfaces nor write on them with any type of marker.

12 MONTH LIMITED WARRANTY

AUDIOVOX CORPORATION (the Company) warrants to the original retail purchaser of this product that should this product or any part thereof, under normal use and conditions, be proven defective in material or workmanship within 12 months from the date of original purchase, such defect(s) will be repaired or replaced with new or reconditioned product (at the Company's option) without charge for parts and repair labor.

To obtain repair or replacement within the terms of this Warranty, the product is to be delivered with proof of warranty coverage (e.g. dated bill of sale), specification of defect(s), transportation prepaid, to the warranty center at the address shown below.

This Warranty does not extend to the elimination of car static or motor noise, to correction of antenna problems, to costs incurred for installation, removal, or reinstallation of the product, or damage to tapes, compact discs, speakers, accessories, or vehicle electrical systems.

This Warranty does not apply to any product or part thereof which, in the opinion of the Company, has suffered or been damaged through alteration, improper installation, mishandling, misuse, neglect, accident, or by removal or defacement of the factory serial number/bar code label(s). THE EXTENT OF THE COMPANY'S LIABILITY UNDER THIS WARRANTY IS LIMITED TO THE REPAIR OR REPLACEMENT PROVIDED ABOVE AND, IN NO EVENT, SHALL THE COMPANY'S LIABILITY EXCEED THE PURCHASE PRICE PAID BY PURCHASER FOR THE PRODUCT.

This Warranty is in lieu of all other express warranties or liabilities. ANY IMPLIED WARRANTIES, INCLUDING ANY IMPLIED WARRANTY OF MERCHANTABILITY, SHALL BE LIMITED TO THE DURATION OF THIS WRITTEN WARRANTY. ANY ACTION FOR BREACH OF ANY WARRANTY HEREUNDER INCLUDING ANY IMPLIED WARRANTY OF MERCHANTABILITY MUST BE BROUGHT WITHIN A PERIOD OF 30 MONTHS FROM DATE OF ORIGINAL PURCHASE. IN NO CASE SHALL THE COMPANY BE LIABLE FOR ANY CONSEQUENTIAL OR INCIDENTAL DAMAGES FOR BREACH OF THIS OR ANY OTHER WARRANTY, EXPRESS OR IMPLIED, WHATSOEVER. No person or representative is authorized to assume for the Company any liability other than expressed herein in connection with the sale of this product.

Some states do not allow limitations on how long an implied warranty lasts or the exclusion or limitation of incidental or consequential damage so the above limitations or exclusions may not apply to you. This Warranty gives you specific legal rights and you may also have other rights which vary from state to state.

U.S.A.: AUDIOVOX CORPORATION, 150 MARCUS BLVD., HAUPPAUGE, NY 11788 • 1-800-645-4994
CANADA: CALL 1-800-645-4994 FOR LOCATION OF WARRANTY STATION SERVING YOUR AREA

128-4270E



For Customer Service
Visit Our Website At
www.audiovox.com
Product Information, Photos,
FAQ's, Owner's Manuals

© 2001 Audiovox Electronics Corp., Hauppauge, NY 11788

Printed in China

128-6003A

128-6003A
20 of 20

Free Manuals Download Website

<http://myh66.com>

<http://usermanuals.us>

<http://www.somanuals.com>

<http://www.4manuals.cc>

<http://www.manual-lib.com>

<http://www.404manual.com>

<http://www.luxmanual.com>

<http://aubethermostatmanual.com>

Golf course search by state

<http://golfingnear.com>

Email search by domain

<http://emailbydomain.com>

Auto manuals search

<http://auto.somanuals.com>

TV manuals search

<http://tv.somanuals.com>