

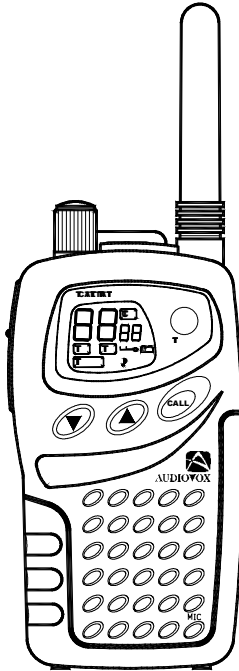

**Owner's Manual**  
**Model FR-140**  
**Two Way Family Radio**



Customer Service  
1-800-654-4994

CONGRATULATIONS ON YOUR SELECTION  
OF THE FR-140 (FAMILY RADIO)

It is one the most sophisticated and reliable two way  
Family radios available.

BEFORE OPERATING YOUR FR-140 (FAMILY RADIO)  
READ THIS MANUAL CAREFULLY

FCC WARNING

Replacement or substitution of transistors, diodes or  
other parts of a unique nature, with parts other than those  
recommended by the manufacturer, may cause a violation  
of the technical regulations of Part 15 of FCC Rules.

---

## ■ FEATURES

---

Your FR-140 Family Radio is a portable, easy to use, two-way radio that you can carry almost anywhere. It is skillfully constructed to give you reliable communications for many different applications. The FR-140 is ideal for use around the house, in your boat, on hunting and camping trips, on the ski slopes or at the mall.

Advanced PLL circuitry uses a new technique for generating the required frequencies, with less dependency on crystals. The result is much tighter frequency control and superior reliability.

---

## ■ PERFORMANCE

---

Your transceiver will achieve its maximum operating range when communicating with another transmitter in a flat open area with no trees or buildings obstructing its signal. Range may be up to two miles under such conditions. Obstacles such as buildings, trees or mountains will tend to reduce the transceiver's effective range.

---

**FUNCTION AND LOCATION OF THE CONTROLS**

---

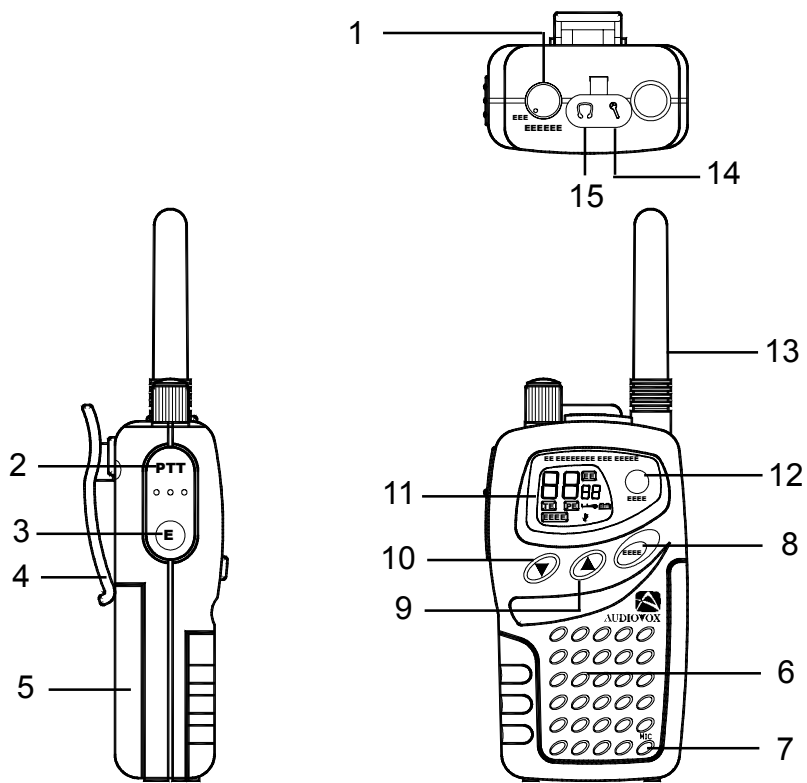

1. **Power On/Off - Volume Control:** Rotate clockwise to turn the unit on and increase the listening volume level. Rotate counterclockwise to decrease the listening volume level or turn the transceiver off.
2. **Push-to-Talk (PTT) button:** Press to transmit. Release to receive.
3. **Monitor Button (M):** Press and hold to bypass the squelch and listen to channel activity.
4. **Belt Clip**
5. **Battery Compartment**
6. **Speaker**
7. **Microphone**
8. **Call Button:** Press and hold this button to send a ringing sound to other radios tuned to the same channel and CTCSS code.
9. **Up Button:** Press this button to increase the channel number.
10. **Down Button:** Press this button to decrease the channel number.
11. **LCD Display:** Displays information about the settings of the transceiver.
12. **Menu Button:** Press this button to scroll through the following settings: TC, SCan, BP, LC
13. **Antenna**
14. **Microphone Jack:** For use with an external microphone and PTT button.
15. **Speaker Jack:** For use with an external speaker.



---

## ■ LCD DISPLAY AND OPERATION

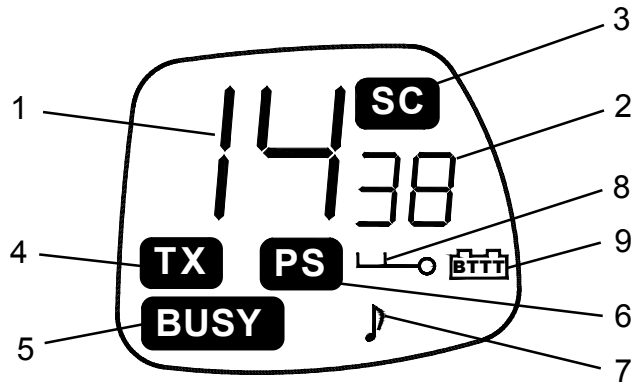
---



The FR-140 is equipped with an LCD display to indicate its settings and functions. The Display incorporates automatic backlighting to allow it to be seen in the dark. Pressing any of the buttons except the PTT (Push-to-Talk) button, will illuminate the display. The display will remain lit for 5 seconds after any of these buttons is pressed.

- 1    14    Displays the current channel number (1 to 14).
- 2    38    Displays the current CTCSS number (1 to 38).
- 3    **SC**    Appears while scanning channels.
- 4    **TX**    Appears while transmitting.
- 5    **BUSY**    Appears while receiving.
- 6    **PS**    Power Saver: Appears when the battery saver mode is active
- 7        Appears while the Button Conformation Tone feature is activated.
- 8        Appears while the keypad is locked
- 9        Flashes when the battery voltage is low. The transceiver will also beep to indicate low battery voltage.

---

## ■ BATTERY INSTALLATION

---

Your FR-140 requires three “AA” alkaline cells or three rechargeable “AA” nickel - cadmium cells. Alkaline batteries will provide the best performance from your transceiver. Remove the battery cover by releasing the clasp at the bottom of the unit and lifting the cover from the battery compartment. Observe the polarity symbols inside the battery tray when installing the batteries.

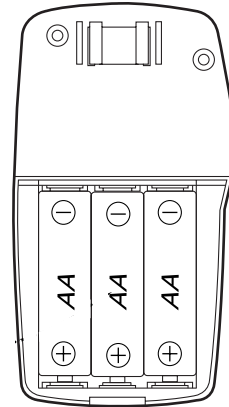

**CAUTION:** Incorrect battery installation can damage the unit.

---

## ■ BATTERY SAVER MODE

---

Your FR-140 has a unique circuit designed to dramatically extend the life of its batteries. Ten seconds after the transmit button has been pressed, the FR-140 will switch to battery saver mode. This will be indicated by the flashing **PS** (Power Saver) icon. The transceiver will remain ready to receive any incoming transmissions while in the battery saver mode. Pressing any of the buttons will exit the battery saver mode.



---

## ■ USING YOUR FR-140

---

### To Select a Channel

Use the UP and DOWN buttons to select the desired channel from 1 to 14. The current channel setting will be shown on the display.

**NOTE:** If the keypad lock  icon is shown on the display, you will need to unlock the keypad. (See the description of the keypad lock later in this manual).

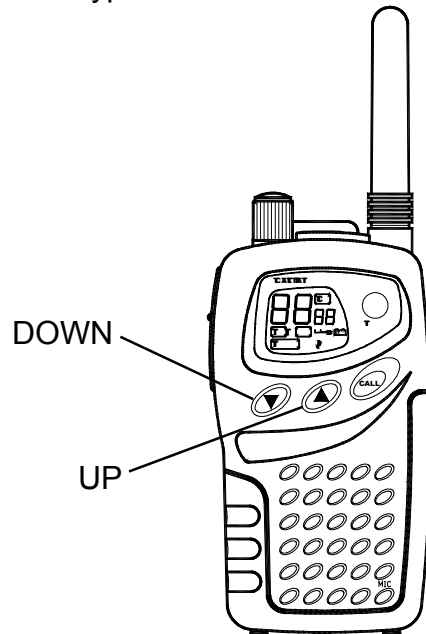

### To Receive

1. Turn the power on.
2. Check the battery condition on the display. If the  icon is displayed, charge or replace the batteries.
3. Set the desired channel and CTCSS code.
4. Adjust the volume control to the desired listening volume by pressing and holding the monitor button while turning the volume control knob.
5. The **BUSY** icon will be displayed when the transceiver detects an incoming transmission.



### To Transmit

1. Set the desired channel.
2. Press and hold the PTT (Push-to-Talk) button while speaking slowly and clearly in a normal voice, approximately 2 to 3 inches from the microphone.
3. The **TX** icon will be displayed while transmitting.
4. Release the PTT button when you finish speaking to receive incoming signals.

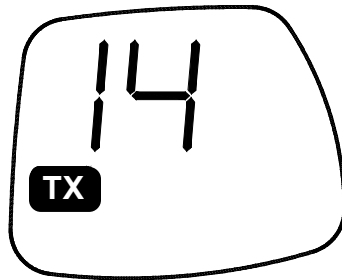

### **Menu Button**

Pressing this button will sequentially select among the following features, Continuous Tone Coded Squelch System (tc), channel scan (SCan), button conformation tones (BP) and the keypad lock (LC). Each successive press of the button will advance the display to the next feature in order. If no buttons are pressed for 5 seconds, the unit will return to standby mode and the display will indicate the current channel. Pressing the PTT or Monitor button will also return to the standby mode.

### **Continuous Tone Coded Squelch System (CTCSS)**

This feature allows you to ignore transmissions from other units that are using the same channel. One of 38 privacy codes may be selected. The same code must also be selected on those transceivers with which you desire to communicate. Keep in mind, however, that this feature does not prevent others from listening to your transmissions.

To select a CTCSS squelch code, press the menu button once or until "tc" is shown on the display. The small flashing numbers to the right represent the current squelch code setting. "OF" (off) indicates that the CTCSS system is off. Use the UP and DOWN buttons to select the desired squelch code number. To allow the transceiver to receive all messages on a particular channel select the "OF" (off) setting. After 5 seconds, the unit will return to the standby mode and the CTCSS squelch code will be effective on all 14 channels. The Display will indicate the current channel number with large digits on the left and the current CTCSS squelch code with the smaller digits to the right. Only the channel number will be displayed if the CTCSS system is off.

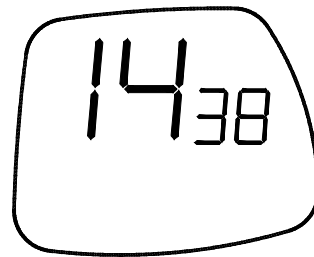
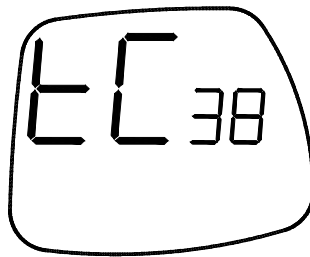

**Continuous Tone Coded Squelch System  
Tone Frequencies**

<b>CTCSS</b>	<b>Freq. Hz</b>	<b>CTCSS</b>	<b>Freq. Hz</b>
1	67.0	20	131.8
2	71.9	21	136.5
3	74.4	22	141.3
4	77.0	23	146.2
5	79.7	24	151.4
6	82.5	25	156.7
7	85.4	26	162.2
8	88.5	27	167.9
9	91.5	28	173.8
10	94.8	29	179.9
11	97.4	30	186.2
12	100.0	31	192.8
13	103.5	32	203.5
14	107.2	33	210.7
15	110.9	34	218.1
16	114.8	35	225.7
17	118.8	36	233.6
18	123.0	37	241.8
19	127.3	38	250.3

### Channel Scan

This feature allows the transceiver to automatically check all 14 channels for activity. Press the menu button twice or until “SC<sub>An</sub>” is shown on the display. Pressing the UP or DOWN buttons will cause the transceiver to immediately begin scanning the channels for activity. When a signal is received, the unit will pause on that channel for the duration of the signal and an additional 5 seconds. If no other signals are received during this period, the transceiver will resume scanning. While scanning, **SC** will be shown in the upper right of the display. Pressing any of the buttons will exit scan mode.

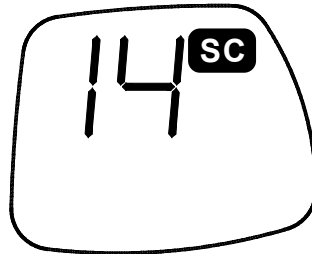

### Button Conformation Tones

The transceiver can be set to confirm each button press with a beep tone or, if the user prefers, these confirmation tones can be turned off. Whenever the tones are on, the 🎵 icon will be shown on the display. To turn the beep tones on or off, press the menu button three times or until "BP" shows on the display. The current setting will be indicated by the two smaller characters to the right ("on" or "of" (off)). Press the UP or DOWN button to change the setting. After 5 seconds, the unit will return to the standby mode.

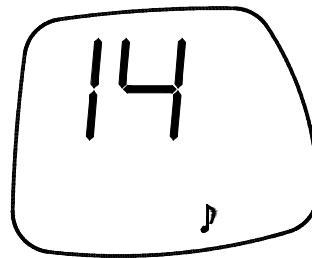
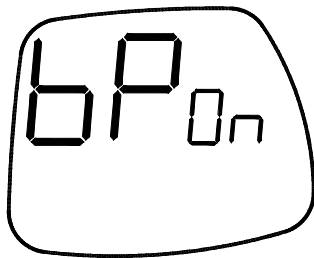



### Keypad Lock

To prevent the transceiver's settings from being inadvertently changed, the keypad can be locked. This will inhibit the function of the UP and DOWN buttons. This is useful when the FR-140 is being used by small children, or when the unit is kept in a pocket. A key icon will be shown on the display whenever the keypad is locked. To lock or unlock the keypad, press the menu button four times or until "LC" is shown on the display. The current setting will be indicated by the two smaller characters to the right. ("on" indicates the keypad is locked, "of" (off) indicates that the keypad is unlocked). Press the UP or DOWN button to change the setting. After 5 seconds, the unit will return to the standby mode.

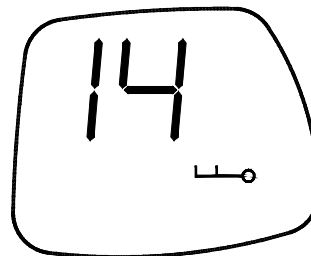
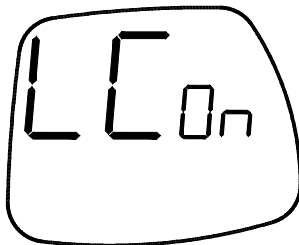

### Call Button

Press this button to transmit a ringing tone to all other transceivers set to the same channel and CTCSS code.

---

**■ WARNING**

---

Remove the batteries from the transceiver if it is not expected to be used for long periods. This will eliminate the possibility of battery acid leaking from the batteries and corroding the transceiver.

Avoid exposing the unit to water or extremes of temperature.

Do not use this device in or near a mining facility, which uses remotely triggered explosives or in areas labeled "Blasting Area". Premature or accidental detonation may result.

Do not attempt to modify or in any way increase the output of this transceiver. Its output is designed to meet the legal limits set by the FCC.

Do not use this device or change its batteries in potentially explosive atmospheres as sparks in such areas could result in an explosion.

Turn your transceiver off wherever posted notices restrict the use of radios or cellular telephones. Facilities such as hospitals may use equipment that is sensitive to RF energy.

Turn your transceiver off on board aircraft when requested to do so.

Do not place your transceiver in front of a vehicle's air-bag. If the air-bag deploys, it could propel the transceiver like a projectile.

This transceiver complies with F.C.C. regulations for use in the United States. Use in other countries may be prohibited or restricted by local regulation. Please check with the local regulating agency before using this device outside of the United States.

---

**■ SPECIFICATIONS**

---

Channels: 14  
Output Power: 500 mw ERP  
Battery Life  
    Alkaline: 30 - 35 Hours  
    NiCd: 13 Hours  
Power Source: 4.5V DC

**Channel Frequencies:**

<b>Channel</b>	<b>MHz</b>	<b>Channel</b>	<b>MHz</b>
1	462.5625	8	467.5625
2	462.5875	9	467.5875
3	462.6125	10	467.6125
4	462.6375	11	467.6375
5	462.6625	12	467.6625
6	462.6875	13	467.6875
7	462.7125	14	467.7125

## 90 DAY LIMITED WARRANTY

Applies to Audiovox Family Radio Service Products.

AUDIOVOX CORPORATION (the Company) warrants to the original retail purchaser of this product that should this product or any part thereof, under normal use and conditions, be proven defective in material or workmanship within 90 days from the date of original purchase, such defect(s) will be repaired or replaced with new or reconditioned product (at the Company's option) without charge for parts and repair labor.

To obtain repair or replacement within the terms of this Warranty, the product is to be delivered with proof of warranty coverage (e.g. dated bill of sale), specification of defect(s), transportation prepaid, to the warranty center at the address shown below.

The Company disclaims liability for communications range of this product.

This Warranty does not apply to any product or part thereof which, in the opinion of the Company, has suffered or been damaged through alteration, improper installation, mishandling, misuse, neglect, accident, or by removal or defacement of the factory serial number/bar code label(s). THE EXTENT OF THE COMPANY'S LIABILITY UNDER THIS WARRANTY IS LIMITED TO THE REPAIR OR REPLACEMENT PROVIDED ABOVE AND, IN NO EVENT, SHALL THE COMPANY'S LIABILITY EXCEED THE PURCHASE PRICE PAID BY PURCHASER FOR THE PRODUCT.

This Warranty is in lieu of all other express warranties or liabilities. ANY IMPLIED WARRANTIES, INCLUDING ANY IMPLIED WARRANTY OF MERCHANTABILITY, SHALL BE LIMITED TO THE DURATION OF THIS WRITTEN WARRANTY. ANY ACTION FOR BREACH OF ANY WARRANTY HEREUNDER INCLUDING ANY IMPLIED WARRANTY OF MERCHANTABILITY MUST BE BROUGHT WITHIN A PERIOD OF 30 MONTHS FROM DATE OF ORIGINAL PURCHASE. IN NO CASE SHALL THE COMPANY BE LIABLE FOR ANY CONSEQUENTIAL OR INCIDENTAL DAMAGES FOR BREACH OF THIS OR ANY OTHER WARRANTY, EXPRESS OR IMPLIED, WHATSOEVER. No person or representative is authorized to assume for the Company any liability other than expressed herein in connection with the sale of this product.

AUDIOVOX CORPORATION, 150 MARCUS BLVD., HAUPPAUGE, NEW YORK 11788  
1-800-645-4994 128-5385

Insert Warranty



**AUDIOVOX**  
CORPORATION  
150 Marcus Blvd.  
Hauppauge, NY 11788

Form No 128-5378

## Free Manuals Download Website

<http://myh66.com>

<http://usermanuals.us>

<http://www.somanuals.com>

<http://www.4manuals.cc>

<http://www.manual-lib.com>

<http://www.404manual.com>

<http://www.luxmanual.com>

<http://aubethermostatmanual.com>

Golf course search by state

<http://golfingnear.com>

Email search by domain

<http://emailbydomain.com>

Auto manuals search

<http://auto.somanuals.com>

TV manuals search

<http://tv.somanuals.com>