

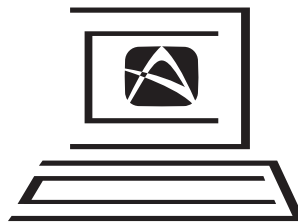

14 CHANNEL FAMILY RADIO SYSTEM MODEL # FR142

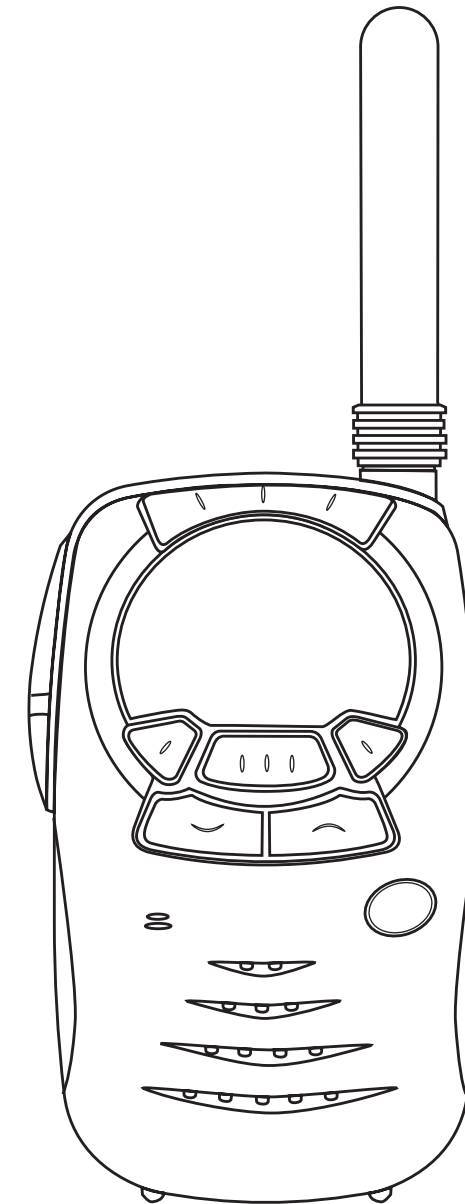

For Customer Service
Visit Our Website At
www.audiovox.com
Product Information, Photos,
FAQ's, Owner's Manuals

© 2001 Audiovox Electronics Corp., Hauppauge, NY 11788

Printed in China
128-6020

052FR142104

**BEFORE OPERATING THIS PRODUCT
PLEASE READ THESE INSTRUCTIONS
COMPLETELY**

CONTENTS

FCC Warnings	1
Features	1
Precautions	1
Unpacking	1
Controls and Indicators	2
Battery Installation	3
To Turn On or Turn Off The Unit.....	4
To Transmit	4
To Adjust Volume Control	4
To Select Main Channel	4
Monitor.....	4
Automatic Channel Scan.....	5
To Send Call Tone.....	5
To Lock Control Keys	5
To Turn On or OFF Beep	5
Frequency Range	6
General Specifications	7
Warranty	7

INTRODUCTION

We welcome you to the Family Radio Service (FRS) 2-way “transceiver” (meaning “transmitter and receiver”) radio, designed for family and friends to keep in touch without the need for a license, or radio knowledge. It provides safety and convenience almost anywhere, indoors or outdoors. The radio operates in Family Radio Service (FRS) designated frequencies. The FCC has established the license free, short range two way radio service for family and individual recreational use - anywhere in the United States & other areas listed by the FCC.

The optimal range for this 2-way radio is approximately 2 miles in open areas, less in areas with buildings, dense foliage, and mountains.

BEFORE YOU CAN TALK

Before you operate the radio, read this instruction manual carefully to know how to operate the radio.

SAFETY INFORMATION

Your wireless hand-held portable transceiver contains a low power transmitter. When the Push-to-Talk (PTT) button is pushed, it sends out radio frequency (RF) signals. The device is authorized to operate at a duty factor not to exceed 50%. In August 1996, the Federal Communications Commissions (FCC) adopted RF exposure guidelines with safety levels for hand-held wireless devices.

IMPORTANT : To maintain compliance with the FCC’s RF exposure guidelines hold the transmitter and antenna at least 1 inch (2.5 centimeters) from your face and speak in a normal voice, with the antenna pointed up and away from the face. If you wear the handset on your body, use only the Audiovox supplied belt clip for this product and ensure that the antenna is at least 1 inch (2.5 centimeters) from your body when transmitting.

Use only the supplied antenna. Unauthorized antennas, modifications, or attachments could damage the transmitter and may violate FCC regulations.

WARNING : Adjustment to this unit or replacement of any transmitter component (crystal, semiconductor, etc.) to this unit that could result in a violation of the rules.

NOTE : This equipment has been tested and found to comply with the limits for a Class B digital device, pursuant to Part 15 of the FCC Rules. These limits are designed to provide reasonable protection against harmful interference in a residential installation. This equipment generates, uses and can radiate radio frequency energy and, if not installed and used in accordance with the instructions, may cause harmful interference to radio communications.

However, there is no guarantee that interference will not occur in a particular installation. If this equipment does cause harmful interference to radio or television reception, which can be determined by turning the equipment off and on, the user is encouraged to try to correct the interference by one or more of the following measures :

- Reorient or relocate the receiving antenna.
- Increase the separation between the equipment and receiver.
- Connect the equipment into an outlet on a circuit different from that to which the receiver is needed.

FCC WARNINGS

This device complies with part 15 of the FCC rules, operation is subject to the condition that this device does not cause harmful interference.

Use only the supplied antenna. Unauthorized antennas, modifications, or attachments could damage the transmitter and may violate FCC regulations.

Features

No Air Time Fees and No License Required	Up to 2 miles range
Auto Battery Saver and Auto Squelch	14 Channel
Monitor and Key Lock Button	Multi-function LED Display
Talk Confirmation Tone and Call / Ring Button	Detachable Belt Clip

PRECAUTIONS

- Do not modify or attempt to adjust the transceiver for any reason.
- Avoid extremes in exposure to water, heat, and cold. This transceiver is weather resistant but not waterproof.
- Do not expose the transceiver to long periods of direct sunlight, nor place the transceiver close to heating appliances.
- Do not place the transceiver in excessively dusty areas, humid areas, wet areas, nor on unstable surfaces.
- If smoke or something unusual is coming from the transceiver, immediately switch OFF the power and remove the batteries from the transceiver. Contact your dealer.

UNPACKING

Carefully unpack the transceiver. We recommend that you identify the items listed below before discarding the packing material.

- Transceiver1
- Belt Clip 1
- Instruction Manual 1

Controls and Indicators

1. Transmission/Reception indicator
2. PTT button
3. MONITOR button
4. ENTER/LOCK button
5. UP/DOWN buttons
6. Microphone
7. POWER button
8. MENU button
9. CALL button
10. Power Saver mode indicator
11. LED display

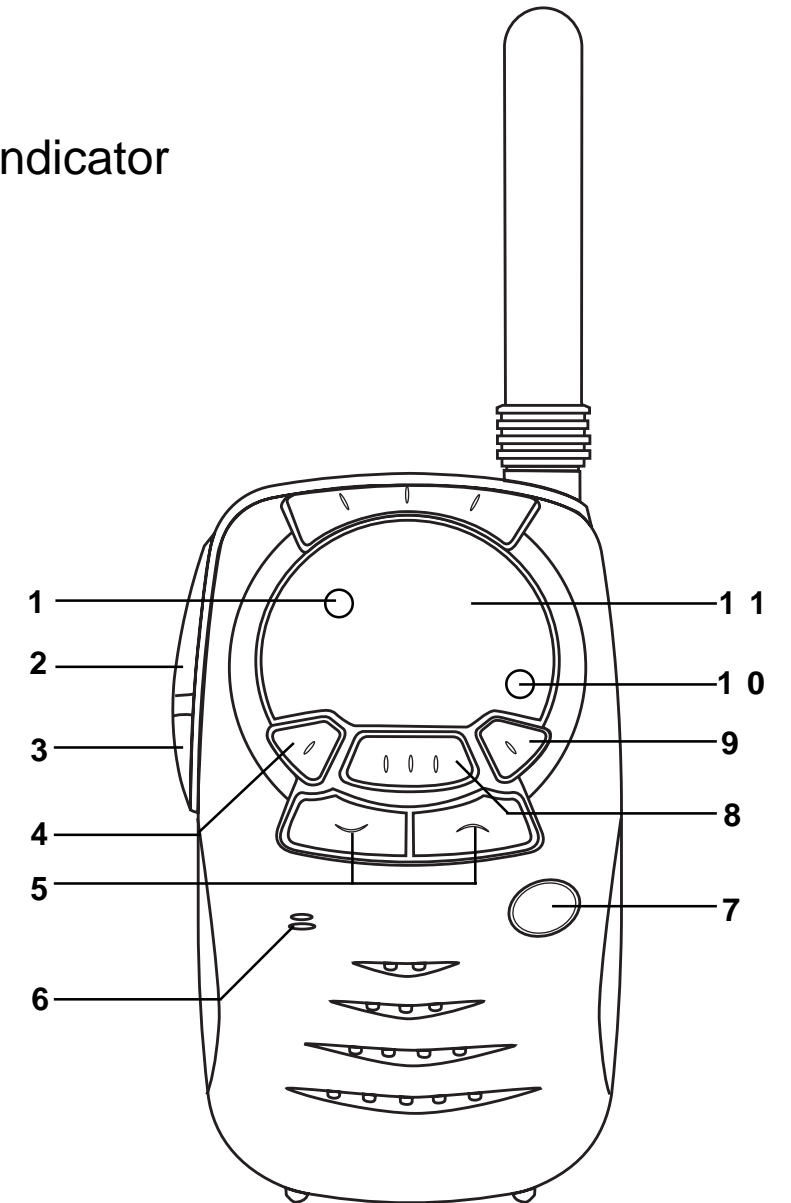

Display and Indicators

LED display - indicates Channel numbers, Volume level, Lock, Beep, Low Battery Level, etc.

Transmission and Reception indicator - When transmitting, the indicator stays on. The indicator flashes when receiving a signal.

Power Saver Mode indicator - flashes in Power Saver Mode.

Battery Installation

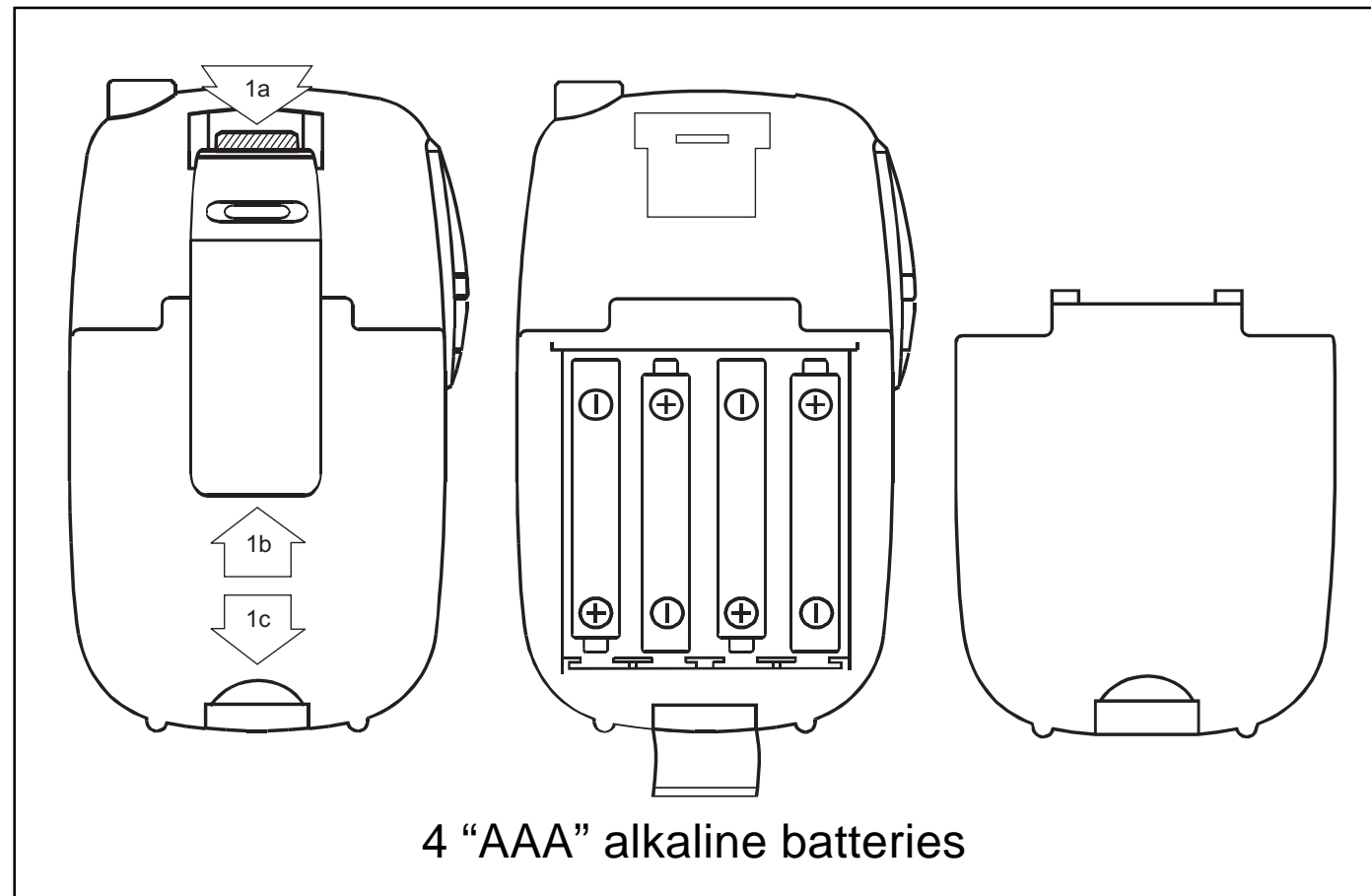

1. (a) Lift the tab of the belt clip while
(b) pushing the clip up to remove it.
(c) Pull lock tab down and lift door up (towards you) to remove battery cover.
2. Insert four "AAA" batteries. Position batteries according to polarity markings. Reverse the steps in "1" to re-assemble.

Note : • Make sure the battery + and - terminals are aligned as shown above.

- When batteries are low or need charging the BATTERY

LOW  will blink. Replace all batteries with new alkaline batteries.

To Turn On The Unit or To Turn Off The Unit

Press the POWER switch for more than 1 second.

Auto Battery Power Saver

The unit has a special circuit designed to extend battery life. If there are no transmissions within 3 seconds, the unit will automatically switch to battery save mode. The Power Saver Mode LED(Red) will flash.

Low Battery Indicator

When battery level becomes low,  appears on the LED display and flashes. Replace all four batteries with new ones.

To Transmit

Simply talk to the built-in microphone and press the PTT(Push-To-Talk) button.

To Adjust VOLUME control

Press momentarily UP button to increase or DOWN button to decrease volume.

The higher number (16), the higher volume level.

To Select Main Channel

1. Press the MENU button. The LED display indicates a flashing number.
2. Press the UP or DOWN button to set a desired channel from 1 to 14.
3. Press the ENTER button.

Monitor

The Monitor function de-squelches the receiver in any situation. Use this function when received signals are too weak to recognize or when you want to adjust the volume while listening to background noise.

Automatic Channel Scan

Press and hold the UP or DOWN button to search signals. When the unit catches a strong signal, scan will stop for 5 seconds.

If you want to stop at that channel, press the PTT or ENTER button.

To Send Call Tone

Call tone sounds like a telephone ring, and is convenient for quickly identify yourself to another party. Persons whom you call will instantly recognize you because of your call tone.

Press the CALL button to send Call Tone.  appears on the LED display and flashes.

To Lock Control Keys (UP/DOWN, MENU keys)

Press and hold the ENTER button for 2 seconds.  will appear on the display.

To unlock, press and hold the ENTER button for 2 seconds.  will appear on the display.

To Turn On or Off Beep

To turn on Beep

1. Press the MENU button twice. The LED display indicates as shown at right.

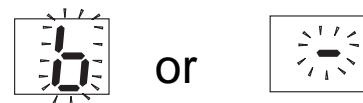

2. Press the UP or DOWN button to select below.



3. Press the ENTER button.

Frequency Range

This unit represents one of the most advanced FM two-way radios used.

FRS Channel Channel Frequency In MHz

FRS Channel	Channel Frequency In MHz
1	462.5625
2	462.5875
3	462.6125
4	462.6375
5	462.6625
6	462.6875
7	462.7125
8	467.5625
9	467.5875
10	467.6125
11	467.6375
12	467.6625
13	467.6875
14	467.7125

General Specifications

Receiver

- | | |
|--------------------------------------|--------------|
| 1. Sensitivity
For 12 dB signal | 0.25 μ V |
| 2. Max. audio output @ 10% THD | 300 mW |
| 3. Max. S/N ratio @ 1mV RF input | 40 dB |
| 4. Squelch Sens | 0.2 μ V |
| 5. Audio frequency resp.
@ 300 Hz | \pm 10 dB |
| @ 3000 Hz | \pm 10 dB |
| 6. Signal displacement BW | \pm 5 kHz |
| 7. Adjacent CH. rejection | 55 dB |
| 8. Intermodulation rejection | 55 dB |
| 9. Spurious response rejection | 55 dB |

Transmitter

- | | |
|---|-------------|
| 1. Effective radiated power | 500 mW |
| 2. Carrier freq. stability | 500 Hz |
| 3. Modulation limiting | 2.5 kHz |
| 4. Carrier attack time | 80 mS |
| 5. Audio frequency response
@ 300 Hz | \pm 10 dB |
| @ 3000 Hz | \pm 10 dB |
| 6. Audio distortion | 3 % |
| 7. Hum and Noise | 40 dB |

Power Supply

- | | |
|---|-------------|
| 1. Battery life (1-Tx : 1-Rx : 8-StandBy) | 30 Hr |
| 2. Battery, AAA x 4 | 4.8 - 6.0 V |

90 DAY LIMITED WARRANTY

Applies to Audiovox Family Radio and General Mobile Service Products.

AUDIOVOX CORPORATION (the Company) warrants to the original retail purchaser of this product that should this product or any part thereof, under normal use and conditions, be proven defective in material or workmanship within 90 days from the date of original purchase, such defect(s) will be repaired or replaced with new or reconditioned product (at the Company's option) without charge for parts and repair labor.

To obtain repair or replacement within the terms of this Warranty, the product is to be delivered with proof of warranty coverage (e.g. dated bill of sale), specification of defect(s), transportation prepaid, to the warranty center at the address shown below.

The Company disclaims liability for communications range of this product.

This Warranty does not apply to any product or part thereof which, in the opinion of the Company, has suffered or been damaged through alteration, improper installation, mishandling, misuse, neglect, accident, or by removal or defacement of the factory serial number/bar code label(s). THE EXTENT OF THE COMPANY'S LIABILITY UNDER THIS WARRANTY IS LIMITED TO THE REPAIR OR REPLACEMENT PROVIDED ABOVE AND, IN NO EVENT, SHALL THE COMPANY'S LIABILITY EXCEED THE PURCHASE PRICE PAID BY PURCHASER FOR THE PRODUCT.

This Warranty is in lieu of all other express warranties or liabilities. ANY IMPLIED WARRANTIES, INCLUDING ANY IMPLIED WARRANTY OF MERCHANTABILITY, SHALL BE LIMITED TO THE DURATION OF THIS WRITTEN WARRANTY. ANY ACTION FOR BREACH OF ANY WARRANTY HEREUNDER INCLUDING ANY IMPLIED WARRANTY OF MERCHANTABILITY MUST BE BROUGHT WITHIN A PERIOD OF 30 MONTHS FROM DATE OF ORIGINAL PURCHASE. IN NO CASE SHALL THE COMPANY BE LIABLE FOR ANY CONSEQUENTIAL OR INCIDENTAL DAMAGES FOR BREACH OF THIS OR ANY OTHER WARRANTY, EXPRESS OR IMPLIED, WHATSOEVER. No person or representative is authorized to assume for the Company any liability other than expressed herein in connection with the sale of this product.

Some states do not allow limitations on how long an implied warranty lasts or the exclusion or limitation of incidental or consequential damage so the above limitations or exclusions may not apply to you. This Warranty gives you specific legal rights and you may also have other rights which vary from state to state.

AUDIOVOX CORPORATION, 150 MARCUS BLVD., HAUPPAUGE, NEW YORK 11788
1-800-290-6650

128-5385A

Free Manuals Download Website

<http://myh66.com>

<http://usermanuals.us>

<http://www.somanuals.com>

<http://www.4manuals.cc>

<http://www.manual-lib.com>

<http://www.404manual.com>

<http://www.luxmanual.com>

<http://aubethermostatmanual.com>

Golf course search by state

<http://golfingnear.com>

Email search by domain

<http://emailbydomain.com>

Auto manuals search

<http://auto.somanuals.com>

TV manuals search

<http://tv.somanuals.com>