

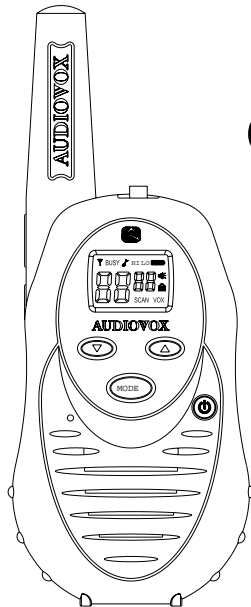

**General Mobile Radio Service (GMRS)  
Model: GMR100**



**Owner's Manual**



Released: 3-10-03

128-XXXX  
1 of 24

 **CAUTION**

NEVER ATTEMPT TO CHARGE ALKALINE OR DRY CELL BATTERIES, AS BATTERIES MAY BURST CAUSING PERSONAL INJURY AND DAMAGE TO THE PRODUCT. WHEN RECHARGING NICKEL METAL HYDRIDE (Ni-MH) BATTERIES WITH THE SUPPLIED AUDIOVOX CHARGER AND WALL ADAPTER, USE ONLY AUDIOVOX-APPROVED RECHARGEABLE BATTERIES. USE OF THE AUDIOVOX CHARGER WITH OTHER BRANDS OF BATTERIES IS NOT RECOMMENDED, AS BATTERY CHARGING TIMES WILL VARY WITH DIFFERENT BRANDS. REFER TO THE MANUFACTURER'S INSTRUCTIONS FOR CHARGING OTHER BRANDS OF BATTERIES.

AVOID PLACING THE GMRS122-2 RADIO TRANSCEIVER FOR PROLONGED PERIODS OF TIME IN DIRECT SUNLIGHT OR TEMPERATURES BELOW -4° F (-20° C) OR ABOVE 140 ° F (60° C).

KEEP THE ANTENNA AT 1 INCH (2.5 cm) AWAY FROM YOUR HEAD AND BODY. DO NOT USE YOUR GMRS122-2 RADIO TRANSCEIVER WITH A DAMAGED ANTENNA.

PLACE THE RUBBER COVERS ON JACKS WHEN NOT IN USE.

**GMRS LICENSE:**

USE OF THIS RADIO WITHIN THE UNITED STATES REQUIRES AN FCC GMRS LICENSE. AN INDIVIDUAL 18 YEARS OF AGE OR OLDER, WHO IS NOT A REPRESENTATIVE OF A FOREIGN GOVERNMENT, IS ELIGIBLE TO APPLY FOR A GMRS SYSTEM LICENSE. YOU WILL NEED TWO FORMS FROM THE FCC; FCC FORM 159 AND FCC FORM 605 MAIN FORM AND SCHEDULE F. YOU CAN FIND THE FORMS ONLINE AT: [HTTP://WWW.FCC.GOV/FORMPAGE.HTML](http://www.fcc.gov/formpage.html), OR CALL 1-800-418-3676.

**Model GMRS100 (FCC License Required)**

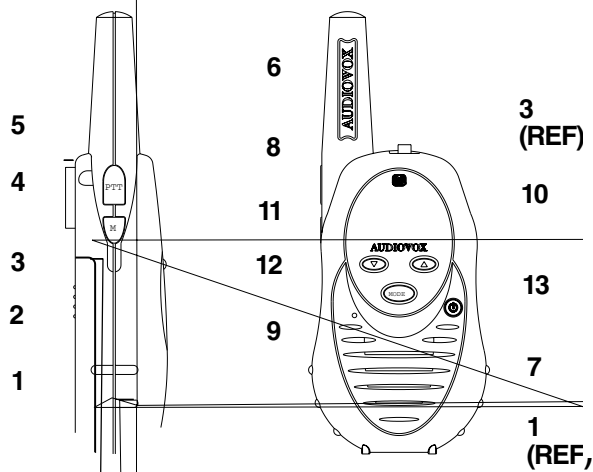

- |  |                                  |
|--|----------------------------------|
| 1. Battery Cover                                       | 8. Liquid Crystal Display (LCD)  |
| 2. Monitor (M) Button                                  | 9. Built-in Microphone           |
| 3. Detachable Carry Clip                               | 10. Up Channel/Volume Button     |
| 4. Push-To-Talk (PTT) and Function Confirmation Button | 11. Down Channel/Volume Button   |
| 5. Antenna   | 12. MODE/VOX Button              |
| 6. External Speaker (SP)/ Microphone (MIC)/CHG Jack    | 13. Power On/Off and SCAN Button |
| 7. Built-in Speaker                                    | 14. Battery Charging Contacts    |

3

**128-XXXX**  
**3 of 24**

## Model GMRS100 DISPLAY

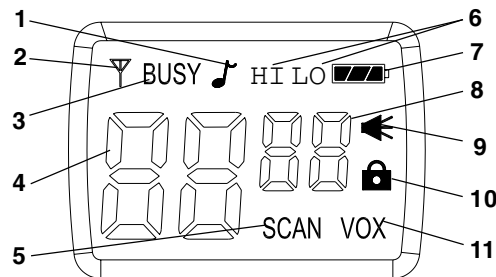

- 1. Roger Beep Tone Indicator:** This icon appears when the Roger Beep tone is on, and disappears when the tone is not in use.
- 2. Transmit Indicator:** Icon appears when the unit is in the transmit mode (PTT button activated or VOX mode active).
- 3. Busy Indicator:** This icon appears when the unit is receiving a transmission.
- 4. Large Segment Display:** Indicates the channel number in use between 1 and 22.
- 5. Scan Indicator:** This function allows the user to scan a channel every 0.5 second to search for a valid signal.
- 6. HI/LO Indicators:** Appropriate icon appears when the transmit power is set to desired output power.
- 7. Battery Level Indicator:** Icon appears flashing to indicate low battery charge level.
- 8. Small Segment Display:** Indicates the CTCSS tone code (1-38) function is active for the main channel in use.
- 9. Monitor Indicator:** This function is not used.
- 10. Key Lock Indicator:** This function is not used.
- 11. Voice Activated Transmission (VOX) Indicator:** This function allows hands-free conversation. The icon appears when the VOX mode is activated.

### **Equipment and Accessories Supplied**

- |    |                    |          |
|----|--------------------|----------|
| 1. | Radio (4)          | GMRS100  |
| 2. | Owner's Manual (1) | 128-XXXX |

### **Optional Accessories**

- |    |                            |                       |
|----|----------------------------|-----------------------|
| 1. | Rechargeable Batteries (4) | NiMH, P/N GMRS1222BAT |
| 2. | Boom Microphone/Headset    | GMRSBHST4             |
| 3. | Leather Carrying Case      | GMRS1502LC            |

### **Powering the transceiver:**

Your GMRS100 radio transceiver operates on four rechargeable batteries. Only approved rechargeable batteries can be recharged in the GMRS4WM wall mount charger. This will ensure optimum performance for the GMRS100. Battery charging time is typically 10-12 hours. Use of other brands of rechargeable batteries is not recommended as battery charging time will vary. Do not mix old and new, or batteries of differing manufacture, since the charging will be uneven and will result in decreased battery life.

If necessary, four AAA alkaline batteries can be used to power the GMRS100, but note that these type batteries can not be recharged and damage to the charger or the batteries may result if the units are placed in the GMRS4WM wall mount charger with the alkaline batteries are installed. FOR THIS REASON, IT IS NOT RECOMMENDED TO USE ALKALINE BATTERIES IN THE GMRS100.

DO NOT PLACE GMRS100 TRANSCEIVERS IN THE CHARGING STAND IF THERE ARE ALKALINE BATTERIES INSTALLED.

### Installing the batteries:

Battery installation is made more convenient when the carry clip is either rotated left or right to the horizontal position, or is removed. Simply rotate the clip in either direction to the horizontal position. Be careful not to use excessive force. To remove the clip, press down on the spring release tab and pull the clip straight out from the radio body. Next, press down with the thumb at the embossed arrow, slide the battery cover down and lift it away from the compartment. Insert four AAA batteries (alternate positive ends (+) toward the top of the transceiver, starting left-to-right).

CLIP SPRING  
RELEASE TAB

CARRY  
CLIP

BATTERY  
COVER

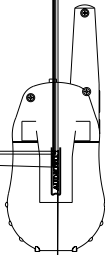

COVER  
ARROW

POSITIVE  
TERMINALS

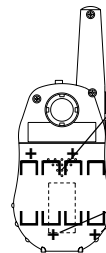

1. Using thumb, press down on battery cover at arrow and slide cover down.

2. Then lift cover at bottom to open. Remove cover.

3. Insert four AAA batteries (positive (+) end toward the top beginning at left side and alternating positive terminals as shown).

The following guidelines will improve performance and provide longer operating times for the GMRS100:

1. Do not mix old and new batteries.
2. Do not mix alkaline, standard (carbon-zinc) or rechargeable batteries.
3. If the unit is not to be used for an extended period of time, remove the batteries. Old or leaking batteries can cause damage to the unit and will void the warranty.

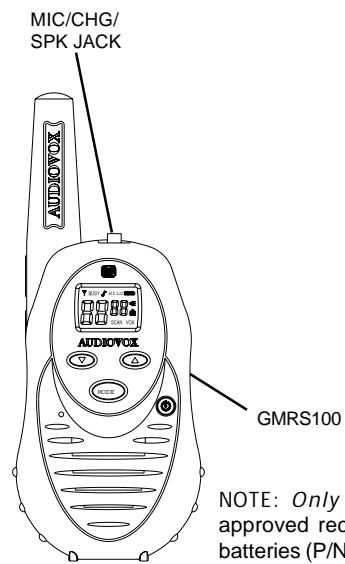

NOTE: *Only* Audiovox approved rechargeable batteries (P/N GMRS1222BAT) can be recharged in the radio transceiver.

## GMRS100 OPERATIONAL MODES

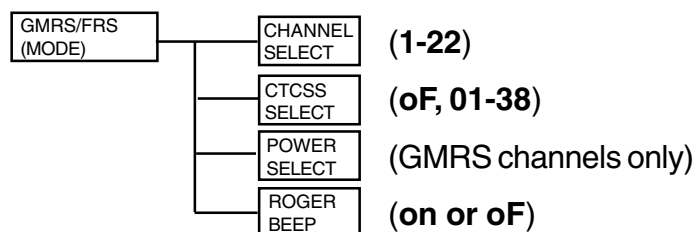

**NOTE:** To differentiate between operating modes, look for **HI** or **LO** indication below the battery power level indicator when in GMRS mode. Refer to the appropriate section of this manual for detailed operating instructions for each mode. Channels 1 through 7 are shared GMRS/FRS. Channels 8 through 14 are FRS only, and channels 15 through 22 are GMRS only.

### Controls:

#### Power On-Off/SCAN Button (13)

Press and hold the PWR on/off button for at least 2 seconds. You will hear a confirming melody to indicate the unit is on. To turn the unit off, press and hold the button for at least 2 seconds.

#### Adjusting the Volume (11, 10)

With the unit powered on, press the Up Channel/Volume button (▲) to increase volume and the Down Channel/Volume button (▼) to decrease



volume. The display will indicate the current volume level (VL) followed by the number (0-7). As volume is increased upward, the unit will beep at each step, and vice-versa. When the minimum and maximum volume settings are reached, a unique tone will sound.

#### **Monitor/Display Backlight Button (2)**

This button is used to check activity on the current frequency before transmitting. Check activity by pressing the Monitor (M) Button longer than 2 seconds; the BUSY icon will appear on the display and you will hear static if frequency is clear. **Do not transmit if you hear conversation.** Hold down the Monitor Button again longer than 2 seconds and the BUSY icon will disappear from the display.

The monitor function will temporarily bypass the squelch setting and play all signals on a given channel. This feature is useful when communicating with other parties at extreme range.

By pressing the monitor button momentarily, the LCD backlight is turned on; the LCD backlight will turn off automatically in about 5 seconds, unless the monitor button is pressed momentarily once again.

#### **Push To Talk (PTT) Button (4)**

Pressing and holding this button will allow you to speak to any transceiver that is set to the same channel and privacy code setting as yours. Hold the transceiver approximately 1 to 2 inches from your face as you speak into the built in microphone (9). After you have finished speaking, release the PTT Button to allow reception of incoming signals. It is not possible to transmit and receive at the same time. Whenever the button is pressed, the transmit signal icon ( Ψ ) will appear in the upper left corner of the display. Releasing the button allows the unit to revert to standby mode. When receiving an incoming signal, the BUSY icon will appear.

The PTT Button can also be used as a two-way call ringer. Pressing the button twice quickly will call another party on the same channel. The transmit icon ( Ψ ) will be displayed for 3 seconds and then disappear.

#### **Up Channel/Volume Button (10)**

In the standby mode, pressing this button will increment the listening volume. When in function edit mode this button will be used to adjust the unit's settings.

#### **Down Channel/Volume Button (11)**

In the standby mode, pressing this button will decrement the listening volume. When in function edit mode this button will be used to adjust the unit's settings.

#### **MODE Button (12)**

This button is used to select various feature settings in the GMRS and FRS modes.

#### **External Speaker (SPK)/ Microphone (MIC)/CHG Jack (6)**

This jack accepts both the optional Audiovox headset/microphone connector. For additional equipment and accessories for the GMRS100, visit the Audiovox web site at [www.audiovox.com](http://www.audiovox.com) <<http://www.audiovox.com/>>

#### **Scan Button (13)**

With the unit in standby mode, press the Power On/Off Button momentarily to enable or disable the scan function; **SCAN** will appear on the display.

## Operating Modes and Features

### GRMS/FRS Operation:

- Press and hold the Power On/Off button for 2 seconds to turn on power.
- Press the MODE button so the Channel number flashes.
- Select the desired channel with the Up (10) and Down (11) Buttons. When receiving a call, the **BUSY** icon appears to indicate an incoming call.
- Press and hold the PTT button (4) to transmit, then speak into the microphone clearly and slowly. The Transmit icon ( **Ψ** ) appears on the display while the button is pressed.
- Release PTT Button (4) to receive.
- Communication can only be accomplished when the channel and CTCSS tone frequency of at least two parties are the same.
- The CTCSS subcode (**01-38**) will be displayed on the LCD panel if the CTCSS tone frequency function is enabled (not **oF**).

### Channel Selection

In order to communicate with other GMRS/FRS units, both the transmitting and receiving party must be on the same frequency.

The GMRS100 has 22 channels (frequencies) indicated by the large digits on the LCD display panel. Channels 1 through 7 are the shared GMRS/FRS channels. Channels 8-14 are FRS only channels, while channels 15-22 are assigned GMRS only channels. If an FRS only channel (8-14) has been selected, the **HI** or **LO** icon will not be displayed on the LCD panel; otherwise, for channels 1-7 (GMRS/FRS) and 15-22 (GMRS only) the **HI** or **LO** icon will be displayed. Communication with Audiovox GMRS/FRS and compatible units is possible on these 22 channels. Before transmitting on the selected channel, press the Monitor (M) Button (2) to check the activity on that channel. If there is activity on the selected channel, change to another channel that is clear.

To change the channel:

- From GMRS/FRS standby mode, press the MODE button (12) once the channel number flashes.
- Press the Up Button (10) briefly to move to the next higher main channel number.
- Press the Down Button (11) briefly to move to the next lower main channel number.
- Press the PTT button momentarily to confirm selection.

### **CTCSS Mode (Sub-Channel) Selection**

The Coded Tone Controlled Squelch System (CTCSS) has 38 Sub-Frequencies. This feature allows you to utilize the coded squelch tones (01-38) within a main channel and enables you to communicate with another party on the same main channel using the same subcode. (This filters out unwanted transmissions from the same main channel). Since there are 38 CTCSS Sub-channels for each main channel, a different subcode may be selected for each of the 22 channels.

To change the CTCSS Sub-channel:

- From GMRS/FRS standby mode, press the MODE Button twice; a flashing **oF** or sub-channel number is displayed.
- Press the Up or Down button to select the desired sub-channel for use (**01-38**).
- Press the PTT button to confirm selection.

The CTCSS mode can be turned off by selecting the **oF** icon as the setting.

**NOTE:** To communicate with other GMRS/FRS units, they must be switched to the same channel and CTCSS subcode. To communicate with other GMRS units that do not have subcodes, switch your unit to the same channel with the subcode set to **oF**.

The CTCSS subcodes do not prevent others from hearing your transmission. This will only allow you to ignore all traffic on a given channel not using the same subcode.

### **Transmit Power Selection Mode (GMRS Channels Only)**

This feature permits selection of the transmitting power level to high or low when using channels 1-7 and 15-22. Using low power, the unit will have a lower transmit range, but battery life will be increased.

**NOTE:** You will find that for the majority of your needs, the low-power setting will provide adequate communications on all channels; there should seldom be any need to use high power, except in situations where you need absolute maximum range. Using low power will greatly extend battery life. We suggest you experiment with switching between low and high power.

To access the transmitter power selection function:

- From GMRS standby mode, press the MODE Button 3 times until the **Po** indication appears flashing on the display with a steady **Hi** or **Lo** indication.
- Press the Up or Down button to toggle between the High and Low selections.
- Press the PTT button to confirm selection.

The display will indicate the current setting in standby mode.

### **Roger Beep Tone**

The Roger Beep is a tone which is automatically transmitted whenever the PTT button is released and the tone is enabled. This tone alerts the receiving party that the transmission has been terminated intentionally.

To enable and disable the Roger Beep tone:

- From GMRS/FRS standby mode, press the MODE Button 4 times (in FRS mode, 3 times) until the flashing Roger Beep icon ( 🎵 ) appears with **On** or **oF**.
- Press the Up or Down Button to select the tone on or off as desired.
- When enabled, the tone icon ( 🎵 ) appears steady on the display.
- Press the PTT button momentarily to confirm selection.

### **VOX Selection Mode**

This option enables you to have hands-free conversation. When using the internal microphone/speaker or external microphone/headset (**purchased separately**), your voice or the signal is detected and the radio transmits and receives automatically. Your voice or nearby sound is detected and the radio transmits without the need to press the PTT button.

To set the radio for VOX operation:

- From GMRS/FRS standby mode, press and hold the MODE button for 3 seconds, or until the **VOX** icon appears on the display.
- To terminate VOX operation, press and hold the MODE button for at least 3 seconds; the VOX indication will disappear.

### **Button Beep (Key Tone)**

This feature allows the transceiver to sound a confirmation tone whenever the following keys are pressed: Power On/Off/SCAN Button, Up/Down Buttons and MODE Button. This feature is always on.

### **Call Ringer Selection Mode**

The transceiver provides a transmit call ring melody at the receiving unit to alert you to an incoming call.

To activate the call ringer melody:

- From GMRS/FRS standby mode, press the PTT button twice in quick succession; a call ring melody will sound at the receiving unit to alert the user to an incoming transmission, provided that unit is equipped with this capability and set to the same channel.

### **Channel Scan Operation**

This feature allows you to monitor all channels automatically for valid signals. While scanning, you can transmit and receive. When a signal is received, the scan is interrupted and will return to scan mode approximately 5 seconds after reception is terminated.

**NOTE:** While the SCAN mode is active, the MODE button is inoperative. In addition, the scan mode will reduce the overall battery life since the battery save function is overridden.

To enable the channel scan mode:

- From GMRS/FRS standby mode, momentarily press the Power On/Off Button; **SCAN** will appear on the LCD display.
- The radio will automatically display each channel (1-22) in ascending order to find an active main channel.
- When the unit doesn't find any signals and you want to transmit, press the PTT Button to return to primary channel operation. The transceiver will automatically resume scanning approximately 15 seconds after the communication is completed.
- If there is no activity and you want to leave the scan mode, press the Power On/Off button momentarily and the unit will return to normal operation; the **SCAN** icon will disappear from the LCD display.

### **Battery Alert**

When the battery icon () blinks steadily on the LCD panel, recharge the unit or install fresh batteries.

### **NOTES FOR GOOD COMMUNICATION**

1. The GMRS100 22 channels are shared on a 'take turns' basis. This means other groups may be talking on any of the channels. A common code of ethics/courtesy is to switch to another vacant channel and not to attempt to talk over someone who is already using the channel you first selected.
2. The GMRS100 has been designed to maximize performance and improve transmission range in the field. To avoid interference, it is recommended that you do not use the units closer than 5 feet apart.
3. For best transmission results, always keep your mouth about 2-3 inches from the microphone (9) and speak slowly in a normal voice.
4. To increase battery life, use the SCAN feature sparingly. This feature will reduce operating time considerably.

### **Warning**

- Do not operate the transceiver unless you are licensed to do so.
- Remove the batteries from the transceiver if it is not expected to be used for long periods. This will eliminate the possibility of chemicals leaking from the batteries and corroding the transceiver.
- Avoid exposing the transceiver to water or extremes of temperature.
- Do not use this device in or near a mining facility, which uses remotely triggered explosives or in areas labeled "Blasting Area". Premature or accidental detonation may result.



- Do not attempt to modify or in any way increase the output of this transceiver. Its output is designed to meet the legal limits set by the FCC.
- Do not use this device or change its batteries in potentially explosive atmospheres as sparks in such areas could result in an explosion.
- Turn your transceiver off wherever posted notices restrict the use of radios or cellular telephones. Facilities such as hospitals may use equipment that is sensitive to RF energy.
- Turn your transceiver off on board aircraft when requested to do so.
- Do not place your radio in front of a vehicle's air-bag. If the air-bag deploys, it could propel the transceiver like a projectile causing bodily injury.

## Troubleshooting

Problem	Possible cause	Correction
No transmission while pressing the PTT Button	Weak batteries	Charge or replace batteries
	Incorrect battery polarity	Install the batteries following the directions in paragraph Installing the Batteries.
Weak or no signal received	Weak batteries	Charge or replace batteries
	Channel and privacy code not set the same as target transceiver	Adjust the transceiver's settings to match those settings of the target transceiver
	Volume level too low PTT Button inadvertently depressed	Increase volume level Release PTT Button
	Excessive radio interference on a particular channel Obstruction of radio signal	Change to a different channel Avoid operating in or near large buildings or vehicles
Unit beeps, but will not function when turned on	Batteries extremely discharged	Charge or replace batteries
Reception of unwanted signals	CTCSS privacy mode not on	Turn on the CTCSS privacy mode and set code number to match the setting of the target transceiver.
	Interference from electronic devices such as computers or TVs	Turn the devices off or move farther away from them.

## Technical Specifications:

### General

Frequency Range:	
Channels 1 through 7 are shared with FRS radios.	Refer to frequency chart on next page.
Channels 8 through 14 are FRS only.	Refer to frequency chart on next page.
Channels 15 through 22 are GMRS only.	Refer to frequency chart on next page.
Channel Spacing	12.5kHz
Privacy Codes	38 for each main channel
Dimensions (W x H x D) (Without Antenna)	2.25" W x 3.68" H x 1.125" D (56.0 mm x 93.7 mm x 28.5 mm)

### Power Supply

Power Source	Ni-MH rechargeable, AAA (4), 4.8 VDC, 650 mAh
Operating Time (Transmit: Receive: Standby) (5: 5: 90 ratio)	18 hours Low Power 11 hours High Power

### Receiver

Useable Sensitivity	>-119 dBm
Maximum Audio Output Power	> 0.3 Watt maximum (8 Ohm )
Modulation Distortion	< 5% (1 kHz 70%)

### Transmitter

RF Output Power	1.8 Watts maximum (high power) 0.5 Watt maximum (low power)
Maximum Deviation	+/- 2.5 kHz
Modulation Distortion	< 5% (1 kHz 70%)

19

**128-xxxx**  
**19 of 24**

This transceiver complies with FCC regulations for use in the United States of America. Use in other countries may be prohibited or restricted by local regulation. Please check with the local regulating agency before using this device outside the United States of America.

### Main Channel Frequencies:

CHANNEL/TYPE	FREQ (MHz)	CHANNEL/TYPE	FREQ (MHz)
1 GMRS/FRS	462.5625	12 FRS	467.6625
2 GMRS/FRS	462.5875	13 FRS	467.6875
3 GMRS/FRS	462.6125	14 FRS	467.7125
4 GMRS/FRS	462.6375	15 GMRS	462.5500
5 GMRS/FRS	462.6625	16 GMRS	462.5750
6 GMRS/FRS	462.6875	17 GMRS	462.6000
7 GMRS/FRS	462.7125	18 GMRS	462.6250
8 FRS	467.5625	19 GMRS	462.6500
9 FRS	467.5875	20 GMRS	462.6750
10 FRS	467.6125	21 GMRS	462.7000
11 FRS	467.6375	22 GMRS	462.7250

**NOTE:** Channels 1 through 7 are shared with FRS radios.

Channels 8 through 14 are FRS only.

Channels 15 through 22 are GMRS only.

**Continuous Tone Coded Squelch System Tone  
Frequencies (in Hz)**

<b>CTCSS</b>	<b>Freq. Hz</b>	<b>CTCSS</b>	<b>Freq. Hz</b>
1	67.0	20	131.8
2	71.9	21	136.5
3	74.4	22	141.3
4	77.0	23	146.2
5	79.7	24	151.4
6	82.5	25	156.7
7	85.4	26	162.2
8	88.5	27	167.9
9	91.5	28	173.8
10	94.8	29	179.9
11	97.4	30	186.2
12	100.0	31	192.8
13	103.5	32	203.5
14	107.2	33	210.7
15	110.9	34	218.1
16	114.8	35	225.7
17	118.8	36	233.6
18	123.0	37	241.8
19	127.3	38	250.3

\* oF = No Tone

## 90 DAY / 12 MONTH LIMITED WARRANTY

AUDIOVOX SPECIALIZED APPLICATION, LLC (the Company) warrants to the original retail purchaser of this product that should this product or any part thereof, under normal use and conditions, be proven defective in material or workman ship within 90 days from the date of original purchase, such defect(s) will be repaired or initial 90 day period and for a period of 12 months from the date of original purchase, the Company will supply at no charge a replacement for any defective part(s), but will charge for the labor to repair the product.

To obtain repair or replacement within the terms of this warranty, the product is to be delivered with proof of warranty coverage (e.g. dated bill of sale), specification of defect(s), transportation prepaid, to an approved warranty station, or the Company at the address shown below.

This warranty does not extend to the elimination of externally generated static or noise, to the correction of antenna problems, to costs incurred for removal or reinstallation of the product, or to damage to any tapes, speakers, accessories, or electrical systems.

This warranty does not apply to any product or part thereof which, in the opinion of the Company, has been damaged through alteration, improper installation, mishandling, misuse, neglect, or accident. THE EXTENT OF THE COMPANY'S LIABILITY UNDER THIS WARRANTY IS LIMITED TO THE REPAIR OR REPLACEMENT PROVIDED ABOVE, AND, IN NO EVENT, SHALL THE COMPANY'S LIABILITY EXCEED THE PURCHASE PRICE PAID BY THE PURCHASER FOR THE PRODUCT.

This warranty is in lieu of all other express warranties or liabilities. ANY IMPLIED WARRANTIES, INCLUDING ANY IMPLIED WARRANTY OF MERCHANTABILITY, SHALL BE LIMITED TO THE DURATION OF THIS WARRANTY. ANY ACTION FOR BREACH OF ANY WARRANTY HEREUNDER INCLUDING ANY IMPLIED WARRANTY OF MERCHANTABILITY MUST BE BROUGHT WITHIN A PERIOD OF 30 DAYS FROM THE DATE OF ORIGINAL PURCHASE. IN NO CASE SHALL THE COMPANY BE LIABLE FOR ANY CONSEQUENTIAL OR INCIDENTAL DAMAGES FOR BREACH OF THIS OR ANY OTHER WARRANTY, EXPRESS OR IMPLIED, WHATSOEVER. No person or representative is authorized to assume for the Company any liability other than that expressed herein in connection with the sale of this product.

Some states do not allow limitations on how long an implied warranty lasts or the exclusion or limitation of incidental or consequential damages so the above limitations or exclusions may not apply to you. This warranty gives you specific legal rights and you may also have other rights which vary from state to state.

AUDIOVOX SPECIALIZED APPLICATIONS, LLC  
Visit us at [www.asaelectronics.com](http://www.asaelectronics.com)



THIS PAGE LEFT BLANK INTENTIONALLY





Printed in China

128-xxxx

128-xxxx  
24 of 24



## Free Manuals Download Website

<http://myh66.com>

<http://usermanuals.us>

<http://www.somanuals.com>

<http://www.4manuals.cc>

<http://www.manual-lib.com>

<http://www.404manual.com>

<http://www.luxmanual.com>

<http://aubethermostatmanual.com>

Golf course search by state

<http://golfingnear.com>

Email search by domain

<http://emailbydomain.com>

Auto manuals search

<http://auto.somanuals.com>

TV manuals search

<http://tv.somanuals.com>