



E X S 9 9 8 0

OWNER'S MANUAL

900 MHz Digital
Spread Spectrum
Technology

Caller ID

Call Waiting
Caller ID

Digital Answering
System

Uniden®

INTRODUCTION

TO YOUR NEW PHONE

Introduction

Congratulations on your purchase of the EXS 9980 cordless telephone. This phone is designed for reliability, long life, and outstanding performance utilizing the latest in 900 MHz Spread Spectrum technology.

Note: Some illustrations in this manual may differ from the actual unit for explanation purposes.

Features

- 900 MHz Spread Spectrum Technology
- Digital Answering Device
- Caller ID and Call Waiting Caller ID
- 50 Number Caller ID Memory
- 3-Line, 16 Character Backlit Handset Display
- 20 Enhanced Memory Dial Locations
- 32 Digit Redial
- 2nd Battery Capability
- Back-up Power Supply with Optional Battery Pack
- 3 Redial memories
- Flash and Pause
- Pulse / Tone Dialing
- 3-Way Conference Operation
- Speakerphone
- 2-Way Page/Intercom
- Page / Find
- 7 Day Standby Battery Life
- 4 Hour Talk Time
- Handset Earpiece and Ringer Volume Control
- Hearing Aid Compatible

Digital Spread Spectrum Technology utilizes a “wider frequency band” vs. a “single narrow band” used in standard digital transmissions. The result is a more secure conversation with the clarity of digital sound, extended range, and minimal interference from other cordless phone.

Random Code™ digital security automatically selects one of over 65,000 codes for the handset and base.

These features enhance your phone’s security and also prevent unauthorized calls as a result of your phone being activated by other equipment.

Controls and functions

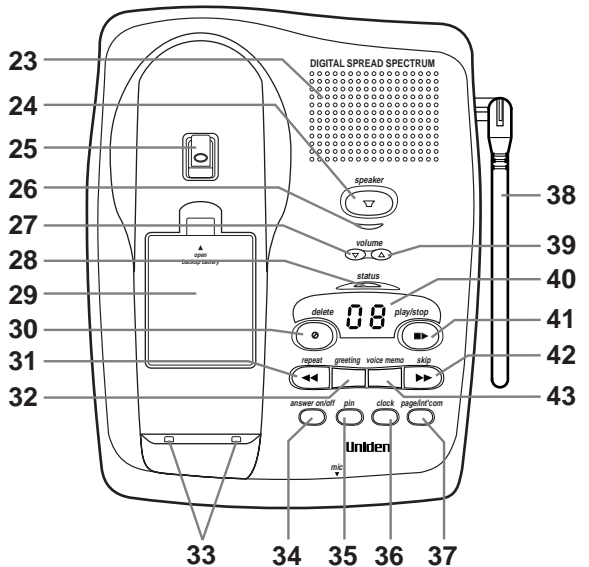
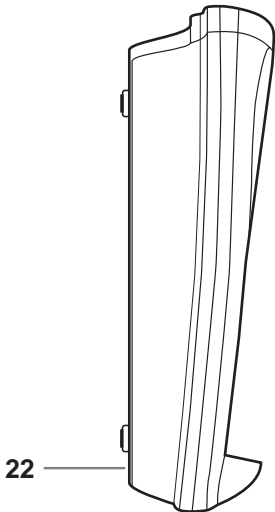
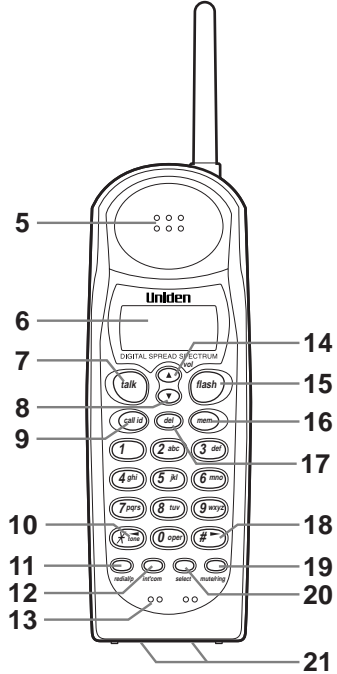
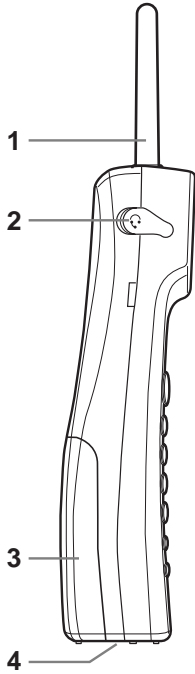

1. Handset antenna
2. Headset jack cover
3. Handset battery compartment
4. Ringer off-on switch
5. Handset earpiece
6. LCD display
7. Talk key
8. Volume/Cursor down key
9. Call ID key
10. Tone/Backspace key
11. Redial/Pause key
12. Intercom key
13. Handset microphone
14. Volume/Cursor up key
15. Flash key
16. Memory key
17. Delete key
18. Cursor forward key
19. Mute/Ring key
20. Select key
21. Handset charging contacts
22. Base microphone
23. Base speaker
24. Speaker key
25. Handset retainer clip
26. Speaker LED
27. Volume down key
28. Status LED
29. Spare battery compartment
30. Delete key
31. Repeat key
32. Greeting key
33. Base charging contacts
34. Answer on/off key
35. Pin code key
36. Clock key
37. Page/Intercom key
38. Base antenna
39. Volume up key
40. LED display
41. Play/Stop key
42. Skip key
43. Voice memo record key
44. Record time switch
45. Ring time switch
46. Ringer on/off switch
47. Pulse-Tone switch
48. DC power input
49. Phone jack

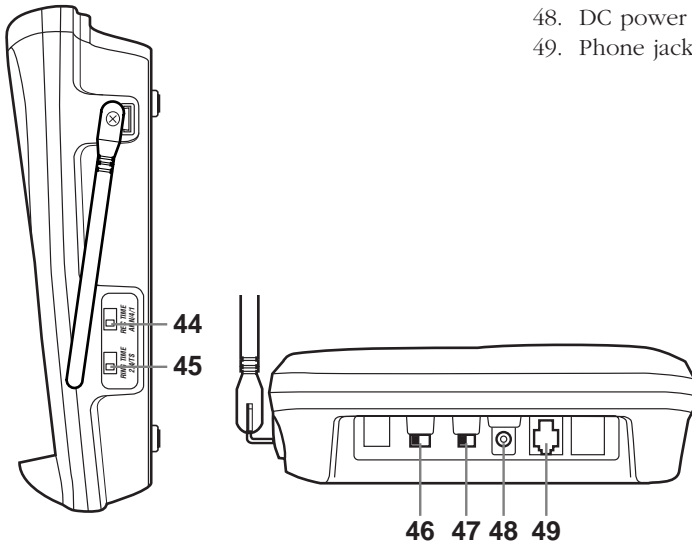

CONTENTS

OF YOUR OWNER'S MANUAL

Contents

Introduction / Features.....	inside front cover
Controls and Functions	inside front cover
Getting Started	
Read this first.....	2
Step 1: Checking the package contents.....	3
Step 2: Setting up the base unit	4
Mounting the base unit on a wall	7
Step 3: Installing the handset battery pack.....	9
Charging optional battery packs.....	10
Basics	
Making a call	11
Receiving a call	13
Adjusting the volume	15
Redialing a call	16
Using the speakerphone.....	18
Transferring a call.....	19
Using your EXS 9980 intercom.....	20
Mute	21
Memory Dialing	
Storing phone numbers and names.....	22
Making calls with memory dialing.....	24
Editing a stored name and/or phone number	26
Erasing a stored name and phone number.....	28
3-Way Conference Feature	
3-way conferencing.....	29
Caller ID Features	
Caller ID.....	30
When the telephone rings.....	31
Viewing the Caller ID Message list	32
Deleting information from the Caller ID list	33
Using the Caller ID list	35
Using "Caller ID on call waiting" service	37
The Integrated Answering Device	
Features.....	38
Setting up your answering system	39
Using your answering system	43
Additional Information	
Changing the digital security code.....	49
Installing the beltclip.....	50
Headset installation	50
Note on power sources	51
Maintenance.....	51
Troubleshooting	52
Specifications	54
Index	55

Getting Started

Basics

Memory
Dialing

3-Way
Conference
Feature

Caller ID
Features

The Integrated
Answering
Device

Additional
Information

Read this first

This cordless telephone must be set up before use. Follow these steps;

Step 1 (page 3)

Unpack and check the telephone and accessories.

Step 2 (page 4 to 8)

Next, choose the best location to set up the base unit.

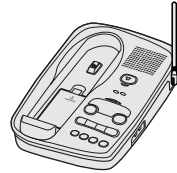

Base unit

Step 3 (page 9 to 10)

Then, insert the battery pack into the handset. You must charge the battery pack for more than 17 hours before using the phone.



Handset

About the digital security code

This cordless telephone uses a digital security code to prevent unauthorized access to your base unit. This security code prevents other cordless handsets from making calls through your base unit. A random security code will be assigned automatically between your base unit and handset when you charge the battery pack for the first time.

If you want to reset the security code, see page 49.

Checking the package contents

Make sure you have received the following items in the package. If any of these items are missing or damaged, contact the **Uniden Parts Department** (see below).

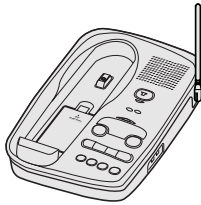

• Base unit



• Handset

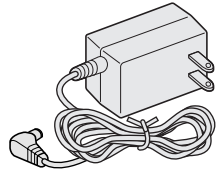

• AC adapter (AD-9500)

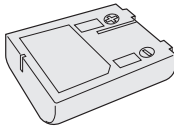

• Rechargeable battery pack (BT-999)

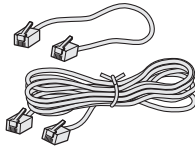

• Telephone line cord (2)

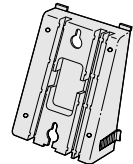

• Wall mount adapter

- This Owner's Manual
- Precautions and Important Safety Instructions
- Registration Card

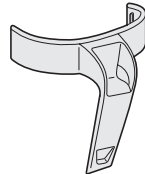

• Beltclip

Uniden Parts Department

(800) 554-3988

Hours: M-F 8:30 AM to 5:00 PM CST.

We can also be reached on the web at www.uniden.com.

Setting up the base unit

Do the following steps.

- Choose the best location
- Connect the base unit
- Choose the dialing mode

Choose the best location

Before choosing a location for your new phone, read the INSTALLATION CONSIDERATIONS included in the PRECAUTIONS AND IMPORTANT SAFETY INSTRUCTIONS brochure. Here are some important guidelines you should consider:

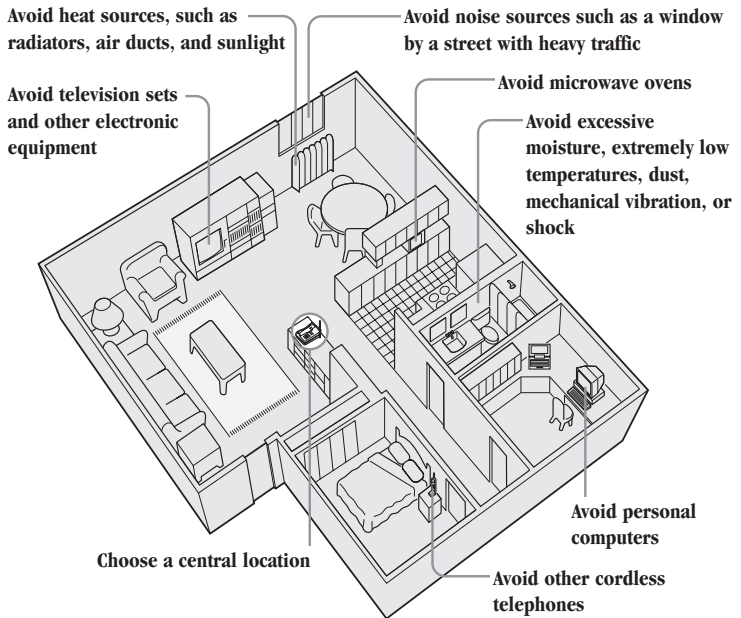

- You should charge your handset for more than 17 hours before using the phone.
- The location should be close to both a phone jack and a continuous power outlet which is not switchable.
- Keep the base and handset away from sources of electrical noise such as motors and fluorescent lighting.
- Be sure there is sufficient space to raise the base antenna fully vertical.
- The base can be placed on a desk, tabletop or mounted on a standard wall plate.

Connect the base unit

If you want to install the base unit on the wall, see page 7.

NOTE

Place the power cord so it does not create a trip hazard, or where it could become chafed and create a fire or electrical hazard.

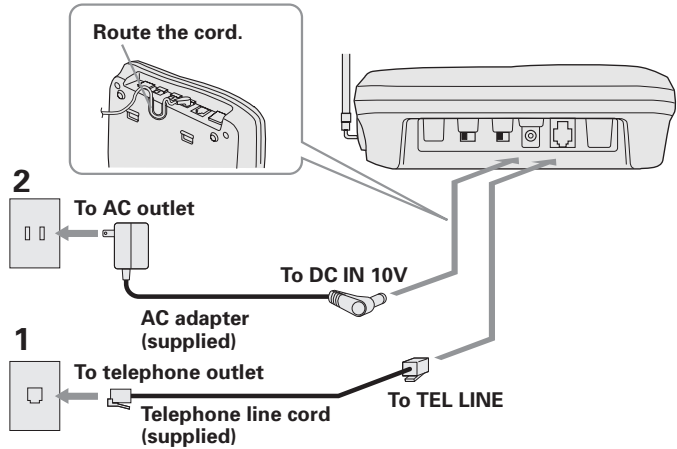

- 1** Connect the telephone line cord to the **TEL LINE** jack and to a telephone outlet.
- 2** Connect the AC adapter to the **DC IN 10V** jack and to a standard 120V AC wall outlet.
- 3** Set the base unit on a desk or tabletop and place the handset on the base unit. Then raise the antenna to a vertical position.

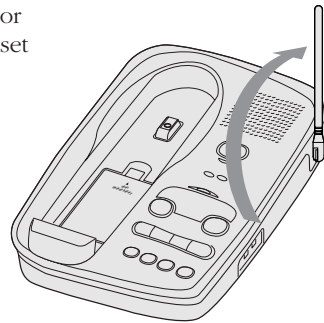



Use only the supplied AD-9500 AC adapter. Do not use any other AC adapter.

Polarity of the plug

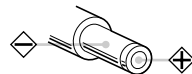

Connect the AC adapter to a continuous power supply.



Place the base unit close to the AC outlet so that you can unplug the AC adapter easily.



If your telephone outlet isn't modular, contact your telephone company for assistance.

Modular



Choose the dialing mode

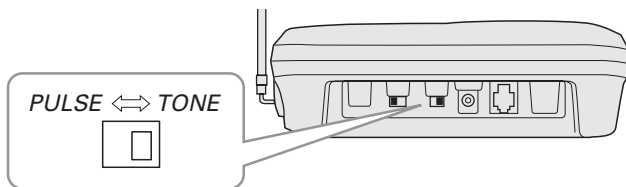

Depending on your dialing system, set the **PULSE-TONE** switch as follows:

If your dialing system is	Set the switch to
Tone	TONE
Pulse	PULSE

If you aren't sure of your dialing system

Make a trial call with the **PULSE-TONE** switch set to **TONE**. If the call connects, leave the switch as is; otherwise, set to **PULSE**.

Mounting the base unit on a wall

Standard wall plate mounting

This phone can be mounted on any standard telephone wall plate.

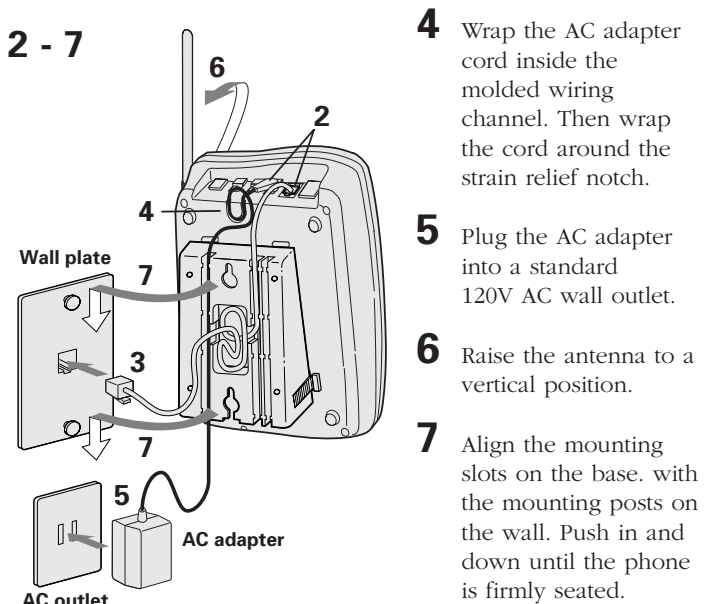
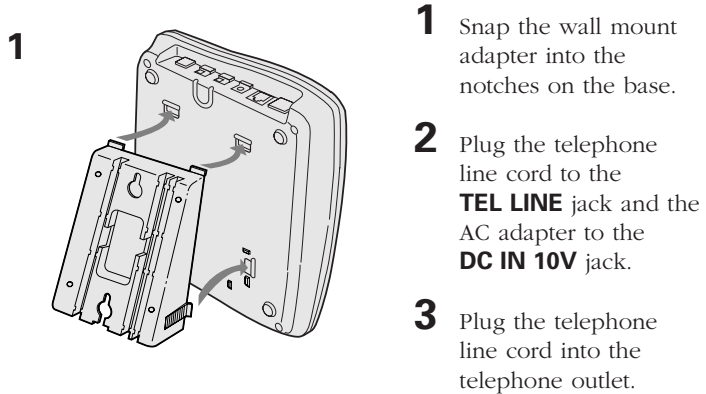



If you have wall mounted the base, you must remove the beltclip to charge the handset facing forward.

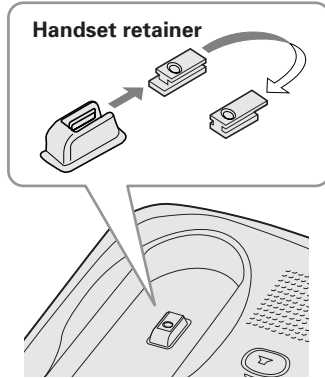

- 8** On the base unit, pull the handset retainer out of the slot. Rotate it clockwise 180 degrees.
- 9** Flip the retainer from front to back. Slide it back into the slot so that the lip of the retainer is up and the oval is down. The retainer holds the handset in place.

Direct wall plate mounting

If you don't have a standard wall plate, you can mount your phone directly to the wall. Before doing this, consider the following:

- Avoid electrical cables, pipes, or other items behind the mounting location, that could cause a hazard when inserting screws into the wall.
- Try to mount your phone within 10 - 15 feet of a working phone jack to avoid excessive cord lengths.
- Make sure the wall material is capable of supporting the weight of the base and handset.
- Use #10 screws with anchoring devices suitable for the wall material where the base unit will be placed.

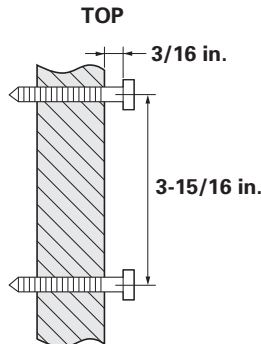

- 1** Insert two mounting screws into the wall, (with their appropriate anchoring device), 3-15/16 inches apart. Allow about 3/16 of an inch between the wall and screwheads for mounting the phone.
- 2** Refer to steps 1 through 9 on page 7 and 8 to mount the telephone.

Installing the handset battery pack

Charge the battery pack for more than 17 hours before you start using your phone.

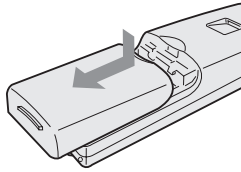

- 1** Press in on the battery cover release and slide the cover down until it comes off.

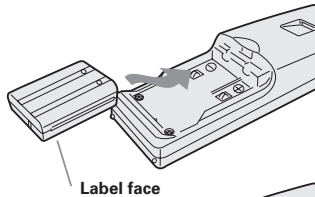

- 2** Install the nickel-cadmium battery with the label facing down.

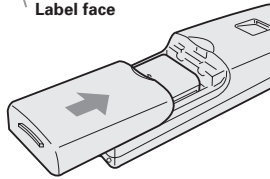

- 3** Slide the battery cover on until it snaps into place.

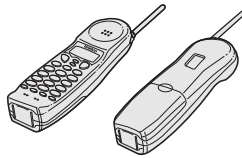

- 4** Place the handset on the base.

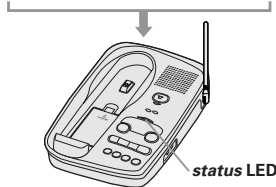

- 5** Make sure that the "*status*" LED lights. If the LED doesn't light, check to see that the AC adapter is plugged in and that the handset makes good contact with the base charging contacts.

NOTE

Use only Uniden Battery (BT-999) supplied with your phone.

NOTE

Even when the battery pack is not being used, it will gradually discharge over a long period. For optimum performance, be sure to return the handset to the base unit after a telephone call for charging the battery.

NOTE

Rechargeable batteries have a memory effect that reduces standby and talk time. To avoid this memory effect, on a monthly basis, use the phone until the "Low Battery" appears. Then charge the battery for more than 17 hours.

NOTE

Please visit your authorized Uniden dealer to obtain an extra battery pack or contact the Uniden parts department at (800)554-3988. Hours are from 8:30 a.m. to 5:00 p.m. Central Time, Monday through Friday.

Battery use time (per charge)

From fully charged

- Four hours continuous use.
- Seven days when the handset is in the standby mode.

When the battery charge becomes low

When the voltage of battery pack in the handset is very low and needs to be charged, the phone is programmed to eliminate functions in order to save power. If the battery charge becomes low, "Low Battery" appears on the LCD. If the phone is in use, the handset beeps. Complete your conversation as quickly as possible and return the handset to the base unit for charging.

Cleaning the battery contacts

To maintain a good charge, it is important to clean the battery contacts on the handset and base unit about once a month. Use a pencil eraser or other contact cleaner.

Do not use any liquids or solvents.

Charging optional battery packs

The base unit of your phone is equipped with a compartment for charging an extra battery pack for use in your handset. **You can obtain an extra battery pack from your authorized Uniden dealer.**

1. Pull the cover of battery charger.
2. Put the battery pack in the compartment with charging contacts facing down.
3. Replace the charger cover.
4. Charge the battery for 24 hours.
To install the charged battery into the handset, refer to "Installing the handset battery pack", page 9.

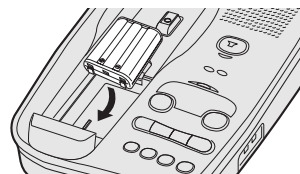
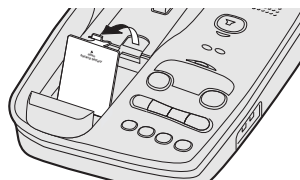

NOTE

In the event of a power failure, your spare battery pack can be used as a back-up power supply for the base unit.

Making a call

NOTE

Press **(del)** if you enter a wrong number at the step 1.

NOTE

You must press a key within 20 seconds or the phone will return to standby.

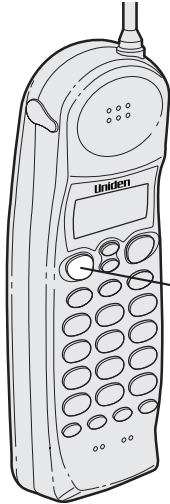

On-hook dialing

- 1 Enter the phone number. (Up to 32 digits.)

Example: Enter 8178583300

8178583300 ■

- 2 Press **(talk)**. "Talk" flashes on the display.

>Talk<
8178583300

Then the volume setting is displayed. For example, if the volume is set to high, the display shows;

Talk
<High>

- 3 The number is dialed. After about 5 seconds, the call-time display appears.

Talk 0:00
8178583300

- 4 To hang up, press **(talk)** or place the handset on the base. The call-time will be displayed for about 5 seconds.

5:15

Other Operations

To	Do this
To adjust the earpiece volume	Press (▲) or (▼) .
To temporarily switch to tone dial (When the base is set to pulse mode)	Press (* / tone / ◀) . The following numbers dialed will be sent as tone dialing.
To enter a pause within dialing sequence	Press (redial/p) .



Off-hook dialing

- 1 Press **(talk)**. "Talk" flashes on the display.



Then the volume setting is displayed. For example, if the volume is set to high, the display shows;



- 2 Dial the phone number.

Example: Enter 8178583300



- 3 To hang up, press **(talk)** or place the handset on the base. The call-time will be displayed for about 5 seconds.

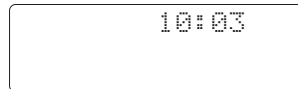

Receiving a call

From the handset

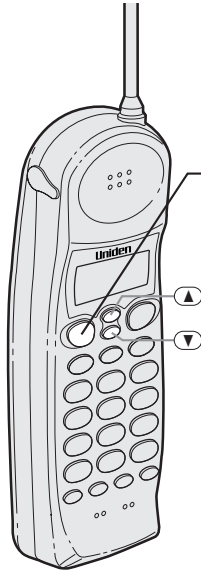

- 1** Phone rings.

Calling

- 2** Press **(talk)**. “Talk” and volume setting appears on the display.

Talk 0:00
<Normal>

- 3** Talk with the caller.

Talk 0:02

- 4** To hang up, press **(talk)** or place the handset on the base. The call time will be displayed for about 5 seconds.

115:35

AutoTalk when ringing

When the AutoTalk setting is on and there is an incoming call, simply lift the handset from the base unit to answer the phone. See “Setting Caller ID options” on page 30 for more details.

Any key answer when ringing

When the AutoTalk setting is on, and the handset is off the base, press any handset key to answer the incoming call.

Call Waiting

Note: You must subscribe to Call Waiting service to use this feature.

When a call is received during a telephone call already in progress, press **(flash)** to switch to the new call.

If you also subscribe to Call Waiting on Caller ID, you will see the name and number of the caller in call waiting. (See page 37.)

From the base

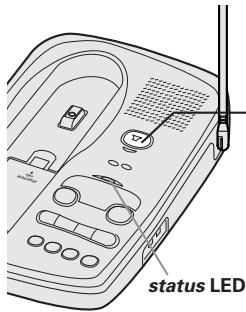

- 1** The phone rings. The **status** LED on the base flashes.
- 2** Press **speaker** and begin speaking.
- 3** To hang up, press **speaker**.

Adjusting the volume

Ringer volume

In the standby mode, press **(mute/ring)** on the handset to set the handset ringer volume. There are two ringer volume settings; high and low.

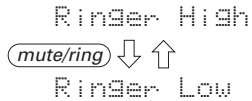

Ringer on/off switch

This switch turns the handset ringer on or off.

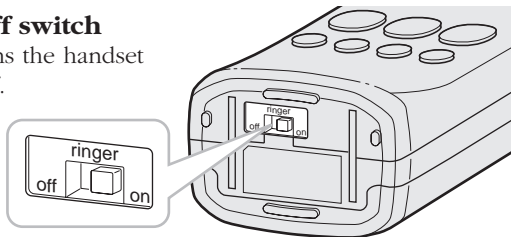

Earpiece volume

Pressing **(▲)** or **(▼)** will change the earpiece volume of the handset. This setting will remain in effect after the telephone call has ended.

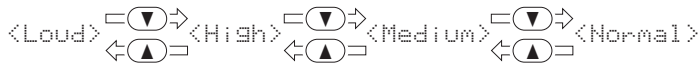

When you press **(▲)** in Loud mode or press **(▼)** in Normal mode, error sound beeps.

Base ringer switch

This switch turns the base ringer on or off.

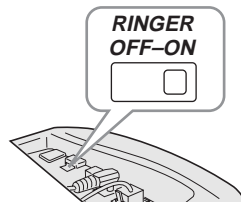

Base speaker volume

To control the speaker volume of the base, adjust the **(volume ▲)** and **(volume ▼)** button as desired.

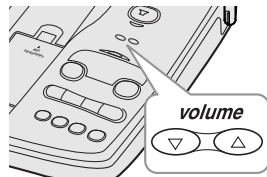

Redialing a call

The last three phone numbers dialed can be quickly redialed.

NOTE

If the number exceeds 32 digits, only the first 32 digits are retained for redialing.

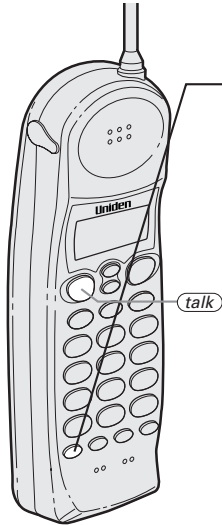

On-hook redialing

- 1 Press **redial/p**.
The phone number that was last dialed appears on the display.
- 2 Press **redial/p** again.
Each press of **redial/p** will display one of the last three numbers dialed.

Most recent

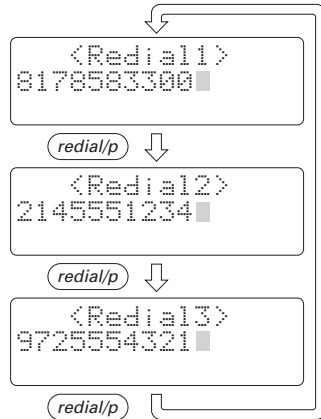

- 3 Press **talk**. "Talk" appears on the display, then the volume setting is displayed.
- 4 Then the selected number is dialed. After about 5 seconds, the call-time display appears.
- 5 To hang up, press **talk** or place the handset on the base. The call-time will be displayed for about 5 seconds.

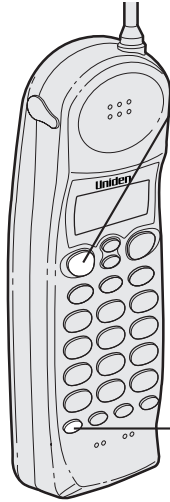

Off-hook redialing

- 1** Press **(talk)**.
“Talk” appears flashing on the display.



- 2** Press **(redial/p)**.
The last number dialed will be displayed.

- 3** To hang up, press **(talk)** or place the handset on the base. The call-time will be displayed for about 5 seconds.



Only the last number dialed can be accessed after **(talk)** has been pressed.

Using the speakerphone

You may use the phone as speaker phone to answer calls and intercom by pressing the **(speaker)** button on the base. To hang up, press **(speaker)** again.

The base microphone is located under the phone. Position yourself approximately 12 inches away from the base and speak clearly.

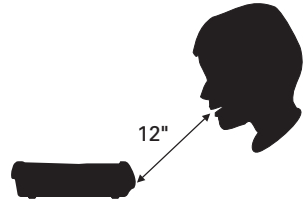

Transferring a call

To transfer from the handset to the base

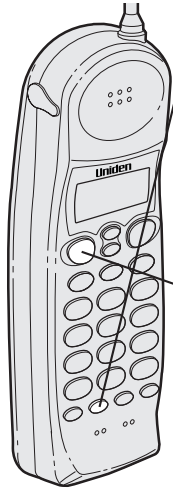

- 1** Press **int'com** on the handset while speaking on the handset. The line will be held, and the inter'com tone will be sounded on the base.
- 2** Press **page/int'com** or **speaker** on the base. The intercom mode is activated and the line is held.
- 3** To transfer to the base, press **talk** on the handset.
To cancel the transfer, press **speaker** on the base.

To transfer from the base to the handset

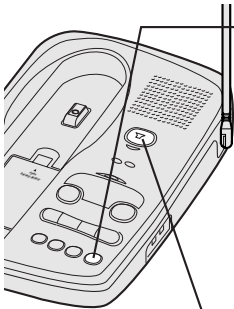

- 1** Press **page/int'com** on the base while speaking on the speaker phone. The line will be held, and the intercom tone will be sounded on the handset.
- 2** Press **int'com** or **talk** on the handset. The intercom mode is activated and the line is held.
- 3** To transfer the handset, press **speaker** on the base.
To cancel the transfer, press **talk** on the handset.

Using your EXS 9980 intercom

Intercom from the base to handset

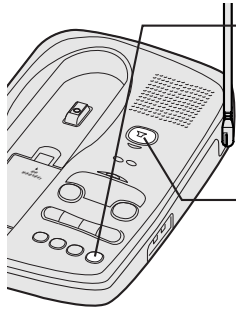

- 1** Press **page/int'com** on the base.
The handset beeps.
- 2** Press **int'com** or **talk** on the handset,
and the intercom turns on.
- 3** To turn off the intercom, press **talk** on
the handset or **speaker** on the base.

Intercom from the handset to base

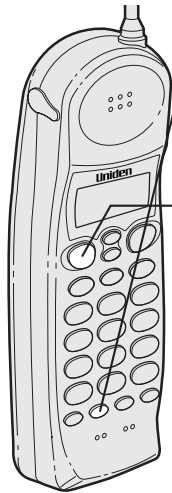

- 1** Press **int'com** on the handset.
The base beeps.
- 2** At the base, press **page/int'com** or
speaker to turn on the intercom.
- 3** To turn off the intercom, press **talk** on
the handset or **speaker** on the base.

Mute

You can turn off the handset microphone so that the person whom you are talking with cannot hear you.

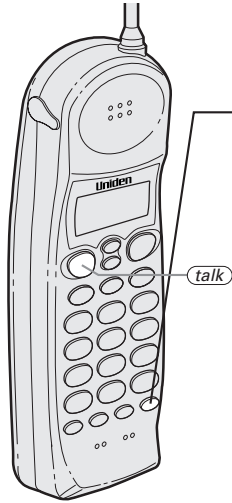

When speaking on the handset

- 1** Press **mute/ring** during a call. The microphone is turned off.
- 2** To resume a call, press **mute/ring** or **talk**.

When phone is ringing

Press **mute/ring** when the phone rings. The ringer sound is turned off.

NOTE

In memory dialing operation, you must press a key within 20 seconds or the phone will return to standby. If you return the handset to the base the phone will return to standby too.

Storing phone numbers and names

Memory Dialing allows you to dial a number using just a few key strokes. You can store up to 20 phone numbers in the memory.



- 1** Press and hold **(mem)** until “Memory Store” is displayed.

```
Memory Store
01▶
02
```

- 2** Press **(▼)** and **(▲)** or enter a two-digit number (01 - 20) to select the memory location where you would like to store the number.

- 3** Press **(select)**. The following screen appears and a cursor flashes indicating that the display is ready for the name to be entered.

```
Store Name
█
```

If this screen appears, the selected memory location is already stored. Then you must either change the entry in this location, clear the entry in this location, or select “Go Back” to choose another location.

```
▶Edit Memory07
Delete Memory07
Go Back
```

- 4** Use the **(▲)**, **(▼)**, or **(del)** keys to enter the name. The name cannot exceed 13 characters.
- Use the **(▲)** and **(▼)** key to scroll through the character menu. It contains upper and lower case letters and various characters.
 - Use **(#/▶)** and **(*/tone/←)** to move the cursor to the desired location.
 - Use **(del)** key to delete characters as needed.

- 5** Press **(select)**.
“Store Number” is displayed. The cursor flashes indicating that the display is ready for the number to be entered.

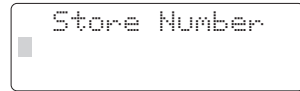

Store Number

- 6** Use the number keypad to enter the phone number. The phone number cannot exceed 20 digits.



Store Number
8178583390

- Use the **(redial/p)** key to enter pause in the dialing sequence. The display shows a “P”.



The pause feature is useful for long distance calling, credit card dialing, or sequences that require a pause between digits.

- Use the **(del)** key to delete digits as needed.

- 7** Press **(select)**.
The handset beeps and displays the confirmation screen. Memory storage is complete.

For example, if you store a name and number into memory location number 07, the display shows “Memory07 Stored”.

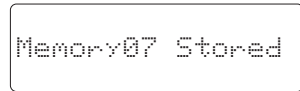

Memory07 Stored

After about 2 seconds, “Memory Store” is displayed.

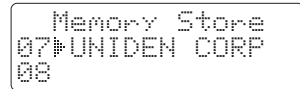

Memory Store
07 UNIDEN CORP
08

- 8** Press **(mem)** to return to standby mode.

Making calls with memory dialing

On-hook memory dialing

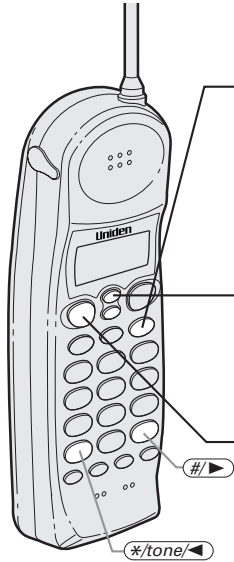

- 1 Press **(mem)**.
The handset displays your programmed memory locations.

```
01 UNIDEN CORP
02 JOHN DOE
03#MOM AND DAD
```

- 2 Press **(v)** and **(u)** or enter a two-digit number (01 - 20) to select the memory location you would like to dial.

- 3 Press **(talk)**. "Talk" flashes and the volume setting appears on the display. Then the displayed number is dialed.

```
-Talk-
0123456789012
```

NOTE

If you press **(select)** before **(talk)**, you can confirm the name and number stored in the selected memory location.

NOTE

To exit the memory function without dialing, press **(mem)**. The handset returns to standby.

Display a Programmed Number

Use the **(#)** and **(*/tone/)** keys to toggle between the names display and the numbers display.

Program name

```
01 UNIDEN CORP
02 JOHN DOE
03#MOM AND DAD
```

Program number

```
01 8178583300
02 5452930
03#8175551212
```

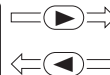

NOTE

When the stored phone number has 13 or more digits, "➔" is displayed next to the 12th digit. Press **(#)** to see the extra digits and **(*/tone/)** to return.

```
05 012345678901➔
06#011813554329+
07
```

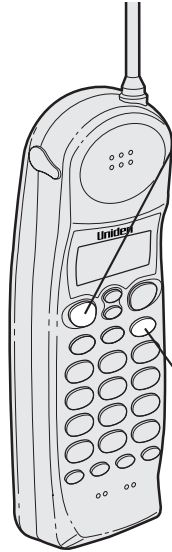

Off-hook memory dialing

- 1** Press **(talk)**.
“Talk” flashes and the volume setting appears.

```
  Talk  <High>
```



```
  Talk  <High>
```

- 2** Press **(mem)**.

```
  Talk  0:00
```

- 3** Enter a two-digit number (01 - 20) to select the memory location of the desired phone number.
The selected phone number is displayed. Then the number is dialed.

```
  Talk  0:35  
0123456789012
```

Editing a stored name and/or phone number

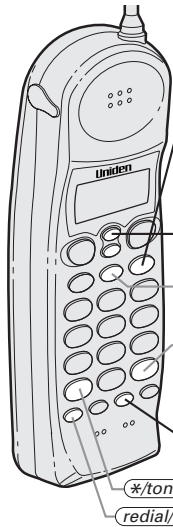

- 1** Press and hold **(mem)** for 2 seconds. The display shows the memory screen and any saved name/number.

```
Memory Store
01▶ UNIDEN CORP
02▶ JOHN DOE
```

- 2** Press **(▼)** and **(▲)** or enter a two-digit number (01 - 20) to select the memory location you would like to edit.

```
Memory Store
01 UNIDEN CORP
02▶ JOHN DOE
```

- 3** Press **(select)**. The following screen appears with the memory location number that you have selected in the display.

```
#Edit Memory01
Delete Memory01
Go Back
```

- 4** Press the **(▲)** or **(▼)** key to select "Edit Memory", then press **(select)**.

```
Store Name
UNIDEN CORP█
```

The following screen appears.

The cursor flashes indicating that the display is ready for the name to be edited. When a name has not been stored, the cursor appears at the beginning of the second line.

- 5** Press **(▲)**, **(▼)**, **(#/▶)**, **(*/tone/◀)**, or **(del)** to edit the name. (See page 22.)

To edit only the phone number, skip this step.

- 6** Press **(select)**.

The following screen appears.

The cursor flashes indicating that the display is ready for the number to be edited.

```
Store Number
817858330█
```

7 Use the dial keypad, **(redial/p)** or **(del)** key to edit the phone number.
 The phone number cannot exceed 20 digits. (See page 23.)
 If you don't want to change the phone number, skip this step.

8 Press **(select)**.
 The handset beeps and displays the confirmation screen. The memory storage is complete.



For example, if you store a name and number into memory location number 01, the display shows "Memory01 Stored".

After about 2 seconds, "Memory Store" is displayed.

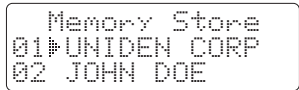

9 Press **(mem)** to return to standby mode.

Display a Programmed Number

Use the **(#/▶)** and **(*/tone/◀)** key to toggle between the names display and the numbers display.

Program name

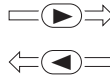
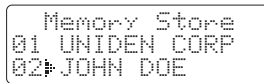

Program number

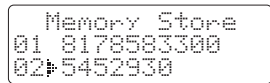

- When the stored phone number has 14 or more digits, "➡" is displayed next to the 12th digit.

Press **(#/▶)** to see the extra digits and **(*/tone/◀)** to return.

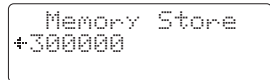
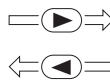
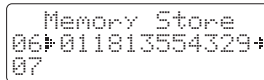

Erasing a stored name and phone number

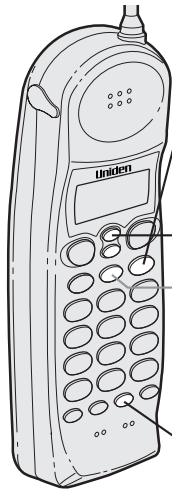

- 1** Press and hold **(mem)** until the display shows the memory screen and any saved name/number.

```
Memory Store
01 UNIDEN CORP
02 JOHN DOE
```

- 2** Press **(v)** and **(^)** keys or enter a two-digit number (01 - 20) to select the memory location you would like to edit.

```
Memory Store
01 UNIDEN CORP
02 JOHN DOE
```

- 3** Press **(select)**.
The following screen appears with the memory location number that you have selected in the display.

```
#Edit Memory02
Delete Memory02
Go Back
```

- 4** Press **(v)** to move the cursor down to "Delete Memory" command line.

```
Edit Memory02
#Delete Memory02
Go Back
```

- 5** Press **(select)**. The following confirmation screen appears.

```
Delete Memory02?
Yes
#No
```

- 6** Press **(^)** to move the cursor to "Yes".

- 7** Press **(select)** or **(del)**.
There is a confirmation tone and the entry is deleted. The following screen appears.

```
Memory02 Deleted
```

- 8** After a few seconds the display returns to the "Memory Store" screen. You may select another number to delete (return to step 2) or press **(mem)** to return to standby.

```
Memory Store
02#
03 MOM AND DAD
```

3-way conferencing

The Uniden EXS 9980 permits 3-way conversations between the handset, base and outside line.

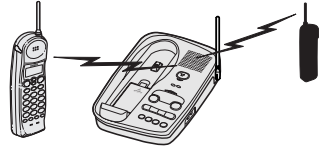

When speaking on the handset



If you pick up the handset from the base while speaking on the base, the call will be transferred to the handset.

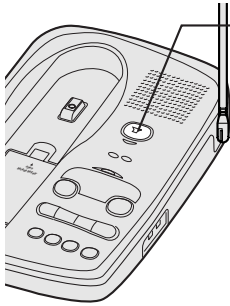

- 1 Press **speaker** on the base to join the 3-way conversation.
- 2 To hang up, press **speaker** on the base. The handset will still be connected to the outline call.

When speaking on the base

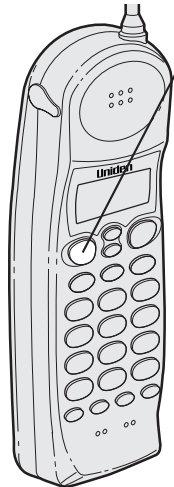

- 1 Press **talk** on the handset to join the 3-way conversation.
- 2 To hang up, press **talk** on the handset. The base will still be connected to the outline call.



You must subscribe to Caller ID on Call Waiting in order to use this feature.

Caller ID

You must subscribe to the Caller ID service to use this feature.

When the telephone rings, the Caller ID feature allows you to view the caller's name and phone number on the display before you answer the phone.

The handset displays the phone number of the incoming call, the name, time, and the number of calls. Additionally, you can dial the displayed number, and store the information for memory dialing.

Setting Caller ID options

There are three Caller ID setup options available; they are AutoTalk, CIDCW (Caller ID on Call Waiting), and Area Code.

AutoTalk allows you to answer the phone without pressing the **(talk)** button. If the phone rings when AutoTalk is on, simply remove the handset from the cradle and the phone automatically answers the call. If the phone rings when AutoTalk is off, you must press **(talk)** to answer the call.

Caller ID on Call Waiting (CIDCW) performs the same as regular Caller ID on a call waiting number.

You must subscribe to CIDCW from your phone company in order to use this feature.

If you enter 3-digit area code number in the **Area Code** option, your local area code does not appear in Caller ID messages. When reviewing Caller ID messages, you will see only the local seven digit number. For calls received from outside your local area code, you will see a full 10-digit number.



If your calling area requires 10-digit dialing, do not program this option.

To change your Caller ID options:

- 1** Press and hold down **(call id)**. The following screen appears.

```

1#Auto Talk:Off
2 CIDCW      :On
3 Area Code:

```
- 2** Use the **(▲)** and **(▼)** keys to move the cursor to the selection that you would like to change. Press the **(select)** key to toggle between **On** and **Off** for **Auto Talk** and **CIDCW**.
- 3** When you wish to enter **Area Code**, press **(▼)** to move the cursor to select **"Area Code"**. Then press **(select)** and enter the 3 digits area code by using the number keypad **(0) - (9)**. After entering **Area Code**, press **(select)**.
- 4** After you have made your selections, press **(call id)** and return the handset to the charging cradle.

FEATURES

CALLER ID

When the telephone rings

NOTE

If you answer a call before the Caller ID message is received (Example: before the second ring), the Caller ID message will not appear.

NOTE

When the call is received via a telephone company that does not offer Caller ID service, the caller's phone number and name do not appear. (This includes international calls.)

NOTE

When the call is via a private branch exchange (PBX), the caller's phone number and name may not appear.

- 1 When the Caller ID message is received, the display shows the caller's phone number, along with the date and time. The incoming call information is stored in Caller ID record. If the Caller ID service includes the caller's name, the caller's name appears on the display (up to 15 letters).

The date and time received — 5/11 12:30PM 01
Caller's name — UNIDEN CORP
Caller's phone number — 817-858-3300

Here are some typical displays;

When the phone number and name data are received

```
5/11 12:30PM 01
UNIDEN CORP
817-858-3300
```

When a private name is received

```
5/11 12:30PM 01
Private Name
817-858-3300
```

When an unknown name is received

```
5/11 12:30PM 01
Unknown Name
817-858-3300
```

When invalid data is received

```
Incomplete Data
```

When a private number is received

```
5/11 12:30PM 01
UNIDEN CORP
Private Number
```

When an unknown number is received

```
5/11 12:30PM 01
UNIDEN CORP
Unknown Number
```

- 2 When you pick up the phone, the display changes to "Talk". (See page 13.)

NOTE

Data errors appear as "■ ■".

```
5/11 12:30PM 01
UNI■EN CORP
813-8■■-3300
```

NOTE

In Caller ID operation, if no key is pressed for more than 20 seconds, an error tone sounds and the telephone returns to the standby mode.

NOTE

If a call comes in via a telephone system that does not offer Caller ID service, no information is stored.

NOTE

“End” appears when you have reviewed all messages in the Caller ID list. Press **▲** repeatedly to return to the summary screen.

NOTE

Each message can be up to 15 characters for the phone number and the name.

Viewing the Caller ID Message list

The Caller ID list stores information for up to 50 incoming calls - even unanswered calls.

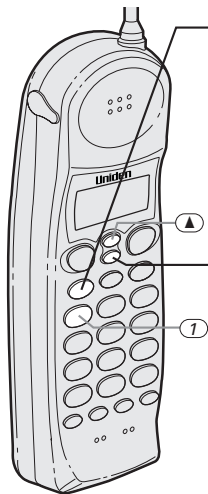

- 1 Press **(call id)**.
The summary screen appears.
The screen shows the number of new messages and total messages.

```
New :01  
Total:02
```

- 2 Press **▼** to display the latest caller ID message.

```
5/17 12:30PM 03  
UNIDEN CORP  
817-858-3300
```

- 3 Press **▼** to see the next message.
Or press **▲** to see previous message.

- 4 Press **(call id)** to return to standby.

Long Distance call setting and cancellation

Press **①** while the incoming call information is displayed (in step 2) to return a long distance call. The prefix “1-” will

be displayed at the beginning of the phone number when a long distance call is set. (When the phone number is 15 digits long, only “1” is displayed.) Pressing **①** again will cancel the long distance call setting.

```
5/17 12:30PM 03  
UNIDEN CORP  
1-817-858-3300
```

Deleting information from the Caller ID list

The EXS 9980 stores up to 50 messages. If the phone receives the 51st message, the oldest one in the list is automatically deleted. Caller ID data can also be deleted manually.

Deleting a Caller ID message

NOTE

If you get an incoming call, the deleting operation is cancelled. The telephone returns to standby so you can answer the call.

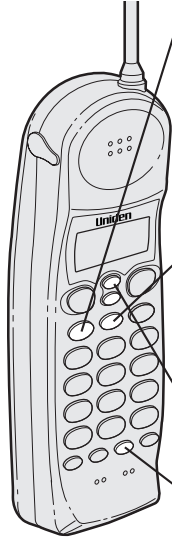

1 Press **(call id)**.

Display the message to be deleted from the Caller ID list by pressing

(v) or **(^)**.

```
5/17 12:30PM 03
UNIDEN CORP
817-858-3300
```

2 Press **(del)**.

```
Delete Message ?
Yes
No
```

3 Press **(v)** or **(^)** to select "Yes" or "No".

4 Press **(select)** or **(del)**.

When the pointer is at "Yes":

A tone sounds and the next Caller ID message is displayed.

When the pointer is at "No":

The display returns to the Caller ID display.

Deleting all Caller ID name/numbers

NOTE

If you get an incoming call, the deleting operation is cancelled.

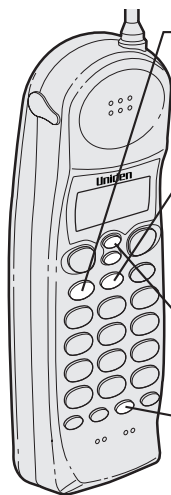

1 Press **call id**.

```
New :01
Total:02
```

2 Press **del**.

```
Delete All ?
Yes
No
```

3 Press **▲** or **▼** to select "Yes" or "No".

4 Press **select** or **del**.

When the pointer is at "Yes":

A tone sounds and all stored Caller ID messages are deleted.

```
Total:00
```

When the pointer is at "No":

The display returns to the summary screen.

```
New :01
Total:02
```

Using the Caller ID list

Calling a party from the Caller ID list

You can place a call from the Caller ID list.
The EXS 9980 stores up to 50 messages.

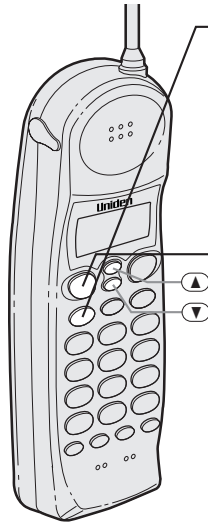

- 1** Press **call id**.
Select the phone number that you want to dial by pressing **▲** or **▼**.

```
5/17 12:30PM 03
UNIDEN CORP
817-858-3300
```

- 2** Press **talk**.

```
Talk
8178583300
```

The displayed phone number dials automatically.

NOTE

You cannot make a call from the Caller ID list if your EXS 9980 is connected to private branch exchange (PBX).

NOTE

When a long distance call has been set, "1" appears in the display.

Long Distance calls

Pressing **1** while the incoming call information is displayed (in step 1) will set or cancel a long distance call.

Dial edit

You can edit the phone number of Caller ID data when you press **select** after the step 1.

Storing Caller ID messages in Memory dialing

Messages shown in the Caller ID list can be stored in memory dialing.

Using the incoming call information (i.e., Caller ID list), the phone number of the party on the Caller ID list can be stored in memory dialing.

NOTE

You can not store a Caller ID message, if no phone number appears in the message.

NOTE

If there is an incoming call or page, memory storage is cancelled and the telephone is set to receive the incoming call or page.



- 1** Press **(call id)**.
Select the phone number to be stored from the Caller ID list by pressing **(▲)** or **(▼)**.

```
5/17 12:30PM 03
UNIDEN CORP
817-858-3300
```

- 2** Press **(mem)**.

```
Select Location
1 UNIDEN CORP
2 JONE DOE
```

- 3** Press **(▼)** and **(▲)** or enter a two-digit number (01 - 20) to select the memory location to be stored.

- 4** Press **(select)**.

A tone will sound. The number is stored in memory, and the display returns to the Caller ID list.

```
5/17 12:30PM 03
UNIDEN CORP
817-858-3300
```

NOTE

If a message has already been stored in the selected memory numbers location, a confirmation screen is displayed. Press **(▲)** to select "Yes". Press **(select)** to overwrite. The display returns to the Caller ID list.

```
Replace Memory ?
Yes
▶ No
```

Using "Caller ID on call waiting" service

"Caller ID" and "Call waiting" are separate services. CIDCW (Caller ID on Call Waiting) performs the same as regular Caller ID on a call waiting number. You must subscribe to the "Caller ID on call waiting (CIDCW) services" before you can use the following features. The "Call waiting" service can also be used independently. Please contact your local telephone company for details.



- 1 When a new incoming call arrives during your current telephone call, the phone number and the name of the caller is displayed.

```
Talk 10:30  
UNIDEN CORP  
817-858-3300
```

- 2 Press **flash**.
You will be able to talk with the second caller. The first caller will be put on hold.
- 3 To return to the first caller, press **flash** again.

The integrated answering device

The EXS 9980 has a built-in answering system that answers and records incoming calls.

You can also use your answering system to record a conversation, leave a voice memo message for others who use the phone, or to announce a special message to callers when you're away from your phone.

Features

- Digital Tapeless Recording
- 15 minutes of Recording Time
- Selective Greetings (Outgoing Messages)
- Time and Day Stamp
- Remote Message Retrieval and Room Monitor
- Toll Saver
- Conversation Recording

Digital Tapeless Recording allows you to quickly review, save or delete the messages. You'll never have to worry about a tape wearing out, jamming, or resetting improperly.

The Integrated Answering System is easy and convenient to use, but please read through all of the instructions carefully.

Setting up your answering system

Turning the answering system on/off

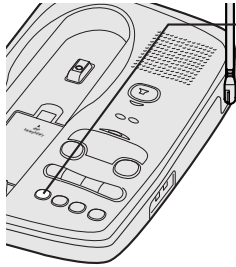

- 1 To turn the answering system on, press **answer on/off**. A tone will sound and the current greeting message is played.
- 2 To turn the answering system off, press **answer on/off** again.

Setting the clock

The clock on EXS 9980 Answer System starts when power is applied to the base. Follow these steps to set the clock to the correct time.

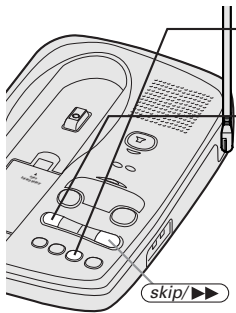

- 1 Press and hold **clock** until a tone sounds.
- 2 First, press **skip** or **repeat** until the correct day of the week is announced. (Number 0 through 5 displays on the base as each day is announced.) Press **clock** again to select the day.

NOTE

Press **skip** or **repeat** multiple times to scroll through days, hours, minutes, etc.

NOTE

If you don't set the clock within two minutes, the system returns to standby.

- 3 Next, press **skip** or **repeat** until you hear the correct hour setting. Numbers 1 through 12 display on the base as each hour is announced. Press **clock** again to select the correct time.
- 4 Press **skip** or **repeat** until you hear the correct time setting. Numbers 0 through 59 display on the base as each minute is announced. Press **clock** again to select the correct time.
- 5 The LED displays an **A** or **P**. Press **skip** or **repeat** until you hear the correct AM/PM setting.
- 6 Press **clock** again to end the time/day setting. The EXS 9980 announces the time that you have set.

Setting your greeting

When you receive a call, the answering system automatically plays either a preset message or your own greeting.

▼ Preset Message

The following message is prerecorded:

“Hello, no one is available to take your call. Please leave a message after the tone.”

▼ Recording your personal outgoing message (Greeting)

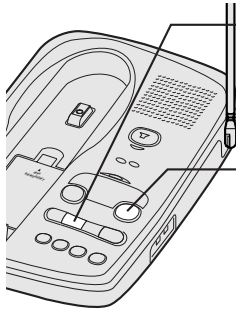

1 Press and hold **(greeting)** until you hear a long tone. Start recording your message immediately after you hear the long tone end.

2 When you finish recording your message, press **(greeting)** or **(play/stop)**.

A long tone sounds and your message plays back on the phone.

▼ Choosing between the two outgoing messages

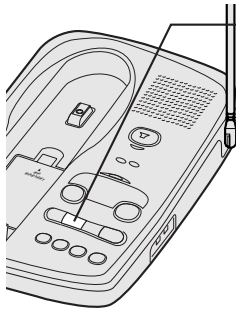

1 Press **(greeting)** to play the outgoing message.

2 Press **(greeting)** again while the message is played. This switches between the two options.

NOTE

You can record a greeting up to 30 second.

NOTE

Stand within 12 inches in front of the microphone and speak clearly when recording your outgoing message.

Selecting the message record time

You can set your answering system to record messages up to one or four minutes long.

One minute option:
move the **REC TIME** switch to **1**.

Four minutes option:
move the **REC TIME** switch to **4**.

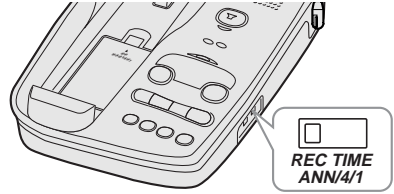

▼ Announce only feature:

The announce only feature plays an outgoing message, but it will not allow the caller to leave a message. Move the **REC TIME** switch to the **ANN** position.

The message counter LED displays “**A**” when system is on standby.

Prerecorded outgoing message for Announce only feature is: “Hello, no one is available to take your call.” (twice)

Selecting a PIN code

To play your messages from a remote location, you will need to enter a two-digit Personal Identification Number (PIN) code (00-99). To select a PIN, perform the following steps.



Press **skip** (▶▶) or **repeat** (◀◀) multiple times to scroll through numbers on the display.

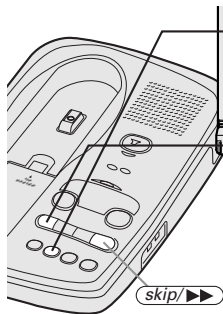

- 1** On the base, press and hold **(pin)** button until a beep sounds and the LED displays **00**.
- 2** To set the first number, press **(skip ▶▶)** or **(repeat ◀◀)** to scroll from 0 to 9. When the desired number appears in the display, press **(pin)**. This selects the first number.
- 3** To set the second number, press **(skip ▶▶)** or **(repeat ◀◀)** to scroll from 0 to 9. When the desired number appears in the display, press **(pin)**. This selects the second number and then the entered number is announced.

Setting ring time switch

The ring time/toll saver switch allows you to set the number of rings the caller hears before the answering system plays your outgoing message. You can set the switch to answer after two rings or after four rings.

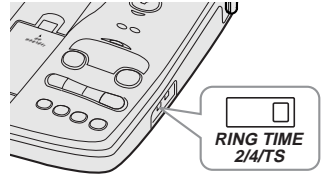

Once the greeting has started, you can stop it when you pick up the call at the handset or base.

In the **TS** (Toll Saver) position, the answering system picks up after two rings if you have new messages, and after four rings if there are none. This way, if you call long distance to check your messages, you can hang up after the third ring to avoid billing charges.



If you answer at another phone extension and the greeting has started, you cannot stop the message. Wait until your greeting is complete before starting your conversation.

Using your answering system

Playing your messages

The base LED shows the number of total messages on the display. If the display is blinking, then there are new messages waiting for you. The EXS 9980 is designed to play your new messages first. After you play your new messages you can then play your old messages.

NOTE

To stop playing your messages, press **play/stop** again.

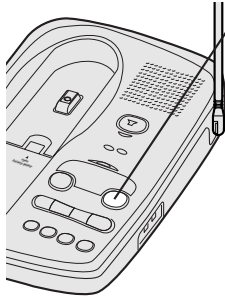

- 1** Press **play/stop**. The system announces the number of new and old messages, then the incoming messages are played. The time and day each message was received is announced after the message is played.
- 2** When all new messages have played, a long tone is heard. The message counter LED stops flashing to indicate that all of the new messages have been reviewed.
- 3** After you have reviewed all your messages, you can play your old messages again. Press **play/stop** and follow the instructions above.

NOTE

Pressing **repeat** (◀◀) before 2 seconds (4 seconds from remote) of the message has played causes the system to scan back one message.

NOTE

If you have several messages, press and hold **repeat** (◀◀) until you return to the message you want to replay.

NOTE

Each time **skip** (▶▶) is pressed, the system scans forward one message.

NOTE

If you have several messages, press and hold **skip** (▶▶) to find the message you want to play.

Repeating a message

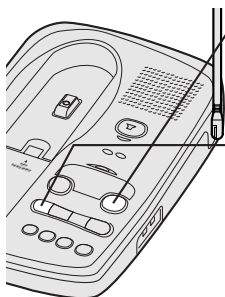

- 1 Press **play/stop** to review your message. The number of stored messages is announced.
- 2 After a message has played for a few seconds, press **repeat** (◀◀) to repeat the message.
- 3 Press **play/stop** at any time to stop reviewing messages and return to standby. The message counter LED shows the total number of messages still on the system.

Skipping a message

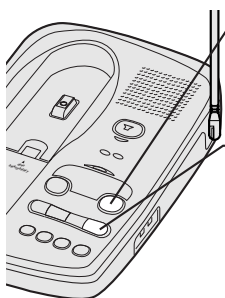

- 1 Press **play/stop** to review your messages. The number of messages is announced.
- 2 Press **skip** (▶▶) at anytime to skip to the next message.
- 3 Press **play/stop** at any time to stop reviewing your messages and return to standby. The message counter LED shows the total number of messages on the system.

NOTE

When you press **(delete)**, you are permanently deleting the message. Once deleted, the message cannot be replayed.

NOTE

The voice memo function is completely independent of the outgoing message. It's handy for leaving others a quick message.

NOTE

A voice memo message will be stored as a typical recorded message.

NOTE

Stand within 12 inches in front of the microphone and speak clearly.

Deleting a message

▼ Deleting individual message

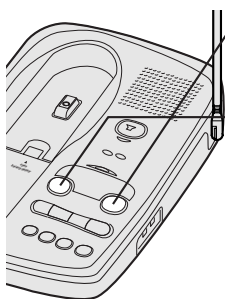

- 1 Press **(play/stop)** to review your message.
- 2 If you decide to delete a message, press **(delete)** anytime during the message. The system beeps and immediately goes to the next message.
- 3 After you have played all of your messages, a long tone sounds on the base speaker.

▼ Deleting all messages

Press and hold **(delete)** after reviewing your messages. A tone sounds when all messages are cleared.

Voice memo

The voice memo function allows the user to record a message (up to 10 minutes) on the base.

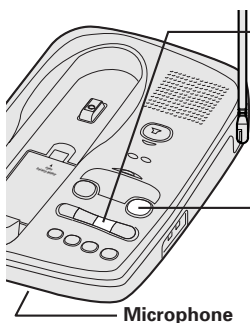

- 1 Press and hold **(voice memo)**, until you hear a long beep. The message counter LED blinks.
- 2 Speak into the microphone.
- 3 When you have finished, press **(voice memo)** or **(play/stop)** to stop recording. The system returns to standby.
- 4 To play voice memo, press **(play/stop)**.

NOTE

A recorded conversation is stored and played back with typical recorded messages.

Recording a conversation

You can record up to 10 minutes of conversation while you are making your call from the handset.

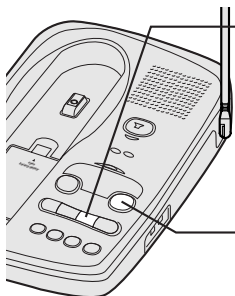

- 1 During the conversation from the handset, press and hold **voice memo** on the base. The unit begins recording and the LED blinks. A beep that can be heard by both parties sounds every 15 seconds.
- 2 To stop the recording, press **voice memo** or **play/stop**.

NOTE

You cannot record a conversation while you are speaking on the base.

Remote access away from home

You can operate your answering system from a remote location using any touch-tone telephone. Use this function to check for recorded messages, to play or delete messages, even to record a new outgoing message, and to monitor sounds in the room.

- 1 Call your telephone number.
- 2 During the answering machine is activated, press **#** and your PIN code.
- 3 The answering system announces the time and day stamp and the number of messages stored in memory. Then the message playback automatically begins.
- 4 You may continue to listen to your message, or you may select a command from the following chart.

Command	Function
# then 1	Repeat a message
# then 2	Playing your messages
# then 3	Skipping a message
# then 4	Deleting a message
# then 5	Stop message playback
# then 6	Answering system on
# then 7	Voice memo record/stop
# then 8	Outgoing message record/stop
# then 9	Answer system off
# then *	Room monitor

- 5 After all of your messages have played, or the playback time exceeds 4 minutes, you will hear that the intermittent beeps indicating that the system is in the command waiting mode. You may enter another command at this time from the chart above.
- 6 When you finish, hang up to exit the system. The answering system automatically returns to standby.



NOTE

You must enter a command within 15 seconds of entering command waiting mode or the answering system automatically hangs up and returns to standby.



NOTE

The system will only playback messages for four minutes and then it returns to command waiting mode. To continue playing your message, press **#** then **2** again within 15 seconds

Remote room monitor

You can call your answering system from any touch-tone phone and monitor sounds in the room where your base is installed.

- 1** Call your telephone number.
- 2** While the answering machine is activated, press **#** and your PIN code.
- 3** The answering system begins announcing the time and day.
- 4** Press **#** then **5** to stop the messages.
- 5** Press **#** then *****. You hear sounds in the room where your phone is installed. After 15 seconds, the answering system returns to the command waiting mode.
- 6** Press **#** then ***** to monitor the room for another 15 seconds. Or select another remote function. Or hang up to exit the system. The answering system automatically returns to standby.

Changing the digital security code

NOTE

If the handset battery pack is completely discharged or the battery pack is removed, the digital security code will be lost. If this happens, a new security code is set automatically next time the battery pack is charged.

The digital security code is an identification code used to connect the handset and the base unit. Normally, setting the code is not necessary.

The first time you charge your handset, the security code is automatically set. (See page 2.)

In the rare situation that you suspect another cordless telephone is using the same security code, you can change the code.

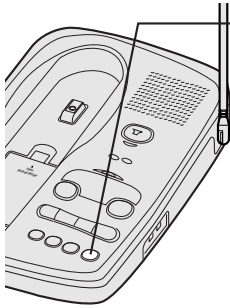

- 1 Remove the handset from the base unit. Press **page/int'com**.
- 2 While the handset is emitting the paging sound, hold **page/int'com** and replace the handset on the base unit. The paging tone stops. Leave the handset on the base longer than 5 seconds. A random, new security code is set.

ADDITIONAL
INFORMATION

NOTE

If you have wall mounted the base, you must remove the beltclip to charge the handset facing forward.

Installing the beltclip

To attach the beltclip

Insert the beltclip into the holes on each side of the handset. Press down until it clicks.

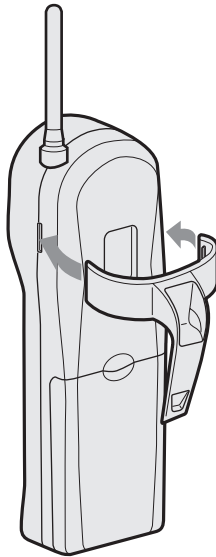

To remove the beltclip

Pull both sides of the beltclip to release the tabs from the holes.

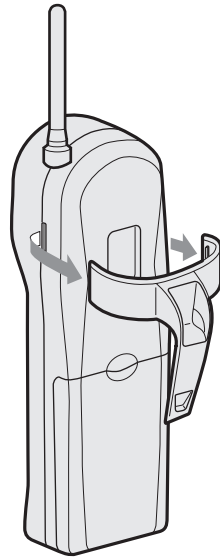

Headset installation

Your phone may be used with an optional headset. To use this feature, simply plug any standard 2.5mm headset plug into the headset jack. Your phone is ready for hands-free conversation.



Note on power sources

Battery replacement and handling

When the operating time becomes short, even after a battery is recharged, please replace the battery.

With normal usage, your battery should last about one year.

Please contact your place of purchase for a replacement battery.

Power Failure

During the period that the power is off, you will not be able to make or receive calls with the telephone.

RECYCLING NICKEL-CADMIUM BATTERIES

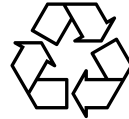

Ni-Cd

NICKEL-CADMIUM BATTERIES MUST BE DISPOSED OF PROPERLY.

Nickel-cadmium cells are used in the battery pack. Please take your used nickel-cadmium battery packs to a store that recycles nickel-cadmium batteries.

Caution

- Use the specified battery pack.
- Do not remove the battery from the handset to charge it.
- Never throw the battery into a fire, disassemble it, or heat it.
- Do not remove or damage the battery casing.

Maintenance

When slightly dirty

Wipe with a soft, dry cloth.

When very dirty

Wipe with a soft cloth that has been dampened with diluted, neutral detergent. Dry with a dry cloth.

When the charging terminals become dirty

Wipe with a pencil eraser or other contact cleaner.

Caution

Do not use paint thinner, benzene, alcohol, or other chemical products. Doing so may discolor the surface of the telephone and damage the finish.

Troubleshooting

If your phone is not performing to your expectations, please try these simple steps first.

Symptom	Suggestion
The status LED won't come on when the handset is placed in the base unit.	<ul style="list-style-type: none"> • Make sure the AC adapter is plugged into the base unit and wall outlet. • Make sure the handset is properly seated in the base unit. • Make sure the charging contacts on the handset and base unit are clean.
The audio sounds weak and/or scratchy.	<ul style="list-style-type: none"> • Make sure that the base unit antenna is in a vertical position. • Move the handset and or base unit to a different location away from metal objects or appliances and try again. • Make sure that you are not too far from the base.
Can't make or receive calls.	<ul style="list-style-type: none"> • Check both ends of the base unit telephone line cord. • Make sure the AC adapter is plugged into the base unit and wall outlet. • Disconnect the AC adapter for a few minutes, then reconnect it. • Reset the digital security code (See page 49). • Make sure (talk) is pressed.
The handset doesn't ring or receive a page.	<ul style="list-style-type: none"> • The battery pack may be weak. Charge the battery on the base unit for more than 17 hours. • The handset may be too far away from the base unit. • Place the base unit away from appliances or metal objects. • Reset the digital security code (See page 49). • Make sure the ringer switch is on (See page 15).

Symptom	Suggestion
The Caller ID does not display.	<ul style="list-style-type: none"> • The handset was picked up before the second ring. • The call was placed through a switch board. • Call your local telephone company to verify your Caller ID service is current.
The answering system does not work.	<ul style="list-style-type: none"> • Make sure the base unit is plugged in. • Make sure that the answering system is turned on. • Make sure that the message record time is not set to ANN (See page 41).
Messages are incomplete.	<ul style="list-style-type: none"> • The incoming messages may be too long. Remind callers to leave a brief message. • The memory may be full. Delete some or all of the saved messages.
After a power failure, the outgoing message is deleted.	<ul style="list-style-type: none"> • Record your greeting again. The preset messages should remain.
No sounds on the base unit speaker during call monitoring or message playback.	<ul style="list-style-type: none"> • Adjust the speaker volume on the base unit.
Cannot access remote call-in features from another touch-tone phone.	<ul style="list-style-type: none"> • Make sure you are using the correct PIN number. • Make sure that the touch-tone phone you're using can transmit the tone for at least two seconds. If it cannot, you may have to use another phone to access your message.

Specifications

General

The EXS 9980 complies with FCC Parts 15 and 68.

Frequency control: PLL

Modulation: Direct Sequence Spread Spectrum; DBPSK

Operating temperature: 0°C to +50°C (+32°F to +122°F)

Base unit

Frequency: 904.2 MHz to 925.8 MHz (20 channel)

Power requirements: 10V 500mA (from AC adapter)

Size: 8-49/64 in. (W) x 6-57/64 in. (D) x 2-37/64 in. (H)
(222.5 mm (W) x 175 mm (D) x 65.3 mm (H))

Weight: Approx. 22.2 oz. (Approx. 630 g)

Handset

Frequency: 904.2 MHz to 925.8MHz (20 channel)

Power requirements: Rechargeable Nickel-Cadmium battery pack

Size (without antenna): 7 in. (W) x 2-17/64 in. (D) x 2 in. (H)
(178 mm (W) x 57.6 mm (D) x 51 mm (H))

Weight: Approx. 8.8 oz. (250 g) (including battery)

Battery: BT-999

Capacity 600 mAh, 3.6V

Talk mode 4 hours TYP

Standby mode 7 days TYP

Specifications, features, and availability of optional accessories are all subject to change without prior notice.

At Uniden, we'll take care of you!

If you need any assistance with this product, please call our Customer Hotline at

1-800-297-1023

PLEASE DO NOT RETURN THIS PRODUCT TO THE PLACE OF PURCHASE.

Our Uniden representatives will be happy to help you with any matters regarding the operation of this unit, available accessories, or any other related matters.

Thank you for purchasing a Uniden product.

Hours: M-F 7:00 AM to 7:00 PM CST.

Index

0 - 9

3-way conferencing.....29

A

Adjusting the volume.....15

Answering device

Features.....38

Setting up.....39

Using.....43

B

Base ringer switch.....15

Battery pack

Preparing and charging ...9

Replacement and
handling.....51

C

Caller ID

Caller ID service.....30

Call Waiting.....37

Deleting.....33

Using.....35

Viewing.....32

Connection.....5

D

Dialing mode.....6

Digital security code.....2, 49

E, F, G

Earpiece volume.....15

H

Headset installation.....50

I, J, K, L

Installing the beltclip.....50

M, N, O

Maintenance.....51

Making a call.....11

Memory dialing

Making calls
with memory dialing.....24

Erasing a stored name
and phone number.....28

Storing phone
numbers and names.....22

Mounting the base unit

on a wall.....7

Mute.....21

P, Q

Package contents.....3

R

Receiving a call.....13

Redialing a call.....16

Ringer volume.....15

S

Setting up your answering
system

Selecting a PIN code.....41

Selecting the
message record time.....41

Setting the clock.....39

Setting ring time

switch.....42

Setting your greeting.....40

Turning the answering
system on/off.....39

Setting up the Base unit.....4

Setting up the Handset.....9

Specifications.....54

T

Troubleshooting.....52

U, V, W, X, Y, Z

Using your answering system

Deleting a message.....45

Playing your message.....43

Recording a
conversation.....46

Remote access

away from home.....47

Remote room monitor.....48

Repeating a message.....44

Skipping a message.....44

Voice memo.....45

THANK YOU

FOR PURCHASING A UNIDEN PHONE!

Uniden®

Covered under one or more of the following U.S. patents:

4,511,761 4,523,058 4,595,795 4,797,916 5,381,460
5,426,690 5,431,905 5,491,745 5,533,010 5,574,727
5,650,790 5,660,269 5,661,780 5,663,981 5,671,248
5,717,321 5,754,407 5,768,345 5,787,356 5,838,721

© August 1999 Uniden America Corporation

All rights reserved • Printed in China UCZZ01648BZ

Free Manuals Download Website

<http://myh66.com>

<http://usermanuals.us>

<http://www.somanuals.com>

<http://www.4manuals.cc>

<http://www.manual-lib.com>

<http://www.404manual.com>

<http://www.luxmanual.com>

<http://aubethermostatmanual.com>

Golf course search by state

<http://golfingnear.com>

Email search by domain

<http://emailbydomain.com>

Auto manuals search

<http://auto.somanuals.com>

TV manuals search

<http://tv.somanuals.com>