

Uniden®

OWNER'S MANUAL

EXT1365



tr24
.4GHZ
DIGITAL SPREAD SPECTRUM



Contents

Welcome / Features	2	Memory Dialing	
Controls and Functions	4	Storing phone numbers and names	23
Getting Started		Steps for entering names and special characters	25
Read this first	6	Making calls with memory dialing	27
Step 1: Checking the package contents	7	Editing a stored name and/or phone number	29
Step 2: Setting up the base unit	8	Erasing a stored name and phone number	30
Step 3: Installing the handset battery pack	9	Telephone Features	
Step 4: Setting Caller ID options	12	3-way conferencing	32
Entering your Area Code	13	Intercom Feature	33
Basics		Call Transfer Feature	34
Making a call	14	Chain Dialing	35
Receiving a call	16	Selecting a Different Channel	35
Adjusting the volume	18	Tone Dialing Switch-over	35
Redialing a call	19	Caller ID Features	
Traveling out-of-range	20	Caller ID	36
Using one touch voice mail access	21	When the telephone rings	36

Viewing the Caller ID Message list	37	General Information	54
Deleting information from the Caller ID list	38	Precautions	55
Using the Caller ID list	40	Important Safety Instructions	55
Using "Caller ID on call waiting" service	42	Important Electrical Considerations	55
Call Waiting Features	43	Installation Considerations	56
Advanced Calling Features		One Year Limited Warranty	56
Accessing calling features	44	Technical Information	57
Pre-programmed calling features	45	Index	59
Adding new features	47		
Additional Information			
Changing the digital security code	49		
Installing the beltclip	50		
Headset installation	50		
Note on power sources	51		
Maintenance	51		
Troubleshooting	52		

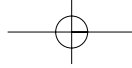

Welcome

Congratulations on your purchase of the EXT 1365 cordless telephone. This phone is designed for reliability, long life and outstanding performance utilizing the latest in 2.4 GHz Spread Spectrum Technology.

Note: Some illustrations in this manual may differ from the actual unit for explanation purposes.

Features

- 2.4 GHz Spread Spectrum Technology
- Secure Digital Transmission
- Caller ID and Call Waiting Caller ID
- Advanced Caller ID with Call Waiting Options
- 50 Number Caller ID Memory
- 20 Number Memory
- 3 Line Backlit Display
- 3 Redial Memories (up to 32 digit)
- Flash and Pause
- Pulse / Tone Dialing
- 10 Day Standby Battery Life
- 6 Hour Talk Time
- Handset Earpiece and Ringer Volume Control
- Base Speakerphone with Keypad
- 3-Way Conference Operation
- Dual Keypad Operation
- 35 Channels
- Voice Message Waiting Indicator

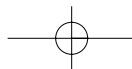

Digital Spread Spectrum Technology utilizes a “wider frequency band” vs. a “single narrow band” used in standard digital transmissions. The 2.4 GHz frequency range was recently released to commercial communications. The result is a more secure conversation with the clarity of digital sound, extended range, and minimal interference from other cordless phones.

Random Code™ digital security automatically selects one of approx. 65,000 codes for the handset and base.

These features enhance your phone’s security and also prevents unauthorized calls as a result of your phone being activated by other equipment.

Uniden™ is a registered trademark of Uniden America Corporation.
AutoTalk™ and Random Code™ are trademarks of Uniden America Corporation.

Throughout this manual, terms such as Standby Mode and Talk Mode are used. Below is the terminology explanation:

- **Standby Mode** - The handset is not in use, off of the base and **talk** has not been pressed. A dial tone is not present and the display is blank.
- **Talk Mode** - The handset is not on the base and **talk** has been pressed enabling a dial tone. **Talk** appears on the display.

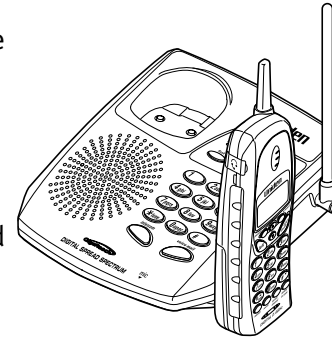

Controls and Functions

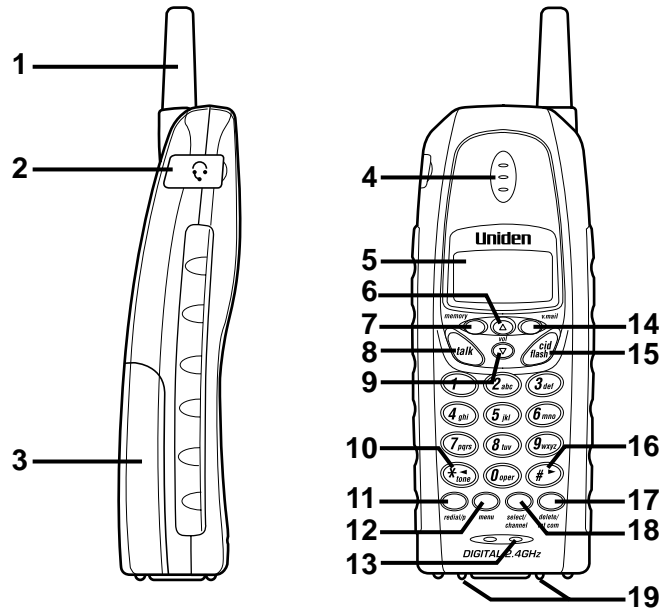

1. Handset Antenna
2. Headset Jack Cover
3. Handset Battery Compartment
4. Handset Earpiece
5. LCD Display
6. Volume Up Key
7. Memory Key
8. Talk Key
9. Volume Down Key
10. Tone/Left Cursor Key
11. Redial/Pause Key
12. Menu Key
13. Handset Microphone
14. V.mail Key
15. Caller ID/Flash Key
16. Right Cursor Key
17. Delete/Intercom Key
18. Select/Channel Key
19. Handset Charging Contacts

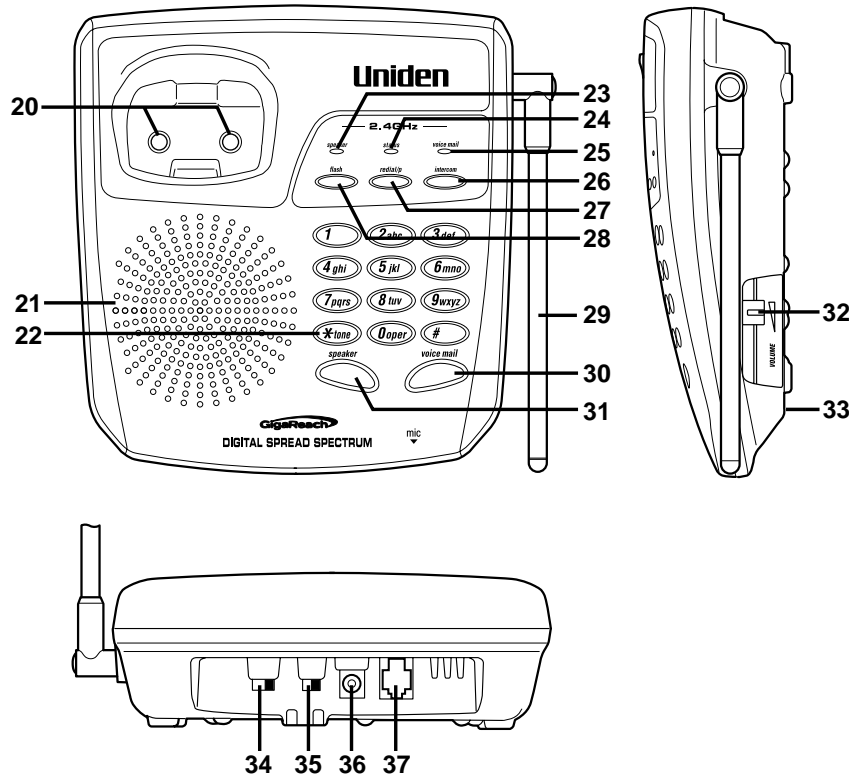

- 20. Base Charging Contacts
- 21. Base Speaker
- 22. Tone Key
- 23. Speaker LED
- 24. Status LED
- 25. Voice Mail LED
- 26. Intercom Key
- 27. Redial/Pause Key
- 28. Flash Key
- 29. Base Antenna
- 30. Voice Mail Key
- 31. Speaker Key
- 32. Base Speaker Volume Adjust
- 33. Base Microphone
- 34. Base Ringer Switch
- 35. Pulse-Tone Switch
- 36. DC Power Input
- 37. Phone Jack

Read This First

This cordless telephone must be set up before use. Follow these steps:

Step 1 (page 7)

Unpack the telephone and accessories.

Step 2 (page 8)

Next, choose the best location to set up the base unit.

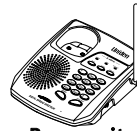

Base unit

Step 3 (page 9 to 11)

Then, insert the battery pack into the handset. Connect the base unit. You must charge the battery pack for **15-20 hours before plugging into the phone line and using the phone.**



Handset

Step 4 (page 12 to 13)

Finally, set the Caller ID options and store your area code in the memory to use the Caller ID service.

Note: Skip the area code setting if your calling area requires 10-digit dialing.



Handset

About the digital security code

This cordless telephone uses a digital security code to prevent unauthorized access to your base unit. This security code prevents other cordless handsets from making calls through your base unit.

A random security code will be assigned automatically between your base unit and handset when you charge the battery pack for the first time.

If you want to reset the security code, see page 49.

Checking the Package Contents

Make sure you have received the following items in the package.
If any of these items are missing or damaged, contact the Uniden Parts Department (see below).

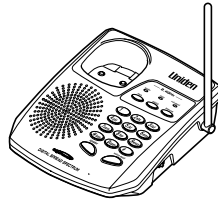

• Base unit



• Handset

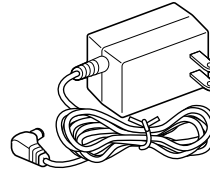

• AC adapter (AD-312)

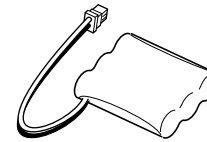

• Rechargeable battery pack (BT-800)

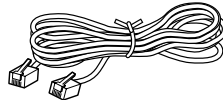

• Telephone line cord



• Beltclip

- This Owner's Manual
- Quick Reference Guide

Uniden Parts Department

(800) 554-3988

Hours: M-F 7:00 AM to 5:00 PM CST.

We can also be reached on the web at www.uniden.com

Setting Up the Base Unit

Do the following steps:

- | | |
|-----------------------------|----------------------------|
| A. Choose the best location | C. Connect the base unit |
| B. Install the battery pack | D. Choose the dialing mode |

A. Choose the best location

Before choosing a location for your new phone, read the INSTALLATION CONSIDERATIONS included in the PRECAUTIONS AND IMPORTANT SAFETY INSTRUCTIONS brochure. Here are some important guidelines you should consider:

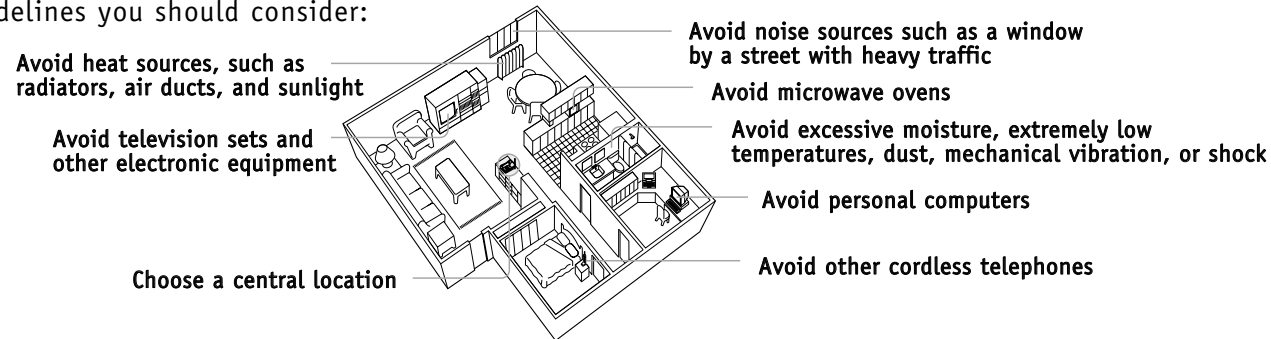

- After installing the battery pack in the handset, you should charge your handset for **15-20 hours before using the phone**. Once the handset battery pack is fully charged, you may connect the telephone line cord to the base and telephone wall outlet.
- The location should be close to both a phone jack and a continuous power outlet which is not switchable.
- Keep the base and handset away from sources of electrical noise such as motors and fluorescent lighting.
- Be sure there is sufficient space to raise the base antenna to a vertical position.

[8] GETTING STARTED

B. Installing the Handset Battery Pack

Charge the battery pack for 15-20 hours before plugging the phone line into your phone.

- 1 Press in on the battery cover release and slide the cover down until it comes off.
- 2 Connect the battery pack connector with the correct polarity (black and red wires), then insert the battery pack into the battery compartment.
- 3 Slide the battery cover forward until it snaps into place.
- 4 Place the handset on the base.
- 5 Make sure that the “*status*” LED lights. If the LED doesn’t light, check to see that the AC adapter is plugged in and that the handset makes good contact with the base charging contacts.

note Use only the Uniden Battery (BT-800) supplied with your phone. Replacement batteries are also available through the Uniden Parts Department (See page 7).

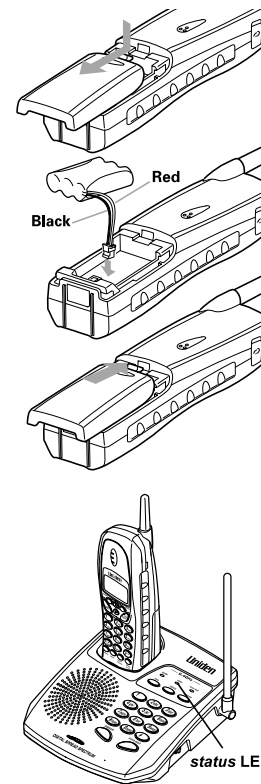

The plastic connectors will fit together only one way. Make sure the battery’s connector is properly aligned.



- Even when the battery pack is not being used, it will gradually discharge over a long period of time. For optimum performance, be sure to return the handset to the base unit after each telephone call.
- The built-in memory backup can hold numbers and names stored in the memory even if the battery is completely discharged.
- If you must replace the battery pack during a telephone call, complete the replacement of the battery pack within 30 seconds, and you can return to the original call.

Battery use time (per charge)

From fully charged

- 6 hours continuous use
- 10 days when the handset is in the standby mode

When the battery charge becomes low

When the voltage of battery pack in the handset is very low and needs to be charged, the phone is programmed to eliminate functions in order to save power. If the battery charge becomes low, "Low Battery" appears on the LCD. If the phone is in use, the handset beeps. Complete your conversation as quickly as possible and return the handset to the base unit for charging.



Low Battery

Cleaning the charging contacts

To maintain a good charge, it is important to clean the battery contacts on the handset and base unit with a dry cloth or a pencil eraser about once a month.

Do not use any liquids or solvents.

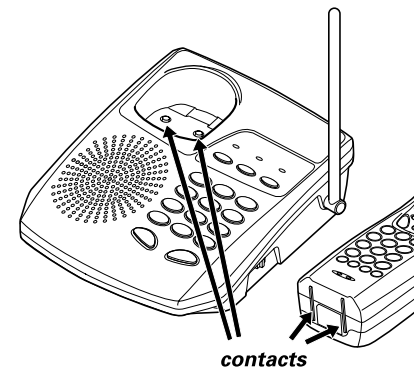

C. Connect the base unit

- 1 Connect the AC adapter to the **DC IN 9V** jack and to a standard 120V AC wall outlet.
- 2 Set the base unit on a desk or tabletop and place the handset on the base unit as shown.
- 3 Then raise the antenna to a vertical position. After installing the battery pack in the handset, charge your handset at least **15-20 hours before plugging into the phone line.** Once the handset battery pack is fully charged, connect the telephone line cord to the base and telephone wall outlet.
- 4 Connect the telephone line cord to the **TEL LINE** jack and to a telephone outlet.

tip

If your telephone outlet isn't modular, contact your telephone company for assistance.

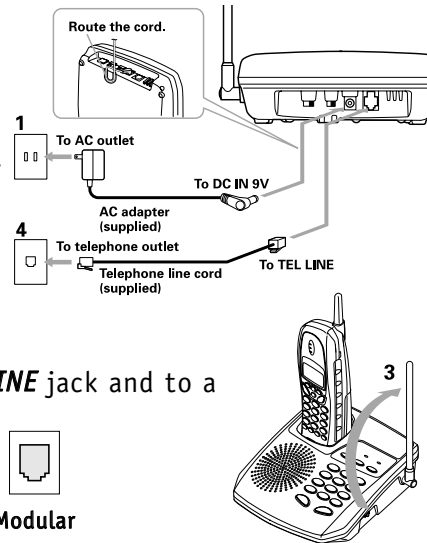

- Place the power cord so it does not create a trip hazard or where it could become chafed and create a fire or electrical hazard.
- Use only the supplied AD-312 AC adapter. Do not use any other AC adapter.
- Connect the AC adapter to a continuous power supply.
- Place the base unit close to the AC outlet so that you can unplug the AC adapter easily.

D. Choose the dialing mode

Depending on your dialing system, set the **PULSE-TONE** switch as follows:

If your dialing system is	Set the switch to
Tone	TONE
Pulse	PULSE

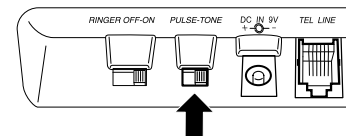

If you aren't sure of your dialing system, make a trial call with the **PULSE-TONE** switch set to **TONE**. If the call connects, leave the switch as is; otherwise, set to **PULSE**.



You must subscribe to Caller ID on Call Waiting in order to use this feature.

Setting Caller ID Options

There are three Caller ID setup options available; they are AutoTalk, CIDCW (Caller ID on Call Waiting), and Area Code. See page 13 for Area Code setup instructions.

AutoTalk™ allows you to answer the phone without pressing the **(talk)** button. If the phone rings when AutoTalk is on, simply remove the handset from the base and the phone automatically answers the call. Or if the handset is not on the base, press any key to answer the call. If the phone rings when AutoTalk is off, you must press **(talk)** to answer the call.

Caller ID on Call Waiting (CIDCW) performs the same as regular Caller ID on a call waiting number. Call waiting options allow you to handle call waiting calls in seven different ways. (See page 43.)

You must subscribe to CIDCW from your phone company in order to use this feature.

To change your Caller ID options:

1 Press and hold **(cid/flash)**. The following screen appears.

```
1 Auto Talk: Off
2 CIDCW      : On
3 Area Code:
```

2 Use **(▲)** and **(▼)** or a number key (1-3) to move the pointer to the selection that you would like to change.

Press **(select/channel)** to choose "On" and "Off" for "Auto Talk".

For "CIDCW", choose "On", "Off", or "Off" depending upon the type of service to which you subscribe.

3 After you have made your Caller ID selections, press **(cid/flash)** and return the handset to the base.

Entering Your Area Code

If you enter a 3-digit area code number in the "Area Code" option, your local area code does not appear in Caller ID messages. Do not program this option if your calling area requires 10-digit dialing. When reviewing Caller ID messages, you will see only the local seven digit number. For calls received from outside your local area code, you will see a full 10-digit number.

1 When the phone is in the standby mode, press and hold **(cid/flash)**. The Caller ID setting screen appears.

```
1 Auto Talk:Off
2 CIDCW      :On
3 Area Code:
```

2 Press **(3)** to select "Area Code".

```
1 Auto Talk:Off
2 CIDCW      :On
3 Area Code:
```

3 Press **(select/channel)**.

```
1 Auto Talk:Off
2 CIDCW      :On
3 Area Code:█
```

4 Use the number keypad (**(0)** to **(9)**) to enter the 3-digit area code.

5 Press **(select/channel)**. A tone sounds and the displayed area code is entered.

6 Press **(cid/flash)** to complete the setting. Or return the handset to the base unit to complete the setting. The handset returns to the standby mode.

note When the area code has already been stored in memory, the stored area code will be displayed. To change it, use the **(delete/int com)** and number keypad to enter the new area code. Then press **(select/channel)**. To complete the setting, press **(cid/flash)** or return the handset to the base unit.

```
1 Auto Talk:Off
2 CIDCW      :On
3 Area Code:817
```



If your calling area requires 10-digit dialing, do not program this option.



- Press **(delete/int com)** if you enter a wrong number at step 1. To delete all the numbers that you have entered, press and hold **(delete/int com)** until the display clears.
- You must press a key within 20 seconds or the phone will return to standby.
- Refer to terminology explanation on Page 3, if necessary.

Making a Call

Dialing from Standby Mode

- 1 Enter the phone number and press **(talk)**. "Talk" flashes on the display. Then current volume setting is displayed.

Example:

- Volume Medium
- Volume Medium and Ringer Off

- 2 The number is dialed. After about 5 seconds, the call-time display appears.

- 3 To hang up, press **(talk)** or place the handset on the base. The call-time will be displayed for about 5 seconds.

```

-Talk-
8002971023
    
```

```

Talk
Volume Medium
    
```

```

Talk
Volume Medium
<Ringer Off>
    
```

```

Talk 0:00
8002971023
    
```

Other Operations

To	Do this
To improve the reception	Press (select/channel) during a call.
To adjust the earpiece volume	Press (▲) or (▼) during a call.
To temporarily switch to tone dial (when the base is set to pulse mode)	Press (tone) . The following numbers will be sent as tone dialing.
To enter a pause within the dialing sequence	Press (redial/p) . "P" appears on the display which represents a pause.

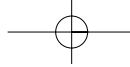

Dialing from Talk Mode

1 Press **(talk)**. "Talk" flashes on the display.

Then current volume setting is displayed.

note If you set the ringer to off, "Ringer Off" appears on the display.

2 Dial the phone number.

Example: Enter 8002971023

3 To hang up, press **(talk)** or place the handset on the base. The call-time will be displayed for about 5 seconds.

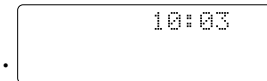
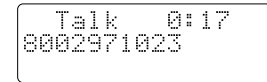
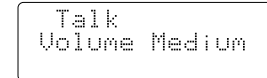
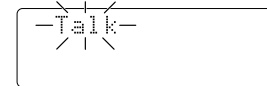

From the base

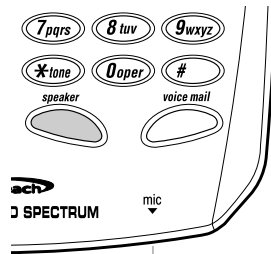

Microphone

1 Press **(speaker)**.

2 Dial the number on the keypad.

3 When you finish the call, press **(speaker)** to hang up.



The base microphone is located under the phone. Position yourself as near to the base as possible and speak clearly.

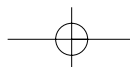

Receiving a Call

From the handset

- 1 The phone rings.
- 2 Press **(talk)**. "Talk" and the volume setting appears on the display.

note If you set the ringer to off, "Ringer Off" appears on the display.
- 3 Talk with the caller.
- 4 To hang up, press **(talk)** or place the handset on the base. The call-time will be displayed for about 5 seconds.

Incoming Call

Talk 0:00
Volume Medium

Talk 0:02

1:15:35

AutoTalk when ringing

When the AutoTalk setting is on and there is an incoming call, simply lift the handset from the base unit to answer the phone. See "Setting Caller ID options" on page 12 for more details.

Any key answer when ringing

When the AutoTalk setting is on and the handset is off the base, press any handset key to answer the incoming call.

Call Waiting

Note: You must subscribe to Call Waiting service to use this feature.

When a call is received during a telephone call already in progress, press **(cid/flash)** to switch to the new call. If you also subscribe to Call Waiting on Caller ID, you will see the name and number of the caller in call waiting. (See page 42.)

From the base

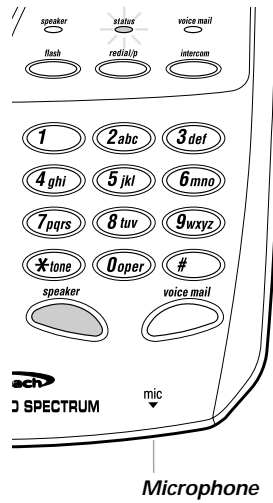



- 1 The phone rings. The *status* LED on the base flashes.
- 2 Press **speaker** and begin speaking.
- 3 To hang up, press **speaker**.



The base microphone is located under the phone. Position yourself as near to the base as possible and speak clearly.



Adjusting the Volume



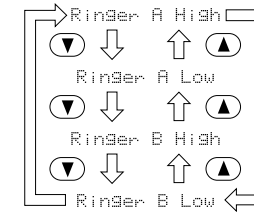





Handset ringer tone and volume



Press  or  in standby mode to select one of four ringer tones and volume combinations. (Refer to terminology explanation on page 3 if necessary.)



Earpiece volume



Pressing  or  during a call will change the earpiece volume of the handset. This setting will remain in effect after the telephone call has ended.

Volume Maximum   Volume High   Volume Medium   Volume Low  

note When you press  in Maximum mode or  in Low mode, an error tone sounds.

Handset ringer off

During the standby mode or tone/volume setting, press and hold  until "Ringer Off" appears.

To turn the ringer back on, simply press  or .

"Ringer A High" appears.

Base ringer switch

This switch turns the base ringer on or off.

Base speaker volume

To control the speaker volume of the base, adjust the volume slide control as desired.

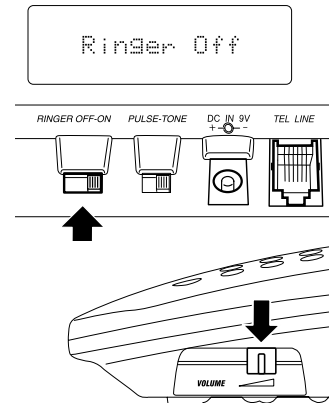

Redialing a Call

The last three phone numbers dialed can be quickly redialed.

Redialing from Standby Mode

- 1 Press **(redial/p)**.
The phone number that was last dialed appears on the display.
- 2 Press **(redial/p)** again.
Each press of **(redial/p)** will display one of the last three numbers dialed.

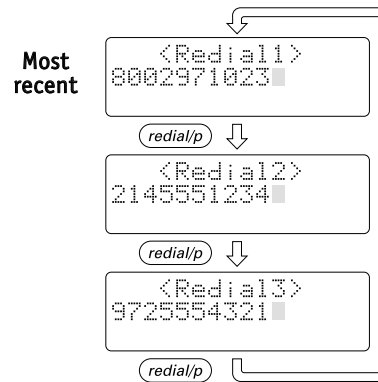

- 3 Press **(talk)**. "Talk" appears on the display, then the volume setting is displayed.
- 4 The selected number is dialed. After about 5 seconds, the call-time display appears.
- 5 To hang up, press **(talk)** or place the handset on the base. The call-time will be displayed for about 5 seconds.



- If the number exceeds 32 digits, only the first 32 digits are retained for redialing.
- Press and hold **(delete/int com)** to delete the displayed redial number.
- Refer to terminology explanation on Page 3, if necessary.



Only the last number dialed can be accessed after **talk** has been pressed.

Redial from Talk Mode

1 Press **talk**. "Talk" appears on the display.



note If you set the ringer to off, "Ringer Off" appears on the display.

2 Press **redial/p**. The last number dialed will be displayed and redialed.

3 To hang up, press **talk** or place the handset on the base. The call-time will be displayed for about 5 seconds.

From the Base

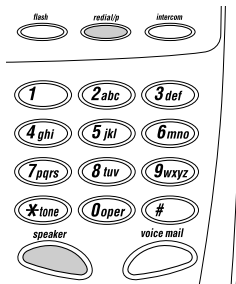

1 To call the last number dialed from the base, press **speaker**.

2 Press **redial/p**. The last number dialed from the base is redialed.

3 To hang up, press **speaker**.

Traveling Out-of-Range

During a call, as you begin to move your handset too far from your base unit, noise increases. If you pass the range limits of the base unit, your call will terminate within 30 seconds.

Using One Touch Voice Mail Access

If you subscribe to voice mail service, you can use your EXT 1365 to access your voice mailbox. The message light on the base of your phone flashes whenever you have messages waiting in your voice mailbox. Just program the **v.mail** key with your access number and you can get your messages at the touch of a button. (The voice mail service provider will supply you with the access number. This number may be simply a phone number. Refer to the provider's literature.)

Programming your Voice Mail Access Number

- 1 On the handset, press and hold **v.mail** for about 2 seconds. The following screen appears:

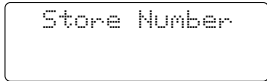

Store Number

If you have previously stored a number, the following display appears:

Use the **▲** and **▼** to move the pointer to the "Edit Number" option. Press **select/channel** to select the option.

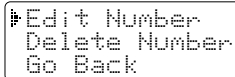

▶ Edit Number
Delete Number
Go Back

- 2 Enter your personal access number.
- 3 Press **select/channel**. You will hear a confirmation tone and the following display appears:



Number Stored

With the Base

- 1 Press and hold **voice mail** in standby mode.
- 2 Enter your personal access number.
- 3 Press **voice mail** again. You will hear a confirmation tone.



note

You must subscribe to voice mail service from your telephone company in order to use this feature. The voice mail service company will provide you with the access number.

Dialing your Voice Mail Service

Once you've programmed your personal access number, you can dial your mailbox with the touch of a button. When you have messages, simply pick up the handset and press **(v.mail)**. Or press **(talk)**, listen for the dial tone, and then press **(v.mail)**. If you have not entered the access number or it has been deleted, when you press **(v.mail)**, an error tone sounds.

Message Waiting Indicator

The **voice mail** LED indicator on the base is designed to work with voice mail service provided by your local telephone company. The indicator flashes when you have new voice messages.

You may need to occasionally reset the indicator if it remains on after you've retrieved your messages. To reset the indicator, return the handset to the base and press and hold **(intercom)**.

Deleting the Voice Mail Number

- 1 Press and hold **(v.mail)** in standby mode. You will hear a confirmation tone.
- 2 Use the **(▲)** or **(▼)** to move the pointer to "Delete Number".
- 3 Press **(select/channel)**.
- 4 Press **(▲)** to select "Yes".
- 5 Press **(select/channel)** or **(delete/int com)**. You will hear a confirmation tone.

```

Edit Number
Delete Number
Go Back
  
```

```

Delete Number?
▶ Yes
No
  
```

With the base

- 1 Press and hold **(v.mail)** in standby mode.
- 2 Press **(v.mail)** again. You will hear a confirmation tone.

Storing Phone Numbers and Names

Memory Dialing allows you to dial a number using just a few key presses. Your EXT 1365 stores up to 20 names/numbers in the handset.

With the handset

- 1 Press and hold **(memory)** until "Memory Store" is displayed in standby mode.

```
Memory Store
01▶
02
```

- 2 Press **(▲)** and **(▼)** or enter a two-digit number (01 - 20) to select the memory location where you would like to store the number.

- 3 Press **(select/channel)**. The following screen appears and a cursor flashes indicating that the display is ready for the name to be entered.

```
Store Name
█
```

If this screen appears, the selected memory location is already stored. Then you must either change the entry in this location, clear the entry in this location, or select "Go Back" to choose another location.

```
▶Edit Memory07
Delete Memory07
Go Back
```

- 4 To enter a name (up to 13 characters), use the number keys.
 - See the "Steps for entering names and special characters". (See pages 25-26.)
 - Use **(#▶)** and **(Xtone▶)** to move the cursor to the desired location.



In memory dialing operation, you must press a key within 20 seconds or the phone will return to standby. If you return the handset to the base, the phone will return to standby also.



The pause feature is useful for long distance calling, credit card dialing, or sequences that require a pause between digits.

- Use *delete/int com* to delete characters as needed.
- Press and hold *delete/int com* to delete all the characters.
- If a name is not required, go to step 5.

5 Press *select/channel*.

"Store Number" is displayed. The cursor flashes indicating that the display is ready for the number to be entered.

```
Store Number
█
```

6 Use the number keypad to enter the phone number. The phone number cannot exceed 20 digits.

- Use *redial/p* to enter pause in the dialing sequence. The display shows a "P". Each pause counts as one digit and represents a two second delay of time between the digits.
- Use *delete/int com* to delete digits as needed.

```
Store Number
8002971023█
```

7 Press *select/channel*.

The handset beeps and displays the confirmation screen. Memory storage is complete.

For example, if you store a name and number into memory location number 07, the display shows "Memory07 Stored". After about 2 seconds, "Memory Store" is displayed.

```
Memory07 Stored
```

```
Memory Store
07*UNIDEN CORP
08
```

8 Press *memory* to return to standby mode.

Steps for Entering Names and Special Characters

Refer to the letters on the number keys to select the desired characters. With each press of a numeric key, the displayed character appears in the following order: Upper case letters first, lower case letters next and finally the number corresponding to the key.

keys	Number of times key is pressed								
	1	2	3	4	5	6	7	8	9
1	1								
2abc	A	B	C	a	b	c	2		
3def	D	E	F	d	e	f	3		
4ghi	G	H	I	g	h	i	4		
5jkl	J	K	L	j	k	l	5		
6mno	M	N	O	m	n	o	6		
7pqrs	P	Q	R	S	P	q	r	s	7
8tuv	T	U	V	t	u	v	8		
9wxyz	W	X	Y	Z	w	x	y	z	9
0	*	#	-	&	()	(blank)	0	

If you make a mistake while entering a name

Use **(Xtone←)** or **(#→)** to move the cursor to the incorrect character. Press **(delete/int com)** to erase the wrong character, then enter the correct character. To delete all characters, press and hold **(delete/int com)**.

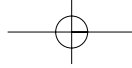

For example, to enter **Uniden**:

- 1 Press and hold **(memory)** in standby mode.
- 2 Enter a two-digit number or press **(▲)**, **(▼)** to select a memory location number.
- 3 Press **(select/channel)**.
- 4 Press **(8)** twice.
- 5 Press **(6)** five times.
- 6 Press **(4)** six times.
- 7 Press **(3)** four times, then press **(#▶)** to move the cursor to the right.



If the next character uses the same number key, you must press **(#▶)** to move the cursor over. Otherwise the next time you press the number key, it changes the character that was previously set.

- 8 Press **(3)** five times.
- 9 Press **(6)** five times.
- 10 When finished, Press **(select/channel)**.

To continue to store the telephone number, proceed to step 6 on page 24.

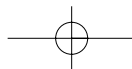

Making Calls with Memory Dialing

Memory dialing from Standby Mode

- 1 Press **(memory)**.
The handset displays your programmed memory locations.
- 2 Press **(▲)** and **(▼)** or enter a two-digit number (01 - 20) to select the memory location you would like to dial.
- 3 Press **(talk)**. "Talk" and the volume setting appear on the display. Then the displayed number is dialed.

```
01 UNIDEN CORP
02 JOHN DOE
03 MOM AND DAD
```

```
-Talk-
0123456789012
```

Display a Programmed Number

Use **(#▶)** and **(*tone◀)** to toggle between the names display and the numbers display.

Program name		Program number
01 UNIDEN CORP	▶	01 800-297-1023
02 JOHN DOE		02 5452930
03 MOM AND DAD	◀	03 8175551212

- note** When the stored phone number has 14 or more digits, "➔" is displayed next to the 12th digit. Press **(#▶)** to see the extra digits and **(*tone◀)** to return.

```
05 012345678901
06 011813554329➔
07
```

note

- If you press **(select/channel)** before **(talk)**, you can confirm the name and number stored in the selected memory location. To exit this mode, press and hold **(delete/int com)** until the display clears.
- To exit the memory mode without dialing, press **(memory)**.

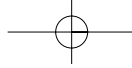

Memory dialing from Talk Mode

1 Press **(talk)**. "Talk" and the volume setting appears.

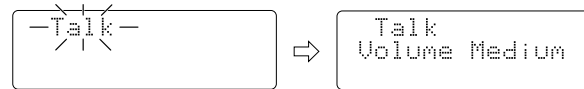

(note) If you set the ringer to off, "Ringer Off" appears on the display.

2 Press **(memory)**.

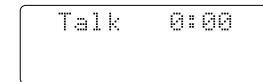

3 Enter a two-digit number (01 - 20) to select the memory location of the desired phone number. The selected phone number is displayed. Then the number is dialed.

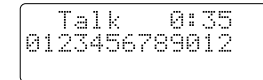

4 To hang up, press **(talk)**.

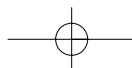
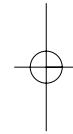
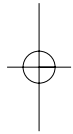

Editing a Stored Name and/or Phone Number

- 1 Press and hold **memory** in standby mode until "Memory Store" is displayed.
- 2 Press **▲** and **▼** or enter a two-digit number (01 - 20) to select the memory location you would like to edit.
- 3 Press **select/channel**.
The following screen appears with the memory location number that you have selected in the display.
- 4 Press **▲** or **▼** to select "Edit Memory", then press **select/channel**. The following screen appears.
The cursor flashes indicating that the display is ready for the name to be edited. When a name has not been stored, the cursor appears at the beginning of the second line.
- 5 Press the number keypad, ***tone**, ***▶**, or **delete/int com** to edit the name. (See page 26.)
To edit only the phone number, skip this step.
- 6 Press **select/channel**. The following screen appears.
The cursor flashes indicating that the display is ready for the number to be edited.

```
Memory Store
01▶UNIDEN CORP
02 JOHN DOE
```

```
▶Edit Memory01
Delete Memory01
Go Back
```

```
Store Name
UNIDEN CORP█
```

```
Store Number
800297102█
```



To edit the numbers that you have stored in the base, simply overwrite the existing number.

7 Use the number keypad, **(redial/p)** or **(delete/int com)** to edit the phone number. The phone number cannot exceed 20 digits. (See page 24.) If you don't want to change the phone number, skip this step.

8 Press **(select/channel)**. The handset beeps and displays the confirmation screen. The memory storage is complete. For example, if you store a name and number into memory location number 01, the display shows "Memory01 Stored". After about 2 seconds, "Memory Store" is displayed.

```
Memory01 Stored
```

```
Memory Store
01 UNIDEN CORP
02 JOHN DOE
```

9 Press **(memory)** to return to standby mode.

Erasing a Stored Name and Phone Number

1 Press and hold **(memory)** in standby mode until "Memory Store" is displayed.

```
Memory Store
01 UNIDEN CORP
02 JOHN DOE
```

2 Press **(▲)** and **(▼)** or enter a two-digit number (01 - 20) to select the memory location you would like to erase.

3 Press **(select/channel)**.

The following screen appears with the memory location number that you have selected in the display.

```
Edit Memory02
Delete Memory02
Go Back
```

4 Press **(▼)** to move the pointer down to "Delete Memory" command line.

```
Edit Memory02
Delete Memory02
Go Back
```

5 Press **(select/channel)**. The following confirmation screen appears.

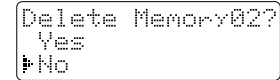

Delete Memory02?
Yes
No

6 Press **(▲)** to move the pointer to "Yes".

7 Press **(select/channel)** or **(delete/int com)**. You will hear a confirmation tone and the entry is deleted. The following screen appears.



Memory02 Deleted

8 After a few seconds the display returns to the "Memory Store" screen. You may select another number to delete (return to step 2) or press **(memory)** to return to standby.



Memory Store
02
03 MOM AND DAD



- Pressing the **speaker** key on the base while dialing with the handset will set the 3-way conversation mode, and dialing is not affected.
- During a 3-way conversation, you can only dial from the handset.
- Pressing the **talk** key on the handset while dialing with the base will not set the 3-way conversation mode, and you hear the busy tone.

3-way Conferencing

The Uniden EXT 1365 permits 3-way conversations between the handset, base and outside line.

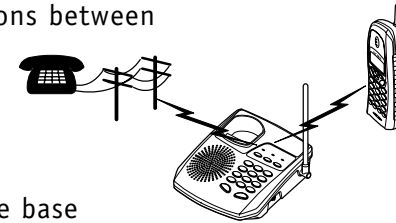

When speaking on the handset

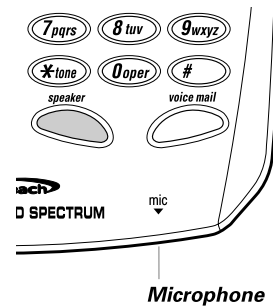

- 1 Press **speaker** on the base to join the 3-way conversation.
- 2 To hang up, press **speaker** on the base. The handset will still be connected to the call.

When speaking on the base

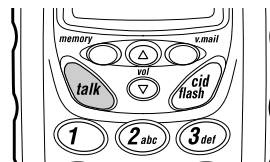

- 1 Press **talk** on the handset to join the 3-way conversation.
- 2 To hang up, return the handset to the base, or press **talk** on the handset. The base will still be connected to the call.

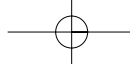

Intercom Feature

Intercom from the base to handset

- 1 Press **intercom** on the base. The handset and base beep. "Paging" appears on the display. (If no answer, press **intercom** again to disconnect.)
- 2 Press **delete/int com** or **talk** on the handset to answer. "Intercom" appears on the display.
- 3 To turn off the intercom, press **talk** on the handset or **speaker** on the base.

Intercom from the handset to base

- 1 Press **delete/int com** on the handset. The handset and base beep. "Paging Base" appears on the handset display. (If no answer, press **delete/int com** again to disconnect.)
- 2 At the base, press **intercom** or **speaker** to answer. "Intercom" appears on the display. Speak into the base microphone.
- 3 To turn off the intercom, press **talk** on the handset or **speaker** on the base.



note

If the page is not answered within one minute, the paging sounds stops automatically.

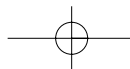

Call Transfer Feature

To Transfer from the Handset to the Base

- 1 Press **(delete/int com)** on the handset. The caller is put on hold and the intercom tone sounds on the handset and the base. "Hold Paging Base" appears on the display.
- 2 Press **(intercom)** or **(speaker)** on the base. "Hold Intercom" appears on the display. The intercom mode is activated, but the caller is still on hold.
- 3 To transfer the call to the base, press **(talk)** on the handset. To cancel the transfer, press **(speaker)** on the base.

To Transfer from the Base to the Handset

- 1 Press **(intercom)** on the base. The caller is put on hold and the intercom tone sounds on the handset and the base. "Hold Paging" appears on the display.
- 2 Press **(delete/int com)** or **(talk)** on the handset. "Hold Intercom" appears on the display. The intercom mode is activated, but the caller is still on hold.
- 3 To transfer the call to the handset, press **(speaker)** on the base. To cancel the transfer, press **(talk)** on the handset.

Chain Dialing

The memory locations on the handset and base are not limited to phone numbers, you may want to store in memory a group of numbers (up to 16 digits) that you need to enter once your call connects. This is referred to as Chain Dialing.

Selecting a Different Channel

If you encounter interference while using your phone, you can manually change the phone's channel for clear operation. Interference can come from appliances or other phone in your home (see troubleshooting on page 52).

Tone Dialing Switch-over

Some telephone companies use equipment that require pulse dialing (sometimes referred to as rotary dialing). If you need to enter tone dialing digits, you can switch-over to tone dialing during the call. An example of this could be entering your bank account number after you have called your bank. The digits of your bank account can be entered using DTMF tones.

Initially make your call with the pulse dialing mode. Once your call connects, press **(**tone*)**. Enter the desired number (like in the example above, the bank account number). These digits will be sent as tone dialing. This special number can be stored in a memory location. This is referred to as Chain Dialing. Once the call ends, the tone mode is canceled and pulse dialing resumes.



- If you answer a call before the Caller ID message is received (Example: before the second ring), the Caller ID message will not appear.
- When the call is received via a telephone company that does not offer Caller ID service, the caller's phone number and name do not appear. (This includes international calls.)
- When the call is via a private branch exchange (PBX), the caller's phone number and name may not appear.

Caller ID

You must subscribe to Caller ID service to use this feature.

When the telephone rings, the Caller ID feature allows you to view the caller's name and phone number on the display before you answer the phone. The handset displays the phone number of the incoming call and the name. Additionally, you can dial the displayed number and store the information for memory dialing. Make sure you have turned on the Caller ID/Call Waiting feature (See page 12).

When the Telephone Rings

- 1 When the Caller ID message is received, the display shows the caller's phone number. The incoming call information is stored in the Caller ID record.
If the Caller ID service includes the caller's name, the caller's name appears on the display (up to 15 letters).

Caller's name — Incoming Call
UNIDEN CORP
Caller's phone number — 800-297-1023

Here are some typical displays:

When the phone number and name data are received

```
Incoming Call
UNIDEN CORP
800-297-1023
```

When invalid data is received

```
Incoming Call
Incomplete Data
```

When the ringer is off

```
<Ringer Off>
UNIDEN CORP
800-297-1023
```

When a private name is received

```
Incoming Call
Private Name
800-297-1023
```

When a private number is received

```
Incoming Call
UNIDEN CORP
Private Number
```

When an unknown name is received

```
Incoming Call
Unknown Name
800-297-1023
```

When an unknown number is received

```
Incoming Call
UNIDEN CORP
Unknown Number
```

2 When you pick up the phone, the display changes to "Talk".



Data errors appear as "■".

```
Talk 10:30
UNIDEN CORP
800-2■■-1023
```

Viewing the Caller ID Message List

The Caller ID list stores information for up to 50 incoming calls - even unanswered calls.

1 Press **(cid/flash)**. The summary screen appears. The screen shows the number of new messages and total messages.

```
New :01
Total:02
```

2 Press **(v)** to display the latest Caller ID message.

```
5/17 12:30PM 03
UNIDEN CORP
800-297-1023
```

3 Press **(v)** to see the next message. Or press **(u)** to see previous message.

4 Press **(cid/flash)** to return to standby.



- In Caller ID operation, if no key is pressed for more than 20 seconds, an error tone sounds and the telephone returns to the standby mode.
- If a call comes in via a telephone system that does not offer Caller ID service, no information is stored.
- Each message can be up to 15 characters for the phone number and the name.



If you get an incoming call or page, the deleting operation is canceled and the telephone returns to standby so you can answer the call or page.

Deleting Information from the Caller ID List

The EXT 1365 stores up to 50 messages. If the phone receives the 51st message, the oldest one in the list is automatically deleted. Caller ID data can also be deleted manually.

Deleting a Caller ID message

- 1 Press **(cid/flash)**. Display the message to be deleted from the Caller ID list by pressing **(▲)** or **(▼)**.

```
5/17 12:30PM 03
UNIDEN CORP
800-297-1023
```

- 2 Press **(delete/int com)**.

```
Delete Message?
▶ Yes
No
```

- 3 Press **(▲)** or **(▼)** to select "Yes" or "No".

- 4 Press **(select/channel)** or **(delete/int com)**.

When the pointer is at "Yes" :

A tone sounds and the Caller ID message is deleted. The next Caller ID message is then displayed.

When the pointer is at "No" :

The display returns to the Caller ID message.

Deleting all Caller ID names/numbers

- 1 Press `(cid/flash)`.
- 2 Press `(delete/int com)`.
- 3 Press `(▲)` or `(▼)` to select "Yes" or "No".
- 4 Press `(select/channel)` or `(delete/int com)`.

When the pointer is at "Yes":

A tone sounds and all stored Caller ID messages are deleted.

When the pointer is at "No":

The display returns to the summary screen.

```
New :01  
Total:02
```

```
Delete All?  
Yes  
*No
```

```
Total:00
```

```
New :01  
Total:02
```



While using the "Delete All?" screen if no key is pressed within 20 seconds, an error tone sounds and the telephone returns to standby.



- You cannot make a call from the Caller ID list if your EXT 1365 is connected to a private branch exchange (PBX).
- When a long distance call has been set, "1" appears in the display.

Using the Caller ID List

Calling a party from the Caller ID list

You can place a call from the Caller ID list. The EXT 1365 stores up to 50 messages.

- 1 Press **(cid/flash)**. Select the phone number that you want to dial by pressing **(▲)** or **(▼)**.
- 2 Press **(talk)**. The displayed phone number dials automatically.

```
5/17 12:30PM 03
UNIDEN CORP
800-297-1023
```

```
Talk
800-297-1023
```

Long Distance calls and Area Code setting/cancellation

Pressing **(1)** while the incoming call information is displayed (in step 1) will place the prefix "1" in the display to set up for a long distance call. Pressing **(3)** will set or cancel an area code setting.

Dial edit

You can temporarily edit the Caller ID number that is displayed by pressing **(select/channel)**. A cursor appears in the display. Press **(delete/int com)** to move the cursor left, make your changes and then press **(talk)**. This will not change the number in the Caller ID list menu.

Storing Caller ID messages in Memory dialing

Messages shown in the Caller ID list can be stored in memory dialing. Using the incoming call information (i.e., Caller ID list), the phone number of the party on the Caller ID list can be stored in memory dialing.

- 1 Press **(cid/flash)**.
Select the phone number to be stored from the Caller ID list by pressing **(▲)** or **(▼)**.
- 2 Press **(memory)**.
- 3 Press **(▲)** and **(▼)** or enter a two-digit number (01 - 20) to select the memory location to be stored.
- 4 Press **(select/channel)**.
A tone will sound. The number is stored in memory, and the display returns to the Caller ID list.

note If a message has already been stored in the selected memory number location, a confirmation screen is displayed. Press **(▲)** to select "Yes". Press **(select/channel)** to overwrite. The display returns to the Caller ID list.

```
5/17 12:30PM 03
UNIDEN CORP
800-297-1023
```

```
Select Location
01 UNIDEN CORP
02 JONE DOE
```

```
5/17 12:30PM 03
UNIDEN CORP
800-297-1023
```

```
Replace Memory?
Yes
#No
```



- You can not store a Caller ID message if no phone number appears in the message.
- If there is an incoming call or page, memory storage is canceled and the telephone is set to receive the incoming call or page.

Using “Caller ID on Call Waiting” Service

“Caller ID” and “Call Waiting” are separate services. CIDCW (Caller ID on Call Waiting) performs the same as regular Caller ID on a Call Waiting number. You must subscribe to the “Caller ID on Call Waiting (CIDCW) services” before you can use the following features. The “Call Waiting” service can also be used independently. Please contact your local telephone company for details.

- 1 When a new incoming call arrives during your current telephone call, the phone number and the name of the caller are displayed.

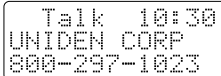

```
Talk 10:30
UNIDEN CORP
800-297-1023
```

- 2 Press **(cid/flash)**.
You will be able to talk with the second caller. The first caller will be put on hold.
- 3 To return to the first caller, press **(cid/flash)** again.



When CIDCW is set to “Off” in the Caller ID setup menu (See page 12), you can press the **(menu)** key after receiving a call waiting call and view a list of ways to handle the new call. Choose an option using the **(▲)** and **(▼)** keys and press **(select/channel)** to activate.

Call Waiting Features

Your EXT 1365 gives you new options for Call Waiting. At the touch of a button, you can ask the caller to hold, send them to your voice mail service, or conference them into your current call. You may be required to subscribe to Call Waiting and Call Waiting options to use these features. Not all features are available in all areas. Check with your local telephone company for details.

- 1 When you receive a Call Waiting call, press **menu** for a list of options.
- 2 Press the **▲** or **▼** key to select an option.

1 Ask to Hold	▲	3 Take Message	▲	5 Conference
2 Tell Busy	or	4 Answer/Drop 1	or	6 Drop First
3 Take Message	▼	5 Conference	▼	7 Drop Last

- 3 Press **select/channel** .
A confirmation screen will appear.

Your EXT 1365 is pre-programmed with seven Call Waiting options. You may select to ask the calling party to **hold**, send them a **busy** message, **forward** them to your voice mail, or **conference** them into the current call. You may also select to **answer and drop** the first caller or, at any time, choose to **drop the first** or **drop the last caller**.

Check with your local telephone company for a full list of options.



You can also answer a Call Waiting call immediately by pressing the **cid/flash** key. The first caller will be placed on hold. To return to the original caller, press **cid/flash** again.



- You must select a service from the menu before pressing **talk**.
- When using certain calling features, local toll or long distance charges may apply.
- Certain calling features may not be used on some long distance calls or from certain types of business lines.

Accessing Calling Features

To access the network calling features programmed into your phone, follow the instructions below. General descriptions of each service are given in the following section. For complete instructions for using each service, please contact your local telephone company.

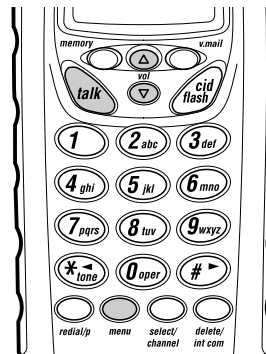

- 1 Press **menu**. The following screen appears.
- 2 Use the **▲** or **▼** key or enter a two-digit number (01-12) to select the feature you would like to use.
- 3 Press **talk**. Talk and the volume setting appears for a few moments. The display shows the activation code being dialed.

```
01 Call Return
02 Busy Redial
03 Cncl Call Wtg
```

```
Talk
*69
```

Pre-programmed Calling Features

The following calling features and activation codes are pre-programmed in the EXT 1365. Activation codes may vary depending on the local telephone company. See the page to reprogram a different code of any of these features.

No.	Calling features	Display	Preprogrammed activation codes
01	Last Call Return	Call Return	*69
02	Busy Call Return	Busy Redial	*66
03	Cancel Call Waiting	Cncl Call Wtg	*70
04	Call Forwarding	Call Forward	72#
05	Cancel Call Forwarding	Cncl Call Fwd	73#
06	Priority Calling	Priority Call	*61
07	Anonymous Call Rejection On	ACR On	*77
08	Anonymous Call Rejection Off	ACR Off	*87
09	Call Blocking	Call Block	*60
10	Select Blocking	Select Block	*67

Displaying the pre-programmed activation codes

Use the ***tone** and **#** keys to switch between the calling feature and its activation code.

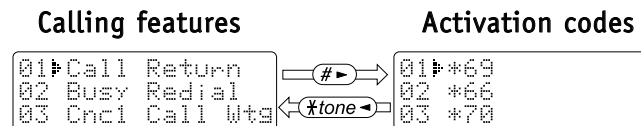

Descriptions of calling features

The following descriptions are typical and may vary depending on local calling area and service availability. For complete instructions, please contact your telephone company.

Last Call Return remembers the number of the person who called you last and automatically dials that number. This feature is useful if you just missed an incoming call.

Busy Call Return continually redials a busy number for you. When a number is busy, Busy Redial monitors the busy number and lets you know when the line is free.

Cancel Call Waiting temporarily cancels call waiting service. This feature is useful if you have call waiting service, but don't want to be disturbed during a call.

Call Forwarding allows you to send your calls to another phone, cellular or even pager number.

Cancel Call Forwarding temporarily cancels call forwarding.

Priority Calling lets you recognize special calls before you answer the phone. You can set up a list of up to 12 special phone numbers and the instant your phone rings, you'll know if the call is from one of these numbers by the distinctive ring. Your list can identify important callers or people you don't wish to talk to.

Anonymous Call Rejection stops calls from people who block their Caller ID information. Anonymous callers hear a message that you are not accepting blocked calls and how to unlock their calls. On your end of the line, the phone doesn't ring.

Call Blocking allows you to stop the specified calls before you answer the phone.

Select Blocking stops your name and telephone number, one call at a time, from being sent to Caller ID customers.

Adding New Features

The last two calling feature locations are available for you to program new features into your EXT 1365. You may also reprogram features in any of the other locations or restore the pre-programmed service at any time.

Add or edit a service

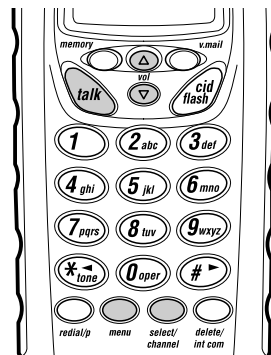

- 1 Press and hold **menu**.
The following screen appears.

```
Select to Edit
01 Call Return
02 Busy Redial
```

- 2 Use the **▲** and **▼** keys or number keys to select the feature location you would like to edit.

```
Select to Edit
01 Call Return
02 Busy Redial
```

- 3 Press **select/channel**.
The following screen appears with the service location number that you have selected in the display.

```
Edit Svc01
Restore Svc01
Go Back
```

You can restore a feature to its original pre-programmed service. Just select "Restore Svc01" and follow the instructions below.

If you have selected "Restore Svc01", the following display appears:

```
Restore Svc01?
Yes
No
```

Select "Yes" to restore Call Return. The following display appears. The phone returns to step 1.

```
Service Setting
Restored
```

- 4 Press **(select/channel)** to edit the feature stored in location two. The following screen appears:

The cursor flashes indicating that the name can be edited. Use the **(*tone◀)**, **(#▶)**, and number keys to enter a new name.

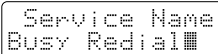

```
Service Name
Busy Redial█
```

Press the **(delete/int com)** key to delete a character.

Press and hold **(delete/int com)** to delete all characters at once.

- 5 Press **(select/channel)** when you have entered a new name. The following screen appears:

The cursor flashes indicating that the code can be edited or entered. Use the keypad to enter a new code.

If you enter a wrong digit, press the **(delete/int com)**.

To delete wrong digits all together, press and hold **(delete/int com)**.

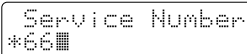

```
Service Number
*66█
```

- 6 Press **(select/channel)**. The following screen appears:

- 7 Press **(menu)** or return the handset to the base to return to standby mode.

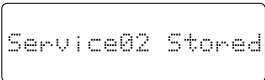

```
Service02 Stored
```

Changing the Digital Security Code

The digital security code is an identification code used to connect the handset and the base unit. Normally, setting the code is not necessary. The first time you charge your handset, the security code is automatically set. (See page 6.)

In the rare situation that you suspect another cordless telephone is using the same security code, you can change the code.

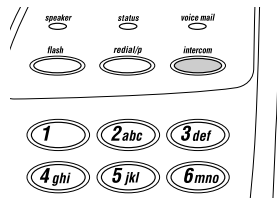

- 1 Remove the handset from the base unit. Press and hold **intercom** on the base.
- 2 While the handset is emitting the paging sound, replace the handset to the base unit. The paging tone stops. Leave the handset on the base for more than 3 seconds. A random, new security code is set.



If the handset battery pack is completely discharged or the battery pack is removed, the digital security code will be lost. If this happens, a new security code is set automatically next time the battery pack is charged.

Installing the Beltclip

To attach the beltclip

Insert the beltclip into the holes on each side of the handset. Press down until it clicks.

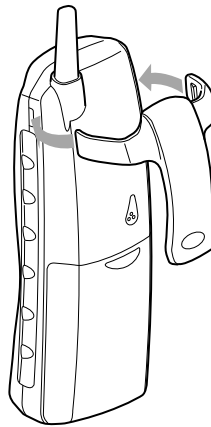

To remove the beltclip

Pull both sides of the beltclip to release the tabs from the holes.

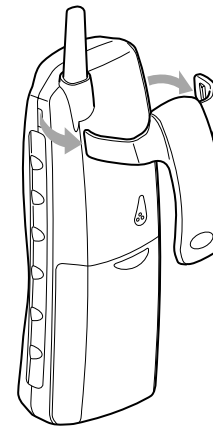

Headset Installation

Your phone may be used with an optional headset, the Uniden HS910. To use this feature, insert the headset plug into the headset jack. Your phone is ready for hands-free conversations. (Headsets may be purchased by calling the Uniden Parts Department or visiting the website. See Page 7.)

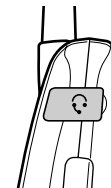

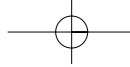

Note on Power Sources

Battery replacement and handling

When the operating time becomes short, even after a battery is recharged, please replace the battery.

With normal usage, your battery should last about one year.

Please contact your place of purchase or the Uniden Parts Department for a replacement battery. (See page 7)

Power Failure

During the period that the power is off, you will not be able to make or receive calls with the telephone.

Caution

- Use the specified battery pack.
- Do not remove the battery from the handset to charge it.
- Never throw the battery into a fire, disassemble it, or heat it.
- Do not remove or damage the battery casing.

RECYCLING NICKEL-CADMIUM BATTERIES



Nickel-cadmium cells are used in the battery pack. Please take your used nickel-cadmium battery packs to a store that recycles nickel-cadmium batteries.

Caution

Do not use paint thinner, benzene, alcohol, or other chemical products. Doing so may discolor the surface of the telephone and damage the finish.

ADDITIONAL INFORMATION [51]

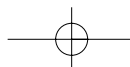
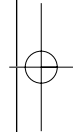
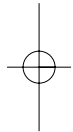

Maintenance

When slightly dirty

Wipe with a soft, dry cloth.

When very dirty

Wipe with a soft cloth that has been dampened with diluted, neutral detergent. Dry with a dry cloth.

When the charging terminals become dirty

Wipe with a dry cloth or a pencil eraser, if necessary.

Troubleshooting

If your phone is not performing to your expectations, please try these simple steps first.

Symptom	Suggestion
The status LED won't light when the handset is placed in the base unit.	<ul style="list-style-type: none"> • Make sure the AC adapter is plugged into the base unit and wall outlet. • Make sure the handset is properly seated in the base unit. • Make sure the charging contacts on the handset and base unit are clean.
The audio sounds weak and/or scratchy.	<ul style="list-style-type: none"> • Press (select/channel) during a call to help eliminate background noise. • Make sure that the base unit antenna is in a vertical position. • Move the handset and or base unit to a different location away from metal objects or appliances and try again. • Make sure that you are not too far from the base.
Can't make or receive calls.	<ul style="list-style-type: none"> • Check both ends of the base unit telephone line cord. • Make sure the AC adapter is plugged into the base unit and wall outlet. • Disconnect the AC adapter for a few minutes, then reconnect it. • Reset the digital security code (See page 49). • Make sure (talk) is pressed.

Symptom	Suggestion
The handset doesn't ring or receive a page.	<ul style="list-style-type: none">• The battery pack may be weak. Charge the battery on the base unit for more than 15-20 hours.• The handset may be too far away from the base unit.• Place the base unit away from appliances or metal objects.• Reset the digital security code (See page 49).
Severe noise interference.	<ul style="list-style-type: none">• Keep the handset away from microwave ovens, computers, remote control toys, wireless microphones, alarm systems, intercoms, room monitors, fluorescent lights, and electrical appliances.• Move to another location or turn off the source of interference.
The Caller ID/CIDCW does not display.	<ul style="list-style-type: none">• The handset was picked up before the second ring.• The call was placed through a switch board.• Call your local telephone company to verify your Caller ID service is current.• Make sure that the CIDCW option is set to "On" or "Off".
If you still have a problem.	<ul style="list-style-type: none">• Call our customer hotline at 1-800-297-1023.

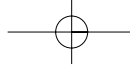

General Information

The EXT 1365 complies with FCC Parts 15 and 68.
Operating Temperature: 0°C to +50°C (+32°F to +122°F)

AC Adapter Information

AC Adapter part number: AD-312
Input Voltage: 120V AC 60Hz
Output Voltage: 9V DC 350 mA

Battery Information

Battery part number: BT-800
Capacity: 800 mAh, 3.6V
Battery Use Time (per charge)
From fully charged:
Talk Mode duration 6 hours
Standby Mode duration 10 days



If the handset is left off of the base, the actual Talk Mode duration will be reduced respective to the amount of time the handset is off the base.

Recharge your phone on a regular basis about once a week by placing the handset on the base for 15-20 hours. When the operating time becomes short, even after the battery is recharged, please replace the battery. With normal usage, the battery should last about one year.

Replacement batteries may be purchased at your local Uniden dealer or by contacting the Uniden Parts Department (800) 554-3988. Hours are from 7:00 a.m. to 5:00 p.m. Central Time, Monday through Friday. We can also be reached on the web at www.uniden.com

Specifications, features, and availability of optional accessories are all subject to change without prior notice.

[54] ADDITIONAL INFORMATION

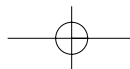

Precautions!

Before you read anything else, please observe the following:

Warning!

Uniden America Corporation DOES NOT represent this unit to be waterproof. To reduce the risk of fire, electrical shock, or damage to the unit, DO NOT expose this unit to rain or moisture.

Rechargeable Nickel-Cadmium Battery Warning

- This equipment contains a rechargeable nickel-cadmium battery.
- Cadmium is a chemical known to the State of California to cause cancer.
- The rechargeable nickel-cadmium battery contained in this equipment may explode if disposed of in a fire.
- **Do not** short-circuit the battery.
- Do not charge the rechargeable nickel-cadmium battery used in this equipment in any charger other than the one designed to charge this battery as specified in the owner's manual. Using another charger may damage the battery or cause the battery to explode.

Rechargeable Nickel-Cadmium Batteries Must Be Recycled or Disposed of Properly

- Uniden voluntarily participates in an RBRCC[®] industry program to collect and recycle nickel-cadmium batteries at the end of their useful life, when taken out of service within the United States. The RBRCC[®] program provides a convenient alternative to placing used nickel-cadmium batteries into the trash or municipal waste stream, which is illegal in some areas.
- Through the RBRCC[®] program, Uniden makes it easy for you to drop off the used battery at local retailers of replacement nickel-cadmium batteries. You may also contact your local recycling center for information on where to return the used battery. Please call 1-800-8-BATTERY for information on Ni-Cd battery recycling in your area. Uniden's involvement in this program is part of its commitment to protecting our environment and conserving natural resources.
- RBRCC[®] is a registered trademark of the Rechargeable Battery Recycling Corporation.



The exclamation point within an equilateral triangle is intended to alert the user to the presence of important operating and maintenance (servicing) instructions in the literature accompanying the appliance.

Important Safety Instructions

When using your telephone equipment, these basic safety precautions should always be followed to reduce the risk of fire, electrical shock, and injury to persons:

1. Read and understand all instructions.
2. Follow all warnings and instructions marked on the product.
3. Unplug this product from the wall outlet before cleaning. Use a dry cloth for cleaning without liquid or aerosol cleaners.
4. Do not use this product near water; for example, near a bath tub, wash bowl, kitchen sink or laundry tub, in a wet basement, or near a swimming pool.
5. Do not place this product on an unstable cart, stand, or table. The telephone may fall, causing serious damage to the unit.
6. Slots and openings in the cabinet and the back or bottom are provided for ventilation. To protect the product from overheating, these openings must not be blocked or covered. This product should never be placed near or over a radiator or heat register. This product should not be placed in a built-in installation unless proper ventilation is provided.
7. This product should be operated only from the type of power source indicated on the marking label. If you are not sure of the type of power supply to your home, consult your dealer or local power company.
8. Do not allow anything to rest on the power cord. Do not locate this product where the cord will be damaged by persons walking on it.
9. Do not overload wall outlets and extension cords, as this can result in the risk of fire or electrical shock.
10. Never push objects of any kind into this product through cabinet slots, as they may touch dangerous voltage points or short out parts that could result in a risk of fire or electric shock. Never spill liquid of any kind on the product.
11. To reduce the risk of electric shock, do not disassemble this product. Take it to qualified service personnel when service or repair work is required. Opening or removing covers may expose you to dangerous voltages or other risks. Incorrect reassembly can cause electric shock when the appliance is subsequently used.
12. Unplug this product from the wall outlet and refer servicing to qualified service personnel under the following conditions:
 - A. When the power supply cord is damaged or frayed.
 - B. If liquid has been spilled into the product.
 - C. If the product has been exposed to rain or water.
 - D. If the product does not operate normally when following the operating instructions. (Adjust only those controls that are covered by the operating instructions. Improper adjustment of other controls may result in damage and will often require extensive repair work by a qualified technician.)
 - E. If the product has been dropped or the cabinet has been damaged.
 - F. If the product exhibits a distinct change in performance.
13. Do not use the telephone to report a gas leak in the vicinity of the leak.

Additional Battery Safety Precautions

Caution! To reduce the risk of fire or injury to persons by the battery, read and follow these instructions:

1. Use only the appropriate type and size battery pack specified in the owner's manual.
2. Do not dispose of the battery pack in a fire. The cell may explode. Check the nickel-cadmium battery disposal package insert for disposal instructions.
3. Do not open or mutilate the battery pack. Released electrolyte is corrosive and may cause damage to the eyes or skin. It may be toxic if swallowed.
4. Exercise care in handling the battery in order not to short the battery with conducting materials such as rings, bracelets, and keys. The battery or conductor may overheat and cause burns.
5. Charge the battery pack provided with or identified for use with this product only in accordance with the instructions and limitations specified in the owner's manual provided for this product.
6. Observe proper polarity orientation between the battery pack and battery charger.

SAVE THESE INSTRUCTIONS!

Important Electrical Considerations

Unplug all electrical appliances when you know an electrical storm is approaching. Lightning can pass through your household wiring and damage any device connected to it. This phone is no exception.

Warning!

Please do not attempt to unplug any appliance during an electrical storm.

The FCC Wants You To Know

Changes or modifications to this product not expressly approved by Uniden, or operation of this product in any way other than as detailed by the owner's manual, could void your authority to operate this product. The equipment cannot be used on public coin phone service provided by the telephone company. Connection to party line service is subject to state tariffs. (Contact the state public utility commission, public service commission or corporation commission for information.)

Range

Your new phone is designed to achieve the maximum possible range by transmitting and receiving according to the highest specifications set forth by the FCC. We have rated this phone to operate at a maximum distance with the qualification that the range depends upon the environment in which the telephone is used. Many factors limit range, and it would be impossible to include all the variables in our rating. The Maximum Range rating of this phone is meant to be used as a means of comparison against other range claims.

Telephone Line Problems

The FCC has granted the telephone company the right to disconnect service in the event that your phone causes problems on the telephone line. Also, the telephone company may make changes in facilities and services which may affect the operation of your unit. However, your telephone company must give adequate notice in writing prior to such actions to allow you time for making necessary arrangements to continue uninterrupted service.

If you are having trouble with your telephone service, you must first disconnect your phone to determine if it is the cause of your problem. If you determine that it is the cause, you must leave it disconnected until the trouble has been corrected.

ADDITIONAL INFORMATION [55]

Radio Interference

Radio interference may occasionally cause buzzing and humming in your cordless handset, or clicking noises in the base. This interference is caused by external sources such as TV, refrigerator, vacuum cleaner, fluorescent lighting, or electrical storm. Your unit is NOT DEFECTIVE. If these noises continue and are too distracting, please check around your home to see what appliances may be causing the problem. In addition, we recommend that the base not be plugged into a circuit that also powers a major appliance because of the potential for interference. Be certain that the antenna on the unit is fully extended when needed.

In the unlikely event that you consistently hear other voices or distracting transmissions on your phone, you may be receiving radio signals from another cordless telephone or other source of interference. If you cannot eliminate this type of interference, you need to change to a different channel.

Finally, it should be noted that some cordless telephones operate at frequencies that may cause interference to nearby TVs and VCRs. To minimize or prevent such interference, the base of the cordless telephone should not be placed near or on top of a TV or VCR. If interference is experienced, moving the cordless telephone farther away from the TV or VCR will often reduce or eliminate the interference.

More Than One Cordless Telephone

If you want to use more than one cordless telephone in your home, they must operate on different channels. Press the channel key to select a channel that provides the clearest communication.

Cordless Telephone Privacy

Cordless telephones are radio devices. Communications between the handset and base of your cordless telephone are accomplished by means of radio waves which are broadcast over the open airways. Because of the inherent physical properties of radio waves, your communications can be received by radio receiving devices other than your own cordless telephone unit. Consequently, any communications using your cordless telephone may not be private.

Installation Considerations

Selecting a Location

Before choosing a location for your new phone, there are some important guidelines you should consider:

- The location should be close to both a phone jack and continuous power outlet. (A continuous power outlet is an AC outlet which does not have a switch to interrupt its power.)
- Keep the base and handset away from sources of electrical noise such as motors or fluorescent lighting.
- Be sure there is sufficient space to fully extend the base antenna.
- The base can be placed on a desk or tabletop or mounted on a standard telephone wall plate.
- You should charge your new phone for 15-20 hours before completing the installation or using the handset.

Telephone Line Outlets

There are two types of phone outlets:

Modular Jack

Most phone equipment available now uses modular jacks. Phone cords are fitted with a molded plastic connector which plugs into this type of jack. If you do not have modular phone jacks, contact your local telephone company for information about their installation.

Hardwired Jack

Some equipment is wired directly to a phone jack, and these types of installations require a modular jack converter. This type of installation is not difficult; however, you should contact your Uniden telephone dealer or a telephone supply store for advice about the proper adapter or converter for your particular situation.

Connecting the Telephone Cords

Consider these safety guidelines before connecting the telephone cords:

Caution!

- Never install telephone wiring during a lightning storm.
- Never touch uninsulated telephone wires or terminals unless the telephone line has been disconnected.
- Use caution when installing or modifying telephone lines.

Applying Power to the Base

This phone requires an AC outlet, without a switch to interrupt power, and the included AC adapter. To relieve strain on the DC plug when the phone is placed on a desk or table, wrap the power cord around the strain relief notch on the bottom of the base.

NOTE: Place the power cord so that it does not create a trip hazard, or where it could become chafed and create a fire or other electrical hazards.

Adapter Safety Features

If the AC adapter furnished with this phone has a polarized line plug (a plug having one blade wider than the other), this plug will fit into the power outlet only one way. If you are unable to insert the plug fully into the outlet, try reversing the plug.

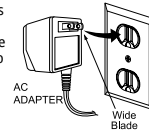

Do not alter the shape of the blades of the polarized plug!

NOTE: If you cannot plug the AC adapter into the outlet, contact someone about replacing the outlet.

Plug the AC Adapter into a standard 120 VAC wall outlet.

Do not use an outlet controlled by a wall switch.



Use only the Uniden AC Adapter supplied with this phone.

One Year Limited Warranty

Important: Evidence of original purchase is required for warranty service.

WARRANTOR: UNIDEN AMERICA CORPORATION ("Uniden")

ELEMENTS OF WARRANTY: Uniden warrants, for one year, to the original retail owner, this Uniden Product to be free from defects in materials and craftsmanship with only the limitations or exclusions set out below.

WARRANTY DURATION: This warranty to the original user shall terminate and be of no further effect 12 months after the date of original retail sale. The warranty is invalid if the Product is (A) damaged or not maintained as reasonable or necessary, (B) modified, altered, or used as part of any conversion kits, subassemblies, or any configurations not sold by Uniden, (C) improperly installed, (D) serviced or repaired by someone other than an authorized Uniden service center for a defect or malfunction covered by this warranty, (E) used in any conjunction with equipment or parts or as part of any system not manufactured by Uniden, or (F) installed or programmed by anyone other than as detailed by the owner's manual for this product.

STATEMENT OF REMEDY: In the event that the product does not conform to this warranty at any time while this warranty is in effect, warrantor will either, at its option, repair or replace the defective unit and return it to you without charge for parts, service, or any other cost (except shipping and handling) incurred by warrantor or its representatives in connection with the performance of this warranty. Warrantor, at its option, may replace the unit with a new or refurbished unit. THE LIMITED WARRANTY SET FORTH ABOVE IS THE SOLE AND ENTIRE WARRANTY PERTAINING TO THE PRODUCT AND IS IN LIEU OF AND EXCLUDES ALL OTHER WARRANTIES OF ANY NATURE WHATSOEVER, WHETHER EXPRESS, IMPLIED OR ARISING BY OPERATION OF LAW, INCLUDING, BUT NOT LIMITED TO ANY IMPLIED WARRANTIES OF MERCHANTABILITY OR FITNESS FOR A PARTICULAR PURPOSE. THIS WARRANTY DOES NOT COVER OR PROVIDE FOR THE REIMBURSEMENT OR PAYMENT OF INCIDENTAL OR CONSEQUENTIAL DAMAGES. Some states do not allow this exclusion or limitation of incidental or consequential damages so the above limitation or exclusion may not apply to you.

LEGAL REMEDIES: This warranty gives you specific legal rights, and you may also have other rights which vary from state to state. This warranty is void outside the United States of America.

PROCEDURE FOR OBTAINING PERFORMANCE OF WARRANTY: If, after following the instructions in the owner's manual you are certain that the Product is defective, pack the Product carefully (preferably in its original packaging). The Product should include all parts and accessories originally packaged with the Product. Include evidence of original purchase and a note describing the defect that has caused you to return it. The Product should be shipped freight prepaid, by traceable means, to warrantor at:

Uniden America Corporation
Parts and Service Division
4700 Amon Carter Blvd.
Fort Worth, TX 76155

(800) 297-1023, 7 a.m. to 7 p.m. Central, Monday through Friday

Technical Information

The FCC wants you to know!

Changes or modifications to this product not expressly approved by Uniden, or operation of this product in any way other than as detailed by the owner's manual, could void your authority to operate this product. The equipment cannot be used on public coin phone service provided by the telephone company. Connection to party line service is subject to state tariffs. (Contact the state public utility commission, public service commission or corporation commission for information.)

Below is some information that might concern you while using your new phone.

Range

Your new phone is designed to achieve the maximum possible range by transmitting and receiving according to the highest specifications set forth by the FCC. We have rated this phone to operate at a maximum distance with the qualification that the range depends upon the environment in which the telephone is used. Many factors limit range, and it would be impossible to include all the variables in our rating. The Maximum Range rating of this phone is meant to be used as a means of comparison against other range claims.

Telephone Line Problems

The FCC has granted the telephone company the right to disconnect service in the event that your phone causes problems on the telephone line. Also, the telephone company may make changes in facilities and services which may affect the operation of your unit. However, your telephone company must give adequate notice in writing prior to such actions to allow you time for making necessary arrangements to continue uninterrupted service.

If you are having trouble with your telephone service, you must first disconnect your phone to determine if it is the cause of your problem. If you determine that it is the cause, you must leave it disconnected until the trouble has been corrected.

Radio Interference

Radio interference may occasionally cause buzzing and humming in your cordless handset, or clicking noises in the base. This interference is caused by external sources such as TV, refrigerator, vacuum cleaner, fluorescent lighting, or electrical storm. Your unit is NOT DEFECTIVE. If these noises continue and are too distracting, please check around your home to see what appliances may be causing the problem.

ADDITIONAL INFORMATION [57]

In addition, we recommend that the base not be plugged into a circuit that also powers a major appliance because of the potential for interference. Be certain that the antenna on the unit is fully extended when needed.

In the unlikely event that you consistently hear other voices or distracting transmissions on your phone, you may be receiving radio signals from another cordless telephone or other source of interference. If you cannot eliminate this type of interference, you need to change to a different channel.

Finally, it should be noted that some cordless telephones operate at frequencies that may cause interference to nearby TVs and VCRs. To minimize or prevent such interference, the base of the cordless telephone should not be placed near or on top of a TV or VCR. If interference is experienced, moving the cordless telephone farther away from the TV or VCR will often reduce or eliminate the interference.

More Than One Cordless Telephone

If you want to use more than one cordless telephone in your home, they must operate on different channels. Press the channel key to select a channel that provides the clearest communication.

Cordless Telephone Privacy

Cordless telephones are radio devices. Communications between the handset and base of your cordless telephone are accomplished by means of radio waves which are broadcasted over the open airways. Because of the inherent physical properties of radio waves, your communications can be received by radio receiving devices other than your own cordless telephone unit. Consequently, any communications using your cordless telephone may not be private.

Index

0 - 9

3-way conferencing32

A

Adjusting the volume18

Area Code13

Auto Talk12

B

Base ringer switch18

Base speaker volume18

Battery pack

 Preparing and charging10

 Replacement and handling . . .51

C

Caller ID

 Advanced Call Waiting Features . .42

 Caller ID service36

 Calling40

 Call Waiting42

 Deleting38

 Setting12

 Storing41

 Using40

 Viewing37

Calling Features

 Accessing44

 Adding and Editing47

 Description46

 Options43

 Pre-programmed45

Connection11

D

Dialing mode11

Digital security code6, 49

E, F, G

Earpiece volume18

H

Headset installation50

I, J, K, L

Installing the beltclip50

Intercom33

M, N, O

Maintenance51

Making a call14

Memory dialing

 Editing a stored name

 and phone number29

Erasing a stored name

 and phone number30

Making calls

 with memory dialing27

Storing phone

 numbers and names23

P, Q

Package contents7

R

Receiving a call16

Redialing a call19

Ringer off18

Ringer volume18

S

Setting up the Base unit8

Setting up the Handset9

T, U, V, W, X, Y, Z

Technical Information3, 57

Transferring a call34

Troubleshooting52

Voice Mail21

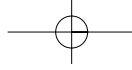

Memo

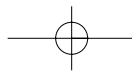
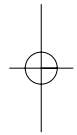
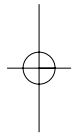

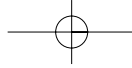

At Uniden, we'll take care of you!

If you need any assistance with this product, please call our Customer Hotline at

1-800-297-1023

PLEASE DO NOT RETURN THIS PRODUCT TO THE PLACE OF PURCHASE.

Our Uniden representatives will be happy to help you with any matters regarding the operation of this unit, available accessories, or any other related matters.

Thank you for purchasing a Uniden product.
Hours: M-F 7:00 AM to 7:00 PM CST.

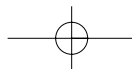

THANK YOU FOR PURCHASING A UNIDEN CORDLESS PHONE

A World Without Wires | **Uniden**[®]

Covered under one or more of the following U.S. patents:

4,511,761 4,523,058 4,595,795 4,797,916 5,381,460 5,426,690
5,434,905 5,491,745 5,533,010 5,574,727 5,650,790 5,660,269
5,661,780 5,663,981 5,671,248 5,717,312 5,754,407 5,768,345
5,787,356 5,838,721 5,864,619 5,893,034 5,912,968 5,915,227
5,929,598 5,930,720 5,960,358 5,987,330

© 2001 Uniden America Corporation, Fort Worth, TX
All rights reserved.

Printed in China
UCZZ01734BZ

Free Manuals Download Website

<http://myh66.com>

<http://usermanuals.us>

<http://www.somanuals.com>

<http://www.4manuals.cc>

<http://www.manual-lib.com>

<http://www.404manual.com>

<http://www.luxmanual.com>

<http://aubethermostatmanual.com>

Golf course search by state

<http://golfingnear.com>

Email search by domain

<http://emailbydomain.com>

Auto manuals search

<http://auto.somanuals.com>

TV manuals search

<http://tv.somanuals.com>