

H/O 100
H/O200
Owner's Manual

PRECAUTIONS

Before you read anything else, please observe the following:



WARNING! — Uniden America Corporation **DOES NOT** represent this unit to be waterproof. To reduce the risk of fire, electrical shock, or damage to the unit, **DO NOT** expose this unit to rain or moisture.

RECHARGEABLE NICKEL-CADMIUM BATTERY WARNING

- This equipment contains a Rechargeable Nickel-Cadmium Battery.
- Cadmium is a chemical known to the State of California to cause cancer.
- The Rechargeable Nickel-Cadmium Battery contained in this equipment may explode if disposed of in a fire.
- Do not** short-circuit the battery.
- Do not** charge the Rechargeable Nickel-Cadmium Battery used in this equipment in any charger other than the one designed to charge this battery as specified in this Guide. Using another charger may damage the battery or cause the battery to explode.

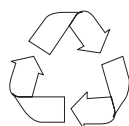

Ni-Cd

RECHARGEABLE NICKEL-CADMIUM BATTERIES MUST BE RECYCLED OR DISPOSED OF PROPERLY

Uniden voluntarily participates in an RBRC[®] program to collect and recycle nickel-cadmium batteries at the end of their useful life, when taken out of service within the United States. The RBRC[®] program provides a convenient alternative to placing used nickel-cadmium batteries into the trash or municipal waste stream, which is illegal in some states.

Through the RBRC[®] program, Uniden makes it easy for you to drop off the used battery at local retailers of replacement nickel-cadmium batteries. You may also contact your local recycling center for more information on where to return the used battery. Please call 1-800-8-BATTERY for information on Ni-Cd battery recycling in your area. Uniden's involvement in this program is part of its commitment to protecting our environment and conserving natural resources.

RBRC[®] is a registered trademark of the Rechargeable Battery Recycling Corporation.



The exclamation point within an equilateral triangle is intended to alert the user to the presence of important operating and maintenance (servicing) instructions in the literature accompanying the appliance.

Controls and Indicators

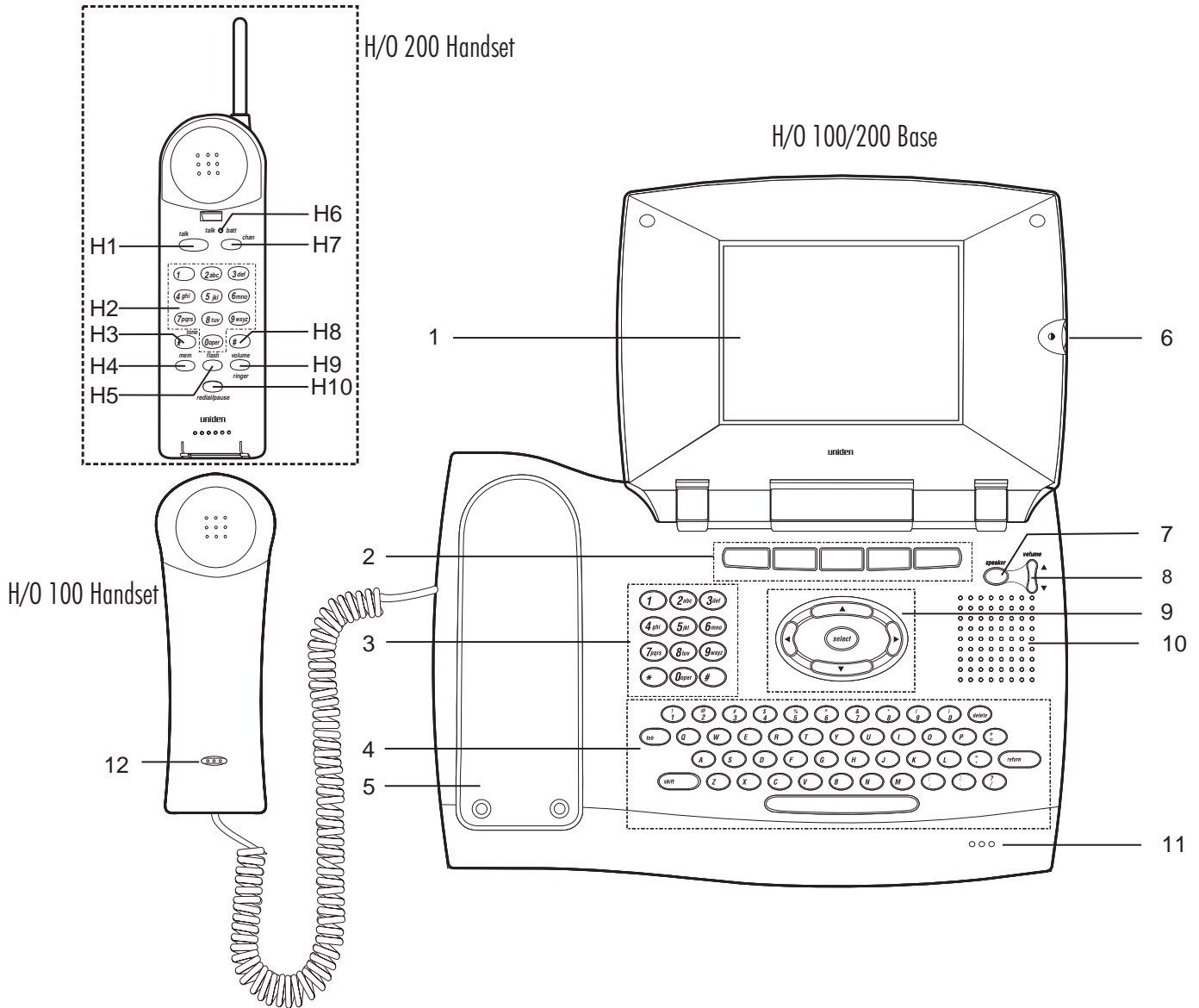

H/O 200 Handset

- H1. Talk Key *talk*
- H2. Numeric Keypad
- H3. Tone Key ***
- H4. Memory Key *mem*
- H5. Flash Key *flash*
- H6. Talk/Battery Low LED
- H7. Channel Key *chan*
- H8. Pound Key *#*
- H9. Volume/Ringer Control *volume/ringer*
- H10. Redial/Pause Key *redial/pause*

H/O 100/200 Base

- 1. LCD Screen
- 2. Function Keys
- 3. Numeric Keypad
- 4. **QWERTY** Keyboard
- 5. Charging Cradle
- 6. LCD Contrast
- 7. Speaker button *speaker*
- 8. Speaker Volume
- 9. Function Keys
- 10. Speaker
- 11. Base Microphone
- 12. H/O 100 Handset and Microphone

TABLE OF CONTENTS

Controls and Indicators	Back Cover Fold-out
Important Safety Instructions	3
H/O 200 Battery Safety Precautions.	5
Introduction	6
Getting Started	7
Unpack Your Phone.	7
Check the Contents	7
Preparing the Phone for Use	8
H/O 200 Final Touches	11
H/O 100 Final Touches	14
Initial Power Up	15
Setup	17
H/O 100/200 Functional Areas.	18
Setup Screen	21
Setting up the Phone	21
Home	25
The Home Screen	25
Entering notes	25
Modifying notes	26
Viewing notes	26
Address Book	27
Address Book Screen	27
Viewing Addresses	27
Modifying Addresses	28
Deleting Addresses	28
Entering New Addresses	29
Speed Dialing From the Address Book	29
Caller ID.	31
Caller ID Screen	31
Viewing Caller Information.	32
Deleting Caller Information	32
Adding Caller ID Information to the Address Book	32
Dialing From the Caller ID Menu.	32
Using Your Phone	33
Receiving Calls	33
Making Calls	33
Storing Memory Numbers (H/O 200)	34
Erasing a Stored Number (H/O 200).	34
Dialing Memory Numbers (H/O 200).	34
Chain Dialing (H/O 200)	34
Redialing the last Number Called (H/O 200).	35
Using Your Phone With Call Waiting (H/O 100 and H/O 200)	35
Paging the Handset (H/O 200).	35
Changing Channels (H/O 200).	35
Changing the Handset Ring Type and Ring Volume (H/O 200)	36
Changing the Handset Earpiece Volume (H/O 200)	36
Product Specifications	37

Important Safety Instructions

This product has been designed to assure your personal safety. Improper use can result in potential electrical shock or fire hazards. Carefully observe and comply with all warnings, cautions, and instructions placed on the product, or described in this operating guide.



WARNING! — When using your telephone equipment, these basic safety precautions should always be followed to reduce the risk of fire, electrical shock, and injury to persons:



Instructions — Read, understand, and retain all instructions.



Warnings — Follow all warnings and instructions marked on the product.



Cleaning — Unplug this product from the wall outlet before cleaning, and use a dry cloth, without liquid or aerosol cleaners.



Water and Moisture — Do not use this product near water; for example, near a bath tub, wash bowl, kitchen sink or laundry tub, in a wet basement, or near a swimming pool.



Placement — Do not place this product on an unstable cart, stand, or table. The telephone may fall, causing serious damage to the unit.

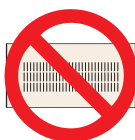

Ventilation — This product should never be placed near or over a radiator or heat register. This product should not be placed in a built-in installation unless proper ventilation is provided.

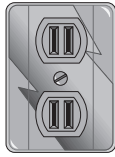

Power Sources — This product should be operated only from the type of power source indicated on the marking label. If you are not sure of the type of power supply to your home, consult your dealer or local power company.



Power-Cord Protection — Do not allow anything to rest on the power cord. Do not locate this product where the cord will be damaged by persons walking on it.

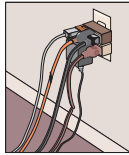

Overloading — Do not overload wall outlets and extension cords, as this can result in the risk of fire or electrical shock.



Obstructions — Never push objects of any kind into this product through cabinet slots, as they may touch dangerous voltage points or short out parts that could result in a risk of fire or electric shock. Never spill liquid of any kind on the product.



Servicing — To reduce the risk of electric shock, do not disassemble this product. Take it to qualified service personnel when service or repair work is required. Opening or removing covers may expose you to dangerous voltages or other risks. Incorrect reassembly can cause electric shock when the appliance is subsequently used.

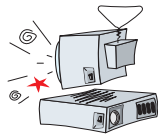

Damage Requiring Service — Unplug this product from the wall outlet and refer servicing to qualified service personnel under the following conditions:

- A. When the power supply cord is damaged or frayed.
- B. If liquid has been spilled into the product.
- C. If the product has been exposed to rain or water.
- D. If the product does not operate normally when following the operating instructions. (Adjust only those controls that are covered by the operating instructions. Improper adjustment of other controls may result in damage and will often require extensive repair work by a qualified technician.)
- E. If the product has been dropped or the cabinet has been damaged.
- F. If the product exhibits a distinct change in performance.



Hazards — Do not use the telephone to report a gas leak in the vicinity of the leak.



Privacy — Cordless telephones are radio devices. Communications between the handset and base of your cordless telephone are accomplished by means of radio waves which are broadcast over the open airways. Because of the inherent physical properties of radio waves, your communications can be received by radio receiving devices other than your own telephone unit. Consequently, any communications using your cordless telephone may not be private.

SAVE THESE INSTRUCTIONS

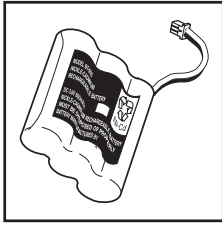

H/O 200 Battery Safety

Precautions



To reduce the risk of fire or injury to persons by the battery, read and follow these instructions:

Recommended Battery — Use only the appropriate type and size Battery Pack specified in this Operating Guide.



Battery Disposal — Do not dispose of the Battery Pack in a fire. The cell may explode. Check the Nickel-Cadmium Battery Disposal package insert for disposal instructions.



Damage to Battery Case — Do not open or mutilate the Battery Pack. Released electrolyte is corrosive and may cause damage to the eyes or skin. It may be toxic if swallowed.



Battery Handling — Exercise care in handling the battery in order not to short the battery with conducting materials such as rings, bracelets, and keys. The battery or conductor may overheat and cause burns.



Battery Charging — Charge the Battery Pack provided with or identified for use with this product only in accordance with the instructions and limitations specified in the instruction manual provided for this product.



Battery Polarity — Observe proper polarity orientation between the Battery Pack and battery charger.

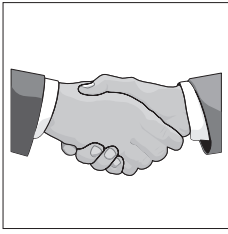

Introduction

Congratulations on the purchase of your new H/O 100/200 Home Organizer. The Cordless Home Organizer helps keep track of all your family functions with features like these:

- 900 MHz Cordless Phone
- Electronic Calendar
- Caller ID
- Speakerphone
- Dual Keypad
- Electronic Notepad
- Easy-to-Use Menu System
- Electronic Address book
- QWERTY Keyboard
- Large Flip-top LCD Screen

For assistance with set up, or any other questions regarding your H/O 100/200 , contact Uniden at 888-777-2947. Or, visit our web site at www.uniden.com

Getting Started

Unpack Your Phone

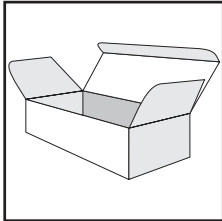

Remove all the components from the box.

Check the Contents

Your H/O 100/200 phone should contain the following items. If any of these items are missing, please contact your place of purchase.



Base Unit

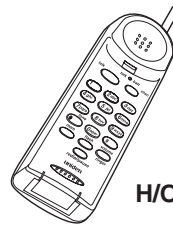

H/O 200

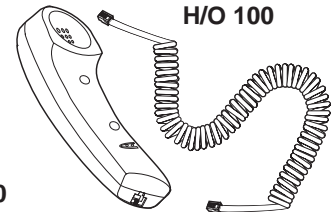

H/O 100

H/O 200 Cordless Handset
or
H/O 100 Handset and Coiled Cord

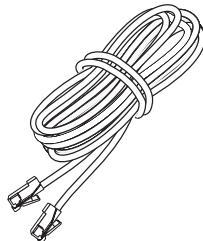

Telephone Cord

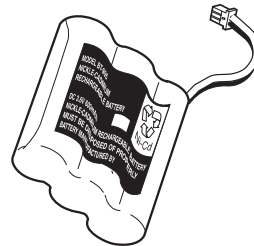

H/O 200 Handset Battery

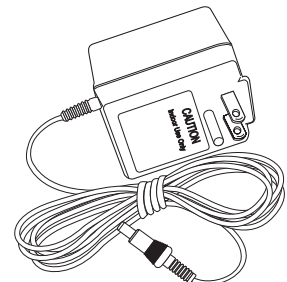

AC Adapter

- This Owner's Manual
- Other Printed Material

Preparing the Phone for Use



Use only the Uniden AC Adapter supplied with this phone.

Connect the Power

1. Plug one end of the AC Adapter into the DC 13V In jack on the back of your H/O 100/200 phone

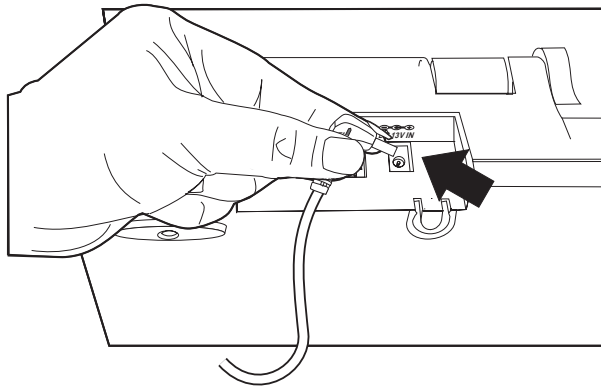

2. Wrap the power cord around the strain relief notch in the base.

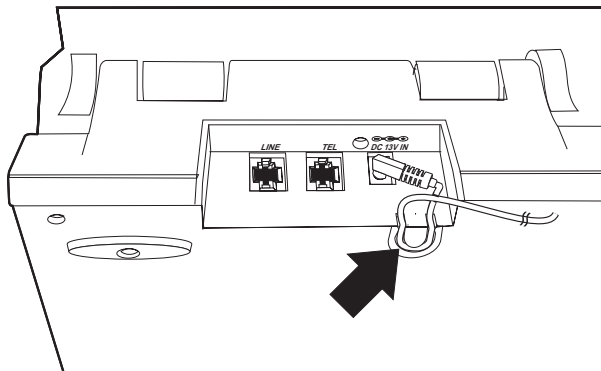

3. Plug the other end of the AC Adapter into your wall outlet.

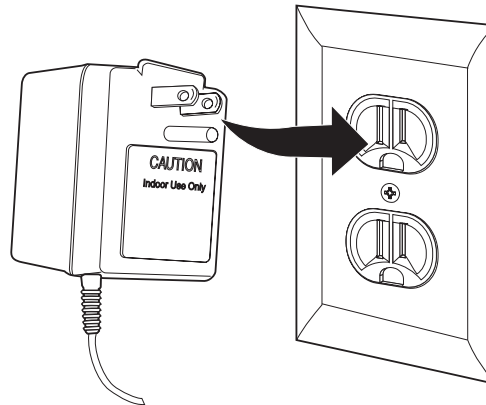

Connecting the Phone Line

1. Plug one end of the telephone cord into the **Line** Jack on the back of your H/O 100/200 phone.

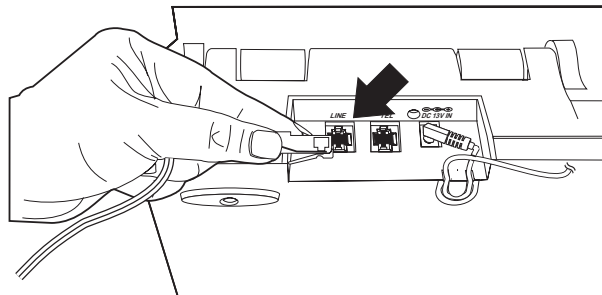

2. Plug the other end of the telephone cord into your wall jack.

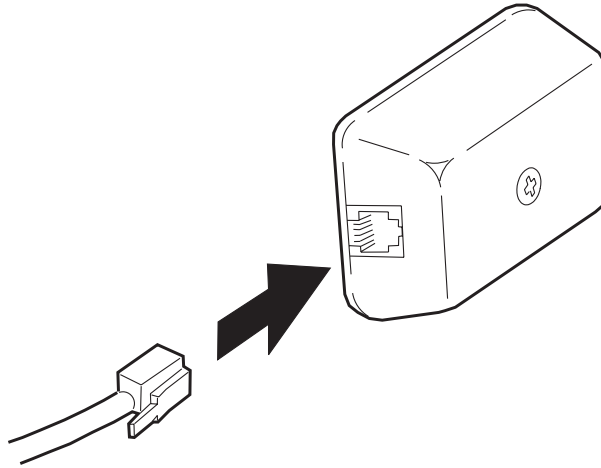

Installing Additional Equipment

You can install additional equipment, such as an answering machine or messaging system, by connecting it to the **TEL** Jack on the back of your H/O 100/200 phone.

1. Plug one end of your telephone cord into the **TEL** Jack on the back of your H/O 100/200 phone.

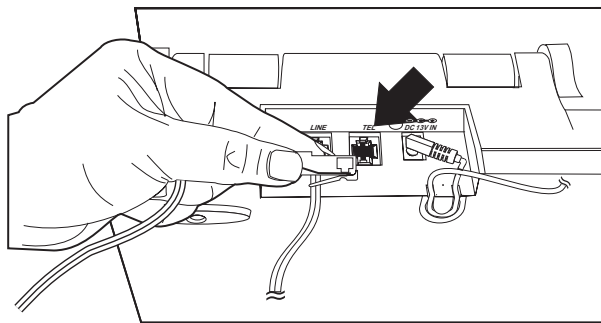

2. Plug the other end of the telephone cord into the additional device, such as an answering machine.

H/O 200 Final Touches

Raise the Antenna

Raise the antenna to the vertical position.

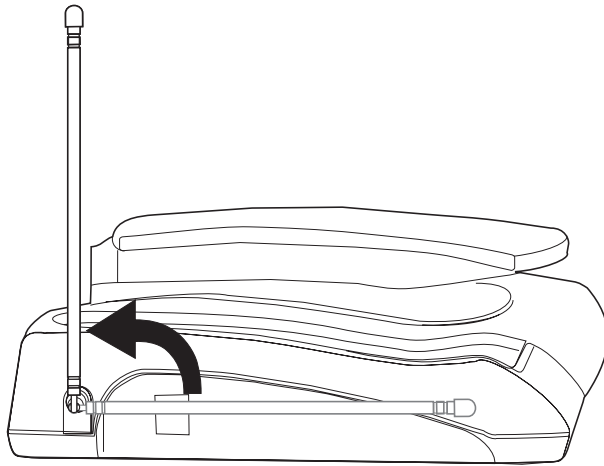

Installing the Handset Battery Pack

1. Press in on the Battery Cover Release and slide the battery compartment cover down.

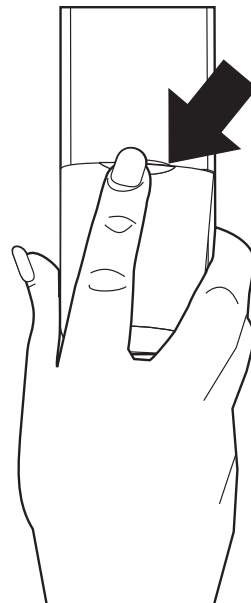

2. Align the plastic connector of the Nickel-Cadmium battery pack with its socket and plug it in.

Note: The black lead will be on the right when the plug is properly aligned.

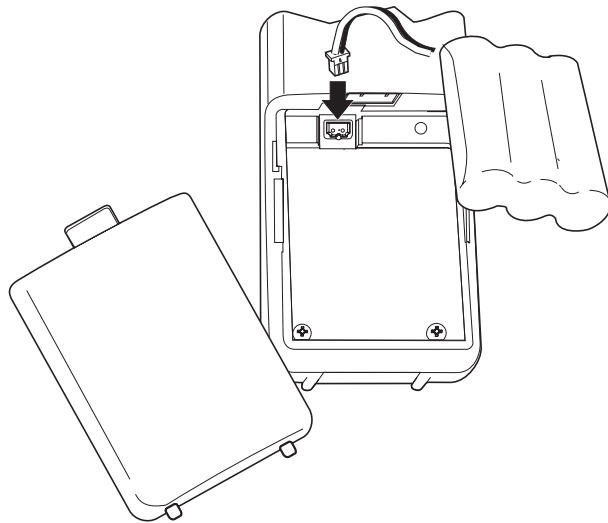

3. Place the battery pack inside the battery compartment, and slide the battery cover back on.

Note: The built-in Memory Backup feature allows up to 3 minutes to disconnect the old battery pack and install a new one without losing any numbers stored in memory. For optimum battery performance, please charge the battery overnight before using the system.

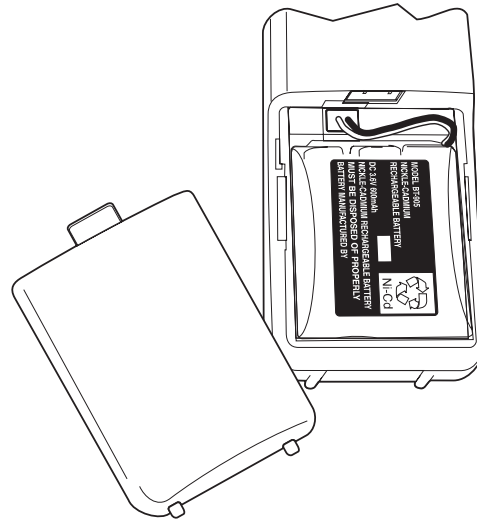



Charging the Handset

Place the handset on the base to charge. The Charge message appears on the LCD. See page 17 for details.

Note: The handset must be fully charged before the phone will operate properly. The battery included with your phone is not charged. Allow 12 to 15 hours for the Handset to charge.

During this time you can use the speaker phone to make calls.

Battery Memory Effect

Rechargeable batteries can develop a “memory” (reduced charge capacity) caused by repeated charge and discharge cycles. The battery life will seem to be shorter over time as you use the unit.

To Avoid Memory Effect

At least once a month, operate the unit until the “Battery Low” indicator appears. Avoid “topping off” the charge after using the phone for a short time. Also, do not charge the Rechargeable Battery for extended periods of time.

Low Battery Indicator

When the Battery Pack in the Handset is low and needs to be charged, the *talk/batt low* LED flashes every 3 seconds.

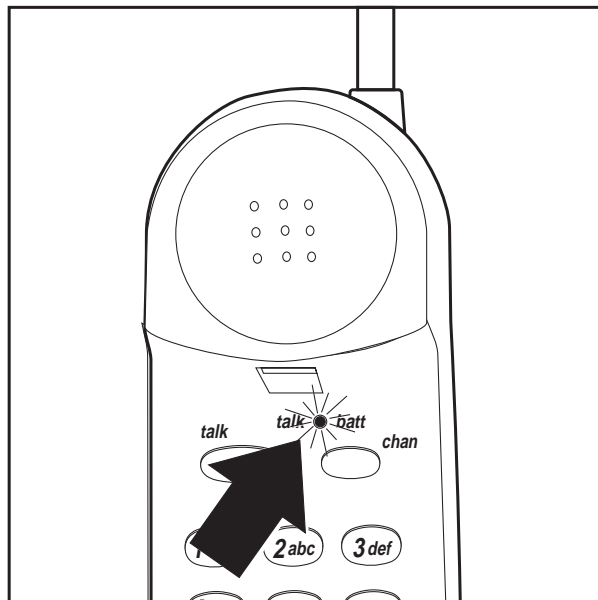

If this occurs while you are on the phone, you hear an alert tone. Complete your call as quickly as possible, and return the Handset to the Base Unit for charging.

Allow 12 to 15 hours without any interruption for the Handset to fully recharge.

Cleaning the Battery Contacts

To maintain a good charge, it is important to clean all battery contacts on the Handset and Base Unit about once a month. Use a pencil eraser or other contact cleaner. Do not use any liquids or solvents.

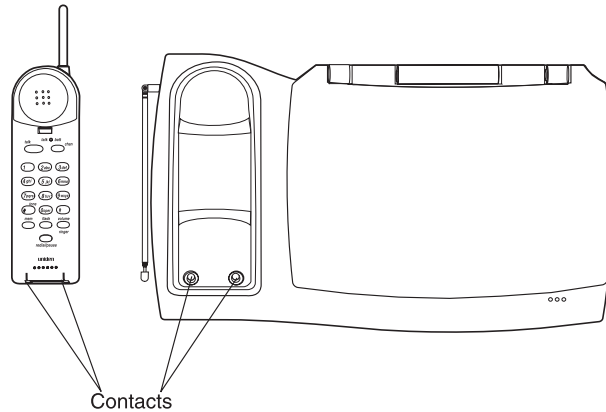

H/O 100 Final Touches

Attach the Handset

1. Plug one end of the Handset cord into the H/O 100 Handset.

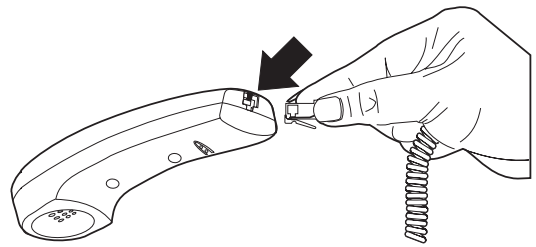

2. Plug the other end of the Handset cord into the Base.

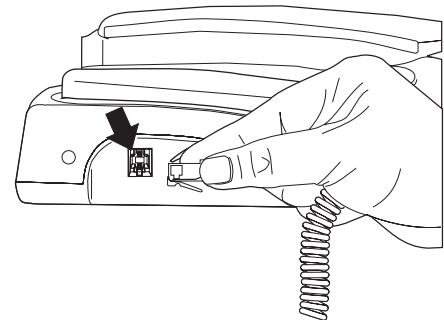

Adjust the LCD Contrast

1. Lift the LCD Panel.

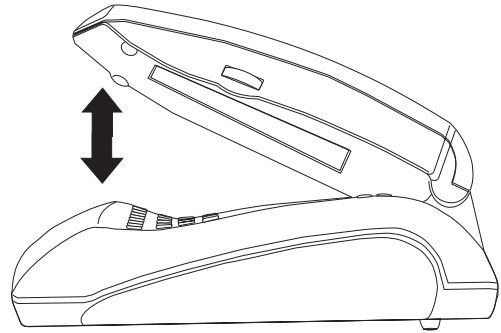

2. Move the contrast adjustment knob to change the LCD contrast.

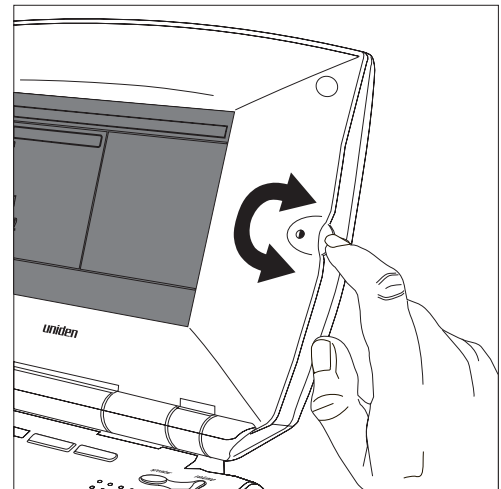

3. The LCD is properly adjusted when you can comfortably read the screen.

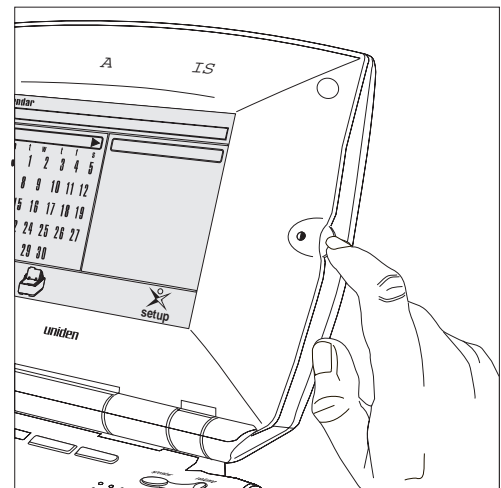

Initial Power Up

When you first turn on the Home Organizer, a diagnostic is performed. During the diagnostic, which lasts around 15 seconds, the screen will be blank.



Setup



The LCD Screen

The LCD Screen is where all of your information is displayed. A typical Home screen is shown below, and is broken down into several different sections.

The Home screen can be reached at any time by pressing the Function Key under the  icon.

Note: The LCD display could look different depending on the software in your H/O 100/200 phone.

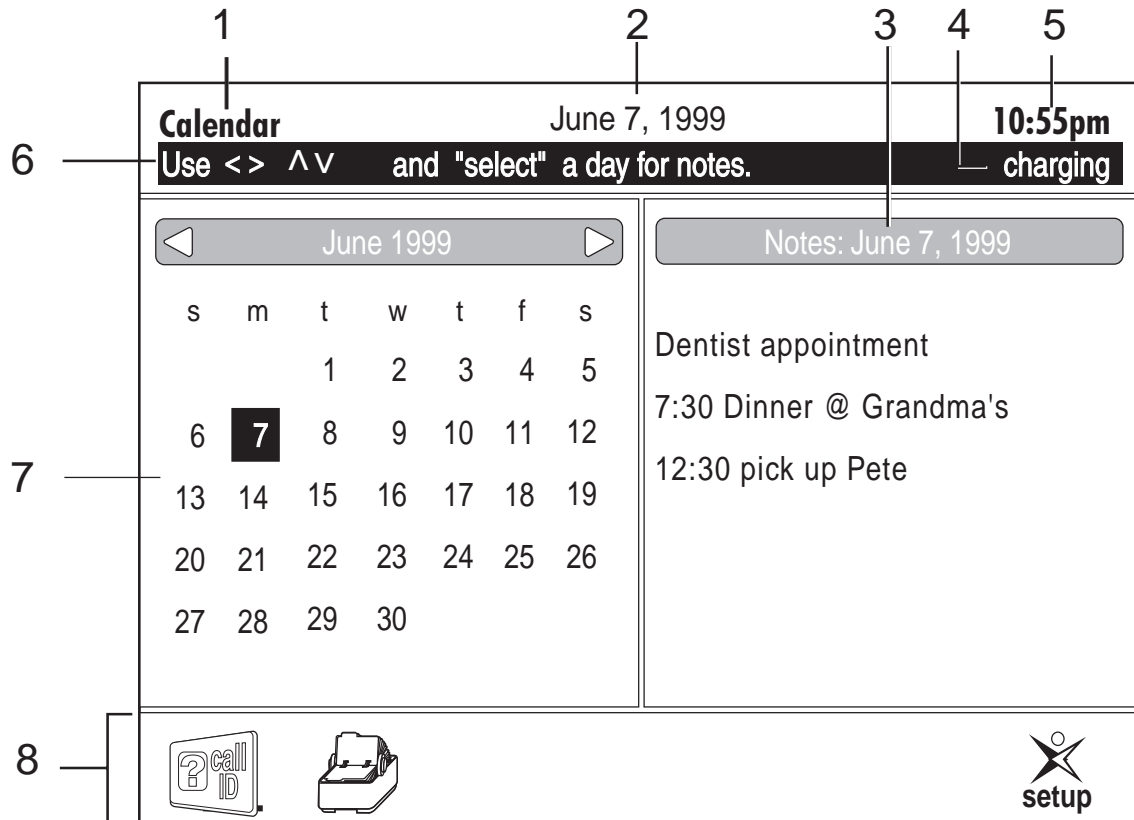

- | | | | |
|----------------------------|----------------------------|--------------------------|--------------------------|
| 1. Screen Type | Mode of operation. | 5. Time | Current time. |
| 2. Date | Current date. | 6. Status Line | Status and instructions. |
| 3. Notepad | Notes for the current day. | 7. Calendar | Current month. |
| 4. Charge Indicator | Phone is Charging | 8. Function Icons | Icons for Function Keys. |

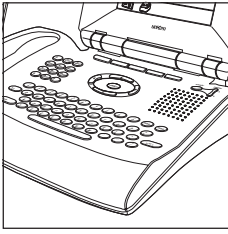

H/O 100/200 Functional Areas

Your H/O 100/200 phone is divided into several functional areas. These are:

- The Arrow and Select Keys
- The Function Keys
- The Base Unit Keypad
- The Keyboard
- The LCD Screen

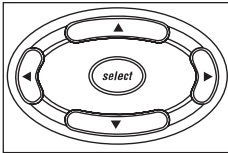

Arrow and Select Keys

These keys are used to move the cursor on the screen, or to select a feature.

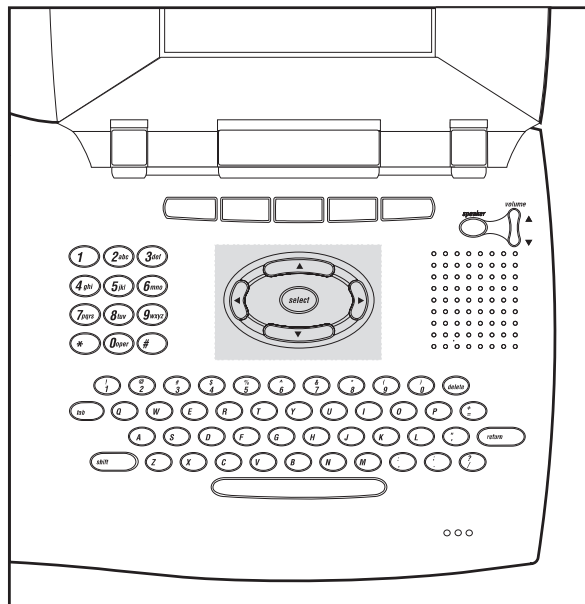

Function Keys



The Function Keys are associated with the icons on the LCD screen directly above them. To select an operation represented by an icon on the LCD screen, press the Function Key below the icon.

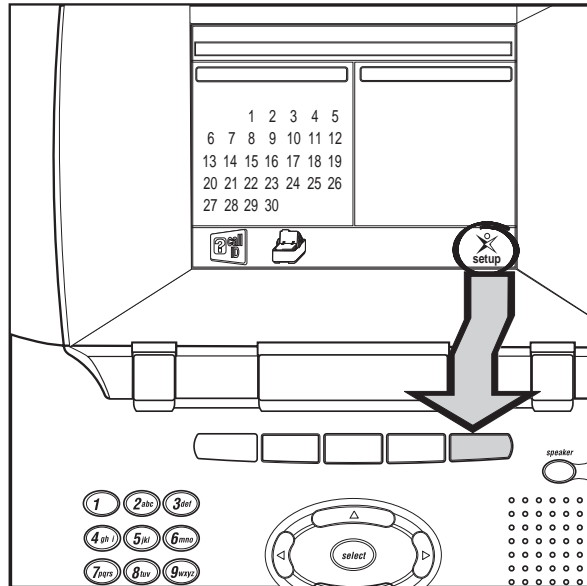
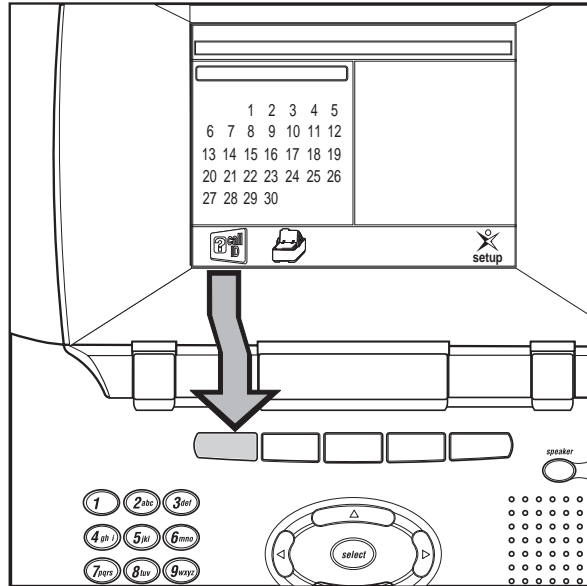



The Base Unit Keypad

The base unit keypad is used to dial phone numbers (H/O 100) and when using the speaker option (H/O 200).

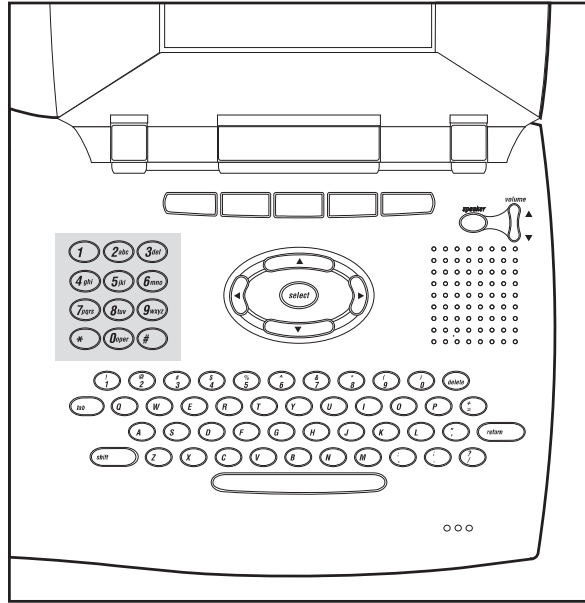

The Keyboard

Use the keyboard to type appointments, phone numbers, addresses and notes.

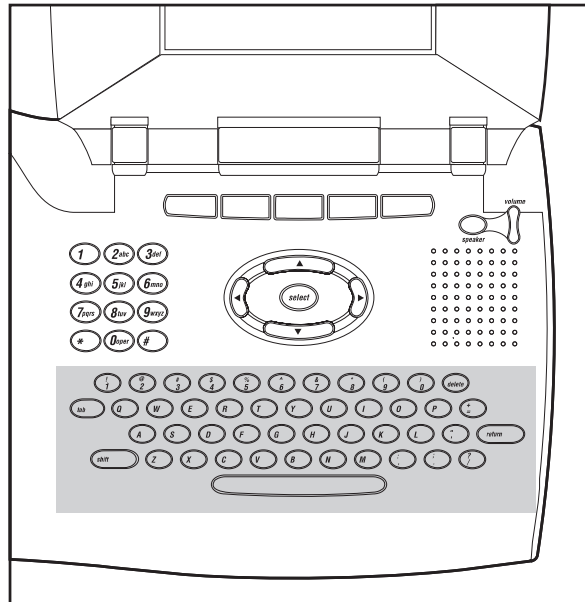
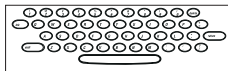

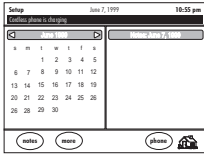

Setup Screen

1. Press the Function Key under .
2. A typical setup screen is displayed.

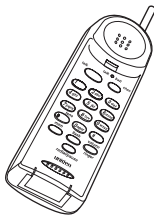
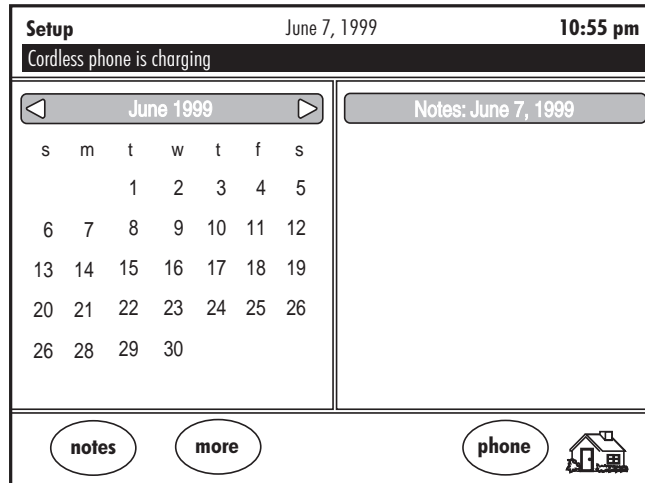

Note: The LCD display could look different depending on the software in your H/O 100/200 phone.



Setting up the Phone

This section explains how to set up the phone features of your H/O 100/200 phone. The features include setting the Speaker volume, entering your local area code and prefix, turning off the LCD screen, and paging the Handset.



Entering the Local Area Code and Prefix

1. Press the Function Key under .
2. Press the Function Key under .
3. Enter a dial prefix, if necessary, and press *return* on the keyboard. For example, enter the number 9 if you are required to dial 9 for an outside line.
4. Enter your local area code. For example, 817.
5. If your area has multiple area codes, but calling within these area codes is a local call, enter those numbers in "Local Area Codes" to keep the unit from automatically dialing the area codes
6. Press the Function Key under  to save the information.

Press the Function Key under  to cancel.

Setting the Time

Note: If you have Caller ID service from your local phone company, the time and date will be set automatically when you receive your first call.

1. Press the Function Key under  setup.
2. Press the Function Key under .
3. Press the Function Key under .

4. Use ▼ or ▲ to select the hour.

— OR —

Type the hour in with the number keys on the keyboard.

5. Press ► to move to minutes.
6. Use ▼ or ▲ to select minute.

— OR —

Type the minute in with the number keys on the keyboard.



7. Press ► to move to am/pm.
8. Use ▼ or ▲ to select am or pm.

— OR —



Type a for am, or p for pm on the keyboard.

9. Press ► on the keyboard to advance to the date.
10. Use ▼ or ▲ ◀ or ▶ to select the month.
11. Press ► to move to the day.
12. Use ▼ or ▲ to select the day.
13. Press ► to move to the year.
14. Use ▼ or ▲ to select the year.
15. Press ► on the keyboard to advance to daylight saving.
16. Use ▼ or ▲ to select daylight savings time. Selecting “yes” will enable your unit to automatically sense the change to Daylight Savings Time.
17. Use ► to move to the time zone.
18. Use ▼ or ▲ to select the time zone.

For example: Select CST/-0600 for Central Standard Time.



19. Press the Function Key under .
20. To cancel, press the Function Key under .

Setting the Ringer Level

1. From the Setup Phone Screen press  until the cursor is on Ringer Level.
2. Use the left or right arrow keys to toggle between off, low, and high.
3. Press  on the keyboard.
4. Press the Function Key under  to save the information.

Key Feedback



This option gives you the choice of turning the sound on or off when pressing the keys on the base.

1. From the Setup Phone Screen press  until the cursor is on Key Feedback.
2. Use the left or right arrow keys to toggle between on and off.
3. Press the Function Key under  to save the information.



Turn the LCD Display Off

Use this feature to turn the LCD backlight off.

Note: The LCD backlight automatically turns off after ten minutes if you are not using the H/O 100/200.

1. Press the Function Key under .
2. Press the Function Key under .
3. Press the Function Key under .





Setting the Speaker Volume

1. Press  on the Base.
2. Use the Volume Key  to adjust the speaker volume to a comfortable level.

Exiting Phone Setup

To exit the Phone Setup Screen, press the Function Key under .





Setting Up Permanent Notes

1. Press the Function Key under  **setup**.
2. Press the Function Key under .
3. Use ▼ or ▲ ◀ or ▶ to select the date.
4. Press  on the base.
5. Enter the note.
6. Press the Function Key under .

Permanent notes will be highlighted on the calendar.

Clearing Permanent Notes

Note: This clears all permanent notes on the day selected.

1. Press the Function Key under  **setup**.
2. Press the Function Key under .
3. Use ▼ or ▲ ◀ or ▶ to select the date.
4. Press the Function Key under .
5. Repeat for other dates.
6. Press the Function Key under .

Restarting the System

You can restart the H/O 100/200 phone anytime by pressing **shift + tab + del** at the same time.



Home



The Home Screen

A typical Calendar/Notepad screen is displayed below.

Note: The LCD display could look different depending on the software version in your H/O 100/200 phone.

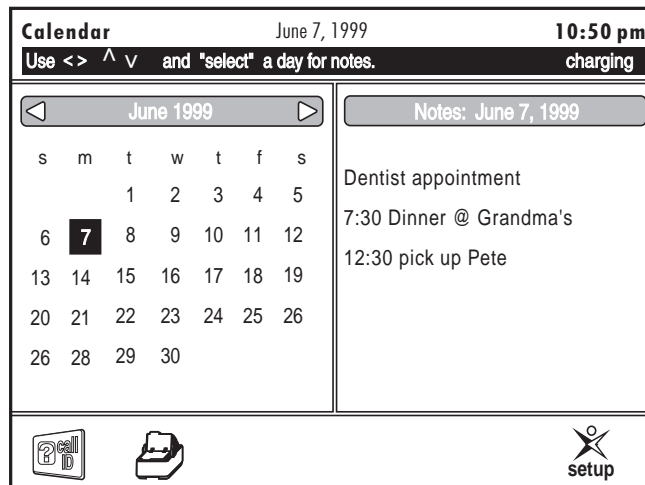



Entering notes

You can store up to seven lines of notes for each date on the calendar. Each line contains about 20 characters. The calendar changes each day and the notes for that day are automatically displayed.

Note: Temporary notes are only active for 60 days after they are entered.

1. Press ▼, ▲, ◀, or ▶ to move to the desired date on the calendar.
2. Press **select**.
3. Type in the note.
4. If you need to modify your note, press ▼, ▲, ◀, or ▶ to move through your note and modify text.
5. Press **del** on the Base to backspace and erase text.
6. Press **return** on the Base.
7. Repeat for multiple notes
8. Press the Function Key under **done** when finished.

Modifying notes

1. Press ▼, ▲, ◀, or ▶ to move to the desired date on the calendar.
2. Press .
3. Press ▼, ▲, ◀, or ▶ to move through your note and modify text.
4. Press the *del* key to backspace and erase text.
5. Press the *return* key.
6. Repeat for multiple notes
7. Press the Function Key under  when finished.

Viewing notes

1. Press ▲ to highlight the month.
2. Press ◀ or ▶ to move back and forth one month at a time and highlight the desired month.
3. Press ▼, ▲, ◀, or ▶ to move to the desired date on the calendar.

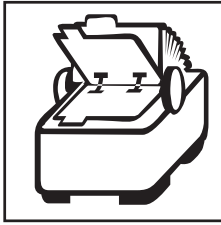

Address Book

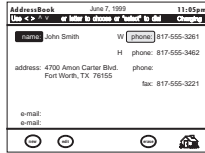

Address Book Screen

To enter the Address Book, press the Function Key under .

You can enter a maximum of 500 addresses in the Address Book. Any addresses you try to save above that number will be lost.

A typical Address Book screen is displayed below.

Note: The LCD display could look different depending on the software version in your H/O 100/200 phone.

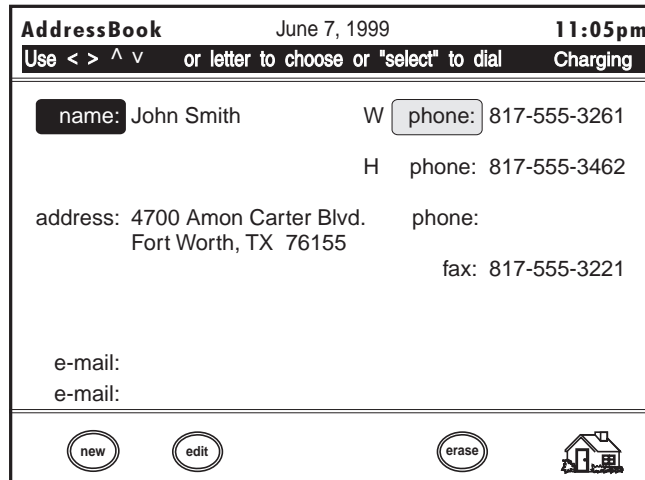

Viewing Addresses

1. Press the Function Key under .

Note: The address book will display the message "Please wait while loading address book" while the information is loaded in memory.

2. Press ▼ or ▲ to highlight the desired name.

— OR —



Enter the first letter of the Name.

3. Press ◀, ▶, or  to move to the next field.

4. Press the Function Key under  when done.

Modifying Addresses

1. Press the Function Key under .
2. Press ▼ or ▲ to highlight the desired call.

— OR —
Enter the first letter of the Name.
3. Press the Function Key under .
4. Press  on the keyboard, or use ◀ and ▶ to move to the field you want to modify.

Note: *The field in front of the phone number can be used as a reminder of what location the number belongs to. For example, you could use H for (H)ome or W for (W)ork. You can use any letter in this field.*

5. Type in the changes.

Press del on the keyboard to backspace over a mistake.
6. Press the Function Key under  when finished.
7. Press ▼ or ▲ to select another address.

— OR —
Press the Function Key under  to exit.



Deleting Addresses

1. Press the Function Key under .
2. Press ▼ or ▲ to highlight the desired call.



— OR —
Enter the first letter of the Name.
3. Press the Function Key under .
4. Press ▼ or ▲ to select another address.

— OR —
Press the Function Key under  to exit.

Entering New Addresses

1. Press the Function Key under .
2. Press the function Key under .
3. Press  on the keyboard, or use ◀ and ▶ to move to the field you want to modify.
4. Type in the changes.

Press *del* on the keyboard to backspace over a mistake.

5. Press the Function Key under  when finished.
6. Press the Function Key under  to exit.

Speed Dialing From the Address Book

1. Press the Function Key under .
2. Press ▼ or ▲ to highlight the desired entry.
3. Press ▶ to highlight the phone number.
4. Pick up handset

— OR —

Pick up the handset and press the *talk* key.

— OR —

Press  on the base.

5. Press  on the base.
6. The selected number is dialed.



Caller ID

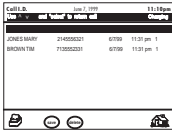





Caller ID Screen

The Caller ID icon will blink when you have new calls.

Note: You must subscribe to Caller ID service from your local phone company to use this feature.



A typical Caller ID screen is displayed below.

Note: The LCD display could look different depending on the software version in your H/O 100/200 phone.



Call I.D.		June 7, 1999		11:10pm	
Use ^ v and "select" to return call			Charging		
<hr/>					
JONES MARY	2145556321	6/7/99	11:31 pm	1	
BROWN TIM	7135552331	6/7/99	11:31 pm	1	
<hr/>					
					
1	2	3	4	5	

1. Caller's Name.
2. Caller's Number.
3. Date of last call.
4. Time of last call.
5. Number of times called.





Viewing Caller Information

1. Press the Function Key under .
2. Press ▼ or ▲ to highlight the desired call.
3. Press the Function Key under  to exit.

Deleting Caller Information



1. Press the Function Key under .
2. Press ▼ or ▲ to highlight the desired call.
3. Press the Function Key under .
- Repeat for all calls you want to delete**
4. Press the Function Key under  to exit.

Adding Caller ID Information to the Address Book

1. Press the Function Key under .
2. Press ▼ or ▲ to highlight the desired call.
3. Press the Function Key under .
4. Press the Function Key under .
- Repeat for all calls you want to add to the Address Book.**
5. Press the Function Key under  when done.

Dialing From the Caller ID Menu

Note: If the area code is the same as yours, or it's entered in "Local Area Codes," the phone will not dial the area code, only the last seven digits.

1. Press the Function Key under .
2. Press ▼ or ▲ to highlight the desired call.
3. Pick up the handset (H/O 100), or pick up the handset and press the **talk** key (H/O 200).
Press  on the base.
4. Press the Function Key under .
5. The selected number is dialed.

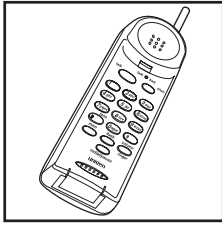

Using Your Phone

Receiving Calls

1. After the second ring Caller ID information is displayed.

To remove the window immediately, Press any key on the keyboard.

The window closes automatically after 2 minutes.

2. Pick up the Handset (H/O 100 and H/O 200).

— OR —

If the Handset is away from the base press ***talk***. (H/O 200 only)

— OR —

Press . (H/O 100 and H/O 200)

Note: All screen functions are still available during your conversation. For example, you can type a note while talking on the phone.

3. To hang up, press ***talk***, return the Handset to the Base, or press .

Making Calls

Pick up the Handset and dial the number on the base keypad.

— OR —

Pick up the Handset, press the ***talk*** key and dial the number. (H/O 200)

— OR —

Press the speaker key on the base unit and dial the number on the base keypad. (H/O 200)

Storing Memory Numbers (H/O 200)

Up to 10 numbers can be stored in the H/O 200 Handset for speed dialing when you are away from the base. **Numbers cannot be stored in the Base unit.**

Note: These numbers will not be stored in the Address Book automatically. You need to enter Address Book numbers separately.

1. Pick up the Handset and press *mem*. You will hear a beep and the *talk/batt low* LED flashes.
2. Enter the number you want to store on the Handset keypad.

Note: You may enter a delay between numbers (for accessing a switchboard, or long distance service) by pressing the redial/pause button on the Handset at the point in the number sequence you wish to pause. The redial/pause button counts as one digit. Pressing redial/pause more than once will increase the length of the pause between numbers.

3. Press *mem*. You will hear another confirmation beep.
4. Enter a number (0-9) from the Handset keypad for the memory location.

Note: After pressing mem the second time, you have 20 seconds to enter the number you wish to store. Otherwise, an error tone will sound and the unit returns to Standby.

Erasing a Stored Number (H/O 200)

1. On the Handset, press *mem* twice.
2. Enter the memory location number (0-9) you want to clear. You will hear a long beep confirming the number is erased.

Dialing Memory Numbers (H/O 200)

1. Press the *talk* key on the Handset.
2. Press the *mem* key on the Handset.
3. Enter the Memory Location Number (0-9).

Chain Dialing (H/O 200)

1. Press the *talk* key on the Handset.
2. Press the *mem* key on the Handset.
3. Enter the Memory Location Number (0-9)

4. While on call, enter the number from the Handset

— OR —

Enter the memory location number where the second number is stored.

Redialing the last Number Called (H/O 200)



1. Press *talk*.
2. Press the *redial/pause* key on the Handset.
3. The last number you called is dialed.

Using Your Phone With Call Waiting (H/O 100 and H/O 200)

Note: *You must subscribe to call waiting service from your local phone company to use this feature.*

1. While talking, you hear the call waiting signal.
2. Press *flash* on the Handset to switch to that call or press the switch-hook.
3. To switch back to your original call, press *flash* on the Handset, or press the switch-hook on the base again.

Paging the Handset (H/O 200)

1. Press the Function Key under  **setup**.
2. Press the Function Key under  **phone**.
3. Press the Function Key under  **page**.

Changing Channels (H/O 200)

Note: *If you have more than one cordless phone in your house, they must be set to different channels. This function works only when the phone is in use.*

The *channel* key on the Handset allows you to choose among 40 factory set channels. During the course of a conversation if you hear static or noise causing difficulty in hearing the other party, change channels by:

1. Pressing the *channel* key on the Handset.
2. The talk/batt low LED on the Handset will flash, indicating the H/O 200 is finding the best channel available.

Changing the Handset Ring Type and Ring Volume (H/O 200)

There are 2 ring types and two ring volumes that can be selected while your H/O 200 is in the Standby mode. Be sure the talk/batt low LED is not lit on your H/O 200 Handset.

1. Press the ***volume/ringer*** key on the Handset to change between the 2 different rings and volumes.

Changing the Handset Earpiece Volume (H/O 200)

1. While on a phone call, press the ***volume/ringer*** key on the Handset.
2. You will hear a tone indicating a decrease in the earpiece volume.
3. Press the ***volume/ringer*** key again to increase the earpiece volume to the higher level.

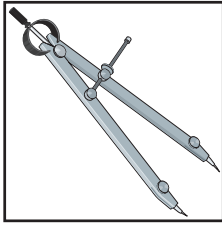

Product Specifications

General

LCD Display:	VGA-compatible with contrast adjustment.
Keyboard:	Full QWERTY keyboard.
Operating Temperature:	10° to 40° C
Storage Temperature:	-40° to 100° C
Humidity:	Up to 90% relative, without condensation

Power Requirements

Voltage:	90-130 volts AC, 55-65 Hz
----------	---------------------------

Cordless Telephone Specifications

General

Frequency Control	Phase Locked Loop
Modulation	FM
Operating Temperature	-10° - 50° C

Base Unit

Transmit Frequency:	926.000 ~ 927.950 MHz (40 Channels)
Power Requirements:	13VDC 900mA (from AC Adapter)

Handset

Transmit Frequency:	902.050 ~ 904.000 MHz (40 Channels)
---------------------	-------------------------------------

Battery

Capacity:	600 mAH 3.6V
Talk Mode:	5 hours
Standby Mode:	14 days

Specifications shown are typical and subject to change without notice.

One-Year Limited Warranty

Important: Evidence of original purchase is required for warranty service.

WARRANTOR: UNIDEN AMERICA CORPORATION (“Uniden”)

ELEMENTS OF WARRANTY: Uniden warrants, for one year, to the original retail owner, this Uniden Product to be free from defects in materials and craftsmanship with only the limitations or exclusions set out below.

WARRANTY DURATION: This warranty to the original user shall terminate and be of no further effect 12 months after the date of original retail sale. The warranty is invalid if the Product is (A) damaged or not maintained as reasonable or necessary, (B) modified, altered, or used as part of any conversion kits, subassemblies, or any configurations not sold by Uniden, (C) improperly installed, (D) serviced or repaired by someone other than an authorized Uniden service center for a defect or malfunction covered by this warranty, (E) used in any conjunction with equipment or parts or as part of any system not manufactured by Uniden, or (F) installed or programmed by anyone other than as detailed by the Operating Guide for this product.

STATEMENT OF REMEDY: In the event that the product does not conform to this warranty at any time while this warranty is in effect, warrantor will, at its option, repair or replace the defective unit and return it to you without charge for parts, service, or any other cost (except shipping and handling) incurred by warrantor or its representatives in connection with the performance of this warranty. Warrantor, at its option, may replace the defective unit with a new or refurbished unit. THE LIMITED WARRANTY SET FORTH ABOVE IS THE SOLE AND ENTIRE WARRANTY PERTAINING TO THE PRODUCT AND IS IN LIEU OF AND EXCLUDES ALL OTHER WARRANTIES OF ANY NATURE WHATSOEVER, WHETHER EXPRESS, IMPLIED OR ARISING BY OPERATION OF LAW, INCLUDING, BUT NOT LIMITED TO ANY IMPLIED WARRANTIES OF MERCHANTABILITY OR FITNESS FOR A PARTICULAR PURPOSE. THIS WARRANTY DOES NOT COVER OR PROVIDE FOR THE REIMBURSEMENT OR PAYMENT OF INCIDENTAL OR CONSEQUENTIAL DAMAGES. Some states do not allow this exclusion or limitation of incidental or consequential damages so the above limitation or exclusion may not apply to you.

LEGAL REMEDIES: This warranty gives you specific legal rights, and you may also have other rights which vary from state to state. This warranty is void outside the United States of America.

PROCEDURE FOR OBTAINING PERFORMANCE OF WARRANTY: If, after following the instructions in this Operating Guide you are certain that the Product is defective, pack the Product carefully (preferably in its original packaging). The Product should include all parts and accessories originally packaged with the Product. The Product should include all parts and accessories originally packaged with the Product. Include evidence of original purchase and a note describing the defect that has caused you to return it. The Product should be shipped freight prepaid, by traceable means to warrantor at:

Uniden America Corporation
Parts and Service Division
4700 Amon Carter Blvd.
Fort Worth, TX 76155
(800) 297-1023, 8 a.m. to 5 p.m. Central,
Monday through Friday

Covered under one or more of the following U.S. patents:

4,511,761	4,523,058	4,595,795	4,797,916	5,426,690
5,650,790	5,660,269	5,661,780	5,768,345	

uniden®

©113098 Uniden America Corporation
All Rights Reserved
Printed in the USA

Free Manuals Download Website

<http://myh66.com>

<http://usermanuals.us>

<http://www.somanuals.com>

<http://www.4manuals.cc>

<http://www.manual-lib.com>

<http://www.404manual.com>

<http://www.luxmanual.com>

<http://aubethermostatmanual.com>

Golf course search by state

<http://golfingnear.com>

Email search by domain

<http://emailbydomain.com>

Auto manuals search

<http://auto.somanuals.com>

TV manuals search

<http://tv.somanuals.com>