

Uniden®

OWNER'S MANUAL

TRU346



tru
2.4.GHZ
DIGITAL SPREAD SPECTRUM



Contents

Welcome / Features	inside front cover	Erasing a stored name and phone number	24
Controls and Functions	2, 3	Paging	25
Getting Started		Caller ID Features	
Read this first	4	Caller ID	26
Step 1: Checking the package contents	5	When the telephone rings	28
Step 2: Setting up the base unit	6	Viewing the Caller ID Message list	29
Step 3: Preparing the battery pack	9	Deleting information from the Caller ID list	30
Adjusting the speaker and earpiece volume	11	Using the Caller ID list	32
Basics		Using "Caller ID on call waiting" service	34
Making a call	12	Call Waiting features	35
Receiving a call	14	Additional Information	
Redialing a call	15	Changing the digital security code	36
Traveling out-of-range	16	Beltclip installation	37
Telephone Features		Headset installation	37
Memory dialing		Note on power sources	38
Storing phone numbers and names	17	Maintenance	38
Making calls with memory dialing	19	Troubleshooting	39
Chain dialing	20	General Information	41
Editing a stored name and/or phone number	21	Index	42

Welcome Congratulations on your purchase of the TRU 346 cordless telephone. This phone is designed for reliability, long life, and outstanding performance utilizing the latest in 2.4 GHz Spread Spectrum technology.

Note: Some illustrations in this manual may differ from the actual unit for explanation purposes.

- Features**
- 2.4 GHz Spread Spectrum Technology
 - Caller ID and Call Waiting Caller ID
 - 50 Number Caller ID Memory
 - Advanced Caller ID with Call Waiting Options
 - Lighted Keypad
 - 3-Line, 16 Character Backlit Handset Display
 - 20 Enhanced Memory Dial Locations
 - 32 Digit Redial
 - 3 Redial Memories
 - Flash
 - Pause
 - Pulse/Tone Dialing
 - Page/Find
 - 10 Day Standby Battery Life
 - 6 Hour Talk Time
 - Handset Earpiece and Ringer Volume Control
 - Hearing Aid Compatible

Digital Spread Spectrum Technology utilizes a "wider frequency band" vs. a "single narrowband".

Dom

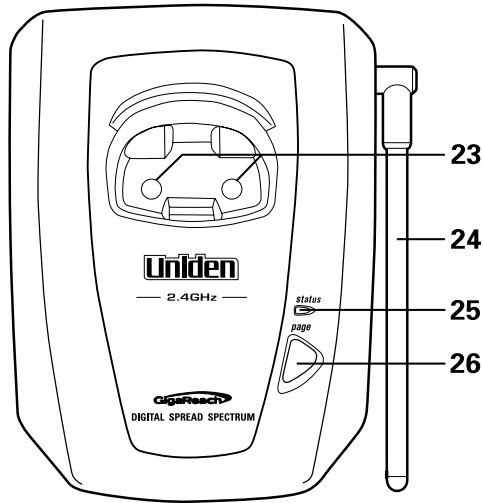
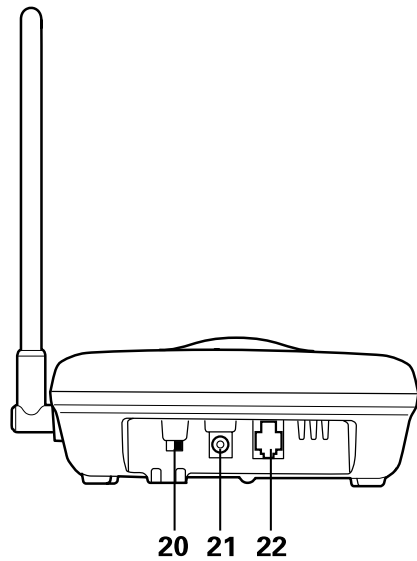

- 20. Pulse-Tone switch
- 21. DC power input
- 22. Phone jack
- 23. Base charging contacts
- 24. Base antenna
- 25. Status LED
- 26. Page key

Read This First

This cordless telephone must be set up before use. Follow these steps;

Step 1 (page 5)

Unpack and check the telephone and accessories.

Step 2 (page 6 to 8)

Next, choose the best location to set up the base unit.



Step 3 (page 9 to 10)

Then, insert the battery pack into the handset. You must charge the battery pack for **15 hours before using the phone.**

About the digital security code

This cordless telephone uses a digital security code to prevent unauthorized access to your base unit. This security code prevents other cordless handsets from making calls through your base unit. A random security code will be assigned automatically between your base unit and handset when you charge the battery pack for the first time.

If you want to reset the security code, see page 36.

Checking the Package Contents



• Base unit



• Handset

- This Owner's Manual
- Precautions and Important Safety Instructions
- Quick Reference Guide
- Registration Card

- Rechargeable battery

- AC adapter

- Telephone cord

Setting up the Base Unit

Do the following steps.

- Choose the best location
- Connect the base unit
- Choose the dialing mode

Choose the best location

Before choosing a location for your new phone, read the INSTALLATION CONSIDERATIONS included in the PRECAUTIONS AND IMPORTANT SAFETY INSTRUCTIONS brochure. Here are some important guidelines you should consider:

Avoid heat sources, such as radiators, air ducts, and sunlight

Avoid noise sources such as a window by a street with heavy traffic

Avoid television sets and other electronic equipment

Avoid microwave ovens

Avoid excessive moisture, extremely low temperatures, dust, mechanical vibration, or shock

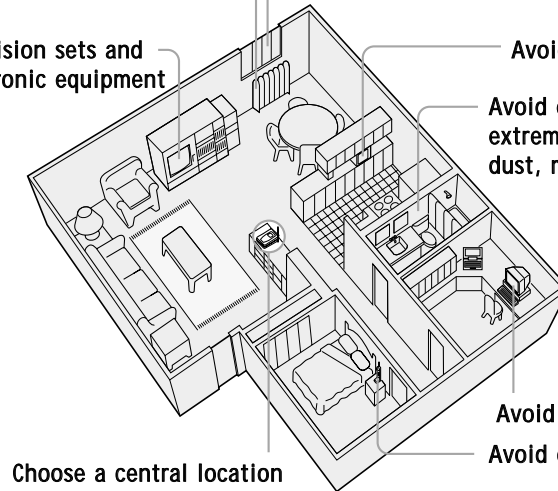





06

- Keep the motors in vertical position.
- Be sure the motors are in vertical position.

Connect the base

- 1 Connect the telephone line to the **TEL LINE** jack and to a telephone outlet.
- 2 Connect the AC adapter to the **DC IN/ON** jack and to a standard

-  Use only the supplied AD-311 AC adapter. Do not use any other AC adapter.
-  Connect the AC adapter to a continuous power supply.
-  Place the base unit close to the AC outlet so that you can unplug the AC adapter easily.
-  If your telephone outlet isn't modular,
contact your telephone company for assistance.



Choose the dialing mode

Depending on your dialing system, set the **PULSE-TONE** switch as follows:

If your dialing system is	Set the switch to
Tone	<i>TONE</i>
Pulse	<i>PULSE</i>

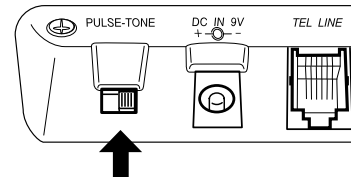

If you aren't sure of your dialing system

Make a trial call with the PULSE-TONE switch set to *TONE*.
If the call connects, leave the switch as is; otherwise, set to *PULSE*.

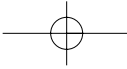

Preparing the Battery Pack

Charge the battery pack for at least 15 hours before you start using your phone.

- 1 Press in on the battery cover release and slide the cover down until it comes off.
- 2 Connect the battery pack connector with the correct polarity (black and red wires), then insert the battery pack into the battery compartment.
- 3 Securely close the battery compartment cover by sliding it up until it snaps into place.
- 4 Place the handset on the base as shown.
- 5 Make sure that the **status** LED lights. If the LED doesn't light, check to see that the AC adapter is plugged in and that the handset makes good contact with the base charging contacts.

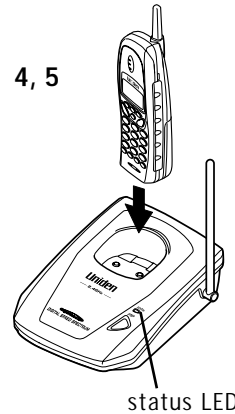
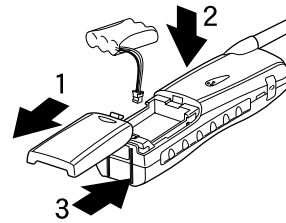

Use only the Uniden Battery (BT-905) supplied with your phone. Replacement batteries are also available through the Uniden Parts Department. (see page 5)

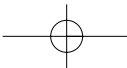

note

- Even when the battery pack is not being used, it will gradually discharge over a long period of time. For optimum performance, be sure to return the handset to the base unit after a telephone call for charging the battery.
- The redial memory numbers backup for up to 2 minutes while you replace the battery pack.
- If you must replace the battery pack during a telephone call, complete the replacement of the battery pack within 30 seconds, and you can return to the original call.

Battery use time (per charge)

From fully charged

- Six hours continuous use.
- Ten days when the handset is in the standby mode.

When the battery charge becomes low

When the battery pack is very low and needs to be charged, the phone is programmed to eliminate functions in order to save power. If the phone is not in use, "Low Battery" flashes and none of the keys will operate.

Low Battery

If the phone is in use, "Low Battery" flashes and the handset beeps. Complete your conversation as quickly as possible and return the handset to the base unit for charging.

note

The built-in memory backup can hold numbers and names stored in the memory even if the battery pack is completely discharged.

Cleaning the battery contacts

To maintain a good charge, it is important to clean the battery contacts on the handset and base unit with a dry cloth or a pencil eraser about once a month.

Do not use any liquids or solvents.

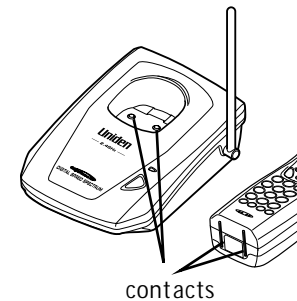

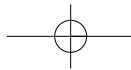

Adjusting the Ringer and Earpiece Volume

Ringer tone and volume

The phone has four ringer tone and volume combinations.
In the standby mode, press ▲ or ▼ on the handset repeatedly.
The display shows the setting.

Earpiece volume

Pressing ▲ or ▼ during a call will change the earpiece volume of the handset. This setting will remain in effect after the telephone call has ended.

<Loud> ◀▼▶ ◀▼▶ ◀▼▶ ◀▼▶ ◀▼▶
◀▲▶ ◀▲▶ ◀▲▶ ◀▲▶ ◀▲▶ ◀▲▶

When you press ▲ in Loud mode or press ▼ in Normal mode, the error tone sounds.

note

- Press **delete** if you enter a wrong number in step 1. To delete all the numbers that you have entered, press and hold **delete** until the display clears.
- You must press a key within 20 seconds or the phone will return to standby.

Making a Call Dialing from standby

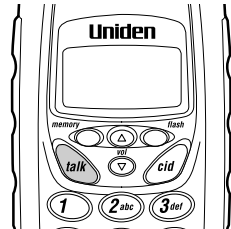

- 1 Enter the phone number.
(Up to 32 digits.)
Example: Enter 8178583300
- 2 Press **talk**.
"Talk" flashes on the display.
Then the volume setting is displayed.

Example: Volume level High
- 3 The number is dialed.
After about 5 seconds, the call-time display appears.
- 4 To hang up, press **talk** or place the handset on the base. The call-time will be displayed for about 5 seconds.

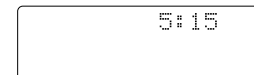
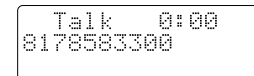
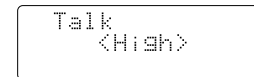
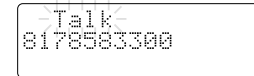
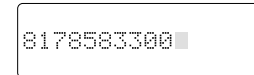

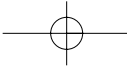

Other Operations

To	Do this
To adjust the earpiece volume	Press or during a call.
To temporarily switch to tone dial (When the base is set to pulse mode)	Press . The following numbers will be sent as tone dialing.
To enter a pause within the dialing sequence	Press . "F" appears in the display which represents a pause.
To improve the reception	Press during a call. "Scanning" appears on the display. If the operation fails, the error tone sounds.

Dialing from talk mode

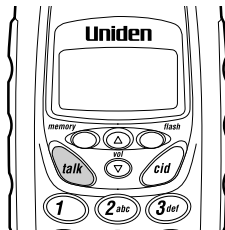

- 1 Press . "Talk" flashes on the display. Then the volume setting is displayed. Example: Volume level High
- 2 Dial the phone number. Example: Enter 8178583300
- 3 To hang up, press or place the handset on the base. The call-time will be displayed for about 5 seconds.

Talk

Talk
<High>

Talk 0:17
8178583300

10:03

Receiving a Call

From the handset

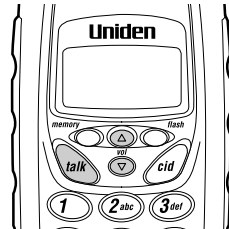

- 1 The phone rings. "Incoming call" appears on the display.
- 2 Press **(talk)**. "Talk" and volume setting appear on the display.
- 3 Talk with the caller.
- 4 To hang up, press **(talk)** or place the handset on the base.
The call time will be displayed for about 5 seconds.

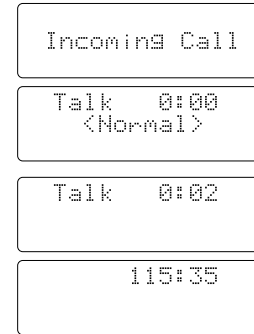

AutoTalk when ringing

When the AutoTalk setting is on and there is an incoming call, simply lift the handset from the base unit to answer the phone. See "Setting Caller ID options" on page 26 for more details.

Any key answer when ringing

When the AutoTalk setting is on and the handset is off the base, press any handset key to answer the incoming call.

Call Waiting

Note: You must subscribe to Call Waiting service to use this feature.

When a call is received during a telephone call already in progress, press **(flash)** to switch to the new call. If you also subscribe to Call Waiting on Caller ID, you will see the name and number of the caller in call waiting. (See page 34.)

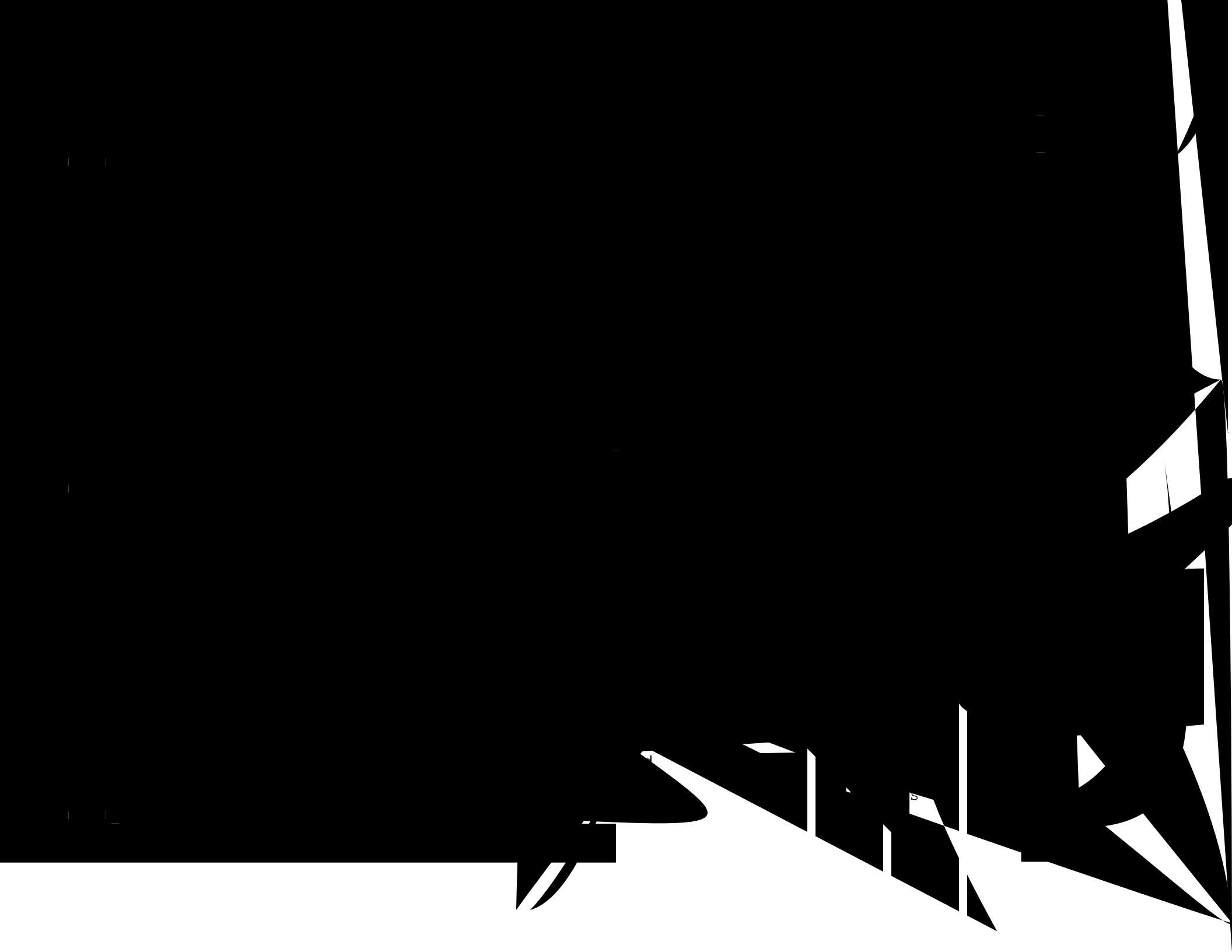

Redial from talk mode

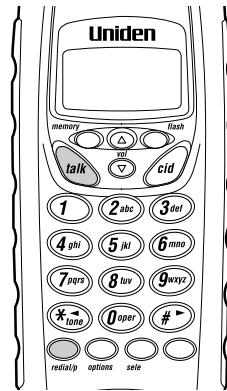

- 1 Press **talk**.
"Talk" and the volume setting appear on the display.
- 2 Press **redial/p**.
The last number dialed will be displayed and redialed.
- 3 To hang up, press **talk** or place the handset on the base. The call-time will be displayed for about 5 seconds.

Traveling Out-of-Range

Storing Phone Numbers and Names

Memory Dialing allows you to dial a number using just a few key strokes. You can store up to 20 phone numbers in the memory.

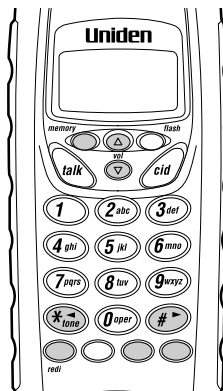

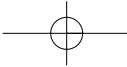

5 Press **(select/channel)**.
"Store Number" is displayed. The cursor flashes indicating that the display is ready for the number to be entered.

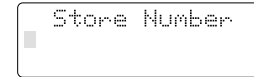

6 Use the number keypad to enter the phone number. The phone number cannot exceed 20 digits.

- Use **(redial/p)** to enter a pause in the dialing sequence. The display shows a "P". Each pause counts as one digit and represents a two second delay in time between digits.

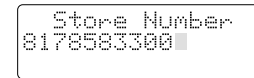

(note) The pause feature is useful for long distance calling, credit card dialing, or sequences that require a pause between digits.

- Use **(delete)** to delete digits as needed.

7 Press **(select/channel)**.
The handset beeps and displays the confirmation screen. Memory storage is complete.
For example, if you store a name and number into memory location number 07, the display shows "Memory07 Stored".
After about 2 seconds, "Memory Store" is displayed.

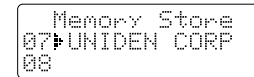
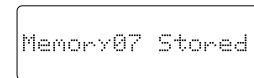

8 Press **(memory)** to return to standby mode.

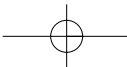
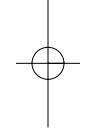
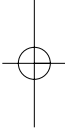

Making Calls with Memory Dialing

Memory dialing from standby

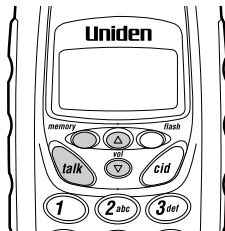

- 1 Press **memory**.
The handset displays your programmed memory locations.
- 2 Press **▲** and **▼** or enter a two-digit number (01 - 20) to select the memory location you would like to dial.
- 3 Press **talk**. "Talk" and the volume setting appear on the display. Then the displayed number is dialed.

```
01 UNIDEN CORP
02 JOHN DOE
03▶ MOM AND DAD
```

```
Talk
0123456789012
```

Display a Programmed Number

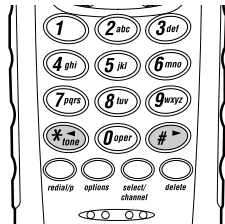

Use **#** and ***tone** to toggle between the names display and the numbers display.

Program name		Program number
01 UNIDEN CORP	⇌	01 8178583300
02 JOHN DOE		02 5452930
03▶ MOM AND DAD	⇌	03▶ 8175551212

When the stored phone number has 14 or more digits, "

Memory dialing from talk mode

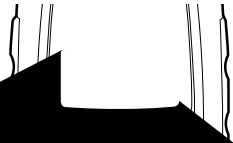

1 Press **(talk)**.
"Talk" and the volume setting appear on the display.

Press **(memory)**.

digit number (01 - 2)

memory location of the

number is displayed

and

Editing a Stored Name and/or Phone Number

- 1 Press and hold **(memory)** until "Memory Store" is displayed.
- 2 Press **(▲)** and **(▼)** or enter a two-digit number (01 - 20) to select the memory location you would like to edit.
- 3 Press **(select/channel)**.
The following screen appears with the memory location number that you have selected in the display.
- 4 Press **(▲)** or **(▼)** to select "Edit Memory", then press **(select/channel)**.
The following screen appears.
The cursor flashes indicating that the display is ready for the name to be edited. When a name has not been stored, the cursor appears at the beginning of the second line.
- 5 Press **(▲)**, **(▼)**, **(#→)**, **(*tone←)**, or **(delete)** to edit the name. (See page 17.) To edit only the phone number, skip this step.

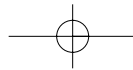

- 6 Press **(select/channel)**.
The following screens appears.
The cursor flashes indicating that the display is ready for the number to be edited.

```
Store Number
817858330
```

- 7 Use the number keypad, **(redial/p)** or **(delete)** to edit the phone number.
The phone number cannot exceed 20 digits. (See page 18.)
If you don't want to change the phone number, skip this step.

- 8 Press **(select/channel)**. The handset beeps and displays the confirmation screen. The memory storage is complete.
For example, if you store a name and number into memory location number 01, the display shows
"Memory01 Stored".
After about 2 seconds, "Memory Store" is displayed.

```
Memory01 Stored
```

```
Memory Store
01 UNIDEN CORP
02 JOHN DOE
```

- 9 Press **(memory)** to return to standby mode.

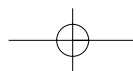
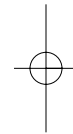
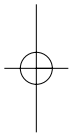

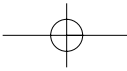

Display a Programmed Number

Use **#>** and ***tone>** to toggle between the names display and the numbers display.

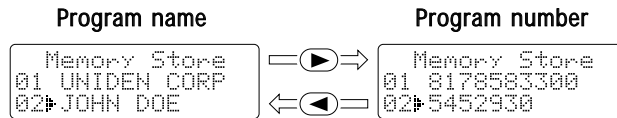

- When the stored phone number has 14 or more digits, "**➡**" is displayed next to the 12th digit. Press **#>** to see the extra digits and ***tone>** to return.

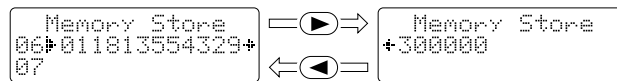

Erasing a Stored Name and Phone Number

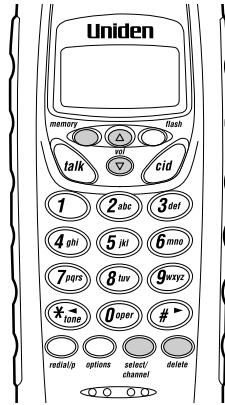

- 1 Press and hold **memory** until "Memory Store" is displayed.
- 2 Press **▲** and **▼** or enter a two-digit number (01 - 20) to select the memory location you would like to edit.
- 3 Press **select/channel**.
The following screen appears with the memory location number that you have selected in the display
- 4 Press **▼** to move the pointer down to the "Delete Memory" command line.
- 5 Press **select/channel**. The following confirmation screen appears.
- 6 Press **▲** to move the pointer to "Yes".
- 7 Press **select/channel** or **delete**.
There is a confirmation tone and the entry is deleted. The following screen appears.
- 8 After a few seconds the display returns to the "Memory Store" screen. You may select another number to delete (return to step 2) or press **memory** to return to standby.

```
Memory Store
01▶UNIDEN CORP
02 JOHN DOE
```

```
▶Edit Memory02
Delete Memory02
Go Back
```

```
Edit Memory02
▶Delete Memory02
Go Back
```

```
Delete Memory02?
Yes
▶No
```

```
Memory02 Deleted
```

```
Memory Store
02▶
03 MOM AND DAD
```

Paging

To locate the handset

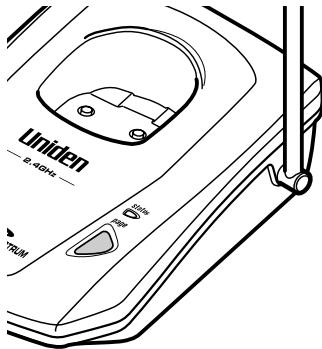

- 1 Press **page** on the base.
- 2 The handset beeps for 5 seconds. The following screen appears;
- 3 Press any key except **talk** on the handset to end the page.

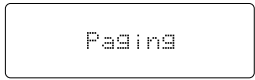

By holding **page** for more than 2 seconds, the handset beeps for 60 seconds.



When an incoming call is received during paging, paging is canceled and the telephone is switched to the incoming call.



If you press **talk** during paging, the handset will be placed in off-hook (talk) mode.



You must subscribe to Caller ID on Call Waiting in order to use this feature.

Caller ID

You must subscribe to Caller ID service to use this feature.

When the telephone rings, the Caller ID feature allows you to view the caller's name and phone number on the display before you answer the phone. The handset displays the phone number of the incoming call, the name, time, and the number of calls. Additionally, you can dial the displayed number and store the information for memory dialing.

Setting Caller ID options

There are three Caller ID setup options available; they are AutoTalk, CIDCW (Caller ID on Call Waiting), and Area Code.

AutoTalk allows you to answer the phone without pressing **(talk)**. If the phone rings when AutoTalk is on, simply remove the handset from the base and the phone automatically answers the call. Or, if the handset is not on the base, press any key to answer the call. If the phone rings when AutoTalk is off, you must press **(talk)** to answer the call.

Caller ID on Call Waiting (CIDCW) performs the same as regular Caller ID on a call waiting number. Call Waiting options allow you to handle call waiting calls in seven different ways. (See page 35.)

If you enter a 3-digit area code number in the **Area Code** option, your local area code does not appear in Caller ID messages. When reviewing Caller ID messages, you will see only the local seven digit number. For calls received from outside your local area code, you will see a full 10-digit number.



If your calling area requires 10-digit dialing, do not program this option.

To change your Caller ID options:

- 1 Press **options**. The following screen appears.

```
1 Auto Talk:Off
2 CIDCW :On
3 Area Code:
```

- 2 Use **▲**, **▼**, or a number key (1-3) to move the pointer to the selection that you would like to change.

Press **select/channel** to toggle between "On" and "Off" for "Auto Talk". For "CIDCW", choose "On", "Off", or "Opt", depending upon the type of service to which you subscribe.

- 3 When you wish to enter Area Code, press **▼** or the number key **3** to move the pointer to select "Area Code". Then press **select/channel** and enter the 3 digits area code by using the number keypad **0-9**. After entering the area code, press **select/channel**.
- 4 After you have made your selections, press **options** and return the handset to the base.

note

- If you answer a call before the Caller ID message is received (Example: before the second ring), the Caller ID message will not appear.
- When the call is received via a telephone company that does not offer Caller ID service, the caller's phone number and name do not appear. (This includes international calls.)
- When the call is via a private branch exchange (PBX), the caller's phone number and name may not appear.

When the Telephone Rings

- 1 When the Caller ID message is received, the display shows the caller's phone number along with the date and time. The incoming call information is stored in the Caller ID record.
If the Caller ID service includes the caller's name, the caller's name appears on the display (up to 15 letters).

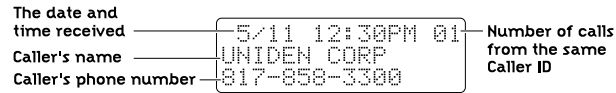

Here are some typical displays;

When the phone number and name data are received

```

5/11 12:30PM 01
UNIDEN CORP
817-858-3300
  
```

When a private name is received

```

5/11 12:30PM 01
Private Name
817-858-3300
  
```

When an unknown name is received

```

5/11 12:30PM 01
Unknown Name
817-858-3300
  
```

When invalid data is received

```

Incomplete Data
  
```

When a private number is received

```

5/11 12:30PM 01
UNIDEN CORP
Private Number
  
```

When an unknown number is received

```

5/11 12:30PM 01
UNIDEN CORP
Unknown Number
  
```

- 2 When you pick up the phone, the display changes to "Talk". (See page 14.)

note

Data errors appear as " ■ ■ " .

```

5/11 12:30PM 01
UNI ■ EN CORP
813-8 ■ ■ -3300
  
```

Viewing the Caller ID Message List

The Caller ID list stores information for up to 50 incoming calls - even unanswered calls.

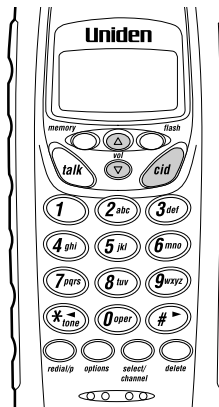

- 1 Press **cid** .
The summary screen appears.
The screen shows the number of new messages and total messages.
- 2 Press **▼** to display the latest Caller ID message.
- 3 Press **▼** to see the next message, or press **▲** to see previous message.
- 4 Press **cid** to return to standby.

```
New :01
Total:02
```

```
5/17 12:30PM 03
UNIDEN CORP
817-858-3300
```



- In Caller ID operation, if no key is pressed for more than 20 seconds, an error tone sounds and the telephone returns to the standby mode.
- If a call comes in via a telephone system that does not offer Caller ID service, no information is stored.
- "End" appears when you have reviewed all messages in the Caller ID list. Press **▲** repeatedly to return to the summary screen.
- Each message can be up to 15 characters for the phone number and the name.



If you get an incoming call or page, the deleting operation is canceled. The telephone returns to standby so you can answer the call or page.

Deleting Information from the Caller ID List

The TRU 346 stores up to 50 messages. If the phone receives the 51st message, the oldest one in the list is automatically deleted. Caller ID data can also be deleted manually.

Deleting a Caller ID message



- 1 Press **cid** .
Display the message to be deleted from the Caller ID list by pressing **▲** or **▼** .
- 2 Press **delete** .
- 3 Press **▲** or **▼** to select "Yes" or "No" .
- 4 Press **select/channel** or **delete** .

```
5/17 12:38PM 03
UNIDEN CORP
817-858-3300
```

```
Delete Message?
Yes
No
```

When the pointer is at "Yes" :

A tone sounds and the Caller ID message is deleted. The next Caller ID message is then displayed.

When the pointer is at "No" :

The display returns to the Caller ID display.

Deleting all Caller ID names/numbers

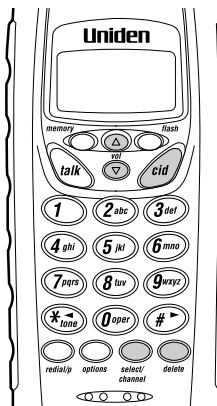

- 1 Press **cid** .
- 2 Press **delete** .
- 3 Press **▲** or **▼** to select "Yes" or "No" .
- 4 Press **select/channel** or **delete** .

When the pointer is at "Yes" :
A tone sounds and all stored Caller ID messages are deleted.

When the pointer is at "No" :
The display returns to the summary screen.

```
New :01
Total:02
```

```
Delete All?
Yes
No
```

```
Total:00
```

```
New :01
Total:02
```



If you get an incoming call or page, the deleting operation is canceled and the telephone returns to standby so you can answer the call or page.

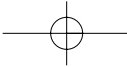

Storing Caller ID messages in Memory dialing

The phone number of the party on the Caller ID list can be stored in memory dialing.

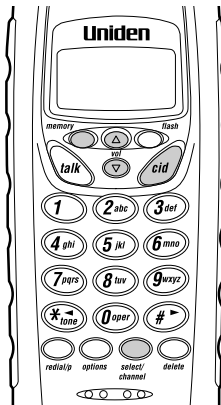

- 1 Press **cid**.
Select the phone number to be stored from the Caller ID list by pressing **▲** or **▼**.
- 2 Press **memory**.
- 3 Press **▲** and **▼** or enter a two-digit number (01 - 20) to select the memory location.
- 4 Press **select/channel**.
A confirmation tone will sound.
The number is stored in memory, and the display returns to the Caller ID list.

```
5/17 12:30PM 03
UNIDEN CORP
817-858-3300
```

```
Select Location
01 UNIDEN CORP
02 JONE DOE
```

```
5/17 12:30PM 03
UNIDEN CORP
817-858-3300
```



- You can not store a Caller ID message if no phone number appears in the message.
- If there is an incoming call or page, memory storage is canceled and the telephone is set to receive the incoming call or page.

Long Distance call and Area Code setting

When you need to store Long Distance call prefix "1" and area code, edit the number at step 1. Press **1** for Long Distance call and **3** for area code setting.



If a message has already been stored in the selected memory number location, a confirmation screen is displayed. Press **▲** to select "Yes". Press **select/channel** to overwrite. The display returns to the Caller ID list.

```
Replace Memory?
Yes
No
```

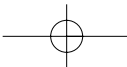
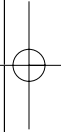
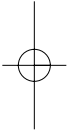

Using

“Caller
Call Wa
You m
you ca
used ir



1 Waiting Service

parate services. CIDCW (Caller ID on
gular Caller ID on a call waiting number.
on call waiting (CIDCW) services” before
he “Call waiting” service can also be
our local telephone company for details.

ing call is received
t telephone call, the
l the name of the caller

o talk with the
first caller will be put

rst caller,

the Caller ID setup menu (see page 27),
after receiving a call waiting call and
the new call. Choose an option using the
ct/channel to activate.

Call Waiting Features

Your TRU 346 gives you new options for call waiting. At the touch of a button, you can ask the caller to hold, send them to your voice mail service, or conference them into your current call. You may be required to subscribe to a voice mail service, call waiting, and call waiting options to use these features. Not all features are available in all areas. Check with your local telephone company for details.

Selecting an Option

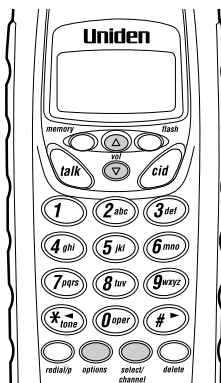

- 1 When you receive a call waiting call, press **options** for a list of options.
- 2 Press **▲** and **▼** keys or a number key (1-7) to select an option.
- 3 Press **select/channel** .
A confirmation screen will appear.

```

1 Ask to Hold
2 Tell Busy
3 Take Message
  
```



You can also answer a call waiting call immediately by pressing the **flash** key. The first caller will be placed on hold. To return to the original caller, press **flash** again.

Your TRU 346 is pre-programmed with seven call waiting options. You may select to ask the calling party to **hold**, send them a **busy** message, **forward** them to your voice mail service or **conference** them into the current call. You may also select to **answer and drop** the first caller or, at any time, choose to **drop the first** or **drop the last** caller.

Check with your local telephone company for a full list of options.



If the handset battery pack is completely discharged or the battery pack is removed, the digital security code will be lost. If this happens, a new security code is set automatically next time the battery pack is charged.

Changing the Digital Security Code

The digital security code is an identification code used to connect the handset and the base unit. Normally, setting the code is not necessary. The first time you charge your handset, the security code is automatically set. (See page 4.)

In the rare situation that you suspect another cordless telephone is using the same security code, you can change the code.

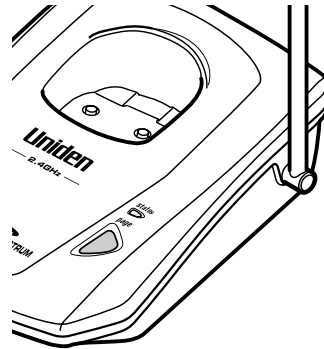

- 1 Remove the handset from the base unit. Press and hold **page**.
- 2 While the handset is emitting the paging sound, replace the handset on the base unit. The paging tone stops. Leave the handset on the base for more than 3 seconds. A random, new security code is set.

Beltclip Installation

To attach the beltclip

Insert the beltclip into the holes on each side of the handset. Press down until it clicks.

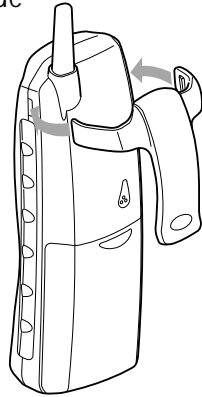

To remove the beltclip

Pull both sides of the beltclip to release the tabs from the holes.

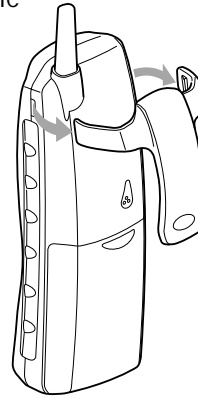

Headset Installation

Your phone may be used with an optional headset, the Uniden HS910. To use this feature, simply plug the headset plug into the headset jack. Your phone is ready for hands-free conversation. (Headsets may be purchased by calling the Uniden Parts Department or visiting the website. See page 5)

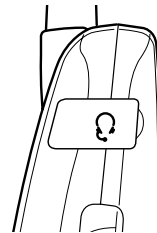

Note on Power Sources

Battery replacement and handling

When the operating time becomes short, even after a battery is recharged, please replace the battery.

With normal usage, your battery should last about one year.

Please contact your place of purchase or the Uniden Parts Department for a replacement battery. (See page 5)

RECYCLING NICKEL-CADMIUM BATTERIES

Nickel-cadmium cells are used in the battery pack. Please take your used nickel-cadmium battery packs to a store that recycles nickel-cadmium batteries.

Troubleshooting

If your phone is not performing to your expectations, please try these simple steps first.

Symptom	Suggestion
The <i>status</i> LED won't light when the handset is placed in the base unit.	<ul style="list-style-type: none"> • Make sure the AC adapter is plugged into the base unit and wall outlet. • Make sure the handset is properly seated in the base unit. • Make sure the charging contacts on the handset and base unit are clean.
The audio sounds weak and/or scratchy.	<ul style="list-style-type: none"> • Press <i>(select/channel)</i> during a call to help eliminate background noise. • Make sure that the base unit antenna is in a vertical position. • Move the handset and or base unit to a different location away from metal objects or appliances and try again. • Make sure that you are not too far from the base.
Can't make or receive calls.	<ul style="list-style-type: none"> • Check both ends of the base unit telephone line cord. • Make sure the AC adapter is plugged into the base unit and wall outlet. • Disconnect the AC adapter for a few minutes, then reconnect it. • Reset the digital security code (See page 36). • Make sure <i>(talk)</i> is pressed.

Symptom	Suggestion
The handset doesn't ring or receive a page.	<ul style="list-style-type: none"> • The battery pack may be weak. Charge the battery on the base unit for more than 15 hours. • The handset may be too far away from the base unit. • Place the base unit away from appliances or metal objects. • Reset the digital security code (See page 36).
The Caller ID does not display.	<ul style="list-style-type: none"> • The handset was picked up before the second ring. • The call was placed through a switch board. • Call your local telephone company to verify your Caller ID service is current.
Severe noise interference.	<ul style="list-style-type: none"> • Keep the handset away from microwave ovens, computers, remote control toys, wireless microphones, alarm systems, intercoms, room monitors, fluorescent lights, and electrical appliances. • Move to another location or turn off the source of interference.

General Information

The TRU 346 complies with FCC Parts 15 and 68.

Operating Temperature: -10 °C to +50 °C (+14°F to +122 °F)

AC Adapter Information

AC Adapter part number: AD-311

Input Voltage: 120V AC 60Hz

Output Voltage: 9V DC 210 mA

Battery Information

Battery part number: BT-905

Capacity: 600 mAH, 3.6V

Battery Use Time (per charge)

From fully charged:

Talk Mode duration 6 hours

Standby Mode duration 10 days



If the handset is left off of the base, the actual Talk mode duration will be reduced respective to the amount of time the handset is off the base.

Recharge your phone on a regular basis about once a week by placing the handset on the base for 15 hours. When the operating time becomes short, even after the battery is recharged, please replace the battery. With normal usage, the battery should last about one year.

Replacement batteries may be purchased at your local Uniden dealer or by contacting the Uniden Parts Department (800) 554-3988. Hours are from 7:00 a.m. to 5:00 p.m. Central Time, Monday through Friday. We can also be reached on the web at www.uniden.com

Specifications, features, and availability of optional accessories are all subject to change without prior notice.

Index

A	
Adjusting ringer and earpiece volume	11
B	
Battery pack	
Preparing and charging	9
Replacement and handling	38
Beltclip installation.....	37
C	
Caller ID	
Caller ID service	26
Call Waiting.....	34
Deleting	30
Setting Caller ID options	26
Using.....	32
Viewing	29
Connection	7
D	
Dialing mode	8
Digital security code	4,36
E, F, G	
Earpiece volume	11
H, I, J, K, L	
Headset installation	37
M, N, O	
Maintenance	38
Making a call	12
Memory dialing	
Making calls with memory dialing.....	19
Erasing a stored name and phone number	24
Storing phone numbers and names	17
P, Q	
Package contents	5
Paging	25
R	
Receiving a call	14
Redialing a call	15
Ringer tone and volume	11
S	
Setting up the Base unit	6
Setting up the Handset	9
T, U, V, W, X, Y, Z	
Troubleshooting	39

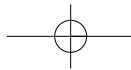

At Uniden, we'll take care of you!

If you need any assistance with this product, please call our Customer Hotline at

1-800-297-1023

PLEASE DO NOT RETURN THIS PRODUCT TO THE PLACE OF PURCHASE.

Our Uniden representatives will be happy to help you with any matters regarding the operation of this unit, available accessories, or any other related matters.

Thank you for purchasing a Uniden product.
Hours: M-F 7:00 AM to 7:00 PM CST.

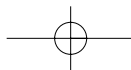
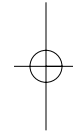
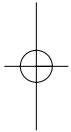

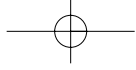

Memo

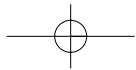
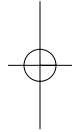
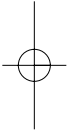

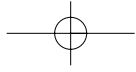

Memo

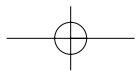
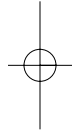
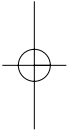

THANK YOU FOR PURCHASING A UNIDEN CORDLESS PHONE

A World Without Wires | **Uniden**[®]

Covered under one or more of the following U.S. patents:

4,511,761	4,523,058	4,595,795	4,797,916	5,381,460	5,426,690
5,434,905	5,491,745	5,533,010	5,574,727	5,650,790	5,660,269
5,661,780	5,663,981	5,671,248	5,717,312	5,754,407	5,768,345
5,787,356	5,838,721	5,864,619	5,893,034	5,912,968	5,915,227
5,929,598	5,930,720	5,960,358	5,987,330		

© 2000 Uniden America Corporation, Fort Worth, TX
All rights reserved.

Printed in China
UCZZ01716BZ

Free Manuals Download Website

<http://myh66.com>

<http://usermanuals.us>

<http://www.somanuals.com>

<http://www.4manuals.cc>

<http://www.manual-lib.com>

<http://www.404manual.com>

<http://www.luxmanual.com>

<http://aubethermostatmanual.com>

Golf course search by state

<http://golfingnear.com>

Email search by domain

<http://emailbydomain.com>

Auto manuals search

<http://auto.somanuals.com>

TV manuals search

<http://tv.somanuals.com>