

HH940

VHF Marine Radio

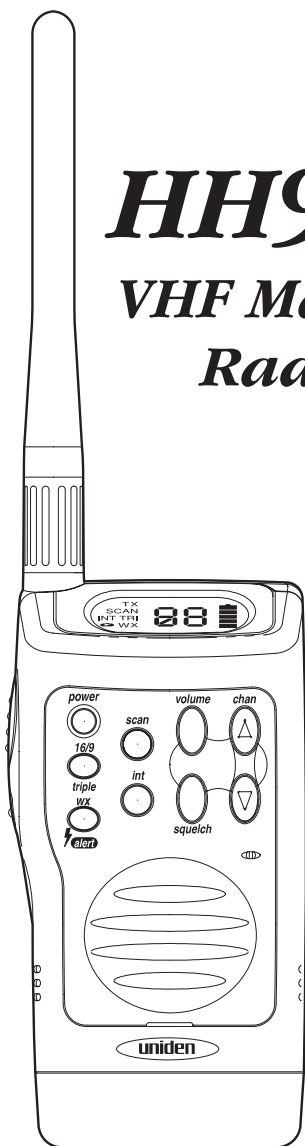

Operating Guide

UTZZ01865ZZ

CONTENTS

Controls and Indicators. . . .	Foldout
Introduction	2
Features	2
Technical Support and Service	2
Maritime Radio Services Operation	3
Included with Your HH940	4
Getting Started	5
Mounting the Drop-in Charger	5
Attaching the Antenna	5
Attaching the Battery Pack	6
Charging the Battery Pack	6
Operation	8
Setting the Squelch.	8
Selecting a Channel.	10
One-touch Channel 16/9	10
All-channel Scan	10
Monitoring Weather Channels.	11
Triple Watch	12
Weather Alert	12
International-USA Channels	13
Transmitting	13
Lighted Keys and Display	13
Key Lock.	13
Marine Channels - USA	14
Marine Channels - International	15
Parts and Accessories.	16
Specifications	17

Controls and Indicators

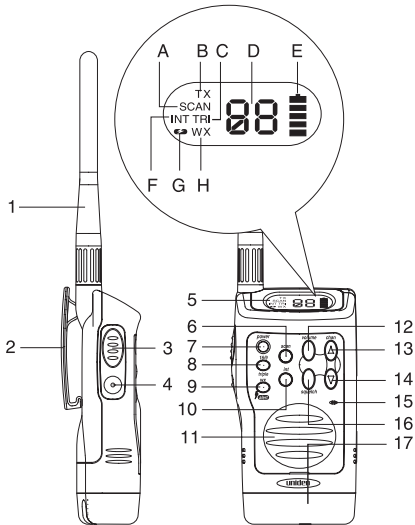

- | | | | |
|----|---|----|------------------------------|
| 1 | Antenna | 14 | Channel Down button ▼ |
| 2 | Belt Clip | 15 | Microphone |
| 3 | PTT (Push to Talk) Key | 16 | Squelch button sqelch |
| 4 | Light/Lock Key | 17 | Battery |
| 5 | LCD Display | A | Scan Indicator |
| 6 | Scan button scan | B | Transmit Indicator |
| 7 | Power button power | C | Triple Watch Indicator |
| 8 | 16/9 - Triple Watch button 16/9/triple | D | Channel Number Display |
| 9 | WX Mode/Weather Alert button wx | E | Strength Meter |
| 10 | USA/International button int | F | International Indicator |
| 11 | Speaker | G | Weather Alert Indicator |
| 12 | Volume button volume | H | Weather Mode Indicator |
| 13 | Channel Up button ▲ | | |

Warning!

- ☞ The HH940 is waterproof only when both the antenna and the battery are properly attached.
- ☞ Do not operate the transmitter of any radio equipment unless all the Radio Frequency (RF) connectors are secure and any open connectors are properly terminated.
- ☞ Do not operate the transmitter of any radio equipment near electrical blasting caps or in an explosive atmosphere.
- ☞ Do not let children operate any transmitter-equipped radio equipment.
- ☞ Have your radio equipment serviced by a qualified technician.
- ☞ Do not operate the transmitter of any radio equipment with the antenna touching or close to the eyes, face, or exposed body parts.

Rechargeable Nickel-Cadmium Battery Warning

- ☞ This equipment contains a Nickel-Cadmium Battery Pack.
- ☞ Cadmium is a chemical known to the State of California to cause cancer.
- ☞ The Nickel-Cadmium Battery Pack contained in this equipment may explode if disposed of in a fire.
- ☞ Do not short-circuit the Battery Pack.
- ☞ Do not charge the Nickel-Cadmium Battery Pack used in this equipment in any charger other than the one designed to charge this Battery Pack. Using another charger may damage the Battery Pack or cause the Battery Pack to explode.

Introduction

The HH940 is a waterproof, portable two-way VHF transceiver. It is compact, lightweight, and rugged and fits easily in your hand. This hand-held VHF marine radio will give you consistent, outstanding performance in virtually all conditions and situations.

To ensure that you get the most from the HH940's features, please read this operating guide carefully before using the unit.

Features

- Waterproof
- Triple Watch Mode
- Priority channel startup
- One-touch channel 16/9
- 10 Weather Channels
- Weather alert
- All-channel scan
- International-USA channels
- Table-top drop-in charger (can also be wall-mounted)
- Rechargeable nickel-cadmium battery pack
- Key lock
- Back-lit display
- Belt clip
- Wrist strap

Technical Support and Service

Your Uniden dealer can provide you with technical assistance and information. If your marine radio does not perform properly, take it to a Uniden dealer for servicing. The radio contains no user-serviceable parts.

Unauthorized adjustment will void the warranty and may cause illegal radio operation. Be sure that a qualified technician services your radio equipment.

Caution: Changes or modifications to this product not expressly approved by Uniden, or operation of this product in any way other than as detailed by this Operating Guide, can void your authority to operate this product.
--

Maritime Radio Services Operation

WARNING!

This transmitter will operate on channels/frequencies that have restricted use in the United States. The channel assignments include frequencies assigned for exclusive use of the U.S. Coast Guard, use in Canada, and use in international waters. Operation in these frequencies without proper authorization is strictly forbidden. For frequencies/channels that are currently in use in the U.S. without requiring an individual license, please contact the FCC Call Center at 1-888-CALL-FCC.

For individuals requiring a license, such as commercial users, you should obtain a license application from your nearest FCC field office.

Included with Your HH940



HH940

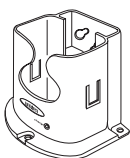

Charger



AC Adapter



Antenna



Battery



Wrist Strap



Operating Guide

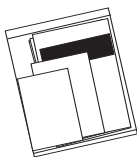

Printed Material

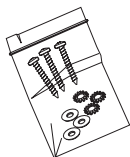

Mounting Screws

If any of these items are missing from the box, contact your Uniden Dealer.

Getting Started

Mounting the Drop-in Charger

1. Mount the drop-in charger to either a counter or wall.

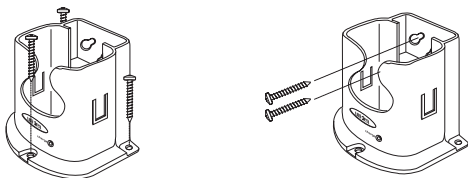

2. Plug one end of the AC adapter into the wall outlet, and the other end into the Drop-in Charger.

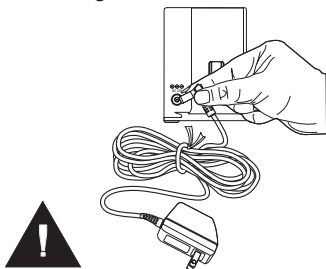

Attaching the Antenna

Attach the antenna to the HH940. Be sure the antenna is firmly seated.



Attaching the Battery Pack

1. Slide the battery pack onto the bottom of the radio.



2. Use a quarter to turn the screw that connects the battery pack to the HH940. Be sure the battery pack fits tightly against the HH940's body.

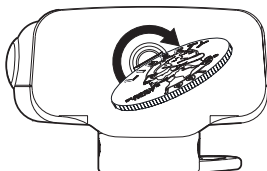

Charging the Battery Pack

Your marine radio is powered by a specially-designed nickel-cadmium battery pack.

- ☞ Before operating the HH940, charge the battery pack for 15 hours in the drop-in charger.

1. Place the HH940 in the drop-in charger.

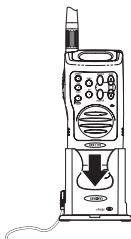

2. The red LED lights and stays on.



- ☞ The charger won't overcharge the battery pack.
- ☞ Do not transmit when the HH940 is in the drop-in charger!
- ☞ You can monitor incoming calls while the HH940 is in the drop-in charger.
- ☞ You can charge the battery pack alone or connected to the HH940.

Operation

- ☞ When you press any key (except PTT), a short tone sounds.
- ☞ Whenever you turn on your HH940, it is tuned to channel 16 – the United States Coast Guard frequency for distress, safety, and calling.
- ☞ See the foldout in the front of the operating guide for button and key positions.

Setting the Squelch

1. To turn the unit on, press and hold the **power** button for 2.0 seconds.



2. Use the **volume** and **chan** buttons to adjust the volume to a comfortable level.

3. Press the **volume** button.



Press ▲ on the **chan** button to adjust the volume up.



Press ▼ on the **chan** button to adjust the volume down.



Press **volume** to finish.

- ☞ Before setting the squelch control on your marine radio, you must select a channel that is not in use.

4. Use the **squelch** and **chan** buttons to adjust the squelch to the desired level. Think of the squelch control as a gate.

Press the **squelch** button.

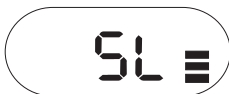

Press and hold ▲ on the *chan* button to adjust the “squelch gate” so high that no signals get through.

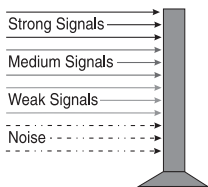

5. Press and hold ▼ on the *chan* button to adjust the “squelch gate” so everything gets through – noise, weak signals, and strong signals.

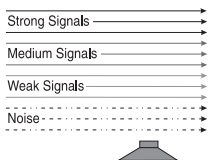

6. To set the “squelch gate” to the desired level, press ▲ on the *chan* button until the gate is all the way shut.

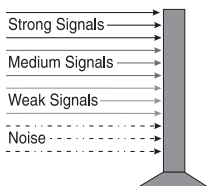

Press ▼ repeatedly until you just hear noise. Then press ▲ on the *chan* button repeatedly until the noise just stops. Now only strong signals get through.

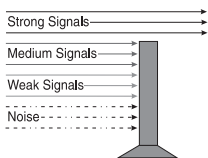

Press the *squelch* button when finished.

Selecting a Channel

1. Turn on your HH940.



2. To select a higher channel, press ▲ on the channel button.



3. To select a lower channel press ▼ on the channel button.

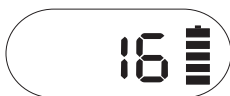

One-touch Channel 16/9

Example: While you are monitoring channel 19, you want to check channel 16 or channel 9.

You are on channel 19.



1. To monitor channel 16, press the **16/9** button.



2. To monitor channel 9, press the **16/9** button again.



To return to channel 19, press the **16/9** button again.

All-channel Scan

 While the HH940 is scanning, it is automatically in Triple Watch mode. See page 12 for information on Triple Watch operation.

Example: You're listening to channel 6. You want to scan all the channels.

1. To start scanning all channels, press the **scan** button.



2. The channels flash on the LCD display as the HH940 looks for a transmission.



3. When it finds (receives) an incoming call, the HH940 stops and monitors that channel.



4. When the transmission stops, the radio continues scanning.

To stop scanning channels press **scan**, **wx**, or **16/9**.

Monitoring Weather Channels

The HH940 has 10 preprogrammed weather channel frequencies – represented by 1 through 0.

1. To listen to the weather channels in your area, press **wx**.



2. To move up, press **▲** on the **chan** button.



3. To move down, press **▼** on the **chan** button.



4. To exit press **wx**.

Triple Watch

Triple Watch mode monitors channels 16 and 9 while monitoring the currently selected channel for a signal. The marine radio checks channel 16 and channel 9 for activity every 2 seconds.

To select Triple Watch mode press and hold the **triple** button for two seconds. A double confirmation tone sounds.



- While in Triple Watch mode you can use the select channels using the ▲ and ▼ chan button, or monitor channels 16 or 9 by pressing and releasing the 16/9 button.

To exit Triple Watch, press and hold **triple** for two seconds. A double confirmation tone sounds.

- If Weather Alert is active, it also checks the weather channel every 7 seconds.

Weather Alert

Weather Alert lets your HH940 function as a severe weather warning radio. With Weather Alert turned on, when the NOAA issues a severe weather warning, the HH940 sounds an alert tone and you will hear the emergency weather broadcast.

- To select Weather Alert, press and hold **wx** for two seconds. A double confirmation tone sounds.



- To turn off weather alert, press and hold **wx** for two seconds. A double confirmation tone sounds.



International-USA Channels

1. To listen to international marine channels, press *int*.



2. To switch back to USA marine channels, press *int* again.



-  For USA and international marine channels and functions, refer to the tables starting on page 14.

Transmitting

To transmit, press and hold in the *PTT* key.

To receive, release the *PTT* key.

Lighted Keys and Display

Press the LCD backlight button to light the display for about 5 seconds.

Key Lock

To prevent accidental entries, you can lock the keypad.

Press and hold the LCD backlight button until it beeps. The keypad is locked.

To unlock the keypad, press and hold the LCD backlight button again.

Marine Channels - USA

Channel	Frequency (MHz)		Traffic Type	Ship to Ship	Ship to Shore
	Transmit	Receive			
WX0		163.275	NOAA Weather		RX Only
WX1		162.550	NOAA Weather		RX Only
WX2		162.400	NOAA Weather		RX Only
WX3		162.475	NOAA Weather		RX Only
WX4		162.425	NOAA Weather		RX Only
WX5		162.450	NOAA Weather		RX Only
WX6		162.500	NOAA Weather		RX Only
WX7		162.525	NOAA Weather		RX Only
WX8		161.650	Can. Weather		RX Only
WX9		161.775	Can. Weather		RX Only
01	156.050	156.050	Com'l, Port Ops, VTS	Yes	Yes
02	156.100	156.100	Port Ops	Yes	Yes
03	156.150	156.150	Com'l, Port Ops, VTS	Yes	Yes
04	156.200	156.200	Port Ops	Yes	Yes
05	156.250	156.250	Port Ops, VTS	Yes	Yes
06	156.300	156.300	Safety	Yes	No
07	156.350	156.350	Com'l	Yes	Yes
08	156.400	156.400	Com'l	Yes	No
09	156.450	156.450	Com'l & Non Com'l	Yes	Yes
10	156.500	156.500	Com'l	Yes	Yes
11	156.550	156.550	Com'l, VTS, SMS	Yes	Yes
12	156.600	156.600	Port Ops, VTS, SMS	Yes	Yes
13	156.650	156.650	Navigational	Yes	No
14	156.700	156.700	Port Ops	Yes	Yes
15		156.750	Environmental		RX Only
16	156.800	156.800	Distress, Safety, Calling	Yes	Yes
17	156.850	156.850	State Control	Yes	Yes
18	156.900	156.900	Com'l	Yes	Yes
19	156.950	156.950	Com'l	Yes	Yes
20	157.000	161.600	Port Ops	Yes	Yes
21	157.050	157.050	U.S. Govt Only	Yes	Yes
22	157.100	157.100	Coast Guard	Yes	Yes
23	157.150	157.150	U.S. Govt Only	Yes	Yes
24	157.200	161.800	Public Corresp.	No	Yes
25	157.250	161.850	Public Corresp.	No	Yes
26	157.300	161.900	Public Corresp.	No	Yes
27	157.350	161.950	Public Corresp.	No	Yes
28	157.400	162.000	Public Corresp.	No	Yes
60	156.025	156.025			
61	156.075	156.075			
62	156.125	156.125			
63	156.175	156.175			
64	156.225	156.225			
65	156.275	156.275	Port Ops	No	Yes
66	156.325	156.325	Port Ops	Yes	Yes
67	156.375	156.375	Com'l	Yes	No
68	156.425	156.425	Non Com'l	Yes	Yes
69	156.475	156.475	Non Com'l	Yes	Yes
70		156.525	Digital Selective Calling	Yes	No
71	156.575	156.575	Non Com'l	Yes	Yes
72	156.625	156.625	Non Com'l	Yes	No
73	156.675	156.675	Port Ops	Yes	Yes
74	156.725	156.725	Port Ops	Yes	Yes
77	156.875	156.875	Port Ops	Yes	No
78	156.925	156.925	Non Com'l	Yes	Yes
79	156.975	156.975	Com'l	Yes	Yes
80	157.025	157.025	Com'l	Yes	Yes
81		157.075	U.S. Govt Only	Yes	Yes
82	157.125	157.125	U.S. Govt Only	Yes	Yes
83		157.175	U.S. Govt Only	Yes	Yes
84	157.225	161.825	Public Corresp.	No	Yes
85	157.275	161.875	Public Corresp.	No	Yes
86	157.325	161.925	Public Corresp.	No	Yes
87	157.375	161.975	Public Corresp.	No	Yes
88	157.425	157.425	Com'l	Yes	No

Marine Channels - International

Channel	Frequency (MHz)		Traffic Type	Ship to Ship	Ship to Shore
	Transmit	Receive			
WX0		163.275	NOAA Weather		RX Only
WX1		162.550	NOAA Weather		RX Only
WX2		162.400	NOAA Weather		RX Only
WX3		162.475	NOAA Weather		RX Only
WX4		162.425	NOAA Weather		RX Only
WX5		162.450	NOAA Weather		RX Only
WX6		162.500	NOAA Weather		RX Only
WX7		162.525	NOAA Weather		RX Only
WX8		161.650	Can. Weather		RX Only
WX9		161.775	Can. Weather		RX Only
01	156.050	160.650	Com'l, Port Ops, VTS	Yes	Yes
02	156.100	160.700	Port Ops	Yes	Yes
03	156.150	160.750	Com'l, Port Ops, VTS	Yes	Yes
04	156.200	160.800	Port Ops	Yes	Yes
05	156.250	160.850	Port Ops, VTS	Yes	Yes
06	156.300	156.300	Safety	Yes	No
07	156.350	160.950	Com'l	Yes	Yes
08	156.400	156.400	Com'l	Yes	No
09	156.450	156.450	Com'l & Non Com'l	Yes	Yes
10	156.500	156.500	Com'l	Yes	Yes
11	156.550	156.550	Com'l, VTS, SMS	Yes	Yes
12	156.600	156.600	Port Ops, VTS, SMS	Yes	Yes
13	156.650	156.650	Navigational	Yes	No
14	156.700	156.700	Port Ops, VTS, SMS	Yes	Yes
15	156.750	156.750	Environmental		RX Only
16	156.800	156.800	Distress, Safety, Calling	Yes	Yes
17	156.850	156.850	State Control	Yes	Yes
18	156.900	161.500	Com'l	Yes	Yes
19	156.950	161.550	Com'l	Yes	Yes
20	157.000	161.600	Port Ops	No	Yes
21	157.050	161.650	U.S. Govt Only	Yes	Yes
22	157.100	161.700	Coast Guard	Yes	Yes
23	157.150	161.750	U.S. Govt Only	Yes	Yes
24	157.200	161.800	Public Corresp.	No	Yes
25	157.250	161.850	Public Corresp.	No	Yes
26	157.300	161.900	Public Corresp.	No	Yes
27	157.350	161.950	Public Corresp.	No	Yes
28	157.400	162.000	Public Corresp.	No	Yes
60	156.025	160.625			
61	156.075	160.675			
62	156.125	160.725			
63	156.175	160.775			
64	156.225	160.825			
65	156.275	160.875	Port Ops	Yes	Yes
66	156.325	160.925	Port Ops	Yes	Yes
67	156.375	156.375	Com'l	Yes	No
68	156.425	156.425	Non Com'l	Yes	Yes
69	156.475	156.475	Non Com'l	Yes	Yes
70		156.525	Digital Selective Calling	Yes	No
71	156.575	156.575	Non Com'l	Yes	Yes
72	156.625	156.625	Non Com'l	Yes	No
73	156.675	156.675	Port Ops	Yes	Yes
74	156.725	156.725	Port Ops	Yes	Yes
77	156.875	156.875	Port Ops	Yes	No
78	156.925	161.525	Non Com'l	Yes	Yes
79	156.975	161.575	Com'l	Yes	Yes
80	157.025	161.625	Com'l	Yes	Yes
81	157.075	161.675	U.S. Govt Only	Yes	Yes
82	157.125	161.725	US Gov Only	Yes	Yes
83	157.175	161.775	U.S. Govt Only	Yes	Yes
84	157.225	161.825	Public Corresp.	No	Yes
85	157.275	161.875	Public Corresp.	No	Yes
86	157.325	161.925	Public Corresp.	No	Yes
87	157.375	161.975	Public Corresp.	No	Yes
88	157.425	162.025	Public Corresp.	No	Yes

Parts and Accessories



Antenna



Battery Pack
BP940



Operating Guide



Wrist Strap



AC Adapter

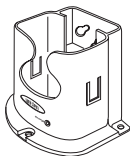

Drop-in Charger

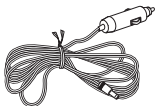

Cigarette
Adapter
HH9804

Specifications

General

Channels	Transmit	55 US/International
	Receive	90 US/International
	Weather	10
Freq. Control		PLL
Freq. Tol.	Transmit	1.0 PPM
	Receive	1.0 PPM
Oper. Temp.		-4°F(-20°C) to +122°F(+50°C)
Antenna		Flexible Whip
Microphone		Built-in Electret type
Display		Liquid Crystal Display
Speaker		8Ω 1 Watt
Power Source		Rechargeable Nickel-cadmium Battery Pack 4.8V 400 mAh
Size	(without antenna)	122 (H) 63 (W) 32 (D)
Weight	(w/battery & antenna)	8.4 oz.

Transmitter

Frequency Range	156 ~ 158 MHz
Frequency Stability	±5 PPM
Power Output	1.0 W
Spurious Emissions	-55 dBc
Current Drain	500 mA

Receiver

Receiver Type	Triple Conversion Super Heterodyne Phase Locked Loop system for Local Oscillator
Frequency Range	156 ~ 164 MHz
Sensitivity	0.25 μV for 12dB SINAD
Squelch Sensitivity	Threshold 0.15μV
Audio Frequency Response	±6 dB 500 to 2000 Hz
Adjacent Channel Selectivity	60 dB @± 25 kHz
Hum & Noise Ratio	40 dB
Audio Output Power	0.6 W @10% THD
Current DrainSquelched	40 mA
Max. Audio	280 mA

Specifications shown are typical and subject to change without notice.

Three-year Limited Warranty

Important! Evidence of original purchase is required for warranty service.

WARRANTOR: Uniden

ELEMENTS OF WARRANTY: Uniden warrants, for three years, to the original retail owner, this Uniden Product to be free from defects in materials and craftsmanship with only the limitations or exclusions set out below.

WARRANTY DURATION: This warranty to the original user shall terminate and be of no further effect 36 months after the date of original retail sale. The warranty is invalid if the Product is (A) damaged or not maintained as reasonable or necessary, (B) modified, altered, or used as part of any conversion kits, subassemblies, or any configurations not sold by Uniden, (C) improperly installed, (D) serviced or repaired by someone other than an authorized Uniden service center for a defect or malfunction covered by this warranty, (E) used in any conjunction with equipment or parts or as part of any system not manufactured by Uniden, or (F) installed or programmed by anyone other than as detailed by the Operating Guide for this product.

STATEMENT OF REMEDY: In the event that the product does not conform to this warranty at any time while this warranty is in effect, warrantor will either, at its option, repair or replace the defective unit and return it to you without charge for parts, service, or any other cost (except shipping and handling) incurred by warrantor or its representatives in connection with the performance of this warranty. Warrantor, at its option, may replace the unit with a new or refurbished unit. THE LIMITED WARRANTY SET FORTH ABOVE IS THE SOLE AND ENTIRE WARRANTY PERTAINING TO THE PRODUCT AND IS IN LIEU OF AND EXCLUDES ALL OTHER WARRANTIES OF ANY NATURE WHATSOEVER, WHETHER EXPRESS, IMPLIED OR ARISING BY OPERATION OF LAW, INCLUDING, BUT NOT LIMITED TO ANY IMPLIED WARRANTIES OF MERCHANTABILITY OR FITNESS FOR A PARTICULAR PURPOSE. THIS WARRANTY DOES NOT COVER OR PROVIDE FOR THE REIMBURSEMENT OR PAYMENT OF INCIDENTAL OR CONSEQUENTIAL DAMAGES. Some states do not allow this exclusion or limitation of incidental or consequential damages so the above limitation or exclusion may not apply to you.

LEGAL REMEDIES: This warranty gives you specific legal rights, and you may also have other rights which vary from state to state. This warranty is void outside the United States of America.

PROCEDURE FOR OBTAINING PERFORMANCE OF WARRANTY: If, after following the instructions in this Operating Guide you are certain that the Product is defective, pack the Product carefully (preferably in its original packaging). Include evidence of original purchase and a note describing the defect that has caused you to return it. The Product should include all parts and accessories originally packaged with the product. The Product should be shipped freight prepaid by traceable means, or delivered, to warrantor at:

Uniden America Corporation
4700 Amon Carter Blvd.
Ft Worth, TX 76155
(800) 586-0409
8:00 a.m. to 5:00 p.m., Central
Monday through Friday

uniden[®]

©1998 Uniden America Corporation
All Rights Reserved.
Printed in the Philippines

Free Manuals Download Website

<http://myh66.com>

<http://usermanuals.us>

<http://www.somanuals.com>

<http://www.4manuals.cc>

<http://www.manual-lib.com>

<http://www.404manual.com>

<http://www.luxmanual.com>

<http://aubethermostatmanual.com>

Golf course search by state

<http://golfingnear.com>

Email search by domain

<http://emailbydomain.com>

Auto manuals search

<http://auto.somanuals.com>

TV manuals search

<http://tv.somanuals.com>