

**Uniden®**

**CXAI 5198**

**SERIES**

**OWNER'S**

**MANUAL**

**OWNER'S MANUAL**

# Contents

<b>WELCOME/FEATURES</b>	<b>2</b>	<b>USING THE SPEED DIAL MEMORY</b>	<b>29</b>
<b>TERMINOLOGY</b>	<b>3</b>	Using the Speed Dial Memory	29
<b>CONTROLS &amp; FUNCTIONS</b>	<b>4</b>	<b>CALLER ID</b>	<b>34</b>
<b>GETTING STARTED</b>	<b>6</b>	Caller ID and Caller ID on Call Waiting (CIDCW)	34
Setting up the Phone	6	<b>THE INTEGRATED ANSWERING DEVICE</b>	<b>38</b>
Installing the Beltclip	11	The Integrated Answering Device	38
Optional Headset Installation	12	Setting Up the Answering Machine	39
<b>SETTING UP YOUR PHONE</b>	<b>13</b>	Turning the Answering System On/Off	41
Base Setup	13	Setting Your Outgoing Message (Greeting)	42
Handset Setup	16	Using Your Answering System	43
<b>BASICS</b>	<b>19</b>	Remote Operation	48
Using Your Phone	19	<b>ADDITIONAL INFORMATION</b>	<b>52</b>
Call Waiting	22	Note on Power Sources	52
Placing a Call on Hold	22	General Information	54
Adjusting the Ringer, and Earpiece and Speaker Volume	23	<b>TROUBLESHOOTING</b>	<b>55</b>
Muting the Ringer	24	Liquid Damage	57
Mute Base Microphone	25	<b>PRECAUTIONS &amp; WARRANTY</b>	<b>58</b>
Tone Dialing Switch-over	25	<b>I.C. NOTICE</b>	<b>60</b>
Traveling Out of Range	25	<b>INDEX</b>	<b>61</b>
Selecting a Different Channel	26	<b>REMOTE OPERATION CARD</b>	<b>62</b>
Conferencing	26		
Intercom	27		

# Welcome

Congratulations on your purchase of the Uniden Cordless Telephone System! This is a “Corded/Cordless” Telephone unit. The corded handset (on base) can make/receive calls during power failure. You can now place a fully-featured cordless handset anywhere in your home or office where AC power is available to connect the handset charger.

**Note: Illustrations in this manual are used for explanation purposes.  
Some illustrations in this manual may differ from the actual unit.**

# Features

- 5.8GHz Extended Range Technology
- Corded/Cordless Telephone System
- Make and Receive Calls During a Power Failure
- Integrated Answering Device
- Caller ID and Caller ID on Call Waiting
- 50 Caller ID feature
- Dual Keypad and LCD Screen at Base
- 10 Number Memory Dialing in the Base and Handset
- Trilingual Display Options and Voice Prompts (English, French and Spanish)
- Intercom Between Handset and Base
- Mute and Hold Features
- Do Not Disturb (DND) Feature
- Clock Display
- Base Speakerphone

This series features **AutoTalk™** and **AutoStandby™**. AutoTalk allows you to answer a call by just removing the handset from the cradle so you don't have to waste time pushing buttons. AutoStandby allows you to hang up by simply returning the handset to the cradle.



To protect you against mis-billed calls that might result from your phone being activated by other equipment, one of more than 10,000 digital security codes is set for your phone.

Be sure to visit our web site: [www.uniden.com](http://www.uniden.com)

Uniden® is a registered trademark of Uniden America Corporation.

AutoTalk, AutoStandby and UltraClear Plus are trademarks of Uniden America.

## Terminology

- **Standby Mode** - The handset may be sitting or off the cradle, but is NOT in use. **talk/flash** has not been pressed. The corded base handset is on the base and  (**speaker**) on the base has not been pressed. No dial tone is present.
- **Talk Mode** - The handset is off the cradle and **talk/flash** has been pressed, or pick up the corded base handset or  (**speaker**) on the base is pressed and enabling a dial tone.

### Talk and Standby Times

With average use, your handset battery provides approximately 6 hours of talk time and approximately 10 days of standby time. When your handsets are not being used and are left off of their charging cradles, the battery will gradually discharge. You can achieve optimum battery life and performance by returning the handset to the charging cradle after each use. If the handset is left off of the charging cradle, the actual talk time duration will be reduced respective to the amount of time the handset is off of the charging cradle.

# Controls & Functions

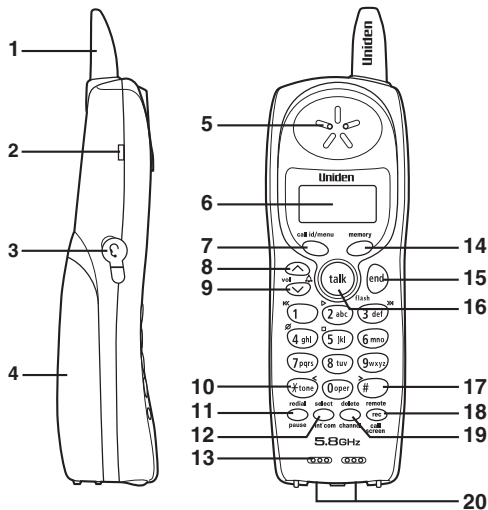

1. Handset antenna
2. Beltclip hole
3. Jack for optional headset
4. Handset battery compartment
5. Handset earpiece
6. LCD display
7. **call id** (Caller ID)/**menu** (P.16, 35)
8. **^/vol/Δ** (volume & scroll) (P.16, 23)
9. **∇/vol/Δ** (volume & scroll) (P.16, 23)
10. **\*/tone/<** (left cursor) (P.25, 30)
11. **redial/pause** (P.21, 31)
12. **select/int'com** (P.16, 27)
13. Handset microphone and ringer speaker
14. **memory** (P.29)
15. **end** (P.21, 24)
16. **talk/flash** (P.19, 22, 26)
17. **#/>** (right cursor) (P.30)
18. **rec** (record)/**remote/call screen** (P.47, 50)
19. **delete/channel** (P.26, 30, 36)
20. Handset charging contacts

## Retrieve TAD message with Handset Remote keys

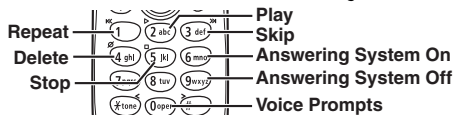

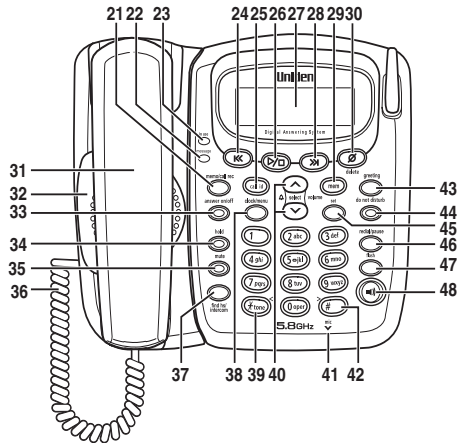

- 21. **memo/call rec** (record) (P.46, 47)
- 22. Message LED
- 23. In use LED
- 24. **◀◀ (repeat/rewind)** (P.44)
- 25. **call id** (P.35)
- 26. **▶/□ (play/stop)** (P.44)
- 27. LCD display
- 28. **▶▶ (skip/forward)** (P.45)
- 29. **mem** (memory) (P.29)
- 30. **∅ delete** (P.30, 36, 45)
- 31. Corded base handset
- 32. Base speaker
- 33. **answer on/off**/answer on/off LED (P.41)

- 34. **hold**/hold LED (P.22)
- 35. **mute**/mute LED (P.24, 25)
- 36. Curl cord
- 37. **find hs** (handset)/intercom (P.27)
- 38. **clock/menu** (P.13, 39)
- 39. **\*/tone/ <** (left cursor) (P.25, 30)
- 40. **^/∨/△/select/volume** (volume, scroll & select) (P.13, 24, 35)
- 41. Mic (microphone)
- 42. **#/>** (right cursor)(P.30)
- 43. **greeting** (P.42)
- 44. **do not disturb**/do not disturb LED (P.24)

- 45. **set** (P.13, 39)
- 46. **redial/pause** (P.21, 31)
- 47. **flash** (P.22)
- 48. **speaker**/speaker LED (P.20, 26)
- 49. **DC IN 9V** Jack
- 50. **TEL LINE** Jack
- 51. Base antenna
- 52. Wall mount adapter
- 53. Charging contacts
- 54. Charge LED
- 55. **DC IN 9V** Jack

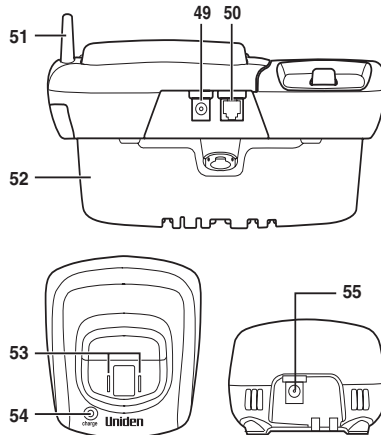

# Setting up the Phone

Do the following steps:

- A. Choose the best location
- B. Connect the base unit
- C. Install the rechargeable battery pack into the handset
- D. Connect the charger
- E. Mount the base unit on a wall (if desired)

## A. Choose the best location

Before choosing a location for your new phone, read “Installation Considerations” on page 59. Here are some important guidelines you should consider:

Avoid heat sources, such as radiators, air ducts, and sunlight

Avoid noise sources such as a window by a street with heavy traffic

Avoid television sets and other electronic equipment

Avoid microwave ovens

Avoid excessive moisture, extremely low temperatures, dust, mechanical vibration, or shock

Avoid personal computers

Choose a central location

Avoid other cordless telephones

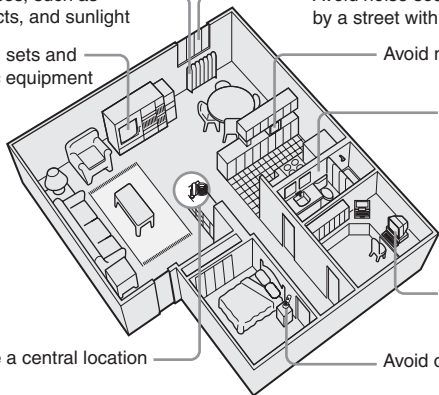

Keep the antenna free of obstruction.



If your home has specially wired alarm equipment connected to phone line, be sure that installing the system does not disable your alarm equipment.

If you have questions about what will disable alarm equipment, contact your telephone company or a qualified installer.



- Use only the supplied [AD-830] AC adapter. Do not use any other AC adapter.
- Do not place the power cord where it creates a trip hazard or where it could become chafed and create a fire or electrical hazard.

## B. Connect the base unit

- 1) Connect to the handset cord to the left side of the phone and the corded base handset.
- 2) Connect AC adapter to the **DC IN 9V** jack and to a standard 120V AC wall outlet.  
Connect the AC adapter to a continuous power supply (i.e., an outlet that is not controlled by a switch).

Place the base unit close to the AC outlet to avoid long extension cords.

- 3) Connect the telephone line cord to the **TEL LINE** jack and to a telephone outlet.
- 4) Set the base on a desk or tabletop. Place the corded base handset on the base.



If your telephone outlet isn't modular, contact your telephone company for assistance.

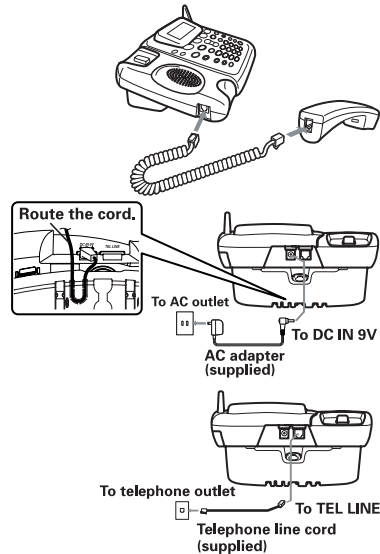



## C. Install the rechargeable battery pack into the handset

- 1) Press down on the handset battery case cover (use the finger indentation for a better grip) and slide the cover downward to remove.
- 2) Plug the battery pack connector (red & black wires) into the jack inside the battery compartment. (The connector notches fit into the grooves of the jack only one way.) Match the wire colors to the polarity label in the battery compartment, connect the battery and listen for a click to insure connection.
- 3) Make sure you have a good connection by slightly pulling on the battery wires. If the connection is secure, the battery jack will remain in place.
- 4) Place the battery case cover back on the handset and slide it upwards until it clicks into place.

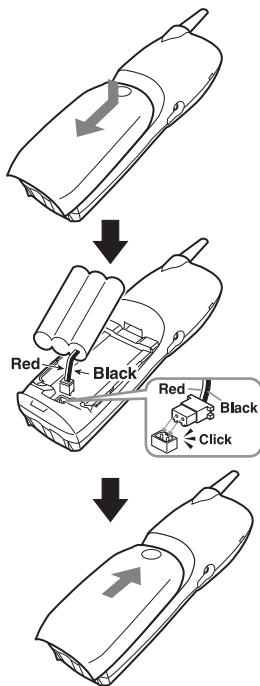

Use only the Uniden (BT-905) rechargeable battery pack supplied with your cordless telephone.



Use only the supplied AC adapter (AD-310). Do not use any other AC adapter.

## D. Connect the charger

The handset is powered by a rechargeable battery pack. The battery recharges automatically when the handset is placed in the charger.

- 1) Connect the AC adapter to the **DC IN 9V** jack and to a standard 120V AC wall outlet.
- 2) Set the charger on a desk or tabletop, and place the handset in the charger with the keypad facing forward.
- 3) Make sure that the charge LED illuminates.  
If the LED does not illuminate, check to see that the AC adapter is plugged in and the handset makes good contact with the base charging contacts.
- 4) Charge the handset battery pack for at least 15-20 hours before using your new cordless handset for the first time.

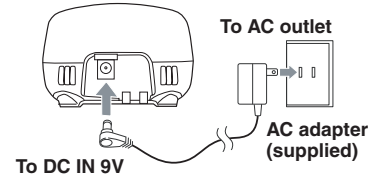

## E. Mount the base unit on a wall (if desired)

### Standard wall plate mounting

This phone can be mounted on any standard wall plate.

- 1) Remove the wall mount adapter from the base and snap it into the notches on the bottom of the base.
- 2) Plug the AC adapter to the **DC IN 9V** jack.
- 3) Wrap the AC adapter cord inside the molded wiring channel as shown.
- 4) Plug the AC adapter into a standard 120V AC wall outlet.
- 5) Plug the telephone line cord into the **TEL LINE** jack.
- 6) Wrap the cord inside the molded wiring channel as shown.
- 7) Plug the telephone line cord into the telephone outlet.
- 8) Align the mounting slots on the base with the mounting posts on the wall. Then push in and down until the phone is firmly seated.
- 9) On the base unit, pull the handset retainer out of the slot. Rotate it clockwise 180 degrees.
- 10) Flip the retainer from front to back. Slide it back into the slot so that the lip of the retainer is up and the oval is down. The retainer holds the handset in place.

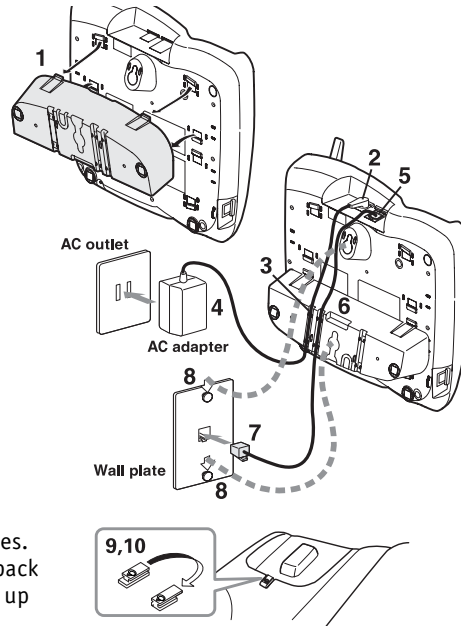

## **Direct wall mounting**

If you don't have a standard wall plate, you can mount your phone directly to the wall. Before doing this, consider the following:

- Avoid electrical cables, pipes, or other items behind the mounting location that could cause a hazard when inserting screws into the wall.
  - Try to mount your phone within 5 feet of a working phone jack to avoid excessive cord lengths.
  - Make sure the wall material is capable of supporting the weight of the base and handset.
  - Use #10 screws (minimum length of 1-3/8 inches) with anchoring devices suitable for the wall material where the base unit will be placed.
- 1) Insert two mounting screws into the wall, (with their appropriate anchoring device), 3-15/16 inches apart. Allow about 1/8 of an inch between the wall and screw heads for mounting the phone.
  - 2) Refer to steps 1 through 8 on page 10 to mount the telephone.

## **Installing the Beltclip**

### **To attach the beltclip**

Insert the beltclip into the holes on each side of the handset. Press down until it clicks.

### **To remove the beltclip**

Pull both sides of the beltclip to release the tabs from the holes.

## Optional Headset Installation

Your phone may be used with an optional headset. To use this feature, insert the headset plug into the headset jack. Your phone is ready for hands-free conversations. (Headsets may be purchased by visiting our website at [www.uniden.com](http://www.uniden.com) or by calling our Parts Department. See back cover page.)



# Base Setup

Below are some tips for using the software interface on your phone.

- Press **clock/menu** on the base to access the base main menu.
- Use the volume up or down key ( $\wedge/\vee/\triangle$  /**select/volume**) to scroll through options.
- Press **set** on the base to make a selection.
- For your convenience, voice prompts will guide you through the base main menu (except LCD contrast and Dial mode setting).
- Press **clock/menu** or  $\triangleright/\square$  (**play/stop**) on the base to return to standby mode.
- If you do not press a key within 30 seconds, the phone will time out and exit the menu mode. When setting Day and Time, the time-out period is extended to two minutes.

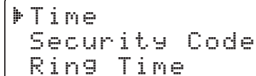

```
Time
Security Code
Ring Time
```

## Adjusting the LCD Contrast

Contrast adjusts the base LCD brightness. Choose one of the ten levels for optimum viewing.

- 1) Press **clock/menu** on the base.
- 2) Press the volume down key to move the pointer to select LCD Contrast and then press **set**.
- 3) Press the volume up or down key to adjust the contrast of the LCD (ten levels.)
- 4) Press **set**. You will hear a confirmation tone.



```
LCD Contrast:
Level 3
Press v/\triangle or set
```



## Setting the Dial Mode

Dial Mode sets the dial mode to tone or pulse. Most phone systems use tone dialing; the default setting is tone dialing. Set the dialing mode to match the dialing system used by your local phone service.

- If you are not sure of your dialing system, make a trial call. If the call connects, leave the setting as is; otherwise set the unit to pulse dialing.
  - If your phone system requires pulse dialing and you need to send DTMF tones in certain situations during a call, you may switch over to tone dialing (refer to “Tone Dialing Switch-over” on page 25).
- 1) Press **clock/menu** and the volume down key to move the pointer to select `Dial Mode`, and then press **set**.
  - 2) Press the volume up or down key to select `Tone` or `Pulse` (the initial setting is `Tone`).
  - 3) Press **set**. You will hear a confirmation tone.

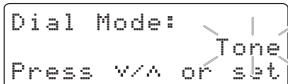

```
Dial Mode: Tone |
Press v/Δ or set
```

## Setting Day and Time

Day & Time sets the day and time of your display.

- 1) Press **clock/menu** on the base.
- 2) Press **set** to select `Time`. The system announces “Time”, the current time and the guidance for the setting the time.
- 3) Press the volume up or down key to select the day of the week, and then press **set**.
- 4) Enter a two-digit number (**01-12**) to set hour, and then press **set**.
- 5) Enter a two-digit number (**00-59**) to set minute, and then press **set**.
- 6) Press the volume up or down key to choose `AM` or `PM`, and then press **set**. You hear a confirmation tone.



```
Day: Sunday |
Press v/Δ or set
```

Use **Ø delete** to edit the hour and minute.



If the area code has already been stored in memory, the stored area code will be displayed. To change it, use **∅ delete** and number keys to enter the new area code.

## Setting the Area Code

If you enter a 3-digit area code number in the Area Code option, your local area code does not appear in the Caller ID message. For calls received from outside your local area code, you will see a full 10-digit number.

- 1) Press **clock/menu** and the volume down key on the base to select **Area Code**, and then press **set**.
- 2) Press the number keypad (**0-9**) to enter a 3-digit area code.
- 3) If you press **set**, the stored number will be transferred to the handset. If the transfer is successful, you will hear a confirmation tone from the base and handset. Otherwise, **Area Code Setting Failed!** appears on the display and an error tone sounds. You will have to start over with the procedure you are performing.

```
Area Code:
          █
Press 0-9 or set
```

## Setting Caller ID on Call Waiting (CIDCW)

Caller ID on Call Waiting (CIDCW) displays the name and number of an incoming call while you are on the line.

- 1) Press **clock/menu** and the volume down key on the base to select **CIDCW**, and then press **set**.
- 2) Press the volume up or down key to select **On** or **Off**, and then press **set**. You will hear a confirmation tone.

```
CIDCW:
          On
Press v/∧ or set
```



## Setting the Language of your Answering System and the Base Display

Language allows you to set the language of your answering system announcements to English, French, or Spanish.

- 1) Press **clock/menu** and the volume down key on the base to select **Language**, and then press **set**.
- 2) Press the volume up or down key to choose **English**, **Français** (French), or **Español** (Spanish).
- 3) Press **set**. You will hear a confirmation tone.

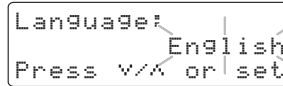

```
Language: English
Press v/v or set
```

## Handset Setup

### Using the interface

Below are some tips for using the software interface on your phone.

- Press and hold **call id/menu** on the handset to access the main menu.
- Use the volume up key or volume down key (**^/v/vol/Δ**) to scroll through options.
- Press **select/int'com** on the handset to make a selection.
- Press **end** or **call id/menu** on the handset, or return the handset to the cradle to return to standby.

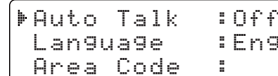

```
▶ Auto Talk : Off
  Language  : Eng
  Area Code  :
```

## Setting AutoTalk

AutoTalk allows you to answer the phone simply by removing the handset from the cradle. You do not have to press any buttons to answer the call.

- 1) Press and hold **call id/menu** on the handset. Press **select/int'com** to turn AutoTalk on.
- 2) Press **end**. The handset returns to standby mode.

```
▶ Auto Talk   : Off
  Language    : Eng
  Area Code   :
```

## Selecting a Language (Handset only)

You can change the language the menu display will use. Choose from English, French, or Spanish.

- 1) Press and hold **call id/menu** on the handset.
- 2) Press the volume down key to move the pointer to select Language.
- 3) Press **select/int'com** to select from **Eng** (English), **Fr.** (French), **Esp** (Spanish).
- 4) Press **end**. The handset returns to standby mode.

```
Auto Talk   : On
▶ Language   : Eng
  Area Code  :
```

## Checking Area Code selected from the Handset

You can only check the Area Code number you have set. If you want to enter or edit the number, refer to “Setting the Area Code” on page 15.

- 1) Press and hold *call id/menu* on the handset.
- 2) You can check the number entered in Area Code.
- 3) Press *end*. The handset returns to standby mode.

```
▶ Auto Talk   : Off  
  Language    : Eng  
  Area Code   : 345
```

# Using Your Phone

## Power Failure Operation

Because the phone is a corded/cordless combination phone, it can still perform several of its functions during a power failure. The following features will function even during a power failure.

- Making and receiving calls with the corded base handset
  - Adjusting the volume on the main base
  - Call waiting/flash feature on the main base
- All other features are disabled during a power failure.

## Making and Receiving Calls

### Making a call

#### From the handset

- 1) Remove the handset from the cradle.
- 2) Press **talk/flash**.
- 3) Listen for the dial tone.
- 4) Dial the number.

OR

- 1) Remove the handset from the cradle.
- 2) Dial the number.

To insert a two-second pause in the dialing sequence, press **redial/pause**.

P appears in the display.

3) Press **talk/flash**.

#### **From the base**

- 1) Pick up the corded handset, or press **⏻** (**speaker**).
- 2) Listen for the dial tone.
- 3) Dial the number.

OR

- 1) Dial the number.  
If a pause is required, press **redial/pause**.
- 2) Pick up the corded handset, or press **⏻** (**speaker**).

#### **Receiving a call**

##### **From the handset**

- 1) Remove the handset from the cradle. (If AutoTalk is on, the phone will automatically answer the call when you pick it up.)
- 2) Press **talk/flash**.

OR

If the handset is off the cradle, press **talk/flash** or any number. (AutoTalk is on.)

##### **From the base**

Press **⏻** (**speaker**) or pick up the corded handset.



- To set "AutoTalk", see page 17.
- The base microphone is located under the base. Position yourself as near to the base as possible.

## Redialing the last dialed number

### From the handset

- 1) Remove the handset from the cradle.
- 2) Press ***talk/flash***.
- 3) Listen for the dial tone.
- 4) Press ***redial/pause***.

OR

- 1) Remove the handset from the cradle.
- 2) Press ***redial/pause***.
- 3) Press ***talk/flash***.

### From the base

- 1) Pick up the corded handset, or press **🔊** (***speaker***).
- 2) Listen for the dial tone.
- 3) Press ***redial/pause***.

OR

- 1) Press ***redial/pause***.
- 2) Pick up the corded handset, or press **🔊** (***speaker***).

## Hanging Up

From the handset press ***end*** or return the handset to the cradle (AutoStandby).

From the base, press **🔊** (***speaker***) or return the corded handset to the base.

# Call Waiting

If you have Call Waiting service, you can receive calls while on the line.

- 1) If a call comes in while you are on the phone, you will hear a call waiting tone. If you have CIDCW activated, you will see the name and number of the incoming caller.
- 2) Press **talk/flash** on the handset, or **flash** on the base to accept the waiting call. After a short pause, you will hear the new caller.
- 3) To return to the original caller, press **talk/flash** on the handset, or **flash** on the base again.



You must subscribe through your local telephone company to receive Call Waiting service.

# Placing a Call on Hold

- 1) During a call with the base, press **hold** on the base. The call will be put on hold.
- 2) To return to the call, press **hold** again, pick up the corded handset or press **talk/flash** on the handset. To talk to the caller on a speakerphone, press **speaker** or **hold** on the base.

- You can place a call on hold for ten minutes. When ten minutes has passed, the call is disconnected, and the phone returns to standby mode.
- You can return the corded handset to the base while a call is on hold, and the call will remain on hold.

# Adjusting the Ringer, and Earpiece and Speaker Volume

## Selecting the Handset Ring Tone and Volume

Your phone has two different ringer tones (A and B) and two different volumes for each (low and high).

- 1) With the phone in standby mode, press the volume up key or volume down key ( $\wedge/\vee$ /**vol**/ $\Delta$ ) to cycle through Ringer A High, Ringer A Low, Ringer B High, Ringer B Low, and Ringer off.
- 2) When the phone sounds the ring tone and volume you wish to use, press the **end** key.

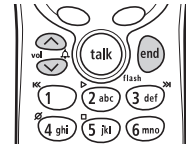

## Setting the Base Ringer Volume

The base has three settings for ringer volume: High, Low, and Off.

- 1) With the phone in standby mode, press the volume up key or down key ( $\wedge/\vee$ / $\Delta$ /**select/volume**).
- 2) The base will sound the ringer volume at the selected setting and display the new ringer volume.
- 3) When the phone sounds the ringer volume you wish to use, press  $\triangleright/\square$  (**play/stop**).

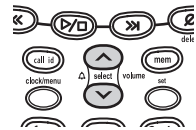



## Earpiece and Speaker Volume

You can select earpiece volume from among four volume levels on the handset and the corded handset and eight different volume levels on the base speaker. For the base speaker volume, press the volume up key or volume down key ( $\wedge/\vee/\text{vol}/\blacktriangle$  or  $\wedge/\vee/\blacktriangle/\text{select/volume}$ ) during a call or while the speaker is turned on to change the earpiece/speaker volume level. This setting will remain in effect after the telephone call has ended.

## Muting the Ringer

### Do Not Disturb (DND)

The do not disturb feature (DND) allows you to mute the ringer on the base and handset at the same time. The phone must be in standby mode. Press and hold **do not disturb** on the base. You will hear a confirmation tone, and the do not disturb LED illuminates on the base. Do Not Disturb flashes on the handset display. To cancel the DND feature, press **do not disturb** again. You can also mute the ringer tone while the phone is ringing by pressing **do not disturb** on the base.

### Temporarily Muting the Ringer

To mute the ringer tone temporarily for the handset or the base, when the phone is ringing, press **end** on the handset when the handset is off the cradle, or press  $\blacktriangleright/\square$  (**play/stop**) or **mute** on the base. The mute will last for the current incoming call only. The ringer tone will return to the previous setting starting with the next incoming call.



If the answering system is off and press **do not disturb**, the answering system will be automatically turned on.



The tone feature only applies when the dial mode is set to pulse.

## Mute Base Microphone

During a call or an intercom call, press **mute** on the base to mute the microphone. **Mute On** appears on the display. To cancel muting, press **mute** again.

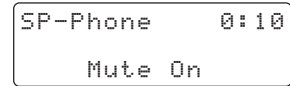

## Tone Dialing Switch-over

If your telephone company requires pulse dialing, you can switch over to tone dialing after the call connects. This feature is useful when you need tone dialing to use any automated menu systems, such as telephone bank tellers, telephone prescription refills, customer support menus, etc.

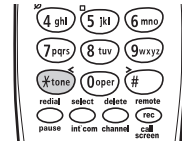

If your phone is set to pulse dialing mode, make your call normally. Once your call connects, press **\*/tone/<**. Any digits you enter from then on will be sent as tone digits. When this particular call ends, the phone automatically returns to pulse dialing mode.

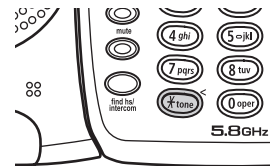

## Traveling Out of Range

During a call, as you begin to move your handset too far from your base unit, noise may increase. If you pass the range limits of the base unit, your call will terminate within one minute.

# Selecting a Different Channel

If you encounter interference while using your handset, you can manually change the handset's channel for clear operation. While using your handset, press **delete/channel**. **Scanning** appears on the display, indicating the handset is changing to another channel. For more information on interference, refer to "Precautions" on page 59.

# Conferencing

Up to three people can participate in a conference call using an outside line, the handset, and the base.

## Joining a Conference Call

You can easily join a call already in progress.

### From the base

- 1) While in talk mode with the handset, press **speaker** on the base or pick up the corded handset from the base to join the conference call.
- 2) To hang up, press **speaker** or return the corded handset to the base. The handset will still be connected to the call.

### From the handset

- 1) While in talk mode with the base, press **talk/flash** on the handset to join the call.
- 2) To hang up, return the handset to the cradle or press **end** on the handset. The base will still be connected to the call.

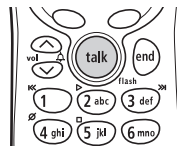
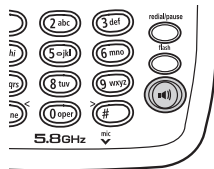

- You can record a conference call. For details, please see "Recording a conversation" on page 47.
- During a conference call with the handset, you can receive a waiting call by pressing **talk/flash** on the handset.



- If the party is busy or out of range, the handset returns to standby mode.
- If the party does not answer within one minute, the operation is canceled.

## Intercom

The intercom feature lets you communicate between the handset and base without using the phone line.

### Making an Intercom Page

#### From the handset

- 1) With the phone in standby mode, press ***select/int'com***.
- 2) The base will be paged. An intercom tone sounds.  
To cancel intercom, press ***select/int'com, end*** or return the handset to the cradle.



Paging Base

#### From the base

- 1) With the phone in standby mode, press ***find hs/intercom*** on the base.
- 2) The handset will be paged. An intercom tone sounds.  
To cancel intercom, press ***find hs/intercom*** or  (***speaker***).



Paging Handset

### Making an Intercom Page While the Line is on Hold

You can make an intercom call while an outside caller is on hold; making an intercom call will not terminate the call on hold.

#### From the handset

- 1) During a call, press ***select/int'com*** on the handset.
- 2) The call will automatically be placed on hold, and the paging tone sounds.  
To cancel the page, press ***talk/flash***, or ***select/int'com***.

### From the base

- 1) During a call, press **hold** on the base. The call will be put on hold.
- 2) Press **find hs/intercom**. The paging tone sounds.
- 3) To cancel the page from:
  - Speakerphone: press **📞 (speaker)** or **find hs/intercom**.
  - Corded base: press **find hs/intercom**.

### Answering an Intercom Page

#### From the handset

- 1) Pick up the handset from the cradle. (If AutoTalk is enabled, the handset will automatically answer when you pick it up.)
- 2) Press **talk/flash** or **select/int'com**.

OR

- 1) If the handset is off the cradle, press **talk/flash, select/int'com** or any number key (AutoTalk is on.)

#### From the base

Pick up the corded handset. To answer with the base speakerphone, press

**📞 (speaker)**, or **find hs/intercom**.

To hang up an intercom page:

- From the handset: press **end, select/int'com** or return the handset to the cradle.
- From the base: with the base speakerphone, press **find hs/intercom** or **📞 (speaker)**.

With the corded base handset, return the corded handset to the base.



When editing the speed dial memory, you must press a key within 30 seconds or the phone will return to standby mode.

## Using the Speed Dial Memory

The speed dial memory allows you to store up to 10 names and numbers in the handset and base. The speed dial memory is stored independently in the base and handset. You can store up to 10 numbers in the base and up to 10 numbers in the handset. You can dial these numbers with just a few key presses.

The speed dial memory is not limited to phone numbers. You can store any number (up to 20 digits) that you need to enter once your call connects. This is referred to as Chain Dialing. For example, you can save your bank account number to speed dial memory. When you call your bank's telephone teller service and are prompted to enter your account number, simply press **memory (mem** on the base) and the speed dial number where you stored your account number. Then press **select/int'com (set** on the base).

### Storing Names and Numbers in Speed Dial Memory

- 1) With the phone in standby mode, press **memory (mem** on the base).
- 2) Enter **0-9** to select the speed dial number where you would like to store this entry. You can also scroll through the list with the volume up or down key (**^/v/Δ/volume** or **^/v/Δ/select/volume**). Press **select/int'com (set** on the base) twice.
- 3) **Store Name** appears and a cursor flashes indicating that the display is ready for the name to be entered.

```
Select Memory
1  JOHN DOE
2
```

```
Store Name
█
```

If the selected speed dial number is already assigned, the Edit screen appears. You can select **Edit** to edit this entry, select **Delete** to erase this entry, or select **Go Back** to choose another speed dial number.



```

Edit Memory 1
Delete Memory 1
Go Back
  
```

4) Enter a name according to the instructions below.

- The name can be up to 14 characters.
- Use **#/>** and **\*/tone/<** keys to move the cursor to the desired location.
- Use **delete/channel** (∅ **delete** on the base) to delete characters as needed.
- Press and hold **delete/channel** (∅ **delete** on the base) to delete all the characters.
- If no name is required, go to step 5.

Refer to the letters on the number keys to select the desired characters.

Each time you press a numeric key, the displayed character appears in the following order: Upper case letters first, lower case letters next and finally the number corresponding to the key.

### If you make a mistake while entering a name

Use **\*/tone/<** or **#/>** to move the cursor to the incorrect character.

Press **delete/channel** (∅ **delete** on the base) to erase the wrong character. Then enter the correct character. To delete all characters, press and hold **delete/channel** (∅ **delete** on the base).



If the next character uses the same number key, you must press the **#/>** key to move the cursor over. Otherwise the next time you press the number key, it changes the character that was previously set.

For example, to enter **Movies**.

- 1) Press **6**. Then press **#/>** to move the cursor to the right.
- 2) Press **6** six times.
- 3) Press **8** six times.
- 4) Press **4** six times.
- 5) Press **3** five times.
- 6) Press **7** eight times.

	Number of times key is pressed								
keys	1	2	3	4	5	6	7	8	9
1	1								
2 abc	A	B	C	a	b	c	2		
3 def	D	E	F	d	e	f	3		
4 ghi	G	H	I	g	h	i	4		
5 jkl	J	K	L	j	k	l	5		
6 mno	M	N	O	m	n	o	6		
7 pqrs	P	Q	R	S	P	q	r	s	7
8 tuv	T	U	V	t	u	v	8		
9 wxyz	W	X	Y	Z	w	x	y	z	9
0 oper	*	#	-	&	<	>	(blank)	0	

- 5) Press **select/int'com** (**set** on the base). Store Number is displayed. The cursor flashes indicating that the display is ready for the number to be entered.

Store Number █

- 6) Use the keypad to enter the phone number; each number can be up to 20 digits.  
If you need the phone to pause during the dialing sequence, press **redial/pause** to insert a two-second delay between the numbers. You can enter multiple pauses to increase the delay. Each pause counts as a digit. The display shows a P for every pause.

Store Number  
8007303456 █

- 7) Press **select/int'com** (**set** on the base). You will hear a confirmation tone, and the following screen appears. Memory storage is complete. After about 2 seconds, the following screen displays all the speed dial memory entries.

Memory 1 Stored



- 8) Press **end** (▷/□ (**play/stop**) on the base) to exit memory setup mode. The phone returns to standby.

```

1▶ Movies
2 JOHN DOE
3 MOM AND DAD
    
```



You can not store a Caller ID message if no phone number appears in the message.

## Storing Caller ID data in Speed Dial Memory

Data (Caller ID names/numbers) shown in the Caller ID list can be stored in memory dialing. For instructions on viewing the Caller ID data, see page 35.

- 1) Press **call id/menu** (**call id** on the base). Select the phone number to be stored from the Caller ID list by pressing the volume up or down key (**^/∇/▲/volume** or **^/∇/▲/select/volume**).

```

5/17 12:30PM 03
Jane Smith
214-555-1234
    
```

- 2) Press **memory** (**mem** on the base).

```

Select Memory
1▶
2 JOHN DOE
    
```

- 3) Enter a number (**0 - 9**) or press the volume up or down key (**^/∇/▲/volume** or **^/∇/▲/select/volume**) to select the memory location to be stored.

```

5/17 12:30PM 03
Jane Smith
214-555-1234
    
```

- 4) Press **select/int'com** (**set** on the base). You hear a confirmation tone, and the number is stored in memory. The display returns to the Caller ID data.



If you want to directly access the speed dial location, press and hold **0-9** in standby mode, and then press **talk/flash** (🔊) (**speaker**) on the base) or remove the corded handset from the base.



If a message has already been stored in the selected memory number location, a confirmation screen is displayed. Press the volume up key ( **^/▲/volume** or **^/▲/select/volume**) to select **Yes**. Press **select/int'com** (**set** on the base) to overwrite. The display returns to the Caller ID data.

```
Replace Memory?  
Yes  
▶ No
```

## Making Calls from Speed Dial Memory

- 1) Press **memory** (**mem** on the base). The handset or base displays your programmed speed dial number.
- 2) Enter the number (**0 - 9**), or press the volume up or down key ( **^/▼/▲/volume** or **^/▼/▲/select/volume**) to select the speed dial number you would like to dial.
- 3) Press **talk/flash** (🔊) (**speaker**) on the base) or remove the corded handset from the base. Then the displayed number is dialed.

```
Select Memory  
1▶ Movies  
2 JOHN DOE
```

```
TTTTT  
Talk  
8007303456
```

## To cancel speed dialing

Press **end** (▶/□) (**play/stop**) on the base) to cancel speed dialing. The phone returns to standby mode.

Also, if the phone is idle (e.g., no key is pressed) for 30 seconds, the phone returns to standby mode.

# Caller ID and Caller ID on Call Waiting (CIDCW)

**You must subscribe to Caller ID service through your local telephone provider to use this feature.** When the telephone rings, the Caller ID feature allows you to view the caller's name, phone number, date and time of call. The Caller ID data stores information for up to 50 incoming calls - even unanswered calls. With Caller ID on Call Waiting (CIDCW), you will hear a Call Waiting tone while you are on a call, and the Caller ID data is displayed. To accept the waiting call, press **talk/flash** (**flash** on the base) (see page 22).

Additionally, you can dial a number stored in the Caller ID list or save data to your Memory dial list.

## When the Telephone Rings

When the Caller ID data is received, each the handset and base shows the caller's phone number along with the date and time. The incoming call information is stored in the Caller ID record on both the handset and base. If the Caller ID service includes the caller's name, the caller's name appears on the display (up to 15 letters).

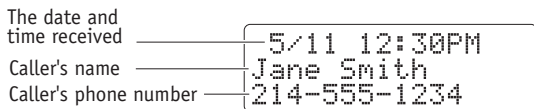

You may receive any one of the following messages:

When invalid data is received;	Incomplete Data
When a private name is received;	Private Name
When a private number is received;	Private Number
When an unknown name is received;	Unknown Name
When an unknown number is received;	Unknown Number



- If you answer a call before the Caller ID data is received (for example, before the second ring), the Caller ID data will not appear.
- When the call is received via a telephone company that does not offer Caller ID service (including international calls), the caller's phone number and name do not appear.
- When the call is via a private branch exchange (PBX), the caller's phone number and name may not appear.



- In Caller ID operation, if no key is pressed for more than 30 seconds, an error tone sounds and the telephone returns to standby mode.
- Each data can be up to 15 characters for the name and 15 digits for the phone number.
- The number of calls from the same Caller ID appears next to the received time. Once you view the new data, the number will be cleared.



Data errors appear as "■."

## Viewing the Caller ID Data

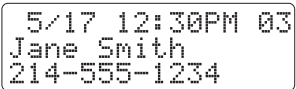
- 1) With the phone in standby mode, press **call id/menu** (**call id** on the base).  
The summary screen appears. The screen shows the number of new messages and total messages.
- 2) To view the Caller ID data in historical order (from new to old or from old to new), use the volume down key (**∇/∆/volume** or **∇/∆/select/volume**) to scroll through the data from the latest to the earliest, or the volume up key (**∧/∆/volume** or **∧/∆/select/volume**) to scroll back through the messages.
- 3) To finish the viewing operation:  
From Handset - press **end**.  
From Base - press **▷/□ (play/stop)**.

## Deleting Data from the Caller ID List

The cordless phone stores up to 50 Caller ID names/numbers. If the phone receives the 51st Caller ID, the oldest one in the list is automatically deleted. Caller ID data can also be deleted manually.

### Deleting a Caller ID Data

1) Press **call id/menu** (*call id* on the base) in standby mode. Find the message to be deleted from the Caller ID list by pressing the volume up key or the volume down key (**^/∇/△/volume** or **^/∇/△/select/volume**).

```
5/17 12:30PM 03  
Jane Smith  
214-555-1234
```

2) Press **delete/channel** (**∅ delete** on the base).

3) Press the volume up key or the volume down key (**^/∇/△/volume** or **^/∇/△/select/volume**) to select **Yes**, and then press **select/int'com** (**set** on the base).

```
Delete Message?  
▶ Yes  
No
```

### Deleting all Caller ID names/numbers

1) With the phone in standby mode, press **call id/menu** (*call id* on the base).

2) Press **delete/channel** (**∅ delete** on the base).

```
Caller ID  
New :01  
Total:02
```

note

- While using the **Delete All?** or **Delete Message?** screen, if no key is pressed for more than 30 seconds, an error tone sounds, and the phone returns to standby mode.
- If you get an incoming call or intercom page, the deleting operation is canceled, and you can answer the call or intercom page.

- 3) Press the volume up key or the volume down key to select **Yes**, and then press **select/int'com** (**set** on the base). You hear a confirmation tone and all stored Caller ID data are deleted.

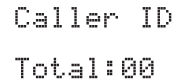

Caller ID  
Total:00

## Making a Call from the Caller ID Data

You can place a call from the Caller ID data.

- 1) Press **call id/menu** (**call id** on the base) in standby mode. Select the phone number that you want to dial by pressing the volume up key or the volume down key (**^/v/Δ/volume** or **^/v/Δ/select/volume**).
- 2) To have the phone dial a 1 before the displayed Caller ID number for setting the long distance call, press **1**. To have the phone dial the stored area code before the displayed Caller ID number, press **3**.
- 3) Press **talk/flash** (**speaker**) on the base) or remove the corded handset from the base. The displayed phone number dials automatically.



5/17 12:30PM 03  
Jane Smith  
214-555-1234



You cannot make a call from the Caller ID list if your cordless phone is connected to a private branch exchange (PBX).

# The Integrated Answering Device

The phone has a built-in answering system that answers and records incoming calls. You can also use your answering system to record a conversation, leave a voice memo message, or announce a special outgoing message to callers when you're away from your phone.

## Features

- Digital Tapeless Recording
- Up to 13 minutes of Recording Time
- Call Screening
- Personal or Prerecorded Outgoing Messages
- Trilingual Display Options and Voice Prompts (English, Spanish, or French)
- Time and Day Announcement
- Remote Message Retrieval
- Toll Saver
- Conversation Recording
- Voice Memo
- Message Alert On/Off
- Retrieve TAD Messages using Handset



- For your convenience, voice prompts will guide you through the menu mode.
- Press **clock/menu** or **▷/◻ (play/stop)** on the base to return to standby mode.
- If you do not press a key within 30 seconds, the phone will time out and exit the menu mode.

## Setting Up the Answering Machine

### Setting the Record Time

Record Time sets the duration for recording the incoming messages. You have three record time options. The options `1 Minute` or `4 Minutes` set the duration for recording the incoming messages. `Announce only` answers the call but prevents the caller from leaving a message.

- 1) Press **clock/menu** and the volume down key on the base to select `Record Time`, and then press **set**.
- 2) Press the volume up or down key to select `Record Time` `1 Minute`, `4 Minutes`, or `Announce Only`.
- 3) Press **set**. You will hear a confirmation tone.

```
Record Time:|
              |
              | 1 Minute
              |
Press v/∧ or set
```

### Setting the Call Screen

Call Screen allows you to listen to the incoming message being left by the caller before you answer the call.

- 1) Press **clock/menu** and the volume down key on the base to select `Call Screening`, and then press **set**.
- 2) Press the volume up or down key to select `On` or `Off`.
- 3) Press **set**. You will hear a confirmation tone.

```
Call Screening:|
                |
                | On
                |
Press v/∧ or set
```



## Setting the Ring Time

Ring Time allows you to set the number of rings the caller hears before your answering system plays the outgoing message. You can set the ring time to answer after two, four, or six rings. If you enable the Toll Saver, the answering system picks up after two rings if you have new messages and after four rings if there are none.

- 1) Press **clock/menu** and the volume down key on the base to select **Ring Time**, and then press **set**.
- 2) Press the volume up or down key to select a Ring Time (Toll Saver, 2 Times, 4 Times, or 6 Times).
- 3) Press **set**. You will hear a confirmation tone.

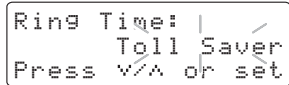

Ring Time: |  
Toll Saver  
Press v/Δ or set

## Setting the Message Alert On or Off

Message Alert sounds an alert tone when you have an unheard message. If you set the Message Alert on, whenever a new message is received, the soft alert tone will sound every 15 seconds. When all messages have been played back, the alert tone automatically deactivates.

- 1) Press **clock/menu** and the volume down key on the base to select **Message Alert**, and then press **set**.
- 2) Press the volume up or down key to select **On** or **Off**.
- 3) Press **set**. You will hear a confirmation tone.

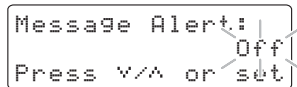

Message Alert: |  
Off  
Press v/Δ or set

## Turning the message alert tone off by pressing any key

To quickly turn off the Message Alert tone, press any key on the base unit; the tone will automatically deactivate.



When the answering system is full, FL appears on the LCD. You should delete some messages so that the system can record new messages.

## Setting a Security Code (PIN Code)

Security code selects a two-digit Personal Identification Number (PIN) code. A PIN code is required to play your messages from a remote location.

- 1) Press **clock/menu** and the volume down key on the base to select **Security Code**, and then press **set**.
- 2) Enter a two-digit PIN code (**01-99**) using the number keypad. To change the number, use **∅ delete** to backspace.
- 3) Press **set**. You will hear a confirmation tone.

Security Code:    
Press 0-9 or set

## Turning the Answering System On/Off

- 1) To turn the answering system on, press **answer on/off** on the base when the phone is in standby mode. The answer on/off LED will be illuminated. If the message LED flashes, then there are new messages waiting for you.
- 2) To turn the answering system off, press **answer on/off** on the base. The answer on/off LED will no longer be illuminated. To turn the answering system back on, press **answer on/off**.

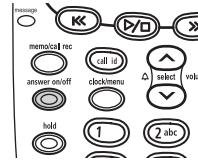

# Setting Your Outgoing Message (Greeting)

When you receive a call, the answering system automatically plays either the pre-recorded message or your own greeting.  
The following message is pre-recorded: "Hello, no one is available to take your call. Please leave a message after the tone."

## Record a Personal Outgoing Message

Record Greeting allows you to record a personal outgoing message (greeting) which the answering system automatically plays when you receive a call.

- 1) Press ***greeting***. While the pre-recorded message is playing, press and hold ***greeting*** again.  
You hear the announcement "Record greeting" and a confirmation tone.

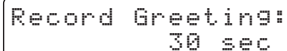

Record Greeting:  
30 sec

If your own greeting has already been recorded, delete the current message and then record a new greeting again. While the current personal outgoing message is playing, press  $\emptyset$  ***delete***. And then start over with the first.

- 2) Start recording your message. You have 30 seconds, and the message counter starts to count down.
- 3) When you are finished recording your greeting, press ***greeting***,  $\triangleright/\square$  (***play/stop***) or ***set***. You hear a confirmation tone, and then your greeting plays back for you.



note

- Position yourself as near to the base as possible and speak clearly when recording your outgoing message.
- If you make an outside call or a call is received during the operation, the operation is canceled.
- The greeting must be more than two seconds long, or it will not be recorded.
- To delete the personal outgoing message, press  $\emptyset$  ***delete*** while the message is playing. The system announces "Greeting has been deleted."

## Selecting Your Greeting

With the phone in standby mode, press ***greeting***. Then press ***greeting*** again while the outgoing message is played. This switches between the prerecorded greeting and the personal greeting. After finishing playing back the message, a confirmation tone is heard.

## Announce only feature

The announce only feature plays a pre-recorded outgoing message or your own personal outgoing message, but it will not allow the caller to leave a message. To set announce only, follow the steps on “Setting the Record Time” page 39. If you want to use your own greeting and you want to change your greeting to omit the prompt to leave a message, refer to “Selecting Your Greeting” above.

The following message is pre-recorded:

“Hello, no one is available to take your call. Please call again.”

## Using Your Answering System

The message counter displays the number of messages stored in memory. If the message LED flashes, then there are new messages waiting for you. The answering system is designed to play your new messages first. After you play all your new messages, you can then play your old messages.

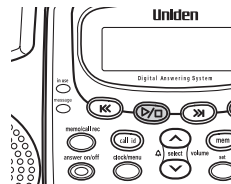

## Playing your messages

- 1) With the phone in standby mode, press  $\triangleright/\square$  (**play/stop**).  
The system announces the number of new and old messages while the message counter displays only the number of new messages. The time and day that each message was received is announced after the message is played. The message counter will then display the number of current stored messages.
- 2) When all new messages have been played, you hear a confirmation tone, and the system announces "End of messages." The system returns to standby.
- 3) After you have reviewed your new messages, you can play your old messages by pressing  $\triangleright/\square$  (**play/stop**) again. Once you have listened to a new message, it then becomes an old message. The old messages will be played in the order in which they were received.

## Repeating a message

- 1) Press  $\triangleright/\square$  (**play/stop**) to review your messages. The number of stored messages is announced.
- 2) To repeat the current message, press  $\lll$  (**repeat/rewind**) after a few seconds of beginning the message. To quickly scroll backwards through a message, press and hold  $\lll$  (**repeat/rewind**). To repeat the previous message, press  $\lll$  (**repeat/rewind**) within about four seconds after a message begins playing. If you have several messages, press  $\lll$  (**repeat/rewind**) repeatedly until you return to the message you want to replay. If the current message is the first new message, the system plays back from the beginning of the current message (it does not go back into the old message group).
- 3) Press  $\triangleright/\square$  (**play/stop**) at any time to stop reviewing messages and return to standby. The message counter shows the number of messages stored in memory.

## Skipping a message

- 1) Press  $\triangleright/\square$  (**play/stop**) to review your messages. The number of stored messages is announced.
- 2) Press  $\gg|$  (**skip/forward**) at anytime to skip to the next message.  
Each time  $\gg|$  (**skip/forward**) is pressed, the system scans forward one message. If you have several messages, press  $\gg|$  (**skip/forward**) repeatedly to find the message you want to play. To quickly scroll through a message, press and hold  $\gg|$  (**skip/forward**).
- 3) Press  $\triangleright/\square$  (**play/stop**) at anytime to stop reviewing your messages and return to standby. The message counter shows the number of messages stored in memory.

## Deleting a message

To maintain maximum record time, delete the old messages. When you press  $\emptyset$  **delete**, you are permanently deleting the message. Once deleted, the message cannot be replayed or retrieved.

- 1) Press  $\triangleright/\square$  (**play/stop**) to review your messages.
- 2) Press  $\emptyset$  **delete** at anytime during the message to delete the message.
- 3) To delete all messages, with the phone in standby mode, press  $\emptyset$  **delete**. After the announcement "To delete all messages, press delete again," press  $\emptyset$  **delete** again.

When you try to delete all messages without first listening to your new messages, you hear several short beeps followed by an announcement "Please playback all messages." This protects you from accidentally erasing messages you have not yet reviewed.

## Voice memo

The voice memo function allows the user to record messages (more than two seconds and less than four minutes).

- 1) With the phone in standby mode, press and hold **memo/call rec** on the base.
- 2) You will hear the announcement "Record Memo Message" and a confirmation tone.
- 3) Start your recording.
- 4) When you have finished, press **▶/□ (play/stop)**, **memo/call rec** or **set** to stop recording. The system returns to standby.



- The voice memo messages are recorded as an incoming messages.
- When the answering system is full, FL appears on the display, and the system returns to standby.



- If the recording memory is full, you can not record a conversation until you clear some messages from the memory.
- Every state has different regulations governing the recording of conversations over the telephone. Make sure to check your local, state and federal laws before using this product to record any telephone conversation in order to determine that your use is in compliance with such laws or guidelines.
- You can not record intercom conversations.
- To activate this feature, you must turn the Call Screen feature on. See "Setting the Call Screen" on page 39.

## Recording a conversation

You can record a conversation from the handset or the base (more than two seconds and less than ten minutes).

- 1) During a conversation, press **rec/remote/call screen** on the handset or press and hold **memo/call rec** on the base.
- 2) Recording a Call appears on the display. A confirmation tone that can be heard by both parties sounds during recording.
- 3) To stop recording, press **rec/remote/call screen** on the handset, or **memo/call rec** or **▷/□ (play/stop)** on the base.

## Screening a call

### From the base

To screen an incoming call, use the following steps:

- 1) After the answering system answers, the base speaker will let you hear the calls as the machine records the message. To adjust the volume, press the volume up or down key. If you turn the answering system off, you cannot screen a call.
- 2) To answer the call, pick up the corded handset or press **📞 (speaker)** on the base. To mute the Call Screen, press **mute** or **▷/□ (play/stop)**. To cancel muting, press **^/▽/△/select/volume**.

### From the handset

Press **rec/remote/call screen** when the system is answering. To cancel the Call Screen, press **end** or return the handset to the cradle. To answer the call, press **talk/flash** or any number (when AutoTalk is set to on). The answering system will disconnect automatically.



# Remote Operation

You can operate your answering system from a remote location (when you are away from home, or from another room using the handset). Use this function to check for recorded messages, to play or delete message. When using any touch-tone telephone, you can even record a new greeting message.

## Remote access with any touch-tone telephone

You can operate your answering system from a remote location using any touch-tone telephone.

- 1) Call your telephone number.
- 2) During the greeting message, press **0** and enter your PIN code (see page 41).
- 3) The answering system announces the current time and the number of messages stored in memory. Then you hear "To play incoming messages, press zero two. For help, press one zero."
- 4) You may continue to listen to the voice prompts, or you may select a command from the chart on the next page:



For your convenience remote operation cards are provided for you to use while away from home (located on page 62).



Once you enter the remote access menu, you must enter a command within 15 seconds, or the answering system automatically hangs up and returns to standby.

Command	Function	Command	Function
<b>0 then 1</b>	Repeat a Message	<b>0 then 6</b>	Answering System On
<b>0 then 2</b>	Play incoming Messages	<b>0 then 7</b>	Memo Record/Stop*
<b>0 then 3</b>	Skip a Message	<b>0 then 8</b>	Greeting Message Record/Stop*
<b>0 then 4</b>	Delete a Message	<b>0 then 9</b>	Answering System Off
<b>0 then 5</b>	Stop Operation	<b>1 then 0</b>	Voice Prompts

\* For Memo Record and Greeting Message Record function, the first time you enter the corresponding command, it starts the Recording function. If you want to stop the recording, enter the command again.

- 5) After all of the voice prompts have been played, you hear intermittent beeps indicating that the system is in the command waiting mode. You may enter another command at this time from the chart.
- 6) When you are finished, hang up to exit the system. The answering system automatically returns to standby.

## Turn on the Answering System Remotely

If you have forgotten to turn on your answering system, you can turn it on remotely from any touch-tone telephone.

- 1) Call your telephone number.
- 2) Wait ten rings until the system answers. You hear intermittent beeps.
- 3) Press **0** and then enter your PIN code. The answering system announces the number of messages stored in memory. You hear "To play incoming messages, press zero two. For help, press one zero."
- 4) Press **0** then **6** to turn the answering system on. You hear the outgoing message and a confirmation tone.
- 5) Hang up the phone; subsequent calls will be answered by the system.

## Remote Access with the Handset

You can operate your answering system from another room using a handset.

- 1) With the phone in standby mode, press **rec/remote/call screen** on the handset. Remote AnsweringMachine operation appears on the display. The answering system announces the current time and the number of messages stored in the memory.
- 2) You hear "To play incoming message, press two. For help, press zero" followed by intermittent beeps.

3) Enter a command within 15 seconds. You may select a command from the following chart:

Command	Function	Command	Function
⏪/1	Repeat a Message	□/5	Stop Operation
▷/2	Play incoming Messages	6	Answering System On
≫/3	Skip a Message	9	Answering System Off
∅/4	Delete a Message	0	Voice Prompts

4) After the command has finished, you hear intermittent beeps indicating that the system is in the command waiting mode. You may enter another command at this time from the chart above.

5) When you are finished, press **end** to exit the system. The answering system automatically returns to standby.



- If the handset can't access the base within seven seconds, you will hear beeps, and the phone will return to standby.
- The base's keypad is disabled during remote operation.
- If you receive a call, the remote operation is canceled.
- If you have new messages and old messages, only the new messages will be played. After you have reviewed your new messages, you can play your old messages by pressing the ▷/2 key again.

# Note on Power Sources

## Power Failure

During the period that the power is off, you can make or receive calls with the base. You cannot use the base speaker phone or the cordless handset.

## Low battery alert

When the battery pack is very low and needs to be charged, the handset is programmed to eliminate functions in order to save power. If the handset is not in use, `Low Battery` appears on the handset LCD and none of the handset keys will operate.

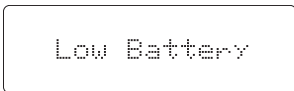

If the phone is in use, `Low Battery` flashes and the handset beeps. Complete your conversation as quickly as possible and return the handset to the cradle for charging.



Information stored in the phone's memory will be retained for 30 minutes after the battery pack is removed. This includes earpiece volume, ringer tone and volume and last number dialed.

Even when the battery pack is not being used, it will gradually discharge over a long period of time. For optimum performance, be sure to return the handset to the cradle after a telephone call.

## Battery replacement and handling

When the operating time becomes short even after a battery is recharged, please replace the battery. With normal usage, your battery should last about one year. A replacement battery may be purchased by calling Uniden's Parts Department (see back cover page).

## Warning:

To avoid the risk of personal injury or property damage from fire or electrical shock, only use the Uniden battery model and Uniden adapter model specifically designated for this product.

### Caution

- Use only the specified Uniden battery pack (BT-905).
- Do not remove the batteries from the handset to charge it.
- Never throw the battery into a fire, disassemble it, or heat it.
- Do not remove or damage the battery casing.

## Cleaning the battery charging contacts

To maintain a good charge, clean the charging contacts on the handset and charger once a month.

Dampen a cloth with plain water. Gently rub the damp cloth over the charging contacts until all visible dirt is removed. Dry the contacts thoroughly before returning the handset to the cradle.

### Caution

Do not use paint thinner, benzene, alcohol, or other chemical products. Doing so may discolor the surface of the telephone and damage the finish.

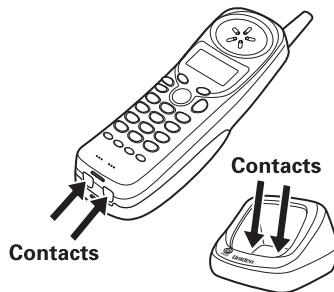

# General Information

The phone complies with FCC Parts 15 and 68.

Operating temperature: -10 °C to +50 °C (+14 °F to +122 °F)

## AC Adapter Information

	(For the base)	(For the charging cradle)
AC Adapter part number:	AD-830	AD-310
Input Voltage:	120 AC 60Hz	120V AC 60Hz
Output Voltage:	9V DC 400mA	9V DC 210mA

## Battery Information

Battery part number:	BT-905
Capacity:	600mAh, 3.6V

## Frequency

925.181424 - 927.451379 MHz  
5739.320225 - 5746.130091 MHz

- **To avoid damage to the phone use only Uniden AD-830, AD-310 and BT-905 with your phone.**
- If the handset is left off of the cradle, the actual Talk mode duration will be reduced respective to the amount of time the handset is off the cradle.

Recharge your phone on a regular basis by returning the handset to the cradle after each phone call. When the operating time becomes short, even after the battery is recharged, please replace the battery. With normal usage, the battery should last about one year.

A replacement Uniden adapter or battery may be purchased by calling Uniden's Parts Department (see back cover page).

Specifications, features, and availability of optional accessories are all subject to change without prior notice.

# Troubleshooting

If your phone is not performing to your expectations, please try these simple steps first.

Symptom	Suggestion
The charge LED won't illuminate when the handset is placed in the cradle.	<ul style="list-style-type: none"><li>• Make sure the AC adapter is plugged into the cradle and wall outlet.</li><li>• Make sure the handset is properly seated in the cradle.</li><li>• Make sure the charging contacts on the handset and charger are clean.</li></ul>
The audio sounds weak and/or scratchy.	<ul style="list-style-type: none"><li>• Move the handset and/or base away from metal objects or appliances and try again.</li><li>• Press <b>delete/channel</b> in the Talk mode to help eliminate background noise.</li><li>• Make sure that the handset is not too far from the base.</li></ul>
Can't make or receive calls.	<ul style="list-style-type: none"><li>• Check both ends of the telephone line cord.</li><li>• Make sure the AC adapter is plugged into the base and wall outlet.</li><li>• Disconnect the AC adapter for a few minutes. Then reconnect it.</li><li>• Make sure that the handset is not too far from the base.</li><li>• Check the dialing mode used by your telephone company.</li></ul>
During power failure, can't make or receive a call.	<ul style="list-style-type: none"><li>• Make sure to use corded handset to make or receive a call.</li><li>• Make sure that TEL line cord is connected firmly.</li></ul>
The handset doesn't ring or receive a intercom page.	<ul style="list-style-type: none"><li>• The battery pack may be weak. Charge the battery for 15-20 hours.</li><li>• The handset may be too far from the base unit.</li><li>• Place the base unit away from appliances or metal objects.</li><li>• Check the battery pack to ensure there is a secure connection.</li><li>• Make sure ringer volume isn't set to turned "off."</li></ul>



Symptom	Suggestion
Severe noise interference.	<ul style="list-style-type: none"> <li>• Keep the handset away from microwave ovens, computers, remote control toys, wireless microphones, alarm systems, intercoms, room monitors, fluorescent lights, and electrical appliances.</li> <li>• Move the base to another location or turn off the source of interference.</li> </ul>
The Caller ID does not display.	<ul style="list-style-type: none"> <li>• The call was answered before the second ring.</li> <li>• The call was placed through a switchboard.</li> <li>• Your Caller ID service may not be active; contact your local telephone service provider.</li> </ul>
The answering system does not work.	<ul style="list-style-type: none"> <li>• Make sure the AC adapter is plugged into wall outlet.</li> <li>• Make sure the answering system is turned on.</li> </ul>
The answering system does not record any messages.	<ul style="list-style-type: none"> <li>• Set the record time to either the one minute or four minute option.</li> <li>• The memory may be full. Delete some or all of the saved messages.</li> </ul>
Messages are incomplete.	<ul style="list-style-type: none"> <li>• The incoming messages may be too long. Remind callers to leave a brief message.</li> <li>• The memory may be full. Delete some or all of the saved messages.</li> </ul>
After a power failure, the outgoing message is deleted.	<ul style="list-style-type: none"> <li>• Record your personal outgoing message again. The default message should remain.</li> </ul>
No sound on the base unit speaker during call monitoring or message playback.	<ul style="list-style-type: none"> <li>• Adjust the speaker volume on the base unit.</li> <li>• Make sure the call screen feature is set to on.</li> </ul>
Cannot access remote call-in features from another touch tone phone.	<ul style="list-style-type: none"> <li>• Make sure you're using the correct PIN code.</li> <li>• Make sure that the touch-tone phone you're using can transmit the tone for at least two seconds. If it cannot, you may have to use another phone to access your phone.</li> </ul>

# Liquid Damage

Moisture and liquid can damage your cordless phone. In case of accidental submersion, please follow these steps.

Case	Action
If the handset or base is exposed to moisture or liquid, but only affects the exterior plastic housing.	Wipe off the liquid, and use as normal.
If moisture or liquid has entered the plastic housing (i.e., liquid can be heard in the phone or liquid has entered the handset battery compartment or vent openings on the base).	<p><b>Handset:</b></p> <ol style="list-style-type: none"><li>1)Remove the battery cover and leave it off for ventilation.</li><li>2)Remove the battery pack by disconnecting.</li><li>3)Leave the battery cover off and the battery pack disconnected for at least 3 days.</li><li>4)Once the handset is completely dry, reconnect the battery pack and the battery cover.</li><li>5)Recharge the handset's battery pack for 20 hours before using again.</li></ol> <p><b>Base:</b></p> <ol style="list-style-type: none"><li>1)Disconnect the AC adapter from the base unit, cutting off electrical power.</li><li>2)Disconnect the telephone cord from the base unit.</li><li>3)Let dry for at least 3 days.</li></ol> <p><b>IMPORTANT:</b> You must <b>unplug the telephone line while recharging the battery pack</b> to avoid charge interruption.</p> <p><b>CAUTION:</b></p> <p>DO NOT use a microwave oven to speed up the drying process. This will cause permanent damage to the handset, base and the microwave oven.</p> <p>After following these steps, if your cordless telephone does not work, please call our Customer Service Hotline at 1-800-297-1023.</p>

## Precautions!

Before you read anything else, please observe the following:

### Warning!

Uniden America Corporation DOES NOT represent this unit to be waterproof. To reduce the risk of fire, electrical shock, or damage to the unit, DO NOT expose this unit to rain or moisture.

## Rechargeable Nickel-Cadmium Battery Warning

- This equipment contains a rechargeable nickel-cadmium battery.
- Cadmium is a chemical known to the State of California to cause cancer.
- The rechargeable nickel-cadmium battery contained in this equipment may explode if disposed of in a fire.
- Do not short-circuit the battery.
- Do not charge the rechargeable nickel-cadmium battery used in this equipment in any charger other than the one designed to charge this battery as specified in the owner's manual.
- Using another charger may damage the battery or cause the battery to explode.

## Rechargeable Nickel-Cadmium Batteries Must Be Recycled or Disposed of Properly

- Uniden voluntarily participates in an RBRC® industry program to collect and recycle nickel-cadmium batteries at the end of their useful life, when taken out of service within the United States.
- The RBRC® program provides a convenient alternative to placing used nickel-cadmium batteries into the trash or municipal waste stream, which is illegal in some areas.
- Through the RBRC® program, Uniden makes it easy for you to drop off the used battery at local retailers of replacement nickel-cadmium batteries. You may also contact your local recycling center for information on where to return the used battery. Please call 1-800-8-BATTERY for information on Ni-Cd battery recycling in your area. Uniden's involvement in this program is part of its commitment to protecting our environment and conserving natural resources.
- RBRC® is a registered trademark of the Rechargeable Battery Recycling Corporation.



The exclamation point within an equilateral triangle is intended to alert the user to the presence of important operating and maintenance (servicing) instructions in the literature accompanying the appliance.

Uniden works to reduce lead content in our PVC coated cords in our products and accessories.

### Warning!

The cords on this product and/or accessories contain lead, a chemical known to the State of California to cause birth defects or other reproductive harm. **Wash hands after handling.**

## Important Safety Instructions

When using your telephone equipment, these basic safety precautions should always be followed to reduce the risk of fire, electrical shock, and injury to persons:

1. Read and understand all instructions.
2. Follow all warnings and instructions marked on the product.
3. Unplug this product from the wall outlet before cleaning. Use a dry cloth for cleaning without liquid or aerosol cleaners.
4. Do not use this product near water; for example, near a bathtub, wash bowl, kitchen sink or laundry tub, in a wet basement, or near a swimming pool.
5. Do not place this product on an unstable cart, stand, or table. The telephone may fall, causing serious damage to the unit.
6. Slots and openings in the cabinet and the back or bottom are provided for ventilation. To protect the product from overheating, these openings must not be blocked or covered. This product should never be placed near or over a radiator or heat register. This product should not be placed in a built-in installation unless proper ventilation is provided.
7. This product should be operated only from the type of power source indicated on the marking label. If you are not sure of the type of power supply to your home, consult your dealer or local power company.
8. Do not allow anything to rest on the power cord. Do not locate this product where the cord will be damaged by persons walking on it.
9. Do not overload wall outlets and extension cords, as this can result in the risk of fire or electrical shock.
10. Never push objects of any kind into this product through cabinet slots, as they may touch dangerous voltage points or short out parts that could result in a risk of fire or electric shock. Never spill liquid of any kind on the product.
11. To reduce the risk of electric shock, do not disassemble this product. Take it to qualified service personnel when service or repair work is required. Opening or removing covers may expose you to dangerous voltages or other risks. Incorrect reassembly can cause electric shock when the appliance is subsequently used.
12. Unplug this product from the wall outlet and refer servicing to qualified service personnel under the following conditions:
  - A. When the power supply cord is damaged or frayed.
  - B. If liquid has been spilled into the product.
  - C. If the product has been exposed to rain or water.
  - D. If the product does not operate normally when following the operating instructions. (Adjust only those controls that are covered by the operating instructions. Improper adjustment of other controls may result in damage and will often require extensive repair work by a qualified technician.)
  - E. If the product has been dropped or the cabinet has been damaged.
  - F. If the product exhibits a distinct change in performance.
13. Do not use the telephone to report a gas leak in the vicinity of the leak.

## Additional Battery Safety Precautions

**Caution!** To reduce the risk of fire or injury to persons by the battery, read and follow these instructions:

1. Use only the Uniden battery pack specified in the owner's manual.
2. Do not dispose of the battery pack in a fire. The cell may explode. Check the Nickel Cadmium battery disposal package insert for disposal instructions.
3. Do not open or mutilate the battery pack. Released electrolyte is corrosive and may cause damage to the eyes or skin. It may be toxic if swallowed.
4. Exercise care in handling the battery in order not to short the battery with conducting materials such as rings, bracelets, and keys. The battery or conductor may overheat and cause burns.
5. Charge the battery pack provided with or identified for use with this product only in accordance with the instructions and limitations specified in the owners manual provided for this product.
6. Observe proper polarity orientation between the battery pack and battery charger.
7. Batteries must be disconnected and removed from the product before shipment to prevent accidental operation during transport. Any batteries transported with the product must be separately secured and cushioned with any exposed terminals covered to prevent their breakage, leakage, movement within the packaging, or short circuits. Failure to follow these recommendations for shipment may result in serious damage and/or personal injury during transport and may be against the U.S. Department of Transportation (DOT), International Civil Aviation Administration (ICAO), International Air Transport Association (IATA), and/or the International Maritime Organization (IMO) regulations.

### SAVE THESE INSTRUCTIONS!

## Important Electrical Considerations

Unplug all electrical appliances when you know an electrical storm is approaching. Lightning can pass through your household wiring and damage any device connected to it. This phone is no exception.

## The FCC Wants You To Know

Changes or modifications to this product not expressly approved by Uniden, or operation of this product in any way other than as detailed by the owner's manual, could void your authority to operate this product. Your telephone complies with Part 68 of FCC Rules. You must, upon request, provide the FCC registration number and the REN to your telephone company. Both numbers are on the base unit.

**Note:** You must not connect your phone to:

- coin-operated systems
- most electronic key telephone systems

This device complies with part 15 of the FCC rules. Operation is subject to the following two conditions: (1) This device may not cause harmful interference, and (2) This device must accept any interference received, including interference that may cause undesired operation. Privacy of communications, may not be ensured when using this phone.

To insure the safety of users, the FCC has established criteria for the amount of radio frequency energy various products may produce depending on their intended usage. This product has been tested and found to comply with the FCC's exposure criteria. For body worn operation, the FCC RF exposure guidelines were also met when used with the Uniden accessories supplied or designed for this product. Use of other accessories may not ensure compliance with FCC RF exposure guidelines and should be avoided.

## Range

Your new phone is designed to achieve the maximum possible range by transmitting and receiving according to the highest specifications set forth by the FCC. We have rated this phone to operate at a maximum distance with the qualification that the range depends upon the environment in which the telephone is used. Many factors limit range, and it would be impossible to include all the variables in our rating. The Maximum Range rating of this phone is meant to be used as a means of comparison against other range claims.

## Telephone Line Problems

The FCC has granted the telephone company the right to disconnect service in the event that your phone causes problems on the telephone line. Also, the telephone company may make changes in facilities and services which may affect the operation of your unit. However, your telephone company must give adequate notice in writing prior to such actions to allow you time for making necessary arrangements to continue uninterrupted service. If you are having trouble with your telephone service, you must first disconnect your phone to determine if it is the cause of your problem. If you determine that it is the cause, you must leave it disconnected until the trouble has been corrected.

## Radio Interference

Radio interference may occasionally cause buzzing and humming in your cordless handset, or clicking noises in the base. This interference is caused by external sources such as TV, refrigerator, vacuum cleaner, fluorescent lighting, or electrical storm. Your unit is NOT DEFECTIVE. If these noises continue and are too distracting, please check around your home to see what appliances may be causing the problem. In addition, we recommend that the base not be plugged into a circuit that also powers a major appliance because of the potential for interference. Be certain that the antenna on the unit is fully extended when needed.

In the unlikely event that you consistently hear other voices or distracting transmissions on your phone, you may be receiving radio signals from another cordless telephone or other source of interference. If you cannot eliminate this type of interference, you need to change to a different channel.

Finally, it should be noted that some cordless telephones operate at frequencies that may cause interference to nearby TVs and VCRs. To minimize or prevent such interference, the base of the cordless telephone should not be placed near or on top of a TV or VCR. If interference is experienced, moving the cordless telephone farther away from the TV or VCR will often reduce or eliminate the interference.

## More than One Cordless Telephone

If you want to use more than one cordless telephone in your home, they must operate on different channels. Press the channel key to select a channel that provides the clearest communication.

## Cordless Telephone Privacy

Cordless telephones are radio devices. Communications between the handset and base of your cordless telephone are accomplished by means of radio waves which are broadcast over the open airways. Because of the inherent physical properties of radio waves, your communications can be received by radio receiving devices other than your own cordless telephone unit. Consequently, any communications using your cordless telephone may not be private.

## Installation Considerations

### Selecting a Location

Before choosing a location for your new phone, there are some important guidelines you should consider:

- The location should be close to both a phone jack and continuous power outlet. (A continuous power outlet is an AC outlet which does not have a switch to interrupt its power.)
- Keep the base and handset away from sources of electrical noise such as motors or fluorescent lighting.
- Be sure there is sufficient space to fully extend the base antenna.
- The base can be placed on a desk or tabletop or mounted on a standard telephone wall plate.
- You should charge your new phone for 15-20 hours before completing the installation or using the handset.

### Telephone Line Outlets

There are two types of phone outlets:

#### Modular Jack

Most phone equipment available now uses modular jacks. Phone cords are fitted with a molded plastic connector which plugs into this type of jack. If you do not have modular phone jacks, contact your local telephone company for information about their installation.

#### Hardwired Jack

Some equipment is wired directly to a phone jack, and these types of installations require a modular jack converter. This type of installation is not difficult; however, you should contact your Uniden telephone dealer or a telephone supply store for advice about the proper adapter or converter for your particular situation.

### Connecting the Telephone Cords

Consider these safety guidelines before connecting the telephone cords:

Caution!

- *Never install telephone wiring during a lightning storm.*
- *Never touch uninsulated telephone wires or terminals unless the telephone line has been disconnected.*
- *Use caution when installing or modifying telephone lines.*

### Applying Power to the Base

This phone requires an AC outlet, without a switch to interrupt power, and the included AC adapter. To relieve strain on the DC plug when the phone is placed on a desk or table, wrap the power cord around the strain relief notch on the bottom of the base.

*NOTE: Place the power cord so that it does not create a trip hazard, or where it could become chafed and create a fire or other electrical hazards.*

## One Year Limited Warranty

Important: Evidence of original purchase is required for warranty service. **WARRANTOR: UNIDEN AMERICA CORPORATION ("Uniden")** ELEMENTS OF WARRANTY: Uniden warrants, for one year, to the original retail owner, this Uniden Product to be free from defects in materials and craftsmanship with only the limitations or exclusions set out below.

**WARRANTY DURATION:** This warranty to the original user shall terminate and be of no further effect 12 months after the date of original retail sale. The warranty is invalid if the Product is

(A) damaged or not maintained as reasonable or necessary, (B) modified, altered, or used as part of any conversion kits, subassemblies, or any configurations not sold by Uniden, (C) improperly installed, (D) serviced or repaired by someone other than an authorized Uniden service center for a defect or malfunction covered by this warranty, (E) used in any conjunction with equipment or parts or as part of any system not manufactured by Uniden, or (F) installed or programmed by anyone other than as detailed by the owner's manual for this product.

**STATEMENT OF REMEDY:** In the event that the product does not conform to this warranty at any time while this warranty is in effect, warrantor will either, at its option, repair or replace the defective unit and return it to you without charge for parts, service, or any other cost (except shipping and handling) incurred by warrantor or its representatives in connection with the performance of this warranty. Warrantor, at its option, may replace the unit with a new or refurbished unit. **THE LIMITED WARRANTY SET FORTH ABOVE IS THE SOLE AND ENTIRE WARRANTY PERTAINING TO THE PRODUCT AND IS IN LIEU OF AND EXCLUDES ALL OTHER WARRANTIES OF ANY NATURE WHATSOEVER, WHETHER EXPRESS, IMPLIED OR ARISING BY OPERATION OF LAW, INCLUDING, BUT NOT LIMITED TO ANY IMPLIED WARRANTIES OF MERCHANTABILITY OR FITNESS FOR A PARTICULAR PURPOSE. THIS WARRANTY DOES NOT COVER OR PROVIDE FOR THE REIMBURSEMENT OR PAYMENT OF INCIDENTAL OR CONSEQUENTIAL DAMAGES.** Some states do not allow this exclusion or limitation of incidental or consequential damages so the above limitation or exclusion may not apply to you.

**LEGAL REMEDIES:** This warranty gives you specific legal rights, and you may also have other rights which vary from state to state. This warranty is void outside the United States of America and Canada.

**PROCEDURE FOR OBTAINING PERFORMANCE OF WARRANTY:** If, after following the instructions in the owner's manual you are certain that the Product is defective, pack the Product carefully (preferably in its original packaging). Disconnect the battery from the Product and separately secure the battery in its own separate packaging within the shipping carton. The Product should include all parts and accessories originally packaged with the Product. Include evidence of original purchase and a note describing the defect that has caused you to return it. The Product should be shipped freight prepaid, by traceable means, to warrantor at:

**Uniden America Corporation**  
Parts and Service Division  
4700 Amon Carter Blvd.  
Fort Worth, TX 76155

# I.C. Notice

## TERMINAL EQUIPMENT

**NOTICE:** This equipment meets the applicable Industry Canada Terminal Equipment Technical Specifications. This is confirmed by the registration number. The abbreviation, IC, before the registration number signifies that registration was performed based on a Declaration of Conformity indicating that Industry Canada technical specifications were met. It does not imply that Industry Canada approved the equipment.

**NOTICE:** The Ringer Equivalence Number (REN) for this terminal equipment is marked on the equipment itself. The REN assigned to each terminal equipment provides an indication of the maximum number of terminals allowed to be connected to a telephone interface. The termination on an interface may consist of any combination of devices subject only to the requirement that the sum of the Ringer Equivalence Numbers of all the devices does not exceed five.

## RADIO EQUIPMENT

The term "IC:" before the radio certification number only signifies that Industry Canada technical specifications were met.

Operation is subject to the following two conditions: (1) this device may not cause interference, and (2) this device must accept any interference, including interference that may cause undesired operation of the device. "Privacy of communications may not be ensured when using this telephone".

# Index

## A

Announce only feature	43
Answering system	
Deleting a message	45
Playing your messages	44
Recording a conversation	47
Remote access	48
Repeating a message	44
Skipping a message	45
Turning On/Off	41
Area Code	15
AutoTalk	17

## B

Battery	
Preparing and charging	8
Replacement and handling	52
Beltclip	11

## C

Caller ID	
Caller ID services	34
Calling	37
CIDCW	34
Deleting	36
Setting	15
Viewing	35
Clock	14
Conferencing	26
Contrast	13

## D

Dial mode	14
-----------	----

## E, F, G, H

Earpiece volume	24
General information	54
Headset installation	12
Hold	22

## I, J, K, L

I.C. notice	60
Important safety instructions	58
Intercom	27
Language	17
Liquid damage	57

## M, N, O

Making a call	19
Mute	25
Outgoing message	42

## P, Q

Precautions	58
-------------	----

## R

Receiving a call	20
Remote	48
Remote access	
away from home	48
from your handset	50
Ringer	
Adjusting	23
Do not disturb	24
Mute	24

## S

Setting up	
base unit	13, 39
Handset	16
Speed dialing	29
<b>T, U, V, W, X, Y, Z</b>	
Talk and Standby Times	3
Troubleshooting	55
Voice memo	46
Warranty	59

# Remote Operation Card

C U T

## REMOTE OPERATION CARD **Uniden**

### Remote access away from home Turn on the answering system remotely

1. Call your phone number from a touch-tone phone.
  2. During the outgoing message, press 0 and enter your PIN code. The answering system announces the number of messages stored in memory and the voice prompts. The phone stands by for you to enter a command.
  3. To quit, hang up the phone.
1. Call your phone and let it ring 10 times until it answers.
  2. Press 0 and enter your PIN code.
  3. Press 0 then 5 to stop the announcement.
  4. Press 0 then 6 to turn the answering system on.

C U T

## REMOTE OPERATION CARD **Uniden**

### Remote access away from home Turn on the answering system remotely

1. Call your phone number from a touch-tone phone.
  2. During the outgoing message, press 0 and enter your PIN code. The answering system announces the number of messages stored in memory and the voice prompts. The phone stands by for you to enter a command.
  3. To quit, hang up the phone.
1. Call your phone and let it ring 10 times until it answers.
  2. Press 0 and enter your PIN code.
  3. Press 0 then 5 to stop the announcement.
  4. Press 0 then 6 to turn the answering system on.

C U T

## MEMORY LOCATION MEMO

Memory Location	Name	Phone Number
1		
2		
3		
4		
5		

C U T

## MEMORY LOCATION MEMO

Memory Location	Name	Phone Number
1		
2		
3		
4		
5		

# Remote Operation Card

C U T

## MEMORY LOCATION MEMO

Memory Location	Name	Phone Number
6		
7		
8		
9		
10		

C U T

Task	Key
Repeat a Message	0 1
Play Incoming Messages	0 2
Skip a Message	0 3
Delete a Message	0 4
Stop Operation	0 5
Answering System On	0 6
Memo Record/Stop	0 7
Greeting Message Record/Stop	0 8
Answer System Off	0 9
Voice Prompts	1 0

C U T

## MEMORY LOCATION MEMO

Memory Location	Name	Phone Number
6		
7		
8		
9		
10		

C U T

Task	Key
Repeat a Message	0 1
Play Incoming Messages	0 2
Skip a Message	0 3
Delete a Message	0 4
Stop Operation	0 5
Answering System On	0 6
Memo Record/Stop	0 7
Greeting Message Record/Stop	0 8
Answer System Off	0 9
Voice Prompts	1 0



# Memo

# Memo

## At Uniden, we'll take care of you!

Thank you for purchasing a Uniden product. If you have any questions or problems,  
**please do not return this product to the place of purchase.**



### Having Trouble?

Our customer care specialists are here to help you! Visit our website at [www.uniden.com](http://www.uniden.com) or call our Customer Hotline at **1-800-297-1023**, Mon-Fri, 7 a.m. to 7 p.m. or Sat/Sun, 9 a.m. to 5 p.m. CST. (Phone support is closed on holidays.)



### Need a Part?

To order headsets, additional handsets, replacement batteries or other accessories, visit our website at [www.uniden.com](http://www.uniden.com) or call **1-800-554-3988**, Mon-Fri, 8 a.m. to 5 p.m. CST.



### Help for our Special Needs Customers

If you need special assistance due to a disability or have questions on the accessibility features of this product, please call **1-800-874-9314 (voice or TTY)**

May be covered under one or more of the following U.S. patents:

4,797,916	5,426,690	5,434,905	5,491,745	5,493,605	5,533,010
5,574,727	5,581,598	5,650,790	5,660,269	5,661,780	5,663,981
5,671,248	5,696,471	5,717,312	5,732,355	5,754,407	5,758,289
5,768,345	5,787,356	5,794,152	5,801,466	5,825,161	5,864,619
5,893,034	5,912,968	5,915,227	5,929,598	5,930,720	5,960,358
5,987,330	6,044,281	6,070,082	6,125,277	6,253,088	6,314,278
6,418,209	6,618,015	6,671,315	6,714,630	6,782,098	6,788,920
6,788,953	6,839,550	6,889,184	6,901,271	6,907,094	6,914,940
6,953,118	7,023,176				

FOR  
ACCESSORIES,  
GO ONLINE @  
WWW.UNIDEN.COM

**REGISTER ONLINE TODAY!**

**THANK YOU FOR BUYING A UNIDEN PRODUCT.**

A World Without Wires | **Uniden®**

## Free Manuals Download Website

<http://myh66.com>

<http://usermanuals.us>

<http://www.somanuals.com>

<http://www.4manuals.cc>

<http://www.manual-lib.com>

<http://www.404manual.com>

<http://www.luxmanual.com>

<http://aubethermostatmanual.com>

Golf course search by state

<http://golfingnear.com>

Email search by domain

<http://emailbydomain.com>

Auto manuals search

<http://auto.somanuals.com>

TV manuals search

<http://tv.somanuals.com>