

# Uniden®

## OWNER'S MANUAL

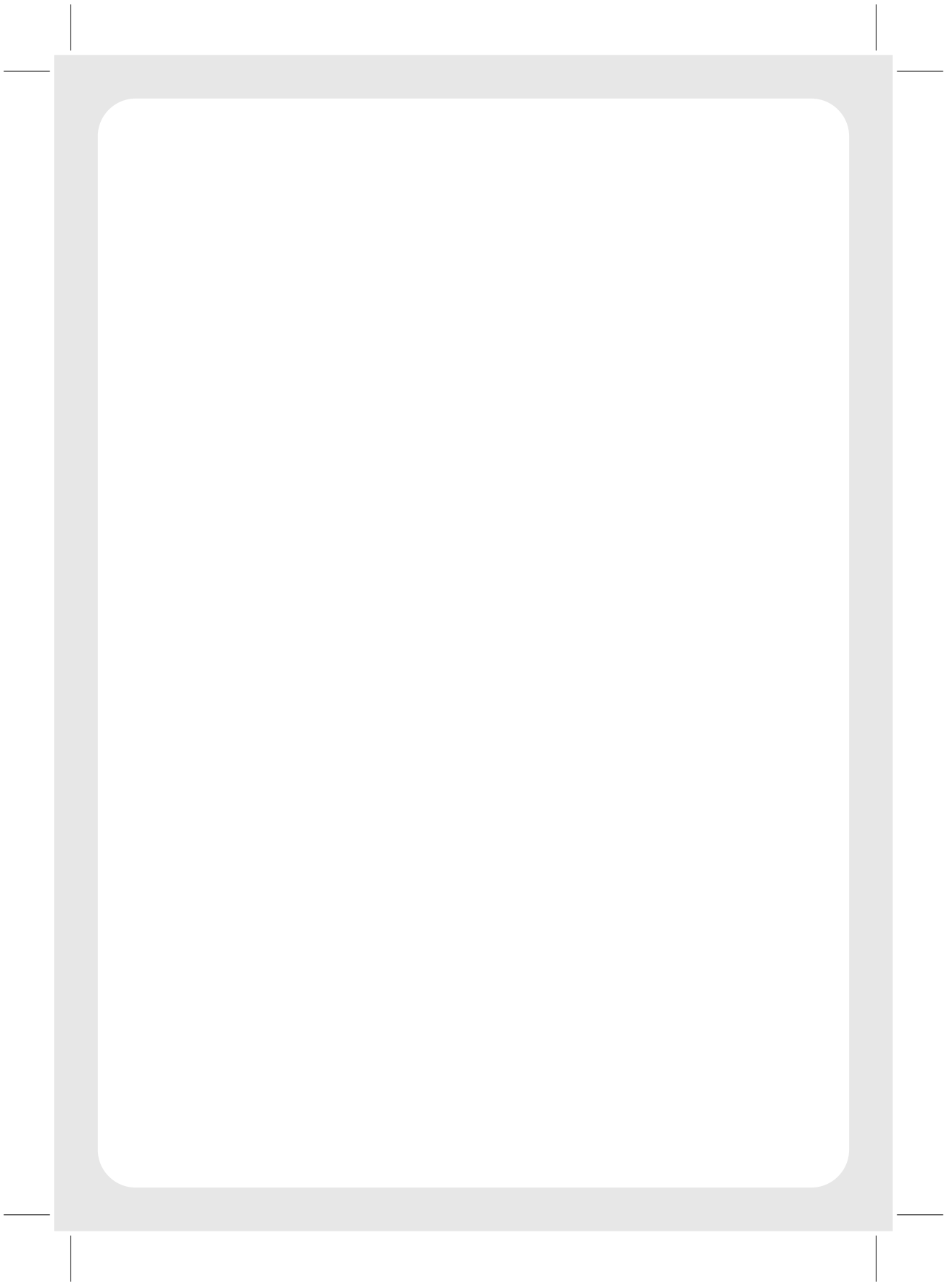

**UNIDEN uh088sx  
CB RADIO**



# Contents

<b>Controls/Indicators/Connections</b>	
Controls.....	3
Indicators.....	4
Connections.....	5
<b>Introduction</b>	
Features.....	6
Preventative Maintenance.....	6
Troubleshooting.....	6
Memory Backup.....	6
Layout.....	7
Included with your uh088sx CB radio.....	8
<b>Operation</b>	
Setting the Squelch.....	9
Selecting a Channel.....	10
Transmitting.....	10
Using Repeater Channels.....	10
Operating the uh088sx in Duplex Mode.....	11
Scanning.....	11
Open Scan (OS) Mode.....	11
Group Scan (GS) Mode.....	12
Choosing a Priority Channel.....	13
Drop Out Delay.....	13
Programming Scan Channels.....	14
Channel Seeking Operation.....	15

# Contents

Continuous Tone Coded Squelch System (CTCSS).....	16
Selective Calling (Optional Selcall PCB Required)	
Outline.....	17
Selective Calling (SELCALL).....	17
Receiver Quieting (Tone Squelch).....	17
Call Alarm.....	17
Tone Squelch Scanning.....	17
Tone Calling.....	17
Group Calling Capability.....	17
Tables	
FM-CB Frequency List.....	18
CTCSS Tone List.....	18
Warranty.....	19

## Controls/Indicators/Connections

### uh088sx CONTROLS

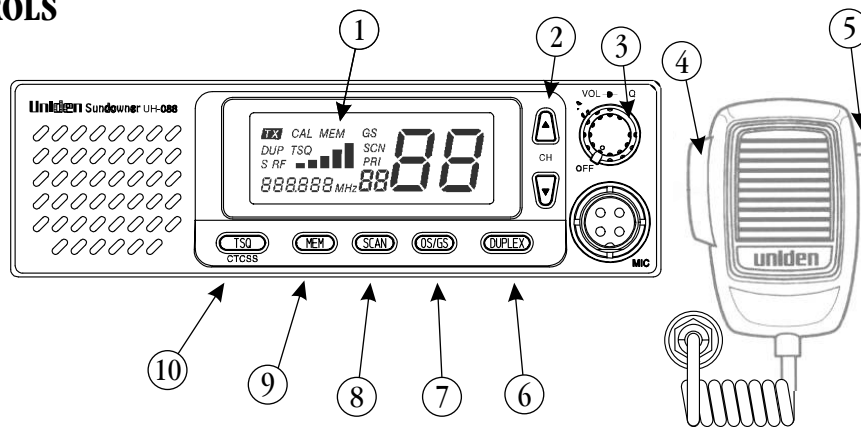

1. **LIQUID CRYSTAL DISPLAY (LCD) PANEL** - Indicators for TX, CAL, MEM, TSQ, GS (OS), SCN PRI, Channel Number, Frequency, Signal Strength Level (S), Transmit Power Level (RF), CTCSS Code and DUP.
2. **UP/DOWN CHANNEL SELECTOR** -These controls are used to select the desired communication channel.
3. **ON/OFF, VOLUME & SQUELCH CONTROLS**  
**ON/OFF & Volume Control (Centre Knob)**  
 Turns the uh088sx power ON or OFF and adjusts the volume.  
**Squelch Control (Outer Ring)**  
 Eliminates background noise in the absence of an incoming spiral.
4. **PUSH-TO-TALK (PTT) - SWITCH** - Press to transmit and release to receive.
5. **TONE CALL CONTROL BUTTON** - Press to transmit SELCALL codes, it functions on condition that SELCALL option is installed.
6. **DUPLEX Control**  
 Press this button momentarily to choose semi-duplex operation for channels 1 through 8.
7. **OPEN SCAN/GROUP SCAN CONTROL (OS/GS)**- Switches operation between OPEN SCAN and GROUP SCAN Mode.
8. **SCAN CONTROL (SCAN)** - Press to activate **Normal OS/GS** scanning or press and hold to enable Seek Mode OS/GS Scanning.

## Controls/Indicators/Connections

9. **MEMORY CONTROL (MEM)** - Places channel numbers into the memory scan list (OS or GS).
10. **TONE SQUELCH CONTROL (TSQ)** - Controls Tone Squelched operation (quiet Mode) on condition that SELCALL option is installed.  
**10 Secondary function: Continuous Tone Coded Squelch System (CTCSS)** - is a feature that allows a group to talk to each other without hearing other users on the same channel.

### INDICATORS

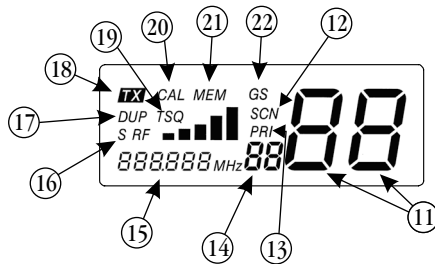

11. **Channel Indicator** - Indicates the channel number currently selected. On TX SELCALL usage the Channel Indicator becomes a Memory location indicator.
12. **Scan Indicator (SCN)** - SCN icon appears when normal Scan mode is activated. When Seek mode Scanning is selected the SCN icon blinks.
13. **Priority Indicator (PRI)** - Indicates that priority channel is active when continuously lit or flashes when it is regularly being checked for activity while GS scanning.
14. **Continuous Tone Coded Squelch System (CTCSS) Code** - Indicates the CTCSS code selected for the current channel.
15. **Frequency Indicator** - Shows the frequency of the current selected channel.
16. **RECEIVE SIGNAL/ RF LEVEL indicator (S/R)** - Indicates the relative signal strength level when receiving (S) or the relative transmit power (RF) when transmitting.
17. **DUPLEX Indicator (DUP)** - The DUP icon appears when duplex operation is selected.
18. **TRANSMIT indicator (TX)** - TX appears when the PTT button on the microphone is pressed and the radio is transmitting. The RF icon also appears at this time.
19. **TONE SQUELCH indicator (TSQ)** - The TSQ icon will appear when the selected channel is set to operate in Quiet Mode, or flashes when the radio is called using SELCALL.
20. **CALL Indicator (CAL)** - The CAL icon appears when the uh088sx radio is called using SELCALL. It also appears when SELCALL codes are being transmitted.
21. **MEMORY Indicator (MEM)** - MEM appears when the displayed channel is programmed either in GS or OS Memory.
22. **GROUP SCAN Indicator (GS)** - The GS icon appears when Group Scan Mode is activated. Open scan is indicated by the absence of the GS icon.

## Controls/Indicators/Connections

### CONNECTIONS

#### FRONT PANEL

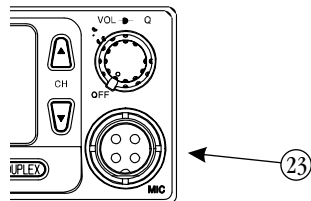

**23. MICROPHONE SOCKET**

The microphone plug is inserted into this socket.

#### BACK PANEL

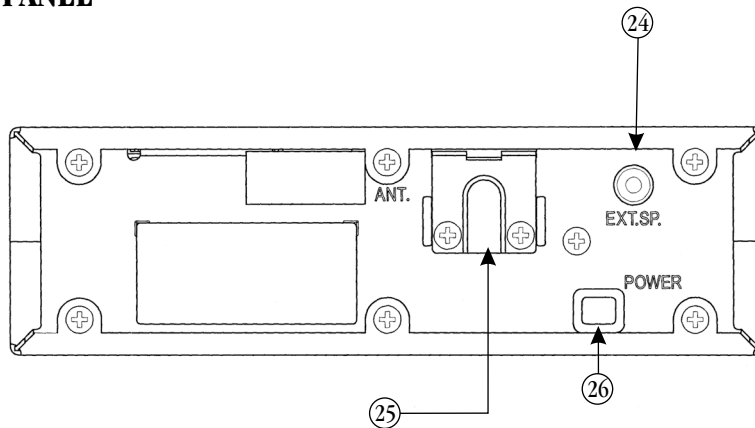

**24. EXTERNAL SPEAKER JACK** - used for remote receiver monitoring. When the external speaker is connected, the internal speaker is automatically disconnected. The connecting wire must use a 3.5mm miniature plug only.

**25. ANTENNA CONNECTOR** - Connect the Antenna here using a standard UHF (PL259) type connector.

**26. DC POWER CORD** - DC Power is connected to the transceiver through this jack. A power cord is supplied with the transceiver.

## Introduction

The Uniden uh088sx is designed to provide you with years of trouble free service. It's rugged components and materials are capable of withstanding harsh environments.

We are certain that you will enjoy your uh088sx. Please read this operating Manual carefully to ensure you gain the optimum performance of the unit.

### Features

- Transmit & Receive FM 40CH (UHF - CB, TX Power 5w)
- 7 Segments LCD
- CTCSS function
- Tone Squelch (Selcall) Capability
- Duplex Capability (from CH01 - CH08 per channel)
- Open Scan/Group Scan
- Variable Squelch Level adjust
- Volume Control with power ON/Off Switch

### Preventative Maintenance

The following system checks should be made every six to twelve months:

- Check the standing Wave Ratio (SWR)
- Inspect the tightness of all electrical connections.
- Inspect the antenna coaxial cable for wear or breaks on the shielding.
- Inspect the tightness of all screws and all other mounting hardware.

### Troubleshooting

Should the unit malfunction or perform poorly, follow these procedures:

- Check the power cord and fuse.

#### **If there is trouble with receiving...**

- Check the VOLUME control setting. Be sure the SQUELCH is adjusted properly. Possibly the radio is over squelched.

#### **If there is trouble with transmitting...**

- Check that the transmission line (coaxial cable) is securely connected to the ANTENNA connector.
- Check that the antenna is fully extended for proper operation.
- Check that all transmission line (coaxial cable) connections are secure and free of corrosion.

### Memory Backup

A built in EEPROM protects the channels stored in the uh088sx memory after the DC power cable is disconnected



# Introduction

## LAYOUT

### Front Panel Layout

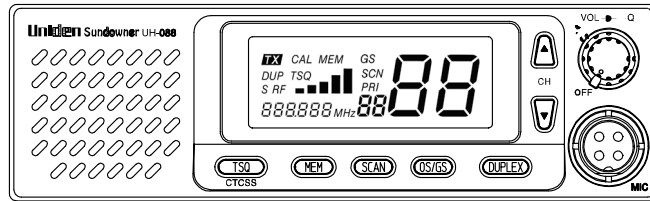

### Microphone Layout

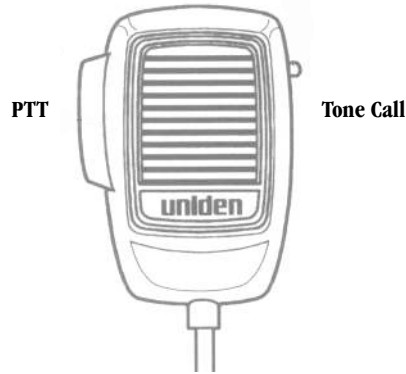

UNIDEN UHF CB Transceiver

**Included with your uh088sx CB radio**



uh088sx Owners Manual

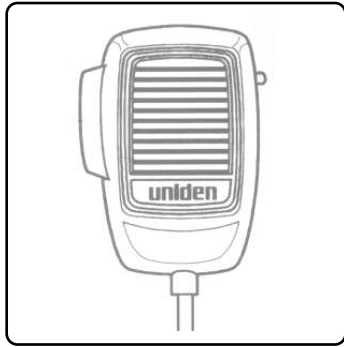

Microphone

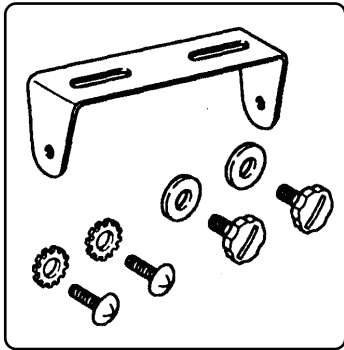

Mounting Bracket, Knobs,  
Rubber washer, Washer Stars  
and Screws.

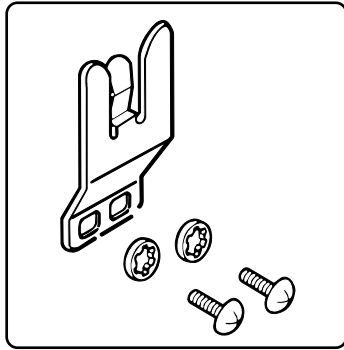

Microphone Hanger Screws  
and washers

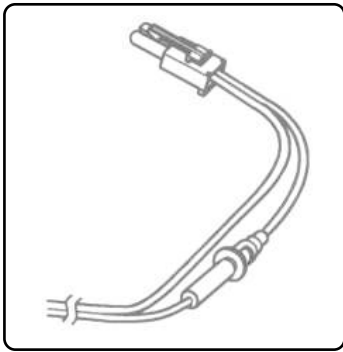

DC Power Cord with fuse

# Operation

## Setting the Squelch

1. To turn the unit ON, rotate volume clockwise. Adjust volume to a comfortable level.



*You must select a channel which is not in use before setting the SQUELCH control. (see p.10)*

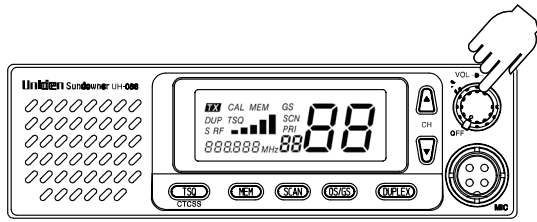

2. Think of the Squelch control as a gate. If you turn SQUELCH fully clockwise it raises the "Squelch Gate" so that no signals get through.

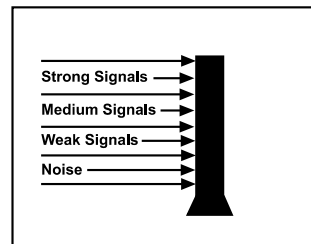

3. If you turn the SQUELCH fully counter clockwise, it lowers the "Squelch Gate" so that everything gets through - noise, weak signals and strong signals.

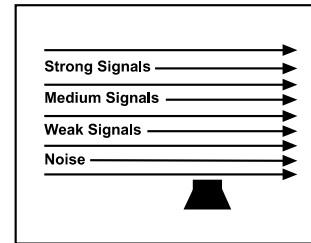

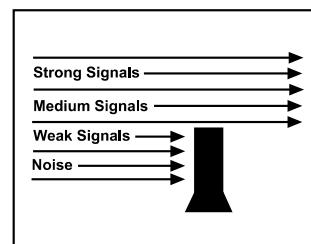

4. To set the "Squelch Gate" to the desired level, turn SQUELCH counterclockwise until you hear noise. Then turn the SQUELCH clockwise just until the noise stops. Now only strong signals get through.



## Operation

### SELECTING A CHANNEL

Press  or  button to select a channel

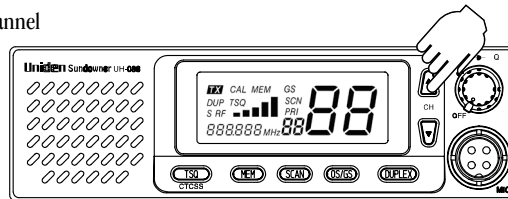

### TRANSMITTING

Select the desired channel. Press the Microphone's PTT button, hold it approx 7cm from your mouth and speak normally into the microphone. The **TX** icon will light. Release the PTT button to end the transmission and listen for a reply.

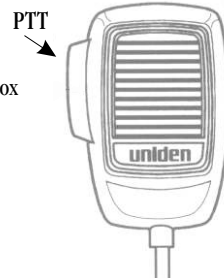

### USING REPEATER CHANNELS

UHF CB Repeaters are used to retransmit or relay your signal. Repeaters will extend the range of your radio and overcome the shielding effect caused by solid obstructions. In normal Simplex operation, your radio transmits on one particular frequency and receives on that same frequency. If there is a barrier that partially blocks your transmitted signal, the probability of another radio receiving the signal is very slim. Hills, tall buildings, metallic structures, ... etc. tend to act as a screen between radios.

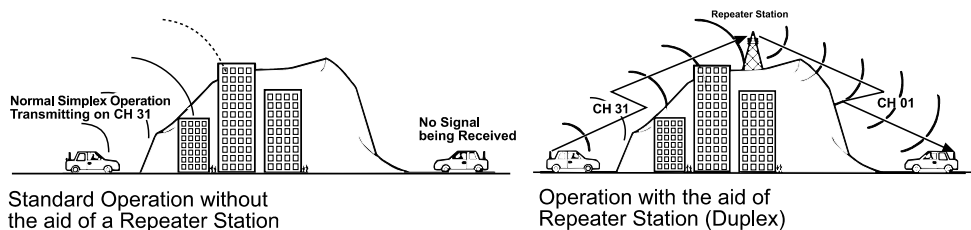

The Signal coming from your radio is received by the Repeater Station and then retransmitted at the same time on another channel. This operation is called "Duplexing".

For example,

CH01 on Duplex Mode will Receive on CH 01 but Transmit on CH31

CH02 on Duplex Mode will Receive on CH 02 but Transmit on CH32 etc ....

If you transmit on CH01 Duplex mode, you are actually transmitting on CH31, the repeater station down-converts your signal and retransmits on CH01.

## Operation

### Operating the uh088sx in Duplex Mode

For this example we are adopting CH01 as the channel being used in your area for repeater use.  
 Press **(DUPLX)** to switch Duplex On. The duplex icon DUP appears.  
 If Duplex is not required - press again to switch Duplex off.  
 Only channels 01 - 08 are available for Duplex

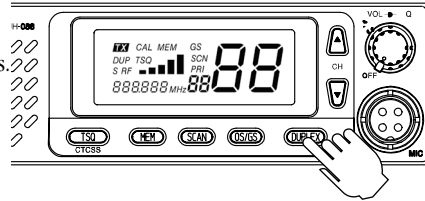

*Check with your local Retailer to determine if there is a Repeater in your area.*

### Scanning

The uh088sx has a scanning feature that allows you to search for active channels automatically.  
 Furthermore, the uh088sx is designed to have two types of scanning; Open Scanning (OS) and Group Scanning (GS), to give you flexibility and allow you to use the radio more effectively. Press **(SCAN)** and scanning starts.  
 The scan icon SCN appears.

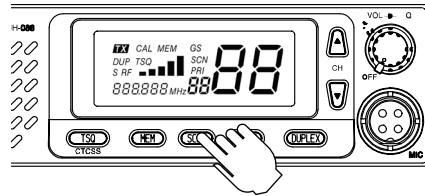

### Open Scan (OS) Mode

Allows continuous scanning of channels stored in the Open Scan memory. If an active channel is found, scanning will stop on that channel.

This example shows CH40 active.

If the received signal ceases, the unit will wait 3 seconds for the signal to return, otherwise scanning resumes.

To skip the active channel, press **(MEM)** momentarily. Scanning resumes.

To deactivate scan, press **(SCAN)** while scanning or the PTT button on the microphone.



*If SCAN is deactivated while on an active channel, the uh088sx will stay on that active channel. If no channels are active, the uh088sx will reinstate the starting channel.*

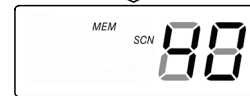
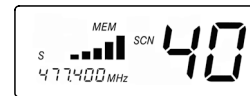

## Operation

### Group Scan (GS) Mode

Allows you to monitor a priority channel while scanning.

To use GS Mode Scanning, press the **(OS/GS)** key.  
GS icon appears on the display. OS Mode is indicated by the absence of the GS icon.

GS Scanning checks the priority channel activity regularly.

If the Priority channel becomes active the radio will stay on that channel for as long as the signal is active.  
If the received signal ceases, the unit will wait 3 seconds for the signal to return, otherwise scanning resumes.

If scanning stops on a channel which is not a Priority channel, uh088sx will continue monitoring the priority channel for activity while listening to the active one.

eg CH40 becomes active.

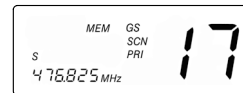
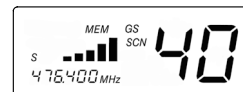
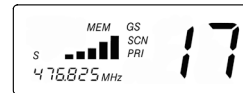
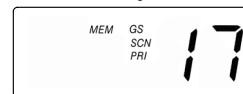
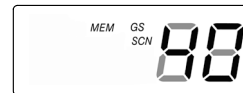

*If SCAN is deactivated while it is turned to an active channel, the ub088sx will stay on that active channel. If none of the channels are active, the ub088sx will reinstate the starting channel.*



*If GS is initiated when there are no channels programmed in GS memory, an error tone will be heard and scanning will not start (see programming Scan Channels - below).*

## Operation

### Choosing a Priority Channel

The starting channel, when Group Scanning is initiated, is always the priority channel.

Changing the PRI channel setting while scanning

eg: PRI Channel is CH17 (476.825 Mhz)

a. press , to select a higher channel (scanning pauses)

- or -

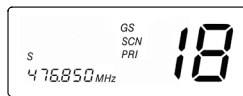

b. press , to select a lower channel

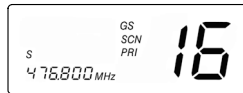

### Drop-out delay

While scanning, the uh088sx stops at a busy channel and receives a transmission. When the received signal is over, the unit will wait for three seconds for the return of the signal, otherwise, the radio resumes scanning.

## Operation

### Programming Scan Channels

1. Select which Scanning Mode you wish to use on the channel.  
OS or GS Mode

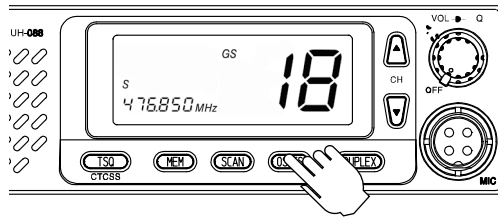

2. Select the channel you want to store.

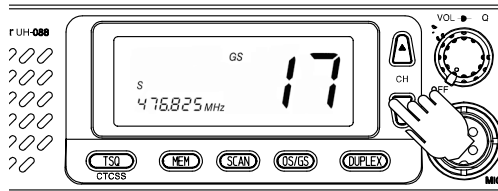

3. Press and hold **MEM** for 1.5sec. to store.  
**MEM** icon appears and a short tone beep is heard.

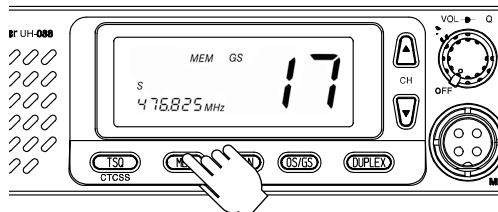

4. To remove the channel from memory, press and hold **MEM** for 1.5 sec. once more.  
Two successive beeps are heard and the **MEM** icon disappears.



## Operation

### Channel Seeking Operation

Unlike normal scanning, CHANNEL SEEK is used more often when checking for active channels.

If a signal is detected, while seeking, the uh088sx will tune to that signal for 4 seconds only and the resumes Seeking Operation.

Changing from SCAN to SEEK Mode Operation.

- 1 Firstly, activate scan mode by pressing 



2. Press and hold  until a 'beep' is heard. The SCN icon starts to flash.

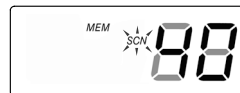

3. If an active channel is detected the uh088sx will stop on that channel for 4 seconds. (eg CH17)

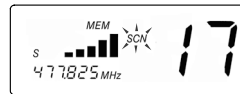

4. After 4 seconds, the uh088sx will start seeking again for active channels.



5. If you find the channel interesting, simply press either the PTT switch or  to stop the operation before the 4 second timer elapses.

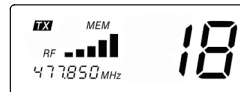

When  is pressed again SEEK is still the mode of operation.



To change back to SCAN, while SEEKING, press and hold  until a beep is heard. The SCN icon stops flashing.





*SEEK checks the same channel stored in SCAN memory. Thus, you can Seek either in OS or GS Mode.*



## Operation

### Continuous Tone Coded Squelch System (CTCSS)

This feature allows signals to be received only from callers who have selected the same CTCSS code.

Press  or  to select the desired channel to use CTCSS.

Press and hold  for 2 seconds. **CTCSS** code flashes.

Press  or  to select the desired CTCSS code 01 - 38.

Press  once to store the new setting.

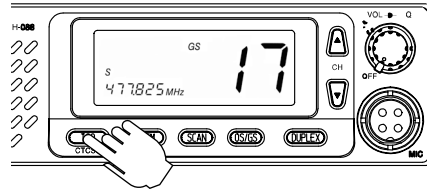

To turn CTCSS OFF please follow the above steps but select the desired CTCSS code of (before code 01).



*Channels 05 and 35 are Emergency Channels.  
CTCSS cannot be selected on these channels.*



*If a button is not pressed within 10  
seconds the ub088sx will automatically  
exit Select Mode.*

## Selective Calling (Optional Selcall PCB Required)

### Outline

**Selective Calling (SELCALL)** is a special Sequential Tone Squelch System that allows the user to receive/transmit calls selectively from/to an individual or group, on a shared busy channel.

The uh088sx has an **Optional Selective Calling system**.

Exceptional features, like Receiver Quieting, Tone Squelch Scanning, Tone and Group Calling make the uh088sx superior to any transceivers in its class.

### Receiver Quieting (Tone Squelch)

When activated, it automatically mutes the receiver audio circuit of the radio.

It will stay in this 'Quiet' mode as long as the SELCALL tone code (SELCALL ID) required to open the muting circuit is not received.

### Call Alarm

When a received code matches to your SELCALL ID, an alarm (CA Alert) will be emitted informing you that a caller is on the channel.

### Tone Squelch Scanning

Scans only tone squelched Channels.

### Tone Calling

Allows you to selectively call another radio.

### Group Calling Capability

Transmits and Responds to Group Calls.

## Tables

### FM - CB Frequency List - Australia & New Zealand

CH No.	Simplex Mode Transmit / Receive Frequency (MHz)	Duplex Mode Transmit Frequency (MHz)	CH No.	Simplex Mode Transmit / Receive Frequency (MHz)
01	476.425	477.175 CH31	21	476.925
02	476.450	477.200 CH32	22	476.950
03	476.475	477.225 CH33	23	476.975
04	476.500	477.250 CH34	24	477.000
05	476.525	477.275 CH35	25	477.025
06	476.550	477.300 CH36	26	477.050
07	476.575	477.325 CH37	27	477.075
08	476.600	477.350 CH38	28	477.100
09	476.625		29	477.125
10	476.650		30	477.150
11	476.675		31	477.175
12	476.700		32	477.200
13	476.725		33	477.225
14	476.750		34	477.250
15	476.775		35	477.275
16	476.800		36	477.300
17	476.825		37	477.325
18	476.850		38	477.350
19	476.875		39	477.375
20	476.900		40	477.400

Note: Channel 05 and 35 are Emergency Channels and Channel 11 is a calling channel

### CTCSS TONE List

Tone No.	Tone Frequency (Hz)	Tone No.	Tone Frequency (Hz)	Tone No.	Tone Frequency (Hz)
00 ('OFF')	OFF	13	103.5	26	162.2
01	67.0	14	107.2	27	167.9
02	71.9	15	110.9	28	173.8
03	74.4	16	114.8	29	179.9
04	77.0	17	118.8	30	186.2
05	79.7	18	123.0	31	192.8
06	82.5	19	127.3	32	203.5
07	85.4	20	131.8	33	210.7
08	88.5	21	136.5	34	218.1
09	91.5	22	141.3	35	225.7
10	94.8	23	146.2	36	233.6
11	97.4	24	151.4	37	241.8
12	100.0	25	156.7	38	250.3

NOTE: Channel 05 and 35 are not CTCSS programmable

## Warranty

### ONE YEAR LIMITED WARRANTY

**IMPORTANT:** Evidence of the original purchase is required for warranty service.

**WARRANTOR:** Uniden New Zealand Limited. Uniden Australia Pty Ltd. ACN 001 865 498

**ELEMENTS OF WARRANTY:** Uniden warrants to the original retail owner for the duration of this warranty its uh088sx (hereinafter referred to as the Product), to be free from defects in materials and craftsmanship with only the limitations or exclusions set out below.

**WARRANTY DURATION:** This warranty to the original retail owner only is only valid in the original country of purchase and shall be of no further effect 12 months after the date of original retail sale. This warranty will be deemed invalid if the Product is: (A) Damaged or not maintained as reasonable and necessary, (B) Modified, altered or used as part of any conversion kits, subassemblies, or any configurations not sold by Uniden, (C) Improperly installed, (D) Repaired by someone other than an authorised Uniden Repair Agent for a defect or malfunction covered by this warranty, (E) Used in conjunction with any equipment or parts or as a part of a system not manufactured by Uniden. (F) Only available in the original country of sale.

**PARTS COVERED:** This warranty covers for one (1) year, the uh088sx transceiver only. All accessories (Mounting bracket, Microphone etc.) are covered for 90 days only.

**STATEMENT OF REMEDY:** In the event that the Product does not conform to this warranty at any time while this warranty is in effect, the warrantor, at its discretion, will repair the defect or replace the Product and return it to you without charge for parts and service. **THIS WARRANTY DOES NOT COVER OR PROVIDE FOR THE REIMBURSEMENT OR PAYMENT OF INCIDENTAL OR CONSEQUENTIAL DAMAGES. THIS GUARANTEE IS IN ADDITION TO AND DOES NOT IN ANY WAY AFFECT YOUR RIGHTS UNDER THE CONSUMER GUARANTEE ACT.**

**PROCEDURE FOR OBTAINING PERFORMANCE OF WARRANTY:** in the event that the Product does not conform to this warranty, the Product should be shipped or delivered, freight prepaid, with evidence of original purchase (e.g. a copy of the sales docket) to the warrantor at:

**UNIDEN AUSTRALIA PTY LIMITED  
SERVICE DIVISION**

345 Princes Highway,  
Rockdale,  
NSW 2216,  
AUSTRALIA  
Fax: (02) 9599 3278  
[www.uniden.com.au](http://www.uniden.com.au)

**UNIDEN NEW ZEALAND LIMITED  
SERVICE DIVISION**

150 Harris Road,  
East Tamaki,  
Auckland,  
NEW ZEALAND  
Fax: (09) 274 4253  
[www.uniden.co.nz](http://www.uniden.co.nz)



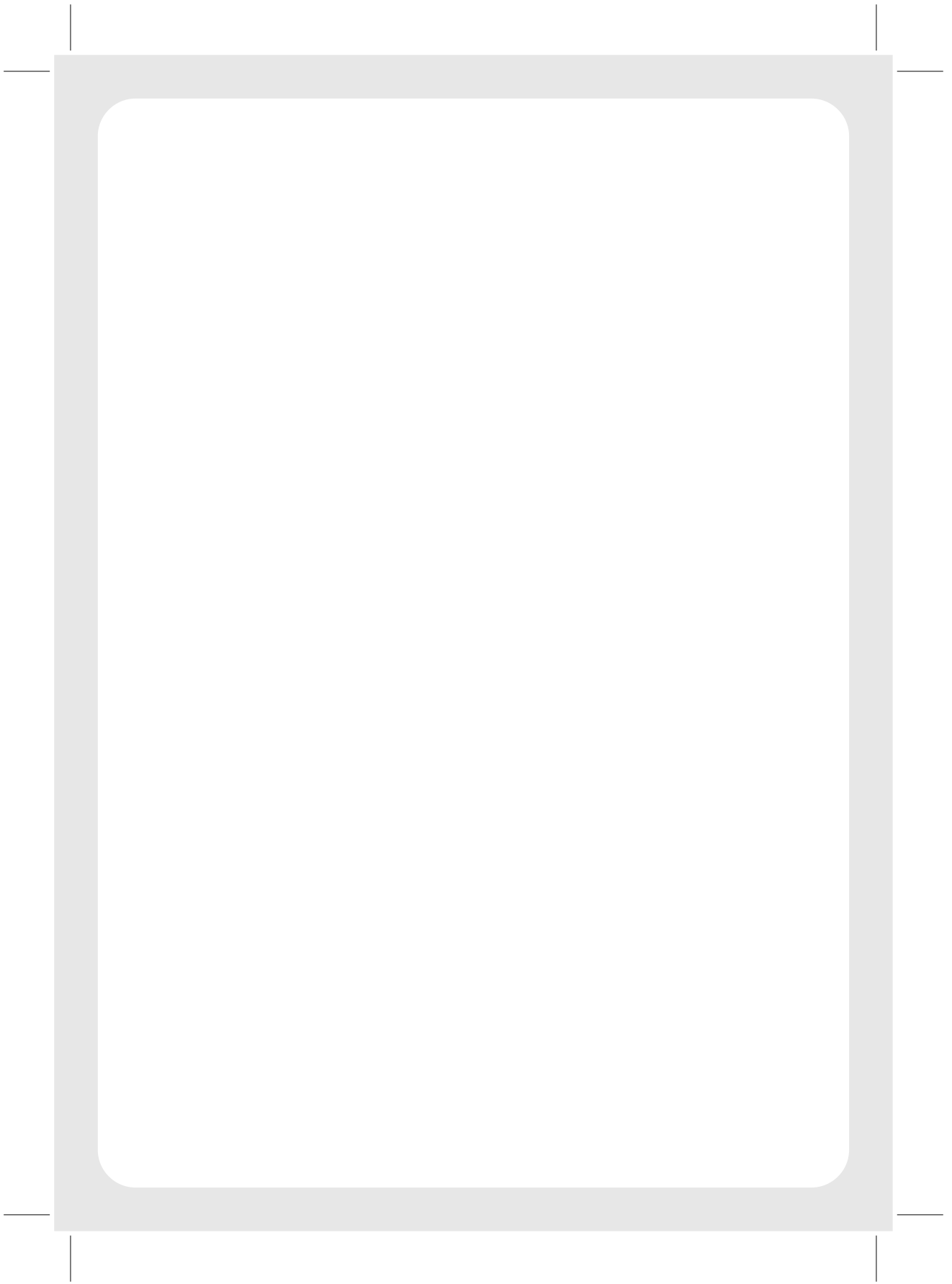

**Uniden<sup>®</sup>**

© 2004 Uniden Australia Pty Limited / Uniden New Zealand Limited  
Printed in the in China  
UTZZ01924ZZ



uh064sx-2  
Operating Guide



**Uniden®**

To bring outstanding wireless communication products  
to people's lives throughout the world.

## CONTROL & INDICATORS

### INCLUDED IN YOUR PACKAGE:

- uh064sx-2 Radio (2)
- Operating Guide
- Belt Clip (2)
- Charging Cradle with AC Adaptor
- NiMH Battery Pack (2)
- VOX Headset (2)
- External Speaker Mic (2)

### OPTIONAL ACCESSORIES

- VOX Earset
- Carry Case

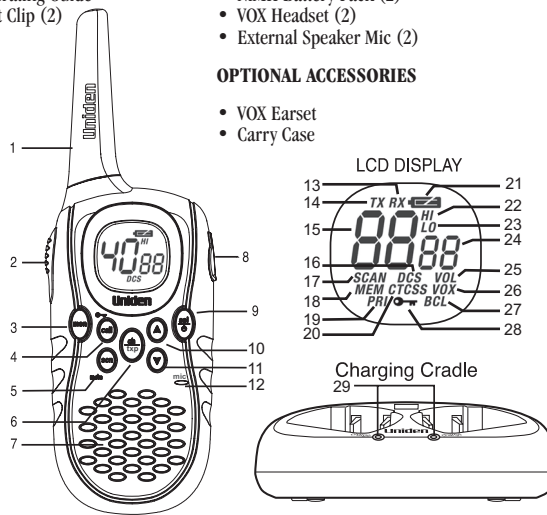

- |                               |  |
|-------------------------------|--|
| 1 Antenna                     | 16 DCS ON Indicator                          |
| 2 PTT(Push-To-Talk) Key       | 17 Scan Indicator                            |
| 3 Monitor Key                 | 18 Memory Indicator                          |
| 4 Keylock/Call Key            | 19 Priority Channel Indicator                |
| 5 Memory/Scan Key             | 20 CTCSS ON Indicator                        |
| 6 Channel/ Transmit Power Key | 21 Battery Level Indicator                   |
| 7 Speaker                     | 22 HI Transmit Indicator                     |
| 8 Headset Jack                | 23 Lo Transmit Indicator                     |
| 9 Select/Power On-Off Key     | 24 CTCSS and DCS Code/Volume Level Indicator |
| 10 Volume/Select Up Key       | 25 Volume Setting Indicator                  |
| 11 Volume/Select Down Key     | 26 VOX Indicator                             |
| 12 Microphone                 | 27 Busy Channel Lockout Indicator            |
| 13 Receive Indicator          | 28 Keypad Lock Indicator                     |
| 14 Transmit Indicator         | 29 Charging LEDs                             |
| 15 Channel Indicator          |  |

## GETTING STARTED



*Uniden does not represent this product to be waterproof. Do not expose this product to Rain or Moisture.*

### BATTERY INSTALLATION

Your uh064sx unit uses the included NiMH battery pack for power. The unit can be powered with optional 4 AAA ALKALINE batteries.



*If you don't use the uh064sx for long periods, Uniden recommend removing the batteries. The uh064sx is designed to retain the previous user settings. This feature will continue to use a small amount of battery power while the unit is switched off.*



*To avoid damage to the unit do not mix old and new batteries.*

#### To install the batteries:

1. Make sure your radio is off.
2. Release the battery cover clip, then remove the battery cover.
3. Insert NiMH battery pack according to the orientation on the battery pack.

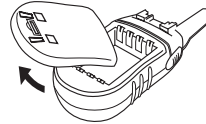

#### OR

Insert 4 AAA ALKALINE batteries (not included) according to the polarity symbols inside the battery compartment.

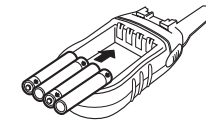

4. Align the battery cover tabs with the uh064sx tab holes then replace the cover clip.

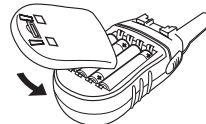

*Do not charge alkaline or non rechargeable batteries.*



### INSTALLING THE CHARGE CRADLE

1. Plug the AC adaptor into the rear of the charge cradle and into the mains power.

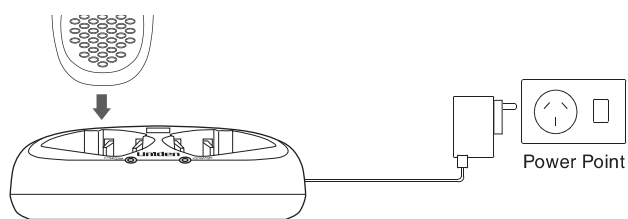

2. Place the uh064sx into the charge cradle. The charge light will come on to indicate the unit is charging.
3. Before operating the uh064sx, charge the battery pack for 16 hours.



*Do not charge alkaline or non rechargeable batteries.*

### USER LICENCE INFORMATION



*The citizen band radio service is licenced in Australia by ACMA Radio-communications (Citizen Band Radio Stations) Class Licence and in New Zealand by MED General User Licence for Citizen Band Radio and operation is subject to conditions contained in those licences.*



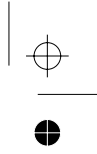
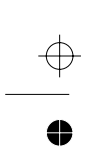

### BELT CLIP

**To attach the belt clip:**  
Slide the belt clip until it snaps into place.

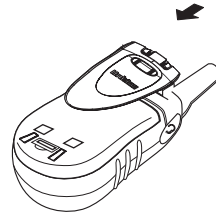

**To remove the belt clip:**  
To remove the belt clip, press and hold belt clip locker, slide the belt clip at the same time until released.

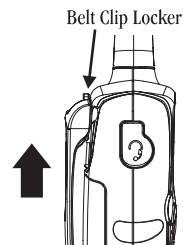

### LOW BATTERY ALERT

If the battery level becomes low, the battery indicator icon on the display begins flashing. When the batteries in the unit are low, the unit will go into a battery Low mode. The Transmit mode is disabled. Replace the alkaline batteries immediately or if you are using the NiMH battery pack, place the radio on the charge cradle to recharge. Full charge will take up to 16 Hrs.



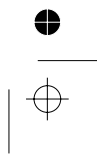
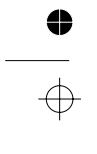

### BACK LIGHT

The uh064sx has an automatic display back light which remains on for 10 seconds after a key press (all keys except PTT key). The back light will work even if the keypad is locked but will not work during low battery alert mode.





## OPERATION

### POWER ON/OFF

1. Press and hold **select**/ key to turn the radio on. A channel number will appear on the display.
2. Press and hold **select**/ key to turn the radio off.

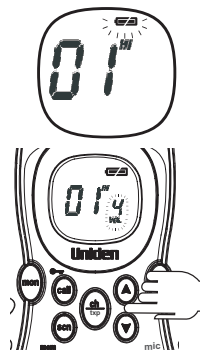

### VOLUME

1. Press  or  key to increase or decrease the volume level. VOL icon appears on the display while volume is being adjusted. There are 8 volume levels. Level 0 (No Audio) to Level 7 (Maximum Volume).





### ADJUSTING THE KEY BEEPS

Your radio emits a beep each time one of the keys (except for the PTT key) is pressed.



1. To turn OFF this beep: Press and hold  /**call** key while turning on the radio.
2. To turn ON this beep: Press and hold  /**call** key while turning on the radio.

### ROGER BEEP

Roger Beep is a BEEP that is sent to notify the end of transmission (both PTT and VOX transmission.) Roger Beep can be heard through the speaker when Key Beep is on. Roger Beep is transmitted even if Key Beep is turned off. However, Roger Beep will not be heard from the speaker.

1. To turn OFF Roger Beep: Press and hold  key while turning on the radio.
2. To turn ON Roger Beep: Press and hold  key while turning on the radio.

### KEYLOCK ON/OFF

1. Press  /**call** key for 1.5 seconds to enter keylock on mode.
2. Press  /**call** key for 1.5 seconds while in Keylock mode to exit the Keylock mode.



*While in Keylock on mode, the ub064sx can still receive and transmit.*

## SELECTING A CHANNEL

1. Press **cb/txp** key momentarily to activate channel select mode. The displayed channel will flash.
2. Press ▲ or ▼ key to select the desired channel.



*For your reference a list of the available channels, corresponding frequencies and guidelines for their use is printed on page 12. For Australia, Channels 05 and 35 are reserved for Emergency Calls.*



3. Press **cb/txp** key momentarily to exit channel select mode. If no key is pressed within 5 sec the uh064sx will exit from the channel select mode.

## TO TRANSMIT AND RECEIVE

The uh064sx uses the 40 UHF-CB Channels (**Channels 22 and 23 are for telemetry and telecommand applications. Transmit is inhibited on these channels.**)

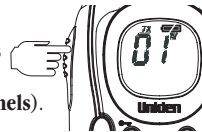

1. Before you transmit, listen for activity on the selected channel.
2. When the channel is clear, press and hold the PTT key to transmit. 'TX' icon appears on the display.

*Hold the radio with microphone approximately 5 cm in front of your mouth with the antenna at approximately 45° angle away from your head. Speak in a clear, normal conversational voice.*

3. When you have finished speaking, release the PTT and listen for a response. 'TX' icon then disappears on the display. While receiving, the 'RX' icon is displayed.

## TRANSMIT Hi/Mid/Lo POWER SELECT

1. Press and hold **cb/txp** key to select desired transmit level. 'HI' icon will appear on the display for maximum transmit level. 'LO' icon will appear on the display for minimum transmit level. When there is no 'HI' or 'LO' icon then the middle transmit level is set. With quality alkaline batteries the transmit power of the uh064sx is 2.0W (Hi), 0.5W (Mid) and 0.1W (Lo).





## AUTOMATIC SQUELCH FEATURE

The uh064sx is equipped with an Automatic Squelch System which shuts off weak transmissions and unwanted noise.

### MONITOR

This feature enables users to listen for weak signals on the current channel at the press of a key.

#### To use monitor:

1. Press *mon* key. The 'RX' icon will flash.
2. Release within 1.5 seconds and the unit exits Monitor mode.
3. Press and hold *mon* key for 2 seconds for continuous listening.





The receiver circuit will stay open, letting in both the noise & weak signals. The 'RX' icon flashes in this status.

4. To return to normal Receive mode press *mon* key. The 'RX' icon disappears or stops flashing in this status.

### SCANNING

The scan function scans all channels which are stored in the SCAN CHANNEL MEMORY and stops at an active channel. If a PRIORITY channel has been selected then this channel will be monitored for activity every 3 seconds. When the signal stops, the uh064sx waits 2 seconds (Reply Delay) before scanning resumes.

#### To initiate scanning:

1. Press *mem/SCN* key momentarily to begin scanning. The 'SCAN' icon is displayed.
2. Press *select/* , *mem/SCN* or /*call* key to cancel.

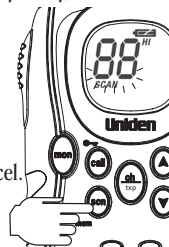

When scan stops at a busy channel, pressing *cb/txp* key will resume scan.







### REPLY DELAY

While scanning, the uh064sx stops at a busy channel and receives a transmission. When the received signal is over, the unit will wait for 2 seconds for the return of the signal, otherwise, the radio resumes scanning.

### TO OPERATE IN DUPLEX MODE (REPEATERS)

The Duplex function enables you to access local repeater stations. You can only activate Duplex from CH01-CH08.

UHF CB Repeaters are used to retransmit or relay your signal. Repeaters will extend the range of your radio and overcome the shielding effect caused by solid obstructions.



Contact your retailer for a list of repeaters available in Your area.

### Operation with the aid of a Repeater

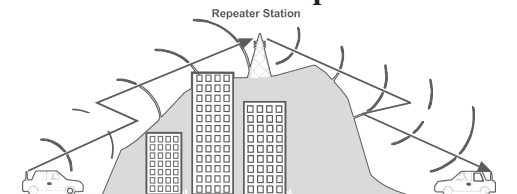

1. Press **select/** key six times. **dp** appears on the display.
2. Press **▲** or **▼** to change to **r**.
3. Press **select/** to confirm

To deactivate the duplex operation repeat activation process and change **r** to , uh064sx will return to normal operation.



If **▲** or **▼** key is pressed when the channel is not from Cb01 - Cb08, an error tone sounds.







## CTCSS & DCS

(Continuous Tone Coded Squelch System) & (Digital Coded Squelch)

CTCSS is a feature that allows a group to talk to each other without hearing other users on the same channel.



1. Press **select/**  key momentarily to enter CTCSS mode. The current selected CTCSS tone flashes.
2. Press **▲** key to select the required CTCSS tone (OFF or 1-38).
3. Press **select/**  key six times to confirm the selected setting and exit to standby mode.



For channels with a CTCSS tone setting, the CTCSS tone is displayed below the channel indicator. For channels with the setting of CTCSS OFF, there will be no display below the channel indicator.

## DCS

DCS is a digital extension of CTCSS. It provides 104 extra, digitally coded, squelch codes that follow after the 38 CTCSS codes. CTCSS 1-38, followed by DCS 1-99 plus DCS 100-104 (represented by 00-04 on the display).

1. Press **select/**  key momentarily to enter CTCSS/DCS mode.
2. Use **▲** key to select a DCS code. The DCS codes follow on after the CTCSS codes. The DCS icon will replace the CTCSS code on the display.
3. Press **select/**  key six times to confirm the selected setting and exit to standby mode.



The DCS icon will appear when selected. To turn off DCS select CTCSS OFF and no display will show below the channel indicator.





*Channels 05 and 35 are used for emergency channels.  
CTCSS and DCS will not operate on these two channels.*





## VOX

VOX is the automatic transmitting function by inputting voice into the VOX headset mic without pressing the PTT key.

1. Press **select/**  key momentarily twice while in standby mode to enter VOX Sensitivity mode. The current selected VOX setting will flash on the display.
2. Press **▲** or **▼** key to adjust the VOX sensitivity. 1 is the highest sensitivity and 4 is the lowest sensitivity. VOX can be turned off by selecting 'oF' icon.
3. Press **select/**  key five times to confirm the setting and exit to standby mode.





The 'VOX' icon is shown on the display when VOX is selected to on and VOX Headset is plugged into VOX Headset Jack.

The 'TX' icon blinks when the voice level is possible to transmit at the current selected VOX sensitivity level.

## TRANSMITTING A CALL TONE

Your uh064sx radio is equipped with 5 selectable call tones that will be transmitted when the  /call key is pressed momentarily.

### To select a call tone:

1. Press **select/**  key momentarily three times while in standby mode to enter Call Tone mode. The current call tone number (C1-C5) will be indicated.
2. Press the **▲** or **▼** key to select desired call tone. Each tone will be heard through the speaker.
3. Press **select/**  key four times to confirm and exit to standby mode. To transmit the selected call tone, press the  /call key. The selected tone will automatically be transmitted for a fixed length of time. Call Tone will be cancelled when the **PTT** key is pressed.





*Current regulations require calling tones to be restricted to one transmission per minute. If a second transmission is attempted within one minute then an error tone will sound.*





## PRIORITY SCAN CHANNEL

### To set a priority scan channel:



1. Press **select/**  momentarily four times while in standby mode to enter Priority Scan Channel mode. The current priority channel will be indicated.
2. Press **▲** or **▼** key to increase or decrease the desired channel number.
3. Press **select/**  three times to confirm and exit to standby mode. **PRI** will be displayed when a priority channel has been selected.



## BCL (Busy Channel Lockout) ON/OFF

BCL is used when CTCSS or DCS is selected to prevent transmission when the uh064sx detects a transmission from another unit using the same CTCSS or DCS code.

### To set BCL ON/OFF:

1. Press **select/**  momentarily five times while in standby mode to enter **BCL ON/OFF** mode. The current BCL status will be indicated.
2. Press **▲** or **▼** key to select **ON** (on) or **OFF** (oF).
3. Press **select/**  two times to confirm and exit to standby mode. **BCL** will be displayed when BCL on has been selected.



## SCAN CHANNEL MEMORY

### To store a channel into Scan Channel Memory:

1. Select desired channel using **ch/txp** key and **▲** or **▼** key.
2. Press and hold **mem/SCN** key. **MEM** will appear on the display.

Repeat steps 1 and 2 to clear channel from Scan Channel Memory.



## UHF CB CHANNELS & FREQUENCIES



**Please follow these guidelines for channel use in Australia:**

- Channels 05 and 35 are Emergency Channels.
- Channel 11 is a Calling Channel.
- Channels 22 and 23 are for telemetry and telecommand applications and TX is inhibited on these channels.

**General communication is accepted on all other channels with these guidelines:**

- Channel 40 - road channel (Australia).
- Channels 01-08 (and 31-38) are repeater channels.

CH No.	Simplex Mode Transmit / Receive Frequency (MHz)	Duplex Mode Transmit Frequency (MHz)	CH No.	Simplex Mode Transmit/Receive Frequency (Mhz)
1	476.425	477.175 CH31	21	476.925
2	476.450	477.200 CH32	22	476.950 (RX only)
3	476.475	477.225 CH33	23	476.975 (RX only)
4	476.500	477.250 CH34	24	477.000
5	476.525	477.275 CH35	25	477.025
6	476.550	477.300 CH36	26	477.050
7	476.575	477.325 CH37	27	477.075
8	476.600	477.350 CH38	28	477.100
9	476.625		29	477.125
10	476.650		30	477.150
11	476.675		31	477.175
12	476.700		32	477.200
13	476.725		33	477.225
14	476.750		34	477.250
15	476.775		35	477.275
16	476.800		36	477.300
17	476.825		37	477.325
18	476.850		38	477.350
19	476.875		39	477.375
20	476.900		40	477.400

## CTCSS & DCS Code List

CTCSS Code LIST

Code No.	Frequency (Hz)	Code No.	Frequency (Hz)	Code No.	Frequency (Hz)
"oF"	OFF	13	103.5	26	162.2
1	67.0	14	107.2	27	167.9
2	71.9	15	110.9	28	173.8
3	74.4	16	114.8	29	179.9
4	77.0	17	118.8	30	186.2
5	79.7	18	123.0	31	192.8
6	82.5	19	127.3	32	203.5
7	85.4	20	131.8	33	210.7
8	88.5	21	136.5	34	218.1
9	91.5	22	141.3	35	225.7
10	94.8	23	146.2	36	233.6
11	97.4	24	151.4	37	241.8
12	100.0	25	156.7	38	250.3

DCS Code LIST

Code No.	DCS Code (Octal)	Code No.	DCS Code (Octal)	Code No.	DCS Code (Octal)	Code No.	DCS Code (Octal)
1	023	27	152	53	311	79	466
2	025	28	155	54	315	80	503
3	026	29	156	55	325	81	506
4	031	30	162	56	331	82	516
5	032	31	165	57	332	83	523
6	036	32	172	58	343	84	526
7	043	33	174	59	346	85	532
8	047	34	205	60	351	86	546
9	051	35	212	61	356	87	565
10	053	36	223	62	364	88	606
11	054	37	225	63	365	89	612
12	065	38	226	64	371	90	624
13	071	39	243	65	411	91	627
14	072	40	244	66	412	92	631
15	073	41	245	67	413	93	632
16	074	42	246	68	423	94	654
17	114	43	251	69	431	95	662
18	115	44	252	70	432	96	664
19	116	45	255	71	445	97	703
20	122	46	261	72	446	98	712
21	125	47	263	73	452	99	723
22	131	48	265	74	454	100(o0)	731
23	132	49	266	75	455	101(o1)	732
24	134	50	271	76	462	102(o2)	734
25	143	51	274	77	464	103(o3)	743
26	145	52	306	78	465	104(o4)	754



## WARRANTY

### UNIDEN uh064sx UHF CB RADIO

Limited One Year Warranty



*Please keep your sales docket as it provides evidence of warranty.*

**Warrantor:** Uniden Australia Pty Limited ABN58 001 865 498 Uniden New Zealand Limited.

**Warranty only available in original country of purchase.**

**Elements of Warranty:** Uniden warrants to the original retail owner for the duration of this warranty, its uh064sx UHF CB Transceiver Radio (hereinafter referred to as the Product) to be free from defects in materials and craftsmanship with only the limitations or exclusions set out below.

**Warranty Duration:** This warranty to the original retail owner only, shall terminate and be of no further effect ONE (1) Year after the date of original retail sale. This warranty will be deemed invalid if the Product is: (A) Damaged or not maintained as reasonable and necessary, (B) Modified, altered or used as part of any conversion kits, subassemblies, or any configurations not sold by Uniden, (C) Improperly installed, (D) Repaired by someone other than an authorised Uniden Repair Agent for a defect or malfunction covered by this warranty, (E) Used in conjunction with any equipment or parts or as part of a system not manufactured by Uniden, (F) Installed, programmed or serviced by anyone other than an authorised Uniden Repair Agent, or (G) Where the Serial Number label of the product has been removed or damaged beyond recognition.

**Parts Covered:** This warranty covers for 1 year, the UHF CB Transceiver Unit only.

**Accessories:** Belt Clip, Battery cover, Batteries etc are covered for 90 days.

**Statement of Remedy:** In the event that the product does not conform to this warranty at any time while this warranty is in effect, the warrantor at its discretion, will repair the defect or replace the product and return it to you without charge for parts and service. This warranty does not cover provide for the reimbursement or payment of incidental or consequential damages.

**Procedure for Obtaining Performance or Warranty:** In the event that the Product does not conform to this warranty, the Product should be shipped or delivered, freight prepaid with evidence of original purchase, (eg. a copy of the sales docket), to the warrantor at:

**UNIDEN AUSTRALIA PTY LIMITED**  
Service Division  
345 Princes Highway, Rockdale, NSW 2216  
Fax (02) 9599 3278  
www.uniden.com.au

**UNIDEN NEW ZEALAND LIMITED**  
Service Division  
150 Harris Road, East Tamaki, Auckland  
Fax (09) 274 4253  
www.uniden.co.nz

Customers in other states should ship or deliver the Product freight pre-paid to the nearest Uniden Authorised Repair Centre. (Contact Uniden for the Warranty Agent nearest you.)



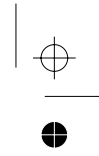
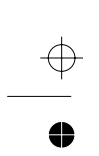

**Uniden®**

© 2006 Uniden Australia Pty Limited/Uniden New Zealand Limited  
Printed in China UTZZ01933ZZ(0)

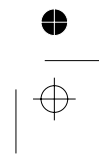
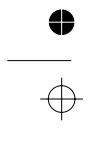



## Free Manuals Download Website

<http://myh66.com>

<http://usermanuals.us>

<http://www.somanuals.com>

<http://www.4manuals.cc>

<http://www.manual-lib.com>

<http://www.404manual.com>

<http://www.luxmanual.com>

<http://aubethermostatmanual.com>

Golf course search by state

<http://golfingnear.com>

Email search by domain

<http://emailbydomain.com>

Auto manuals search

<http://auto.somanuals.com>

TV manuals search

<http://tv.somanuals.com>