

Uniden®

uh065sx

uh065sx-2

Owner's Manual

OWNER'S MANUAL

WARNING!



The citizen band radio service is licenced in Australia by ACMA Radio-communications (Citizen Band Radio Stations) Class Licence and in New Zealand by MED General User Licence for Citizen Band Radio and operation is subject to conditions contained in those licenses.



Do not plug in any AC Adapter plug into the EXT. SPKR/MIC (SM-065) phone jack.

CONTENTS

Introduction	
Features	3
Controls & Indicators	4
Included in Your uh065sx Pack	6
Getting Started	
Battery Installation	7
Charging Batteries	8
Battery Life	8
Battery Level Display.....	9
Low Battery Alert.....	10
Operation	
Power On/Off	11
Volume.....	11
Setting the Squelch	11
Selecting a Channel	12
To Transmit and Receive.....	12
To Operate in Duplex Mode (Repeaters)	13
Transmit Power Select.....	14
Scanning	14
Open Scan Mode.....	15
Group Scan Mode	16
Priority Channel.....	17
Programming Scan Channels	17
Drop-Out Delay	18
Dual Watch	18
Monitor.....	18
CTCSS	19
DCS	19
VOX	20
Room Monitor	20
Call Tone.....	21
Busy Channel Lockout.....	22
Roger Beep	22
Key Beep	22
Battery Save	23
Keypad Lock.....	23
Back Lighting.....	23
UHF CB Channels & Frequencies.....	24
CTCSS & DCS Code List.....	25
Warranty	26

INTRODUCTION

The uh065sx UHF CB radio is compact, rugged and fits easily in your hand. This hand held UHF radio will give you consistent, outstanding performance in virtually all conditions and situations. To ensure that you get the most from the uh065sx's features, please read this operating guide carefully before using the unit.

FEATURES

- Transmit 38 UHF-CB channels*
- Receive 40 UHF-CB channels
- TX output power 0.1W / 0.5W / 2.0W
- Up to 8 km + range**
- LCD display
- Battery level indicator
- Battery Power Save On/Off
- Channel select
- LCD back light
- Monitor
- Room monitor
- Dual watch
- Group Scan with Priority CH Watch
- Open Scan
- OS/GS Scan separately Channel Memory
- Selectable scan direction upward or downward
- Priority CH select
- Duplex capability
- 5 Level VOX (Voice Activated Function)
- 5 Level Room Monitor transmission threshold
- Selectable 3 squelch position
(“1” = threshold, “2” = middle, “3” = tight)
- Busy CH Lock-Out Function
- 5 different CALL tone
- Roger beep
- Key beep On/ Off
- Keypad lock
- 38 Built in CTCSS (Continuous Tone Coded Squelch System) codes and 104 DCS (Digital Coded Squelch System) codes are selectable
- Volume and Power On/OFF Control Knob
- External Speaker / Microphone capability

* See UHF-CB Channels & Frequencies, page 24 for available channels.

** Range varies depending on the environment. 8km + range is noted in a flat open environment.

CONTROLS & INDICATORS

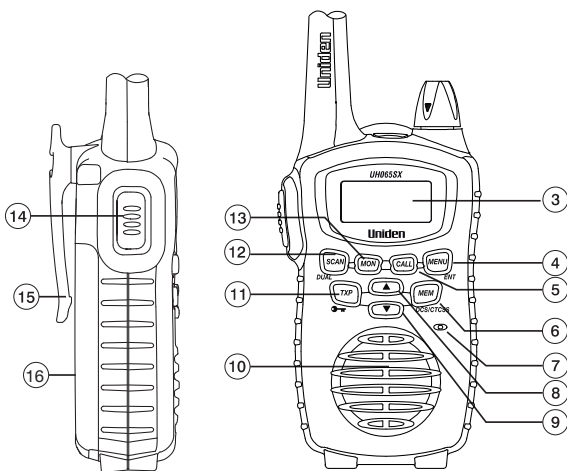
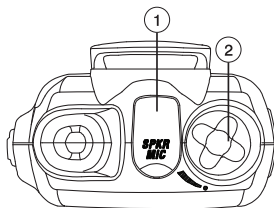

CONTROLS & INDICATORS

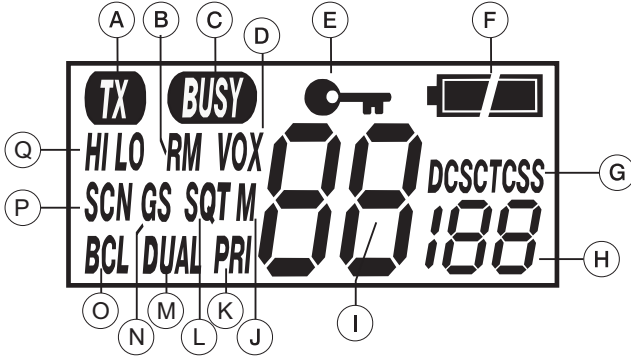

- A. Transmit
- B. Room Monitor
- C. Busy
- D. Voice Activation
- E. Key Lock
- F. Battery Level Indicator
- G. DCS/CTCSS Indicator
- H. DCS/CTCSS code
- I. Channel Number
- J. Memory
- K. Priority
- L. Squelch
- M. Dual Watch
- N. Group Scan
- O. Busy Channel Lockout
- P. Scan
- Q. Power Level Indicator (High/Low)

- 1. EXT. SPKR/MIC Jack
- 2. On/Off Volume Knob
- 3. LCD Display
- 4. Menu/Enter Button
- 5. Call Tone Transmit Button
- 6. Memory On/Off & DCS/CTCSS Button
- 7. Microphone
- 8. Up Button
- 9. Down Button
- 10. Speaker
- 11. Transmit Power Select/Keylock Button
- 12. Scan/Dual Watch Button
- 13. Monitor Button
- 14. PTT (Push-to-talk) Button
- 15. Belt Clip
- 16. Battery Cover

UNIDEN Model uh065sx UHF CB Radio

INCLUDED IN YOUR Uh065sx PACK



Handset(s)*

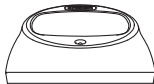

Charger**

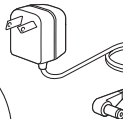

AC Adaptor
AAD-065S(M)



Earpiece Mic*
(uh065sx-2 Only)

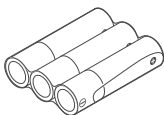

3x AA NiMH batteries*

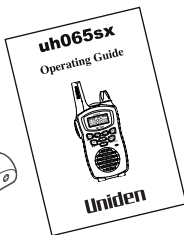

Operating Guide



External Speaker
Microphone (SM-065)*



*If any of these items are missing from the box,
contact your Uniden Dealer.*

* uh065sx (1 piece of indicated item), uh065sx-2 (2 pieces).

** uh065sx single charger is shown, uh065sx-2 comes with twin charger.

Optional Accessories

- Voice Activated (VOX) Headset (VM-041)
- Leather Case (LC-040)
- Commercial Quality Speaker Microphone (SM-060CQ)
- Commercial Quality Dual Earmuff (HM-064CQ)
- Commercial Quality Air Tube (EM-064CQ)
- Commercial Quality Referee's Kit (RK-060CQ)
- Commercial Quality Rubber Car Hook (EM-060CQ)

GETTING STARTED

BATTERY INSTALLATION

Your uh065sx pack includes 3 AA rechargeable NiMH batteries to power the unit. You must install and then charge the batteries for 15 hrs before use. The uh065sx can also use 3 AA Alkaline batteries.



Do not mix old and new batteries to avoid damage to the unit.

To install batteries :

1. Make sure your radio is OFF.
2. Remove the battery compartment door by pressing the tab at the bottom of the compartment door.
3. Install the batteries to the battery compartment.
4. Replace the battery compartment door.

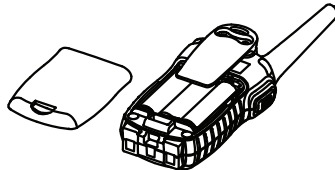
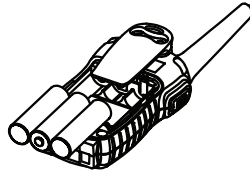
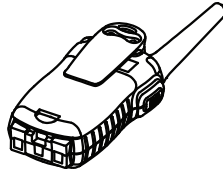

GETTING STARTED

CHARGING BATTERIES

1. Connect the AC adaptor to the charging cradle.
2. Place the battery installed unit with keys facing forward onto the charging cradle to charge the batteries. The charge LED lights to indicate charge contact.



Warning Notice!
Use only the supplied
AAD-065S(M) power adaptor if
rechargeable batteries will be
used in the uh065sx.



uh065sx single
charger is shown.



Battery charging times vary.
A longer time is required
to charge higher capacity
batteries.

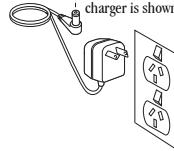

Rechargeable Batteries	Charging Time
1500mAH Ni-MH	15 hrs

BATTERY LIFE

Duty cycle: TX 5% - RX 5% - STANDBY 90 %
55hrs typ. (AA SIZE ALKALINE)
30hrs typ. (AA SIZE 1500mAH Ni-MH)

Condition measured:
Volume Level at rated power (50mW @ 16 ohms)
Transmit Level; LO

GETTING STARTED

BATTERY LEVEL DISPLAY

The  icon in the upper right hand corner of the screen indicates the uh065sx current battery voltage level at all times. The battery level is displayed in 4 levels:

LEVEL 1

Battery 100% full



LEVEL 2

Battery approx
30% capacity



LEVEL 3

Battery approx
15% capacity



LEVEL 4

Almost Empty

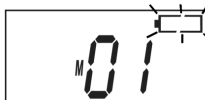



When (PTT) SW is pressed at Level 3, the PTT Error Tone will be heard and the channel number will flash.



GETTING STARTED

LOW BATTERY ALERT

The LCD on your radio shows a battery meter in the upper right hand corner.

 icon indicates a fully powered unit. As the batteries lose power,  will flash. The LCD display will turn off after 30sec. An error tone will sound if any key is pressed.



Recharge the NiMH batteries or replace the Alkaline batteries immediately to continue using the radio.

OPERATION

POWER ON/OFF

To turn the unit ON, rotate the **[ON/OFF VOLUME]** knob clockwise until a “click” is heard. A channel number and battery level should appear on the display.

To turn the unit OFF, rotate the **[ON/OFF VOLUME]** knob counter-clockwise until a “click” is heard to save the battery life. The display will disappear.

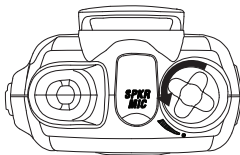
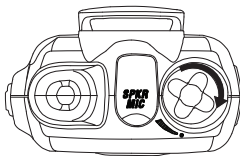

VOLUME

Rotate the **[ON/OFF VOLUME]** knob clockwise to increase the volume, counter-clockwise to decrease the volume.

SETTING THE SQUELCH

The squelch is used to eliminate any annoying background noise when there are no signals present.



1. Press **[MENU/ENT]** once.
The current setting will flash.
2. Press **[▲]** or **[▼]** to select desired squelch setting.
SQL-1 : Max sensitivity (Threshold)
SQL-2 : Med sensitivity
SQL-3 : Min sensitivity (Tight)
3. Press and hold **[MENU/ENT]** to save setting and exit.

OPERATION

SELECTING A CHANNEL

Press  or  to select the desired channel.



If you press and hold  or  the channel numbers will scroll rapidly.

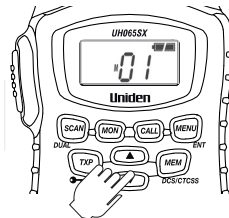



TO TRANSMIT AND RECEIVE

The uh065sx uses the 40 UHF-CB Channels. For your reference a list of the available channels and corresponding frequencies is printed on page 24. (Channels 22 and 23 are for telemetry and telecommand applications. Transmit is inhibited on these channels).

1. The maximum RF transmit power of uh065sx is 2 Watts.
2. Before you transmit, listen for activity on the selected channel.
3. When the channel is clear, press and hold the  to transmit.
TX appears on the LCD.

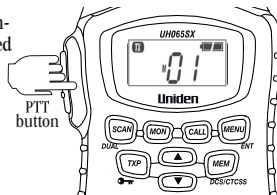
Hold the radio with microphone approximately 5 cm in front of your mouth with the antenna at approximately 45° angle away from your head. Speak in a clear, normal conversational voice.



4. When you have finished speaking, release the  and listen for a response then TX disappears on the LCD. **BUSY** appears while receiving a signal.

OPERATION

TO OPERATE IN DUPLEX MODE (REPEATERS)

The Duplex function enables you to access local repeater stations.



You can only activate Duplex on CH01-CH08.

UHF CB Repeaters are used to retransmit or relay your signal. Repeaters will extend the range of your radio and overcome the shielding effect caused by solid obstructions.

Eg. CH01 is being used in your area for repeater use.

1. Press twice.
dP will flash.
2. Press or to change the selection.
r appears when duplex is selected.
3. Press and hold to save and exit.



Contact your retailer for a list of repeaters available in your area.

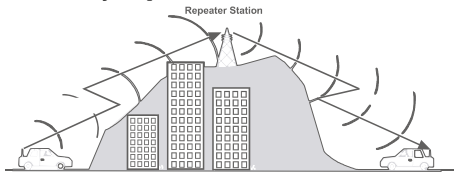

Operation with the aid of a Repeater



OPERATION

TRANSMIT POWER SELECT

The uh065sx has three transmit power levels: 2 Watt, 0.5 Watt and 0.1 Watt. To change your transmit power level:

1. Press  while in the 'power middle level' to change to 'power high level.'
2. Press  while in the 'power high level' to change to the 'power low level.'
3. Press  while in the 'power low level' to change to 'power middle level.'



TX Power Low



TX Power Middle



TX Power High



Transmitting on a higher level will use more Battery power but will enable you to transmit further.

SCANNING

The uh065sx has two types of scanning: Open Scanning (OS) and Group Scanning (GS). OS Scan searches all the channels and frequencies in its memory continuously. GS Scan has the ability of monitoring a priority channel every 1.5 seconds while searching channels and frequencies in its memory.

Scanning allows you to search for active channels programmed in the OS or GS memory.

To initiate scanning,

1. Assuming the unit is on CH01 when switched on.
2. Press  and scanning starts. Scan icon flashes during scanning.

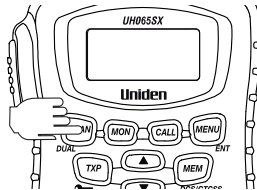

OPERATION

OPEN SCAN (OS) Mode (the absence of GS icon indicates that the unit is on OS mode)

Allows continuous scanning of channels stored in the Open Scan (OS) memory. If an active channel is found, scanning will stop on that channel.







The factory has preprogrammed all the 40 UHF channels into the Open Scan channel memory. However, you can change or customise the channels by following the steps on programming Scan Channels on page 17.

Example. CH40 becomes active

If the received signal ceases, the unit will wait for at least 3 seconds for the signal to return, otherwise scanning resumes.



To skip the active channel, press  or . Scanning resumes.

To deactivate SCAN, press the ,  or .







1. If SCAN is deactivated while in an active channel, the uh065sx will stay on that active channel. If no other channels are active, the uh065sx will reinstate the starting channel.

2. If OS Scanning is initiated when there are no channels programmed in OS memory, an error tone will be heard and scanning will not start.

OPERATION



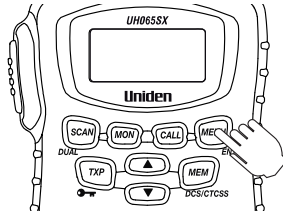

GROUP SCAN(GS) Mode

To change between OS and GS scan;

1. Press  four times.
GS setting ON or OFF will flash.
2. Press  or  to change the selection.
3. Press and hold  to save and exit.



To initiate scanning,

1. When  is pressed during Group Scan Mode, *SCN* will blink and Group Scan Scanning begins.
2. To deactivate GS scanning, press ,  or .



1. If *SCAN* is deactivated while it is tuned to an active channel, the *uh065sx* will stay on that active channel. If none of the channels re-active, the *uh065sx* will reinstate the Scan start channel.
2. If GS Scanning is initiated when there are no channels programmed in GS memory, an error tone will be heard and scanning will not start.

OPERATION

Priority Channel

The feature allows user to monitor one of the 40 channels, monitoring it every 1.5 secs during Group Scanning. The Priority Channel can also be monitored with Dual Watch, see page 18.

Choosing a Priority Channel

1. Press **MENU** **ENT** three times. PRI setting flashes.
2. Press **▲** or **▼** to select the desired channel number or the OFF setting.
3. Press and hold **MENU** **ENT** to save and exit.

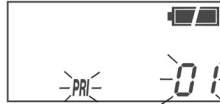

Programming Scan Channels

1. Select which Scanning Mode you wish to use on the channel OS or GS Mode.



OS is indicated by the absence of the GS icon.

2. Select the channel you want to store by pressing **▲** or **▼**.
3. Press **MEM** **DCS/CTCSS** to store. **MEM** icon appears.
4. To remove the channel from Memory, Press **MEM** **DCS/CTCSS** to remove. **MEM** icon disappears.

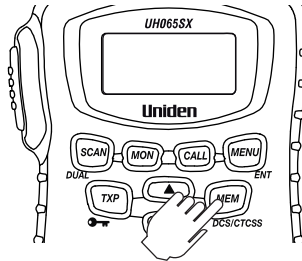

OPERATION

Drop-out Delay

While scanning, the uh065sx stops at a busy channel and receives a signal. When the received signal is over, the unit will wait for 3 seconds for the return of the signal, otherwise, the radio resumes scanning.

DUAL WATCH



When Dual Watch function is active, PRI CH is watched every 1.5 seconds.

Press and hold  to activate or deactivate Dual Watch. DUAL appears on the display when activated.

MONITOR

This feature enables users to listen in for weak signals on the current channel at the press of a button.

To use monitor,



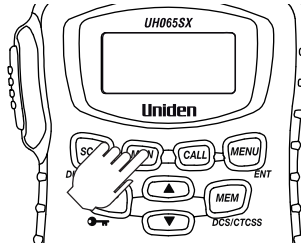

- For continuous listening.
Press .
A single tone beep will be heard and the receiver circuit will stay open, letting in both the noise & weak signals.
- Display shows **BUSY** icon.
- To return to normal receive mode press .



OPERATION

CTCSS

CTCSS is a feature that allows a group to talk to each other without hearing other users on the same channel.

1. Select desired channel.
2. Press and hold . The current DCS/CTCSS setting flashes.
3. Press  or  to select desired CTCSS code.
4. Press  to save and exit.



DCS

DCS is a digital extension of CTCSS. It provides 104 extra, digitally coded, squelch codes that follow after the 38 CTCSS codes. CTCSS 1-38, followed by DCS 1-104.

Follow the steps for changing CTCSS code but select DCS code as desired.



Channels 05 and 35 are used for emergency channels. CTCSS and DCS will not operate on these two channels.





OPERATION

VOX

VOX is the automatic transmitting function by inputting voice into the VOX headset mic without pressing the PTT key.

While headset microphone is not connected, VOX function is inactive even if vox level setting is from 1 to 4.

VOX icon blinks while VOX function is active.

1. Press  five times.
The current vox setting flashes.
2. Press  or  to select desired setting.
The 5 VOX levels are from 1 (High sensitivity) to 4 (Low sensitivity) and Off.
3. Press and hold  to save and exit.

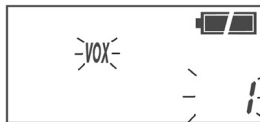
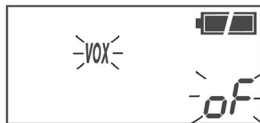

ROOM MONITOR

The Room Monitor function sets the uh065sx to operate as a transmitter only - receive (speaker) is disabled.

The TX is activated by voice activation (VOX) without pressing . TX will activate when the detected voice/noise volume exceeds the setting threshold. If the voice/noise keeps TX open for over 4seconds then TX will continue automatically for an additional 15 seconds until the voice/noise volume falls below the setting threshold.

While in Room Monitor mode;

- The receive function is disabled.
- RM flashes on the display.
- Dual Watch function, if ON, is disabled.
- Duplex mode is disabled on duplex channels.
- Scan mode is disabled.
- All key touch tones are disabled.

OPERATION

Room Monitor can be temporarily disabled by pressing **PTT** or **CALL**.

If no further operation is performed for 45 seconds then the temporary disable mode ends and Room Monitor mode re-activates.

1. Press **MENU/ENT** six times.
2. Press **▲** or **▼** to select desired setting.
The 5 Room Monitor levels are from 1 (High sensitivity) to 4 (Low sensitivity) and Off.
3. Press and hold **MENU/ENT** to save and exit.



- *If using this feature as Baby Monitor please note it is not a replacement for regularly checking the safety and security of children.*
- *The operating time is limited to the remaining charge of the battery and is not suitable for continuous overnight use.*
- *If there is any input at EXT SP MIC JACK, Room Monitor automatically turns off.*

CALL TONE

Your uh065sx radio is equipped with 5 selectable call tones that will be transmitted when **CALL** is pressed momentarily.

1. Press **MENU/ENT** seven times. The current call tone setting flashes.
2. Press **▲** or **▼** to select desired setting.
The 5 call tones are C1, C2, C3, C4 and C5.
3. Press and hold **MENU/ENT** to save and exit.







Current regulations require calling tones to be restricted to one transmission per minute. If a second transmission is attempted within one minute then an error tone will sound.

OPERATION





BUSY CHANNEL LOCKOUT

BCL is used when CTCSS or DCS is selected to prevent transmission when the uh065sx detects a transmission from another unit using the same CTCSS or DCS code.

1. Press  eight times. The current BCL setting flashes.
2. Press  or  to select desired setting.
3. Press and hold  to save and exit.





ROGER BEEP

Roger Beep is a BEEP that is sent to notify the end of transmission (both PTT and VOX transmission.) Roger Beep can be heard through the speaker when Key Beep is on. Roger Beep is transmitted even if Key Beep is turned off. However, Roger Beep will not be heard from the speaker.

1. Press  nine times. The current Roger Beep setting flashes.
2. Press  or  to select desired setting.
3. Press and hold  to save and exit.

KEY BEEP





Assures the user that the keypad has been properly pressed by emitting a beep tone. This tone can be switched on or off.

1. Press  ten times. bP setting flashes.
2. Press  or  to change selection.
3. Press and hold  to save and exit.

OPERATION



BATTERY SAVE

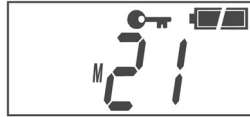

Battery Save feature extends the battery life by switching the receiver circuit power ON and OFF. This feature automatically activates during stand by mode (RX mode without signal). It turns OFF automatically when a signal is present, and activates again after channel inactivity. Battery Save can be switched on or off.

1. Press  eleven times. bS setting flashes.
2. Press  or  to change selection.
3. Press and hold  to save and exit.



KEYPAD LOCK

To prevent accidental entries, you can lock the keypad. Press and hold the  button for 1.5 Secs until it beeps to activate Key Lock. The  icon appears.

To unlock the keypad, press and hold  button again for 1.5 Secs. The  icon disappears.



When the Key Lock is active, an error tone will be heard if you attempt to press the keys.

BACK LIGHTING

The Liquid Crystal Display (LCD) is backlit for easy viewing at night or in low light situations. The back lighting automatically switches ON every time a key (except PTT) is pressed. It turns OFF 5 secs after the last key is pressed.

UHF CB CHANNELS & FREQUENCIES



Please follow these guidelines for channel use in Australia:

- Channels 05 and 35 are Emergency Channels.
- Channel 11 is a Calling Channel.
- Channels 22 and 23 are for telemetry and telecommand applications and TX is inhibited on these channels. General communication is accepted on all other channels with these guidelines:
- Channel 40 - road channel (Australia).
- Channels 01-08 (and 31-38) are repeater channels.

CH No.	Simplex Mode Transmit / Receive Frequency (MHz)	Duplex Mode Transmit Frequency (MHz)	CH No.	Simplex Mode Transmit/Receive Frequency (MHz)
1	476.425	477.175 CH31	21	476.925
2	476.450	477.200 CH32	22	476.950 (RX only)
3	476.475	477.225 CH33	23	476.975 (RX only)
4	476.500	477.250 CH34	24	477.000
5	476.525	477.275 CH35	25	477.025
6	476.550	477.300 CH36	26	477.050
7	476.575	477.325 CH37	27	477.075
8	476.600	477.350 CH38	28	477.100
9	476.625		29	477.125
10	476.650		30	477.150
11	476.675		31	477.175
12	476.700		32	477.200
13	476.725		33	477.225
14	476.750		34	477.250
15	476.775		35	477.275
16	476.800		36	477.300
17	476.825		37	477.325
18	476.850		38	477.350
19	476.875		39	477.375
20	476.900		40	477.400

CTCSS & DCS CODE LIST

CTCSS Code LIST

Code No.	Frequency (Hz)	Code No.	Frequency (Hz)	Code No.	Frequency (Hz)
"oF"	OFF	13	103.5	26	162.2
1	67.0	14	107.2	27	167.9
2	71.9	15	110.9	28	173.8
3	74.4	16	114.8	29	179.9
4	77.0	17	118.8	30	186.2
5	79.7	18	123.0	31	192.8
6	82.5	19	127.3	32	203.5
7	85.4	20	131.8	33	210.7
8	88.5	21	136.5	34	218.1
9	91.5	22	141.3	35	225.7
10	94.8	23	146.2	36	233.6
11	97.4	24	151.4	37	241.8
12	100.0	25	156.7	38	250.3

DCS Code LIST

Code No.	DCS Code (Octal)	Code No.	DCS Code (Octal)	Code No.	DCS Code (Octal)	Code No.	DCS Code (Octal)
1	023	27	152	53	311	79	466
2	025	28	155	54	315	80	503
3	026	29	156	55	325	81	506
4	031	30	162	56	331	82	516
5	032	31	165	57	332	83	523
6	036	32	172	58	343	84	526
7	043	33	174	59	346	85	532
8	047	34	205	60	351	86	546
9	051	35	212	61	356	87	565
10	053	36	223	62	364	88	606
11	054	37	225	63	365	89	612
12	065	38	226	64	371	90	624
13	071	39	243	65	411	91	627
14	072	40	244	66	412	92	631
15	073	41	245	67	413	93	632
16	074	42	246	68	423	94	654
17	114	43	251	69	431	95	662
18	115	44	252	70	432	96	664
19	116	45	255	71	445	97	703
20	122	46	261	72	446	98	712
21	125	47	263	73	452	99	723
22	131	48	265	74	454	100	731
23	132	49	266	75	455	101	732
24	134	50	271	76	462	102	734
25	143	51	274	77	464	103	743
26	145	52	306	78	465	104	754

WARRANTY

UNIDEN uh065sx and uh065sx-2 UHF CB Radio Limited One Year Warranty



Warrantor:

Please keep your sales docket as it provides evidence of warranty.

Uniden Australia Pty Limited ABN 58 001 865 498
Uniden New Zealand Limited

Warranty only available in original country of purchase

Elements of Warranty: Uniden warrants to the original retail owner for the duration of this warranty, its uh065sx and uh065sx-2 UHF CB Radio (hereinafter referred to as the Product) to be free from defects in materials and craftsmanship with only the limitations or exclusions set out below.

Warranty Duration: This warranty to the original retail owner only, shall terminate and be of no further effect ONE (1) year after the date of original retail sale. This warranty will be deemed invalid if the Product is;

- (A) Damaged or not maintained as reasonable and necessary,
- (B) Modified, altered or used as part of any conversion kits, subassemblies, or any configurations not sold by Uniden,
- (C) Improperly installed,
- (D) Repaired by someone other than an authorized Uniden Repair Agent for a defect or malfunction covered by this warranty,
- (E) Used in conjunction with any equipment or parts or as part of a system not manufactured by Uniden, or
- (F) Where the Serial Number label of the product has been removed or damaged beyond recognition.

Warranty only valid in the country of original retail/sale.

Parts Covered: This warranty covers for one (1) year, the Product and included accessories.

Statement of Remedy: In the event that the Product does not conform to this warranty at any time while this warranty is in effect, the warrantor at its discretion, will repair the defect or replace the Product and return it to you without charge for parts or service. This warranty does not provide for reimbursement or payment of incidental or consequential damages.

This EXPRESS WARRANTY is in addition to and does not in any way affect your rights under the TRADE PRACTICES ACT 1974 (Cth) (Australia) or the CONSUMER GUARANTEES ACT (New Zealand).

Procedure for obtaining performance or warranty: In the event that the Product does not conform to this warranty, the Product should be shipped or delivered, freight prepaid, with evidence of original purchase, (eg. a copy of the sales docket), to the warrantor at:

UNIDEN AUSTRALIA PTY LTD

Service Division
345 Princes Highway,
Rockdale, NSW 2216
Fax (02) 9599 3278
www.uniden.com.au

UNIDEN NEW ZEALAND LTD

Service Division
150 Harris Road, East Tamaki,
Auckland
Fax (09) 274 4253
www.uniden.co.nz



Uniden[®]

© 2007 Uniden Australia Pty Limited/Uniden New Zealand Limited
Printed in China UTZZ01938ZZ(0)

Free Manuals Download Website

<http://myh66.com>

<http://usermanuals.us>

<http://www.somanuals.com>

<http://www.4manuals.cc>

<http://www.manual-lib.com>

<http://www.404manual.com>

<http://www.luxmanual.com>

<http://aubethermostatmanual.com>

Golf course search by state

<http://golfingnear.com>

Email search by domain

<http://emailbydomain.com>

Auto manuals search

<http://auto.somanuals.com>

TV manuals search

<http://tv.somanuals.com>