Introduction

Welcome

Congratulations on your purchase of the BCT-10 Highway Information System & Scanning Radio! State-of-the-art engineering and advanced electronics provide you with a preprogrammed information radio designed for easy operation and dependability.

With the BCT-10 Scanning Radio, you can listen to hundreds of highway patrol and police frequencies, as well as a number of weather channels.

Plus, new built-in technology sounds an alarm when a highway patrol unit using a mobile extender is detected!

Best of all, you don't have to program any frequencies. Just set the BCT-10 for your state, and the scanner will do the rest. Please read this Operating Guide thoroughly before attempting to operate the unit.

Features

- Highway Patrol Detection with Strength Meter
- Local Police Coverage
- Highway Patrol Coverage
- 9 Level Strength Meter
- Windshield Mountable
- Instant Weather
- Built-in Speaker
- Pre-Programmed Scanner covers all 50 States Plus Canada

Terms and Definitions

- Frequency** Radio signals are sent as waves through the air. These waves move up and down. A frequency is the number of times in a certain time period, usually a second, that these waves move all the way up and all the way down and back to all the way up. For example: 123.44 kHz means that the waves are moving all the way up and all the way down and back all the way up again 123,440 times each second.
- Mobile Extender** When highway patrol officers step away from their cars, signals from the patrol car are sent to their portable radios via a mobile extender. The mobile extender is a transmitter/receiver that receives the signal from the station and transmits it to the portable radio on a different, but lower, frequency.
- Scanning** Scanning is the process by which your scanning radio looks for “activity” in the channels it is programmed to look at. The scanner checks each frequency for the presence of a signal, and when it finds a frequency with a signal, for example someone talking on it, it stops, allowing you to listen to the signal. The BCT-10’s Highway Patrol Alert System also looks for activity on mobile extender frequencies. When the BCT-10 detects the presence of a signal on one of these frequencies, it will trigger an audio and visual alarm.

Unpacking

Carefully remove all items from the box. If there is any visible damage, do not operate the equipment. Notify your dealer or shipping carrier immediately.

For information or instructions on any problem that you may have, call the Uniden Customer Service Center at:

(800) 297-1023 Monday through Friday,
8:00 a.m. to 5:00 p.m. Central.

Included with Your BCT-10 Scanner

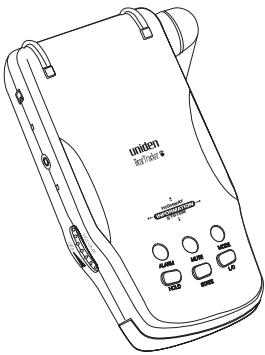

The BCT-10 Highway Information System

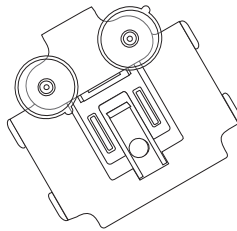

Windshield Mounting Bracket and Hardware

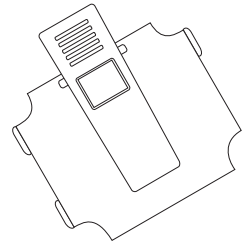

Visor Clip Mounting Bracket

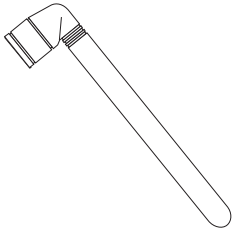

BCT-10 Antenna

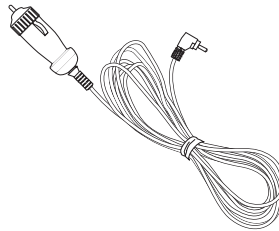

Cigarette Adapter Power Cord

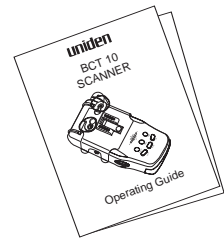

BCT-10 Operating Guide

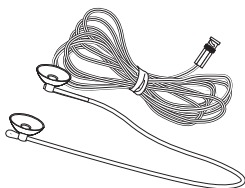

Flexible Mobile Antenna

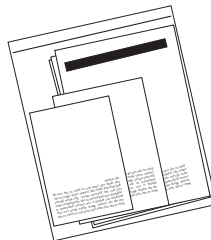

Other Printed Material

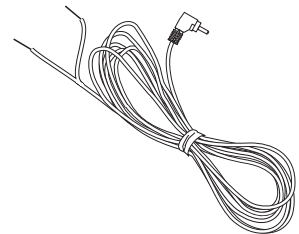

Straight Power Cord

If any of these items are missing, please contact your place of purchase.

Installation

The BCT-10 uses a highly sensitive antenna to receive radio signals. Its sensitivity and range depend on the method of installation and the direction of the antenna in relation to the signal source. Before you decide where to put your scanner, please keep in mind one important factor:

For safety, do not mount the BCT-10 in a location where it will obstruct your driving vision.

Helpful Tips

The antenna is located on the side of the unit. It should not be obstructed and should be pointed as close to straight up or down for best operation.

- Do not mount the unit in front of the heater or defroster vents.
- Do not leave the unit in direct sunlight or in the glove compartment of a closed car for long periods of time, as extreme changes in temperature may cause internal damage. Also, removing the unit from the windshield makes you less susceptible to break-in and theft.
- Be sure the BCT-10 is mounted free of obstructions from the rear view mirror, sun visors, or the ceiling of the automobile.

Installing the Antenna

BCT-10 Antenna

1. Pinch the sides of the antenna and attach it to the BCT-10.

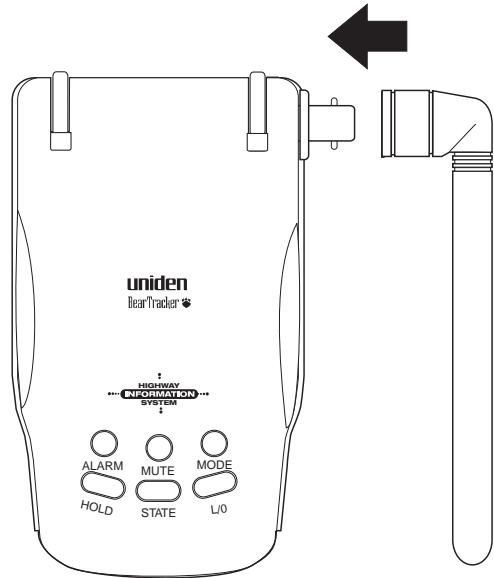

Flexible Mobile Antenna

1. Mount the antenna on the inside of the windshield at the far right-hand (passenger) side.

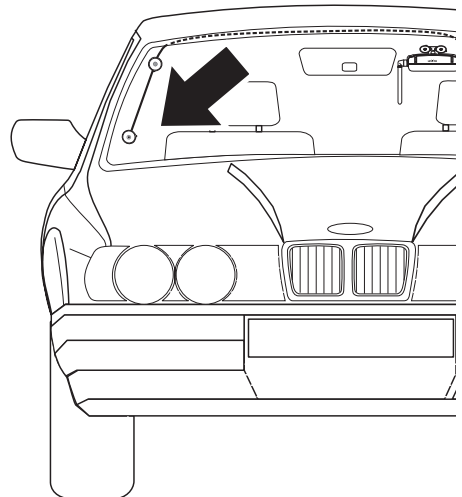

Caution: *Be sure the antenna does not obstruct the driver's vision in any way.*

2. Route the antenna cable down the edge of the windshield and around the dash.

Caution: *Be sure the cable is out of the way of anyone getting in or out of the car.*

3. Plug the cable's BNC connector into the BCT-10.



Mounting the BCT-10

Visor Mounting

1. Snap the visor clip onto the BCT-10.

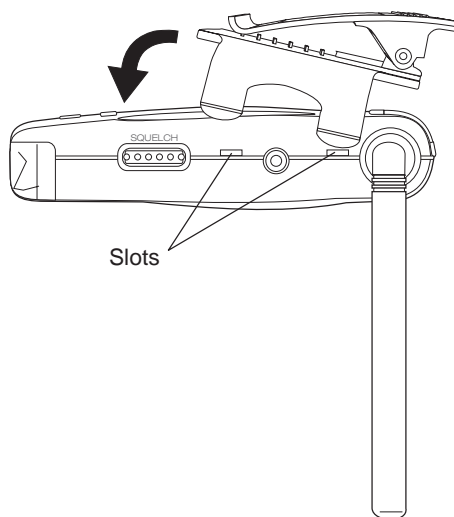

Note: *Make sure that the bracket tabs fit securely in the slots.*

2. Slide the clip over the front of the visor.

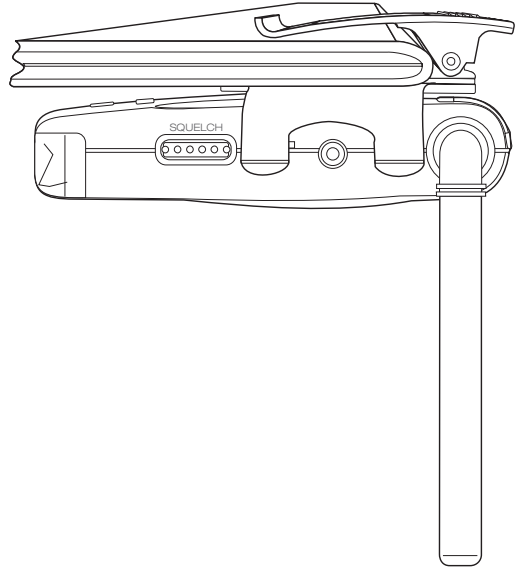

3. Adjust the angle of the antenna as close to straight up or down as possible.

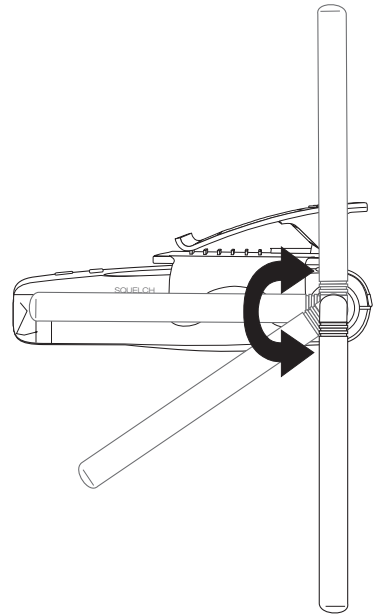

Note: You can remove and replace the BCT-10 by sliding both the unit and the visor mount off and on the visor.

Windshield Mounting

1. Find a good position for the BCT-10 on your windshield. Refer to the Helpful Tips on page 5 for some guidelines on mounting positions.

2. Put the metal mounting bracket on the windshield to adjust it for best position.

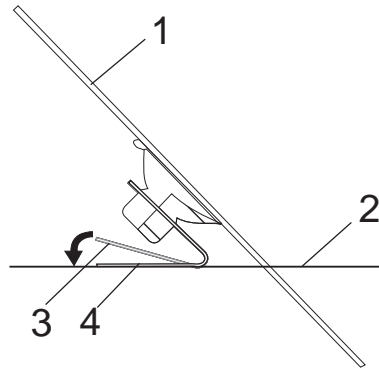

1. Windshield
2. Road Surface
3. Metal Mounting Bracket
4. Metal Mounting Bracket parallel to road

3. If necessary, adjust the metal mounting bracket so that when you slide the BCT-10 onto it, it is parallel to the road surface and fits flush against the windshield. Your BCT-10 should look like the example at the right once it is installed.

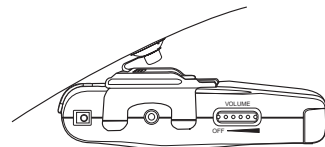
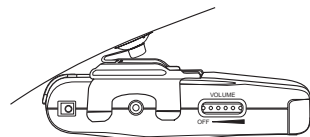
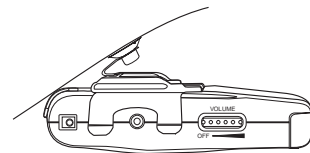

Caution: *Do Not adjust the metal mounting bracket with the BCT-10 attached. Doing so can cause damage to the bracket and the unit.*

4. Snap the windshield mounting clip onto the BCT-10.

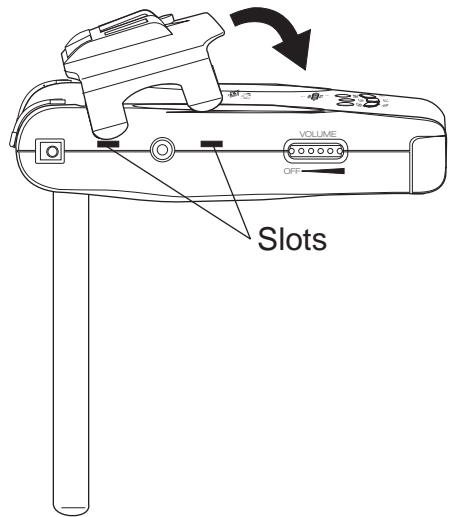

5. Slide the plastic windshield mounting clip into the the metal mounting bracket.

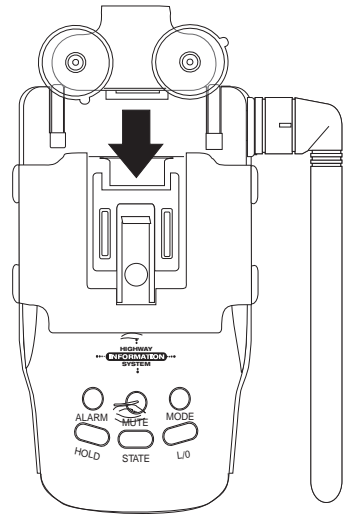

The mounting clip locks into the plastic portion at three different positions. These positions can be used for vehicles with different vertical angles of their windshields. The back position can be used for vehicles with windshields that are slanted back.

6. Place the bracket and the BCT-10 in the proper location on the windshield of your vehicle and press the suction cups firmly against the windshield. If the BCT-10 does not fit flush against the windshield, try a different position on the metal mounting bracket.

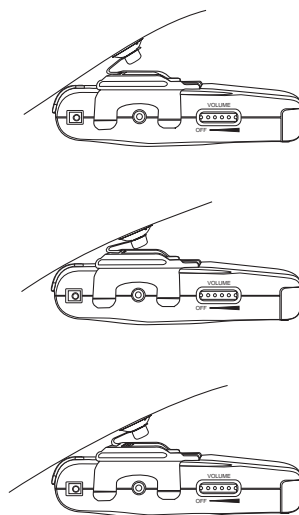

7. Adjust the angle of the antenna as close to straight up or down as possible.

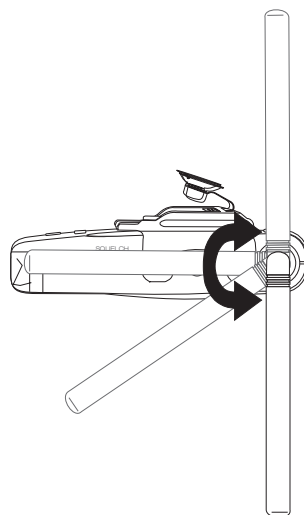

Connecting the Power

Direct Connection

WARNING: *The BCT-10 is designed to operate only with 12V DC, negative ground power systems. Operation of the unit on other voltages or polarities will cause damage to the unit and may create a fire hazard.*

The straight power cord provided with the unit has bare wires at one end, and a small connector at the other end.

1. Connect the positive wire to a 12V DC source in your vehicle's fuse box.
2. Connect the other wire to ground.

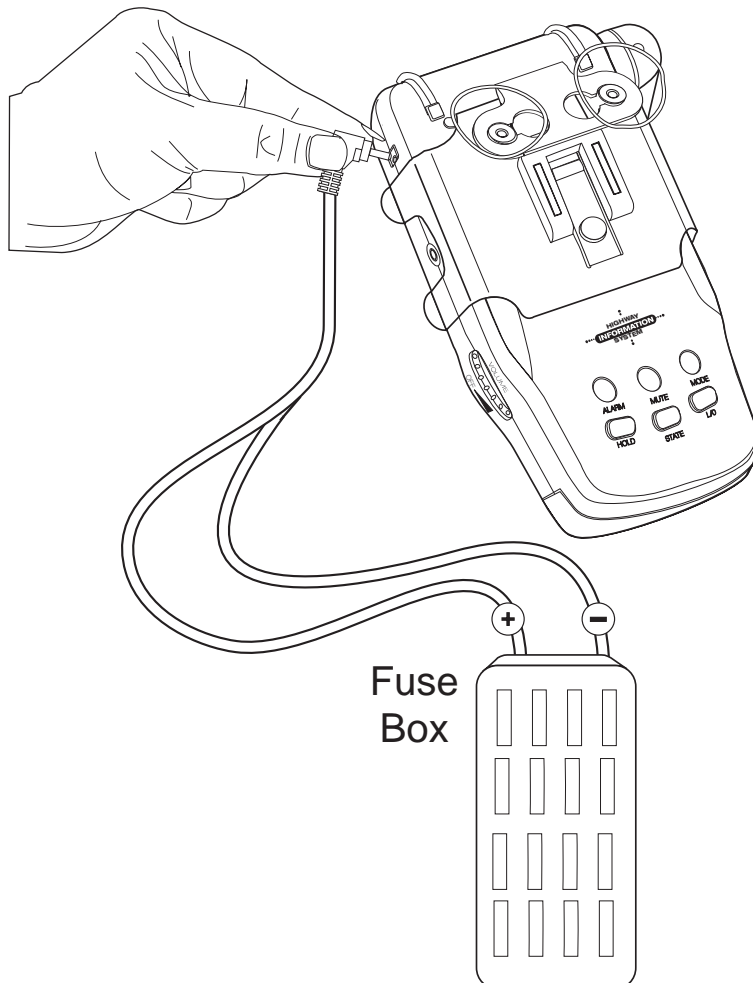

3. Run the power cord from the fuse box to the BCT-10.

Note: *Ensure the cord does not interfere with vehicle operation or cause a tripping hazard.*

4. Plug the power cord connector into the Control Unit at the jack labeled “DC 12V.”

Note: *Push the connector firmly into the jack.*

Using the Cigarette Lighter Adapter

1. Insert the small connector into the jack on the side of the unit.

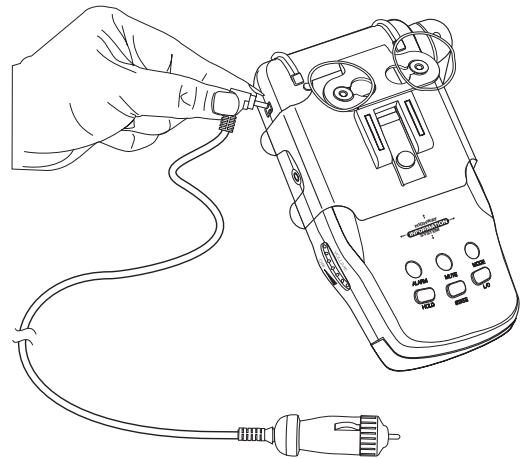

2. Insert the other end into the cigarette lighter socket of your vehicle.

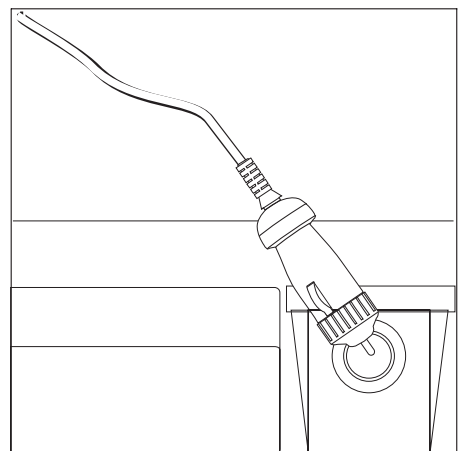

When installing the power cord, make sure that:

- The socket is clean to allow proper contact.
- The power cord does not block the antenna area of the unit.

Your unit also comes with 10 power cord mounting clips. You can use these clips to attach the power cord to the window frame or other parts of the vehicle, keeping it neat and out of the way. Use the double-sided foam tape squares to attach each clip. Slip the power cord into the clip to hold it securely in place.

Replacing the Fuse

The cigarette lighter plug contains a 1-ampere fuse to protect it from power surges.

1. To replace the fuse, unscrew the top of the plug.
2. Remove the fuse and replace it with the same type.
3. To replace the top, push in the two metal contacts and twist into place.

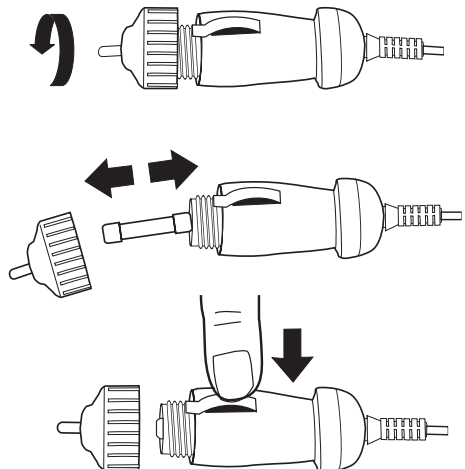

Operating Instructions

Applying Power

1. Turn the OFF/VOLUME control counter clockwise to power on the scanner. Adjust the volume about 1/4 turn.

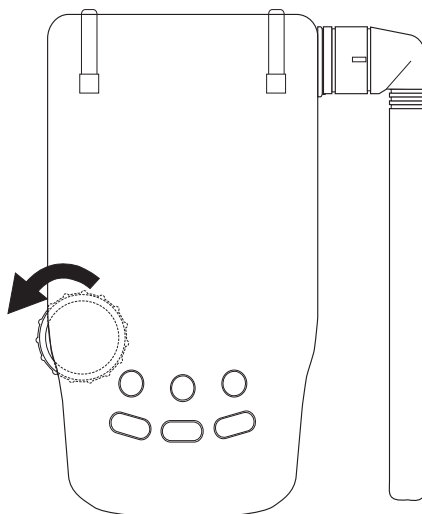

2. During power-on, a self-test is performed. Check the front control panel for proper operation.

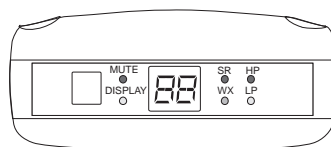

3. All the LED's on the front control panel light up and the numbers 1 through 9 count up on the LED display. An Alert tone is also sounded. This tells you that the scanner is working properly.



4. The currently selected state appears on the display. The BCT-10 always comes on with the last settings selected, and in the last mode of operation.



Adjusting the Squelch

Think of the Squelch Control as a gate.

1. Turn the SQUELCH control fully counterclockwise. This raises the “Squelch Gate” so high that no signals can get through.

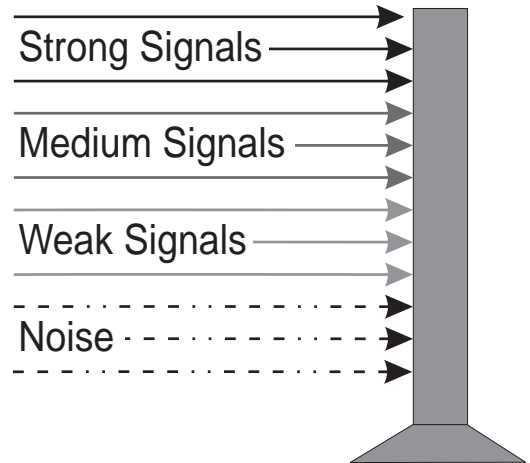
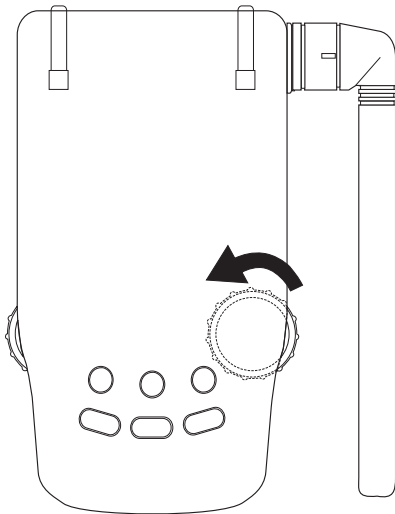

2. Turn the SQUELCH control fully clockwise until you hear a hiss. This lowers the “Squelch Gate” so that everything gets through ... noise, weak signals, and strong signals.

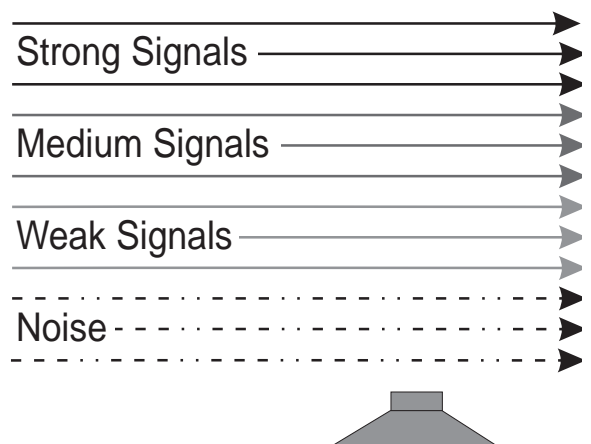
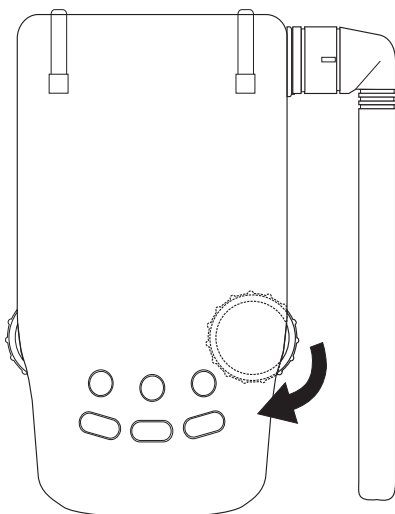

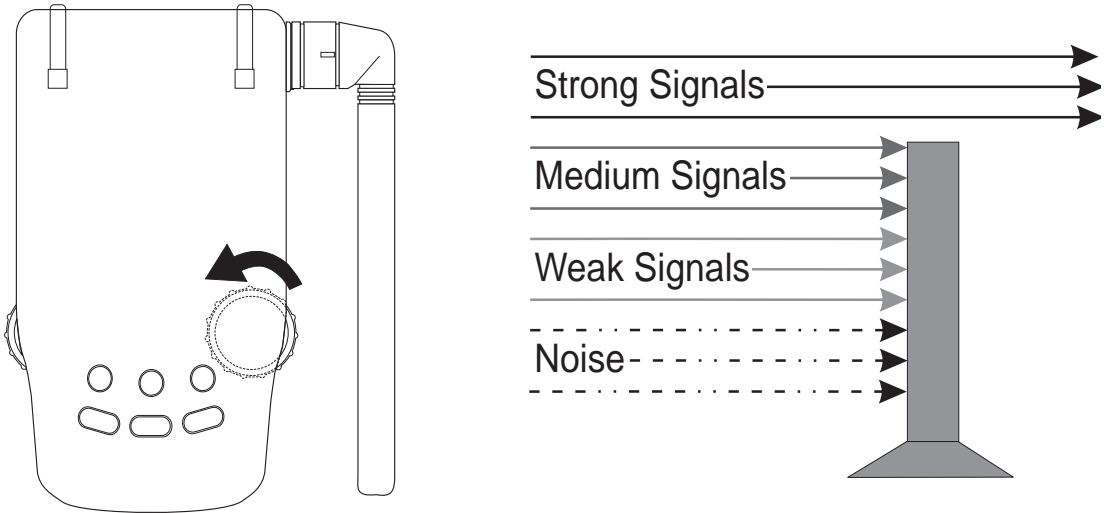

3. Turn the SQUELCH control back counter clockwise just until the hiss stops. Now the “Squelch Gate” allows only strong signals through.



4. Sometimes when you open the Squelch, you may trigger the Alert feature even though no highway patrol cars are in the area. If this happens, turn the SQUELCH control counterclockwise until the “rushing” noise stops. Then turn the BCT-10 off, and back on, to reset the Alert feature.

Note: *In metropolitan areas, you may want to adjust the Squelch control more counterclockwise to reduce the range of the Alert feature. When set fully counterclockwise, Squelch limits the Alert range to a short distance.*

Selecting the State

1. Select the state you are operating in by pressing the  key repeatedly. If you press and hold the  key for 2 seconds, the selector moves rapidly through all the states and Canadian provinces.

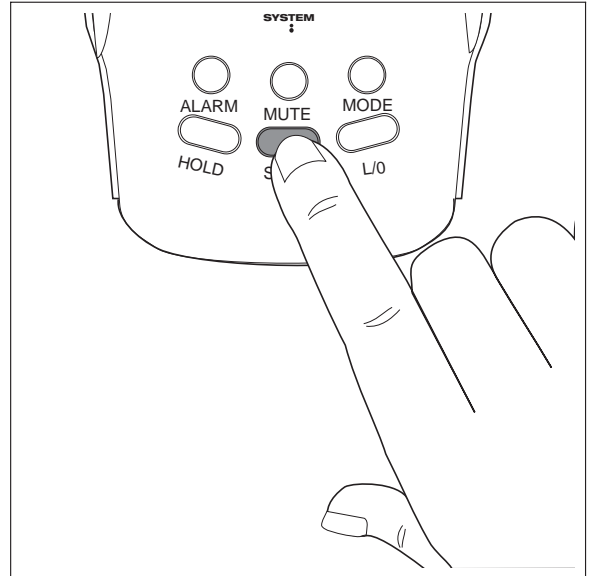

2. The state code appears on the display. See the following page for a list of State codes.



Note: *The state codes are in alphabetical order by abbreviation.*



State Codes

Code	State	Code	State
AK	Alaska	NM	New Mexico
AL	Alabama	NV	Nevada
AR	Arkansas	NY	New York
AZ	Arizona	OH	Ohio
CA	California	OK	Oklahoma
CO	Colorado	OR	Oregon
CT	Connecticut	PA	Pennsylvania
DC	District of Columbia	RI	Rhode Island
DE	Delaware	SC	South Carolina
FL	Florida	SD	South Dakota
GA	Georgia	TN	Tennessee
HI	Hawaii	TX	Texas
IA	Iowa	UT	Utah
ID	Idaho	VA	Virginia
IL	Illinois	VT	Vermont
IN	Indiana	WA	Washington
KS	Kansas	WI	Wisconsin
KY	Kentucky	WV	West Virginia
LA	Louisiana	WY	Wyoming
MA	Massachusetts	AB	Alberta
MD	Maryland	BC	British Columbia
ME	Maine	MB	Manitoba
MI	Michigan	NB	New Brunswick
MN	Minnesota	NF	Newfoundland
MO	Missouri	NS	Nova Scotia
MS	Mississippi	NT	Northwest Territories
MT	Montana	ON	Ontario
NC	North Carolina	PE	Prince Edward Island
ND	North Dakota	PQ	Quebec
NE	Nebraska	SK	Saskatchewan
NH	New Hampshire	YT	Yukon Territories
NJ	New Jersey	XX	All Frequencies

Selecting the Frequencies to Scan

Scanning All Frequencies

Note: The Alert feature is not active in this mode.

1. To scan all frequencies (except Weather), press the  key repeatedly or press and hold the  key until “XX” is blinking on the LED display.



2. All frequencies, except weather channels, are scanned for an active transmission.

3. When the BCT-10 finds an active frequency it activates a built-in two second delay before it resumes scanning.



Note: The  key does not operate in XX mode.

Scanning Highway Patrol Frequencies

1. To scan highway patrol frequencies exclusively, press the  key repeatedly until HP is blinking in the LED display.

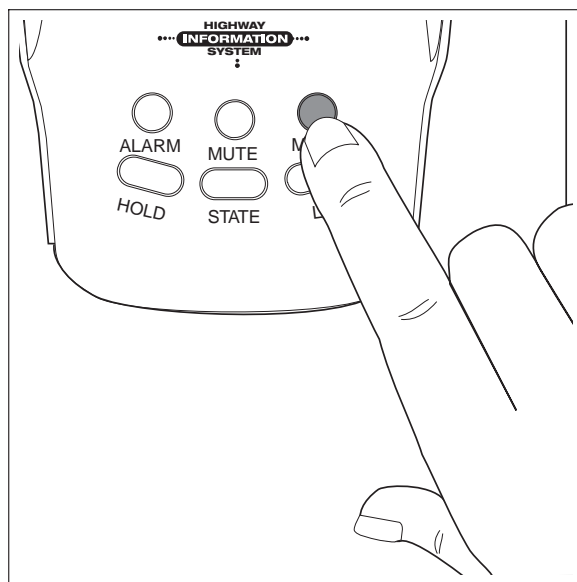

2. The HP LED lights up.



3. While scanning, the BCT-10 displays the state code for the state you selected. When the BCT-10 detects an active frequency, it displays HP in the LED. and stops for two seconds before it resumes scanning.



Scanning All Police Frequencies

1. To scan highway patrol and local police frequencies, press the  key repeatedly until LP is blinking on the LED display.

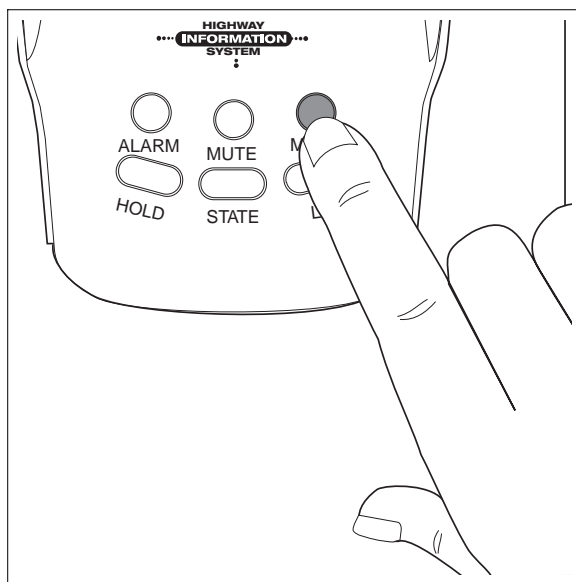

2. The LP and HP LED's will light up.



3. While scanning, the BCT-10 displays the state code for the state you selected. When the BCT-10 detects an active frequency, it displays LP when monitoring an active local police frequency and HP when monitoring an active highway patrol frequency. The BCT-10 will stop for two seconds, and then resume scanning with the state code displayed on the LED.

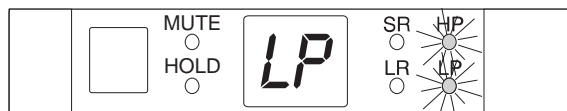

Highway Patrol Alarm

In most cases, when you are within three miles of a highway patrol unit, and a mobile extender is in use, your BCT-10 will set off a visual and audible alarm. The signal strength will be displayed, and the LED will return to the HP display. The time the ALARM LED will stay on depends on the signal strength.

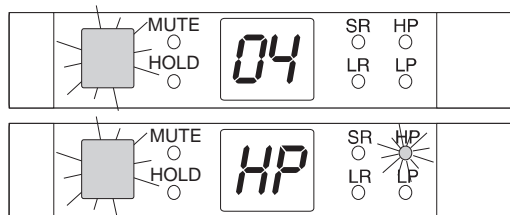

Strength	Duration
1 - 2	3 Minutes
3 - 5	2 Minutes
6 - 8	1 Minute
9	30 Seconds

Setting the Highway Patrol Alarm Range

A range setting is always active for the highway patrol alert. You can set the range for either standard or long range. Signal strength is measured from 1- 9. In standard mode, only signals above a level 5 strength will trigger an audible alert tone. In long range mode, all signal strengths from 1- 9 will trigger an alert tone. To select the range:

1. Press and Hold the  key for 2 seconds.

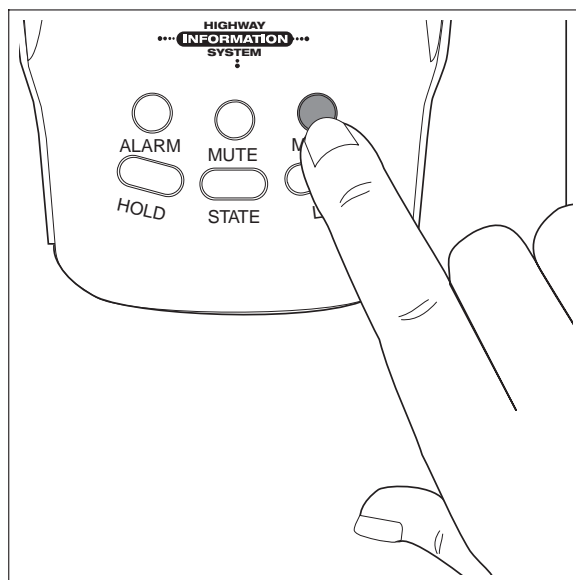

- The LR and SR LED's toggle and you hear two short beeps once either standard or long range mode is selected.



Setting the Highway Patrol Alarm Volume

You can set the Alert Tone volume to either Low, Medium, or High. To change the Alert Tone volume:

- Press the  Key.

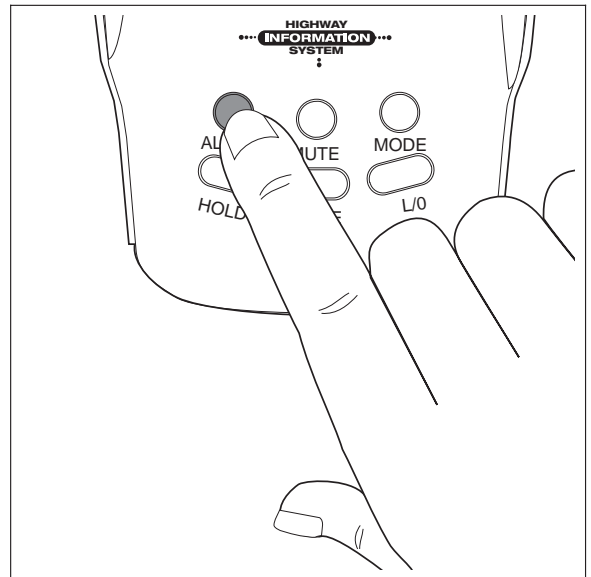

- You hear a beep and the LED will display L (low), M (medium), or H (high).

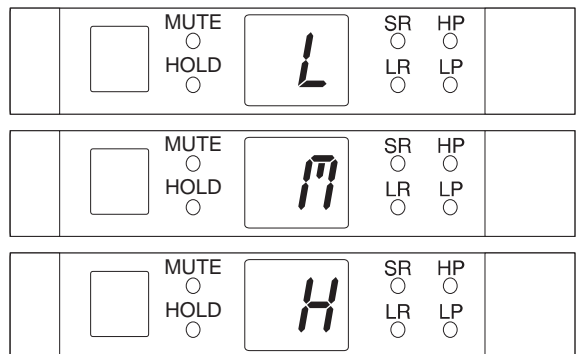

Muting the Highway Patrol Alarm

While in the highway patrol mode you can turn off the alarm tone during the time you are listening to a frequency or disable the alarm tone permanently. To disable the alarm tone while listening to a frequency:

1. While in the highway patrol mode and after you receive an alarm tone, press the  key.

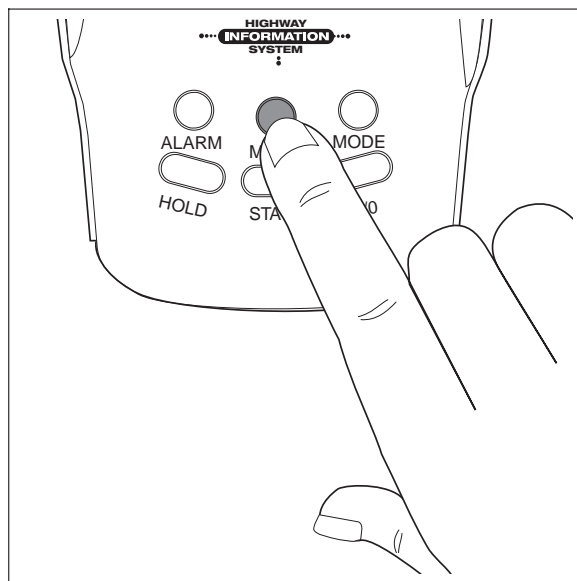

2. The MUTE LED flashes.



Note: Only the alarm tone will be disabled. You will still receive highway patrol alarms but only the ALARM LED will come on.

3. To enable the Alert Tone again, press the  key again.

Note: When the ALARM LED goes off, the mute mode will no longer be on.

To disable the alarm tone permanently:

1. Press and Hold the  key for two seconds.

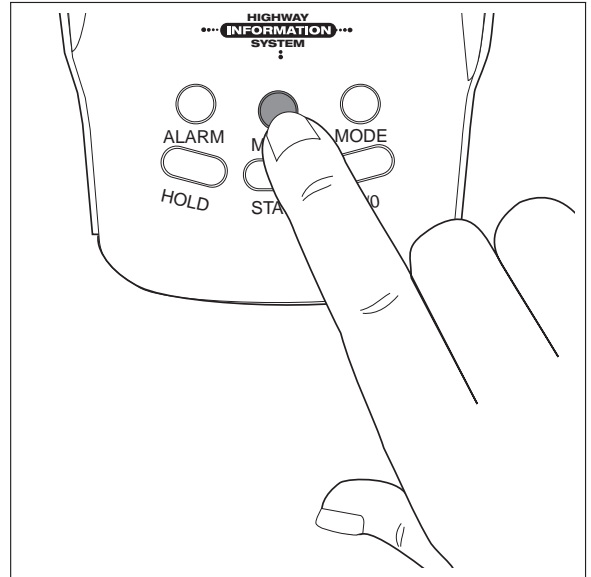

2. You hear a two beeps and the MUTE LED comes on.

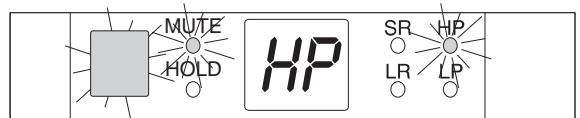

Note: When the MUTE LED is on and not flashing, you can receive highway patrol alarms, but the alarm tone does not sound.

Monitoring Weather Frequencies

1. To monitor weather frequencies, press the  key repeatedly until WX is blinking on the LED display.

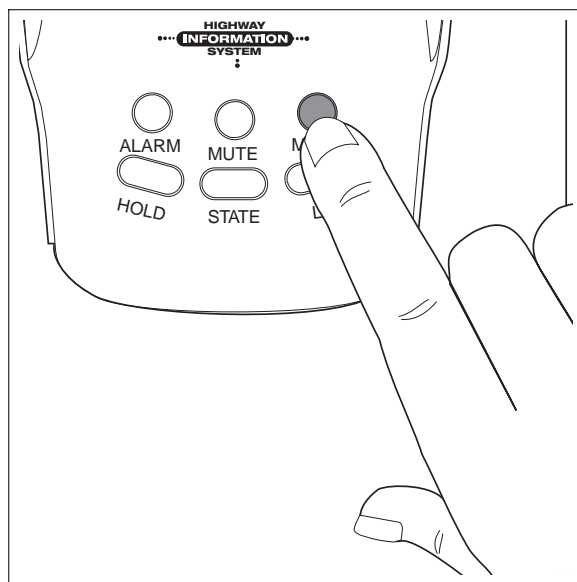

2. While scanning, the BCT-10 will display WX. When the BCT-10 detects an active frequency, it displays the weather channel in the LED and stops scanning.

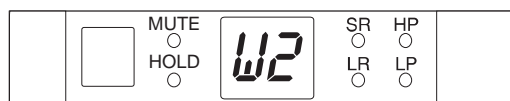

3. Press the  key to make the BCT-10 scan for the next weather frequency.

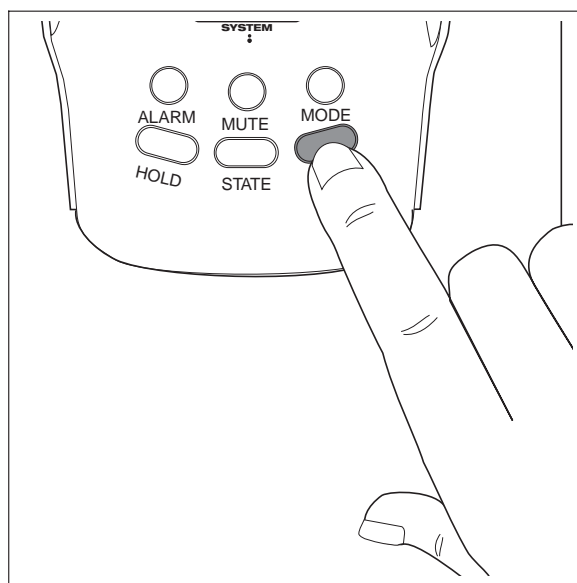

Deleting Frequencies

Some frequencies that have been preprogrammed into your BCT-10 may not be of immediate interest to you, or a frequency may be experiencing interference. You can lock out that frequency from scanning.

1. When the scanner stops on the undesired frequency, press  one time.

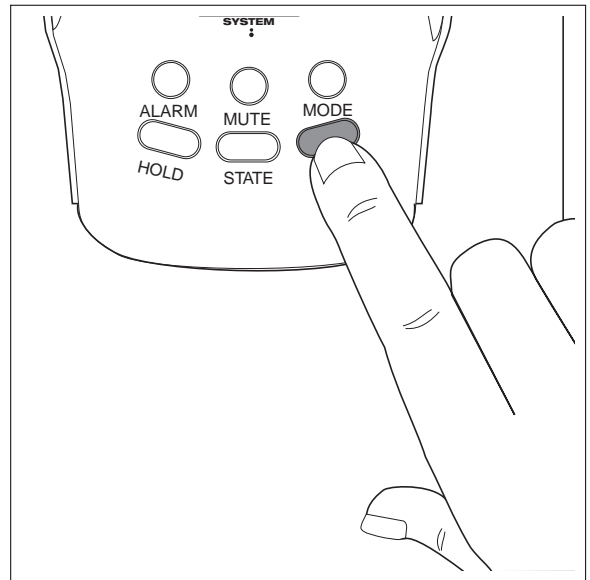

2. To lock out additional frequencies, repeat Step 1.

Note: *You can delete a maximum of 50 frequencies. Although it is possible to delete the highway patrol alarm frequencies, this should never be done unless absolutely necessary for proper operation of your BCT-10. This causes the highway patrol alarm feature to be inactive on that frequency. No further alarms will be received until the deleted frequencies are restored or a new state is selected.*

Caution: *When you lock out more than 50 frequencies, the first locked out frequency is deleted. You cannot lock out all of the alarm, local police, and highway patrol frequencies. If you lock out all of the frequencies by accident, the BCT-10 will sound two short beeps.*

Restoring Deleted Frequencies

Please note that you can only restore all deleted frequencies at the same time.

To restore the deleted frequencies:

1. Make sure the BCT-10 is not scanning. To stop the unit from scanning, turn the SQUELCH knob toward the front of the BCT-10.

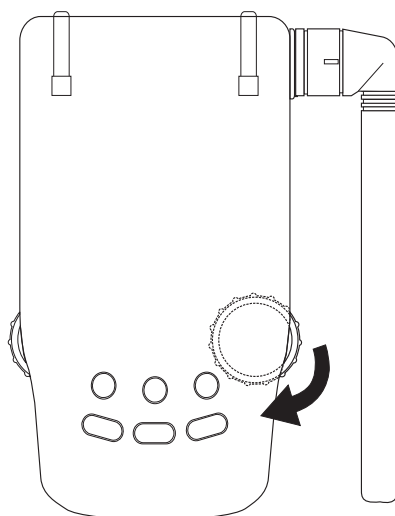

2. Press and hold the  key until you hear two beeps.

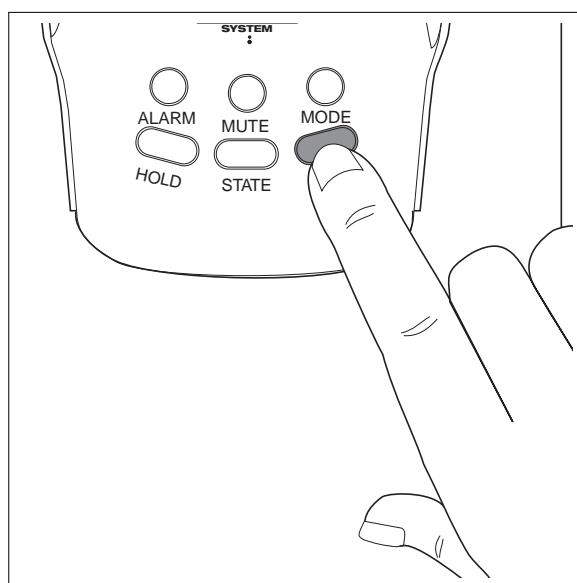

3. All deleted frequencies are now restored.

Using HOLD to Stay on a Selected Frequency

When scanning stops on a desired frequency, you can lock onto that frequency for as long as you like.

To monitor only one frequency:

1. When the scanner stops on the desired frequency, press the  key.

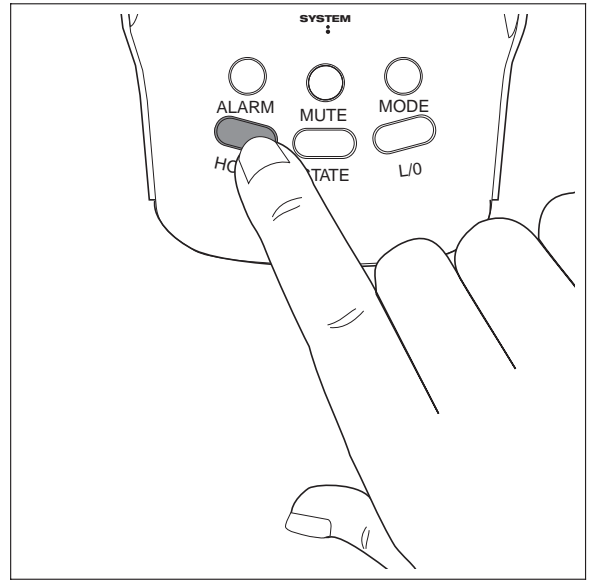

2. The LED display now indicates the service, either highway patrol or local police, you are monitoring. The scanner remains on that frequency until you cancel the Hold mode by pressing .

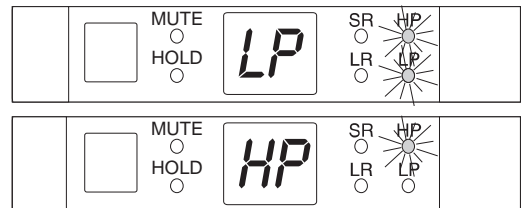

Note: While in the Hold mode, the Alarm feature is inactive!

3. To resume scanning and reactivate the Alert feature, press the  key.

If the BCT-10 stops on an undesired frequency, press the  key twice to force the unit to start scanning again before the end of that transmission.

BE CAREFUL!! *When you are in the Hold mode, there will be no Alert tones or Warning light, even if you are on the Alert frequency.*

REMEMBER!! *When you apply power, the BCT-10 comes on to exactly the same service and in exactly the same mode as when last turned off. If you are monitoring an Alert frequency in the Hold mode when you turn the BCT-10 off, it will come back to that Alert frequency in Hold mode when you turn it back on. The Alert feature will be inactive. To restore the Alert feature, press the  key.*

Memory Backup

Your BCT-10 has a memory backup system that remembers your frequency selections and deletions when you turn off the unit. This memory lasts permanently without any external power to the unit.

Birdies

All radios are subject to receiving undesirable signals. If your scanner stops during Scan mode and no sound is heard, press the  key twice to resume scanning.

Troubleshooting

If your BCT-10 is not performing properly, try the steps listed below.

PROBLEM	POSSIBLE SOLUTION
Scanner is not working properly.	Check power cord and in-line fuse. Check the Volume and Squelch settings.
Signal is weak or distorted.	Check antenna and antenna connection, or change antenna.
Improper reception.	Check antenna and antenna connection, or change antenna. Reposition scanner.
Scan won't stop.	Check Squelch adjustment. Check antenna and antenna connection, or change antenna.
Incomplete reception.	Fringe area of reception. Check Squelch adjustment.
Weather Search (WX) won't work.	Check Squelch adjustment. No active station within range.

If you still cannot get satisfactory results and you wish to receive product information or return the unit for service, please call or write the Uniden Parts and Service Division at:

Uniden America Corporation
4700 Amon Carter Blvd.
Fort Worth, TX 76155
(800) 297-1023 Monday through Friday,
8:00 a.m. to 5:00 p.m. Central

Optional Accessories

The following optional accessories for your BCT-10 are available from your local Uniden Dealer or through the Uniden Customer Service Center by calling: (800) 297-1023, 8:00 a.m. to 5:00 p.m. Central, Monday through Friday.

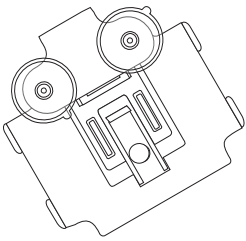

Windshield Mounting
Bracket and Hardware

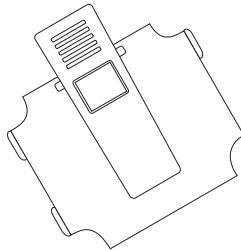

Visor Clip Mounting
Bracket

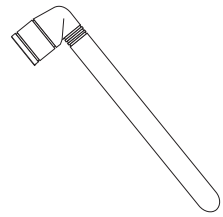

BCT-10 Antenna

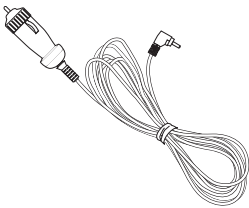

Cigarette Adapter
Power cord

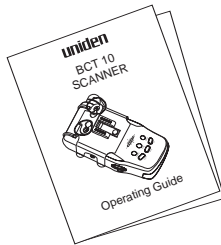

BCT-10 Operating
Guide

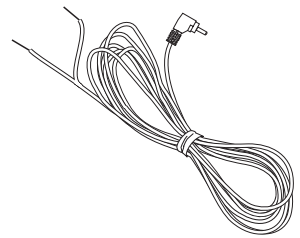

Straight Power Cord

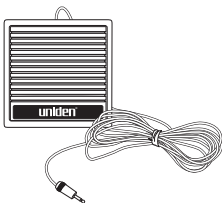

External Speaker

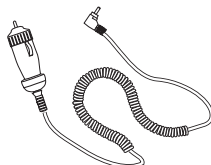

Coiled Cigarette Adapter

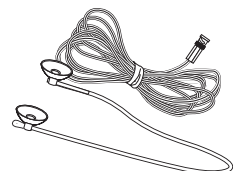

Flexible Mobile Antenna

Specifications

Size:	76W X 136.5D X 33H
Weight:	180 g
Power:	13.8 VDC
Operating Temperature:	-20° C (-4° F) to +60° C (+140° F)
Antenna:	50Ω impedance
RF Sensitivity:	
(FM 12dB signal to noise ratio at 3kHz deviation)	
	37.02 - 46.02 MHz 0.3μV
	138.3450 - 172.0200 MHz 0.4μV
	423.0000 - 508.4875 MHz 0.5μV
Frequency Coverage:	VHF Low Band
	37.02 - 46.02 MHz
	VHF High Band
	138.3450 - 172.0200 MHz
	UHF Band
	423.0000 - 508.4875 MHz
Audio output:	Max 1W

Certified in accordance with FCC Rules and Regulations Part 15 as of date of manufacture.

Specifications are typical and subject to change without notice.

uniden®
Bearcat®

BearTracker 

BCT-10



**HIGHWAY INFORMATION SYSTEM &
PREPROGRAMMED WARNING SCANNER**

Operating Guide

UBZZ01258ZZ

Precautions

Before you use this scanner, please observe the following:

WARNING!





Uniden America Corporation does not represent this unit to be waterproof. To reduce the risk of fire, electrical shock, or damage to the unit, do not expose this unit to rain or moisture.

IMPORTANT!

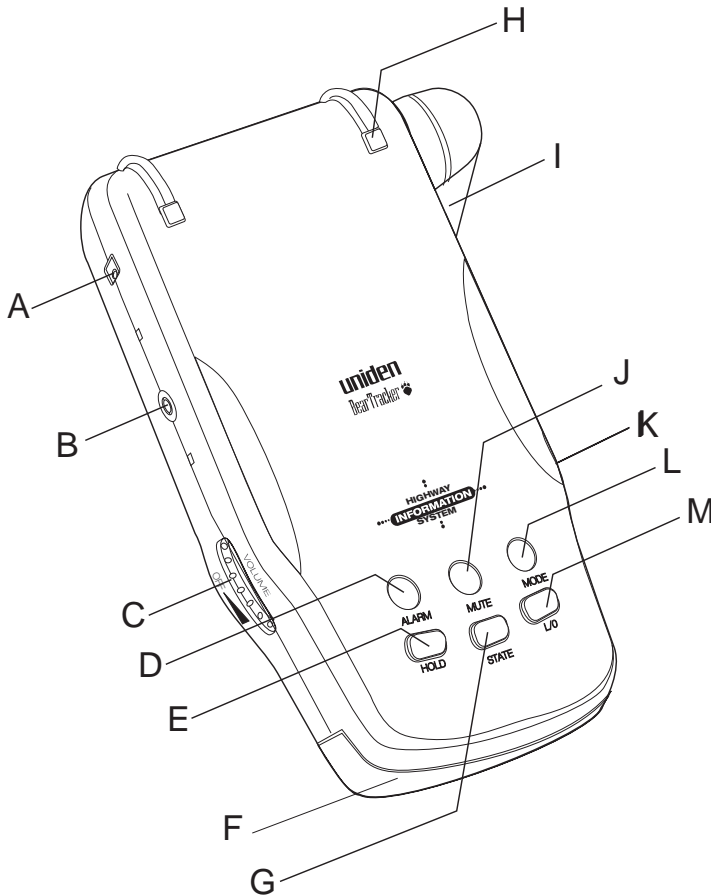
The installation, possession, or use of this scanning radio in a motor vehicle may be prohibited, regulated, or require a permit in certain states, cities, and/or local jurisdiction. Your local law enforcement officials should be able to provide you with information regarding the laws in your community.

Controls and Indicators



- A. DC Input
- B. Speaker Out
- C. On/Off Volume
- D. ALARM Key 
- E. HOLD Key 
- F. Control Panel
- G. STATE Key 
- H. Windshield Bumpers
- I. Antenna
- J. MUTE Key 
- K. Squelch Control
- L. MODE Key 
- M. L/O (Lock Out) Key 

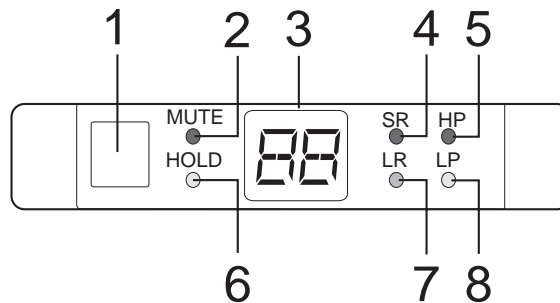

- 1. ALARM LED
- 2. MUTE LED
- 3. 2 Digit LED Display
- 4. Standard Range LED
- 5. Highway Patrol LED
- 6. HOLD LED
- 7. Long Range LED
- 8. Local Police LED

CONTENTS

Introduction.....	1
Welcome	1
Features.....	1
Terms and Definitions	2
Unpacking	3
Included with Your BCT-10 Scanner	4
Installation	5
Helpful Tips	5
Installing the Antenna	6
BCT-10 Antenna.....	6
Flexible Mobile Antenna	6
Mounting the BCT-10.....	7
Visor Mounting	7
Windshield Mounting	9
Connecting the Power	12
Direct Connection	12
Using the Cigarette Lighter Adapter.....	13
Replacing the Fuse	14
Operating Instructions	15
Applying Power	15
Adjusting the Squelch	16
Selecting the State.....	18
State Codes	19
Selecting the Frequencies to Scan	20
Scanning All Frequencies.....	20
Scanning Highway Patrol Frequencies	21
Scanning All Police Frequencies	22
Highway Patrol Alarm.....	23
Setting the Highway Patrol Alarm Range	23
Setting the Highway Patrol Alarm Volume	24
Muting the Highway Patrol Alarm	25
Monitoring Weather Frequencies	27
Deleting Frequencies	28
Restoring Deleted Frequencies	29
Using HOLD to Stay on a Selected Frequency.....	30
Memory Backup	31
Birdies	31
Troubleshooting.....	32
Optional Accessories.....	33
Specifications	34

One Year Limited Warranty

Important: Evidence of original purchase is required for warranty service.

WARRANTOR: UNIDEN AMERICA CORPORATION (“Uniden”)

ELEMENTS OF WARRANTY: Uniden warrants, for one year, to the original retail owner, this Uniden Product to be free from defects in materials and craftsmanship with only the limitations or exclusions set out below.

WARRANTY DURATION: This warranty to the original user shall terminate and be of no further effect 12 months after the date of original retail sale. The warranty is invalid if the Product is (A) damaged or not maintained as reasonable or necessary, (B) modified, altered, or used as part of any conversion kits, subassemblies, or any configurations not sold by Uniden, (C) improperly installed, (D) serviced or repaired by someone other than an authorized Uniden service center for a defect or malfunction covered by this warranty, (E) used in any conjunction with equipment or parts or as part of any system not manufactured by Uniden, or (F) installed or programmed by anyone other than as detailed by the Operating Guide for this product.

STATEMENT OF REMEDY: In the event that the product does not conform to this warranty at any time while this warranty is in effect, warrantor will repair the defect and return it to you without charge for parts, service, or any other cost (except shipping and handling) incurred by warrantor or its representatives in connection with the performance of this warranty. THE LIMITED WARRANTY SET FORTH ABOVE IS THE SOLE AND ENTIRE WARRANTY PERTAINING TO THE PRODUCT AND IS IN LIEU OF AND EXCLUDES ALL OTHER WARRANTIES OF ANY NATURE WHATSOEVER, WHETHER EXPRESS, IMPLIED OR ARISING BY OPERATION OF LAW, INCLUDING, BUT NOT LIMITED TO ANY IMPLIED WARRANTIES OF MERCHANTABILITY OR FITNESS FOR A PARTICULAR PURPOSE. THIS WARRANTY DOES NOT COVER OR PROVIDE FOR THE REIMBURSEMENT OR PAYMENT OF INCIDENTAL OR CONSEQUENTIAL DAMAGES. Some states do not allow this exclusion or limitation of incidental or consequential damages so the above limitation or exclusion may not apply to you.

LEGAL REMEDIES: This warranty gives you specific legal rights, and you may also have other rights which vary from state to state. This warranty is void outside the United States of America.

PROCEDURE FOR OBTAINING PERFORMANCE OF WARRANTY: If, after following the instructions in this Operating Guide you are certain that the Product is defective, pack the Product carefully (preferably in its original packaging). Include evidence of original purchase and a note describing the defect that has caused you to return it. The Product should be shipped freight prepaid by traceable means, or delivered, to warrantor at:

Uniden America Corporation
Parts and Service
4700 Amon Carter Blvd.
Fort Worth, TX 76155
(800) 297-1023, 8:00 am to 5:00 pm Central, Monday through Friday

PAT. UNDER ONE OR MORE OF THE FOLLOWING
U.S. PATENT NUMBERS:

3,883,808, 3,961,261, 3,962,644, 3,974,450
3,974,452, 3,987,400, 3,996,521, 3,996,522
4,000,468, 4,027,251, 4,057,760, 4,092,594
4,100,497, 4,114,103, 4,123,715, 4,153,877
4,156,193, 4,157,505, 4,179,662, 4,219,821
4,270,217, 4,398,304, 4,409,688, 4,455,679
4,461,036, 4,521,915, 4,627,100, 4,888,815
4,932,074, 4,947,456, 5,014,348, DES 253,173
DES 272,737, RE 31,523

uniden®
Beancat®

Free Manuals Download Website

<http://myh66.com>

<http://usermanuals.us>

<http://www.somanuals.com>

<http://www.4manuals.cc>

<http://www.manual-lib.com>

<http://www.404manual.com>

<http://www.luxmanual.com>

<http://aubethermostatmanual.com>

Golf course search by state

<http://golfingnear.com>

Email search by domain

<http://emailbydomain.com>

Auto manuals search

<http://auto.somanuals.com>

TV manuals search

<http://tv.somanuals.com>