

Uniden®

TRU 8885

SERIES

OWNER'S

MANUAL

OWNER'S MANUAL

Contents

WELCOME/FEATURES	2	Deleting a Caller ID Message	52
TERMINOLOGY	3	Using the Caller ID Message List	53
CONTROLS & FUNCTIONS	4	Call Waiting Deluxe Features	55
DISPLAY AND ICONS	6	THE INTEGRATED ANSWERING DEVICE	56
SOFT KEY FUNCTION	8	The Integrated Telephone Answering Device	56
GETTING STARTED	9	Turning the Answering System On/Off	57
Setting up the Phone	9	Setting your outgoing message (Greeting)	57
Mounting the Base Unit on a Wall	13	Using the Answering Setup Menu	58
Main Menu Options	15	New Message LED	58
Setting Menu Options	16	Using your Answering System	59
BASICS	33	Remote Operation	63
Making and Receiving Calls	33	EXPANDING YOUR PHONE	67
Flash and Call Waiting	34	Expanding Your Phone	67
Placing a Call on Hold	34	Connecting the Charger	68
Redialing a Call	35	Register the Handset	68
Adjusting the Earpiece and Speaker Volume	37	Using DirectLink Mode	70
Do Not Disturb (DND)	37	Intercom/Call Transfer Feature	71
Mute Microphone	38	ADDITIONAL INFORMATION	74
Tone Dialing Switch-over	39	Changing the Digital Security Code	74
Traveling Out of Range	39	Find Handset	74
Privacy Mode	40	Installing the Beltclip	75
3 or 4-Way Conferencing	40	Headset Installation	75
PHONEBOOK	42	Note on Power Sources	76
Phonebook (Storing Phone Numbers, Names, Distinctive Rings and Speed Dial)	42	Maintenance	76
Chain Dialing	43	General Information	77
Steps for Entering Names and Special Characters	44	TROUBLESHOOTING	78
Viewing the Phonebook	46	Troubleshooting	78
Making Calls Using the Phonebook	47	Liquid Damage	81
Speed Dialing	47	PRECAUTIONS & WARRANTY	82
Editing or Erasing a Phonebook Entry	48	I.C. NOTICE	84
Copying Phonebook Entries	49	MEMORY LIST	85
CALLER ID	50	INDEX	86
Caller ID and CIDCW (Caller ID on Call Waiting)	50	REMOTE OPERATION CARD	88
Viewing the Caller ID List	51	MAIN MENU FLOW CHART	90

Welcome

Congratulations on your purchase of the Uniden Multi-Handset Cordless System telephone. This unit is different from conventional cordless telephones. When the base unit is connected to AC power and a telephone line, it can support up to 10 handsets. You can now place a fully-featured cordless handset anywhere in your home or office where AC power is available to connect the handset chargers. Extra handsets also allow you to establish a 4-way conference call among 2 handsets, the base speakerphone, and an outside line.

Note: Some illustrations in this manual may differ from the actual unit for explanation purposes.

As an Energy Star® Partner, Uniden has determined that this product or product models meets the Energy Star® guidelines for energy efficiency. Energy Star® is a U.S. registered mark.



Features

- 5.8GHz Digital Expandable
- Integrated Answering Device
- Dual Keypad with LCD Screen at Base
- 10 Multi-Handset Expandability
- Hands-Free Speakerphone in the Handset and Base
- Caller ID/Caller ID on Call Waiting (subscribe through local telephone company)
- Call Waiting Deluxe (subscribe through local telephone company)
- 100 Programmable Memory Locations
- Trilingual Display Options and Voice Prompts (English, French and Spanish)
- Intercom/Call Transfer Between Handsets
- 20 Distinctive Ring Options (10 ringer tones and 10 melody ringers)
- Mute and Hold Features
- Do Not Disturb (DND) Feature
- DirectLink™ Mode
- Room/Baby Monitoring
- Battery Level Indicator
- Clock Display
- Animation Displays

This series features **AutoTalk™** and **AutoStandby™**. AutoTalk allows you to answer a call by just removing the handset from the cradle so you don't have to waste time pushing buttons. AutoStandby allows you to hang up by simply returning the handset to the cradle.

To protect you against mis-billed calls that might result from your phone being activated by other equipment, this series has **Random Code™** digital security, which automatically selects one of over approx. 65,000 digital security codes for the handset and base.

Digital Spread Spectrum Technology uses a wider frequency band than standard digital transmissions. The result is a more secure conversation with the clarity of digital sound, extended range, and minimal interference from other cordless phones.

IntegriSound™ Built in sound quality which provides life-like conversations.

With **DirectLink™** mode, you can use 2 or more handsets as radio transceivers (walkie-talkies).

Be sure to visit our web site: www.uniden.com

Uniden® is a registered trademark of Uniden America Corporation.

AutoTalk, AutoStandby, DirectLink, IntegriSound and Random Code are trademarks of Uniden America.

Terminology

- **Standby Mode** - The handset is not in use, and **talk/flash** or **speaker** has not been pressed. No dial tone is present.
- **Talk Mode** - The handset is not in the cradle, and **talk/flash** or **speaker** has been pressed, enabling a dial tone. Talk appears on the display.

Controls & Functions

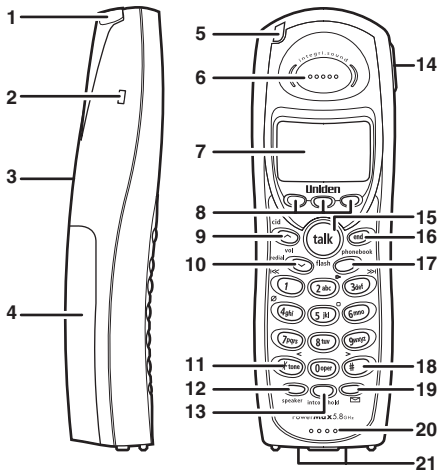

**Retrieve TAD message
with Handset Remote keys**



1. Handset Antenna
2. Beltclip Hole
3. Speakerphone Speaker and Ringer
4. Handset Battery Compartment
5. New Message LED
6. Handset Earpiece
7. LCD Display
8. **soft** Keys (P. 8)
9. **cid/vol/∧** (volume up) (P. 37 & 16)
10. **redial/p/vol/∨** (volume down) (P. 35, 33, 16 & 37)
11. ***/tone/<** (P. 39 & 44)
12. **speaker** (P. 33)
13. **intcom/hold** (P. 71 & 34)
14. Headset Jack Cover
15. **talk/flash** (P. 33 & 34)
16. **end** (P. 33)
17. **phonebook** (P. 42)
18. **#/>** (P. 44)
19. **Message** (P. 65)
20. Handset Microphone
21. Handset Charging Contacts

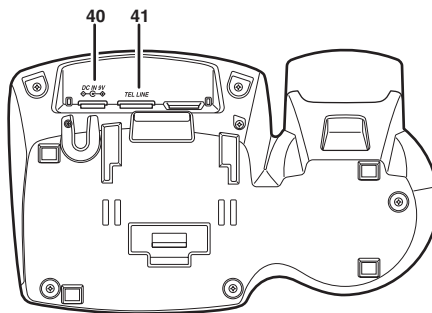
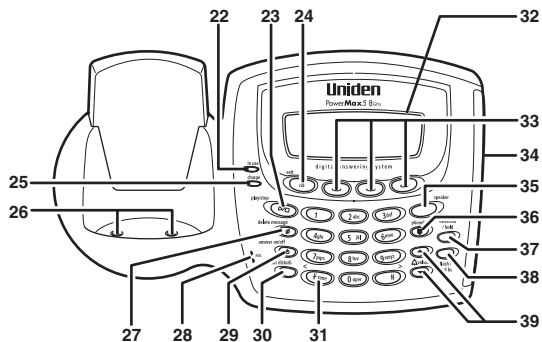

22. In use LED

23. ▽/□ **play/stop** (P. 59)

24. **cid/exit** (P. 51)

25. Charge LED

26. Base Charging Contacts

27. ∅ **delete message** (P. 60)

28. **mic** (microphone)

29. Ⓞ **answer on/off** (P. 57)

30. **do not disturb** (P. 37)/DND LED

31. ✕/tone (P. 39)

32. Message Counter Display

33. **soft** Keys (P. 8)

34. Base Speaker

35. **speaker**/speaker LED (P. 33)

36. **phonebook** (P. 42)

37. **intercom/hold** (P. 71 & 34)

38. **flash/find hs** Key (P. 34 & 74)

39. ▲/volume/▲/▼ (volume up/down)
(P. 37 & 16)

40. **DC IN 9V** Jack

41. **TEL LINE** Jack

Display and Icons

Example of the standby mode display

•Handset



- Ringer off icon (when the ringer is off)/ day of the week and time / battery icon
- Handset ID and Banner
- Number of new Caller ID calls received (If there are no new Caller ID messages, the Handset ID appears here.)

•Base

* Status of your Answering machine



- Day of the week and time
- Number of new Caller ID calls received

** Number of message

* appears if you have a new message.

appears if you turn your answering system off.

** appears when the message storage is full.

appears if you set your answering system to announce only.

ICON	Appears During	DESCRIPTION
	Standby/Talk	Battery icons indicate the handset battery status. This icon changes depending on the battery status (empty, low, medium and full).
	Standby	The Ringer off icon indicates that ringer is turned off.
	Talk	The Mute icon appears when you mute the handset or base.
	Talk	The Speaker icon appears when the handset speaker phone is used (handset only).
	Talk	The Privacy icon appears when the Privacy Mode is turned on.
	Talk	The Recording icon appears while recording a conversation.

Animation Displays (Handset only)

The handsets have a variety of animation displays. Below are examples of the animation screens and what they mean:

Turning on the phone

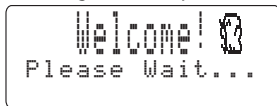

Hanging up the phone



Confirmation (Done!)

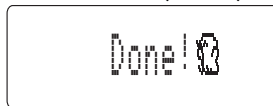

Deleting (Deleted!)

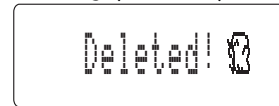

Making a call



Find Handset/Paging the Handset



Also, the animation display changes depending on the ringer volume setting.

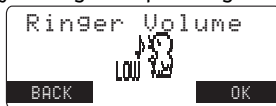
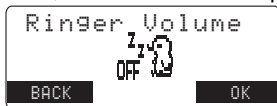

Out of Range



Unavailable



Low Battery

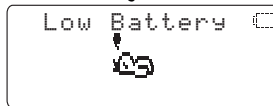

Soft Key Function

"Soft" keys are keys that change function during the operation of the phone. There are three soft keys on the base and three on each handset.

The function of each soft key is determined by the icon that appears directly above it. For example, when the base is in standby mode, pressing soft key 1 will redial the last number. When the base is in talk mode, pressing soft key 1 will mute the microphone.

Complete information on the features controlled by the soft keys can be found under each feature.

In standby mode Handset

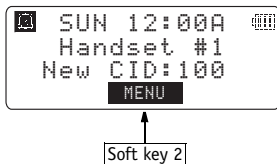

In talk mode Handset

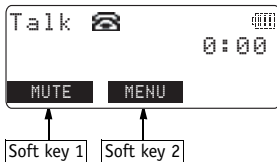

Base

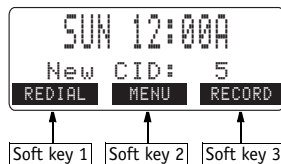

Base

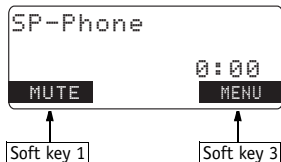



note

For maximum range:

- Keep the antenna free of obstruction.
- When the handset is not in use place the handset in an upright position.
- Do not hold the handset where you would block the signal.

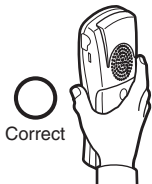

- Metal and reinforced concrete may affect cordless telephone performance.

Setting up the Phone

A. Choose the best location

When choosing a location for your new phone, here are some important guidelines you should consider:

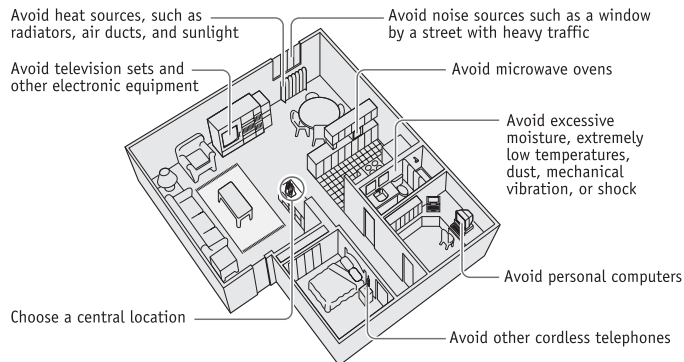

- The location should be close to both a phone jack and a continuous power outlet (one which is not connected to a switch).
- The base and handset should be kept away from sources of electrical noise such as motors, microwave ovens, and fluorescent lighting.
- For better reception, place the base as high as possible.
- The base should be placed in an open area for optimum range and reception.
- If your home has specially wired alarm equipment connected to phone line, be sure that installing the system does not disable your alarm equipment. If you have questions about what will disable alarm equipment, contact your telephone company or a qualified installer.

B. Install the rechargeable battery pack into the handset, and charge for at least 15-20 hours before using!

The handset is powered by a rechargeable battery pack. The battery recharges automatically when the handset is placed in the base unit. To maximize the charge capacity of your battery pack, **DO NOT** plug the telephone cord into the base unit and wall jack until the battery is fully charged.

- 1) Press down on the handset battery case cover (use the finger indention for a better grip) and slide the cover downward to remove.
- 2) Turn the battery pack so that the connector with the red and black wires is near the jack inside the battery compartment. Match the connector's wire colors to the polarity label in the battery compartment (the connector notches fit into the grooves of the jack only one way). Push the battery pack connector into the jack until it clicks into place.
- 3) Make sure you have a good connection by gently pulling on the battery wires. If the connection is secure, the battery jack will remain in place.
- 4) Place the battery case cover back on the handset and slide it upwards until it clicks into place.
- 5) Place the handset in the base unit for 15-20 hours without interruption. The base unit's LED light (labeled **charge**) illuminates once the handset is placed in the base. The LED light will illuminate whether the battery pack is connected or not.

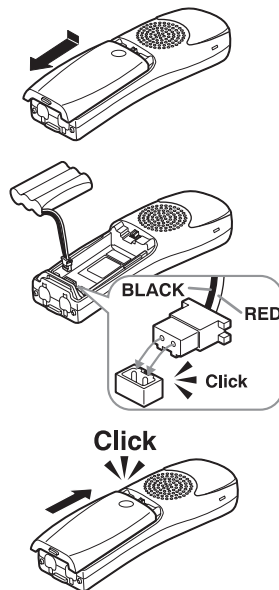

The battery may be purchased by calling Uniden's Parts Department (see back cover page).



Even when the battery pack is not being used, it will gradually discharge over a long period of time. For optimum performance, be sure to return the handset to the base unit after each telephone call.

Low battery alert

When the battery pack is very low, the phone is programmed to eliminate functions in order to save power.

The battery pack needs to be charged when:

- The empty battery icon appears.
- Low Battery appears in the display.

If the phone is in standby mode, none of keys will operate. If you are on a call, complete your conversation as quickly as possible, and return the handset to the cradle.

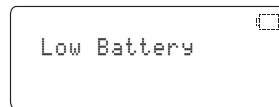

Cleaning the battery charging contacts

To maintain a good charge, it is important to clean the charging contacts on both the handset and the base unit once a month. Using water only, dampen a cloth to clean the charging contacts. Then make sure to go back over the charging contacts with a dry cloth before returning the handset to the base to charge.

Caution: Do not use paint thinner, benzene, alcohol, or other chemical products. Doing so may discolor the surface of the telephone and damage the finish.

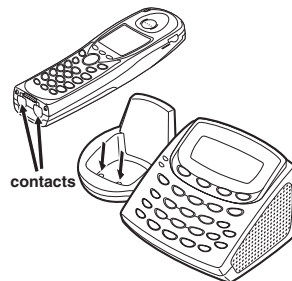

C. Connect the base unit

- 1) Connect the AC adapter to the **DC IN 9V** jack and to a standard 120V AC wall outlet.
Connect the AC adapter to a continuous power supply (i.e., an outlet that is not controlled by a switch).
- 2) Set the base on a desk or tabletop, and place the handset in the base unit.
Place the base unit close to the AC outlet so that you can unplug the AC adapter easily.
- 3) Make sure that the **charge** LED illuminates.
If the LED does not illuminate, check to see that the AC adapter is plugged in and the handset makes good contact with the base charging contacts.

After installing the battery pack in the handset, charge your handset for at least **15-20 hours before plugging into the phone line.**

- 4) Once the handset battery pack is fully charged, connect the telephone line cord to the **TEL LINE** jack and to a telephone outlet.



If your telephone outlet isn't modular, contact your telephone company for assistance.

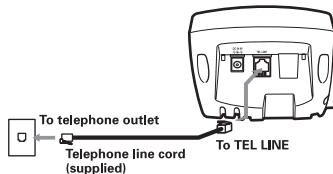
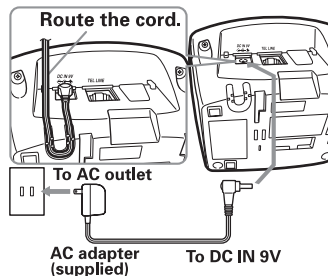

Modular



- Use only the supplied [AD-830] AC adapter. Do not use any other AC adapter.
- Place the power cord so that it does not create a trip hazard or where it could become chafed and create a fire or electrical hazard.



DO NOT use an AC outlet controlled by a wall switch.

Mounting the Base Unit on a Wall

Standard wall plate mounting

This phone can be mounted on any standard wall plate.

- 1) Make the AC adapter and the telephone line cord through the hole on the wall mount adapter.
- 2) Plug the AC adapter into the **DC IN 9V** jack.
- 3) Plug the telephone line cord into the **TEL LINE** jack.
- 4) Slide the wall mount adapter into the notches on the base.
- 5) Plug the AC adapter into a standard 120V AC wall outlet. Hook the cord on the notch of the wall mount adapter.
- 6) Plug the telephone line cord into the telephone outlet. Hook the cord on the notch of the wall mount adapter.
- 7) Align the mounting slots on the base with the mounting posts on the wall. Then push in and down until the phone is firmly seated.

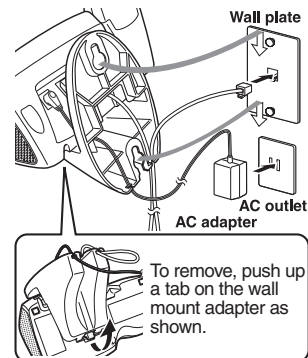
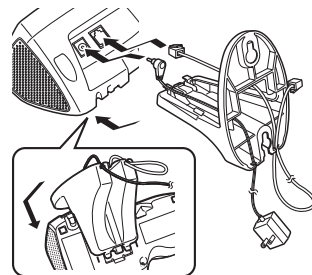

Direct wall mounting

If you don't have a standard wall plate, you can mount your phone directly to the wall. Before doing this, consider the following:

- Avoid electrical cables, pipes, or other items behind the mounting location that could cause a hazard when inserting screws into the wall.
 - Try to mount your phone within 5 feet of a working phone jack to avoid excessive lengths.
 - Make sure the wall material is capable of supporting the weight of the base and handset.
 - Use #10 screws (minimum length of 1 & 3/8 inches) with anchoring devices suitable for the wall material where the base unit will be placed.
- 1) Insert two mounting screws into the wall (with their appropriate anchoring device), 3 & 15/16 inches apart. Allow about 1/8 of an inch between the wall and screw heads for mounting the phone.
 - 2) Refer to steps 1 through 7 on page 13 to mount the telephone.

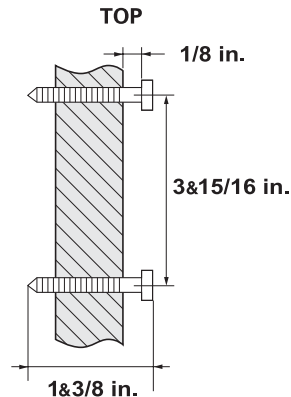



- For Global Setup, Answ. Setup, and Deregister HS menu options, make sure the line is not in use and the handsets are within range of the base.
- For a flow chart of the main menu, see page 90.

Main Menu Options

Your phone has seven main menu options: **DirectLink Mode**, **Room Monitor**, **Handset Setup**, **Base Setup**, **Answ. Setup**, **Global Setup** and **Deregister HS**. You can change **Room Monitor**, **Answering Setup**, and **Global Setup** settings from the base or from any handset. **DirectLink Mode**, **Handset Setup**, and **Deregister HS** are only available from a handset. **Base Setup** is only available from the base.

Default Settings

The default settings set from the factory match the features that most people use. You may not need to change them. However, there are a number of options you must set and entries you must make in memory to take full advantage of all the phone features. The table below lists the default settings.

Function	Handset	Base	Function	Handset	Base
Ringer Tone	Flicker		Day & Time	SUN 12:00 AM	
Ringer Volume	High		CW / CWDX	CW on/CWDX off	
Distinctive Ring	On	-	Dial Mode	Tone	
Auto Talk	Off	-	Area Code	None	-
Anykey Answer	Off	-	Security Code	80	
Banner	" "	-	Record Time	1 minute	
Language	English		Ring Time	Toll Saver	
(LCD) Contrast	Level 5		Message Alert	Off	
Key Touch Tone	On	-	Call Screen	On	
Animation Screen	On	-			
Room Monitor (allow monitoring)	On	-			

Setting Menu Options

Entering the Menu

- 1) In standby mode, press the **MENU** soft key.
- 2) Use **volume up/down** to move the pointer to a desired main menu (DirectLink Mode, Room Monitor, Handset Setup, Base Setup, Answ. Setup, Global Setup, and Deregister HS).
- 3) Press the **OK** soft key to select the desired main menu. To return to the previous screen, press the **BACK** soft key.
- 4) Use **volume up/down** to select a desired submenu and then press the **OK** soft key to enter.
- 5) In the submenu option, use **volume up/down** to select an item. Press the **OK** soft key to confirm your selection. For detailed instructions, see the following sections for the desired submenu option. To return to the previous screen, press the **BACK** soft key.
- 6) To exit the menu, press **end** on the handset or **cid/exit** on the base.

•Handset



•Base





You must have at least two handsets to use DirectLink Mode.

DirectLink Mode (Handset only)

In DirectLink mode, a pair of handsets can function as two-way radios. DirectLink Mode allows two handsets to communicate with each other without the base unit or a telephone line. Use them at sporting events or while shopping to stay in contact with family members or friends. You must set both handsets to DirectLink Mode activate this feature.

Using DirectLink Mode

- 1) Enter the DirectLink Mode menu. To enter DirectLink mode Press [ENTER] appears.
- 2) Press the **ENTER** soft key to enter the DirectLink Mode. You will hear a confirmation tone, and DirectLink Mode Complete appears.
- 3) To return back to the normal mode, press the **CANCEL** soft key and then the **OK** soft key, or return the handset to the cradle.

```
To enter
DirectLink mode
Press [ENTER]
BACK      ENTER
```

Room/Baby Monitor

This feature allows you to monitor sounds in another room. Place the base or a handset in the room you wish to monitor; it will function as a microphone. A second handset can be set to function as a remote speaker, allowing you to monitor sounds in the room.

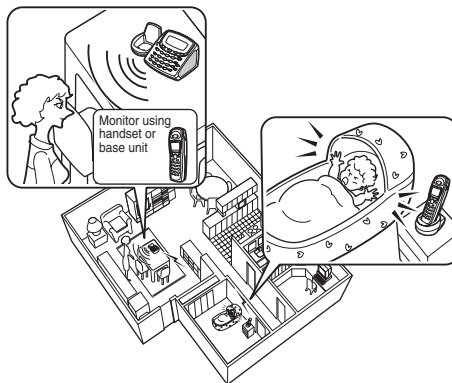

Using Room/Baby Monitor

- 1) Enter the Room Monitor menu (see "Entering the Menu" on page 16).
Listen to; appears.
- 2) Select the handset or base you want to monitor by using **volume up/down**.
- 3) Press the **OK** soft key.
Monitoring appears, and you hear sounds in the room where the handset or the base is installed.
- 4) To turn off the Room Monitor, press the **END** soft key, or **end**.



If you want to prevent other handsets or the base from monitoring this handset, press the **MENU** soft key. Select the Handset Setup menu, and then the Room Monitor submenu. Select **Off** and press the **OK** soft key.

Handset Setup / Base Setup

The following submenu options must be set separately for each handset and the base.

Selecting a Ringer Volume

Ringer volume lets you choose from one of three ringer volumes.

From the handset

- 1) Press the **MENU** soft key. Select the Handset Setup menu, and then the Ringer Volume submenu.
- 2) Press **volume up/down** to select **HIGH**, **LOW**, or **OFF**.
- 3) Press the **OK** soft key. You will hear a confirmation tone.

From the base

In standby mode, press **volume up/down** to select one of three ringer volumes (Off, Low, or High).

Selecting a Ringer Tone (Handset only)

Ringer tone lets you choose from 10 ringer tones or 10 melodies:

- Ringers (Flicker, Clatter, Soft Alert, Wake Up, Light Bug, Beep Boop, Tone Board, Chip Chop, Party Clap, Reminder)
- Melodies (Beethoven's Symphony #9 [Beethoven9], For Elise [Elise], We Wish You A Merry Christmas [Merry- Xmas], Home Sweet Home [Hm Swt Hm], Lorri Song #6 [Lorri Song], When the Irish Eyes Are Smiling [Irish Eyes], Aura Lee, Let Me Call You Sweet Heart [Sweetheart], Star Spangled Banner [Star Spngl], Old MacDonald [Old MacDld])

- 1) Enter the Handset Setup menu, and then the Ringer Tones submenu (see "Entering the Menu" on page 16).
- 2) Press **volume up/down** to move the pointer. You will hear the ringer or melody as you scroll through the options.
- 3) Press the **OK** soft key. You will hear a confirmation tone.

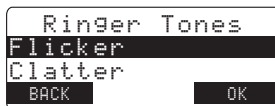

Distinctive Ringer Setup (Handset only)

Distinctive Ringer allows you to assign a designated ring tone to a stored phonebook number. When a call is received and the Caller ID information matches the information in one of the phonebook memory locations, the phone uses the distinctive ring assigned to that particular Caller. You can assign distinctive rings to multiple phonebook memory locations. Switching the setting to Distinctive Off disables distinctive ringing: all incoming calls will have a normal ring tone. Switching to Distinctive On activates all programmed distinctive ring memory locations.

- 1) Enter the Handset Setup menu, and then the Distinct. Ring submenu (see "Entering the Menu" on page 16).
- 2) Press **volume up/down** to select On or Off.
- 3) Press the **OK** soft key. You will hear a confirmation tone.

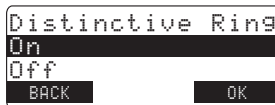

Setting the AutoTalk (Handset Only)

AutoTalk allows you to answer the phone simply by removing the handset from the cradle. You do not have to press any buttons to answer the call.

- 1) Enter the Handset Setup menu, and then the AutoTalk submenu (see "Entering the Menu" on page 16).
- 2) Press **volume up/down** to select On or Off.
- 3) Press the **OK** soft key. You will hear a confirmation tone.

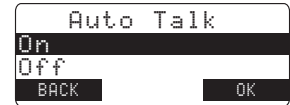

Setting the Anykey Answer (Handset only)

Anykey Answer allows you to answer the phone by pressing any number key, ***/tone/<**, or **#/>** on the handset.

- 1) Enter the Handset Setup menu, and then the Anykey Answer submenu (see "Entering the Menu" on page 16).
- 2) Press **volume up/down** to select On or Off.
- 3) Press the **OK** soft key. You will hear a confirmation tone.



Setting the True Banner (Handset only)

True Banner lets you customize the name your handset displays.

The name will be displayed on the LCD screen during Standby Mode, Intercom, Intercom Hold, Room Monitor and Copy Phonebook operation. The banner name will be displayed on the receiving handset as well.

- 1) Enter the Handset Setup menu, and then the Banner submenu (see "Entering the Menu" on page 16).
- 2) Use the number keypad (**0-9**), ***/tone/<**, **#/>**, or the **DELETE** soft key to enter or edit the name.
- 3) Press the **OK** soft key. You will hear a confirmation tone.



Selecting a Language

Language selects which language the menu display will use. Choose from English, French, or Spanish.

- 1) Enter the Handset Setup or the Base Setup menu, and then the Language submenu (see "Entering the Menu" on page 16).
- 2) Press **volume up/down** to choose English, Français (French), or Español (Spanish).
- 3) Press the **OK** soft key. You will hear a confirmation tone.

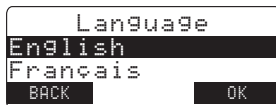

Adjusting the LCD Contrast

Contrast adjusts the handset LCD brightness. Choose one from the 10 levels for optimum viewing.

- 1) Enter the Handset Setup or the Base Setup menu, and then the LCD Contrast (for handset) or the Contrast (for base) submenu (see "Entering the Menu" on page 16).
- 2) Press ***volume up/down*** to adjust the contrast of the LCD (10 levels).
- 3) Press the **OK** soft key. You will hear a confirmation tone.

Setting the Key Touch Tone (Handset only)

Key Touch Tone is the tone your keypad makes when keys are pressed. You can turn this tone on or off.

- 1) Enter the Handset Setup menu, and then the Key Touch Tone submenu (see "Entering the Menu" on page 16).
- 2) Press ***volume up/down*** to select On or Off.
- 3) Press the **OK** soft key. You will hear a confirmation tone.



Setting the Animation Screen (Handset Only)

The Animation Screen displays animation on the handset LCD (see page 7). The animations will be displayed on the LCD screen during a call, ringer volume setting, paging operation, when you hang up and so on.

- 1) Enter the Handset Setup menu, and then the Animation Screen submenu (see "Entering the Menu" on page 16).
- 2) Press **volume up/down** to select On or Off.
- 3) Press the **OK** soft key. You will hear a confirmation tone.



See "Animation Displays (Handset only)" on page 7 for all the available screens.

Answering System Setup

This main menu option allows you to set up the built in answering device.

Record a Personal Outgoing Message (Base Only)

Record Greeting allows you to record a personal outgoing message (greeting) which the answering system automatically plays when you receive a call.

- 1) Enter the Answ. Setup menu, and then the Record Greeting submenu (see "Entering the Menu" on page 16). To record greeting press [START] appears.
- 2) Press the **START** soft key. You will hear "Record Greeting." The message counter displays 30 and then begins to count down.



- The greeting must be more than 2 seconds long, or it will not be recorded.

- To delete the personal outgoing message, press the **DELETE** soft key while the message is playing. The system announces "Greeting has been deleted."

- 3) Position yourself near the base microphone and record your greeting.
- 4) When you are finished recording, press the **STOP** soft key. Your greeting will playback for confirmation.

Selecting Your Greeting (Base only)

Select Greeting allows you to choose between the two outgoing messages, a pre-recorded message or your own greeting.

- 1) Enter the Answ. Setup menu, and then the Select Greeting submenu (see "Entering the Menu" on page 16). `Play back greeting` appears, and the current outgoing message is played. LCD is an example if you recorded your greeting.



- 2) Once you have recorded a personal greeting, press the **CHANGE** soft key to choose the greeting. The selected outgoing message is played. Each time you press the **CHANGE** soft key, the phone switches the outgoing message between the prerecorded and the personal outgoing message.

Setting a PIN Code

Security Code selects a two-digit Personal Identification Number (PIN) code. A PIN code is required to play your messages from a remote location.

- 1) Enter the Answ. Setup menu, and then the Security Code submenu (see "Entering the Menu" on page 16).
- 2) Enter a two-digit PIN code (01-99) using the number keypad (**0-9**).

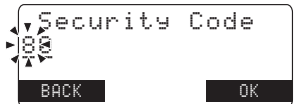

3) Press the **OK** soft key. You will hear a confirmation tone.

Setting the Ring Time

Ring Time allows you to set the number of rings the caller hears before your answering system plays the outgoing message. You can set the ring time to answer after two, four, or six rings. If you enable the Toll Saver (TS), the answering system picks up after two rings if you have new messages and after four rings if there are none.

- 1) Enter the Answ. Setup menu, and then the Ring Time submenu (see "Entering the Menu" on page 16).
- 2) Press **volume up/down** to select a Ring Time (Toll Saver, 2 Times, 4 Times, or 6 Times).
- 3) Press the **OK** soft key. You will hear a confirmation tone.



Setting the Record Time

Record Time sets the duration for recording the incoming messages. You have three record time options. The options "1 minute" or "4 minutes" set the duration for recording the incoming messages. "Announce only" answers the call but prevents the caller from leaving a message.

- 1) Enter the Answ. Setup menu, and then the Record Time submenu (see "Entering the Menu" on page 16).
- 2) Press **volume up/down** to select Record Time (1 Minute, 4 Minutes, or Announce Only).
- 3) Press the **OK** soft key. You will hear a confirmation tone.



Setting the Message Alert On or Off

Message Alert sounds an alert tone when you have an unheard message. If you set the Message Alert on, the alert tone will sound every 15 seconds when a new message is received.

- 1) Enter the Answ. Setup menu, and then the Message Alert submenu (see "Entering the Menu" on page 16).
- 2) Press **volume up/down** to select `On` or `Off`.
- 3) Press the **OK** soft key. You will hear a confirmation tone.



Turning the message alert tone off by pressing any key

To quickly turn off the Message Alert tone, press any key on the base unit; the tone will automatically deactivate.

Turning the message alert tone off from a remote location

When all new messages are played back using the remote playback feature (see pages 63 to 66), the Message Alert tone will automatically deactivate. The tone will not deactivate until all new messages are played back.

Setting the Language of your Answering System

Language allows you to set the language of your answering system announcements to English, French, or Spanish.

- 1) Enter the Answ. Setup menu option, and then the Language submenu (see "Entering the Menu" on page 16).
- 2) Press **volume up/down** to choose English, Français (French), or Español (Spanish).
- 3) Press the **OK** soft key. You will hear a confirmation tone.

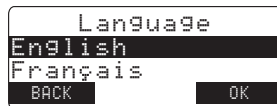

Setting the Call Screen

Call screen allows you to listen to an incoming call before answering.

- 1) Enter the Answ. Setup menu and then the Call Screen submenu (see "Entering the Menu" on page 16).
- 2) Press **volume up/down** to select On or Off.
- 3) Press the **OK** soft key. You will hear a confirmation tone.





- Any changes to the global settings menu affect all registered handsets and the base.
- For setting the Day and Time, the idle time-out is extended to 2 minutes.

Global Setup

If you change one of the global settings, you change that setting for all additional handsets. Only one handset can change global settings at a time.

Setting Day and Time

Day & Time sets the day and time of your display.

- 1) Enter the Global Setup menu, and then the Day & Time submenu option (see "Entering the Menu" on page 16). Image is for the base.
- 2) Press **volume up/down** to select the day of the week, and then the → soft key.
- 3) Press **volume up/down** to set hour, and then press the → soft key.
- 4) Press **volume up/down** to set minute, and then press the → soft key.
- 5) Press **volume up/down** to choose AM or PM, and then press the **SAVE** soft key. You will hear a confirmation tone.



Setting CIDCW (Caller ID on Call Waiting)

CIDCW sets the Caller ID on Call Waiting (CIDCW) displays the name and number of an incoming call while you are on the line. Call Waiting Deluxe (CWDX) allows you to handle call waiting calls in seven different ways.

- 1) Enter the Global Setup menu, and then the CIDCW submenu (see "Entering the Menu" on page 16).
- 2) Press **volume up/down** to select CW On/CWDX On, CW On/CWDX Off, or CW Off/CWDX Off, and then press the **OK** soft key. You will hear a confirmation tone.



Setting the Area Code

If you enter a 3-digit area code number in the "Area Code" option, your local area code does not appear in the Caller ID message. For calls received from outside your local area code, you will see a full 10-digit number.

- 1) Enter the Global Setup menu, and then the Area Code submenu (see "Entering the Menu" on page 16).
- 2) Press the number keypad (**0-9**) to enter a 3-digit area code.
- 3) Press the **OK** soft key. You will hear a confirmation tone.



If the area code has already been stored in memory, the stored area code will be displayed. To change it, use the **DELETE** soft key and number keys to enter the new area code.

Setting the Dial Mode

Dial Mode sets the dial mode to tone or pulse. Most phone systems use tone dialing; the default setting is tone dialing. Set the dialing mode to match the dialing system used by your local phone service.

- If you are not sure of your dialing system, set the unit to tone dialing. Make a trial call. If the call connects, leave the setting as is; otherwise set the unit to pulse dialing.
- If your phone system requires pulse dialing and you need to send DTMF tones in certain situations during a call, you may switch over to tone dialing (refer to “Tone Dialing Switch-over” on page 39).

- 1) Enter the Global Setup menu, and then the Dial Mode submenu (see “Entering the Menu” on page 16).
- 2) Press **volume up/down** to select **Tone** or **Pulse** (the initial setting is **Tone**).
- 3) Press the **OK** soft key. You will hear a confirmation tone.

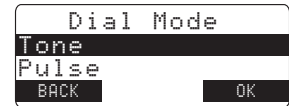

De-register the Handset (Handset only)

Deregister the handset's ID from the main base unit or the base ID from the handset. Use this option, for example, when you change the digital security code (see page 74).

- 1) In standby mode, select Deregister HS in the menu and press the **OK** soft key. Deregister HS? appears.
- 2) Press **volume up/down** to select Yes and then the **OK** soft key.



- When de-registration is complete you will hear a confirmation tone, and Deregistration Complete appears.
- 3) After de-registering the handset, place the handset to the base to register.



- To set "AutoTalk", see page 21 or to set "Anykey Answer" see page 21.
- The handset microphone is located at the bottom of the handset (see "Controls and Functions" on page 4). Position yourself as near to the handset as possible and speak clearly.
- If the line is in use by another handset(s), "Line In Use" appears in the base's display, and "InUse" appears in the display of all registered handset's display that are not in use.
- For the location of the base microphone, see "Controls and Functions" on page 5. Position yourself as near to the base as possible.

Making and Receiving Calls

This handset has a built-in speakerphone that allows you to have a hands-free conversation. This feature allows you to easily communicate while performing other tasks, such as cooking.  appears on the display during hands-free conversations.

You can easily switch a call from normal conversation to hands-free conversation. To switch a call, press **speaker** during the call.

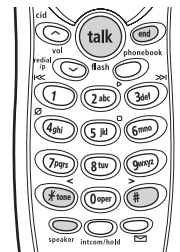

	From the Handset		From the Base
	Normal conversation	Hands-free conversation	
To answer a call	<p>Handset On the Cradle Pick up the handset (AutoTalk is: on) or pick up the handset and press talk/flash (AutoTalk is: off).</p> <p>Handset Off the Cradle Press any number key, */tone/, or #/> (Any Key Answer), or press talk/flash.</p>	<p>Handset Off the Cradle Press speaker.</p>	Press speaker .
To make a call	<p>Handset Off the Cradle 1) Press talk/flash. 2) Listen for the dial tone. 3) Dial the number.</p> <p>OR Dial the number, and then press talk/flash.</p>	<p>Handset Off the Cradle 1) Press speaker. 2) Listen for the dial tone. 3) Dial the number.</p> <p>OR Dial the number, and then press speaker.</p>	<p>1) Press speaker. 2) Listen for the dial tone. 3) Dial the number.</p> <p>OR Dial the number, and then press speaker.</p>
To hang up	Press end or return the handset to the cradle (AutoStandby).		Press speaker .
To enter a pause within the dialing sequence	When you dial the number in standby mode, press redial/p/vol/ . P appears in the display, which represents a pause.		When you dial the number in standby mode, press the PAUSE soft key.

Flash and Call Waiting

If you have Call Waiting service and a call waiting tone sounds while you are on a call, press **talk/flash** on the handset or **flash/find hs** on the base to accept the waiting call. There is a short pause, and then you will hear the new caller. To return to the original caller, press **talk/flash** on the handset or **flash/find hs** on the base again.

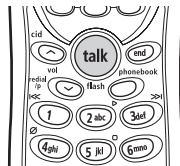

- If the battery pack is completely drained, the handset will not beep when paging.
- You can place a call on hold for 5 minutes. When 5 minutes has passed, the call is disconnected, and the phone returns to standby mode.
- While a call is on hold, CIDCW can not be received.

Placing a Call on Hold

- 1) During a call, press **intcom/hold** on the handset or **intercom/hold** on the base. The call will be put on hold (image is for the base).

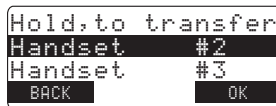

If you leave a call on hold for more than 10 seconds, the base display screen will read, Line On Hold and handset display screen will read Hold.

- 2) To talk to the caller, press **talk/flash** or **speaker** on a handset (or **speaker** on the base). The phone will return back to the call.



- If the number exceeds 32 digits, only the first 32 digits are retained in redial memory.
- If the redial memory is empty, you will hear a beep.
- Redial numbers stored in the handset and the base are independent from each other.

Redialing a Call

The last three phone numbers dialed can be quickly redialed from the handset or base.

- 1) With the phone in standby mode, press **redial/p/vol/√** on the handset or the **REDIAL** soft key on the base.
- 2) Press **volume up/down**. Each press of **volume up/down** will display one of the last three number redialed.
- 3) Press **talk/flash** or **speaker** on the handset (or **speaker** on the base). The selected number is dialed.
- 4) To hang up, press **end** or return the handset to the base (or press **speaker** on the base).

You can also display the redial list for redial number with the handset in talk mode. Press the **MENU** soft key, then select the redial menu. Press **volume up/down** to select the number you want to dial. Press the **DIAL** soft key to redial the number.

Deleting a Redial Record (Handset only)

- 1) Press **redial/p/vol/√** in standby mode.
- 2) Press **volume up/down** repeatedly to display the number to be deleted.
- 3) Press the **EDIT** soft key, and then select Delete?.
- 4) Press **volume up/down** to choose Yes.
- 5) Press the **OK** soft key. The redialed number is deleted.



Storing a Redial Record (from the handset only)

- 1) Press **redial/p/vol/√** in standby mode.
- 2) Press **volume up/down** repeatedly to display the number to be stored.
- 3) Press the **EDIT** soft key,, then select **Store into PB?**, and then the **OK** soft key.
- 4) To complete the setting, follow the steps 3-8 in "Phonebook (Storing Phone Numbers, Names, Distinctive Rings, and Speed Dial)" on pages 42-43.

Adjusting the Earpiece and Speaker Volume

Earpiece and Speaker Volume

You can select from among of six volume levels on the handset, and ten levels on the base. Pressing **volume up/down** on the handset or base during a call will change the earpiece or speaker volume. This setting will remain in effect after the telephone call has ended.

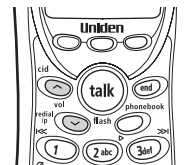

If you press **volume up** when the earpiece is at the maximum volume level, an error tone sounds. The error tone also sounds if you press **volume down** at the lowest volume.

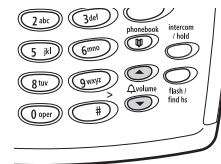

Do Not Disturb (DND)

The do not disturb feature (DND) allows you to mute the ringer, the base, and any registered handsets at the same time. The phone must be in standby mode. Press and hold **do not disturb** on the base. You will hear a confirmation tone, and the **DND** LED illuminates. To cancel the DND feature, press **do not disturb** again. You can also mute the ringer tone while the phone is ringing by pressing **do not disturb** on the base.

Activating the DND while the answering system is off will turn the answering system on automatically. The answering system setting will reset to the original setting when you cancel the DND.

If you press **Ⓞ** *answer on/off* when the DND and the answering system is on, both of the DND and the answering system will turn off.

To mute the ringer tone temporarily for each handset or the base, when the phone is ringing, press *end* or the **MUTE** soft key on the handset or the base. The ringer tone will return to the previous setting starting with the next incoming call.

Mute Microphone

You can temporarily mute the microphone so that the caller cannot hear you. Press the **MUTE** soft key during talk mode (while the phone is in use) to mute the microphone. *Mute On* and  appear in the display. To cancel muting, press the **MUTE** soft key again. *Mute Off* appears.



- The tone feature only applies when the dial mode is set to pulse.
- This special number can be stored in a memory location. This is referred to as Chain Dialing (see page 43).

Tone Dialing Switch-over

Some telephone companies use equipment that requires pulse dialing (sometimes referred to as rotary dialing). If you need to enter tone dialing digits, you can switch to tone dialing during the call. This feature is useful when you need tone dialing to use automated systems. For example, you can call your bank's telephone teller system, then switch over to tone dialing to enter your bank account number and make menu selections.

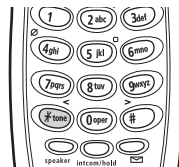

Initially make your call with pulse dialing mode. Once your call connects, press ***/tone/**< on the handset or base to enter tone dialing mode. Any digits entered will be sent in tone dialing mode. Once the call ends, tone mode is canceled, and pulse dialing mode resumes.

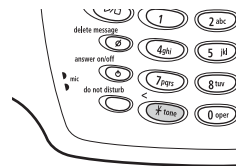

Traveling Out of Range

During a call, as you begin to move your handset too far from your base unit, noise may increase. If you pass the range limits of the base unit, you will hear a beep and see **Out of Range** on the display, and then the handset returns to standby mode. You may return to the call if you move your handset within the range limits of the base and press **talk/flash** or **speaker** within 30 seconds.

Privacy Mode

Privacy Mode prevents interruption from other registered handsets or the base. **This works only when the phone is in use.**

- 1) Press the **MENU** soft key *on the handset or base during talk mode.*
- 2) Press **volume up/down** to move the pointer to Privacy Mode and then the **OK** soft key.

Privacy Mode On and  appear in the display. To exit the Privacy Mode, repeat above step again when the Privacy Mode is on. Privacy Mode Off appears.

3 or 4-Way Conferencing

If you have more than one handset, up to four people can participate in a conference call.

3-Way Conferencing

- Outside line > Handset > Base

4-Way Conferencing

- Outside line > Handset > Handset > Base

When speaking on the handset

- 1) Press **speaker** on the base to initiate the 3-conference call.
- 2) To hang up, press **speaker** on the base. The handset will still be connected to the call.

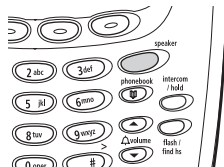

If someone is using another handset in Privacy Mode, System Busy Please try later appears in the display when you try to join the call.

When speaking on the base

- 1) Press **talk/flash** or **speaker** on the handset to initiate the 3 or 4-conference call.
- 2) To hang up, return the handset to the cradle, or press **end** on the handset. The base will still be connected to the call.

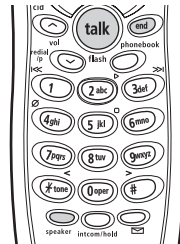

Phonebook (Storing Phone Numbers, Names, Distinctive Rings and Speed Dial)

You can store names and numbers in your phone's phonebook, search for names alphabetically, and dial phonebook entries with just a few key presses. You can store up to 100 numbers in the base and up to 100 additional numbers in each registered handset.

The phone uses the same memory to store phonebook entries and Caller ID messages. If the shared memory is already full, the phone will not store any more phonebook entries. You will have to delete some of the Caller ID messages before you can store a new phonebook entry.

- 1) When the phone is in standby mode, press **phonebook**.
- 2) Press the **STORE** soft key, *Store/Edit Name* appears.
- 3) Enter the name (up to 16 characters) by using the number keypad (see the "Steps for Entering Names and Special Characters" on page 44).
If a name is not required, go to step 4. <No Name> will be used as the name.
- 4) Press the **OK** soft key to store the name; *Store/Edit No.* appears.
- 5) Use the number keypad, ***/tone/**<, or **#/**> to enter the phone number (up to 20 digits).
If you make an error, use the **DELETE** soft key to erase the incorrect digits. When you are finished, press the **OK** soft key to store the number.



- Base



- Handset

note

- Selecting a phonebook entry where a number is already stored overwrites the old number. The new number will be stored in the phonebook entry.
- When the memory is full, you will hear a beep and **Memory Full** appears. You will have to delete some Caller ID messages before you can store new phonebook entries.
- The pause key counts as one digit. Pressing the **PAUSE** soft key on the base or **redial/p/vol/√** on the handset more than once increases the length of the pause between numbers. Each pause represents a 2 second delay.



- If you choose not to store a Distinctive Ring, simply select the "No Selectn" option.
- If you choose not to store the name/number as a Speed Dial, simply choose the "No Selectn" option.

6) If you store the phonebook entry from the handset, Distinctive Ring appears. Press **volume up/down** to move the pointer to one of the Distinctive Ring options and then press the **OK** soft key.

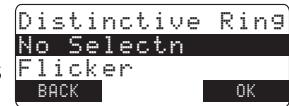

7) Speed Dial appears. Press **volume up/down** to move the pointer to select the Speed Dial location (10 locations: SPD1-SPD0).



8) Press the **OK** soft key. You will hear a confirmation tone, and Done! appears in the display.

Chain Dialing

The memory locations in the handset are not limited to phone numbers. You can also store a group of numbers (up to 20 digits) that you need to enter once your call connects. This is referred to as Chain Dialing.

An example of this is a bank account number. Store the account number in one of the phonebook locations (refer to "Phonebook (Storing Phone Numbers, Names, Distinctive Rings and Speed Dial)" on page 42). When you call your bank and are prompted to enter the account number, scroll through your phonebook locations until you find your account number, and then press the **DIAL** soft key.

Steps for Entering Names and Special Characters

Refer to the letters on the number keys to select the desired characters. With each press of a number key (**0-9**), the displayed character appears in the following order: Upper case letters first, lower case letters next and finally the number corresponding to the key.

keys	Number of times key is pressed								
	1	2	3	4	5	6	7	8	9
1	i								
2 abc	A	B	C	a	b	c	2		
3 def	D	E	F	d	e	f	3		
4 ghi	G	H	I	g	h	i	4		
5 jkl	J	K	L	j	k	l	5		
6 mno	M	N	O	m	n	o	6		
7 pqrs	P	Q	R	S	P	q	r	s	7
8 tuv	T	U	V	t	u	v	8		
9 wxyz	W	X	Y	Z	w	x	y	z	9
0 oper	&	<	>	<	>	/	(blank)	--	_
	.	,	=	?	!	@	'	"	*
	#	0							

If you make a mistake while entering a name

Use ***/tone/**< or **#/**> to move the cursor to the incorrect character.

Press the **DELETE** soft key to erase the wrong character, and then enter the correct character. To delete all characters press and hold the **DELETE** soft key.



If the next character uses the same number key, you must press **#/>** to move the cursor over. Otherwise the next time you press the number key, it changes the character that was previously set.

For example, to enter **Movies**:

- 1) When the phone is in standby mode, press **phonebook** and the **STORE** soft key.
Store/Edit Name appears.
- 2) Press **6** once, and then press **#/>** to move the cursor to the right.
- 3) Press **6** six times.
- 4) Press **8** six times.
- 5) Press **4** six times.
- 6) Press **3** five times.
- 7) Press **7** eight times.
- 8) When finished, press the **OK** soft key.

To continue to store the telephone number, proceed to step 5 in “Phonebook (Storing Phone Numbers, Names, Distinctive Rings, and Speed Dial)” on page 42.

Viewing the Phonebook

Your phone stores names/numbers in the phonebook memory entries, and you can search names in alphabetical order. You can view the phonebook even while the phone is in use.

- 1) Press **phonebook**. If you open the phonebook during a call, only the **BACK** soft key will appear.
- 2) Press **volume up/down**, or the number keypad to scroll through the phonebook entries. Phonebook entries appear in alphabetical order (from first to last when you press **volume down**, from last to first when you press **volume up**).



- Base



- Handset

You can also use the letters on the number keys to select the first letter of the desired name. Press a number key (**2-9** and **0**) once for the first letter, twice for the second letter, and so on. The first entry that begins with the letter you entered appears.

For example, to search for Movies, press **6** once. Press **volume up/down**, until the phonebook entry is displayed.

- 3) To finish the viewing operation:

From Handset - press **end** (or the **BACK** soft key or **talk/flash** during a call).
From Base - press **cid/exit** key or the **BACK** soft key.



During a call, don't press **end** on the handset or the call will be disconnected.

Making Calls Using the Phonebook

From Standby Mode

- 1) When the phone is in standby mode, select the phonebook entry you want to dial (see "Viewing the Phonebook" on page 46).
- 2) Press **talk/flash** or **speaker** on the handset or **speaker** on the base. The displayed number is dialed.
- 3) To hang up press **end** on the handset (or press **speaker** on the base or return the handset to the base).

From Talk Mode

- 1) Press **talk/flash** or **speaker** on the handset or **speaker** on the base.
- 2) Select the phonebook entry you want to dial (see "Viewing the Phonebook" on page 46).
- 3) Press the **DIAL** soft key. The number in the displayed phonebook location is dialed.
- 4) To hang up press **end** on the handset (or press **speaker** on the base or return the handset to the base).

Speed Dialing

If you store a phone number in a speed dial memory location (10 locations: SPD1 - SPD0), you can use the speed dialing feature. When the phone is in standby mode, press and hold a number key (**0-9**) associated with the speed dial until the phone number appears, and then press **talk/flash** or **speaker** on the handset or **speaker** on the base. The number stored in the speed dial (SPD1 - SPD0) is dialed.

Editing or Erasing a Phonebook Entry

- 1) When the phone is in standby mode, press **phonebook**.
- 2) Press **volume up/down**, or the number keypad to select the phonebook entry you want to edit or delete. (see "Viewing the Phonebook" on page 46).

a. Editing the Stored Data

- 1) When the phonebook entry to be edited appears, press the **EDIT** soft key. For the handset, then select Edit?. Store/Edit Name appears.
- 2) Follow the steps 3 to 7 under "Phonebook (Storing Phone Numbers, Names, Distinctive Rings, and Speed Dial)" on pages 42-43 to complete the editing operation.
- 3) Press the **OK** soft key. You will hear a confirmation tone.

b. Deleting the Stored Data

- 1) When the phonebook entry to be deleted appears, press the **DELETE** soft key on the base or the **EDIT** soft key on the handset. For the handset, then select Delete?. Delete Memory? appears.
- 2) Press **volume up/down** to move the pointer to Yes.
- 3) Press the **OK** soft key. You hear a confirmation tone. Deleted! appears in the display.





If the memory entry on the receiving handset or base is full, and can not store the phonebook locations, you will hear a beep.

Copying Phonebook Entries

Copy Phonebook allows you to transfer stored phonebook entries from handset to handset or from base to handset (or from handset to base) without having to manually re-enter names and numbers. You can transfer one memory (phonebook entries) at a time, or all memory entries at once.

- 1) When the phone is in standby mode, press **phonebook**.
- 2) Press the **COPY** soft key.
- 3) Press **volume up/down**, to select the handset or base which you want to transfer the phonebook entries to and then press the **OK** soft key.
- 4) Press **volume up/down** to select One Memory or All Memories: and then press the **OK** soft key.

If you select All Memories, Are you sure? appears on the display screen.

Press **volume up/down** to select Yes, and then press the **OK** soft key.

If you select One Memory, press **volume up/down**, or the number key (2-9 and 0) to select the phonebook entry you want to export and then press the **COPY** soft key.

- 5) The phonebook entries will be transferred to the handset (or the base). Copying and the receiving handset name (or base) appear. When the transfer is completed Done appears on the handset (or the base).

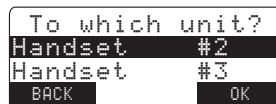

Caller ID and CIDCW (Caller ID on Call Waiting)

You must subscribe to Caller ID services through your local telephone provider to use these features.

When the telephone rings, the Caller ID feature allows you to view the caller's name, phone number, date and time of call. With CIDCW (Caller ID on Call Waiting), you will hear a call waiting tone while you are on a call, and the Caller ID data is displayed. To accept the waiting call, press **talk/flash** on the handset or **flash/find hs** on the base (see page 34). Additionally, you can dial a number stored in the Caller ID list or save data to your phonebook.

Important:

Memory for Caller ID messages and phonebook entries (including Speed Dials) are common, you can store up to 100 entries for each handset and the base. Caller ID messages are not stored when you have 100 phonebook entries. When you have stored total of 100 phonebook entries and Caller ID messages, the oldest Caller ID message is overwritten.

The date and time received — 12/21 12:30PM
 Caller's name — Jane Smith
 Caller's phone number — 214-555-1234

BACK DELETE STORE

- Base

12/21 12:30P *
 Uniden Corp
 817-858-3300

EDIT

- Handset

- 1) When the Caller ID message is received, the display shows the caller's phone number along with the date and time. The incoming call information is stored in the Caller ID record. If the Caller ID service includes the caller's name, the name will appear in the display (up to 15 characters).



- If you answer a call before the Caller ID message is received (for example, before the second ring), the Caller ID message will not appear.
- When the call is received via a telephone company that does not offer Caller ID service, the caller's phone number and name does not appear. (This includes some international calls.)
- When the call is via a private branch exchange (PBX), the caller's phone number and name may not appear.



- The number of calls from the same Caller ID appears next to the received time. Once you view the new message, the number will be cleared and disappear.
- * icon appears next to Time to indicate this is a unread message. Once you view the new message, the * icon will disappear.

You may receive any one of the following messages:

When invalid data is received; Incomplete Data

When a private name is received; Private Name

When a private number is received; Private Number

When a unknown name is received; Unknown Name

When a unknown number is received; Unknown Number

2) When you pick up the phone, the display changes to Talk.
(AutoTalk feature is set to on).



Data errors appear as "■."

Viewing the Caller ID List

The Caller ID list stores information for incoming calls - even unanswered calls.

You can store up to 100 Caller ID messages and Phonebook locations (including Speed Dials) for each handset and the base. You can view the Caller ID list through the handset or base during a call or when the phone is in standby mode.

1) With the phone in standby mode, press **cid/vol/∧** (or **cid/exit**).

Or with the handset in talk mode, press the **MENU** soft key. Use **volume up/down** to select Caller ID, then press the **OK** soft key.

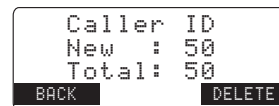

The summary screen appears. The screen shows the number of new messages and total messages.

- 2) To view the Caller ID messages in historical order (from new to old or from old to new), repeatedly press **volume down** to scroll through the messages from the latest to the earliest, or **volume up** to scroll back through the messages. To view the Caller ID messages with alphabetical search, press the number key pad (**2-9** and **0**) with the letter associated with the first letter of the desired message.



Once you view the Caller ID list with alphabetical search, you cannot switch back to historical order (from new to old or from old to new) unless you exit and re-enter the operation.

- 3) To finish the viewing operation:

From Handset - press **end** (or the **BACK** soft key or **talk/flash** during a call).

From Base - press **cid/exit** key or the **BACK** soft key.



- During a call, don't press **end** on the handset or the call will be disconnected.
- Once the Caller ID data has been deleted, the information cannot be retrieved.

Deleting a Caller ID Message

Deleting Information from the Caller ID List

- 1) When the phone is in standby mode, view the Caller ID information to be deleted (see "Viewing the Caller ID List" on page 51).
- 2) From the base, press the **DELETE** soft key.
From the handset, press the **EDIT** soft key, and then use **volume up/down** to select **Delete?**. Press the **OK** soft key. **Delete Caller ID** appears.
- 3) Press **volume up/down** to choose **Yes**.
- 4) Press the **OK** soft key. You will hear a confirmation tone.



You cannot make a call from the Caller ID list if your phone is connected to a private branch exchange (PBX).

Deleting all Caller ID names/numbers

1) When the phone is in standby mode, press **cid/vol/∧** (**cid/exit**).

Press the **DELETE** soft key. Delete All? appears.

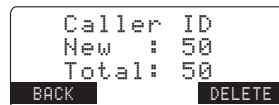

2) Press **volume up/down** to choose Yes.



3) Press the **OK** soft key. You will hear a confirmation tone.

Using the Caller ID Message List

Calling a party from the Caller ID list

From Standby mode

1) When the phone is in standby mode, select the Caller ID message (see "Viewing the Caller ID List" on page 51).

2) Press **talk/flash** or **speaker** on the handset or **speaker** on the base. The displayed phone number dials automatically.

From Talk mode

1) Press **talk/flash** or **speaker** on the handset or **speaker** on the base.

2) Select the Caller ID message you want to dial (see "Viewing the Caller ID List" on page 51).

3) Press the **DIAL** soft key. The displayed phone number will be dialed.

Long Distance calls and Area Code Setting/Cancellation

While the present Caller ID information is displayed, pressing ***/tone/**< will place or remove the prefix "1" in the display to set the call for a long distance call, or pressing **#/**> will set or cancel an area code (see page 30).

Storing Caller ID messages in the Phonebook

Messages shown in the Caller ID list can be stored in the phonebook. The phone number and name of the party on the Caller ID list can be stored in memory.

- 1) When the phone is in standby mode, select the Caller ID message to be stored. Then press the **STORE** soft key on the base or the **EDIT** soft key on the handset. From the handset, then select **EDIT? Store/Edit Name** appears. If the Caller ID message is already stored in memory, you will hear a beep and **This data is already stored!!** appears. The number will not be stored.
- 2) To complete the setting, follow the steps 3-8 in "Phonebook (Storing Phone Numbers, Names, Distinctive Rings, and Speed Dial)" on pages 42-43.



- When a long distance call has been set, "1" appears in the display.
- If a call comes in via a telephone system that does not offer Caller ID service, no information is stored.
- If the Caller ID message was received as a private/unknown number, or the message does not have the number, you cannot store the message in the phonebook. If it was received as private/unknown name, the message will be stored as <No Name>.
- Even if the memory is full, the message will be stored in the phonebook. However, the message will be erased from the Caller ID list.



- To activate features, select **CW On/CWDX On** in the **CIDCW** option. See page 30.
- You can also answer a waiting call immediately by pressing **talk/flash**, the first caller will be placed on hold. To return to the original caller, press **talk/flash** again.
- If you don't choose a **CWDX** option within 30 seconds, the phone returns to call.
- To return to the call, press the **BACK** soft key.

Call Waiting Deluxe Features

Your phone is pre-programmed with seven call waiting deluxe options. You may select to ask the calling party to hold, send them a busy message, forward them to your voice mail, or answer and drop the first caller. You may also select to conference them into the current call or, at any time, choose to drop the first or drop the last caller. You must subscribe to Call Waiting and Call Waiting Deluxe to use these features. Not all features are available in all areas. Check with your local telephone company for details.

1) From the base

When you receive a Call Waiting call, press the **CWDX** soft key for a list of options.

From the handset

When you receive a Call Waiting call, press the **MENU** soft key.

Press **volume up/down** to select **CallWaitDeluxe**, then the **OK** soft key for a list of option.

2) Press **volume up/down** or the number keypad (1-7) to select an option.

For example:

press **volume down** 4 times

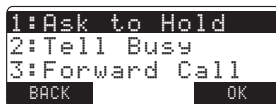

press **volume down** 2 times



3) Press the **OK** soft key. A confirmation screen will appear, and the phone returns to the call.

The Integrated Telephone Answering Device

The phone has a built-in answering system that answers and records incoming calls. You can also use your answering system to record a conversation, leave a voice memo message, or to announce a special outgoing message to callers when you're away from your phone.

Features

- Digital Tapeless Recording
- Up-to 12 minutes of Recording Time
- Call Screening
- Personal or pre-recorded Outgoing Messages
- Voice Prompts for TAD (English, Spanish, or French)
- Time and Day Announcement
- Remote Message Retrieval
- Toll Saver
- Conversation Recording
- Voice Memo
- Message Alert On/Off
- Retrieve TAD Messages using Handset



- When the answering system is full, you will hear "No Remaining Time" and **Full** appears on the sub-display. You should delete some messages so that the system can record new messages.

- Position yourself as near to the base as possible and speak clearly when recording your outgoing message.

- If you make an outside call, or a call is received on the base during the operation, the operation is canceled.

Turning the Answering System On/Off

- 1) To turn the answering system on, press **⓪ answer on/off** on the base when the phone is in standby mode. **MESSAGE** and the number of messages stored in memory appears on the sub-display. If the sub-display flashes, then there are new messages waiting for you.
- 2) To turn the answering system off, press **⓪ answer on/off** on the base. **ANSWER OFF** appears on the sub-display.

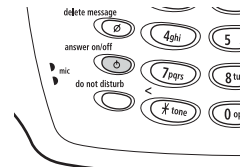

Setting your outgoing message (Greeting)

When you receive a call, the answering system automatically plays either the pre-recorded message or your own greeting. To record your own greeting, or choose between the two outgoing messages, refer to "Setting Menu Options", "Answering System Setup" on page 24.

The following message is pre-recorded: "Hello, no one is available to take your call. Please leave a message after the tone."

Announce only feature

The announce only feature plays a pre-recorded outgoing message or your own personal outgoing message, but it will not allow the caller to leave a message. To set announce only, follow the steps on "Setting the Record Time" page 26. If you want to use your

own greeting and you want to change your greeting to omit the prompt to leave a message, refer to "Selecting Your Greeting (Base only)" on page 25.

The following message is pre-recorded:

"Hello, no one is available to take your call. Please call again."

Using the Answering Setup Menu

The Answering Setup menu allows you to set the following Answering System functions through the handset or the base. For detailed instructions, see "Setting Menu Options", "Answering System Setup" on page 24.

Menu Options	Base	Handset	Menu Options	Base	Handset
Record Greeting	<input type="radio"/>	X	Record Time	<input type="radio"/>	<input type="radio"/>
Select Greeting	<input type="radio"/>	X	Message Alert	<input type="radio"/>	<input type="radio"/>
Security Code	<input type="radio"/>	<input type="radio"/>	Language	<input type="radio"/>	<input type="radio"/>
Ring Time	<input type="radio"/>	<input type="radio"/>	Call Screen	<input type="radio"/>	<input type="radio"/>

New Message LED

The new message LED on the handset flashes when you have new messages in your answering system. The LED stops flashing when all new messages are played back.



The time stamp will not be heard until you have set the time.

Using your Answering System

The message counter displays the number of messages stored in memory. If the display flashes, then there are new messages waiting for you. The answering system is designed to play your new messages first. After you play all your new messages, you can then play your old messages.

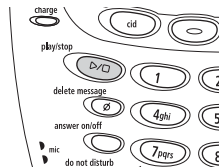

Playing your messages

- 1) When the base is in standby mode, press \triangleright/\square **play/stop**.
The system announces the number of new and old messages while the message counter displays only the number of new messages. The time and day that each message was received is announced after the message is played. The message counter will then display the number of current stored messages.
- 2) When all new messages have been played, you hear a confirmation tone and the system announces "End of messages." The system returns to standby. After you have reviewed your new messages, you can play your old messages by pressing \triangleright/\square **play/stop** again. Once you have listened to a new message, it then becomes an old message. The old messages will be played in the order in which they were received.

Repeating a message

- 1) Press \triangleright/\square **play/stop** to review your messages. The number of stored messages is announced.
- 2) To repeat the current message, press the $|\ll$ soft key after a few seconds of beginning the message. To quickly scroll backwards through a message, press and hold the $|\ll$ soft key. To repeat the previous message, press the $|\ll$ soft key

within a few seconds (about 4 seconds during remote operation) after a message begins playing. If you have several messages, press the |<< soft key repeatedly until you return to the message you want to replay. If the current message is the first new message, the system plays back from the beginning of the current message (it does not go back into the old message group).

- 3) Press ▸/□ **play/stop** at any time to stop reviewing messages and return to standby.

The message counter shows the number of messages stored in memory.

Skipping a message

- 1) Press ▸/□ **play/stop** to review your messages. The number of stored messages is announced.
- 2) Press the >>| soft key at anytime to skip to the next message.
Each time the >>| soft key is pressed, the system scans forward one message. If you have several messages, press the >>| soft key repeatedly to find the message you want to play. To quickly scroll through a message, press and hold the >>| soft key. The system advances through the playback at double speed.
- 3) Press ▸/□ **play/stop** at anytime to stop reviewing your messages and return to standby. The message counter shows the number of messages stored in memory.

Deleting a message

To maintain maximum record time, delete the old messages.

- 1) Press ▸/□ **play/stop** to review your messages.
- 2) Press the **DELETE** soft key or Ⓞ **delete message** at anytime during the message to delete the message. You hear a confirmation tone and the message is deleted.

3) To delete all messages, press **⓪ *delete messege*** in standby mode. Press **⓪ *delete messege*** again after the announcement "To delete all messages, press delete again."

When you try to delete all messages without first listening to your new messages, you hear several short beeps followed by an announcement "Please playback all messages." This protects you from accidentally erasing messages you have not yet reviewed.

Important:

When you press **⓪ *delete messege***, you are permanently deleting the message. Once deleted, the message cannot be replayed or retrieved.

Voice memo

The voice memo function allows the user to record messages (more than 2 seconds and less than 4 minutes).

- 1) In stand by mode, press the **RECORD** soft key on the base.
- 2) Press the **START** soft key.
- 3) Start your recording after the announcement "Record Memo Message" and a confirmation tone.
- 4) When you have finished, press the **STOP** soft key to stop recording. The system returns to standby.

Recording a conversation

You can record a conversation from the handset or the base (more than 2 seconds and less than 10 minutes).

- 1) During a conversation, press the **MENU** soft key.
- 2) Press **volume up/down** to select Call Record, and then press the **OK** soft key.
Recording a Call appears on the display.
A confirmation tone, that can be heard by both parties, sounds during recording.
- 3) To stop recording:

From Handset - press the **MENU** soft key and **volume up/down** to select Call Record.
You will hear a confirmation tone.

From Base - press **play/stop**. Or press the **MENU** soft key and \triangle **volume**/ \blacktriangle or \triangle **volume**/ \blacktriangledown to select Call Record. You will hear a confirmation tone.

Screening a call

From the base

To screen an incoming call, use the following steps:

- 1) After the answering system answers, the base speaker will let you hear the calls as the machine records the message. To adjust the volume, press \triangle **volume**/ \blacktriangle or \triangle **volume**/ \blacktriangledown . If you set the answering system to off, you cannot screen a call.



- Every state has different regulations governing the recording of conversations over the telephone. Make sure to check your local, state and federal laws before using this product to record any telephone conversation in order to determine that your use is in compliance with such laws or guidelines.
- To active this feature, you must turn the Call Screen feature on. See "Answering System Setup", "Setting the Call Screen" on page 28.
- If you press the SCREEN soft key while another handset is screening a call, you will hear a beep and you can not screen a call.

2)

- a) To mute the Call Screen, press the **MUTE** soft key or \triangleright/\square **play/stop**. To cancel muting, press the **SCREEN** soft key.
- b) To answer the call, press **speaker** or pick up the handset from the base (when AutoTalk is set to on).

From the handset

Press the **SCREEN** soft key when the system is answering. To mute the Call Screen, press the **MUTE** soft key. If the handset is away from the base, press **talk/flash**, **speaker** or any number key, ***/tone/<**, or **#/>** (when AutoTalk is set to on). The answering system will disconnect automatically.

Remote Operation

You can check, play, or delete messages, even record a new greeting message from a remote location (when you are away from home, or from another room using a handset). Additionally, you can turn on or off your answering system remotely.

Remote access away from home

You can operate your answering system from a remote location using any touch-tone telephone.

- 1) Call your telephone number and wait for the system to answer. If the answering system is off, it will answer after about 10 rings and sounds a series of beeps.
- 2) During the greeting message (or a series of beeps when the answering system is off), press 0 and enter your PIN code within 2 seconds (see "Setting a PIN Code" on page 25).



- 3) The answering system announces the current time and the number of messages stored in memory. You hear "To play incoming messages, press zero-two. For help, press one-zero." You will hear a beep.
- 4) Enter a command within 15 seconds, each command there after must be entered within 2 seconds. You may select a command from the following chart:

Command	Function	Command	Function
0 then 1	Repeat a Message*	0 then 6	Answering System On
0 then 2	Playing incoming Messages	0 then 7	Memo Record/Stop**
0 then 3	Skipping a Message	0 then 8	Greeting Message Record/Stop**
0 then 4	Deleting a Message	0 then 9	Answer System Off
0 then 5	Stop Operation	1 then 0	Help

- * For the Repeat a Message function, press **0** then **1** within about four seconds to repeat the previous message, or press **0** then **1** after about four seconds to repeat the current message.
- ** For the Memo Record and Greeting Message Record functions, the first time you enter the corresponding command, the phone starts recording. If you want to stop the recording, press **0** then **7**, **8** or **5**.
- 5) After the command has finished, you hear intermittent beeps indicating that the system is in the command waiting mode. You may enter another command at this time from the chart above.

- Time stamp will not be heard until you have set the time. See "Setting Day and Time" on page 29.
- The system will only playback messages for four minutes and then it returns to the command waiting mode. To continue playing your messages, press **0** then **2** again within 15 seconds.
- If you enter an incorrect PIN code three times, you will hear a beep and the system will return to standby.
- During the remote operation, Line Remote appears on the display.
- If the answering system is recording an incoming message, the recording operation is canceled when you start remote operation.
- For your convenience a remote operation card is provided for you to use while away from home (refer to page 88).



- Time stamp will not be heard until you have set the time.

- When the answering system is full, **FULL** appears on the base. You should delete some messages so that the system can record new messages. (Refer to "Deleting a message" on page 60.)

- 6) When you are finished, hang up to exit the system. The answering system automatically returns to standby.

Remote access with the handset

You can operate your answering system from another room using a handset.

- 1) When the phone is in standby mode, press  on the handset. `Remote AnsweringMachine operation` appears on the handset display. The answering system announces the current time and the number of messages stored in the memory. Messages will be played in the order in which they were received. The time and day that each message was received is announced after the message is played.
- 2) You hear "To play incoming messages, press two. For help, press zero."
You will hear a beep.
 - If you press **end** before the answering system answers, the phone will return to standby.
 - When the answering system does not answer within 6 seconds, you hear a beep and the phone will return to standby.



- When you receive a call, the remote operation is canceled.
 - You can change the handset volume during a remote operation.
 - During the remote operation `Remote AnsweringMachine operation` appears on the base.
 - If you have new messages and old messages, after you have reviewed your new messages, you can play your old messages by pressing 2 again.
- 3) Enter a command within 30 seconds. Select a command from the following chart:

Remote Key Function

<</1	Repeat a Message*	6	Answering System On
▷/2	Playing incoming Messages	7	Memo Record/Stop**
>>/3	Skipping a Message	8	Greeting Message Record/Stop**
∅/4	Deleting a Message	9	Answer System Off
□/5	Stop Operation	0	Help Guidance

- * For the Repeat a Message function, press **1** within about four seconds to repeat the previous message, or press **1** after about four seconds to repeat the current message.
- ** For the Memo Record and Greeting Message Record functions, the first time you enter the corresponding command, the phone starts recording. If you want to stop the recording, press **7**, **8** or **5**.
- 4) After the command has finished, you will hear intermittent beeps indicating that the system is waiting for a command. You may enter another command at this time from the chart above.
- 5) When you are finished, press **end** to exit the system.



- The voice memo messages are recorded as an incoming messages.
- When the answering system is full, **FULL** appears on the display, and recording is terminated.
- If an outside call is received during the operation, the operation is canceled.
- You cannot record intercom conversations.



- If you have any trouble with your phone, visit our web site at www.uniden.com or call our Customer Hotline at 1- 800-297-1023 (Mon-Fri 7 am to 7pm, Sat/ Sun 9 am to 5pm, CST). (The Customer Service Hotline is closed on holidays.)
- Charge the handset battery pack for at least 15-20 hours before using your new cordless telephone for the first time.

Expanding Your Phone

10 Handset Expandability

Your phone supports up to 10 handsets, including any handsets supplied with your phone. You can now place a fully-featured cordless handset anywhere AC power is available to connect the handset charger.

Up to 2 handsets can be used in DirectLink

Mode or on an intercom call without interfering with incoming calls. It is possible to have a 4-way conference among the base, 2 handsets, and one outside line. All of the handsets ring when a call is received.

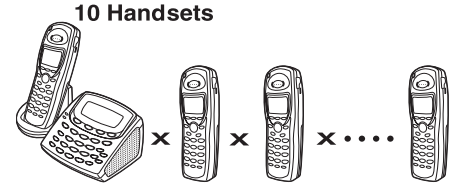

Backwards/Forwards Compatibility

Your phone is compatible with other Uniden 5.8GHz Digital Expandable Handsets. Compatible models include the **TCX400**, **TCX440**, and **ELX500**. (Please check www.uniden.com for an updated list of expansion handsets compatible with this series.)



Connecting the Charger

- 1) Connect the AC adapter to the **DC IN 9V** jack and to a standard 120V AC wall outlet.
- 2) Set the charger on a desk or tabletop, and place the handset in the charger with the keypad facing forward. (See " B. Install.... the rechargeable battery pack into the handset, and charge for at least 15-20 hours before using" on page 10.)

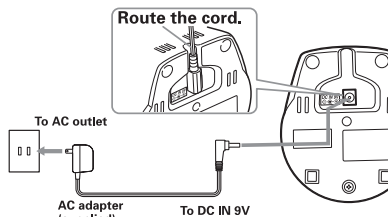

note

- An extra handset can be registered when the main base is in standby mode.
- If a handset has ever been registered to a different base, you must de-register the handset before you can register it to the new base (see page 32).

Register the Handset

If you purchase an expansion handset, you need to register the handset before use. Only one handset can be registered at a time.

Handsets supplied with the phone are registered to the base by the factory. When charged, pre-registered handsets display a handset ID number. Handsets that have not been registered display Models vary! Charge handset on the base for registration or refer to Owner' Manual. When you register an extra handset to the base, the handset ID will be assigned.

Register the expansion handset to main base

Before an expansion handset is registered, the battery pack **MUST** be charged for 15 hours.

To register a TCX805 handset, simply place it in the main base.

While the handset is registering, Handset Registering will appear in the LCD.

When Registration complete. is displayed, the handset has been registered to the base. If Registration failed. appears, please try these steps again.

To register a ELX500, TCX440, or TCX400 handset, follow the steps below:

- 1) Disconnect the AC adapter from the main base.
- 2) While pressing down *flash/find hs*, reconnect the AC adapter.
- 3) On the handset, press and hold # until you hear a beep.

While the handset is registering, Handset Registering will appear in the LCD. When Registration complete. is displayed, the handset has been registered to the base. If Registration failed. appears, please try these steps again.

Using DirectLink Mode

To use this feature, you must enter the handsets into DirectLink mode first.

To enter DirectLink mode, see page 17.

DirectLink call

- 1) When the phone is in the DirectLink standby mode, press the **DirectLink** soft key (example of DirectLink from handset #1).
- 2) Select the handset to which you wish to DirectLink with by pressing the number keys (**0-9**). Your handset will then page the other handset.
- 3) On the receiving handset, press **talk/flash**, the **ANSWER** soft key, or if Any Key Answer is on, press any number key, ***/tone/<**, or ***/>**.
- 4) When you finish your conversation, press **end** or the **END** soft key on either handset. To cancel DirectLink mode (and return to normal standby), return the handset to the cradle or press the **CANCEL** soft key, and then press the **OK** soft key.

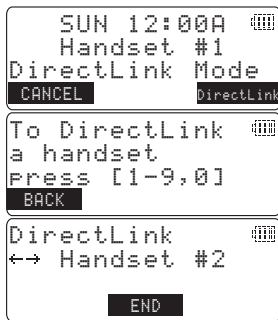
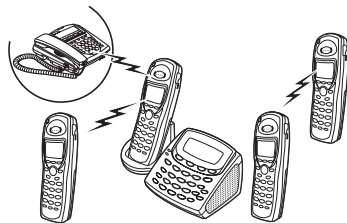

Handsets can be in DirectLink mode while other handsets are in use.



note

- If the party is busy or out of range, the handset returns to standby mode.
- If any you receive an outside/intercom call or page while selecting the other handset (or the base), the operation will be canceled.
- If the party does not answer within one minute, the operation is canceled.

Intercom/Call Transfer Feature

Intercom and Call Transfer features are available for your phone.

Intercom

From handset to handset or handset to the base

- 1) In standby mode, press **intercom/hold**.
- 2) Select the base or the handset you want to talk with within 30 seconds. To select the handset (or the base), press **volume up/down**, and then press the **OK** soft key. If you select **All**, all other handsets and the base will be paged. An intercom tone sounds.



To cancel intercom, press the **CANCEL** soft key.

- 3) To answer the page on a handset, press **talk/flash**, **intercom/hold**, or the **ANSWER** soft key. If Any Key Answer is enabled, pressing any number key, ***/tone/<**, or **#/>** will answer the page. If AutoTalk is enabled, you can answer the page by simply picking up the handset. To answer a page from the base, press **intercom/hold**, **speaker**, or the **ANSWER** soft key.
- 4) To hang up the intercom call, press **end** or the **END** soft key on either handset (or the **END** soft key or **intercom/hold** on the base).



From the base to a handset

- 1) In standby mode, press **intercom/hold** on the base.
- 2) Select the handset you want to talk with within 30 seconds. To select the handset, press **volume/▲** or **volume/▼**, and then press the **OK** soft key. If you select **A11**, all handsets will be paged. An intercom tone sounds. To cancel intercom, press **intercom/hold** or the **CANCEL** soft key.
- 3) Follow the steps 3-4 under "From handset to handset or handset to the base" on page 71.

Call Transfer Feature

From handset to handset or to the base

- 1) During a call, press **intcom/hold** on the handset.
- 2) Select a handset or the base to transfer the call to within 10 seconds. To select the handset (or the base), press **volume up/down**, and then press the **OK** soft key. If you select **A11**, all other handsets and the base will be paged.
The call will automatically be placed on hold, and an intercom tone sounds.
To cancel the transfer, press **talk/flash**, the **CANCEL** soft key or **speaker** on the initiating handset.
- 3) To answer the page on a handset, press **talk/flash**, **intcom/hold**, or the **ANSWER** soft key. If Any Key Answer is enabled, pressing any number key, ***/tone/<**, or **#/>** will answer the page. If AutoTalk is enabled, you can answer the page by simply picking up the handset. To answer a page from the base, press **intercom/hold**, **speaker**, or the **ANSWER** soft key.

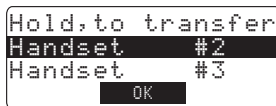

- 4) To speak to the caller, press ***talk/flash*** on the receiving handset or ***speaker*** on the base.

From the base to a handset

- 1) During a call, press ***intercom/hold*** on the base. The call will automatically be placed on hold.
- 2) Select the handset you want to talk with within 10 seconds. To select the handset, press **△ *volume*/▲** or **△ *volume*/▼** and then press the **OK** soft key. If you select **ALL**, all handsets will be paged. An intercom tone sounds. To cancel the transfer, press ***intercom/hold***, ***speaker*** or the **CANCEL** soft key on the base.
- 3) To answer the page on a handset, press ***talk/flash***, ***intercom/hold***, or the **ANSWER** soft key. If Any Key Answer is enabled, pressing any number key, ****/tone/<***, or ***#/>*** will answer the page. If AutoTalk is enabled, you can answer the page by simply picking up the handset.
- 4) To speak to the caller, press ***talk/flash*** on the receiving handset.

Changing the Digital Security Code

The digital security code is an identification code used to connect the handset and the base unit. Normally, setting the code is not necessary. In the rare situation that you suspect another cordless telephone is using the same security code, you can change the code. To change the digital security code:

1. De-register all the handsets you have (see "De-register the handset" on page 32).
2. Register the handsets by following the steps under "Register the Handset" on page 68.

Find Handset

To locate the handset, press **flash/find hs** on the base when the phone is in standby mode. All registered handsets beep for 60 seconds, and **Paging** appears on the handset display. To cancel paging, press any key on the handset or **flash/find hs** on the base.

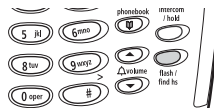

Installing the Beltclip

To attach the beltclip

Insert the beltclip into the holes on each side of the handset. Press down until it clicks.

To remove the beltclip

Pull either side of the beltclip to release the tabs from the holes.



Headset Installation

Your phone may be used with an optional headset. To use this feature, insert the headset plug into the headset jack. Your phone is ready for hands-free conversations. (Headset may be purchased by calling the Uniden Parts Department or visiting the web site. See back page.)

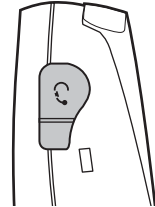

Note on Power Sources

Battery replacement and handling

When the operating time becomes short, even after a battery is recharged, please replace the battery. With normal usage, your battery should last about one year. Please contact your place of purchase or the Uniden Parts Department for a replacement battery.

Warning

To avoid the risk of personal injury or property damage from fire or electrical shock, only use the Uniden battery model and Uniden adapter model specifically designated for this product.

Power Failure

During the period that the power is off, you will not be able to make or receive calls with the telephone.

Caution

- Use only the specified Uniden battery pack (BT-446).
- Do not remove the batteries from the handset to charge them.
- Never throw the battery into a fire, disassemble them, or heat them.
- Do not remove or damage the battery casing.

Maintenance

To maintain a good charge, it is important to clean the charging contacts on both the handset and the base unit once a month. Using water only, dampen a cloth to clean the charging contacts. Then make sure to go back over the charging contacts with a dry cloth.

Caution

Do not use paint thinner, benzene, alcohol, or other chemical products. Doing so may discolor the surface of the telephone and damage the finish.

General Information

The phone complies with FCC Parts 15 and 68. Operating temperature:
0 °C to +50 °C (+32 °F to +122 °F)

AC Adapter Information

AC Adapter part number: AD-830 for the base	AD-0005 for the charger (TRU8885-2/3 only)
Input Voltage: 120 AC 60Hz	120V AC 60Hz
Output Voltage: 9V DC 400mA	9V DC 210mA

Battery Information

Battery part number: BT-446
Capacity: 800mAh, 3.6V



- To avoid damage to the phone use only Uniden AD-830 and BT-446 with your phone.
- If the handset is left off of the base, the actual Talk mode duration will be reduced respective to the amount of time the handset is off the base.

Recharge your phone on a regular basis by returning the handset to the base after each phone call. When the operating time becomes short even after the battery is recharged, please replace the battery. With normal usage, the battery should last about one year.

A replacement Uniden adapter or battery may be purchased by contacting the Uniden Parts Department (see back page).

Specifications, features, and availability of optional accessories are all subject to change without prior notice.

Troubleshooting

If your phone is not performing to your expectations, please try these simple steps first.

Symptom	Suggestion
The charge LED won't illuminate when the handset is placed in the cradle.	<ul style="list-style-type: none">• Make sure the AC adapter is plugged into the base or the charger (if you have more than one handset) and wall outlet.• Make sure the handset is properly seated in the cradle.• Make sure the charging contacts on the handset and the base or the charger (if you have more than one handset) are clean.
The audio sounds weak.	<ul style="list-style-type: none">• Move the handset and/or base away from metal objects or appliances and try again.• Make sure that you are not too far from the base.
Can't make or receive calls.	<ul style="list-style-type: none">• Check both ends of the base telephone line cord.• Make sure the AC adapter is plugged into the base and wall outlet.• Disconnect the AC adapter for a few minutes, and then reconnect it.• De-register the handset (see "De-register the Handset" on page 32) and register the handset (see "Register the Handset" on page 68).• Make sure that you are not too far from the base.• Make sure the line is not in use.• If an outside call is already established, you can not make another outside call.
The handset doesn't ring or receive a page.	<ul style="list-style-type: none">• Charge the batteries in the handset for 15-20 hours by placing the handset on the base or charging cradle.• Make sure that you are not too far from the base.• De-register the handset (see "De-register the Handset" on page 32) and register the handset (see "Register the Handset" on page 68).
Unavailable appears in the display.	<ul style="list-style-type: none">• Make sure that another handset(s) or the base is not in use, and try the phone again.• Make sure that you are not too far from the base.

Symptom	Suggestion
Severe noise interference.	<ul style="list-style-type: none"> • Keep the handset away from microwave ovens, computers, remote control toys, wireless microphones, alarm systems, intercoms, room monitors, fluorescent lights, and electrical appliances. • Move to another location or turn off the source of interference.
The Caller ID does not display.	<ul style="list-style-type: none"> • The handset was picked up before the second ring. • The call was placed through a switchboard. • Call your local telephone company to verify your Caller ID service is current. There may be a problem with your Caller ID service.
You cannot register the handset at the base.	<ul style="list-style-type: none"> • Charge the battery pack for 15-20 hours. • De-register the handset (see "De-register the Handset" on page 32) and register the handset (see "Register the Handset" on page 68).
The handset doesn't communicate with other handsets.	<ul style="list-style-type: none"> • De-register the handset (see "De-register the Handset" on page 32) and register the handset (see "Register the Handset" on page 68). • Make sure that you have registered all handsets.
An extra handset can't join the conversation.	<ul style="list-style-type: none"> • Make sure there are not 2 handsets already using the 3-way conference feature.
The handset or the base can't join the conversation	<ul style="list-style-type: none"> • Make sure that another handset or base is in privacy mode.
The answering system does not work.	<ul style="list-style-type: none"> • Make sure the base unit is plugged in. • Make sure that the answering system is turned on. • Make sure that the message record time is not set to Announce only (see page 26).
Messages are incomplete.	<ul style="list-style-type: none"> • The incoming messages may be too long. Remind callers to leave a brief message. • The memory may be full. Delete some or all of the saved messages.
After a power failure, the outgoing message is deleted.	<ul style="list-style-type: none"> • Record your greeting again. The default message should remain.

Symptom	Suggestion
No sound on the base unit speaker during call monitoring or message playback.	<ul style="list-style-type: none">• Adjust the speaker volume on the base unit.• Make sure the call screen feature is set to on.
Cannot access remote call-in features from another touch-tone phone.	<ul style="list-style-type: none">• Make sure you are using the correct PIN number.• Make sure that the touch-tone phone you're using can transmit the tone for at least two seconds. If it cannot, you may have to use another phone to access your phone.
Time stamp cannot be heard.	<ul style="list-style-type: none">• Make sure you have set the time (see "Setting Day and Time" on page 29).
If you still have a problem.	<ul style="list-style-type: none">• Call our customer hotline at 1-800-297-1023.

Liquid Damage

Moisture and liquid may damage your cordless phone. Follow the steps below if your phone gets wet:

Case	Action
If the exterior plastic housing on the handset or base is exposed to moisture or liquid.	Wipe off the liquid, and use as normal.
If moisture or liquid has entered the plastic housing (i.e. liquid can be heard in the phone or liquid has entered the handset battery compartment or vent openings on the base).	<p>Handset:</p> <ol style="list-style-type: none">1) Remove the battery cover and leave it off for ventilation.2) Disconnect the battery pack. Leave the battery cover off and the battery pack disconnected for at least 3 days.3) Once the handset is completely dry, reconnect the battery pack and the battery cover.4) Recharge the handset's battery pack for 20 hours before using. <p>Base:</p> <ol style="list-style-type: none">1) Disconnect the AC adapter from the base, cutting off electrical power.2) Disconnect the telephone cord from the base.3) Let dry for at least 3 days. <p>IMPORTANT: You must unplug the telephone line while recharging the battery packs to avoid charge interruption.</p> <p>CAUTION: DO NOT use a microwave oven to speed up the drying process. This will cause permanent damage to the handset, base and the microwave oven. After following these steps, if your cordless telephone does not work, please call our Customer Service Hotline at 1-800-297-1023.</p>

Precautions!

Before you read anything else, please observe the following:

Warning!

Uniden America Corporation DOES NOT represent this unit to be waterproof. To reduce the risk of fire, electrical shock, or damage to the unit, DO NOT expose this unit to rain or moisture.

Rechargeable Nickel-Metal-Hydride Battery Warning

- This equipment contains a rechargeable Nickel-Metal-Hydride battery.
- Nickel is a chemical known to state of California to cause cancer.
- The rechargeable Nickel-Metal-Hydride battery contained in this equipment may explode if disposed of in a fire.
- Do not short-circuit the battery.
- Do not charge the rechargeable Nickel-Metal-Hydride battery used in this equipment in any charger other than the one designed to charge this battery as specified in the owner's manual. Using another charger may damage the battery or cause the battery to explode.

Rechargeable Nickel-Metal-Hydride Batteries Must Be Recycled or Disposed of Properly

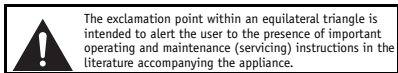

The exclamation point within an equilateral triangle is intended to alert the user to the presence of important operating and maintenance (servicing) instructions in the literature accompanying the appliance.

Uniden works to reduce lead content in our PVC coated cords in our products and accessories.

Warning!

The cords on this product and/or accessories contain lead, a chemical known to the State of California to cause birth defects or other reproductive harm. **Wash hands after handling.**

Important Safety Instructions

When using your telephone equipment, basic safety precautions should always be followed to reduce the risk of fire, electric shock and injury to persons, including the following:

1. Do not use this product near water, for example, near a bath tub, wash bowl, kitchen sink or laundry tub, in a wet basement or near a swimming pool.
2. Avoid using a telephone (other than a cordless type) during an electrical storm. There may be a remote risk of electric shock from lightning.
3. Do not use the telephone to report a gas leak in the vicinity of the leak.

4. Use only the power cord and batteries indicated in this manual. Do not dispose of batteries in a fire. They may explode. Check with local codes for possible battery disposal instructions.
5. Do not disassemble any component of this product.

SAVE THESE INSTRUCTIONS

CAUTION

Risk of explosion if battery is replaced by an incorrect type. Dispose of used batteries according to the instructions. Do not open or mutilate the battery, and disconnect the battery before shipping this product.

The FCC Wants You To Know

This equipment complies with Part 68 of the FCC rules and the requirements adopted by the ACTA. On the bottom of this equipment is a label that contains, among other information, a product identifier in the format US:AAAEQ##TXXXX. If requested, this number must be provided to the telephone company.

An applicable Universal Service Order Codes (USOC) certification for the jacks used in this equipment is provided (i.e., RJ11C) in the packaging with each piece of approved terminal equipment.

A plug and jack used to connect this equipment to the premises wiring and telephone network must comply with the applicable FCC Part 68 rules and requirements adopted by the ACTA. A compliant telephone cord and modular plug is provided with this product. It is designed to be connected to a compatible modular jack that is also compliant. See installation instructions for details.

The REN is used to determine the number of devices that may be connected to a telephone line. Excessive RENs on a telephone line may result in the devices not ringing in response to an incoming call. In most but not all areas, the sum of RENs should not exceed five (5.0). To be certain of the number of devices that may be connected to a line, as determined by the total RENs, contact the local telephone company. For products approved after July 23, 2001, the REN for this product is part of the product identifier that has the format US:AAAEQ##TXXXX. The digits represented by ## are the REN without a decimal point (e.g., 03 is a REN of 0.3). For earlier products, the REN is separately shown on the label.

If this equipment causes harm to the telephone network, the telephone company will notify you in advance that temporary discontinuance of service may be required. But if advance notice isn't practical, the telephone company will notify the customer as soon as possible. Also, you will be advised of your right to file a complaint with the FCC if you believe it is necessary.

The telephone company may make changes in its facilities, equipment, operations or procedures that could affect the operation of the equipment. If this happens the telephone company will provide advance notice in order for you to make necessary modifications to maintain uninterrupted service. Please follow instructions for repairing, if any (e.g. battery replacement section); otherwise do not substitute or repair any parts of the device except as specified in this manual.

Connection to party line service is subject to state tariffs. Contact the state public utility commission, public service commission or corporation commission for information. This equipment is hearing aid compatible.

Should you experience trouble with this equipment, please contact Uniden customer service at 800-297-1023. If the equipment is causing harm to the telephone network, the telephone company may request that you disconnect the equipment until the problem is resolved.

NOTICE: According to telephone company reports, AC electrical surges, typically resulting from lightning strikes, are very destructive to telephone equipment connected to AC power sources. To minimize damage from these types of surges, a surge arrester is recommended.

Changes or modifications to this product not expressly approved by Uniden, or operation of this product in any way other than as detailed by the owner's manual, could void your authority to operate this product.

This device complies with part 15 of the FCC rules. Operation is subject to the following two conditions: (1) This device may not cause harmful interference, and (2) This device must accept any interference received, including interference that may cause undesired operation. Privacy of communications, may not be ensured when using this phone.

To insure the safety of users, the FCC has established criteria for the amount of radio frequency energy various products may produce depending on their intended usage. This product has been tested and found to comply with the FCC's exposure criteria. For body worn operation, the FCC RF exposure guidelines were also met when used with the Uniden accessories supplied or designed for this product. Use of other accessories may not ensure compliance with FCC RF exposure guidelines and should be avoided.

Radio Interference

Radio interference may occasionally cause buzzing and humming in your cordless handset, or clicking noises in the base. This interference is caused by external sources such as TV, refrigerator, vacuum cleaner, fluorescent lighting, or electrical storm. Your unit is NOT DEFECTIVE. If these noises continue and are too distracting, please check around your home to see what appliances may be causing the problem. In addition, we recommend that the base not be plugged into a circuit that also powers a major appliance because of the potential for interference. Be certain that the antenna on the unit is fully extended when needed. In the unlikely event that you consistently hear other voices or distracting transmissions on your phone, you may be receiving radio signals from another cordless telephone or other source of interference. If you cannot eliminate this type of interference, you need to change to a different channel.

Finally, it should be noted that some cordless telephones operate at frequencies that may cause interference to nearby TVs and VCRs. To minimize or prevent such interference, the base of the cordless telephone should not be placed near or on top of a TV or VCR. If interference is experienced, moving the cordless telephone farther away from the TV or VCR will often reduce or eliminate the interference.

Cordless Telephone Privacy

Cordless telephones are radio devices. Communications between the handset and base of your cordless telephone are accomplished by means of radio waves which are broadcast over the open airways. Because of the inherent physical properties of radio waves, your communications can be received by radio receiving devices other than your own cordless telephone unit. Consequently, any communications using your cordless telephone may not be private.

One Year Limited Warranty

Important: Evidence of original purchase is required for warranty service. **WARRANTOR: UNIDEN AMERICA CORPORATION ("Uniden") ELEMENTS OF WARRANTY:** Uniden warrants, for one year, to the original retail owner, this Uniden Product to be free from defects in materials and craftsmanship with only the limitations or exclusions set out below.

WARRANTY DURATION: This warranty to the original user shall terminate and be of no further effect 12 months after the date of original retail sale. The warranty is invalid if the Product is (A) damaged or not maintained as reasonable or necessary, (B) modified, altered, or used as part of any conversion kits, subassemblies, or any configurations not sold by Uniden, (C) improperly installed, (D) serviced or repaired by someone other than an authorized Uniden service center for a defect or malfunction covered by this warranty, (E) used in any conjunction with equipment or parts or as part of any system not manufactured by Uniden, or (F) installed or programmed by anyone other than as detailed by the owner's manual for this product.

STATEMENT OF REMEDY: In the event that the product does not conform to this warranty at any time while this warranty is in effect, warrantor will, either, at its option, repair or replace the defective unit and return it to you without charge for parts, service, or any other cost (except shipping and handling) incurred by warrantor or its representatives in connection with the performance of this warranty. Warrantor, at its option, may replace the unit with a new or refurbished unit. **THE LIMITED WARRANTY SET FORTH ABOVE IS THE SOLE AND ENTIRE WARRANTY PERTAINING TO THE PRODUCT AND IS IN LIEU OF AND EXCLUDES ALL OTHER WARRANTIES OF ANY NATURE WHATSOEVER, WHETHER EXPRESS, IMPLIED OR ARISING BY OPERATION OF LAW, INCLUDING, BUT NOT LIMITED TO ANY IMPLIED WARRANTIES OF MERCHANTABILITY OR FITNESS FOR A PARTICULAR PURPOSE. THIS WARRANTY DOES NOT COVER OR PROVIDE FOR THE REIMBURSEMENT OR PAYMENT OF INCIDENTAL OR CONSEQUENTIAL DAMAGES.** Some states do not allow this exclusion or limitation of incidental or consequential damages so the above limitation or exclusion may not apply to you.

LEGAL REMEDIES: This warranty gives you specific legal rights, and you may also have other rights which vary from state to state. This warranty is void outside the United States of America and Canada.

PROCEDURE FOR OBTAINING PERFORMANCE OF WARRANTY: If, after following the instructions in the owner's manual you are certain that the Product is defective, pack the Product carefully (preferably in its original packaging). Disconnect the battery from the Product and separately secure the battery in its own separate packaging within the shipping carton. The Product should include all parts and accessories originally packaged with the Product. Include evidence of original purchase and a note describing the defect that has caused you to return it. The Product should be shipped freight prepaid, by traceable means, to warrantor at:

Uniden America Service
4700 Amon Carter Blvd.
Fort Worth, TX 76155

I.C. Notice

TERMINAL EQUIPMENT

NOTICE: This equipment meets the applicable Industry Canada Terminal Equipment Technical Specifications. This is confirmed by the registration number. The abbreviation, IC, before the registration number signifies that registration was performed based on a Declaration of Conformity indicating that Industry Canada technical specifications were met. It does not imply that Industry Canada approved the equipment.

NOTICE: The Ringer Equivalence Number (REN) for this terminal equipment is marked on the equipment itself. The REN assigned to each terminal equipment provides an indication of the maximum number of terminals allowed to be connected to a telephone interface. The termination on an interface may consist of any combination of devices subject only to the requirement that the sum of the Ringer Equivalence Numbers of all the devices does not exceed five.

RADIO EQUIPMENT

The term "IC:" before the radio certification number only signifies that Industry Canada technical specifications were met.

Operation is subject to the following two conditions: (1) this device may not cause interference, and (2) this device must accept any interference, including interference that may cause undesired operation of the device. "Privacy of communications may not be ensured when using this telephone".

Memory List

	Name	Phone No.		Name	Phone No.		Name	Phone No.
1			35			69		
2			36			70		
3			37			71		
4			38			72		
5			39			73		
6			40			74		
7			41			75		
8			42			76		
9			43			77		
10			44			78		
11			45			79		
12			46			80		
13			47			81		
14			48			82		
15			49			83		
16			50			84		
17			51			85		
18			52			86		
19			53			87		
20			54			88		
21			55			89		
22			56			90		
23			57			91		
24			58			92		
25			59			93		
26			60			94		
27			61			95		
28			62			96		
29			63			97		
30			64			98		
31			65			99		
32			66			100		
33			67					
34			68					

Index

0-9

- 20 ring options 19
- 3 or 4-Way Conferencing 40

A

- Animation screen 24
- Announce only feature 57
- Answering system

- Deleting a message 60
- Playing your messages 59
- Recording a conversation 62
- Remote access 63
- Repeating a message 59
- Skipping a message 60
- Turning On/Off 57

- Anykey Answer 21
- Area Code 30
- AutoTalk 21

B

- Banner 22
- Battery
 - Preparing and charging 10
 - Replacement and handling 76
- Beltclip 75

C

- Call screen 28
- Call transfer feature 72
- Caller ID
 - Call Waiting 34
 - Caller ID services 50
 - Calling 53

- CIDCW 50
- CWDX 55
- Deleting 52
- Setting 30
- Storing 54
- Viewing 51
- Chain dialing 43
- Clock 29
- Contrast 23
- Copying phonebook 49

D

- Deluxe Call Waiting Features 55
- De-register the handset 32
- Dial mode 31
- Digital security code 74
- DirectLink 70
- Distinctive ringer 20

E

- Earpiece volume 37
- Expanding your phone 67

G

- General information 77

H

- hands-free conversation 33
- Headset installation 75

I

- I.C. notice 84
- Important safety instructions 82
- Intercom 71

K

- Key touch tone 23

L

- Language 22
- Liquid damage 81

M

- Maintenance 76
- Making a call 33
- Message alert 27
- Mute 38

N

- New message LED 58

O

- Outgoing message 24, 57

P

- Phonebook
 - Editing 48
 - Erasing 48
 - Making calls 47
 - Storing 42
 - Viewing 46
- Precautions 82
- Privacy Mode 40

R

- Receiving a call 33
- Redialing a call 35
- Register the handset 68
- Remote 65
- Remote access
 - away from home 63
 - from your handset 65
- Ringer
 - Adjusting 37
 - Do not disturb 37

mute	38
Room/baby monitor	18
S	
Setting up	
base unit	12
extra handset	68
Handset	19
Menu options	16
Soft Key	8
Speed dialing	47
T	
Transferring a call	72
V	
Voice memo	61
W	
Warranty	83

Remote Operation Card

CUT

REMOTE OPERATION CARD

Uniden®

Remote access away from home

1. Call your phone number from a touch-tone phone.
2. During the outgoing message, press 0 and enter your PIN code. The answering system announces the number of messages stored in memory and the voice prompts.
3. To quit, hang up the phone.

Turn on the answering system remotely

1. Call your phone and let it ring 10 times until you hear a beep.
2. Press 0 and then enter your PIN code.
3. Press 0 then 5 to stop the announcement.
4. Press 0 then 6 to turn the answering system on.

CUT

REMOTE OPERATION CARD

Uniden®

Remote access away from home

1. Call your phone number from a touch-tone phone.
2. During the outgoing message, press 0 and enter your PIN code. The answering system announces the number of messages stored in memory and the voice prompts.
3. To quit, hang up the phone.

Turn on the answering system remotely

1. Call your phone and let it ring 10 times until you hear a beep.
2. Press 0 and then enter your PIN code.
3. Press 0 then 5 to stop the announcement.
4. Press 0 then 6 to turn the answering system on.

CUT

REMOTE OPERATION CARD

Uniden®

Remote access away from home

1. Call your phone number from a touch-tone phone.
2. During the outgoing message, press 0 and enter your PIN code. The answering system announces the number of messages stored in memory and the voice prompts.
3. To quit, hang up the phone.

Turn on the answering system remotely

1. Call your phone and let it ring 10 times until you hear a beep.
2. Press 0 and then enter your PIN code.
3. Press 0 then 5 to stop the announcement.
4. Press 0 then 6 to turn the answering system on.

CUT

REMOTE OPERATION CARD

Uniden®

Remote access away from home

1. Call your phone number from a touch-tone phone.
2. During the outgoing message, press 0 and enter your PIN code. The answering system announces the number of messages stored in memory and the voice prompts.
3. To quit, hang up the phone.

Turn on the answering system remotely

1. Call your phone and let it ring 10 times until you hear a beep.
2. Press 0 and then enter your PIN code.
3. Press 0 then 5 to stop the announcement.
4. Press 0 then 6 to turn the answering system on.

CUT

Task	Key
Repeat a Message	0 1
Playing incoming Messages	0 2 abs
Skipping a Message	0 3 def
Deleting a Message	0 4 ghs
Stop Operation	0 5 jkl
Answering System On	0 6 mno
Memo Record/Stop	0 7 pqr
Greeting Message Record/Stop	0 8 tuv
Answer System Off	0 9 wxyz
Help Guidance	1 0 open

CUT

Task	Key
Repeat a Message	0 1
Playing incoming Messages	0 2 abs
Skipping a Message	0 3 def
Deleting a Message	0 4 ghs
Stop Operation	0 5 jkl
Answering System On	0 6 mno
Memo Record/Stop	0 7 pqr
Greeting Message Record/Stop	0 8 tuv
Answer System Off	0 9 wxyz
Help Guidance	1 0 open

CUT

Task	Key
Repeat a Message	0 1
Playing incoming Messages	0 2 abs
Skipping a Message	0 3 def
Deleting a Message	0 4 ghs
Stop Operation	0 5 jkl
Answering System On	0 6 mno
Memo Record/Stop	0 7 pqr
Greeting Message Record/Stop	0 8 tuv
Answer System Off	0 9 wxyz
Help Guidance	1 0 open

CUT

Task	Key
Repeat a Message	0 1
Playing incoming Messages	0 2 abs
Skipping a Message	0 3 def
Deleting a Message	0 4 ghs
Stop Operation	0 5 jkl
Answering System On	0 6 mno
Memo Record/Stop	0 7 pqr
Greeting Message Record/Stop	0 8 tuv
Answer System Off	0 9 wxyz
Help Guidance	1 0 open

Main Menu Flow Chart

•From standby mode

•Base



MENU →



•Handset



MENU →



∨



∨



∨



Enter

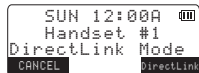

∧

or

∨



∧

or

∨

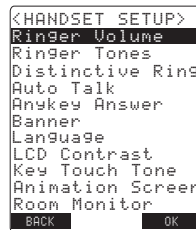

or

∧

∨



OK

•Base



•Handset

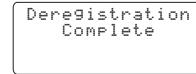
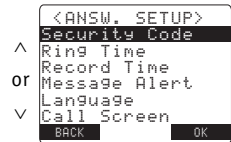
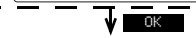
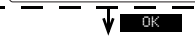
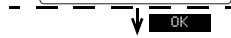

Memo

Memo

At Uniden, we'll take care of you!

Thank you for purchasing a Uniden product. If you have any questions or problems,
please do not return this product to the place of purchase.



Having Trouble?

Our customer care specialists are here to help you! Visit our website at www.uniden.com or call our Customer Service Hotline at **1-800-297-1023**, Mon-Fri, 7 a.m. to 7 p.m. or Sat/Sun, 9 a.m. to 5 p.m. CST. (The Customer Service Hotline is closed on holidays.)



Need a Part?

To order headsets, additional handsets, replacement batteries or other accessories, visit our website at www.uniden.com or call 1-800-554-3988, Mon-Fri, 8 a.m. to 5 p.m. CST.



Help for our Special Needs Customers

If you need special assistance due to a disability or have questions on the accessibility features of this product, please call **1-800-874-9314 (voice or TTY)**

Uniden®

May be covered under one or more of the following U.S. patents:

4,797,916	5,381,460	5,426,690	5,434,905	5,491,745	5,493,605
5,533,010	5,574,727	5,581,598	5,650,790	5,660,269	5,661,780
5,663,981	5,671,248	5,696,471	5,717,312	5,732,355	5,754,407
5,758,289	5,768,345	5,787,356	5,794,152	5,801,466	5,825,161
5,864,619	5,893,034	5,912,968	5,915,227	5,929,598	5,930,720
5,960,358	5,987,330	6,044,281	6,070,082	6,125,277	6,253,088
6,314,278	6,418,209	6,618,015	6,671,315	6,714,630	6,782,098
6,788,920	6,788,953				

Other patents pending.

FOR
ACCESSORIES,
GO ONLINE @
WWW.UNIDEN.COM

REGISTER ONLINE TODAY!

THANK YOU FOR BUYING A UNIDEN PRODUCT.

A World Without Wires | **Uniden**[®]

Free Manuals Download Website

<http://myh66.com>

<http://usermanuals.us>

<http://www.somanuals.com>

<http://www.4manuals.cc>

<http://www.manual-lib.com>

<http://www.404manual.com>

<http://www.luxmanual.com>

<http://aubethermostatmanual.com>

Golf course search by state

<http://golfingnear.com>

Email search by domain

<http://emailbydomain.com>

Auto manuals search

<http://auto.somanuals.com>

TV manuals search

<http://tv.somanuals.com>