

Uniden®

OWNER'S MANUAL



**UNIDEN Model uh095sx
Dual Band (UHF CB/AM CB) Radio**

Contents

Introduction	
Features	2
Preventive Maintenance	2
Troubleshooting	2
Controls / Connectors	3
Indicators	4
Included with your uh095sx	5
Operation	
Setting AM or FM or Dual AM+FM Band	6
Setting the AM Squelch	6
Setting the FM (UHF CB) Squelch	7
Monitor	7
Selecting a Channel	7
Dual Watch	7
Programming the Instant Priority Channel	8
Recalling the Instant Channel	8
Transmitting	8
Call Function	8
Selecting the Call tone	8
Using UHF CB Repeater Channel (FM only)	9
UHF CB Duplex Mode (FM only).....	9
Scanning	10
Open Scan (OS) Mode	10
Group Scan (GS) Mode	11
Priority	11
Programming Scan Channels	11
40 Receive Channels	12
Manual Programming	12
Deleting a Programmed Receive Channel	12
Roger Beep	12
Busy Channel Lockout	13
VOX Operation (optional VOX headset required)	13
Scramble	14
CTCSS (Continuous Tone Coded Squelch System - FM Only).....	14
DCS (Digital Coded Squelch - FM Only)	14
LCD Backlight Dimmer	14
UHF CB Channels & Frequencies	15
AM CB (HF Band) Channels and Frequencies	16
CTCSS & DCS Code List	17
Warranty	18

UNIDEN Model uh095sx Dual Band (UHF CB/AM CB) Radio

Introduction

The Uniden uh095sx is designed to provide you with years of trouble free service. Its rugged components and materials are capable of withstanding harsh environments. Please read this Operating Manual carefully to ensure you gain the optimum performance of the unit

NOTE

The citizen band radio service is licenced in Australia by ACMA Radio-communications (Citizen Band Radio Stations) Class Licence and in New Zealand by MED General User Licence for Citizen Band Radio and operation is subject to conditions contained in those licenses.

Features

AM+FM Band

- Voice Activated Function (VOX)
- VOX Mic sensitivity adjustment - 9 levels
- Volume Control with Power On/Off Switch
- LCD Display with Backlight and 3-stage Dimmer
- Signal Strength Indicator
- RF Power Indicator
- One touch AM, FM or AM+FM Band selectable
- Dual Watch with Instant Channel
- One touch Instant Channel recalling
- AM, FM or AM+FM Group Scan with Priority Channel Watch
- AM, FM or AM+FM Open Scan
- Busy Channel Lock-out Function
- Roger Beep Function On/Off
- 5 Different Call Tones
- Memory Backup if power fails
- Scramble

- 40 Programmable Receive channels (450-512MHz)

AM Band

- Transmit & Receive AM 40CH (AM Band, TX Power 4W) - See p16 for AUST model/NZ model AM frequencies
- Variable Squelch with rotary adjust

FM Band

- Transmit & Receive FM 40CH (UHF-CB, TX Power 5W; Transmission is inhibited at CH22 & CH23)
- Duplex Capability (from CH01 - CH08)
- 38 Built-in CTCSS codes and 104 additional DCS codes
- Preset FM Squelch with 3 levels

Preventive Maintenance:

The following system checks should be made every six to twelve months:

- Check the Standing Wave Ratio (SWR).
- Inspect the tightness of all electrical connections.
- Inspect the antenna coaxial cable for wear or breaks on the shielding.
- Inspect the tightness of all screws and other mounting hardware.

Troubleshooting:

Should the unit malfunction or perform poorly, follow these procedures:

If the transceiver is completely inoperative: Check the power cord and fuse.

If there is trouble with receiving: Check the VOLUME control setting. Be sure the SQUELCH is adjusted properly. Possibly the radio is over-squelched.

If there is trouble with transmitting: Check that the transmission line (coaxial cable) is **securely connected to the ANTENNA** connector. Check that the antenna is fully extended for proper operation. Check that all transmission line (coaxial cable) connections are secure and free of corrosion.

NOTE

Blackening may occur on the Liquid Crystal Display if the uh095sx has been subjected to extreme high temperature (above 60°C) . This is not a fault. Normal LCD operation resumes when the temperature stabilizes back to standard operating condition (0-55°C).

UNIDEN Model uh095sx Dual Band (UHF CB/AM CB) Radio

Controls/Connectors

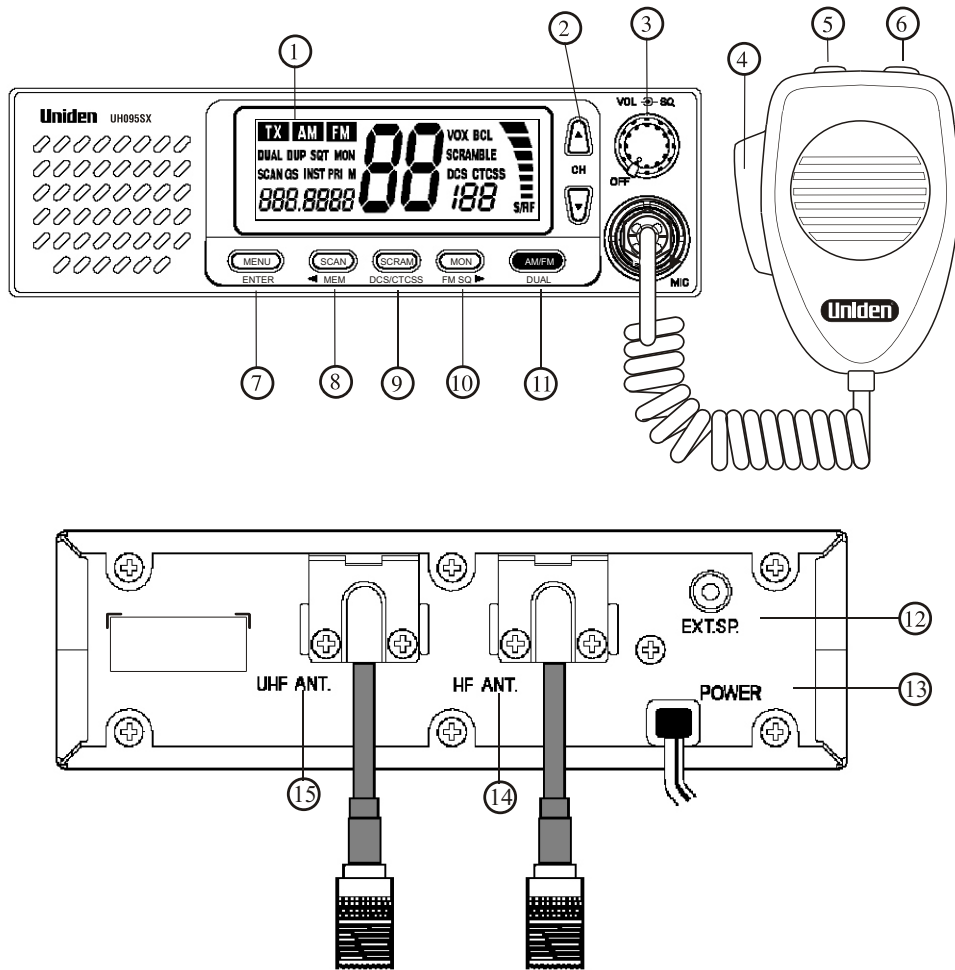

Controls and Connectors

Ref.	Item	Page	Ref.	Item	Page
(1)	Liquid Crystal Display (LCD)	4	(9)	SCRAM/DCS/CTCSS	
(2)	Channel Up/Down	7	(10)	MON/FM SQ/▶	14
(3)	ON/OFF, Volume & AM Squelch	6	(11)	- Monitor, FM Squelch/▶ Button	7, 12
(4)	Push to Talk (PTT) Switch	8	(12)	External Speaker Jack	-
(5)	Call Button	8	(13)	Power Input (13.8VDC)	-
(6)	INST - Instant Button	8	(14)	HF Antenna Connection (AM)	-
(7)	MENU/ENTER Button	8-9, 11-14	(15)	UHF Antenna Connection (FM)	-
(8)	SCAN/MEM/◀ Button	10, 11, 12			

Indicators

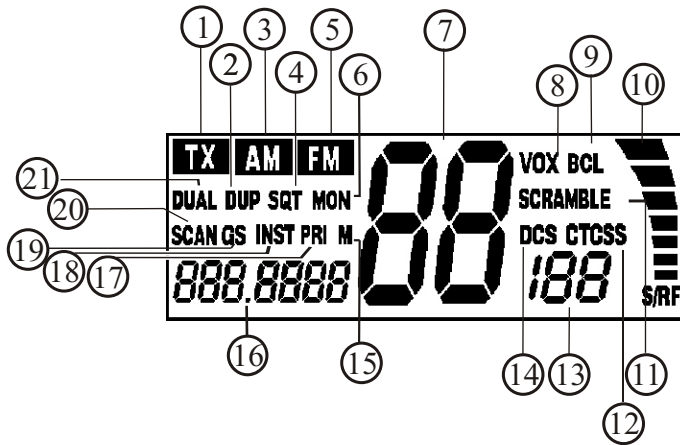

Indicators

Ref.	Item	Page	Ref.	Item	Page
(1)	TX - Transmit	8	(12)	CTCSS - Continuous Tone Coded Squelch System	14
(2)	DUP - Duplex	9	(13)	DCS/CTCSS Code	14
(3)	AM - AM Mode	6	(14)	DCS - Digital Coded Squelch	14
(4)	SQT - FM Squelch	7	(15)	M - Memory	11
(5)	FM - FM Mode	6	(16)	Channel Frequency	7
(6)	MON - Monitor	7	(17)	PRI - Priority Channel	11
(7)	Channel Number	7	(18)	INST - Instant Channel	8
(8)	VOX - Voice Activation	13	(19)	GS - Group Scan	11
(9)	BCL - Busy Channel Lockout	13	(20)	SCAN	10
(10)	S/R/F - Signal receive or transmit RF power	-	(21)	DUAL - Dual Watch	7
(11)	SCRAMBLE	14			

UNIDEN Model uh095sx Dual Band (UHF CB/AM CB) Radio

Included with your uh095sx

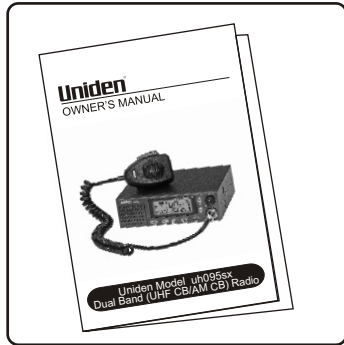

uh095sx Owners Manual

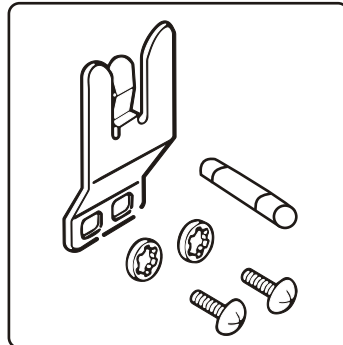

Microphone Hanger & Screws
Washers and spare fuse

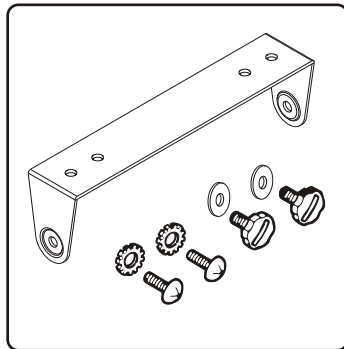

Mounting Bracket,
Mounting Screws, Washer Stars
And Screws

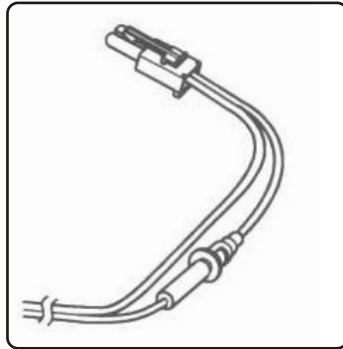

DC Power Cord with fuse

Optional Accessories



External Speaker (MS100)

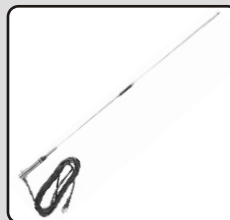

UHF CB Antenna (AT470)



VOX Earphone/Mic
(VM090)

Operation

Selecting AM or FM or Dual AM+FM Band

Turn the uh095sx ON by rotating the volume control clockwise. By pressing **[AM/FM]** you may select which band the uh095sx will receive and transmit on. When **[AM]** only is displayed the uh095sx will transmit and receive on AM CB channels which is HF Band. When **[FM]** only is displayed transmit and receive will be on UHF CB channels. When both **[AM]** and **[FM]** are displayed either **[AM]** or **[FM]** will flash reflecting the band that the uh095sx is currently on.

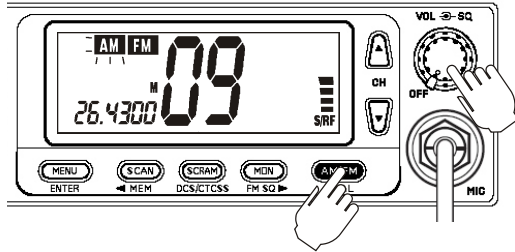

Setting the AM Squelch

Select **[FM]** only by pressing **[AM/FM]**. Turn the outer ring of the control to adjust the Squelch.

NOTE You must select a channel which is not in use before setting the SQUELCH control. (Selecting a Channel see p7)

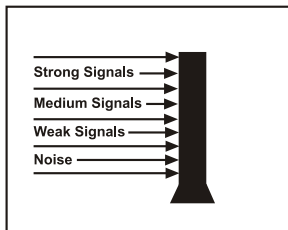
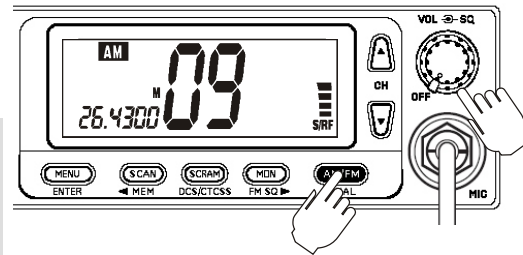

Think of the squelch control as a gate. If you turn Squelch fully clockwise it raises the 'Squelch gate' so high that no signals get through.

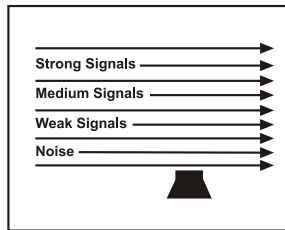

If you turn the Squelch fully counterclockwise it lowers the 'Squelch Gate' to the extent that all signals get through - weak, medium and strong signals and noise.

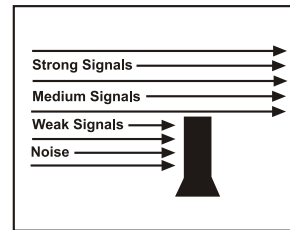

To set the 'Squelch Gate' to the desired level, turn the squelch knob counterclockwise until you hear noise. Then carefully turn the Squelch knob clockwise until the noise stops. Now only strong signals get through.

UNIDEN Model uh095sx Dual Band (UHF CB/AM CB) Radio

Operation

Setting the FM (UHF CB) Squelch

The FM Band has an Automatic Squelch Control. It requires no adjustment. However, if you are in a very high noise area it may break through. The uh095sx has 3 preset squelch levels:

- 1 - Normal sensitivity (minimum squelch)
- 2 - Medium sensitivity (medium squelch)
- 3 - Minimum sensitivity (maximum/tight squelch)

Select **FM** only by pressing **AM/FM**.

Press and hold **MON** /**FM SQ**/▶. The squelch preset will flash. Use ▼ or ▲ to select preset 1, 2 or 3. Press **MON** /**FM SQ**/▶ to store. The tight squelch icon **SQT** flashes if level 3 is selected.

Monitor

Press **MON** momentarily to open the squelch and receive all weak signals. **MON** appears on the display when on.

Press **MON** again momentarily to cancel.

Selecting a Channel

Press **AM/FM** to select either **AM** or **FM** or both **AM** + **FM**. Press **CH** ▼ or ▲ to select the desired channel.

NOTE
For your reference a list of the available channels, corresponding frequencies and guidelines for their use is printed on page 15. For Australia, UHF CB/FM Channels 05 and 35 are reserved for Emergency Calls.

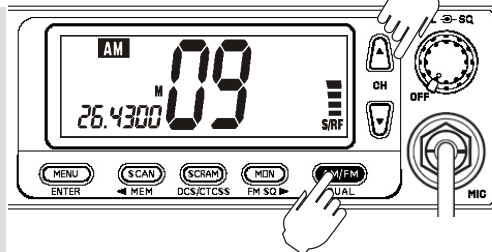

Dual Watch

Dual watch will continuously monitor the Instant channel no matter what other channel or band you are on (Instant Priority Channel see p8).

Press and hold **AM/FM** /**DUAL** to turn Dual Watch on or off. **DUAL** appears on the display when on.

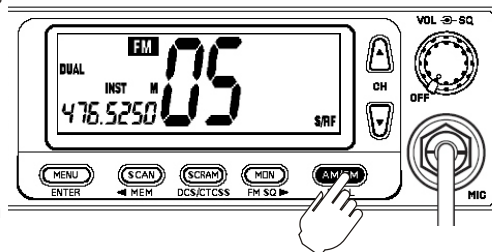

UNIDEN Model uh095sx Dual Band (UHF CB/AM CB) Radio

Operation

Programming the Instant Priority Channel

Press ∇ or \blacktriangle to select the Priority Channel you prefer on either AM or FM.

Press and hold INST button on the microphone for 3 seconds to store the new setting. **INST** icon appears.

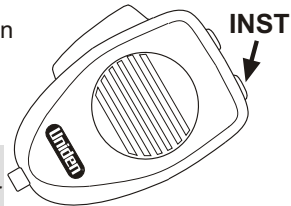

NOTE If Dual Watch feature is on the Instant channel will always be monitored no matter what band or other channel you are on.

NOTE If Priority feature is on the Instant channel will always be monitored no matter what band or group you are scanning.

Recalling the Instant Channel

Momentarily press the INST button on the microphone at any time to return to the Instant Channel.

Transmitting

The uh095sx uses the 40 UHF-CB Channels and the 40 AM-CB Channels.

NOTE UHF Channels 22 and 23 are for telemetry and telecommand applications. Transmit is inhibited on these channels.

Select the desired channel. Press the microphone's PTT button and speak normally into the microphone. Hold it approx. 7cm from your mouth. Release the PTT button to end the transmission and listen for a reply.

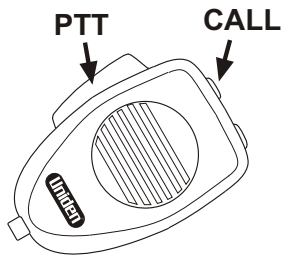

Call Function

Press the microphone Call Button. A two second ringing tone will be transmitted. You may select from 5 types of tones (see below).

NOTE Current regulations require calling tones to be restricted to one transmission per minute. If a second transmission is attempted within one minute then an error tone will sound.

Selecting the Call tone

Press **MENU** six times.

Press ∇ or \blacktriangle to select from call tones 1-5.

Press and hold **MENU** / **ENTER** to store the new setting.

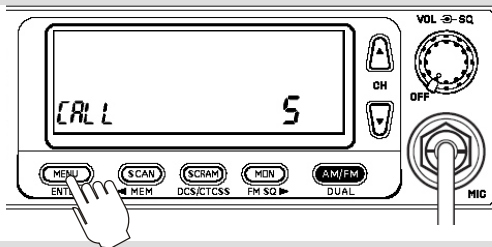

NOTE If a button is not pressed within 10 seconds the uh095sx will automatically exit the Menu Mode.

Operation

Using UHF CB Repeater Channels (FM Only)

UHF CB repeaters are used to retransmit or relay your signal. Repeaters will extend the range of your radio and overcome the shielding effect caused by solid obstructions. In normal Simplex operation, your radio transmits on one particular frequency and receives on that same frequency. If there is a barrier that partially blocks your transmitted signal, the probability of another radio receiving the signal is very slim. Hills, tall buildings, metallic structures,...etc tend to act as a screen between radios.

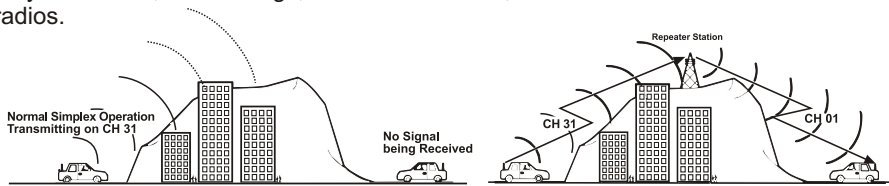

Standard Operation without the aid of a Repeater Station.

Operation with the aid of a Repeater Station (Duplex).

The signal coming from your radio is received by the Repeater Station and the re-transmitted at the same time on another channel. This operation is called "Duplexing".

For example,

CH01 on Duplex Mode will Receive on CH01 but Transmit on CH31

CH02 on Duplex Mode will Receive on CH02 but Transmit on CH32 etc...

If you transmit on CH01 Duplex mode, you are actually transmitting on CH31 the repeater station down-converts your signal and retransmits on CH01.

UHF CB Duplex Mode (FM only)

For this example we are adopting CH01 as the channel being used in your area for repeater use.

Press **MENU** once. **DUP** flashes on the display. Press **↓** or **↑** to select duplex ON or OFF. Press and hold **MENU** / **ENTER** to store setting. Only channels 01 - 08 are available for Duplex.

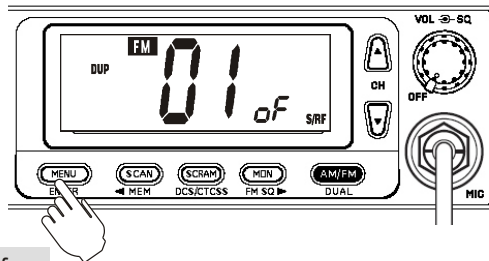

Check with your local Retailer for information on available repeaters.

Operation

Scanning

The uh095sx scanning feature allows you to search the SCAN MEMORY for active channels on either AM or FM or both AM+FM channels at the same time.

The scan memory has two main groups; Open Scan (OS) and Group Scan (GS). OS Scan searches all the channels in its memory continuously. GS Scan has the ability of monitoring a priority channel every 1.5 seconds while searching channels in its memory.

Press **[AM/FM]** to select which band you wish to scan.

Press **[SCAN]** and Scanning starts.

The **SCAN** icon flashes.

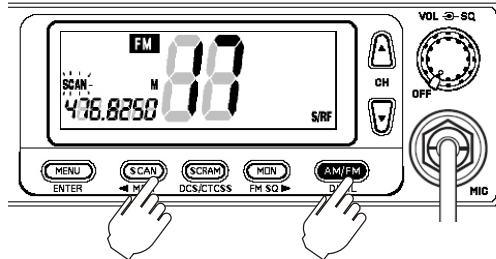

- The scan direction can be changed at any time by pressing **[V]** or **[A]**.
- To skip the active channel, press **[V]** or **[A]** momentarily. Scanning resumes.
- To deactivate SCAN, press **[SCAN]** or the INST button on the microphone.
- If SCAN is deactivated while Scanning has stopped on an active channel, the uh095sx will stay on that active channel.
- If no channels are active, the uh095sx will reinstate the starting channel.
- If the PTT button is pressed during scanning the uh095sx will return temporarily to the starting scan channel and transmit. Scanning will automatically resume after 20 seconds of inactivity.
- If the PTT button is pressed while scanning has stopped on an active channel the uh095sx will transmit on that same channel. Scanning will automatically resume after 20 seconds of inactivity.

NOTE

Programming Scan Channels see p11.

Open Scan (OS) Mode

Allows continuous scanning of all selected channels. If an active channel is found, scanning will stop on that channel.

If the received signal ceases, the unit will wait 3 seconds for the signal to return, otherwise scanning resumes.

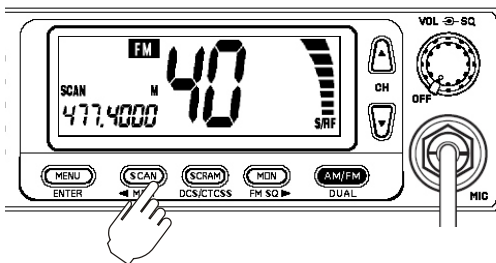

NOTE

OS Mode is indicated by the absence of the GS icon.

UNIDEN Model uh095sx Dual Band (UHF CB/AM CB) Radio

Operation

Group Scan (GS) Mode

NOTE *The GS scan memory is empty at factory setting. Channels must be programmed to GS scan memory for scan to work in GS mode (see Programming Scan Channels below).*

Allows you to monitor a Priority channel while scanning other channels in the GS memory. The Priority channel is the same as the Instant Priority Channel, see p.8.

To use GS Mode Scanning, press **MENU** two times momentarily. Press **▼** or **▲** to select **ON**. Press and hold **MENU** / **ENTER** to store setting. GS appears on the display when on.

GS Scanning checks the Instant Priority Channel for activity regularly.

NOTE *If the priority setting is not turned on, then GS can be used in the same way as OS. (see Priority below).*

The uh095sx will scan the group channels and stop on any active channel. When stopped on an active channel the Priority channel will still be monitored for activity. If the Priority channel becomes active the uh095sx will immediately switch to the Priority channel.

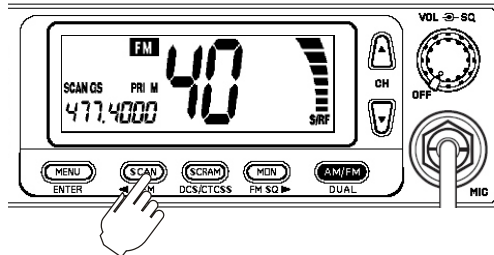

To deactivate SCAN, press the **SCAN** button or the INST button on the microphone.

Priority

Priority monitors the instant channel continuously during scanning. Press **MENU** three times. Press **▼** / **▲** to select **ON**. Press and hold **MENU** / **ENTER** to store. **PRI** appears on the display when on.

Programming Scan Channels

Select which Scanning Mode you wish to use - OS or GS.

Select **AM** or **Fm** or **AM + Fm**. Select the channel you want to store using **▼** / **▲**.

Press and hold **SCAN** / **MEM** to store. **M** icon appears and a short tone beep is heard.

To remove the channel from Memory. Press and hold **SCAN** / **MEM** once more. The **M** icon disappears.

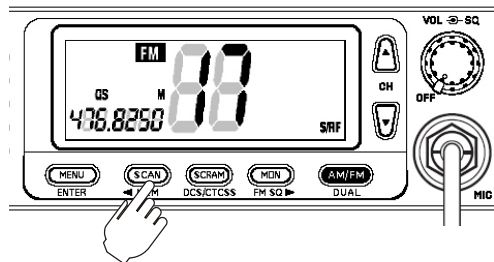

UNIDEN Model uh095sx Dual Band (UHF CB/AM CB) Radio

Operation

40 Receive Channels

The uh095sx also has 40 receive only channels (CH41 to CH80) which can be programmed with frequencies ranging from 450-512MHz (in 12.5kHz steps). When programmed they are added to the FM band channels. If you know the frequency you may store it manually.

Manual Programming

Turn power off. Press and hold **MON** while turning power back on. The channel indicator flashes the lowest available empty channel. You may use the **▼** or **▲** to select another channel.

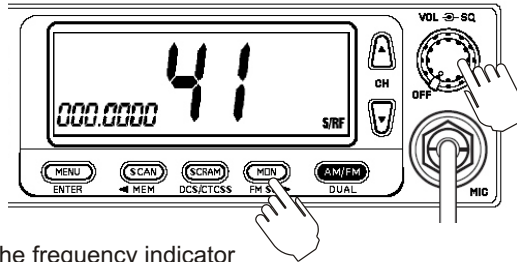

Press **MENU/ENTER**. The first digit of the frequency indicator flashes. Press **▼** or **▲** to select first digit.

Press **◀SCAN** or **MON▶** to move left or right between digit positions and press **▼** or **▲** to change digits.

When finished press **MENU/ENTER**, the channel indicator flashes. Press **▼** or **▲** to select next channel for programming or press and hold **MENU/ENTER** to store setting. A confirmation tone sounds. The channel is automatically entered into OS scan memory.

Deleting a Programmed Receive Channel

Follow the steps in Manual Programming to enter a frequency for a desired channel. Select 0 for the first frequency digit and then press **MENU/ENTER**. Press **▼** or **▲** to select another channel or press and hold **MENU/ENTER** to exit programming mode.

Roger Beep

Roger Beep is a BEEP that is sent to notify the end of transmission (both PTT and VOX transmission.)

Press **MENU** eight times.

Press **▼** or **▲** to display ON.

Press and hold **MENU/ENTER** to store the new setting.

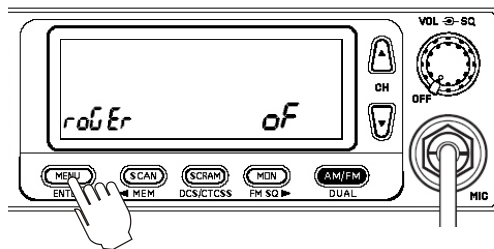

NOTE

If a button is not pressed within 10 seconds the uh095sx will automatically exit the Menu Mode.

UNIDEN Model uh095sx Dual Band (UHF CB/AM CB) Radio

Operation

Busy Channel Lockout

BCL is used when CTCSS or DCS is selected to prevent transmission when the uh095sx detects a transmission from another unit using the same CTCSS or DCS code.

Press **[MENU]** five times. Press **▼** or **▲** to select ON. Press and hold

[MENU] /ENTER to store the new setting.

BCL appears on the display when on.

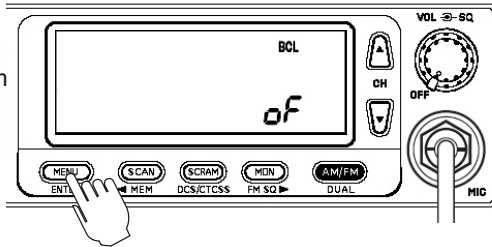

NOTE

If a button is not pressed within 10 seconds the uh095sx will automatically exit the Menu Mode.

VOX Operation (optional VOX headset required)

VOX is the automatic transmitting function by inputting voice into the VOX headset mic without pressing the PTT key. Press **[MENU] /ENTER** four times. Press **▼** or **▲** to select the desired VOX sensitivity (oF, 1-9).

Press and hold **[MENU] /ENTER** to store the new setting. **VOX** appears on the display when select 1-9. Connect the optional VOX headset.

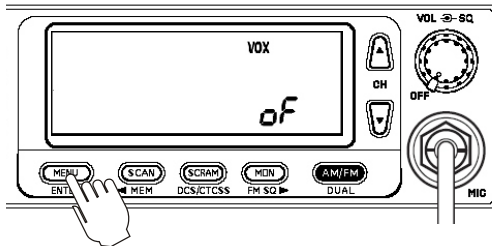

NOTE

If a button is not pressed within 10 seconds the uh095sx will automatically exit the Menu Mode.

Operation

Scramble

Scramble enables private communications by scrambling the voice signal. This prevents users without descrambler equipment or a compatible unit understanding the conversation. Select desired channel. Press **SCRAM** momentarily. **SCRAMBLE** icon appears.

Press **SCRAM** momentarily again to disable scramble.

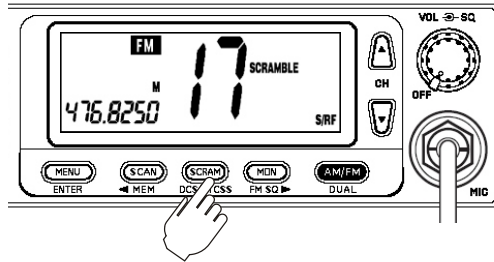

For safety purposes Scramble is inhibited on FM channels 5, 11, 35 and Duplex enabled channels and also AM channels 9, 11 and 16 for Australia.

CTCSS (Continuous Tone Coded Squelch System - FM Only)

Press and hold **SCRAM** DCS/CTCSS. **CTCSS** icon appears.

Press **▼** or **▲** to select the desired CTCSS code 01 - 38.

Press **SCRAM** DCS/CTCSS once to store the new setting.

To turn off CTCSS (or DCS) select the of code during setting.

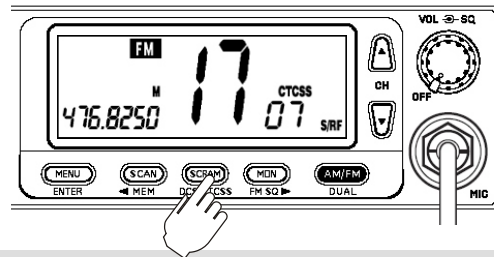

FM Channels 5 and 35 are used for emergency channels. CTCSS and DCS will not operate on these channels.

DCS (Digitally Coded Squelch - FM Only)

DCS is a digital extension of CTCSS. It provides 104 extra, digitally coded, squelch codes that follow after the 38 CTCSS codes. CTCSS 1-38, followed by DCS 1-104.

Follow the steps for setting a CTCSS code. Press **▼** or **▲** until the DCS codes appear. Press **SCRAM** DCS/CTCSS to store. The **DCS** icon and code will display.



FM Channels 5 and 35 are used for emergency channels. CTCSS and DCS will not operate on these channels.

LCD Backlight Dimmer

Press **MENU** seven times. Press **▼** **▲** to select Hi, Low or Off. Press and hold **MENU**/ENTER to store.

UHF CB Channels & Frequencies



Please follow these guidelines for channel use in Australia:

- Channels 05 and 35 are Emergency Channels.
- Channel 11 is a Calling Channel.
- Channels 22 and 23 are for telemetry and telecommand applications and TX is inhibited on these channels.

General communication is accepted on all other channels with these guidelines:

- Channel 40 - road channel (Australia).
- Channels 01-08 (and 31-38) are repeater channels.
- Scramble is inhibited on a Duplex channel when Duplex enabled.

CH No.	Simplex Mode Transmit / Receive Frequency (MHz)	Duplex Mode Transmit Frequency (MHz)	Scramble	CTCSS/DCS	Usage
1	476.425	477.175 CH31	-	-	Repeater
2	476.450	477.200 CH32	-	-	Repeater
3	476.475	477.225 CH33	-	-	Repeater
4	476.500	477.250 CH34	-	-	Repeater
5	476.525	477.275 CH35	Inhibited	Inhibited	Repeater /Emergency
6	476.550	477.300 CH36	-	-	Repeater
7	476.575	477.325 CH37	-	-	Repeater
8	476.600	477.350 CH38	-	-	Repeater
9	476.625	-	-	-	-
10	476.650	-	-	-	-
11	476.675	-	Inhibited	-	Calling
12	476.700	-	-	-	-
13	476.725	-	-	-	-
14	476.750	-	-	-	-
15	476.775	-	-	-	-
16	476.800	-	-	-	-
17	476.825	-	-	-	-
18	476.850	-	-	-	-
19	476.875	-	-	-	-
20	476.900	-	-	-	-
21	476.925	-	-	-	-
22	476.950 (RX only)	-	-	-	Telemetry
23	476.975 (RX only)	-	-	-	Telemetry
24	477.000	-	-	-	-
25	477.025	-	-	-	-
26	477.050	-	-	-	-
27	477.075	-	-	-	-
28	477.100	-	-	-	-
29	477.125	-	-	-	-
30	477.150	-	-	-	-
31	477.175	-	-	-	Repeater
32	477.200	-	-	-	Repeater
33	477.225	-	-	-	Repeater
34	477.250	-	-	-	Repeater
35	477.275	-	Inhibited	Inhibited	Repeater /Emergency
36	477.300	-	-	-	Repeater
37	477.325	-	-	-	Repeater
38	477.350	-	-	-	Repeater
39	477.375	-	-	-	-
40	477.400	-	-	-	-

UNIDEN Model uh095sx Dual Band (UHF CB/AM CB) Radio

AM CB (HF Band) Channels & Frequencies

NOTE

The uh095sx will only operate on the frequencies of the country of original purchase. The frequencies cannot be changed from one country to another. It is illegal to operate a uh095sx set on Australian frequencies in New Zealand or a uh095sx set on New Zealand frequencies in Australia.

- Road Channel for Australia/New Zealand Model is shown in **BOLD** in the table. Modulation: AM, Transmit Power (each channel): 4W

CH NO.	Frequency AUST (MHz)	Frequency NZ (MHz)	Scramble	Usage
01	26.965	26.330	-	-
02	26.975	26.340	-	-
03	26.985	26.350	-	-
04	27.005	26.370	-	-
05	27.015	26.380	-	-
06	27.025	26.390	-	-
07	27.035	26.400	-	-
08	27.055	26.420	-	Road Ch(AUS)
09	27.065	26.430	Inhibited (AUS only)	Emergency
10	27.075	26.440	-	-
11	27.085	26.450	Inhibited (AUS only)	Emergency
12	27.105	26.470	-	-
13	27.115	26.480	-	-
14	27.125	26.490	-	-
15	27.135	26.500	-	Road Ch(NZ)
16	27.155	26.520	Inhibited (AUS only)	SSB
17	27.165	26.530	-	-
18	27.175	26.540	-	-
19	27.185	26.550	-	-
20	27.205	26.570	-	-
21	27.215	26.580	-	-
22	27.225	26.590	-	-
23	27.255	26.620	-	-
24	27.235	26.600	-	-
25	27.245	26.610	-	-
26	27.265	26.630	-	-
27	27.275	26.640	-	-
28	27.285	26.650	-	-
29	27.295	26.660	-	-
30	27.305	26.670	-	-
31	27.315	26.680	-	-
32	27.325	26.690	-	-
33	27.335	26.700	-	-
34	27.345	26.710	-	-
35	27.355	26.720	-	-
36	27.365	26.730	-	-
37	27.375	26.740	-	-
38	27.385	26.750	-	-
39	27.395	26.760	-	-
40	27.405	26.770	-	-

UNIDEN Model uh095sx Dual Band (UHF CB/AM CB) Radio

CTCSS & DCS Code List

CTCSS Code LIST

Code No.	Frequency (Hz)	Code No.	Frequency (Hz)	Code No.	Frequency (Hz)
"oF"	OFF	13	103.5	26	162.2
1	67.0	14	107.2	27	167.9
2	71.9	15	110.9	28	173.8
3	74.4	16	114.8	29	179.9
4	77.0	17	118.8	30	186.2
5	79.7	18	123.0	31	192.8
6	82.5	19	127.3	32	203.5
7	85.4	20	131.8	33	210.7
8	88.5	21	136.5	34	218.1
9	91.5	22	141.3	35	225.7
10	94.8	23	146.2	36	233.6
11	97.4	24	151.4	37	241.8
12	100.0	25	156.7	38	250.3

DCS Code LIST

Code No.	DCS Code (Octal)	Code No.	DCS Code (Octal)	Code No.	DCS Code (Octal)	Code No.	DCS Code (Octal)
1	023	27	152	53	311	79	466
2	025	28	155	54	315	80	503
3	026	29	156	55	325	81	506
4	031	30	162	56	331	82	516
5	032	31	165	57	332	83	523
6	036	32	172	58	343	84	526
7	043	33	174	59	346	85	532
8	047	34	205	60	351	86	546
9	051	35	212	61	356	87	565
10	053	36	223	62	364	88	606
11	054	37	225	63	365	89	612
12	065	38	226	64	371	90	624
13	071	39	243	65	411	91	627
14	072	40	244	66	412	92	631
15	073	41	245	67	413	93	632
16	074	42	246	68	423	94	654
17	114	43	251	69	431	95	662
18	115	44	252	70	432	96	664
19	116	45	255	71	445	97	703
20	122	46	261	72	446	98	712
21	125	47	263	73	452	99	723
22	131	48	265	74	454	100	731
23	132	49	266	75	455	101	732
24	134	50	271	76	462	102	734
25	143	51	274	77	464	103	743
26	145	52	306	78	465	104	754

WARRANTY

UNIDEN UH095SX UHF CB/AM CB TRANSCEIVER RADIO

Two Year Limited Warranty

Note: Please keep your sales docket as it provides evidence of warranty.

Warrantor: Uniden Australia Pty Limited ABN 58 001 865 498

Uniden New Zealand Limited

Warranty only available in original country of purchase

Elements of Warranty: Uniden warrants to the original retail owner for the duration of this warranty, its uh095sx Dual Band (UHF CB/AM CB) Radio (hereinafter referred to as the Product) to be free from defects in materials and craftsmanship with only the limitations or exclusions set out below.

Warranty Duration: This warranty to the original retail owner only, shall terminate and be of no further effect TWO (2) years after the date of original retail sale. This warranty will be deemed invalid if the Product is;

- (A) Damaged or not maintained as reasonable and necessary,
- (B) Modified, altered or used as part of any conversion kits, subassemblies, or any configurations not sold by Uniden,
- (C) Improperly installed,
- (D) Repaired by someone other than an authorized Uniden Repair Agent for a defect or malfunction covered by this warranty,
- (E) Used in conjunction with any equipment or parts or as part of a system not manufactured by Uniden, or
- (F) Where the Serial Number label of the product has been removed or damaged beyond recognition.

Warranty only valid in the country of original retail/sale.

Parts Covered: This warranty covers for two (2) years, the Product and included accessories.

Statement of Remedy: In the event that the Product does not conform to this warranty at any time while this warranty is in effect, the warrantor at its discretion, will repair the defect or replace the Product and return it to you without charge for parts or service. This warranty does not provide for reimbursement or payment of incidental or consequential damages.

This EXPRESS WARRANTY is in addition to and does not in any way affect your rights under the TRADE PRACTICES ACT 1974 (Cth) (Australia) or the CONSUMER GUARANTEES ACT (New Zealand).

Procedure for obtaining performance or warranty: In the event that the Product does not conform to this warranty, the Product should be shipped or delivered, freight prepaid, with evidence of original purchase, (eg. a copy of the sales docket), to the warrantor at:

UNIDEN AUSTRALIA PTY LTD

Service Division
345 Princes Highway,
Rockdale, NSW 2216
Fax (02) 9599 3278
www.uniden.com.au

UNIDEN NEW ZEALAND LTD

Service Division
150 Harris Road, East Tamaki,
Auckland
Fax (09) 274 4253
www.uniden.co.nz

Uniden®

© 2007 Uniden Australia Pty Limited/Uniden New Zealand Limited
Printed in China UTZZ01934ZA(0)

Free Manuals Download Website

<http://myh66.com>

<http://usermanuals.us>

<http://www.somanuals.com>

<http://www.4manuals.cc>

<http://www.manual-lib.com>

<http://www.404manual.com>

<http://www.luxmanual.com>

<http://aubethermostatmanual.com>

Golf course search by state

<http://golfingnear.com>

Email search by domain

<http://emailbydomain.com>

Auto manuals search

<http://auto.somanuals.com>

TV manuals search

<http://tv.somanuals.com>