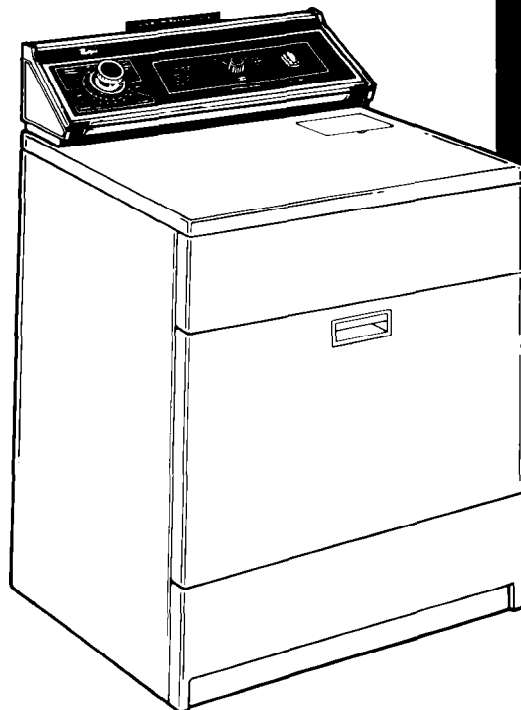
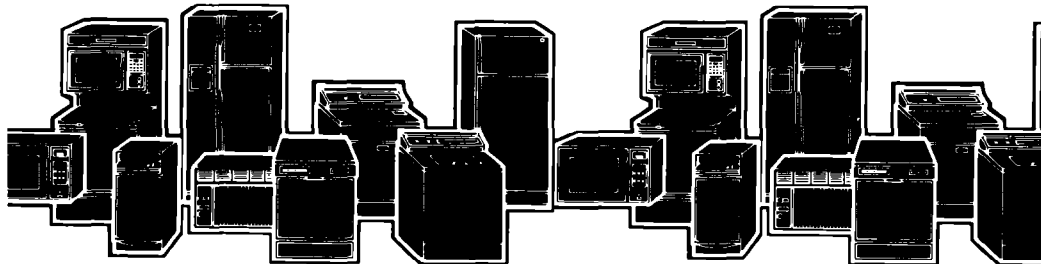

use & care guide

The Whirlpool logo, consisting of a stylized swirl icon above the word "Whirlpool" in a serif font, all contained within a black square background.

AUTOMATIC DRYERS

**Electric Model
LE5920XM
and
Gas Model
LG5921XM**

Wave Ovens, Trash Compactors, Room Air Conditioners, Dehumidifiers, Automatic Washers, Clothes Dryers, Freezers, Refrigerator-Freeze



Parts and features

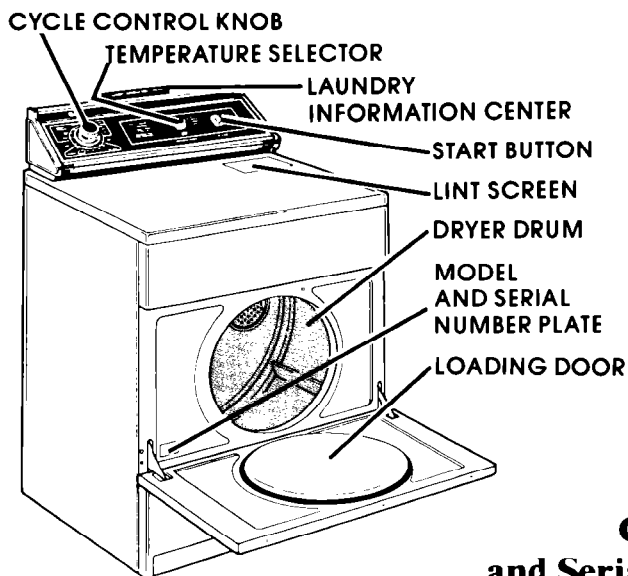

Remove the Consumer Buy Guide label before using your dryer. It will be easier to remove.

Wipe out the dryer drum with a damp cloth to remove dust from storing or shipping.

Copy your Model and Serial Numbers here

When you need service or call with a question, have this information ready:

- 1. Complete** Model and Serial Numbers (from the plate located as shown).
- 2.** Purchase date from sales slip.

Copy this information in these spaces. Keep this book, your warranty, sales slip and "Dryer Guide" in the Laundry Information Center on the back of the dryer console.

There is no warranty registration to return. Proof-of-purchase is all that is required for in-warranty service.

Complete Model Number

Complete Serial Number

Purchase Date

Service Company and Telephone Number

Contents

	Page		Page
PARTS AND FEATURES	2	End-of-Cycle Signal	8
YOUR RESPONSIBILITIES	3	Using the Drying Rack ...	8
SAFETY FIRST	3	LINT SCREEN	9
SELECTING A CYCLE AND		LINT REMOVAL	9
STARTING YOUR DRYER ...	4	CARING FOR YOUR DRYER ..	10
OPERATING INSTRUCTIONS ..	6	Vacation Care	10
The Automatic Cycles ...	6	IF YOU NEED SERVICE OR	
Timed Drying	6	ASSISTANCE	11
DRYING TIPS	7	1. Before Calling for	
FLUFF AIR Setting	7	Assistance	11
Mixed Loads	7	2. If You Need Assistance	
TUMBLE PRESS® Setting ...	7	3. If You Need Service ...	11
Drying Times	7	4. If You Have a Problem	11

Your Responsibilities

Read this "Use and Care Guide" and your "Dryer Guide" carefully for important use and safety information.

You are personally responsible for making sure that your dryer...

- is installed by a qualified installer.
- is properly maintained.
- is installed in an area protected from the weather.
- is properly installed and leveled in a well ventilated room* on a floor that can support the weight.

- is located in an area where the temperature is above 45°F (7.2°C).
 - is connected to the right kind of outlet, electric supply and grounding.*
 - is properly connected to fuel and exhaust systems.*
 - is used only for jobs normally expected of home clothes dryers.
 - is not run where there may be explosive fumes.
 - is not used by children or anyone unable to operate it properly.
- *See the "Installation Instructions" for complete information.

Safety first

ALWAYS unplug the power supply cord or turn off electrical power before attempting to service the dryer. **Shut off the GAS VALVE** if yours is a gas dryer.

ALWAYS shut off the gas valve before leaving on vacation.

NEVER use flammable fluids (dry-cleaning solvents, gasoline, kerosene) in or near your dryer.

ALWAYS hand launder or air dry fabrics treated with flammable fluids before putting them into your dryer.

NEVER dry items containing wax or paint in the dryer. The fumes can create a **FIRE HAZARD**.

FIRE HAZARD and **DAMAGE** to some materials can result from:

- drying heat-sensitive materials with heat (see page 4).
- operating the dryer with the lint screen loose, damaged or missing.
- allowing lint to build up inside the dryer (see page 9).

NEVER allow children to operate, play with, or crawl inside the dryer.

NEVER operate the dryer if...

- it is not working right.
- it is damaged.
- parts are missing.
- all panels are not in place.

DO NOT let dust, lint, paper, rags, chemicals, etc., pile up around or under the dryer. **DO NOT** install against drapes or curtains.

• FOR YOUR SAFETY •

IF YOU SMELL GAS:

1. OPEN WINDOWS.
2. DON'T TOUCH ELECTRICAL SWITCHES.
3. EXTINGUISH ANY OPEN FLAME.
4. IMMEDIATELY CALL GAS SUPPLIER.

• FOR YOUR SAFETY •

DO NOT STORE OR USE GASOLINE OR OTHER FLAMMABLE VAPORS AND LIQUIDS IN THE VICINITY OF THIS OR ANY OTHER APPLIANCE.

• SAVE THESE INSTRUCTIONS •

Selecting a cycle and starting your dryer

Before starting your dryer, be sure laundry is sorted and loaded properly (see your "Dryer Guide"). **Be sure the door is tightly closed.**

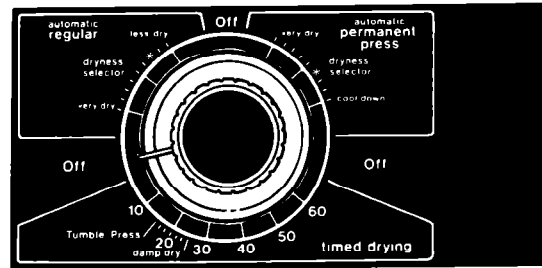

TYPE OF LOAD	SUGGESTED CYCLE	SUGGESTED TEMPERATURE
COTTONS – LINENS		
EXTRA HEAVY – Bedspreads, mattress pads, quilts	AUTOMATIC REGULAR	PERM'T PRESS HEAVY HIGH
HEAVYWEIGHT FABRICS – Towels, jeans, corduroys, work clothes		
MEDIUMWEIGHT COTTONS – Sheets, pillowcases, cotton underwear, diapers		
LIGHTWEIGHT COTTONS – Batistes, organdies, lingerie		
PERMANENT PRESS, SYNTHETICS AND BLENDS		
HEAVYWEIGHT FABRICS – Work clothes, jackets, raincoats	AUTOMATIC PERM'T PRESS	PERM'T PRESS HEAVY HIGH
MEDIUMWEIGHT FABRICS – Shirts, play clothes, sheets, slacks		
LIGHTWEIGHT FABRICS – Lingerie, blouses, dresses		
KNITS		
HEAVYWEIGHT – Cottons, rayons, blends, T-shirts, slacks, shirts	AUTOMATIC PERM'T PRESS	PERM'T PRESS HEAVY HIGH KNITS GENTLE LOW
LIGHTWEIGHT – Synthetics (polyester, acrylic, etc.) and blends, lingerie, blouses, dresses		
LIGHTWEIGHT AND DELICATE FABRICS		
Sheer Curtains (2 or 3 panels)	AUTOMATIC PERM'T PRESS	KNITS GENTLE LOW
Gauze, lace, etc.		
RUBBER, PLASTIC, HEAT-SENSITIVE FABRICS		
FOAM RUBBER – Pillows, bras, stuffed toys	20-30 MINS.	FLUFF AIR
PLASTIC – Shower curtains, tablecloths	20-30 MINS.	
RUBBER-BACKED RUGS	40-50 MINS.	
OLEFIN, POLYPROPYLENE, SHEER NYLON ..	15-20 MINS.	



Drying these and other heat-sensitive materials can damage them or be a FIRE HAZARD.

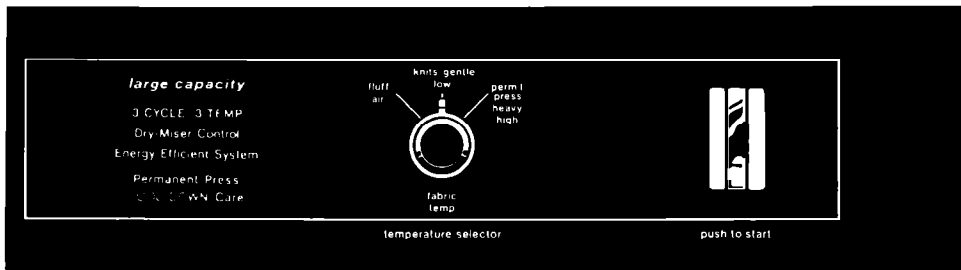

Select a 1. CYCLE

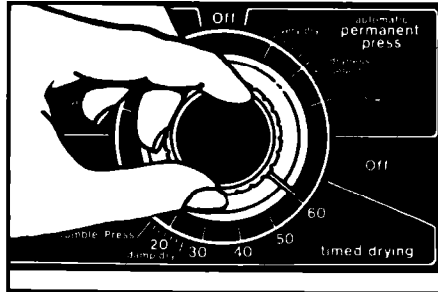

Turn the Control Knob either way to point at the cycle setting you want. See page 6 for information on the cycles.

Set TEMPERATURE 2. SELECTOR

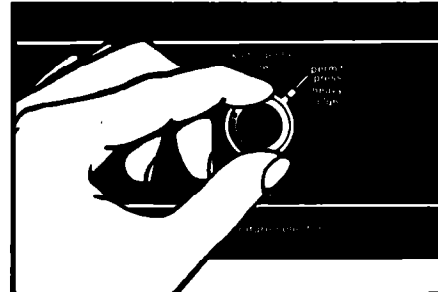

Turn the Temperature Selector to the needed drying temperature.

Push the 3. START Button

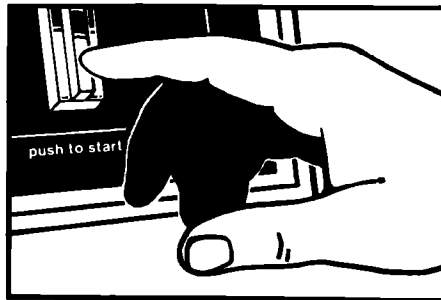

The dryer will start tumbling when you push the START Button.

To stop and restart the dryer

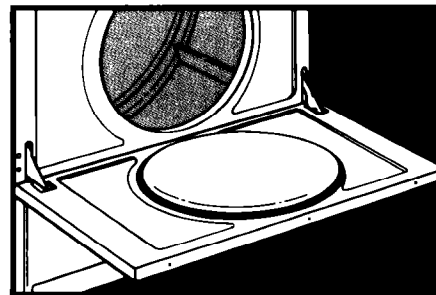

To stop the dryer, open the door (or turn the Control Knob to OFF).
To restart the dryer, close the door, select cycle, if necessary, and push START.

Changing a setting

The setting can be changed at any time by turning the Control Knob to a new setting.

The Cycle Control Knob should point to OFF when the dryer is not in use.

Operating instructions

The automatic cycles

The automatic cycles allow you to select the degree of dryness you prefer for the clothes being dried.

The Control Knob moves and stops several times until the load reaches the dryness setting you selected. Then the knob automatically moves to OFF and tumbling stops.

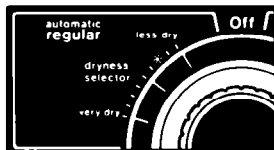

Use **AUTOMATIC REGULAR** to dry heavy and medium-

weight cotton items. **The load tumbles without heat during the last 5 minutes.** This helps make the load easier to handle.

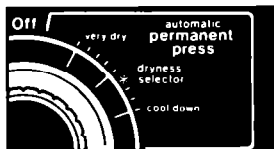

Use **AUTOMATIC PERMANENT PRESS** to dry permanent

press, knits and other synthetic fabrics. **The load tumbles without heat during the last 10 minutes.** This helps keep wrinkles from setting in.

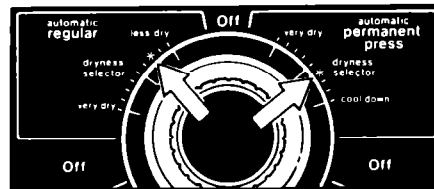

For the first few loads, set the Control Knob to point to an * in either automatic cycle. When the dryer stops, feel the dried items.

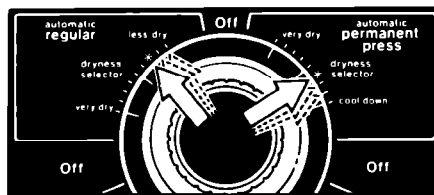

- If items are drier than you like, use a setting to the right of the * the next time you dry a similar load.

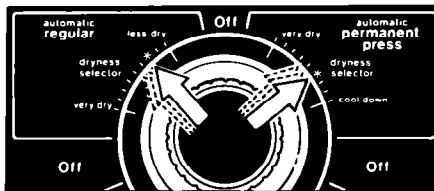

- If items are not as dry as you like, use a setting to the left of the * the next time you dry a similar load.

OVERDRYING CAN CAUSE SHRINKAGE, STATIC CLING AND DAMAGE TO SOME FABRICS.

Timed drying

Use the **TIMED DRY** Cycle for any load you want to dry by time. For example: small loads, large bulky items, items to be fluffed or dusted with the **FLUFF AIR** heat setting.

- Turn the Control Knob to the number of minutes you want – from 10 to 60.
- The last 5 minutes of this cycle are without heat – a cool down time. This helps make the load easier to handle.

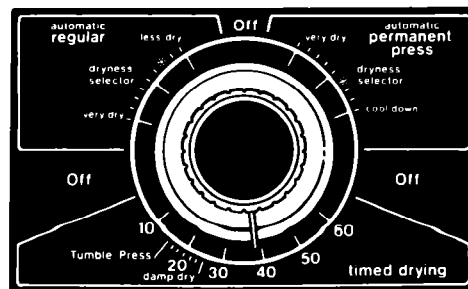

Drying tips

FLUFF AIR

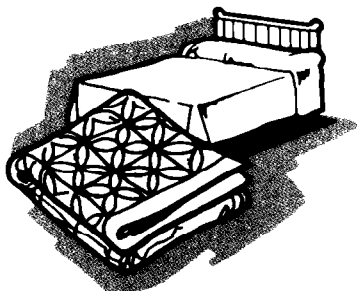

The dryer does not heat when the Temperature Selector is set on FLUFF AIR. This setting can be used to fluff bedding, pillows and clothing or to dust drapes.

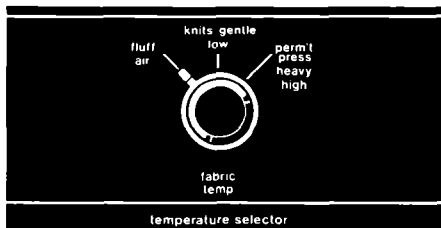

1. Set Temperature Selector on FLUFF AIR.
2. Turn Control Knob to the number of minutes you want in the TIMED DRYING Cycle.
3. Push START Button.



Mixed loads

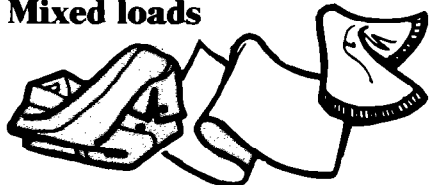

When drying a load with different kinds and weights of fabrics, use the cycle suggested for the lightest fabrics. When the dryer stops, remove drying items and reset the control.

TUMBLE PRESS® Setting

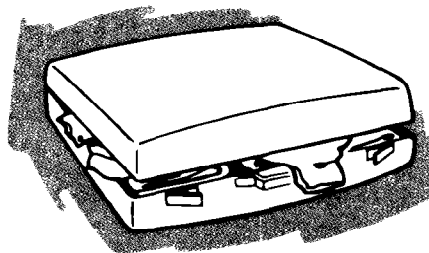

The TUMBLE PRESS setting removes wrinkles from dry clothing such as items that may have been packed in a suitcase, closet, or items not removed from the dryer.

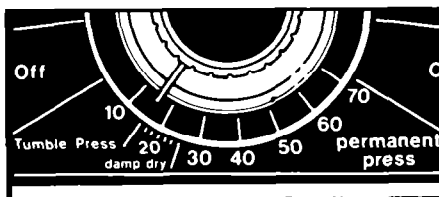

1. Set Temperature Selector on PERM'T PRESS/HEAVY HIGH.
2. Set Control Knob on TUMBLE PRESS.
3. Push START Button.

The load will tumble in heated air for 5 minutes. The heat shuts off and the dryer continues to tumble the load for 10 more minutes.

For best results, TUMBLE PRESS only a few items at a time. Put them on hangers or fold them as soon as the dryer stops.

Drying times

Drying times will vary depending on:

- amount of moisture in the clothes.
- type and weight of the fabric.
- size of the load.
- room temperature around the dryer.
- temperature of the wash rinse water.
- amount of lint in the lint screen.
- dryer temperature selection.

See page 6 in your "Dryer Guide" for more information.

End-of-cycle signal

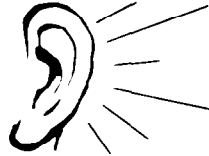

The dryer sounds a signal to let you know when the cycle is finished. The signal cannot be turned off and is not adjustable.

The signal is helpful when you are drying permanent press, synthetics and other items that should be taken out as soon as the dryer stops.

Using the drying rack

The drying rack lets you dry items that you may not want to tumble; for example, sneakers, stuffed toys, knitted wool, etc.

The rack does not move, but the drum turns. **Make sure nothing hangs over the edges of the rack.**

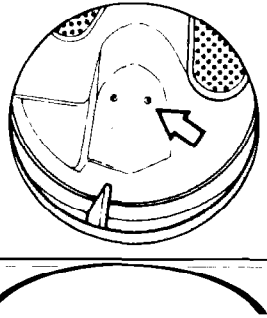

1. Rear legs on the rack fit into indents in the back wall of the dryer.

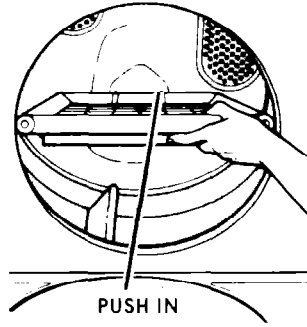

2. Fit rear legs into indents. Push in against the springs in the legs.

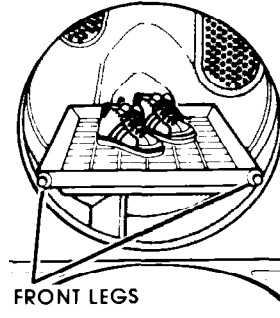

3. Lower the front so legs rest on dryer opening.

4. Put wet items on top of the rack. Leave space between them so air can reach all surfaces.

5. Close the door; set time and temperature; push the START Button.

Use a setting in the TIMED DRY Cycle. Drying time will depend on how much moisture the items hold. The following chart suggests temperature settings for different kinds of items that might best be rack dried.

To rack dry...	Use Temperature setting...
Wool sweaters (Block to shape and lay flat on the rack)	KNITS GENTLE / LOW
Stuffed toys or pillows (Cotton or polyester fiber filled)	PERM'T PRESS / HEAVY HIGH
Stuffed toys or pillows* (Foam rubber filled)	FLUFF AIR
Sneakers or canvas shoes*	FLUFF AIR

 ***WARNING: Drying with heat may damage the foam rubber and will be a FIRE HAZARD.**

Be sure to take the rack out for normal tumble drying.

Lint screen

Clean the lint screen before each load. A screen blocked by lint can increase drying time and may be a FIRE HAZARD.

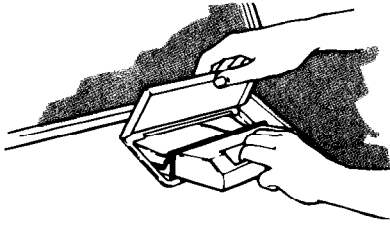

Open the lid and pull the lint screen straight out.



DO NOT run the dryer with the lint screen loose, damaged or missing. Doing so can cause overheating, can damage fabrics and can be a **FIRE HAZARD**.

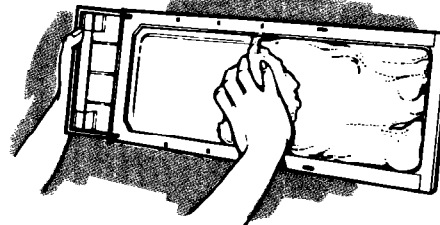

ROLL the lint off the screen with your fingers. **DO NOT** rinse or wash the screen.

Push the screen firmly back into place.

Lint removal

Lint can gather inside the dryer and create a fire hazard. **This lint should be removed every 2 to 3 years, or more often, depending on dryer usage.**

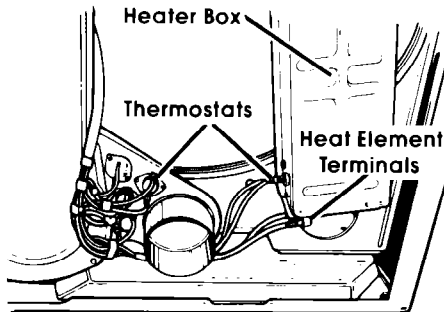

ELECTRIC DRYERS

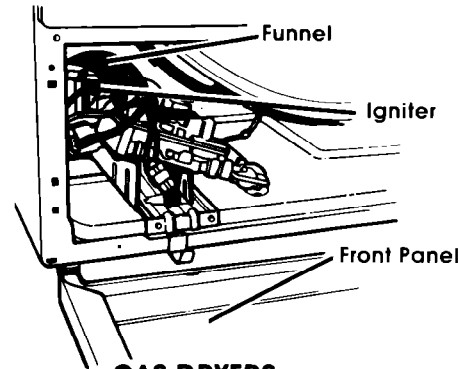

GAS DRYERS

Cleaning should be done only by a qualified person.



- Avoid electrical shock hazard – unplug power supply cord or turn off electrical power.
- Avoid injury or damage – do not put hands inside cabinet.
- Make sure dryer is cool.

1. Remove back panel (electric) or front panel (gas).
2. Avoid damaging wires, thermostats, funnel or igniter.
3. Remove lint from shaded area – see art – with a soft brush or vacuum cleaner.
4. Replace panel; reconnect and re-level dryer.

Caring for your dryer

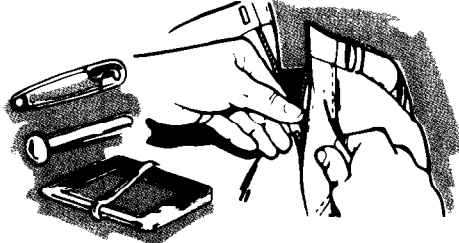

Remove sharp objects from clothing before drying – pins, buckles, etc. **Close metal zippers.**



Never leave wet or damp laundry in your dryer.



Wipe off all spills with a damp, soft cloth. Spills allowed to remain may dull or damage the finish.

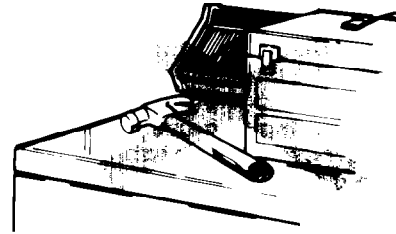

Sharp or heavy objects should never be put on or in the dryer. Check pockets for bolts, nuts, etc.

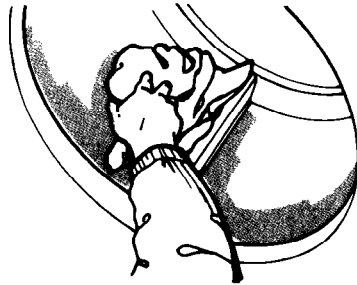

Non-colorfast items can stain the drum. Wipe **carefully** after drying to make sure there is no dye to be transferred to items in the next load.

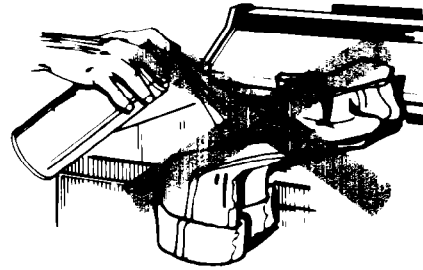

Some pretreatment products can damage dials, console and finish. Do not use these products on or near your dryer.

Vacation care

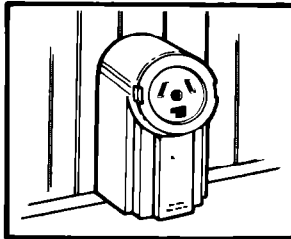

Disconnect power supply cord.

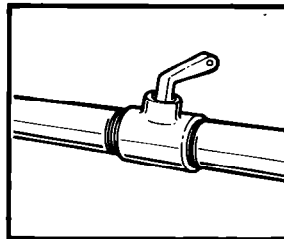

For gas dryers, close gas valve.

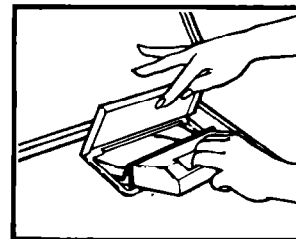

Clean lint screen.

If you need service or assistance, we suggest you follow these four steps:

1. Before calling for assistance... 3. If you need service*...

Performance problems often result from little things you can find and fix yourself without tools of any kind.

DRYER DOES NOT RUN:

- Is power supply cord plugged in?
- Is door closed tightly?
- Did you push START Button?
- Are fuses blown or a circuit-breaker tripped?

DRYER DOES NOT HEAT:

- The AIR setting is without heat.
- The last minutes of heat settings are without heat.
- Is gas turned on? If not, turn Control Knob to OFF. Turn on gas. Wait 5 minutes. Reset controls and start.
- An electric dryer uses a circuit breaker or 2 fuses. If one fuse is blown, the dryer may run, but not heat.

DRYING TIME SEEMS LONG:

- Is the lint screen clean?
- See page 6 in your "Dryer Guide."

2. If you need assistance*...

Call Whirlpool COOL-LINE® service assistance telephone number. Dial free from:

Continental U.S. . . (800) 253-1301
Michigan (800) 632-2243
Alaska & Hawaii (800) 253-1121

and talk with one of our trained Consultants. The Consultant can instruct you in how to obtain satisfactory operation from your appliance or, if service is necessary, recommend a qualified service company in your area.



FSP is a registered trademark of Whirlpool Corporation for quality parts. Look for this symbol of quality whenever you need a replacement part for your Whirlpool appliance. FSP replacement parts

will fit right and work right, because they are made to the same exacting specifications used to build every new Whirlpool appliance.



Whirlpool has a nationwide network of franchised TECH-CARE® Service Companies. TECH-CARE service technicians are trained to fulfill the product warranty and provide after-warranty service, anywhere in the United States. To locate TECH-CARE service in your area, call our COOL-LINE service* assistance telephone number (see Step 2) or look in your telephone directory Yellow Pages under:

APPLIANCES - HOUSEHOLD - MAJOR - SERVICE & REPAIR	OR	ELECTRICAL APPLIANCES - MAJOR - REPAIRING & PARTS
WHIRLPOOL APPLIANCES FRANCHISED TECH-CARE SERVICE		WHIRLPOOL APPLIANCES FRANCHISED TECH-CARE SERVICE
SERVICE COMPANIES		SERVICE COMPANIES
XYZ SERVICE CO 123 Maple 999-9999		XYZ SERVICE CO 123 Maple 999-9999
OR		
WASHING MACHINES, DRYERS & IRONERS - SERVICING		
WHIRLPOOL APPLIANCES FRANCHISED TECH-CARE SERVICE		
SERVICE COMPANIES		
XYZ SERVICE CO 123 Maple 999-9999		

4. If you have a problem*...

Call our COOL-LINE service assistance telephone number (see Step 2) and talk with one of our Consultants, or if you prefer, write to:

Mr. Guy Turner, Vice President
Whirlpool Corporation
Administrative Center
2000 US-33 North
Benton Harbor, MI 49022

*If you must call or write, please provide: model number, serial number, date of purchase, and a complete description of the problem. This information is needed in order to better respond to your request for assistance.



Making your world a little easier.

Part No. 691275 Rev. A
©1984 Whirlpool Corporation

Printed in U.S.A.

omatic Washers, Clothes Dryers, Freezers, Refrigerator-Freezers, Ice Makers, Dishwashers, Built-In Ovens and Surface Units, Ranges, M

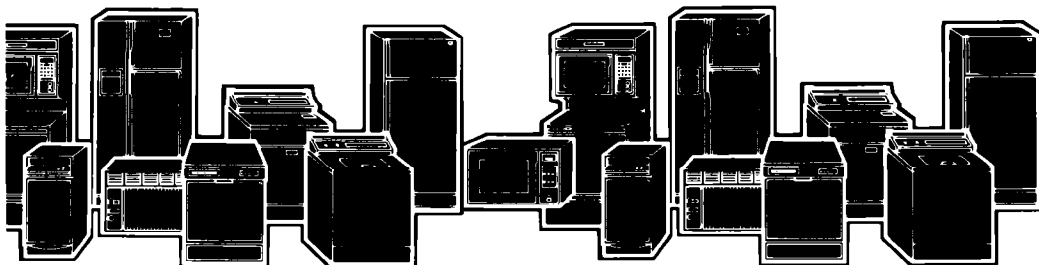

Free Manuals Download Website

<http://myh66.com>

<http://usermanuals.us>

<http://www.somanuals.com>

<http://www.4manuals.cc>

<http://www.manual-lib.com>

<http://www.404manual.com>

<http://www.luxmanual.com>

<http://aubethermostatmanual.com>

Golf course search by state

<http://golfingnear.com>

Email search by domain

<http://emailbydomain.com>

Auto manuals search

<http://auto.somanuals.com>

TV manuals search

<http://tv.somanuals.com>