

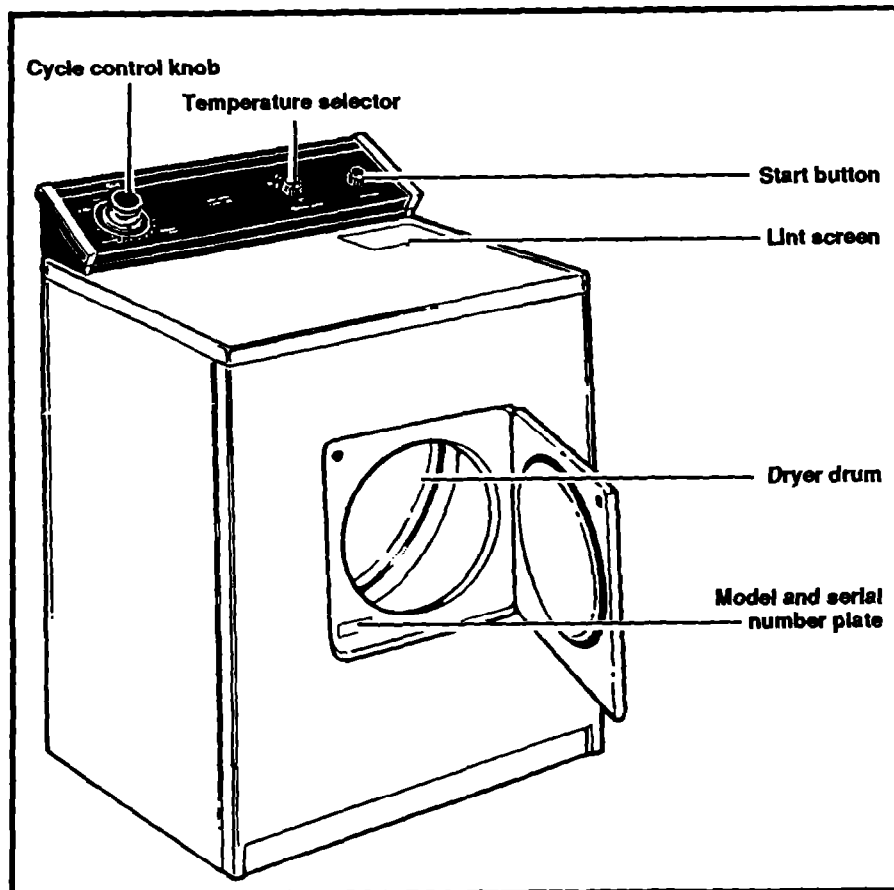

Use & Care Guide



LARGE CAPACITY AUTOMATIC DRYERS
LE5320XT LE5530XS LE5600XS LE5650XM LE5700XS
LE5705XP LE6055XS LG5321XT LG5531XS LG5601XS
LG5651XM LG5701XS LG5706XP LG6056XS

Contents

	Page
Important Safety Instructions	
Additional safety instructions and your responsibilities	3
Operating Instructions	
Starting your dryer	4
The regular cycles	6
The permanent press cycle	7
Using fluff air	7
Using TUMBLE PRESS®	8
Using damp dry	9
Lint signal	9
Caring For Your Dryer	
Cleaning the lint screen	10
Lint screen maintenance	10
Cleaning the dryer	11
Lint removal	12
If You Need Service Or Assistance	14
Whirlpool Automatic Dryer Warranty	16

©1992 Whirlpool Corporation

The drawings in this book may vary slightly from your dryer model. They are designed to show the different features of all models covered by this book.

NOTE: Your model may not include all the features shown.

If your dryer has a Consumer Buy Guide label, remove it. It will be easier to remove before the dryer is used. To remove any remaining glue:

- Rub briskly with thumb to make a ball, then remove.
or
- Soak area with liquid hand dishwashing detergent before removing glue as described above.

Do not use sharp instruments, rubbing alcohol, flammable fluids or abrasive cleaners. These can damage the finish. See "Important Safety Instructions" on page 3.

NOTE: Do not remove any permanent instruction labels inside the dryer.

You should wipe out the dryer drum with a damp cloth before using to remove dust from storing or shipping.

Thank you for buying a Whirlpool appliance. Please complete and mail the Owner Registration Card provided with this product. Then complete the form below. Have this information ready if you need service or call with a question.

- Copy model and serial numbers from plate (on the frame behind the door) and purchase date from sales slip.
- Keep this book, the Dryer Guide and the sales slip together in a handy place.

Model Number

Serial Number

Purchase Date

Service Company Phone Number

FOR YOUR SAFETY

If you smell gas:

1. Open windows.
2. Don't touch electrical switches.
3. Extinguish any open flame.
4. Immediately call your gas supplier.

FOR YOUR SAFETY

Do not store or use gasoline or other flammable vapors and liquids in the vicinity of this or any other appliance. The fumes can create a fire hazard or explosion.

Important Safety Instructions

⚠ WARNING

To reduce the risk of fire, electrical shock, or injury to persons when using your dryer, follow basic precautions, including the following:

- **Read all instructions before using the dryer.**
- **NEVER** dry items cleaned, washed, soaked in or spotted with wax, paint, gasoline or flammable fluids in the dryer. The fumes can create a **FIRE HAZARD** or **EXPLOSION**. **ALWAYS** hand launder and air dry fabrics containing these materials.
- **NEVER** allow children to operate, play with or crawl inside the dryer. Close supervision of children is necessary when the dryer is used near children.
- **DO NOT** reach into a dryer if the drum is moving.
- When discarding an old dryer, **ALWAYS** remove the door to prevent accidental entrapment.
- **DO NOT** install or store dryer where it will be exposed to the weather.
- **DO NOT** tamper with the controls.
- **You are responsible for making sure that your dryer is installed, repaired and has parts replaced by a qualified person.**
- Use only fabric softeners specifically labeled as not being harmful to the dryer.
- **FIRE HAZARD** and **DAMAGE** to materials can result from:
 - drying rubber, rubber-like and heat sensitive materials with heat.
 - allowing lint build-up inside the dryer or exhaust system. Cleaning should be done periodically by a qualified person.
- Clean lint screen before or after each load.
- **DO NOT** let dust, lint, paper, rags, chemicals, etc. pile up around or under the dryer.
- Dryer must be electrically grounded. See the Installation Instructions.

– SAVE THESE INSTRUCTIONS –

Additional safety instructions and your responsibilities

- **NEVER** operate the dryer if:
 - it is not working right (i.e. noisy, too hot).
 - it is damaged.
 - parts are missing (i.e. door latch).
 - all panels are not in place.
 - the lint screen is loose, damaged or missing.
- **ALWAYS** shut off the gas valve before leaving on vacation if you have a gas dryer.
- **ALWAYS** unplug the power supply cord or turn off electrical power before attempting to service the dryer. Shut off GAS VALVE if you have a gas dryer.
- **You are responsible for making sure that your dryer:**
 - is properly maintained.
 - is properly installed and leveled on a floor that can support the weight in a well ventilated room.*
 - is located in an area where the temperature is above 45°F (7°C).
 - is connected to the proper outlet and electrical supply.*
 - is properly connected to fuel and exhaust systems.*
 - is not installed against drapes or curtains.*
 - is used only for jobs normally expected of home clothes dryers.
 - is not used by anyone unable to operate it properly.

*See the Installation Instructions for complete information.

Operating Instructions

Starting your dryer

Be sure to refer to the chart below and the Dryer Guide for proper sorting, loading and control setting information before starting your dryer.

NOTE: Do not overdry. Overdrying can cause shrinkage, static cling, and damage some fabrics.

TYPE OF LOAD	SUGGESTED CYCLE	SUGGESTED TEMPERATURE
Cottons and linens		
EXTRA HEAVY—Bedspreads, mattress pads, quilts	EXTRA HEAVY	PERMT PRESS HEAVY HIGH
HEAVYWEIGHT—Towels, jeans, corduroys, work clothes	HEAVY	
MEDIUMWEIGHT—Sheets, pillowcases, cotton underwear, diapers	MEDIUM	
LIGHTWEIGHT—Batistes, organdies, lingerie	LIGHT	
Permanent press, synthetics and blends		
	PERMANENT PRESS	
HEAVYWEIGHT—Work clothes, jackets, raincoats	40-50 min	PERMT PRESS HEAVY HIGH
MEDIUMWEIGHT—Shirts, play clothes, sheets, slacks	30-40 min	
LIGHTWEIGHT—Lingerie, blouses, dresses	20-30 min	
Knits		
	PERMANENT PRESS	
HEAVYWEIGHT—Cottons, rayons, blends, T-shirts, slacks, shirts	40-50 min	PERMT PRESS HEAVY HIGH
MEDIUMWEIGHT—Synthetics (polyester, acrylic, etc.), dress slacks, skirts, sweaters	30-40 min	
LIGHTWEIGHT—Synthetics (polyester, acrylic, etc.) and blends, lingerie, blouses, dresses	20-30 min	KNITS GENTLE LOW
Delicate fabrics		
	PERMANENT PRESS	
Sheer curtains (2 or 3 panels) gauze, lace, etc.	15-20 min	KNITS GENTLE LOW
Fire Hazard		
⚠ WARNING		
Drying rubber, plastic and other heat-sensitive materials with heat can damage them or be a FIRE HAZARD.		
Rubber, plastic, heat-sensitive fabrics		
	PERMANENT PRESS	
FOAM RUBBER—Pillows, bras, stuffed toys	20-30 min	FLUFF AIR*
PLASTIC—Shower curtains, tablecloths	20-30 min	
RUBBER-BACKED RUGS	40-50 min	
OLEFIN, POLYPROPYLENE, SHEER NYLON	15-20 min	

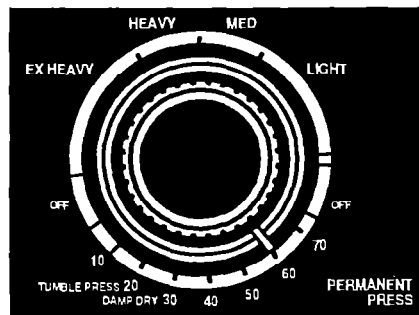

1. **Select a cycle** by turning the Cycle Control Knob either way. Stop when the indicator on the knob's outer ring points to the cycle and time you want. See pages 6-9 for further cycle information.

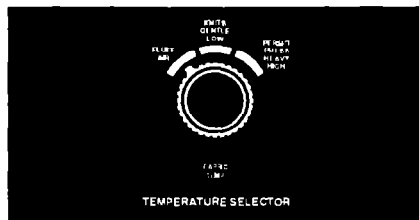

2. **Set the Temperature Selector** on the desired temperature setting.

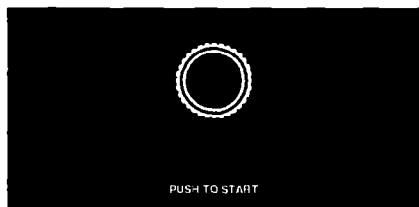

3. **Push the Start Button** to start the dryer.

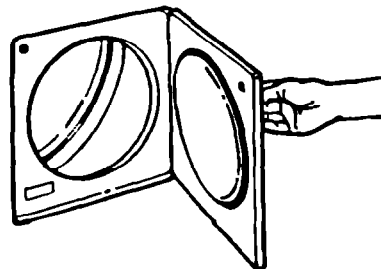

4. **To stop and restart the dryer:**

- Open the door or turn the Cycle Control Knob to OFF to stop the dryer.
- Close the door, select a cycle (if necessary) and push the Start Button to restart the dryer.

The Cycle Control Knob should point to an OFF area when the dryer is not in use. If the dryer is stopped before the cycle is finished, turn the Cycle Control Knob to an OFF area.

Operating Instructions Continued

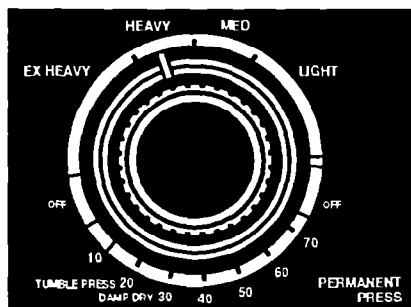

The regular cycles

The names of the regular cycles describe the types of loads they are designed to dry. Each cycle is followed by a 5 minute cool-down period. During the cool down, the load tumbles without heat. This helps make the load easier to handle.

Use **EX HEAVY** to dry items such as bedspreads, mattress pads and quilts.

Use **HEAVY** to dry items such as towels, jeans, corduroys and work clothes.

Use **MED** to dry items such as sheets, pillowcases, cotton underwear and diapers.

Use **LIGHT** to dry batistes, organdies and lingerie.

For the first few loads, set the Cycle Control Knob to point to one of the lines between any of the cycles. When the dryer stops, feel the dried items.

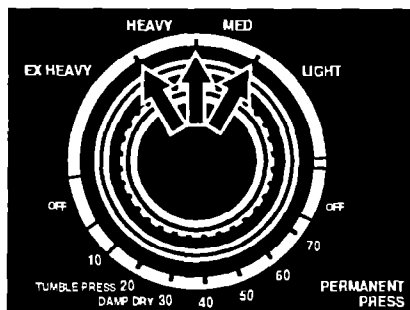

More drying time Less drying time

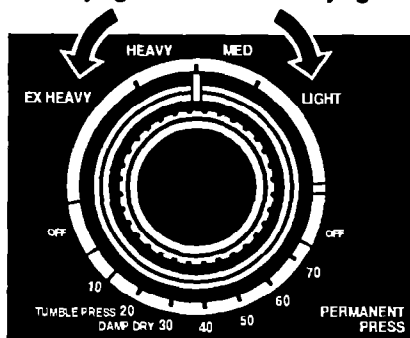

- If the items are drier than you like, set the Cycle Control Knob more to the **right** the next time you dry a similar load.
- If items are not as dry as you like, set the Cycle Control Knob more to the **left** the next time you dry a similar load.

NOTE: Overdrying can cause shrinkage, static cling and damage to some fabrics.

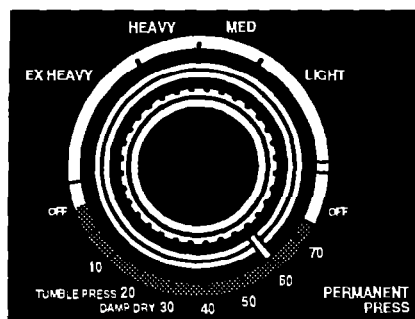

The PERMANENT PRESS cycle

The PERMANENT PRESS cycle helps provide the special care that permanent press and synthetic fabrics need. The cycle consists of a timed period of heated drying and a 10 minute cool-down period. During the cool down, the load tumbles without heat. This helps keep wrinkles from setting and makes the load easier to handle.

NOTE: To help reduce wrinkling, remove the load from the dryer as soon as tumbling stops. This is important for permanent press, knits and synthetic fabrics.

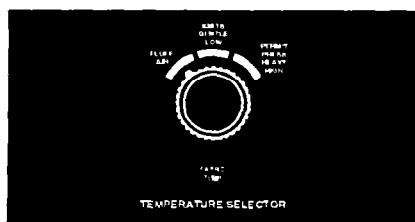

Using FLUFF AIR

⚠ WARNING

Fire Hazard

Do not dry plastic or rubber items with heat. Use FLUFF AIR setting, or line dry. Failure to do so could result in fire or damaged items.

The dryer does not heat when the Temperature Selector is set on FLUFF AIR. This setting can be used to fluff or air dry bedding, plastic tablecloths, foam rubber pillows, stuffed toys, sneakers, etc.

1. Turn the Temperature Selector to FLUFF AIR.
2. Turn the Cycle Control Knob to the desired number of minutes you want in the PERMANENT PRESS cycle.
3. Push the Start Button.

NOTE: Repeat steps above if more time is needed to dry items.

Using TUMBLE PRESS®

The TUMBLE PRESS setting removes wrinkles from clothing that has been packed in a suitcase or closet, and from items not removed from the dryer at the end of a cycle.

1. Set the Cycle Control Knob on TUMBLE PRESS.
2. Set the Temperature Selector on PERM'T PRESS HEAVY HIGH.
3. Push the Start Button.

For best results, put only a few items at a time in this cycle. As soon as the dryer stops, put the items on hangers or fold them.

For all models (except LE5650XM, LG5651XM, LE5705XP, LG5706XP):

The load will tumble in heated air for 10 minutes. Then the dryer will tumble the clothes for 10 minutes without heat.

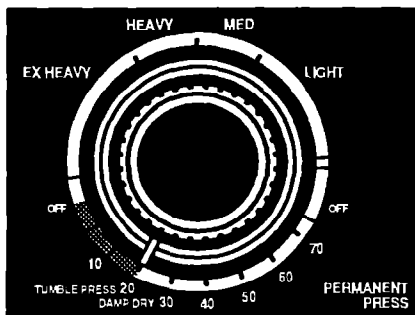

All models (except LE5650XM, LG5651XM, LE5705XP, LG5706XP)

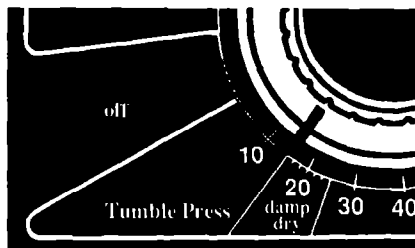

Models LE5650XM, LG5651XM, LE5705XP, LG5706XP

For models LE5650XM, LG5651XM, LE5705XP, LG5706XP:

The load will tumble in heated air for 5 minutes. Then the dryer will tumble the clothes for 10 minutes without heat.

Using DAMP DRY

Use this setting to dry damp items that do not require an entire drying cycle, or to dry items to damp level. (Two examples are heavy cottons, such as jeans, which you do not want to become stiff, or cotton clothes which are easier to press when damp.)

1. Set the Cycle Control Knob on DAMP DRY.
2. Push the Start Button.

For all models (except LE5650XM, LG5651XM, LE5705XP, LG5706XP):

The load will tumble in heated air for 20 minutes. Then the dryer will tumble the clothes for 10 minutes without heat.

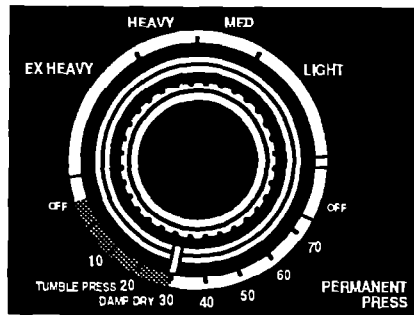

All models (except LE5650XM, LG5651XM, LE5705XP, LG5706XP)

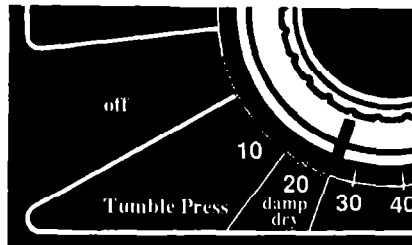

Models LE5650XM, LG5651XM, LE5705XP, LG5706XP

For models LE5650XM, LG5651XM, LE5705XP, LG5706XP:

The load will tumble in heated air for 15 minutes. Then the dryer will tumble the clothes for 10 minutes without heat.



Lint signal

For models LE5705XP and LG5706XP:

Clean the lint screen before each load. A signal will sound if you neglect to clean your lint screen. The signal (a whistle tone) lets you know the airflow is restricted. Restricted airflow reduces drying efficiency.

Turn off the dryer and clean the lint screen as shown on page 10.

Caring For Your Dryer

CAUTION

Product and Fabric Damage Hazard

Do not run the dryer with the lint screen loose, damaged, blocked or missing. Doing so can cause overheating and damage to both the dryer and fabrics.

Cleaning the lint screen

The lint screen is located under a lid on top of the dryer. **Clean it before each load.** A screen blocked by lint can increase drying time.

1. Open the lid and pull the lint screen straight out.
2. Roll lint off the screen with your fingers. Do not rinse or wash the screen to remove lint. Wet lint is hard to remove.
3. Push the lint screen firmly back into place and close the lid.

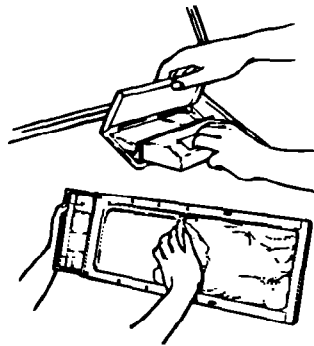

Lint screen maintenance

Laundry detergents and fabric softeners can cause a residue build-up on the lint screen. A clogged lint screen can extend drying times. Clean the lint screen every six months or more frequently if it becomes clogged due to a residue build-up. Use the following method:

1. Wet both sides of lint screen with hot water.
2. Wet a nylon brush with hot water and liquid detergent.
3. Scrub lint screen with the brush until all residue build-up is removed.
4. Rinse with hot water.
5. **Thoroughly** dry lint screen with a clean towel and replace in dryer.

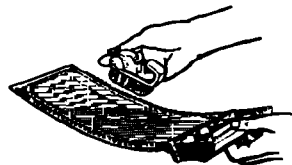

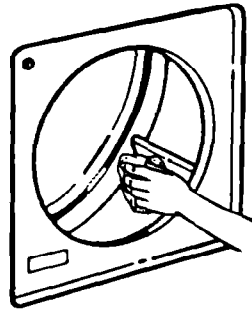

Cleaning the dryer

⚠ WARNING

Electrical Shock and Personal Injury Hazard

- Turn off the electrical power before cleaning the interior.
 - Make sure the dryer is cool.
- Failure to do so could result in electrical shock or injury.

Fire Hazard

- Use non-flammable cleaner.
- Failure to do so could result in an explosion.

Garments which contain unstable dyes, such as denim blue jeans or brightly colored cotton items, may discolor the dryer interior.

If you want to remove stains from dryer drum use one of the following methods:

Powdered laundry detergent

1. Make a paste with detergent and very warm water.
2. Apply paste to a soft cloth and scrub area until all excess dye is removed.
3. Wipe thoroughly with a damp cloth.
4. Tumble a load of rags to dry.

Liquid non-flammable household cleaner

1. Apply to stained area.
2. Rub with a cloth until all excess dye is removed.
3. Wipe thoroughly with a damp cloth.
4. Tumble a load of rags to dry.

To clean dryer exterior:

Wipe with a soft, damp cloth.

Lint removal

Lint can gather inside the dryer and be a fuel for fire. It is recommended the lint be removed every 2 to 3 years, or more often, depending on dryer usage. Cleaning should be done by a qualified person. If you have any questions, please call our Consumer Assistance Center at 1-800-253-1301.

⚠ WARNING

Electrical Shock and Personal Injury Hazard

- Unplug the power supply cord or turn off the electrical power before removing dryer panels.
- Make sure the dryer is cool.
- Dryer parts can have sharp edges. Use care when handling.
- When replacing front panel after lint removal, the wire clips holding the door switch wires must be anchored to top of front and side panels. Wires **MUST NOT** touch rotating drum. (See page 12, step 7.) Failure to do so could result in electrical shock or personal injury.

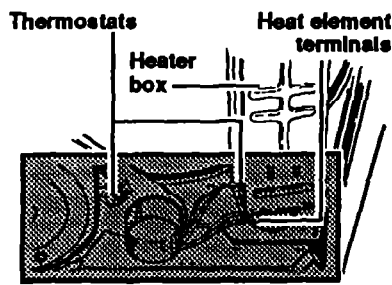

Electric dryer with back panel removed

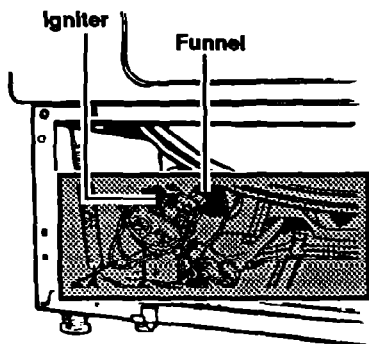

Gas dryer with lower front access panel removed

If your dryer is electric, or is gas and has a lower front access panel:

1. Unplug the power supply cord or turn off the electrical power.
2. Remove back panel (electric) or lower front access panel (gas). See Installation Instructions.
3. Remove lint from shaded area in illustration with a soft brush or vacuum cleaner. Avoid damaging wires, thermostats (electric), funnel (gas) or igniter (gas).
4. Replace panel; reconnect and level dryer again, if necessary.

NOTE: See page 13 if your dryer is gas and has a full front panel.

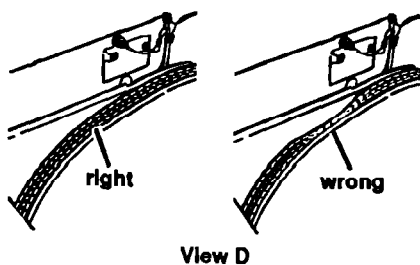
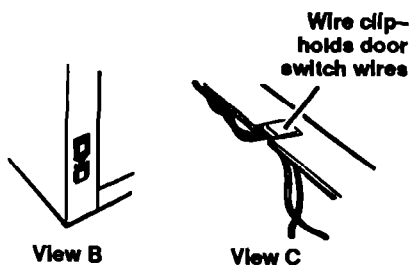
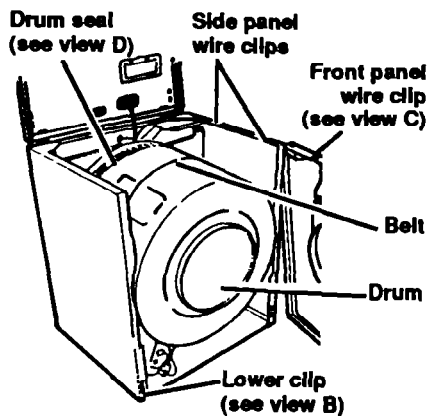
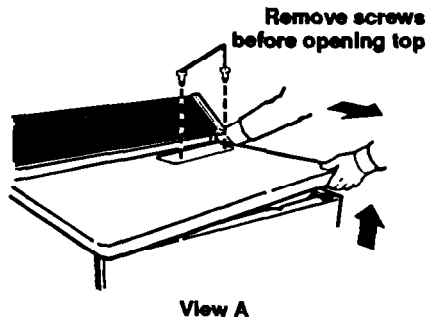

If your dryer is gas and has a full front panel, remove front panel as follows:

1. Unplug the power supply cord or turn off the electrical power.
2. Open lint screen lid. Remove two screws in lint screen area.
3. Open top by pulling forward and up at each front corner (see view A). Rest raised top against wall behind dryer (top is hinged at rear).
4. Remove two internal screws from front panel flanges (near top front corners). Lift front panel slightly, lifting off lower clips (see view B). Slowly pull front panel forward, disengaging panel from drum. (Drum will drop slightly.)
5. Move front panel aside and rest edge against side of dryer. Avoid disconnecting wire clips (see view C) or damaging wires.
6. Remove lint from area shown in "gas dryer" illustration on page 12 with soft brush or vacuum cleaner. Avoid damaging wires, funnel or igniter.
7. Reassemble in reverse order. Before closing the top, check the following:
 - Drum seal must be flared out (see view D) and properly positioned against panel at back of drum. Rotate drum counterclockwise one full turn to check drum seal.
 - Belt should be centered and tight on dryer drum.
 - Wire clips which hold the door switch wires must be anchored in slot in top of front panel (see view C) and along top edge of side panel. Door wires must not touch drum when dryer is operating.
8. Replace top panel and lint screen screws. Top and front panels must be securely in place before operating dryer.
9. Reconnect power and level dryer again (if necessary).

NOTE: Call Consumer Assistance at 1-800-253-1301 for assistance or more information.

If You Need Service Or Assistance

We suggest you follow these steps:

1. Before calling for assistance ...

Performance problems often result from little things you can find and fix yourself without tools of any kind.

If your dryer does not run:

- Is the power supply plugged into a live circuit with the proper voltage?
- Is the door closed tightly?
- Did you push the Start Button?
- Have you checked your home's main fuses or circuit breaker box?

If your dryer does not heat:

- The FLUFF AIR setting is without heat.
- The last minutes of heat settings are without heat.
- If you have a gas dryer, is the gas turned on? If not, turn the Cycle Control Knob to OFF. Turn on gas. Wait 5 minutes. Reset controls and start.
- The circuit supplying an electric dryer uses 2 breakers or 2 fuses. If one breaker is tripped or one fuse is blown, the dryer may run, but not heat.

If drying time seems too long:

- Is the lint screen clean? See page 10 for cleaning instructions.
- Is the exhaust duct or outside exhaust hood clogged? Clean if needed.
- See the Dryer Guide.

2. If you need assistance*...

Call Whirlpool Consumer Assistance Center telephone number. Dial free from anywhere in the U.S.:

1-800-253-1301

and talk with one of our trained consultants. The consultant can instruct you in how to obtain satisfactory operation from your appliance or, if service is necessary, recommend a qualified service company in your area.

If you prefer, write to:

Mr. William Clark
Consumer Assistance Representative
Whirlpool Corporation
2000 M-63
Benton Harbor, MI 49022

Please include a daytime phone number in your correspondence.

3. If you need service*...



Whirlpool has a nationwide network of authorized WhirlpoolSM service companies.

Whirlpool service technicians are trained to fulfill the product warranty and provide after-warranty service, anywhere in the United States. To locate the authorized Whirlpool service company in your area, call our Consumer Assistance Center telephone number (see Step 2) or look in your telephone directory Yellow Pages under:

APPLIANCES - HOUSEHOLD - ELECTRICAL APPLIANCES -
MAJOR - SERVICE & REPAIR MAJOR - REPAIRING & PARTS

OR

WASHING MACHINES, DRYERS
& IRONERS - SERVICING

WHIRLPOOL APPLIANCES
AUTHORIZED WHIRLPOOL SERVICE

SERVICE COMPANIES
XYZ SERVICE CO
123 Maple _____ 800-8000

4. If you need FSP® replacement parts*...

FSP is a registered trademark of Whirlpool Corporation for quality parts. Look for this symbol of quality whenever you need a replacement part for your Whirlpool appliance. FSP replacement parts will fit right and work right, because they are made to the same exacting specifications used to build every new Whirlpool appliance.

To locate FSP replacement parts in your area, refer to Step 3 or call the Whirlpool Consumer Assistance Center number in Step 2.

5. If you are not satisfied with how the problem was solved*...

- Contact the Major Appliance Consumer Action Panel (MACAP). MACAP is a group of independent consumer experts that voices consumer views at the highest levels of the major appliance industry.
- Contact MACAP only when the dealer, authorized servicer and Whirlpool have failed to resolve your problem.

Major Appliance Consumer
Action Panel
20 North Wacker Drive
Chicago, IL 60606

- MACAP will in turn inform us of your action.

*When requesting assistance, please provide: model number, serial number, date of purchase, and a complete description of the problem. This information is needed in order to better respond to your request.

WHIRLPOOL®

Automatic Dryer Warranty

DR006

LENGTH OF WARRANTY	WHIRLPOOL WILL PAY FOR
FULL ONE-YEAR WARRANTY From Date of Purchase	FSP® replacement parts and repair labor to correct defects in materials or workmanship. Service must be provided by an authorized Whirlpool SM service company.
WHIRLPOOL WILL NOT PAY FOR	
<p>A. Service calls to:</p> <ol style="list-style-type: none"> 1. Correct the installation of the dryer. 2. Instruct you how to use the dryer. 3. Replace house fuses or correct house wiring or plumbing. 4. Replace light bulbs. <p>B. Repairs when dryer is used in other than normal, single-family household use.</p> <p>C. Pickup and delivery. This product is designed to be repaired in the home.</p> <p>D. Damage to dryer caused by accident, misuse, fire, flood, acts of God or use of products not approved by Whirlpool.</p> <p>E. Repairs to parts or systems caused by unauthorized modifications made to the appliance.</p>	

WHIRLPOOL CORPORATION SHALL NOT BE LIABLE FOR INCIDENTAL OR CONSEQUENTIAL DAMAGES. Some states do not allow the exclusion or limitation of incidental or consequential damages so this limitation or exclusion may not apply to you. This warranty gives you specific legal rights, and you may also have other rights which vary from state to state.

Outside the United States, a different warranty may apply. For details, please contact your authorized Whirlpool distributor or military exchange.

If you need service, first see the "Service and Assistance" section of this book. After checking "Service and Assistance," additional help can be found by calling our Consumer Assistance Center telephone number, **1-800-253-1301**, from anywhere in the U.S.

® Registered Trademark / SM Service Mark of Whirlpool Corporation

Free Manuals Download Website

<http://myh66.com>

<http://usermanuals.us>

<http://www.somanuals.com>

<http://www.4manuals.cc>

<http://www.manual-lib.com>

<http://www.404manual.com>

<http://www.luxmanual.com>

<http://aubethermostatmanual.com>

Golf course search by state

<http://golfingnear.com>

Email search by domain

<http://emailbydomain.com>

Auto manuals search

<http://auto.somanuals.com>

TV manuals search

<http://tv.somanuals.com>