

use & care guide

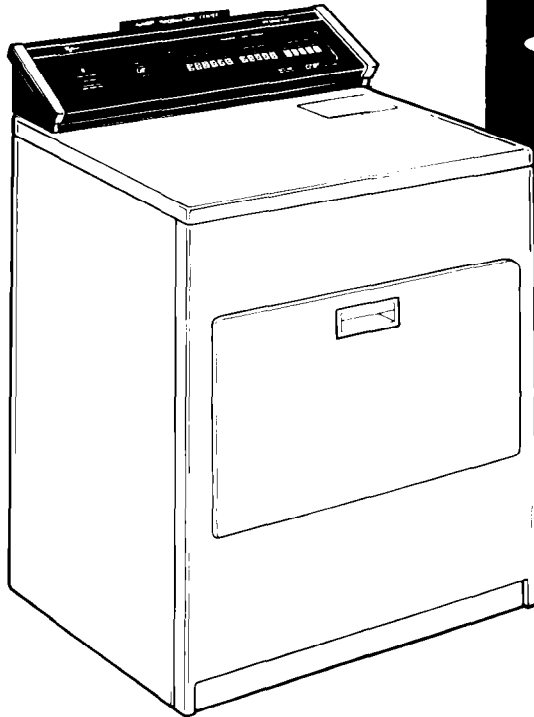

The Whirlpool logo, consisting of a stylized swirl above the word "Whirlpool" in a serif font.

AUTOMATIC DRYERS

**Electric Model
LE9805XP
and
Gas Model
LG9806XP**

**Solid State Series
Electronic Touch Control**

Wave Ovens, Trash Compactors, Room Air Conditioners, Dehumidifiers, Automatic Washers, Clothes Dryers, Freezers, Refrigerator-Freezer

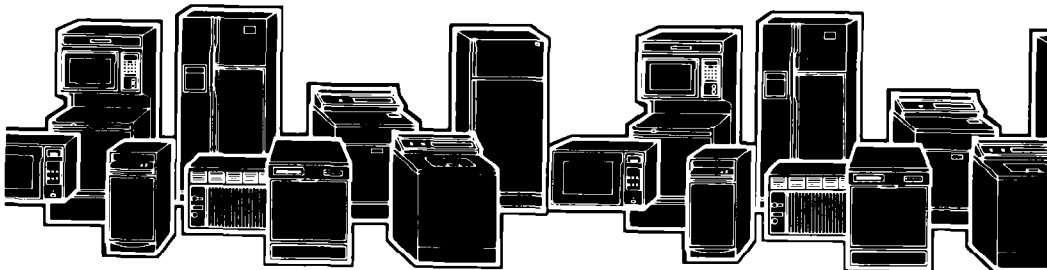

Parts and features

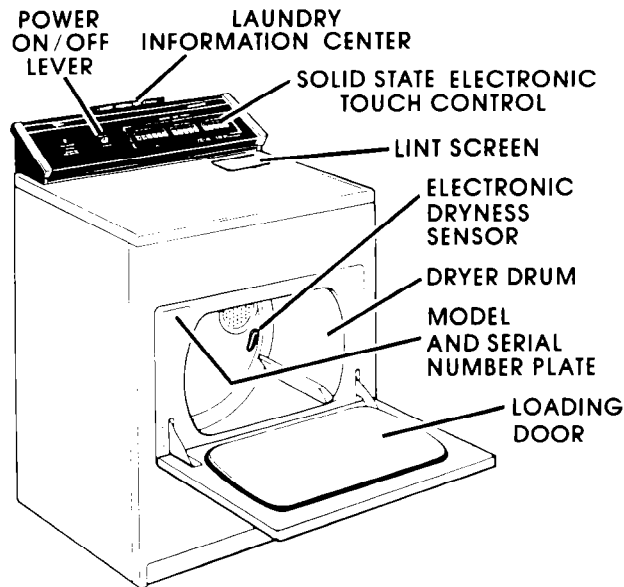

Remove the Consumer Buy Guide label before using your dryer. It will be easier to remove.
Wipe out the dryer drum with a damp cloth to remove dust from storing or shipping.

Copy your Model and Serial Numbers here

When you need service or call with a question, have this information ready.

1. **Complete** Model and Serial Numbers (from the plate located as shown).
2. Purchase date from sales slip.

Copy this information in these spaces. Keep this book, your warranty, sales slip and "Dryer Guide" in the Laundry Information Center on the back of the dryer console.

Complete Model Number

Complete Serial Number

Purchase Date

Service Company and Telephone Number

There is no warranty registration to return. Proof-of-purchase is all that is required for in-warranty service.

Contents

	Page		Page
PARTS AND FEATURES	2	Lint Signal	8
YOUR RESPONSIBILITIES	3	Using the Drying Rack	9
SAFETY FIRST	3	LINT SCREEN	10
STARTING YOUR DRYER AND SELECTING A CYCLE	4	LINT REMOVAL	10
OPERATING INSTRUCTIONS ..	6	CARING FOR YOUR DRYER ...	11
CUSTOM DRY Controls	6	Cleaning Dryer Interior	11
TIMED DRY Controls	6	Vacation Care	11
FINISH GUARD® Control	7	Changing the Drum Light ..	12
DRYING TIPS	7	IF YOU NEED SERVICE OR ASSISTANCE	13
FLUFF AIR Setting	7	1. Before Calling for Assistance	13
TUMBLE PRESS® Setting	7	2. If You Need Assistance ..	13
Drying Times	8	3. If You Need Service	14
Mixed Loads	8	4. If You Have a Problem ...	14
End-of-Cycle Signal	8		

Your Responsibilities

Read this "Use and Care Guide" and your "Dryer Guide" carefully for important use and safety information.

You are personally responsible for making sure that your dryer...

- is installed by a qualified installer.
- is properly maintained.
- is installed in an area protected from the weather.
- is properly installed and leveled in a well ventilated room* on a floor that can support the weight.

- is located in an area where the temperature is above 45°F (7.2°C).
 - is connected to the right kind of outlet, electric supply and grounding.*
 - is properly connected to fuel and exhaust systems.*
 - is used only for jobs normally expected of home clothes dryers.
 - is not run where there may be explosive fumes.
 - is not used by children or anyone unable to operate it properly.
- *See the "Installation Instructions" for complete information.

Safety first

ALWAYS unplug the power supply cord or turn off electrical power before attempting to service the dryer. **Shut off the GAS VALVE** if yours is a gas dryer.

ALWAYS shut off the gas valve before leaving on vacation.

NEVER use flammable fluids (dry-cleaning solvents, gasoline, kerosene) in or near your dryer.

ALWAYS hand launder or air dry fabrics treated with flammable fluids before putting them into your dryer.

NEVER dry items containing wax or paint in the dryer. The fumes can create a **FIRE HAZARD**.

FIRE HAZARD and **DAMAGE** to some materials can result from:

- drying heat-sensitive materials with heat (see page 5).
- operating the dryer with the lint screen loose, damaged or missing.
- allowing lint to build up inside the dryer (see page 10).

NEVER allow children to operate, play with, or crawl inside the dryer.

NEVER operate the dryer if...

- it is not working right.
- it is damaged.
- parts are missing.
- all panels are not in place.

DO NOT let dust, lint, paper, rags, chemicals, etc., pile up around or under the dryer. **DO NOT** install against drapes or curtains.

• FOR YOUR SAFETY •

IF YOU SMELL GAS:

1. OPEN WINDOWS.
2. DON'T TOUCH ELECTRICAL SWITCHES.
3. EXTINGUISH ANY OPEN FLAME.
4. IMMEDIATELY CALL YOUR GAS SUPPLIER.

• FOR YOUR SAFETY •

DO NOT STORE OR USE GASOLINE OR OTHER FLAMMABLE VAPORS AND LIQUIDS IN THE VICINITY OF THIS OR ANY OTHER APPLIANCE.

• SAVE THESE INSTRUCTIONS •

Starting your dryer and selecting a cycle

Before starting your dryer, be sure laundry is sorted and loaded properly (see your "Dryer Guide"). **Be sure the door is tightly closed.**

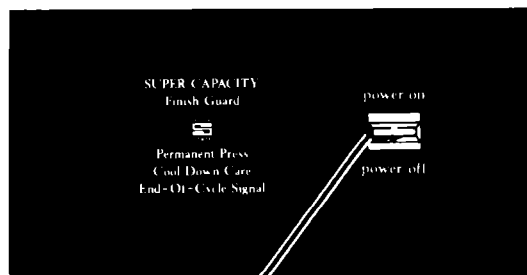

1.

1. Turn power on

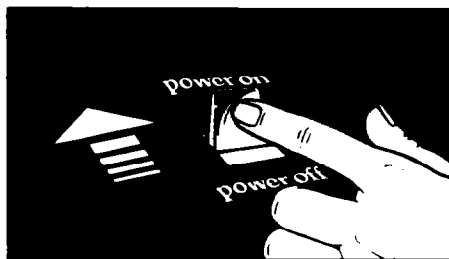

Move the POWER SWITCH **up**. You will have 8 seconds to touch a FABRIC-TEMP Selector.

2. Touch FABRIC-TEMP Selector

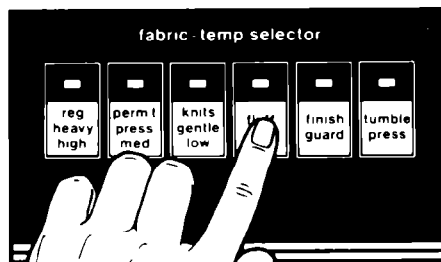

Within 8 seconds, touch the **lower** part of a FABRIC-TEMP Selector. The dryer will not operate if you touch the upper half of the selector.

You may change the dryer setting at any time during any cycle by touching the desired selector or selectors.

3. Touch a CUSTOM DRY or TIMED DRY Control

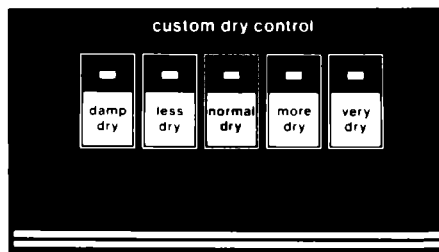

IMPORTANT: If you **do not** touch a CUSTOM DRY or TIMED DRY Control, the dryer will automatically select **NORMAL DRY**.

If this is not the dryness you like, you must touch one of the other dryness Controls. See page 6 of this book for more details.

• To stop the dryer

1. Open the door, or...
2. Move POWER SWITCH to OFF.

• To check the load

1. Open door.
2. The dryer will remember where it was in the cycle **if you restart the dryer within 2 minutes**. Touch selector with the blinking light to restart.

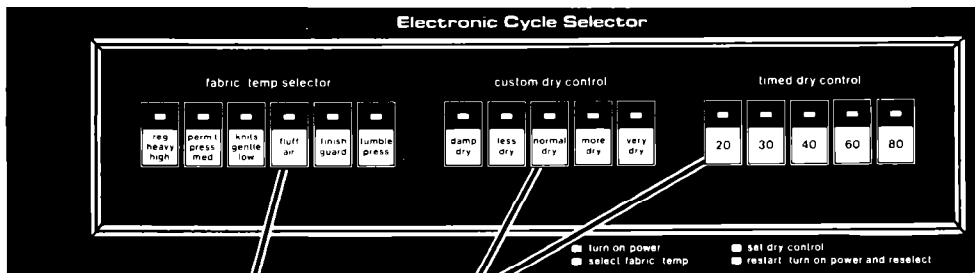

2.

3.

This chart suggests fabric loads and drying temperatures.

TYPE OF LOAD	SUGGESTED FABRIC-TEMP SELECTOR
COTTONS – LINENS	
EXTRA HEAVY – Bedspreads, mattress pads, quilts	
HEAVYWEIGHT FABRICS – Towels, jeans, corduroys, work clothes	REG HEAVY HIGH
MEDIUMWEIGHT COTTONS – Sheets, pillowcases, cotton underwear, diapers	
LIGHTWEIGHT COTTONS – Batistes, organdies, lingerie	
PERMANENT PRESS, SYNTHETICS AND BLENDS	
HEAVYWEIGHT FABRICS – Work clothes, jackets, raincoats	PERM'T PRESS MED
MEDIUMWEIGHT FABRICS – Shirts, play clothes, sheets, slacks	
LIGHTWEIGHT FABRICS – Lingerie, blouses, dresses	
KNITS	
HEAVYWEIGHT – Cottons, rayons, blends, T-shirts, slacks, shirts	KNITS GENTLE LOW
LIGHTWEIGHT – Synthetics (polyester, acrylic, etc.) and blends, lingerie, blouses, dresses	
LIGHTWEIGHT AND DELICATE FABRICS	
Sheer Curtains (2 or 3 panels)	KNITS GENTLE LOW
Gauze, lace, etc.	
RUBBER, PLASTIC, HEAT-SENSITIVE FABRICS	
FOAM RUBBER – Pillows, bras, stuffed toys	FLUFF AIR
PLASTIC – Shower curtains, tablecloths	
RUBBER-BACKED RUGS	
OLEFIN, POLYPROPYLENE, SHEER NYLON	

WARNING: Drying these and other heat-sensitive materials with heat can damage them or be a FIRE HAZARD.

Operating instructions

The CUSTOM DRY Controls



After touching a FABRIC-TEMP Selector, touch a CUSTOM DRY Control selection that describes the dryness you prefer for your load.

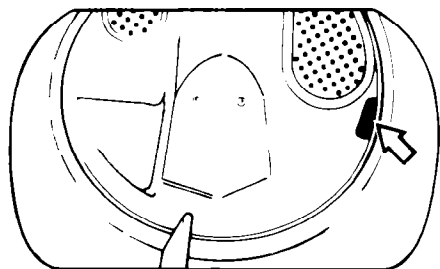

A sensor on the back of the dryer drum "feels" the amount of moisture in the load. When the dryness you have selected is reached, the dryer automatically shuts off.

You may need to try different dryness settings to find the one you like.

SUGGESTIONS

- For the first few loads, use NORMAL DRY. When finished, check to see if the load is as dry as you want.
- If the load is not as dry as you like, use MORE DRY or VERY DRY the next time.
- If the load is too dry, use LESS DRY the next time. Use DAMP DRY if you plan to iron the clothes when you remove them from the dryer.
- Use a TIMED DRY setting for bedspreads, quilts, blankets and other bulky loads. Start with 60 minutes.

IMPORTANT: If a finished load is not as dry as you like:

1. Clear dryer memory by moving the POWER SWITCH to OFF then back to ON.
2. Touch the FABRIC-TEMP Selector for the load type.
3. Touch the 20 minute TIMED DRY Control.
4. Remember to select a different dryness setting for the next similar load.

Cool down times

In all cycles, the heat shuts off before the dryer stops tumbling. This cool down time helps:

- keep wrinkles from setting in.
- make handling the hot load items easier.

TIMED DRY Control

After touching a FABRIC-TEMP Selector, touch a TIMED DRY Control setting for any load you want to dry by time. Touch the number or minutes you want: 20, 30, 40, 60, or 80.

This setting is good for very small loads or large, bulky items.

Note the cool down times in each cycle.

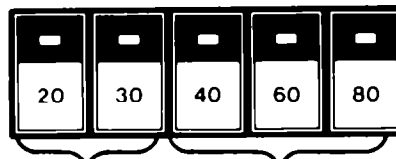

Includes 5 minute
cool down

Includes 10 minute
cool down

Overdrying can cause shrinkage, static cling and damage to some fabrics.

To help reduce wrinkling, take the load from the dryer as soon as tumbling stops. This is very important for permanent press, knits and synthetic fabrics.

FINISH GUARD® Control

FINISH GUARD takes over automatically when the cycle is completed.

It tumbles the load, without heat, every 5 minutes for up to 2½ hours. This rearranges and fluffs the load to help prevent wrinkles that set in when a load remains in a warm dryer.

The indicator light will stay on as long as FINISH GUARD is tumbling the load. Remember that **FINISH GUARD is selected automatically every time you use the dryer.**

To cancel FINISH GUARD:
Touch **FINISH GUARD Control Selector** at any time during the cycle. The light will go out.

Drying tips**FLUFF AIR Setting**

FLUFF AIR gives you 20 minutes of tumbling without heat. FINISH GUARD is automatically selected with this cycle.

If you do not want FINISH GUARD you must cancel it by touching it. The light will go out.

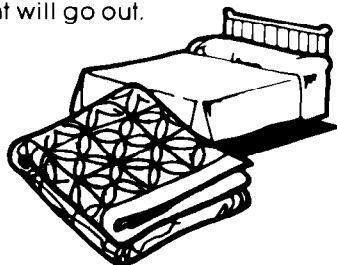

This setting can be used to fluff bedding, pillows and clothing or to dust drapes. It can also be used to damp-dry heat sensitive items... such as plastic shower curtains, rubber-backed rugs, plastic tablecloths, foam rubber pillows, stuffed toys, sneakers, etc.

TUMBLE PRESS® Setting

This setting is useful for removing wrinkles from items packed in suitcases or closets.

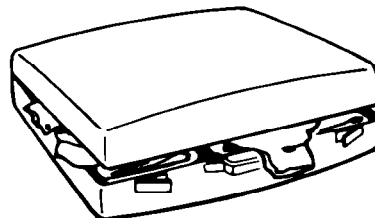

TUMBLE PRESS gives you 15 minutes of tumbling at the medium fabric temperature and 5 more minutes of tumbling without heat. **FINISH GUARD is automatically selected with this cycle.**

For best results, TUMBLE PRESS only a few items at a time. Put them on hangers or fold them as soon as the dryer stops.



WARNING: Drying plastic or rubber items with heat may damage the items or be a FIRE HAZARD.

If you want more than 20 minutes of tumbling, touch the FLUFF AIR **and** the **TIMED DRY Control** for the amount of time you want (up to 80 minutes).

Drying times



Drying times will vary depending on:

- amount of moisture in the clothes.
- type and weight of the fabric.
- size of the load.
- room temperature around the dryer.
- temperature of the wash/rinse water.
- amount of lint in the lint screen.
- dryer temperature selection.

See page 6 in your "Dryer Guide" for more information.

Mixed loads

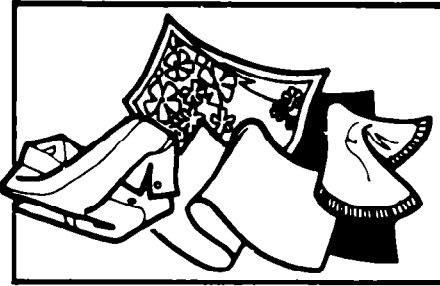

When drying a load with different kinds and weights of fabrics, use the setting suggested for the lightest fabrics.

End-of-cycle signal



The dryer will beep 5 times to let you know when the cycle is finished. It will also beep after each FINISH GUARD tumbling. The signal cannot be turned off and is not adjustable.

The signal is helpful when you are drying permanent press, synthetics and other items that should be taken out as soon as the dryer stops.



Lint signal

Clean lint screen **before each load**. If you neglect to clean your lint screen, the signal will sound. The (whistle tone) signal lets you know the air flow is being restricted. Restricted air flow reduces drying efficiency.

Turn off the dryer and clean the lint screen as shown on page 10.

Using the drying rack

The drying rack lets you dry items that you may not want to tumble; for example, sneakers, stuffed toys, knitted wool, etc.

The rack does not move, but the drum turns. **Make sure nothing hangs over the edges of the rack.**

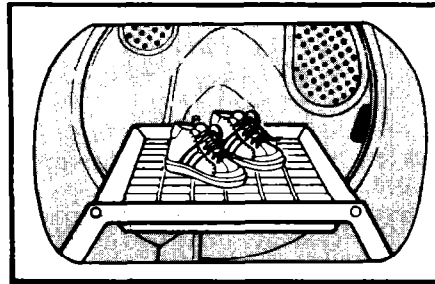
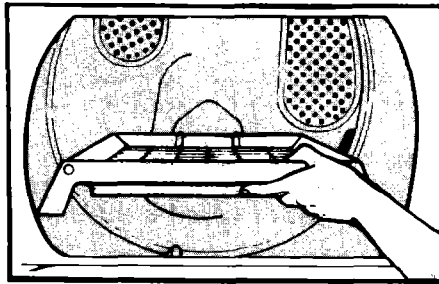

1. Fit rear legs of the rack into indents in back wall of dryer.
2. Lower the front so legs rest on dryer opening.
3. Put wet items on top of the rack. **Leave space between them** so air can reach all surfaces.
4. Close the door; touch a TIMED DRY Control selection.

Control selection

Drying time will depend on how much moisture the items hold. The following chart suggests temperature settings for different kinds of items that might best be rack dried.

To rack dry...	Use Temperature setting...
Wool sweaters (Block to shape and lay flat on the rack.)	KNITS GENTLE / LOW
Stuffed toys or pillows (Cotton or polyester fiber filled.)	PERM'T PRESS/MED
Stuffed toys or pillows* (Foam rubber filled)	FLUFF AIR
Sneakers or canvas shoes*	FLUFF AIR

***WARNING: Drying with heat may damage the foam rubber and will be a FIRE HAZARD.**

Be sure to take the rack out for normal tumble drying.

Lint screen

Clean the lint screen before each load. A screen blocked by lint can increase drying time and may be a FIRE HAZARD.

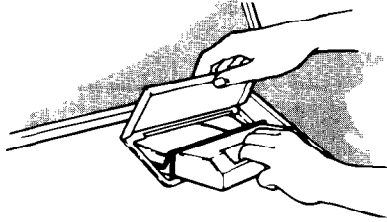

Open the lid and pull the lint screen straight out.

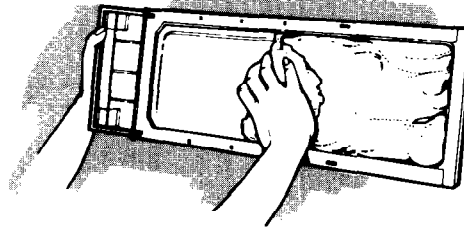

ROLL the lint off the screen with your fingers.

DO NOT rinse or wash the screen.

Push the screen firmly back into place.

WARNING: DO NOT run the dryer with the lint screen loose, damaged or missing. Doing so can cause overheating, can damage fabrics and can be a **FIRE HAZARD**.

Lint removal

Lint can gather inside the dryer and create a fire hazard. **This lint should be removed every 2 to 3 years, or more often, depending on dryer usage.**

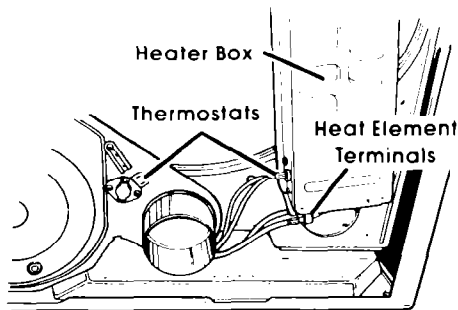

ELECTRIC DRYERS

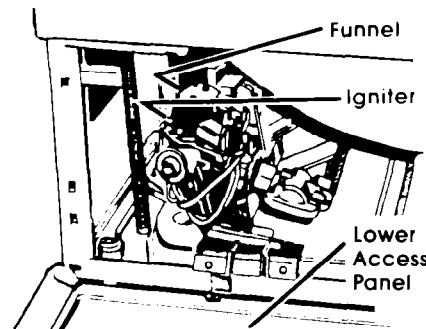

GAS DRYERS

Cleaning should be done only by a qualified person.



WARNING:

- Avoid electrical shock hazard – unplug power supply cord or turn off electrical power.
- Avoid injury or damage – do not put hands inside cabinet.
- Make sure dryer is cool.

1. Remove back panel (electric) or lower access panel (gas).
2. Avoid damaging wires, thermostats, funnel or igniter.
3. Remove lint from shaded area – see art – with a soft brush or vacuum cleaner.
4. Replace panel; reconnect and re-level dryer.

Caring for your dryer



Remove all loose and sharp objects from pockets and cuffs before drying – pins, buckles, etc. **Close metal zippers.**

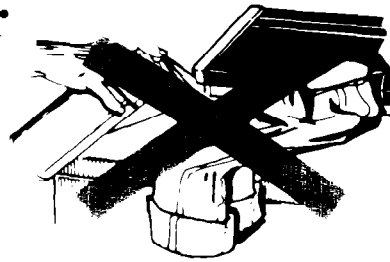

Some pretreatment products can damage dials, consoles and finish. Do not use these products on or near your dryer.

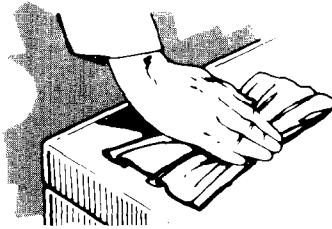

Wipe off all spills with a damp, soft cloth. Spills allowed to remain may dull or damage the finish.

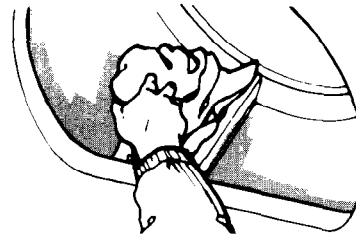

Cleaning dryer interior



Before cleaning interior, unplug power supply cord or turn off electrical power to avoid electrical shock hazard.

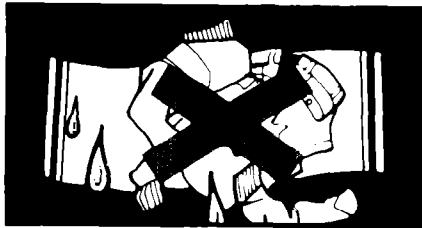

Never leave wet or damp laundry in your dryer.

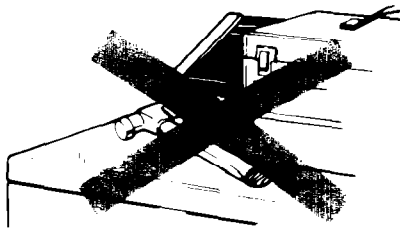

Sharp or heavy objects should never be put on or in the dryer. Check pockets for bolts, nuts, etc.

Garments which contain unstable dyes, such as denim blue jeans or brightly colored cotton items, may discolor the dryer interior. If the interior is discolored, clean with one of the following methods to avoid staining later load items.

Powdered laundry detergent and very warm water

Make a paste with detergent and very warm water. Apply paste to a soft cloth and scrub area until all excess dye is removed. Wipe thoroughly with a damp cloth. Tumble a load of rags. – **OR** –

Liquid spray household cleaner

Spray on stained area. Rub with a cloth until all excess dye is removed. Tumble a load of rags.

Vacation care

- Unplug power cord or turn off electrical power.
- For gas dryers, close gas valve.
- Clean lint screen.

Changing the drum light



WARNING: Unplug the dryer to avoid possible electric shock.

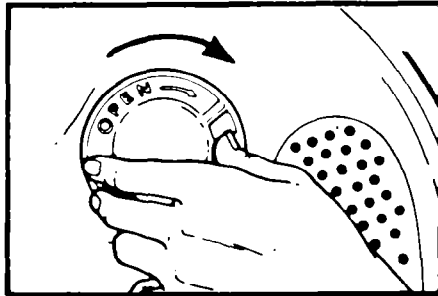

1. Open the dryer door and remove light bulb cover by turning it clockwise.

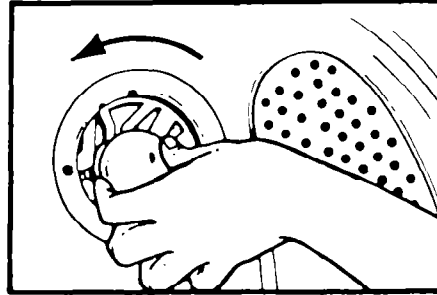

2. Remove the light bulb by turning it counterclockwise.

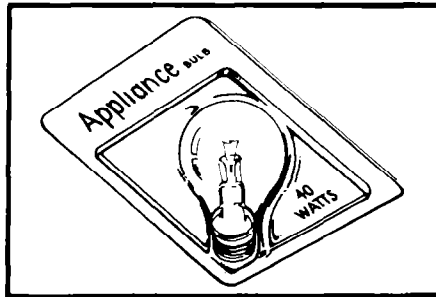

3. Replace the bulb only with a **40-watt appliance bulb** from most hardware, grocery or variety stores.

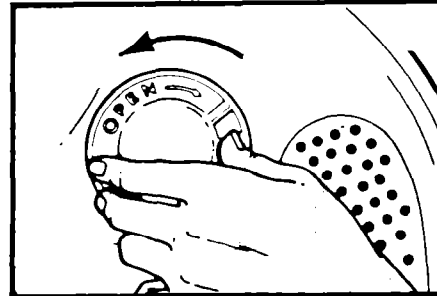

4. Replace the light bulb cover and lock it in place by turning counterclockwise.

CAUTION: The bulb cover must be securely in place during dryer operation to prevent overheating and possible damage to fabrics. Operating the dryer with the bulb cover removed can cause the dryer to fail or create a FIRE HAZARD.

If you need service or assistance, we suggest you follow these four steps:

1. Before calling for assistance...

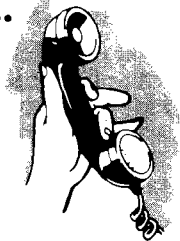

Performance problems often result from little things you can find and fix yourself without tools of any kind.

If your dryer does not run:

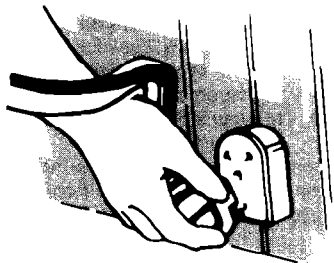

- If the power supply cord plugged into a live circuit with the proper voltage?
- Is the door closed tightly?
- Did you touch the **lower half** of a FABRIC-TEMP Selector?

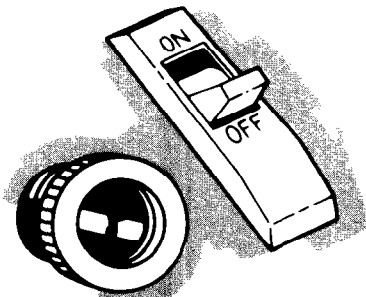

- Have you checked your home's main fuses or circuit breaker box?

If your dryer does not heat:

- The AIR setting is without heat.
- The last minutes of heat settings are without heat.

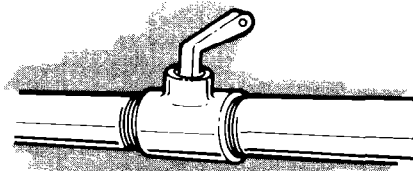

- Is the gas turned on? If not, move POWER SWITCH to OFF. Turn on gas. Wait 5 minutes. Reset controls and start.
- An electric dryer uses a circuit breaker or 2 fuses. If one fuse is blown, the dryer may run, but not heat.

If drying time seems long:

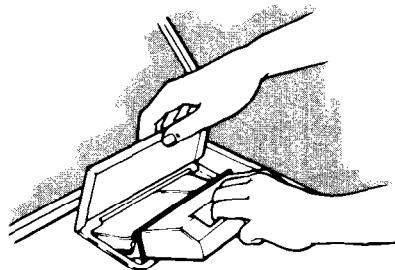

- Is the lint screen clean?
- See page 7 of this book and page 6 of your "Dryer Guide."

2. If you need assistance*...

Call Whirlpool COOL-LINE® service assistance telephone number. Dial free from:

Continental U.S. . . (800) 253-1301
 Michigan (800) 632-2243
 Alaska & Hawaii (800) 253-1121

and talk with one of our trained Consultants. The Consultant can instruct you in how to obtain satisfactory operation from your appliance or, if service is necessary, recommend a qualified service company in your area.

3. If you need service*...



Whirlpool has a nationwide network of franchised TECH-CARE[®] Service Companies. TECH-CARE

service technicians are trained to fulfill the product warranty and provide after-warranty service, anywhere in the United States. To locate TECH-CARE service in your area, call our COOL-LINE service assistance telephone number (see Step 2) or look in your telephone directory Yellow Pages under:

APPLIANCES - HOUSEHOLD - MAJOR - SERVICE & REPAIR OR ELECTRICAL APPLIANCES - MAJOR - REPAIRING & PARTS
WHIRLPOOL APPLIANCES FRANCHISED TECH-CARE SERVICE WHIRLPOOL APPLIANCES FRANCHISED TECH-CARE SERVICE

SERVICE COMPANIES SERVICE COMPANIES
XYZ SERVICE CO XYZ SERVICE CO
123 Maple 999-9999 123 Maple 999-9999

OR

WASHING MACHINES, DRYERS & IRONERS - SERVICING

WHIRLPOOL APPLIANCES FRANCHISED TECH-CARE SERVICE

SERVICE COMPANIES
XYZ SERVICE CO
123 Maple 999-9999

4. If you have a problem*...

Call our COOL-LINE service assistance telephone number (see Step 2) and talk with one of our Consultants, or if you prefer, write to:

Mr. Stephen E. Upton
Senior Vice President
Whirlpool Corporation
Administrative Center
2000 US-33 North
Benton Harbor, MI 49022

*If you must call or write, please provide: model number, serial number, date of purchase, and a complete description of the problem. This information is needed in order to better respond to your request for assistance.



FSP is a registered trademark of Whirlpool Corporation for quality parts. Look for this symbol of quality whenever you need a replacement part for your Whirlpool appliance. FSP replacement parts

will fit right and work right, because they are made to the same exacting specifications used to build every new Whirlpool appliance.



Making your world a little easier.

Part No. 696211
©1985 Whirlpool Corporation

Printed in U.S.A.

Automatic Washers, Clothes Dryers, Freezers, Refrigerator-Freezers, Ice Makers, Dishwashers, Built-In Ovens and Surface Units, Ranges, Mic

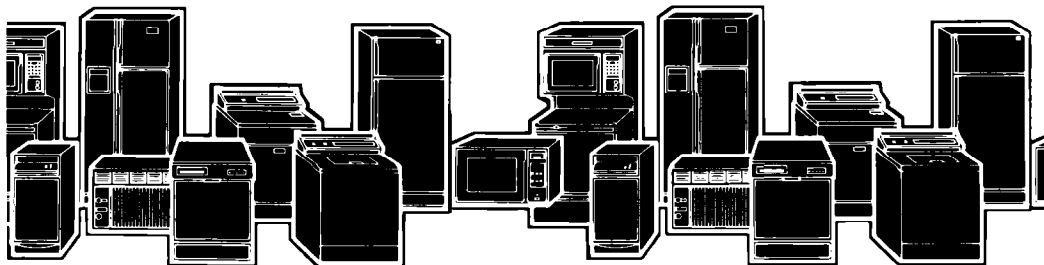

Free Manuals Download Website

<http://myh66.com>

<http://usermanuals.us>

<http://www.somanuals.com>

<http://www.4manuals.cc>

<http://www.manual-lib.com>

<http://www.404manual.com>

<http://www.luxmanual.com>

<http://aubethermostatmanual.com>

Golf course search by state

<http://golfingnear.com>

Email search by domain

<http://emailbydomain.com>

Auto manuals search

<http://auto.somanuals.com>

TV manuals search

<http://tv.somanuals.com>