



HOW TO MAKE A HOME RUN.™

Use And Care

G U I D E



| | |
|---|-------|
| A Note to You | 2 |
| Dryer Safety | 3-4 |
| Parts and Features | 5 |
| Operating Your Dryer | 6 |
| Before starting your dryer | 6 |
| Starting your dryer | 6 |
| Stopping/restarting your dryer | 6 |
| Selecting the right cycle and setting | 7 |
| Caring for Your Dryer ... | 10 |
| Laundry Tips | 13-16 |
| Troubleshooting | 17-18 |
| Requesting Assistance or Service | 19 |
| Warranty | 20 |

1-800-253-1301
Call our Consumer Assistance Center with questions or comments.

COMPACT ELECTRIC AND GAS DRYERS

MODELS LDR3822D LER3622D LGR3622D

A Note to You

Thank you for buying a WHIRLPOOL® appliance.

Because your life is getting busier and more complicated, WHIRLPOOL dryers are easy to use, save time, and help you manage your home better. To ensure that you enjoy years of trouble-free operation, we developed this Use and Care Guide. It contains valuable information about how to operate and maintain your dryer properly and safely. Please read it carefully. Also, please complete and mail in the Ownership Registration Card provided with your appliance. The card helps us notify you about any new information on your appliance.

Please record your model's information.

Whenever you call to request service on your appliance, you need to know your complete model number and serial number. You can find this information on the model and serial number label in the door well (see diagram on page 5 for location of label).

Please also record the purchase date of your appliance and your dealer's name, address, and telephone number.

Model Number _____

Serial Number _____

Purchase Date _____

Dealer Name _____

Dealer Address _____

Dealer Phone _____

Keep this book and the sales slip together in a safe place for future reference.

**Our Consumer Assistance Center
number is toll-free 24 hours a day.**

1-800-253-1301

Dryer Safety

Your safety is important to us.

This guide contains safety statements under warning symbols. Please pay special attention to these symbols and follow any instructions given. Here is a brief explanation of the use of the symbol.

⚠ WARNING

This symbol will help alert you to such dangers as fire, electrical shock, burns, and personal injury.

IMPORTANT SAFETY INSTRUCTIONS

⚠ WARNING

For your safety, the information in this manual must be followed to minimize the risk of explosion or fire, or to prevent loss of life, personal injury, or property damage.

- Do not store or use gasoline or other flammable vapors and liquids in the vicinity of this or any other appliance.
- **WHAT TO DO IF YOU SMELL GAS:**
 - Do not try to light any appliance.
 - Do not touch any electrical switch; do not use any phone in your building.
 - Clear the room, building, or area of all occupants.
 - Immediately call your gas supplier from a neighbor's phone. Follow the gas supplier's instructions.
 - If you cannot reach your gas supplier, call the fire department.

Installation and service must be performed by a qualified installer, service agency, or the gas supplier.

continued on next page

IMPORTANT SAFETY INSTRUCTIONS

⚠ WARNING

To reduce the risk of fire, electrical shock, or injury to persons when using your dryer, follow basic precautions, including the following:

- Read all instructions before using your dryer.
- Dryer must be electrically grounded. See the Installation Instructions.
- Do not machine wash or machine dry items cleaned, washed, soaked in, or spotted with wax, paint, gasoline, oil, dry cleaning solvents, or other flammable fluids. The fumes can create a fire hazard or explosion. Always hand wash and line dry items containing these materials.
- Do not wash or dry items that are soiled with vegetable or cooking oil. These items may contain some oil after laundering. Due to the remaining oil, the fabric may smoke or catch fire by itself.
- Store flammable solvents or fluids away from your dryer.
- Dry cleaning solvents or fluids should never be put directly into your dryer.
- Do not let dust, lint, paper, rags, chemicals, etc., pile up around or under the dryer.
- Do not allow lint to build up inside the dryer or exhaust system. Cleaning should be done periodically by a qualified person.
- Do not allow children to operate, play with, or crawl inside your dryer. Supervise children when your dryer is used near children.
- Do not reach into a dryer if the drum is moving.
- Install and/or store dryer where it will not be exposed to the weather.
- Do not tamper with the controls.
- Do not dry rubber, rubber-like, or heat-sensitive materials with heat.
- Unplug the power supply cord or turn off electrical power before attempting to service your dryer. Also, shut off gas valve if you have a gas dryer.
- When removing from service or discarding a dryer, always remove the door to prevent accidental entrapment.
- Clean lint screen before or after each load.
- Use only fabric softeners specifically labeled as not being harmful to the dryer.

Understanding your responsibilities

- Be sure that your dryer:
 - is located in an area where the temperature is above 45°F (7°C).
 - is properly installed in a well-ventilated room and leveled on a floor that can support the weight.*
 - is connected to the proper outlet and electrical supply.*
 - is properly connected to fuel and exhaust systems (gas dryers must be vented outdoors).*
 - is not installed against draperies or curtains, or on carpet.*
 - is properly maintained, repaired, and has parts replaced by a qualified person.
 - is used only for jobs normally expected of home clothes dryers.
 - is not used by anyone unable to operate it properly.
 - Never operate the dryer if:
 - it is not working right (i.e. noisy, too hot).
 - it is damaged.
 - parts are missing.
 - all panels are not in place.
 - the lint screen is loose, damaged, or missing.
- *See the Installation Instructions for complete information.

– SAVE THESE INSTRUCTIONS –

Parts and Features

The parts and features of your dryer are illustrated below. Become familiar with all parts and features before using your dryer.

NOTE: The drawings in this book may vary from your dryer model. They are designed to show the different features of all models covered by this book. Your model may not include all features.

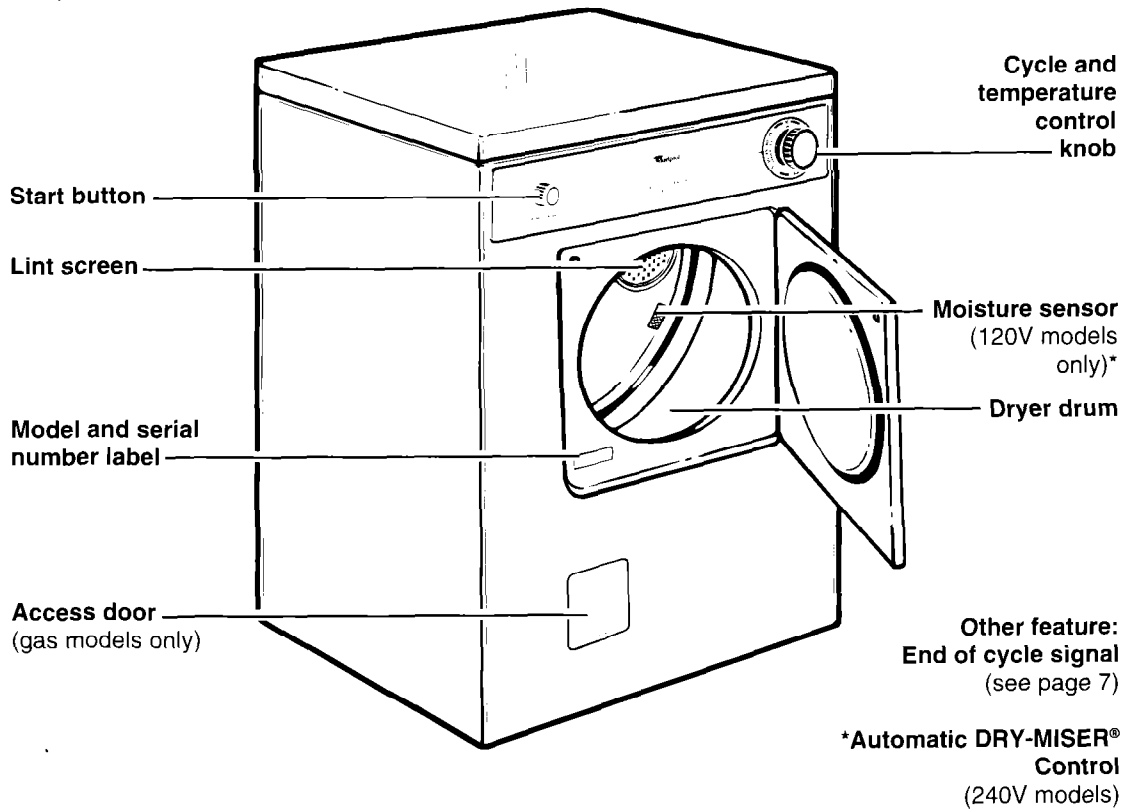

Optional mounting kits

You can mount your compact dryer above your compact washer using one of the following kits:

⚠ WARNING

Fire and Explosion Hazard

If mounting a gas dryer, use only Dryer Stand Kit, Part No. 49971 or 49978. Using any other kit could result in a gas leak. Failure to follow the above instructions could cause explosion or fire.

- Dryer Stand Kit for permanent installation, secured to the wall. Part No. 49971(white) or 49978 (almond)

- Dryer Wall-Mounting Kit for securing the dryer to the wall with a steel bracket. Part No. 345994 (electric only)

NOTE: The wall must be strong enough to support the dryer's weight. (Do not use in mobile homes.)

Optional deflector kit

- Exhaust Deflector Kit to move dryer exhaust up, down, or to the side. Part No. 346001 (electric)

Operating Your Dryer

The information in this section helps you learn to use your dryer efficiently and safely. Refer to "Laundry Tips" on page 13 for additional information on sorting, loading, and drying most types of washables.

Before starting your dryer

Before using your dryer, wipe the dryer drum with a damp cloth to remove dust from storing and shipping.

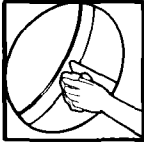

Starting your dryer

1. Load clothes into the dryer and close the door.



3. Push the Start Button.

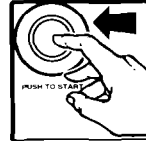

2. Turn the Cycle Control Knob either way to the desired cycle. Use the Energy Preferred Automatic Setting (*) to dry most loads (see page 7).

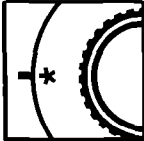

NOTE: Your dryer stops automatically when a cycle ends.

Stopping/restarting your dryer

You can stop your dryer anytime during a cycle.

To stop the dryer, either:

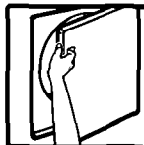

- Open the dryer door.

OR

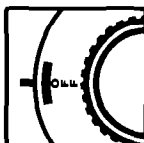

- Turn the Cycle Control Knob to OFF.

To restart the dryer:

1. Close the door.
2. Select a new cycle and temperature (if desired).
3. Push the Start Button.

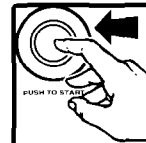

NOTE: The Cycle Control Knob should point to an OFF area when the dryer is not in use.

End of cycle signal

The dryer sounds a signal to let you know when the cycle is finished. The signal is not adjustable and cannot be turned off.

The signal is helpful when you are drying permanent press, synthetics, and other items that should be taken out as soon as the dryer stops.

Selecting the right cycle and setting

The following pages describe the cycles on your dryer. Refer to the chart on page 9 for help in selecting drying cycles.

Drying guidelines

- Always follow care label directions when they are available.
- Use the Air cycle, or line dry rubber, plastic, delicate, and heat-sensitive fabrics (see page 8).
- The last few minutes of all cycles are without heat to make the load easier to handle.
- To help reduce wrinkling, remove the load from the dryer as soon as tumbling stops. This is especially important for permanent press, knits, and synthetic fabrics.
- Overdrying can cause shrinkage, static cling, and damage to some fabrics.
- Refer to pages 13-15 for information about:
 - sorting clothes for drying
 - choosing load sizes
 - drying tips
 - using dryer fabric softeners
 - saving energy
 - drying special-care items.

Cycle descriptions

Automatic Permanent Press/ Regular Cycle(s)

Dry most loads using the **Energy Preferred Automatic Setting (*)**. Your Automatic cycle(s) shuts off when the selected dryness is reached. The Cycle Control Knob will not move until the load is almost dry. After the cool-down, the Knob automatically turns to an OFF area and tumbling stops.

- If the load is drier than you like, select a setting closer to **LESS DRY** the next time you dry a similar load.
- If the load is not as dry as you like, complete drying using a **Timed** cycle. Select a setting closer to **VERY DRY** the next time you dry a similar load.

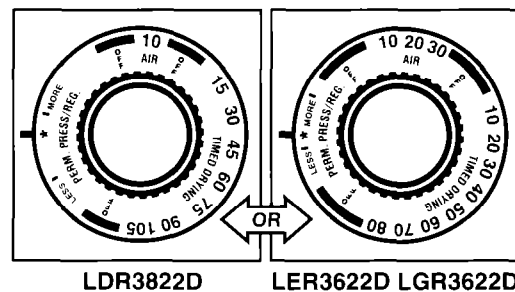

OPERATING YOUR DRYER

Timed Cycle(s)

Use a Timed cycle to complete drying if some items are damp after Automatic drying. Timed drying is also useful for:

- Delicate items and small loads that need a short drying time.
- Bulky items and large loads that require a long drying time.

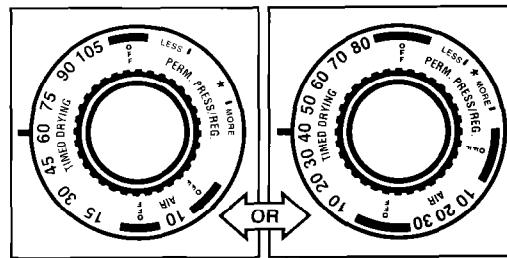

LDR3822D

LER3622D LGR3622D

Air Cycle

The Air cycle has no heat. Use this unheated cycle to fluff or air dry bedding, plastic tablecloths, foam pillows, sneakers, etc. See page 9 for more information about the Air cycle.

⚠ WARNING

Fire Hazard

Do not dry heat-sensitive fabrics, plastic, rubber, or some stuffed items with heat. Use the Fluff Air cycle, if available, or dry these items on a line or rack.

Failure to do so could result in fire or damaged items.

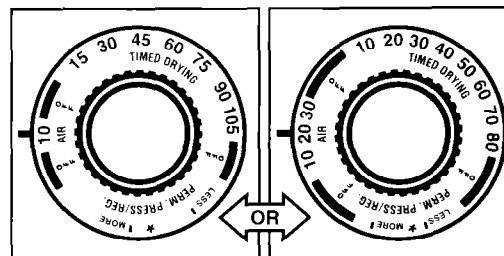

LDR3822D

LER3622D LGR3622D

Selecting the right cycle and setting

| TYPE OF LOAD | CYCLE | MODELS | |
|--|--|--|--|
| | | LDR3822D | LER3622D LGR3622D |
| COTTONS AND LINENS Extra Heavy—Bedspreads, mattress pads, quilts Heavyweight—Towels, jeans, corduroys, work clothes MEDIUM WEIGHT—Sheets, cotton underwear, diapers Lightweight—Batistes, organdies, lingerie | Timed Drying Perm. Press/Reg. Perm. Press/Reg. Perm. Press/Reg. | 90-105 min | 45-55 min |
| PERMANENT PRESS, SYNTHETICS AND BLENDS Heavyweight—Work clothes, jackets, raincoats MEDIUM WEIGHT—Shirts, play clothes, sheets, slacks Lightweight—Lingerie, blouses, dresses | Perm. Press/Reg. Perm. Press/Reg. Perm. Press/Reg. | | |
| KNITS Heavyweight—Cottons, rayons, blends, T-shirts, slacks, shirts Medium weight—Synthetics (polyester, acrylic, etc.), dress slacks, skirts, sweaters Lightweight—Synthetics (polyester, acrylic, etc.) and blends, lingerie, blouses, dresses | Perm. Press/Reg. Perm. Press/Reg. Perm. Press/Reg. | | |
| DELICATE FABRICS Sheer curtains (2 or 3 panels), gauze, lace, etc. | Air | 20-30 min* | 20-30 min* |
| RUBBER, PLASTIC, HEAT-SENSITIVE FABRICS Foam Rubber—Pillows, bras, stuffed toys Plastic—Shower curtains, tablecloths Rubber-backed rugs Olefin, Polypropylene, Sheer nylon | Air Air Air Air | 20-30 min* 20-30 min* 40-50 min* 15-20 min* | 20-30 min* 20-30 min* 40-50 min* 15-20 min* |
| COTTON AND CANVAS SHOES Place several bath towels in the dryer to act as a buffer, or place shoes on a drying rack if your dryer has one. Remove shoes from dryer while still damp. Stretch shoes and allow to air dry. | Air | 30-40 min* | 30-40 min* |

*Reset Air cycle as needed to complete drying.

Caring for Your Dryer

Proper care of your dryer can extend its life. This section explains how to care for your dryer properly and safely.

Cleaning the lint screen

Every load cleaning

The lint screen is located inside the dryer drum, on the back wall. **Clean it before each load.** A screen blocked by lint can increase drying time.

To clean:

1. Open the door and pull the lint screen straight out.



2. Squeeze body of lint screen lightly while pulling the cover off.

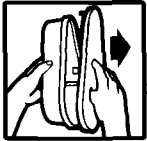

3. Roll lint off the screen with your fingers. Do not rinse or wash screen to remove lint. Wet lint is hard to remove.
4. Replace cover on lint screen body. Push the lint screen firmly back into place and close the door.

IMPORTANT:

- Do not run the dryer with the lint screen loose, damaged, blocked, or missing. Doing so can cause overheating and damage to both the dryer and fabrics.
- Some towels made of synthetic fibers and natural fibers (polyester and cotton blends) may shed more lint than other towels, causing your dryer's lint screen to fill up faster. Be sure to remove lint from the lint screen before and after drying new towels.

As needed cleaning

Laundry detergents and fabric softeners can cause a residue buildup on the lint screen. Clean the lint screen with a nylon brush every six months or more frequently if it becomes clogged due to a residue buildup.

Use the following method:

1. Wet both sides of lint screen with hot water.

2. Wet a nylon brush with hot water and liquid detergent; scrub lint screen with the brush to remove residue buildup.

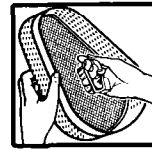

3. Rinse screen with hot water.
4. **Thoroughly** dry lint screen with a clean towel; replace in dryer.

Cleaning the dryer interior

Garments which contain unstable dyes, such as denim blue jeans or brightly colored cotton items, may discolor the dryer interior.

To clean dryer drum:

1. Make a paste with detergent and very warm water.
2. Apply paste to a soft cloth and scrub area until all excess dye is removed.



3. Wipe thoroughly with a damp cloth.
4. Tumble a load of rags to dry.

⚠WARNING

Explosion Hazard

Turn off the electrical power before cleaning the dryer interior.

Make sure the dryer is cool.

Use nonflammable cleaner.

Failure to do so could result in explosion, fire, electrical shock, or injury.

Removing accumulated lint

Lint can gather inside the dryer and be a fuel for fire. Lint should be removed every two to three years, or more often, depending on dryer usage. Cleaning should be done by a qualified person. If you have any questions or comments, please call our Consumer Assistance Center at 1-800-253-1301.

⚠ WARNING

Electrical Shock Hazard

Unplug the power supply cord or turn off the electrical power before removing dryer panels.

Make sure the dryer is cool.

Dryer parts can have sharp edges. Use care when handling.

When replacing front panel after lint removal, the wire clips holding the door switch wires must be anchored to top of front and side panels. Wires **MUST NOT** touch rotating drum.

Failure to do so could result in electrical shock or personal injury.

For all electric dryers, or gas dryers

1. Unplug the power supply cord or turn off the electrical power.
2. **Electric dryers:**
Remove back panel using a hex-head screwdriver (1/4 inch).
- Gas dryers:**
Pry off lower front access panel using a flat-blade screwdriver.
3. Remove lint from shaded area in illustration with a soft brush or vacuum cleaner. Avoid damaging wires, thermostats (electric), funnel (gas), or ignitor (gas).
4. Replace panel.
5. Reconnect and level dryer again, if necessary.

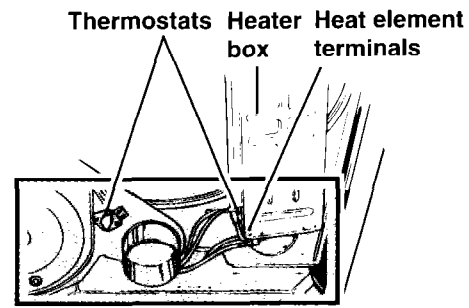

Electric dryer with back panel removed

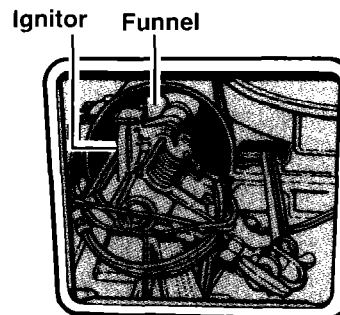

Gas dryer with lower front access panel removed

Laundry Tips

This section provides information on preparing clothes for drying, drying guidelines, and instructions for drying special-care items.

NOTES:

- Refer to your Washer Use and Care Guide for proper washing techniques and additional laundry tips.
- See pages 3 and 4 of this book for Important Safety Information.

Sorting clothes



- Separate dark from light colors; colorfast from non-colorfast. Items properly sorted for washing are usually properly sorted for drying.
- Separate heavy fabrics (denim, towels) from light fabrics (synthetics, permanent press).
- Separate lint givers (towels, chenille) from lint takers (corduroy, synthetics, permanent press). When possible, turn lint takers inside out.

Choosing load sizes

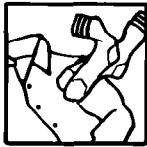

- Mix large items with smaller items. Load the dryer by the amount of space items take up, not by their weight. Do not overload the dryer. Overcrowding causes uneven drying and wrinkling, and can cause items to wear out faster (because of pilling).
- You may need to rearrange large items (sheets, blankets, tablecloths) during a cycle to reduce balling or rolling up.
- For better tumbling action, when drying only a few small items, add one or two lint-free towels. This also prevents small, lightweight items from blocking airflow.

Drying tips



- Close zippers, snaps, and hooks to avoid snagging other items. Remove heat-sensitive trim that can be damaged by drying. Tie strings and sashes so they will not tangle.
- Check garments to make sure all spots and stains were removed during the wash. Do not tumble dry soiled or stained items. Heat may permanently set stains.
- Sharp or metal objects can damage your dryer. Check pockets for pins, clips, money, bolts, nuts, etc. Do not lay these objects on your dryer after emptying pockets. Turn pockets of heavy items inside out for even drying.
- Place small items such as baby socks or hankies in a mesh bag for easier removal.
- Articles to be ironed should be removed from the dryer while still damp.

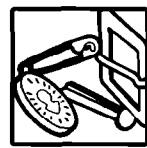

Using dryer fabric softeners

Dryer fabric softeners are recommended for reducing static cling and for softening fabrics. Always follow package instructions carefully.

- Put one fabric softener sheet on top of the load **before starting the dryer**.

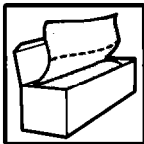

Do not add a fabric softener sheet **after** the drying cycle has started. Instant heat can cause the fabric softener to spot fabrics.

- Remove fabric softener stains by wetting the stains and rubbing them with liquid detergent or bar soap and rewash.
- Some fabric softeners can clog the lint screen and slow drying. Use fabric softeners labeled as dryer safe.

Saving energy

- Use an Automatic cycle to dry most loads.
- Dry only full loads without overdrying.
- Avoid overloading dryer, adding wet items to a partly dried load, or opening the door unnecessarily.
- Plan your laundry to dry one load after another. A warm dryer shortens drying time.
- Shorten drying times by exhausting dryer properly and cleaning exhaust duct and outside exhaust hood as needed.
 - Keep the lint screen clean.
 - Use your dryer in a room where room air temperature is above 45°F (7°C).
 - Sort loads by fabric weight and type.

Vacation care

1. Unplug power supply cord or turn off electrical power supply.
2. Clean lint screen.

Voltage requirements

- Model LER3622D operates on 240 or 208 volt household current.
- Models LDR3822D and LGR3622D operate on 120 volt household current.

NOTE: Electric dryers using 208 or 120 volts require longer drying times than dryers using 240 volts.

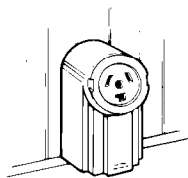

240 or 208 volt power supply

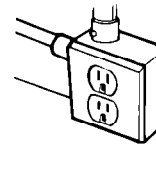

120 volt power supply

Drying special-care items

Most garments and household textiles have manufacturer's care labels with laundering instructions. **Always follow care label directions when they are available.** Page 9 includes drying instructions for most types of washables. The chart below provides drying instructions for special-care washables.

| ITEMS | DRYING INSTRUCTIONS |
|---|---|
| <p>Blankets and woolens</p> <ul style="list-style-type: none"> • Cotton, rayon, synthetic blankets • Electric blankets, electric sheets, woolen blankets, washable woolen garments | <p>Machine drying knitted woolens is not recommended. Block to shape when wet and allow to air dry. Line dry blankets in the shade on a breezy day over two lines. Pin edges together and straighten them. When partly dry, turn the blanket over, re-pin, and re-straighten. When dry, brush nap.</p> <p>Dry as recommended for permanent press fabrics on page 9.</p> <p>If manufacturer recommends machine drying:</p> <ol style="list-style-type: none"> 1. Place one or two dry towels in the dryer and preheat 3-5 minutes on a high setting. This will dry blankets faster and help avoid pilling. 2. Put blanket in dryer with warm towels. 3. Check after 10 minutes. Remove when still damp. Overdrying and long tumbling can cause shrinking and pilling. 4. Place blanket on flat surface, or over two lines to finish drying. Gently stretch to original size and shape. 5. When completely dry, brush gently to raise nap. Press binding with cool iron if needed. |
| <p>Curtains, slipcovers</p> <ul style="list-style-type: none"> • Draperies, slipcovers | <p>Remove drapery weights and hooks before laundering. For slipcovers, replace while still slightly damp. They will dry to fit tightly.</p> <p>Dry only a few minutes.</p> <ol style="list-style-type: none"> 1. Leave room in dryer for load to fluff. 2. Remove from dryer while slightly damp. Do not overdry. |
| <p>Diapers, baby clothes</p> | <p>Wash and dry small items in a mesh bag or pillowcase for convenient handling.</p> <p>Remove diapers and cotton knit items while still slightly damp. They will feel softer, shrink less, and be easier to fold.</p> |
| <p>Elastic items</p> | <p>Remove from dryer while still slightly damp.</p> |

continued on next page

LAUNDRY TIPS

| ITEMS | DRYING INSTRUCTIONS |
|---|--|
| Flame-retardant finishes | Some items have been treated with a flame-retardant finish to improve their resistance to burning. Such items are clearly labeled. To retain flame-retardant qualities through continuous use and washing, clean and dry according to the manufacturer's instructions. |
| Napped items <ul style="list-style-type: none"> • Corduroy, velveteen | Dry separately or with similar colors to avoid lint transfer. Follow care label instructions. <ol style="list-style-type: none"> 1. Remove from dryer while there is still a trace of moisture. 2. Smooth, reshape, and air dry before putting away. |
| Quilted, down-filled items | Follow care label instructions. <ol style="list-style-type: none"> 1. Dry one at a time. 2. Remove from dryer and shake or fluff the item during the drying cycle. 3. Smooth and reshape before putting away. |
| Snowsuits, jackets <ul style="list-style-type: none"> • Nylon or polyester | Check label for fiber content, then follow care label instructions. <ol style="list-style-type: none"> 1. Dry garment for about 10 minutes. Remove and turn inside out. Dry for 10 more minutes. 2. Remove from dryer immediately and hang on a non-rusting hanger to finish drying. This will help eliminate wrinkles. |
| Tinted, dyed, or noncolorfast items | Dry according to fabric, weight, and care label instructions. Wipe the dryer drum carefully to remove any dye or lint that can be transferred to other loads. See "Cleaning the dryer interior" on page 11. |
| Washable knits | Do not overdry knits. Overdrying can cause shrinking and static cling. <ol style="list-style-type: none"> 1. Select cycle according to fabric and construction. 2. Turn synthetics and blends inside out when drying to avoid pilling. 3. Remove cotton and rayon knits while still slightly damp. Stretch into shape and lay flat to finish drying. |

Troubleshooting

Most laundering problems are easily solved if you understand the cause. Check the following list for **laundry** problems you may have and their possible causes. Also refer to the next page for a **dryer** checklist which can help you solve some simple problems without calling for service. If you still need help, see “Requesting Assistance or Service” on page 19.

Common laundry problems

| PROBLEM | CAUSE |
|---------------------------|--|
| Greasy spots | <ul style="list-style-type: none">• Dryer fabric softener improperly used. See manufacturer's directions.• Drying soiled items. |
| Lint | <ul style="list-style-type: none">• Full lint screen. (See page 10.)• Load not properly sorted.• Overdrying, especially synthetic fabrics that cause lint-attracting static electricity.• Load size too big or heavy.• Tissue or paper left in pockets.• Pilling (surface fuzz caused by normal wear and laundering) attracts lint. |
| Shrinking | <ul style="list-style-type: none">• Overdrying.• Fabric type and quality inappropriate for drying.• Dryer settings incorrect for fabric type.• Manufacturer's care label instructions not followed. |
| Slow drying | <ul style="list-style-type: none">• Full lint screen.• Load too large and bulky to dry quickly.• Dryer located in room with temperature below 45°F (7°C).• Exhaust duct clogged, restricted, or too long. |
| Stains | <ul style="list-style-type: none">• Drying soiled items.• Dryer fabric softener improperly used. See manufacturer's directions.• Dryer interior stained. (See page 11 for cleaning procedures.) |
| Static electricity | <ul style="list-style-type: none">• Overdrying.• Dryer fabric softener improperly used. See manufacturer's directions.• Load includes synthetics, synthetic blends, permanent press, and knit fabrics that build up static electricity. |
| Wrinkling | <ul style="list-style-type: none">• Overloading.• Overdrying, especially permanent press, and synthetic fabrics.• Clothes left in dryer at end of cycle. |

TROUBLESHOOTING

Common dryer problems

Before calling for service, check these:

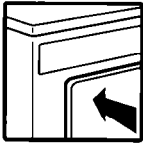

Is the dryer door firmly closed?

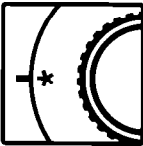

Are the controls set in an ON position?

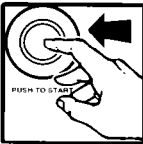

Did you firmly push the Start Button?



Is lint screen clogged with lint?

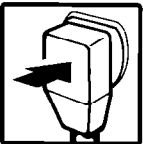

Is the power cord plugged in?

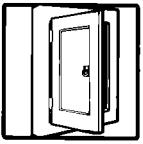

Have you blown a fuse or tripped the circuit breaker?

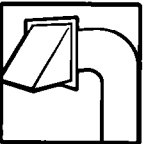

Is exhaust duct or outside exhaust hood clogged with lint?

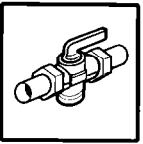

For gas dryers, are the valves open on the dryer and the supply line?



Is the dryer making noise? Is there a thumping sound from support rollers indicating dryer has not been used for awhile? Is the lint signal sounding?

If you still have problems, see "Requesting Assistance or Service" on page 19.

Requesting Assistance or Service

Before calling for assistance or service, please check "Troubleshooting" on pages 17-18. It may save you the cost of a service call. If you still need help, follow the instructions below.

1. If you need assistance* ...

Call the Whirlpool Consumer Assistance Center telephone number. Dial toll-free from anywhere in the U.S.A.:



1-800-253-1301

and talk with one of our trained consultants. The consultant can instruct you in how to obtain satisfactory operation from your appliance or, if service is necessary, recommend a qualified service company in your area.

If you prefer, write to:

Mr. William Clark
Consumer Assistance Representative
Whirlpool Corporation
2000 North M-63
Benton Harbor, MI 49022-2692

Please include a daytime phone number in your correspondence.

2. If you need service* ...

Whirlpool has a nationwide network of authorized Whirlpool service companies. Whirlpool service technicians are trained to fulfill the product warranty and provide after-warranty service, anywhere in the United States. To locate the authorized Whirlpool service company in your area, call our Consumer Assistance Center telephone number (see Step 1) or look in your telephone directory Yellow Pages under:



**• APPLIANCE-HOUSEHOLD-
MAJOR, SERVICE & REPAIR**

- See: Whirlpool Appliances or
Authorized Whirlpool Service
(Example: XYZ Service Co.)

**• WASHING MACHINES &
DRYERS, SERVICE & REPAIR**

- See: Whirlpool Appliances or
Authorized Whirlpool Service
(Example: XYZ Service Co.)

3. If you need FSP® replacement parts ...

FSP is a registered trademark of Whirlpool Corporation for quality parts. Look for this symbol of quality whenever you need a replacement part for your WHIRLPOOL® appliance. FSP replacement parts will fit right and work right, because they are made to the same exacting specifications used to build every new WHIRLPOOL appliance.

To locate FSP replacement parts in your area, refer to Step 2 or call the Whirlpool Consumer Assistance Center number in Step 1.

4. If you are not satisfied with how the problem was solved ...

- Contact the Major Appliance Consumer Action Program (MACAP). MACAP is a group of independent consumer experts that voices consumer views at the highest levels of the major appliance industry.
- Contact MACAP only when the dealer, authorized servicer, and Whirlpool have failed to resolve your problem.

Major Appliance Consumer Action Program
20 North Wacker Drive
Chicago, IL 60606

- MACAP will in turn inform us of your action.

*When asking for help or service:

Please provide a detailed description of the problem, your appliance's complete model and serial numbers, and the purchase date. (See page 2.) This information will help us respond properly to your request.

WHIRLPOOL® Dryer Warranty

| LENGTH OF WARRANTY | WHIRLPOOL WILL PAY FOR |
|---|--|
| FULL ONE-YEAR WARRANTY From Date of Purchase | FSP® replacement parts and repair labor to correct defects in materials or workmanship. Service must be provided by an authorized Whirlpool service company. |
| WHIRLPOOL WILL NOT PAY FOR | |
| <p>A. Service calls to:</p> <ol style="list-style-type: none"> 1. Correct the installation of your dryer. 2. Instruct you how to use your dryer. 3. Replace house fuses or correct house wiring or plumbing. 4. Replace light bulbs. <p>B. Repairs when your dryer is used in other than normal, single-family household use.</p> <p>C. Pickup and delivery. Your dryer is designed to be repaired in the home.</p> <p>D. Damage to your dryer caused by accident, misuse, fire, flood, acts of God, or use of products not approved by Whirlpool.</p> <p>E. Repairs to parts or systems caused by unauthorized modifications made to the appliance.</p> | |

6-94

WHIRLPOOL CORPORATION SHALL NOT BE LIABLE FOR INCIDENTAL OR CONSEQUENTIAL DAMAGES. Some states do not allow the exclusion or limitation of incidental or consequential damages, so this exclusion or limitation may not apply to you. This warranty gives you specific legal rights, and you may also have other rights which vary from state to state.

Outside the United States, a different warranty may also apply. For details, please contact your authorized Whirlpool distributor or military exchange.

If you need service, first see the "Requesting Assistance or Service" section of this book. After checking "Requesting Assistance or Service," additional help is available by calling our Consumer Assistance Center telephone number, **1-800-253-1301**, from anywhere in the U.S.A.



Printed on recycled paper –
 10% post-consumer waste
 50% recovered materials

Free Manuals Download Website

<http://myh66.com>

<http://usermanuals.us>

<http://www.somanuals.com>

<http://www.4manuals.cc>

<http://www.manual-lib.com>

<http://www.404manual.com>

<http://www.luxmanual.com>

<http://aubethermostatmanual.com>

Golf course search by state

<http://golfingnear.com>

Email search by domain

<http://emailbydomain.com>

Auto manuals search

<http://auto.somanuals.com>

TV manuals search

<http://tv.somanuals.com>