

Xerox Phaser
3140 / 3155 / 3160B / 3160N
Laser Printer

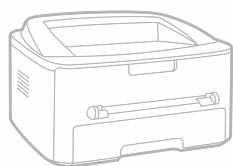

Xerox® Phaser® 3140 / 3155 / 3160B / 3160N User Guide Guide d'utilisation

Español Guía del usuario

Português Guia do usuário

Čeština Uživatelská příručka

Polski Przewodnik użytkownika

Magyar Felhasználói útmutató

Română Ghid de Utilizare

Български Ръководство за потребителя

Русский Руководство пользователя

Türkçe Kullanıcı Kılavuzu



copyright

© 2009 Xerox Corporation. All rights reserved.

This user guide is provided for information purposes only. All information included herein is subject to change without notice. Xerox Corporation is not responsible for any direct or indirect damages, arising from or related to use of this user guide.

- Xerox and Xerox logo are trademarks of Xerox Corporation.
- PCL and PCL 6 are trademarks of Hewlett-Packard Company.
- Microsoft, Windows, and Windows Vista are either registered trademarks or trademarks of Microsoft Corporation.
- TrueType, LaserWriter and Macintosh are trademarks of Apple Computer, Inc.
- All other brand or product names are trademarks of their respective companies or organizations.

REV. 1.00

table of contents

	7 Safety
	12 About this user guide
	14 Features of your new product
INTRODUCTION	16 Machine overview
16	Front view
	Rear view
	18 Control panel overview
	19 Understanding the control panel
	LEDs
	Button
GETTING STARTED	20 Setting up the hardware
20	20 Printing a demo page
	21 Supplied software
	21 System requirements
	Windows
	Macintosh
	Linux
	22 Installing driver for USB connected machine
	Windows
	Macintosh
	Linux
	24 Sharing your machine locally
	Windows
	Macintosh
NETWORK SETUP (PHASER 3160N ONLY)	25 Network environment
25	25 Introducing useful network programs
	CentreWare IS (Phaser 3160N only)
	SetIP
	25 Installing drivers for network connected machine
	Windows
	Macintosh
	Linux
	27 Using a wired network
	Printing network configuration report
	Setting IP address
	Network parameter setting
	Restoring factory default settings
	29 IPv6 Configuration
	Printing network configuration report
	Setting IPv6 addresses
	Manual address configuration
	Installing printer driver
	Using CentreWare IS
BASIC SETUP	30 Altitude adjustment
30	For Phaser 3140 and 3155
	For Phaser 3160B and 3160N
	30 Setting the default tray and paper
	In the computer
	31 Using power saving feature
	For Phaser 3140 and 3155

table of contents

		For Phaser 3160B and 3160N
	31	Changing font setting (Phaser 3160B and Phaser 3160N only)
MEDIA AND TRAY	32	Selecting print media
		Guidelines to select the print media
		Media sizes supported in each mode
	32	Changing the tray size
	33	Loading paper in the tray
		Tray 1
		Manual tray
	34	Printing on special media
		Envelope
		Transparency
		Labels
		Card stock/ Custom-sized paper
		Letterhead/ Preprinted paper
		Photo
		Glossy
	36	Using the output support
PRINTING	37	Printer driver features
		Printer driver
	37	Basic printing
		Canceling a print job
	38	Opening printing preferences
		Using a favorite setting
	38	Using help
	38	Using special print features
		Printing multiple pages on one sheet of paper
		Printing posters
		Printing booklets (Manual)
		Printing on both sides of paper (Manual)
		Change percentage of your document
		Fitting your document to a selected paper size
		Using Troubleshooting tab
		Using watermarks
		Using overlay
		Graphics tab options
	41	Changing the default print settings
	42	Setting your machine as a default machine
	42	Printing to a file (PRN)
	42	Macintosh printing
		Printing a document
		Changing printer settings
		Printing multiple pages on one sheet of paper
	44	Linux printing
		Printing from applications
		Printing files
		Configuring printer properties
MANAGEMENT TOOLS	46	Using CentreWare IS (Phaser 3160N only)
		To access CentreWare IS:
		CentreWare IS overview
	46	Using utility applications
		Understanding Status Monitor

table of contents

		Using Printer Settings Utility (Phaser 3160B, Phaser 3160N only)
		Opening the Troubleshooting Guide
47	Using SetIP program (Phaser 3160N only)	Windows
		Macintosh
		Linux
48	Using the Unified Linux Driver Configurator	Opening the Unified Driver Configurator
		Printers configuration
		Ports configuration
MAINTENANCE	50	Printing a machine report
	50	Using toner low alert (Phaser 3160B and Phaser 3160N only)
	50	Cleaning a machine
		Cleaning the outside
		Printing a cleaning sheet (Phaser 3160B and Phaser 3160N only)
		Cleaning the inside
	51	Storing the toner cartridge
		Handling instructions
		Use of non-Xerox and refilled toner cartridge
		Estimated cartridge life
	51	Tips for moving & storing your machine
TROUBLESHOOTING	52	Redistributing toner
	52	Tips for avoiding paper curls
	53	Tips for avoiding paper jams
	53	Clearing paper jams
		In tray
		In the manual tray
		Inside the machine
		In exit area
	55	Solving other problems
		Power problems
		Paper feeding problems
		Printing problems
		Printing quality problems
		Common Windows problems
		Common Linux problems
		Common Macintosh problems
SUPPLIES	62	How to purchase
	62	Available supplies
	62	Available maintenance parts
	62	Replacing the toner cartridge
SPECIFICATIONS	64	Hardware specifications
	64	Environmental specifications
	65	Electrical specifications
	66	Print media specifications

table of contents

GLOSSARY

67

SAFETY INTRODUCTION

Notices and Safety

Please read the following instructions carefully before operating the machine and refer to them as needed to ensure the continued safe operation of your machine.





Your Xerox product and supplies have been designed and tested to meet strict safety requirements. These include safety agency evaluation and certification, and compliance with electromagnetic regulations and established environmental standards.

The safety and environment testing and performance of this product have been verified using Xerox materials only.

WARNING: Unauthorized alterations, which may include the addition of new functions or connection of external devices, may impact the product certification. Please contact your Xerox representative for more information.

MARKS AND LABELS

Symbols

	WARNING	This symbol alerts users to areas of the equipment where there is the possibility of personal injury.
	WARNING	This symbol alerts users to areas of the equipment where there are heated or hot surfaces, which should not be touched.
	CAUTION	This symbol alerts users to areas of the equipment which require special attention to avoid the possibility of personal injury or damage to the equipment.
	WARNING	This symbol indicates a Laser is being used in the equipment and alerts the user to refer to the appropriate safety information.
	NOTE	This symbol identifies information that is being emphasized and is important for you to remember.

RADIO FREQUENCY EMISSIONS

FCC Notices For The USA

NOTE: This equipment has been tested and found to comply with the limits for a Class B digital device, pursuant to Part 15 of the FCC Rules. These limits are designed to provide reasonable protection against harmful interference in a residential installation. This equipment generates, uses and can radiate radio frequency energy and, if not installed and used in accordance with the instructions, may cause harmful interference to radio communications. However, there is no guarantee that interference will not occur in a particular installation. If this equipment does cause harmful interference to radio or television reception, which can be determined by turning the equipment off and on, the user is encouraged to try to correct the interference by one or more of the following measures:

- Reorient or relocate the receiving antenna.
- Increase the separation between the equipment and receiver.
- Connect the equipment into an outlet on a circuit different from that to which the receiver is connected.
- Consult the dealer or an experienced radio/TV technician for help.

Changes or modifications to this equipment not specifically approved by the Xerox Corporation may void the user's authority to operate this equipment.

EME Compliance for Canada

This Class "B" digital apparatus complies with Canadian ICES-003.

Cet appareil numérique de la classe « B » est conforme à la norme NMB-003 du Canada.

LASER SAFETY INTRODUCTION

Laser Safety



CAUTION: Use of controls, adjustments, or performance of procedures other than those specified in this guide may result in hazardous light exposure.

This equipment complies with international safety standards and is classified as a Class 1 Laser Product.

With specific reference to lasers, the equipment complies with laser product performance standards set by governmental, national, and international agencies as a Class 1 Laser Product. It does not emit hazardous light, as the beam is totally enclosed during all phases of customer operation and maintenance.

OPERATIONAL SAFETY INFORMATION

Operational Safety Information

Your Xerox equipment and supplies have been designed and tested to meet strict safety requirements. These include safety agency examination, approval, and compliance with established environmental standards.

To ensure the continued safe operation of your Xerox equipment, follow these safety guidelines at all times:

Do These

- Always follow all warnings and instructions that are marked on or supplied with the equipment.
- Before cleaning this product, unplug the product from the electrical outlet. Always use materials specifically designated for this product, the use of other materials may result in poor performance and create a hazardous situation.
- Do not use aerosol cleaners, they may be explosive and flammable under certain conditions.
- Always exercise care when moving or relocating equipment. Please contact your local Xerox Service Department to arrange relocation of the copier to a location outside of your building.
- Always locate the machine on a solid support surface (not on plush carpet) that has adequate strength to support the weight of the machine.
- Always locate the machine in an area that has adequate ventilation and room for servicing.
- Always unplug this equipment from the electrical outlet before cleaning.

NOTE: Your Xerox machine is equipped with an energy saving device to conserve power when the machine is not in use. The machine may be left on continuously.

WARNING: The metallic surfaces in the fuser area may be hot. Please use caution when removing paper jams from this area and avoid touching any metallic surfaces.

Do Not Do These

- Never use a ground adapter plug to connect the equipment to a power outlet that lacks a ground connection terminal.
- Never attempt any maintenance function that is not specifically described in this documentation.
- Never obstruct ventilation openings. They are provided to prevent overheating.
- Never remove covers or guards that are fastened with screws. There are no operator serviceable areas within these covers.
- Never locate the machine near a radiator or any other heat source.
- Never push objects of any kind into the ventilation openings.
- Never override or "cheat" any of the electrical or mechanical interlock devices.
- Never place this equipment where people might step on or trip on the power cord.
- This equipment should not be placed in a room unless proper ventilation is provided. Please contact your local Authorized dealer for further information.

Warning - Electrical Safety Information

1. The power receptacle for the machine must meet the requirements stated on the data plate on the rear of the machine. If you are not sure that your electrical supply meets the requirements, please consult your local power company or an electrician for advice.
2. The socket outlet shall be installed near the equipment and shall be easily accessible.
3. Use the power cable that is supplied with your machine. Do not use an extension cord or remove or modify the power cord plug.
4. Plug the power cable directly into a correctly grounded electrical outlet. If you are not sure whether or not an outlet is correctly grounded, consult an electrician.

5. Do not use an adapter to connect any Xerox equipment to an electrical outlet that lacks a ground connection terminal.
6. Do not place this equipment where people might step or trip on the power cable.
7. Do not place objects on the power cable.
8. Do not override or disable electrical or mechanical interlock devices.
9. Do not push objects into slots or openings on the machine. Electrical shock or fire may result.
10. Do not obstruct ventilation openings. These openings are used to provide proper cooling to the Xerox machine.
11. **Disconnect Device:** The power cable is the disconnect device for this equipment. It is attached to the back of the machine as a plug-in device. To remove all electrical power from the machine, disconnect the power cable from the electrical outlet.

Electrical Supply

1. This product shall be operated from the type of electrical supply indicated on the product's data plate label. If you are not sure that your electrical supply meets the requirements, please consult your local power company for advice.
2.  **WARNING:** This equipment must be connected to a protective earth circuit. This equipment is supplied with a plug that has a protective earth pin. This plug will only fit into an earthed electrical outlet. This is a safety feature. If you are unable to insert the plug into the outlet, contact your electrician to replace the outlet.
3. Always connect equipment to a correctly grounded power outlet. If in doubt, have the outlet checked by a qualified electrician.

Disconnect Device

The power cable is the disconnect device for this equipment. It is attached to the back of the machine as a plug-in device. To remove all electrical power from the equipment, disconnect the power cable from the electrical outlet.

Emergency Power Off

If any of the following conditions occur, turn off the machine immediately and **disconnect the power cable(s) from the electrical outlet(s)**.

Contact an authorized Xerox Service Representative to correct the problem:

- The equipment emits unusual odors or makes unusual noises.
- The power cable is damaged or frayed.
- A wall panel circuit breaker, fuse, or other safety device has been tripped.
- Liquid is spilled into the machine.
- The machine is exposed to water.
- Any part of the machine is damaged.

Ozone Information

This product produces ozone during normal operation. The ozone produced is heavier than air and is dependent on copy volume. Install the system in a well-ventilated room. Providing the correct environmental parameters will ensure that the concentration levels meet safe limits.

If you need additional information about ozone, please request the Xerox publication **Facts About Ozone** (part number 610P64653) by calling 1-800-828-6571 in the United States and Canada. In other markets, please contact your local Xerox representative.

MAINTENANCE INFORMATION

1. Any operator product maintenance procedures will be described in the customer documentation supplied with the product.
2. Do not carry out any maintenance on this product which is not described in the customer documentation.
3. Do not use aerosol cleaners. The use of cleaners that are not approved may cause poor performance of the equipment, and could cause a dangerous condition.
4. Use supplies and cleaning materials only as directed in this manual.
5. Do not remove covers or guards that are fastened with screws. There are no parts behind these covers that you can maintain or service.
6. Do not perform any maintenance procedures unless you have been trained to do them by an authorized local dealer or unless a procedure is specifically described in the user manuals.

Consumables Information

1. Store all consumables in accordance with the instructions given on the package or container.
2. Keep all consumables away from the reach of children.
3. Never throw toner, print cartridges or toner containers into an open flame.

PRODUCT SAFETY CERTIFICATION

This product is certified by the following Agency using the Safety standards listed;

Agency	Standard
Underwriters Laboratory Inc.	UL60950-1 1st (2003) First Edition (USA/ Canada)
Intertek ETL Semko	IEC60950-1: 2001 First Edition

REGULATORY INFORMATION

Certification in Europe

CE The CE mark applied to this product, symbolizes XEROX's declaration of conformity with the following applicable European Union Directives, as of the dates indicated:

December 12, 2006: Council Directive 2006/95/EC as amended. Approximation of the laws of the member states related to low voltage equipment.

December 15, 2004: Council Directive 2004/108/EC as amended. Approximation of the laws of the member states related to electromagnetic compatibility.

A full declaration of conformity, defining the relevant directives and referenced standards, can be obtained from your XEROX Limited representative or by contacting:

Environment, Health and Safety

Xerox Limited

Bessemer Road

Welwyn Garden City

Herts

AL7 1BU

England, Telephone +44 (0) 1707 353434

WARNING: In order to allow this equipment to operate in proximity to Industrial, Scientific and Medical (ISM) equipment, the external radiation from the ISM equipment may have to be limited or special mitigation measures taken.

WARNING: Shielded interface cables must be used with this product to maintain compliance with Council Directive 2004/108/EC.

PRODUCT RECYCLING & DISPOSAL

USA & Canada

Xerox operates a worldwide equipment take back and reuse/recycle program. Contact your Xerox sales representative (1-800-ASK-XEROX) to determine whether this Xerox product is part of the program. For more information about Xerox environmental programs, visit www.xerox.com/environment.html.

If your product is not part of the Xerox program and you are managing its disposal, please note that the product may contain lead and other materials whose disposal may be regulated due to environmental considerations. For recycling and disposal information, contact your local authorities. In the United States, you may also refer to the Electronic Industries Alliance web site: www.eiae.org.

European Union

WEEE Directive 2002/96/EC

Some equipment may be used in both a domestic/household and a professional/business application.



Professional/Business Environment

Application of this symbol on your equipment is confirmation that you must dispose of this equipment in compliance with agreed national procedures. In accordance with European legislation, end of life electrical and electronic equipment subject to disposal must be managed within agreed procedures.



Domestic/Household Environment

Application of this symbol on your equipment is confirmation that you should not dispose of the equipment in the normal household waste stream. In accordance with European legislation, end of life electrical and electronic equipment subject to disposal must be segregated from household waste.

Private households within EU member states may return used electrical and electronic equipment to designated collection facilities free of charge. Please In some member states, when you purchase new equipment, your local retailer may be required to take back your old equipment free of charge. Please ask your retailer for information. Prior to disposal, please contact your local dealer or Xerox representative for end of life takeback information.

EH&S CONTACT INFORMATION

Contact Information

For more information on Environment, Health, and Safety in relation to this Xerox product and supplies, please contact the following customer help lines:

USA:1-800 828-6571

Canada:1-800 828-6571

Europe:+44 1707 353 434

about this user guide

This user guide provides information about basic understanding of the machine as well as detailed explanation on each step during actual usage. Valuable for both novice and professional users can refer to this as a guide for installing and using the machine.



-  Read the safety information before using the machine.
- If you have a problem using the machine, refer to the troubleshooting chapter. (See "Troubleshooting" on page 52.)
- Terms used in this user guide are explained in the glossary chapter. (See "Glossary" on page 67.)
- Use Index to find information.
- All illustrations in this user guide may differ from your machine depending on its options or models.
- The procedures in this user guide are mainly based on Windows XP.

CONVENTION

Some terms in this guide are used interchangeably, as below:

- Document is synonymous with original.
- Paper is synonymous with media, or print media.
- Machine refers to printer or MFP.

The following table offers the conventions of this guide:

CONVENTION	DESCRIPTION	EXAMPLE
Bold	For texts on the display or button names on the machine.	Cancel
Note	Provides additional information or detailed specification of the machine function and feature.	 The date format may differ from country to country.
Caution	Gives users information to protect the machine from possible mechanical damage or malfunction.	 Do not touch the green underside of the toner cartridge.
Footnote	Provides additional more detailed information on certain words or a phrase.	a. pages per minute
(“Cross-reference”)	Guides users to a reference page for the additional detailed information.	(See "Finding more information" on page 13.)

FINDING MORE INFORMATION

You can find information for setting up and using your machine from the following resources, either as a print-out or on screen.

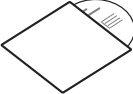
MATERIAL NAME	DESCRIPTION
Quick Install Guide 	This guide provides information on setting up your machine and this requires that you follow the instructions in the guide to prepare the machine.
User guide 	This guide provides you with step-by-step instructions for using your machine's full features, and contains information for maintaining your machine, troubleshooting, and installing accessories.
Network Website	If you have network model, you can set the network environment from your computer using network-managing programs, such as SetIP, CentreWare IS, etc. This Website will be convenient for network administrators who need to manage many machines simultaneously. SetIP program is provided in the software CD.
Machine Driver Help	This help provides you with help information on printer driver and instructions for setting up the options for printing. (See "Using help" on page 38.)
Xerox website	If you have Internet access, you can get help, support, machine drivers, latest software and firmware versions, manuals and order information from the Xerox website, www.xerox.com/office/support .

features of your new product

Your new machine is equipped with a number of special features that improve the quality of the documents you print.

SPECIAL FEATURES

Print with excellent quality and speed



- You can print with a resolution of up to 1,200 x 600 dpi (Phaser 3140, Phaser 3155) and up to 1,200 x 1,200 dpi (Phaser 3160B, Phaser 3160N) effective output.
- Phaser 3140 prints up to 18 ppm, A4-sized paper or up to 19 ppm, letter sized paper. Phaser 3155, Phaser 3160B and Phaser 3160N prints up to 24 ppm, A4-sized paper and letter-sized paper.

Handle many different types of printable material

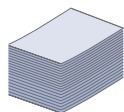

- Manual tray supports plain paper in various sizes, letterhead, envelopes, labels, custom-sized media, postcards, and heavy paper.
- The 250-sheet tray supports plain paper.

Create professional documents (Windows only)

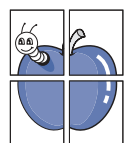

- Print Watermarks. You can customize your documents with words, such as "CONFIDENTIAL". (See "Using watermarks" on page 40.)
- Print Posters. The text and pictures of each page of your document are magnified and printed across the sheet of paper and can then be taped together to form a poster. (See "Printing posters" on page 39.)
- You can use preprinted forms and letterhead with plain paper. (See "Using overlay" on page 40.)

Save time and money

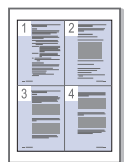

- To save paper, you can print multiple pages on one single sheet of paper. (See "Printing multiple pages on one sheet of paper" on page 38.)
- This machine automatically conserves electricity by substantially reducing power consumption when not in use.
- To save paper, you can print on both sides of the paper (Manual). (See "Printing on both sides of paper (Manual)" on page 39.)

Print in various environments



- You can print with Windows 2000 and Windows XP/2003/2008/Vista as well as Linux and Macintosh systems.
- Your machine is equipped with a USB interface.
- The Phaser 3160N comes with a built-in Network interface, 10/100 Base TX.

IPv6



This machine supports IPv6. (Phaser 3160N only)

FEATURES BY MODELS

The machine is designed to support all of your document needs from printing to more advanced networking solutions for your business.

Features by models include:

FEATURES		Phaser 3140	Phaser 3155	Phaser 3160B	Phaser 3160N
Hi-Speed USB 2.0		○ ^a	●	●	●
Network Interface Ethernet 10/100 Base TX wired LAN					●
Duplex (2-sided) printing (Manual)		●	●	●	●
Effective resolution	1,200 x 600 (dpi)	●	●		
	1,200 x 1,200 (dpi)			●	●
Print speed	up to 19 ppm	●			
	up to 24 ppm		●	●	●

a.USB 1.1

(●: Included, Blank: Not available)

introduction

This chapter gives you an overview of your machine:

This chapter includes:

- Machine overview
- Control panel overview
- Understanding the control panel

MACHINE OVERVIEW

Front view

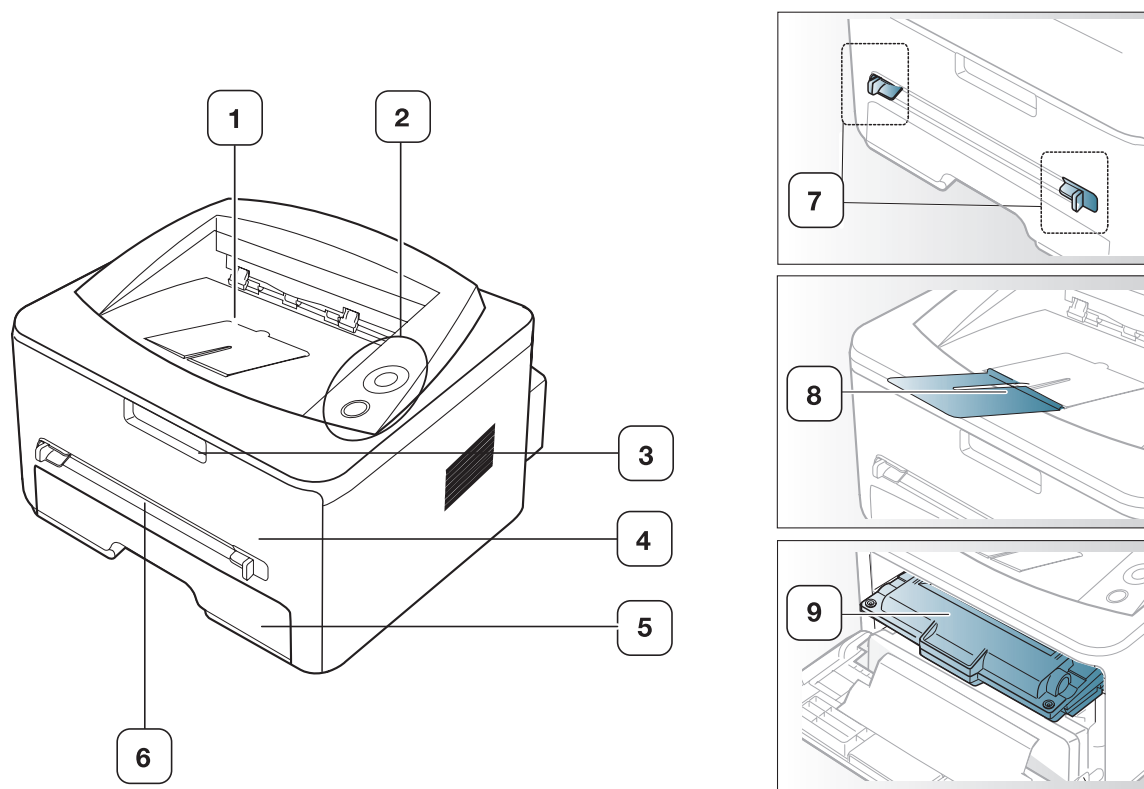

This illustration may differ from your machine depending on its model.

1 Document output tray	6 Manual feeder
2 Control panel	7 Manual feeder guide
3 Front cover handle	8 Output support
4 Front cover	9 Toner cartridge
5 Tray 1	

Rear view

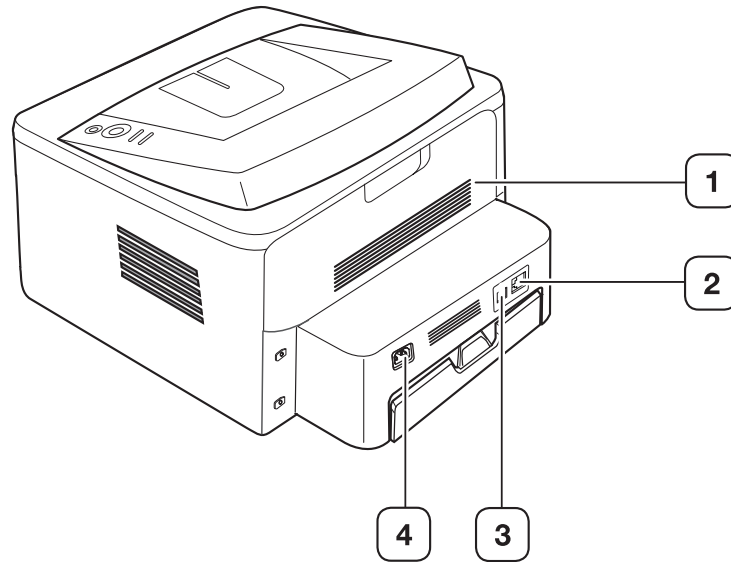

This illustration may differ from your machine depending on its model.

1	Rear cover	3	USB port
2	Network Port ^a	4	Power receptacle

a. Phaser 3160N only.

CONTROL PANEL OVERVIEW

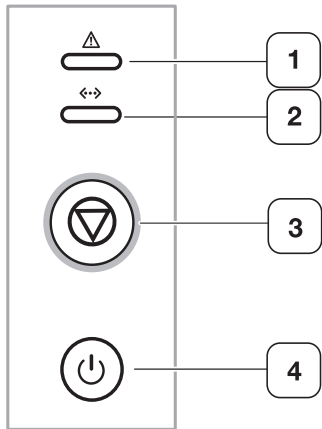



1		Error	Shows the status of your machine. (See "LEDs" on page 19.)
2		Online	Shows the status of your machine. (See "LEDs" on page 19.)
3		Cancel	Stops an operation at any time and there are more functions. (See "Understanding the control panel" on page 19.)
4		Power	You can turn the power on and off with this button. (See "Understanding the control panel" on page 19.)

UNDERSTANDING THE CONTROL PANEL

LEDs

The color of the LEDs indicates the machine's current status.

LED	STATUS		DESCRIPTION
Error 	Red	On <ul style="list-style-type: none"> The cover is opened. Close the cover. There is no paper in the tray. Load paper in the tray. The machine has stopped due to a major error. Your system has some problems. If this problem occurs, contact your service representative. A toner cartridge has reached its estimated cartridge life^a(See "Replacing the toner cartridge" on page 62.) 	
		Blinking <ul style="list-style-type: none"> A minor error has occurred and the machine is waiting for the error to be cleared. When the problem is cleared, the machine resumes. Small amount of toner is left in the cartridge. The estimated cartridge life of toner is close. Order a new cartridge for replacement. You may temporarily increase the printing quality by redistributing the toner. (See "Redistributing toner" on page 52.) 	
	Orange	On	A paper jam has occurred. (See "Clearing paper jams" on page 53.)
Online 	Green	On	The machine is on-line and can receive data from the computer.
		Blinking <ul style="list-style-type: none"> When the backlight slowly blinks, the machine is receiving data from the computer. When the backlight blinks rapidly, the machine is printing data. 	

a. Estimated cartridge life means the expected or estimated toner cartridge life, which indicates the average capacity of print-outs and is designed pursuant to ISO/IEC 19752. The number of pages may be affected by operating environment, printing interval, media type, and media size. Some amount of toner may remain in the cartridge even when red LED turned on and the printer stops printing.



 Xerox does not recommend using non-genuine Xerox toner cartridge such as refilled or remanufactured. Xerox cannot guarantee non-genuine Xerox toner cartridge's quality. Service or repair required as a result of using non-genuine Xerox toner cartridges will not be covered under the machine warranty.

 If the problem persists, call for service.

Button

 (Cancel button)

By pressing the  (cancel button), you can:

FUNCTION	DESCRIPTION
Printing demo page^a	In Ready mode, press and hold this button for about 2 seconds until the status LED blinks slowly, and release. (See "Printing a demo page" on page 20.)
Printing configuration sheet^b	In Ready mode, press and hold this button for about 7 seconds until the status LED blinks fast, and release. (See "Printing a machine report" on page 50.)
Printing a cleaning sheet^b	In Ready mode, press and hold this button for about 10 seconds until the status LED blinks slow, and release. (See "Cleaning the inside" on page 50.)
Cancel print job	Press  (cancel button) during printing. The red LED blinks while the print job is cleared from both the machine and the computer and then the machine returns to ready mode. This may take some time depending on the size of the print job.
Manual print	Press  (cancel button) each time you load a sheet of paper in the manual tray when you select Manual Feeder for Source from your software application.

a. When you print the demo page for Phaser 3140 and Phaser 3155, configuration information is included on the same page.

b. Phaser 3160B and Phaser 3160N only

 (Power button)

This button must be used to turn the machine on/off. When the machine is not in use, it will automatically enter power save mode. (See "Using power saving feature" on page 31.)

Turning on the machine

1. Plug in the power cord.
2. Press  (power) on the control panel.

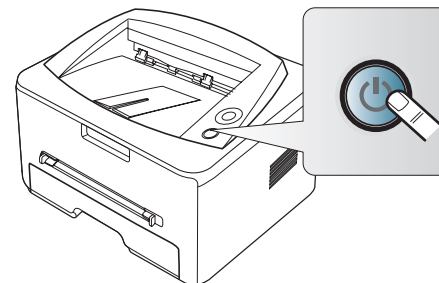

getting started

This chapter gives you step-by-step instructions for setting up the USB connected machine and software.

This chapter includes:

- Setting up the hardware
- Printing a demo page
- Supplied software
- System requirements
- Installing driver for USB connected machine
- Sharing your machine locally

SETTING UP THE HARDWARE

This section shows the steps to set up the hardware, as is explained in the Quick Install Guide. Make sure you read the Quick Install Guide first and follow the steps below:

1. Select a stable location.

Select a level, stable place with adequate space for air circulation. Allow extra space to open covers and trays.

The area should be well ventilated and away from direct sunlight or sources of heat, cold, and humidity. Do not set the machine close to the edge of your desk or table.

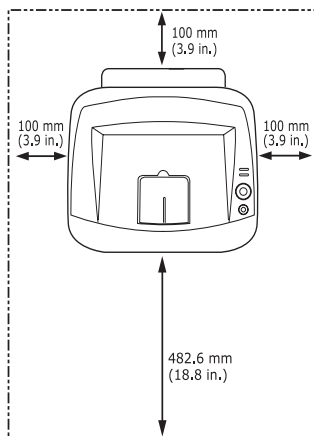

Printing is suitable for altitudes under 1,000 m (3,281 ft). Refer to the altitude setting to optimize your printing. (See "Altitude adjustment" on page 30.)

Place the machine on a flat, stable surface so that there is no incline greater than 2 mm (0.08 inch). Otherwise, printing quality may be affected.

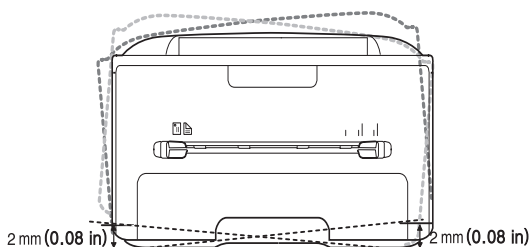

2. Unpack the machine and check all the enclosed items.
3. Remove tape holding the paper tray.

4. Remove the toner sealing strip.

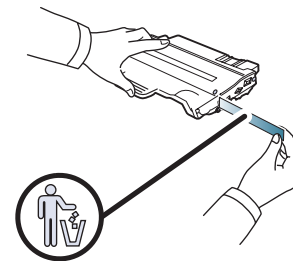

5. Install the toner cartridge.
6. Load paper. (See "Loading paper in the tray" on page 33.)
7. Make sure that all cables are connected to the machine.
8. Turn the machine on by pressing the ⏻ (power button).

! This equipment will be inoperable when the main power fails.

PRINTING A DEMO PAGE

Print a demo page to make sure that the machine is operating correctly.

To print a demo page:

In ready mode, press and hold the ⏻ (cancel button) for about 2 seconds, then release.

SUPPLIED SOFTWARE

After you have set up your machine and connected it to your computer, you must install the printer software using the supplied CD. The software CD provides you with the following software.

OS	CONTENTS
Windows	<ul style="list-style-type: none"> • Printer driver: Use this driver to take full advantage of your machine's features. • Status Monitor: This program allows you to monitor the machine's status and alerts you when an error occurs during printing. • Printer Settings Utility (Phaser 3160B, Phaser 3160N only): This program allows you to set up printer's other options from your computer desktop. • SetIP (Phaser 3160N only): Use this program to set your machine's TCP/IP addresses.
Macintosh	<ul style="list-style-type: none"> • Printer Driver: Use this driver to take full advantage of your machine's features. • Printer Settings Utility (Phaser 3160B, Phaser 3160N only): This program allows you to set up printer's other options from your computer desktop. • SetIP (Phaser 3160N only): Use this program to set your machine's TCP/IP addresses.
Linux	<ul style="list-style-type: none"> • Unified Linux Driver: Use this driver to take full advantage of your machine's features. • Printer Settings Utility (Phaser 3160B, Phaser 3160N only): This program allows you to set up printer's other options from your computer desktop. • SetIP (Phaser 3160N only): Use this program to set your machine's TCP/IP addresses.

SYSTEM REQUIREMENTS

Before you begin, ensure that your system meets the following requirements:

Windows

Your machine supports the following Windows operating systems.

OPERATING SYSTEM	REQUIREMENT (RECOMMENDED)		
	CPU	RAM	FREE HDD SPACE
Windows 2000	Pentium II 400 MHz (Pentium III 933 MHz)	64 MB (128 MB)	600 MB
Windows XP	Pentium III 933 MHz (Pentium IV 1 GHz)	128 MB (256 MB)	1.5 GB
Windows Server 2003	Pentium III 933 MHz (Pentium IV 1 GHz)	128 MB (512 MB)	1.25 GB to 2 GB
Windows Server 2008	Pentium IV 1 GHz (Pentium IV 2 GHz)	512 MB (2048 MB)	10 GB
Windows Vista	Pentium IV 3 GHz	512 MB (1024 MB)	1.5 GB



- Internet Explorer 5.0 or higher is the minimum requirement for all Windows operating systems.
- Users who have an administrator right can install the software.
- **Windows Terminal Services** is compatible with this machine.

Macintosh

OPERATING SYSTEM	REQUIREMENTS (RECOMMENDED)		
	CPU	RAM	FREE HDD SPACE
Mac OS X 10.3 ~ 10.4	<ul style="list-style-type: none"> • Intel Processors • PowerPC G4/ G5 	<ul style="list-style-type: none"> • 128 MB for a PowerPC based Mac (512 MB) • 512 MB for a Intel-based Mac (1 GB) 	1 GB
Mac OS X 10.5	<ul style="list-style-type: none"> • Intel Processors • 867 MHz or faster Power PC G4/ G5 	512 MB (1 GB)	1 GB
Mac OS X 10.6	<ul style="list-style-type: none"> • Intel Processors 	1 GB (2 GB)	1 GB

Linux

ITEM	REQUIREMENTS
Operating system	RedHat Enterprise Linux WS 4, 5 (32/ 64 bit) Fedora Core 2~10 (32/ 64 bit) SuSE Linux 9.1 (32 bit) OpenSuSE 9.2, 9.3, 10.0, 10.1, 10.2, 10.3, 11.0, 11.1 (32/ 64 bit) Mandrake 10.0, 10.1 (32/ 64 bit) Mandriva 2005, 2006, 2007, 2008, 2009 (32/ 64 bit) Ubuntu 6.06, 6.10, 7.04, 7.10, 8.04, 8.10 (32/ 64 bit) SuSE Linux Enterprise Desktop 9, 10 (32/64 bit) Debian 3.1, 4.0, 5.0 (32/ 64 bit)
CPU	Pentium IV 2.4GHz (IntelCore2)
RAM	512 MB (1024 MB)
Free HDD space	1 GB (2GB)

INSTALLING DRIVER FOR USB CONNECTED MACHINE

A locally connected machine is a machine directly attached to your computer using the USB cable. If your machine is attached to a network, skip the following steps below and go on to installing network connected machine's driver. (See "Installing drivers for network connected machine" on page 25.)



 Only use an USB cable no longer than 3 m (118 in.).

Windows

You can install the machine software using the typical or custom method.

The following steps below are recommended for most users who use a machine directly connected to your computer. All components necessary for machine operations will be installed.

1. Make sure that the machine is connected to your computer and powered on.

 If the "Found New Hardware Wizard" window appears during the installation procedure, click  in the upper right corner of the box to close the window, or click **Cancel**.

2. Insert the supplied software CD into your CD-ROM drive.

The software CD should automatically run and an install software window appear.

3. Click **Install Software**.

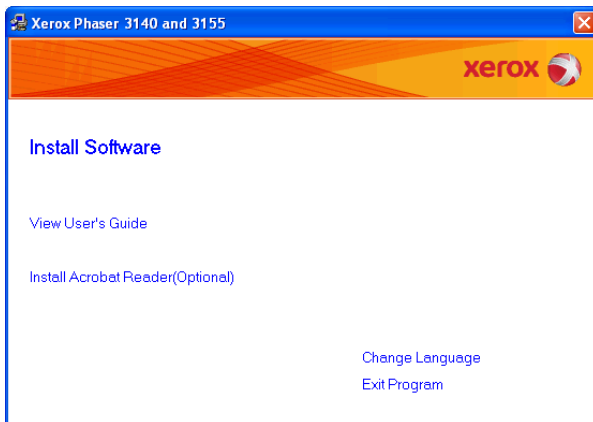



If necessary, select a language from the drop-down list.

- If the installation window does not appear, click **Start** and then **Run**. Type X:\Setup.exe, replacing "X" with the letter which represents your CD drive. Click **OK**.
 - If you use Windows Vista, click **Start** > **All programs** > **Accessories** > **Run**. Type X:\Setup.exe replacing "X" with the letter which represents your drive and click **OK**.
 - If the **AutoPlay** window appears in Windows Vista, click **Run Setup.exe** in **Install or run program** field, and click **Continue** in the **User Account Control** windows.
4. Select **Typical** installation for a local printer. Then, click **Next**.

 The **Custom** allows you to select the machine's connection and choose individual component to install. Follow the guide on the

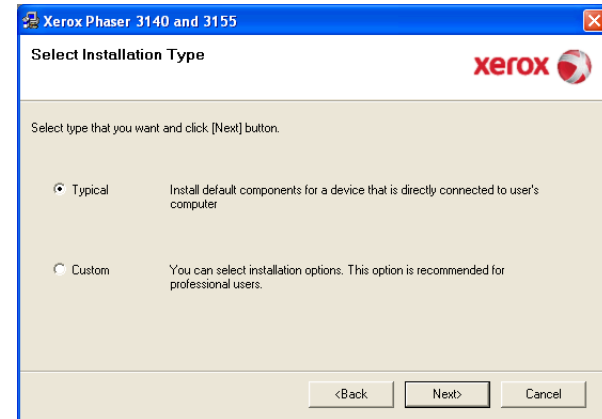
window.



 If your machine is not connected to the computer, the following window will appear.

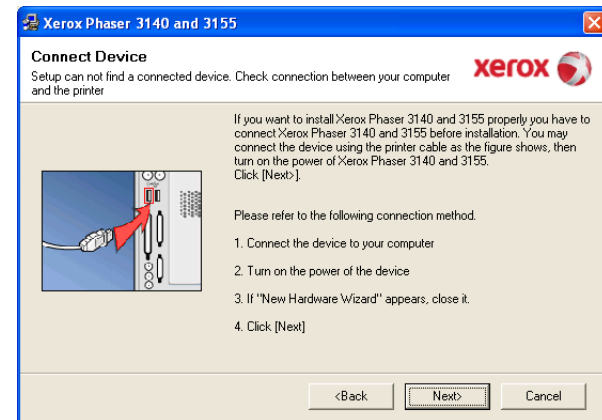

- After connecting the machine, click **Next**.
- If you don't want to connect the printer at this time, click **Next**, and **No** on the following screen. Then the installation will start and a test page will not be printed at the end of the installation.
- The installation window in this user guide may differ depending on the machine and interface in use.

5. After the installation is finished, a window asking you to print a test page appears. If you choose to print a test page, select the checkbox and click **Next**.

Otherwise, just click **Next** and skip to step 7

6. If the test page prints out correctly, click **Yes**. If not, click **No** to reprint it.

7. Click **Finish**.

 If the printer driver does not work properly, follow the steps below to repair or reinstall the driver.

- a) Make sure that the machine is connected to your machine and powered on.
- b) From the **Start** menu, select **Programs** or **All Programs** > **your printer driver name** > **Maintenance**.
- c) Select the option as you wish, follow the instruction on the window.

Macintosh

The software CD that came with your machine provides you with the PPD file that allows you to use the CUPS driver or Apple LaserWriter driver for printing on a Macintosh computer.

1. Make sure that the machine is connected to your computer and powered on.
2. Insert the supplied software CD into your CD-ROM drive.
3. Double-click the CD-ROM icon that appears on your Macintosh desktop.
4. Double-click the **MAC_Installer** folder.
5. Double-click the **Installer OS X** icon.
6. Enter the password and click **OK**.
7. The Xerox Installer window opens. Click **Continue**.
8. Select **Easy Install** and click **Install**. **Easy Install** is recommended for most users. All components necessary for machine operations will be installed.
If you select **Custom Install**, you can choose individual components to install.
9. When the message which warns that all applications will close on your computer appears, click **Continue**.
10. After the installation is finished, click **Quit**.
11. Open the **Applications** folder > **Utilities** > **Print Setup Utility**.
 - For Mac OS X 10.5~10.6, open the **Applications** folder > **System Preferences** and click **Print & Fax**.
12. Click **Add** on the **Printer List**.
 - For Mac OS X 10.5~10.6, click the "+" icon; a display window will pop up.
13. For Mac OS X 10.3, select the **USB** tab.
 - For Mac OS X 10.4, click **Default Browser** and find the USB connection.
 - For Mac OS X 10.5~10.6, click **Default** and find the USB connection.
14. For Mac OS X 10.3, if Auto Select does not work properly, select **Xerox** in **Printer Model** and your machine name in **Model Name**.
 - For Mac OS X 10.4, if Auto Select does not work properly, select **Xerox** in **Print Using** and your machine name in **Model**.
 - For Mac OS X 10.5~10.6, if Auto Select does not work properly, select **Select a driver to use...** and your machine name in **Print Using**.

Your machine appears on the **Printer List**, and is set as the default machine.

15. Click **Add**.

If the printer driver does not work properly, uninstall the driver and reinstall it.

Follow steps below to uninstall the driver for Macintosh.

- a) Make sure that the machine is connected to your computer and powered on.
- b) Insert the supplied software CD into your CD-ROM drive.
- c) Double-click CD-ROM icon that appears on your Macintosh desktop.
- d) Double-click the **MAC_Installer** folder.
- e) Double-click the **Installer OS X** icon.
- f) Enter the password and click **OK**.
- g) The Xerox Installer window opens. Click **Continue**.
- h) Select **Uninstall** and click **Uninstall**.
- i) When the message which warns that all applications will close on your computer appears, Click **Continue**.
- j) When the uninstall is done, click **Quit**.

Linux

Follow the steps below to install the driver for Linux. While installing the driver, the Unified Linux Driver package will automatically be installed as well.

The supplied software CD provides you with the Unified Linux Driver package for using your machine with a Linux computer easily in UI based management tool. (See "Using the Unified Linux Driver Configurator" on page 48.)

1. Make sure that the machine is connected to your computer and powered on.
2. When the **Administrator Login** window appears, type in root in the **Login** field and enter the system password.

You must log in as a super user (root) to install the machine software. If you are not a super user, ask your system administrator.

3. Insert the supplied software CD into your CD-ROM drive.
The software CD will run automatically.

If the software CD does not run automatically, click the  icon at the bottom of the desktop. When the Terminal screen appears, type in the following:

If the software CD is secondary master and the location to mount is /mnt/cdrom,

```
[root@localhost root]#mount -t iso9660 /dev/hdc /mnt/cdrom
```

```
[root@localhost root]#cd /mnt/cdrom/Linux
```

```
[root@localhost Linux]#./install.sh
```

If you still failed to run the software CD type the followings in sequence:

```
[root@localhost root]#umount /dev/hdc
```

```
[root@localhost root]#mount -t iso9660 /dev/hdc /mnt/cdrom
```

The installation program runs automatically if you have an autorun software package installed and configured.

4. When the welcome screen appears, click **Next**.

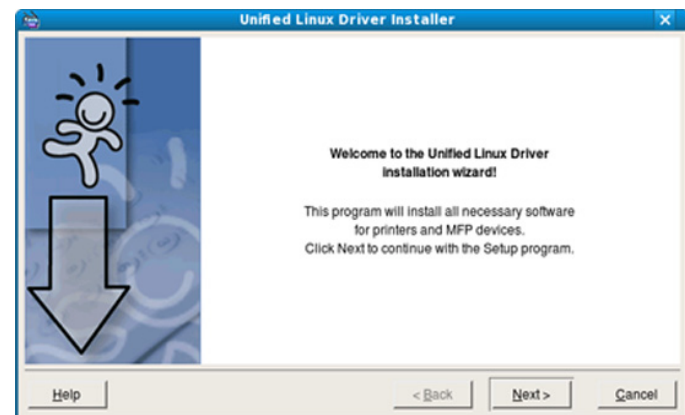

5. When the installation is complete, click **Finish**.

The installation program has added the Unified Driver Configurator desktop icon and the Unified Driver group to the system menu for your convenience. If you have any difficulties, consult the on screen help that is available through your system menu or can otherwise be called from the driver package Windows applications, such as **Unified Driver Configurator** or **Image Manager**.

Installing the driver in the text mode:

- If you do not use the graphical interface or have been unable to

install the driver, you have to use the driver in the text mode.

- Follow the steps 1 to 3, then type [root@localhost Linux]# ./install.sh. Follow the instructions on the terminal screen. The installation is completed.
- When you want to uninstall the driver, follow the installation instructions above, but type [root@localhost Linux]# ./uninstall.sh on the terminal screen.



If the printer driver does not work properly, uninstall the driver and reinstall it.

Follow the steps below steps to uninstall the driver for Linux.

- a) Make sure that the machine is connected to your computer and powered on.
- b) When the **Administrator Login** window appears, type in "root" in the **Login** field and enter the system password.
You must log in as a super user (root) to uninstall the printer driver. If you are not a super user, ask your system administrator.
- c) Insert the supplied software CD into your CD-ROM drive.
The software CD will run automatically.
If the software CD does not run automatically, click the  icon at the bottom of the desktop. When the Terminal screen appears, type in:
If the software CD is secondary master and the location to mount is /mnt/cdrom,
[root@localhost root]#mount -t iso9660 /dev/hdc /mnt/cdrom
[root@localhost root]#cd /mnt/cdrom/Linux
[root@localhost Linux]#./uninstall.sh
The installation program runs automatically if you have an autorun software package installed and configured.
- d) Click **Uninstall**.
- e) Click **Next**.
- f) Click **Finish**.

SHARING YOUR MACHINE LOCALLY

Follow the steps below to set up the computers to share your machine locally.

If the Host computer is directly connected to the machine with USB cable and is also connected to the local network environment, the client computer connected to the local network can use the shared machine through the host computer to print.

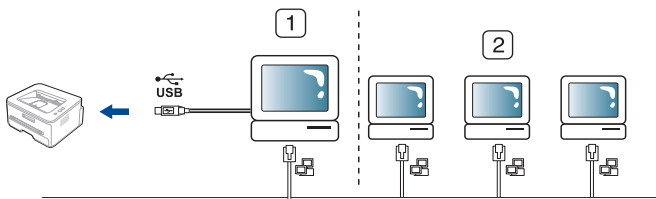

1	Host computer	A computer which is directly connected to the machine by USB cable.
2	Client computers	Computers which use the machine shared through the host computer.

Windows

Setting up a host computer

1. Click the Windows **Start** menu.
2. For Windows 2000, select **Settings > Printers** .
 - For Windows XP/2003 select **Control Panel > Printers and Faxes**.
 - For Windows 2008/Vista select **Control Panel > Hardware and Sound > Printers**.
3. Double-click your printer driver icon.
4. From the **Printer** menu, select **Sharing...**
5. Check the **Share this printer**.
6. Fill in the **Shared Name** field. Click **OK**.

Setting up a client computer

1. Click the Windows **Start** menu.
2. Select **All programs > Accessories > Windows Explorer**.
3. Enter the IP address of the host computer in the address bar and press Enter in your keyboard.



In case host computer requires **User name** and **Password**, fill in User ID and password of the host computer account.

4. Right click the printer icon you want to share and select **Connect**.
5. If a set up complete message appears, click **OK**.
6. Open the file you want to print and start printing.

Macintosh



The following steps are for Mac OS X 10.5~10.6. Refer to Mac Help for other OS versions.

Setting up a host computer

1. Install your printer driver. (See "Macintosh" on page 23.)
2. Open the **Applications** folder > **System Preferences** and click **Print & Fax**.
3. Select the printer to share in the **Printers list**.
4. Select **Share this printer**.

Setting up a client computer

1. Install your printer driver. (See "Macintosh" on page 23.)
2. Open the **Applications** folder > **System Preferences** and click **Print & Fax**.
3. Click the "+" icon.
A display window showing the name of your shared printer appears.
4. Select your machine and click **Add**.

network setup (phaser 3160n only)

This chapter gives you step-by-step instructions for setting up the network connected machine and software.

This chapter includes:

- Network environment
- Introducing useful network programs
- Installing drivers for network connected machine
- Using a wired network
- IPv6 Configuration

NETWORK ENVIRONMENT

You need to set up the network protocols on the machine to use it as your network machine.

The following table shows the network environments supported by the machine:

ITEM	REQUIREMENTS
Network interface	Ethernet 10/100 Base-TX
Network operating system	<ul style="list-style-type: none">• Windows 2000/XP/2003/2008/Vista• Various Linux OS• Mac OS X 10.3 ~ 10.6
Network protocols	<ul style="list-style-type: none">• TCP/IPv4• DHCP, BOOTP, Static• DNS, WINS, Bonjour, SLP, UPnP• Standard TCP/IP Printing (RAW), LPR, IPP• SNMPv 1/2/3, HTTP, IPSec• TCP/IPv6 (DHCP, DNS, RAW, LPR, SNMPv 1/2/3, HTTP, IPSec) (See "IPv6 Configuration" on page 29.)

INTRODUCING USEFUL NETWORK PROGRAMS

There are several programs available to setup the network settings easily in network environment. For the network administrator especially, managing several machines on the network is possible.

 Before using the programs below, set the IP address first.

CentreWare IS (Phaser 3160N only)

Web server embedded on your network machine, which allows you to:

- Configure the network parameters necessary for the machine to connect to various network environments.
- Customize machine settings.
(See "Using CentreWare IS (Phaser 3160N only)" on page 46.)

SetIP

This utility program allows you to select a network interface and manually configure the IP addresses for use with the TCP/IP protocol. (See "IP setting using SetIP Program (Windows)" on page 27, "IP setting using SetIP Program (Macintosh)" on page 28 or "IP setting using SetIP Program (Linux)" on page 28.)

 TCP/IPv6 is not supported by this program.

INSTALLING DRIVERS FOR NETWORK CONNECTED MACHINE

Windows

You can set up the machine network driver, following the steps below.

This is recommended for most users. All components necessary for machine operations will be installed.

1. Make sure that the machine is connected to the network and powered on. The green indicator light should be on.
2. Insert the supplied software CD into your CD-ROM drive.
The software CD should automatically run and an install software window appear.
3. Click on **Install Software**.

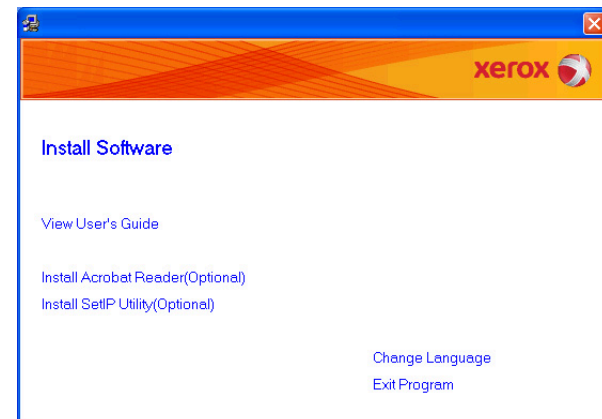

If necessary, select a language from the drop-down list.

- If the installation window does not appear, click **Start** and then **Run**. Type X:\Setup.exe, replacing "X" with the letter which represents your drive. Click **OK**.
- If you use Windows Vista, click **Start > All programs > Accessories > Run**. Type X:\Setup.exe replacing "X" with the letter which represents your drive and click **OK**.

- If the **AutoPlay** window appears in Windows Vista, click **Run Setup.exe** in **Install or run program** field, and click **Continue** in the **User Account Control** windows.

4. Select **Typical installation for a network printer**. Then, click **Next**.

-  The Custom Installation allows you to select the machine's connection and choose individual component to install. Follow the guide on the window.

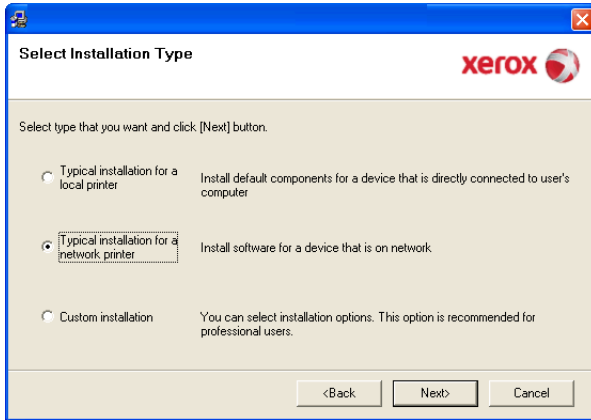

5. The list of printers available on the network appears. Select the printer you want to install from the list and then click **Next**.

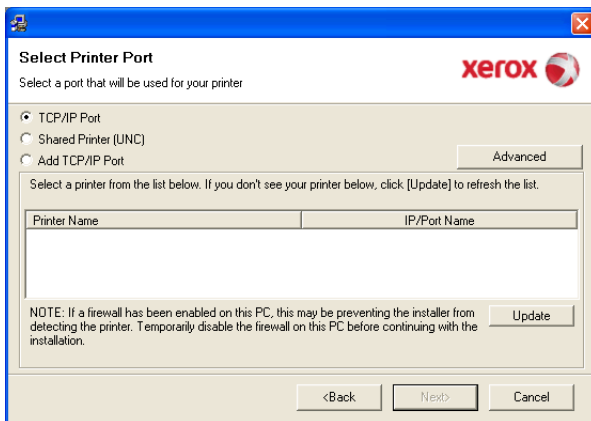

- If you do not see your printer on the list, click **Update** to refresh the list, or select **Add TCP/IP Port** to add your printer to the network. To add the printer to the network, enter the port name and the IP address for the printer.
- To verify your printer's IP address, print a Network Configuration page. (By pressing the Ⓞ (cancel button) for about 7 seconds, then release. (Example IP Address is 13.121.52.104)
- To find a shared network printer (UNC Path), select **Shared Printer [UNC]** and enter the shared name manually or find a shared printer by clicking the **Browse** button.

-  If you cannot find your machine in network, please turn off the firewall and click **Update**.

For Windows operating system, **Start > Control Panel** and start windows firewall, and set this option unactivated. For other operating system, refer to its on-line guide.

6. After the installation is finished, click **Finish**. If you choose to print a test page, select the checkbox.
7. If the test page prints out correctly, click **Yes**.
If not, click **No** to reprint it.

8. Click **Finish**.

-  • After the driver setup, you may enable firewalls.
- If your printer driver doesn't work properly after setup has been completed, repair or reinstall the printer driver. (See "Installing driver for USB connected machine" on page 22.)

Macintosh

1. Make sure that the machine is connected to your network and powered on. Also, your machine's IP address should have been set.
2. Insert the supplied software CD into your CD-ROM drive.
3. Double-click the CD-ROM icon that appears on your Macintosh desktop.
4. Double-click the **MAC_Installer** folder.
5. Double-click the **Installer OS X** icon.
6. Enter the password and click **OK**.
7. The Xerox Installer window opens. Click **Continue**.
8. Select **Easy Install** and click **Install**. **Easy Install** is recommended for most users. All components necessary for machine operations will be installed.
 - If you select **Custom Install**, you can choose individual components to install.
9. The message which warns that all applications will close on your computer appears. Click **Continue**.
10. After the installation is finished, click **Quit**.
11. Open the **Applications** folder > **Utilities** > **Print Setup Utility**.
 - For Mac OS X 10.5~10.6, open the **Applications** folder > **System Preferences** and click **Print & Fax**.
12. Click **Add** on the **Printer List**.
 - For Mac OS X 10.5~10.6, click the "+" icon; a display window will pop up.
13. For Mac OS X 10.3, select the **IP Printing** tab.
 - For Mac OS X 10.4, click **IP Printer**.
 - For Mac OS X 10.5~10.6, click **IP**.
14. Select **Socket/HP Jet Direct** in **Printer Type**.
 -  When printing a document containing many pages, printing performance may be enhanced by choosing **Socket** for **Printer Type** option.
15. Enter the machine's IP address in the **Printer Address** field.
16. Enter the queue name in the **Queue Name** field. If you cannot determine the queue name for your machine server, try using the default queue first.
17. For Mac OS X 10.3, if Auto Select does not work properly, select **Xerox** in **Printer Model** and your machine name in **Model Name**.
 - For Mac OS X 10.4, if Auto Select does not work properly, select **Xerox** in **Print Using** and your machine name in **Model**.
 - For Mac OS X 10.5~10.6, if Auto Select does not work properly, select **Select a driver to use...** and your machine name in **Print Using**.

Your machine appears on the **Printer List**, and is set as the default machine.
18. Click **Add**.
 -  If the printer driver does not work properly, uninstall the driver and reinstall it.

Follow steps below to uninstall the driver for Macintosh.

 - a) Make sure that the machine is connected to your computer and powered on.
 - b) Insert the supplied software CD into your CD-ROM drive.

- c) Double-click CD-ROM icon that appears on your Macintosh desktop.
- d) Double-click the **MAC_Installer** folder.
- e) Double-click the **Installer OS X** icon.
- f) Enter the password and click **OK**.
- g) The Xerox Installer window opens. Click **Continue**.
- h) Select **Uninstall** and click **Uninstall**.
- i) When the message which warns that all applications will close on your computer appears, Click **Continue**.
- j) When the uninstall is done, click **Quit**.

Linux

1. Make sure that the machine is connected to your network and powered on. Also, your machine's IP address should have been set.
2. Insert the supplied software CD into your CD-ROM drive.
3. Double-click CD-ROM icon that appears on your Linux desktop.
4. Double-click the **Linux** folder.
5. Double-click the **install.sh** icon.
6. The Xerox Installer window opens. Click **Continue**.
7. The Add printer wizard window opens. Click **Next**.
8. Select Network printer and click **Search** button.
9. The Printer's IP address and model name appears on list field.
10. Select your machine and click **Next**.

USING A WIRED NETWORK

You must set up the network protocols on your machine to use it on your network. This chapter will show you how this is easily accomplished.

You can use network after connecting network cable to a corresponding port on your machine.

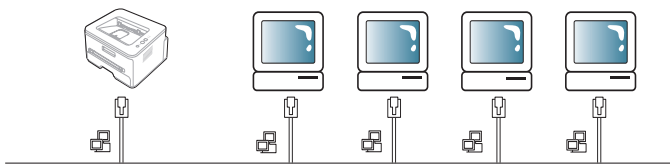

Printing network configuration report

You can print a **Network Configuration Report** from the machine's control panel that will show the current machine's network settings. This will help you to set up a network and troubleshooting problems.

To print the report:

In ready mode, press and hold the Ⓞ (cancel button) for about 7 seconds. You can find your machine's MAC address and IP address.

For example:

- IP Address : 192.0.0.192
- | | | |
|-----------------|---|-------------------|
| MAC Address | : | 00:15:99:46:0D:15 |
| IP Address | : | 192.0.0.192 |
| Subnet Mask | : | 255.255.255.0 |
| Default Getaway | : | 192.0.0.192 |

Setting IP address

First, set up an IP address for network printing and managements. In most cases a new IP address will be automatically assigned by a DHCP (Dynamic Host Configuration Protocol) server located on the network.

In a few situations the IP address must be set manually. This is called a static IP and is often required in corporate Intranets for security reasons.

- **DHCP IP assignment:** Connect your machine to the network, connect the power cord and wait a few minutes for the DHCP server to assign an IP address to the machine. Then, print the **Network Configuration Report** as explained above. If the report shows that the IP address has changed, the assignment was successful. You will see the new IP address in the report.
- **Static IP assignment:** Use SetIP program to change the IP address from your computer. (Only if you do not want to use DHCP.)

In an office environment, we recommend that you contact a network administrator to set this address for you.

IP setting using SetIP Program (Windows)

This program is for manually setting the network IP address of your machine using its MAC address to communicate with the machine. A MAC address is the hardware serial number of the network interface and can be found in the **Network Configuration Report**.

For using SetIP program, disable the computer firewall before continuing by performing the following:

1. Open **Start > All programs > Control Panel**.
2. Double click **Security Center**.
3. Click **Windows Firewall** at the bottom of the screen.
4. Disable the firewall.

Installing the program

1. Make sure that the machine is connected to your computer and powered on.
2. Insert the supplied software CD into your CD-ROM drive.
 - The software CD should automatically run and an installation window appear.
 - If the installation window does not appear, click **Start** and then **Run**. Type X:\Setup.exe, replacing "X" with the letter which represents your drive. Click **OK**.
 - If you use Windows Vista, click **Start > All programs > Accessories > Run**. Type X:\Setup.exe replacing "X" with the letter which represents your drive and click **OK**.
 - If the **AutoPlay** window appears in Windows Vista, click **Run Setup.exe** in **Install or run program** field, and click **Continue** in the **User Account Control** windows.
3. Click **Install SetIP Utility(Optional)**.
4. Click **Next > Next**.
5. Click **Finish**.

Starting the program

1. Connect your machine to the network with a network cable.
2. Turned on the machine.
3. From the Windows **Start** menu, select **All Programs > your printer driver name > SetIP > SetIP**.
4. Click on the ⚙ icon (third from left) in the SetIP window to open the TCP/IP configuration window.
5. Enter the machine's new information into the configuration window as follows. In a corporate intranet, you may need to have this information assigned by a network manager before proceeding.

- **MAC Address** : Find the machine's MAC address from the **Network Configuration Report** and enter it without the colons. For example, 00:15:99:29:51:A8 becomes 0015992951A8.
- **IP Address**: Enter a new IP address for your printer. For example, if your computer's IP address is 192.168.1.150, enter 192.168.1.X. (X is number between 1 and 254 other than the computer's address.)
- **Subnet Mask**: Enter a Subnet Mask.
- **Default Gateway**: Enter a Default Gateway.

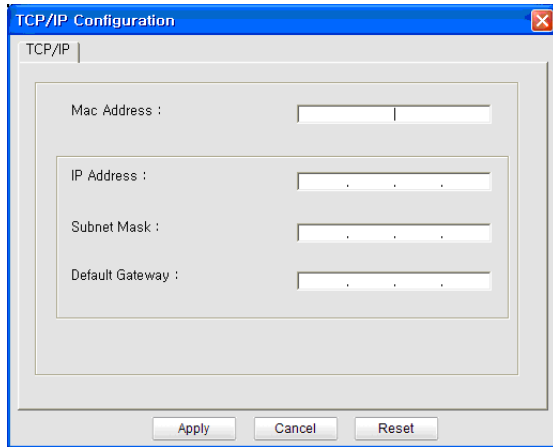

6. Click **Apply**, and then click **OK**. The machine will automatically print the **Network Configuration Report**. Confirm that all the settings are correct.
7. Click **Exit** to close the SetIP program.
8. If necessary, restart the computer's firewall.

IP setting using SetIP Program (Macintosh)

For using SetIP program, disable the computer firewall before continuing by performing the following:

1. Open **System Preferences**.
2. Click **Security**.
3. Click the **Firewall** menu.
4. Turn firewall off.

 The following instructions may vary for your model.

1. Connect your machine to the network with a network cable.
2. Insert the Installation CD-ROM, and open the disk window, select **MAC_Installer > MAC_Printer > SetIP > SetIPApplet.html**.
3. Double click the file and **Safari** will automatically open, then select **Trust**. The browser will open the **SetIPApplet.html** page that shows the printer's name and IP address information.
4. Click on the  icon (third from left) in the SetIP window to open the TCP/IP configuration window.
5. Enter the machine's new information into the configuration window as follows. In a corporate intranet, you may need to have this information assigned by a network manager before proceeding.
 - **MAC Address** : Find the machine's MAC address from the **Network Configuration Report** and enter it without the colons. For example, 00:15:99:29:51:A8 becomes 0015992951A8.
 - **IP Address**: Enter a new IP address for your printer. For example, if your computer's IP address is 192.168.1.150, enter 192.168.1.X. (X is number between 1 and 254 other than the computer's address.)

- **Subnet Mask**: Enter a Subnet Mask.
- **Default Gateway**: Enter a Default Gateway.

6. Select **Apply**, then **OK**, and **OK** again. The printer will automatically print the configuration report. Confirm that all the settings are correct. **Quit Safari**. You may close and eject the installation CD-ROM. If necessary, restart the computer's firewall. You have successfully changed the IP address, subnet mask, and gateway.

IP setting using SetIP Program (Linux)

SetIP program should be automatically installed during the printer driver installation.

1. Print the machine's network configuration report to find your machine's MAC address.
2. Open the **/opt/Xerox/mfp/share/utils/**.
3. Double click the **SetIPApplet.html** file.
4. Click to open the TCP/IP configuration window.
5. Enter the network card's MAC address, IP address, subnet mask, default gateway, and then click **Apply**.

 When you enter the MAC address, enter it without a colon(:).

6. The machine prints the network configuration report. Confirm all the settings are correct.
7. Close the SetIP program.

Network parameter setting

You can also set up the various network settings through the network administration programs such as **CentreWare IS**.

Restoring factory default settings

You may need to reset the machine to the factory default settings when machine that you are using is connected to new network environment.

Restoring factory default settings using CentreWare IS

1. Start a web browser such as Internet Explorer, Safari or Firefox and enter your machine's new IP address in the browser window.

For example,

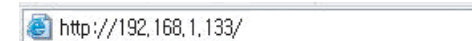

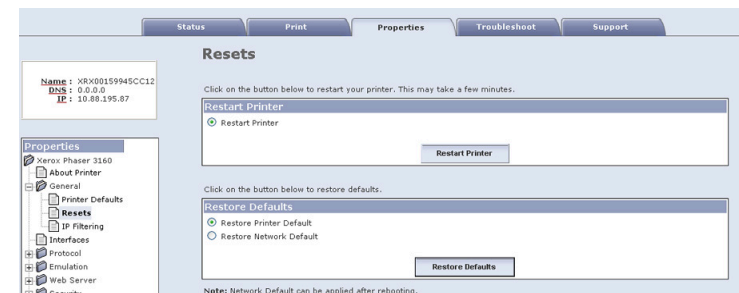

2. When the **CentreWare IS** window opens, click **Properties > General**.
3. Click **Reset**. Then, click on the button below to restore defaults.



4. Turn off and restart machine to apply settings.

IPV6 CONFIGURATION

 **TCP/IPv6** is supported properly only in Windows Vista or higher.

 If the IPv6 network seems not working, set all the network setting to the factory defaults and try again. (See "Restoring factory default settings" on page 28.)

To use the IPv6 network environment, follow the next procedure to use the IPv6 address:

The machine is provided with IPv6 feature on.

1. Connect your machine to the network with a network cable.
2. Turned on the machine.
3. Print a **Network Configuration Report** from the machine's control panel that will check IPv6 addresses.
4. For Windows 2000, select **Settings > Printers** .
 - For Windows XP/2003 select **Control Panel > Printers and Faxes**.
 - For Windows 2008/Vista select **Control Panel > Hardware and Sound > Printers**.
5. Click **Add a local printer** on the **Add Printer** windows.
 - a) Create new port.
 - b) Select type standard TCP/IP.
 - c) Enter the IPv6 address.
 - d) Follow basic instructions.
6. Follow the instruction on the window.

 If the machine does not work in the network environment, activate IPv6. Refer to the next section followed by.

Printing network configuration report

You can print a **Network Configuration Report** from the machine's control panel that will show the current machine's network settings. This will help you to set up a network and troubleshooting problems.

To print the report:

In ready mode, press and hold the  (cancel button) for about 7 seconds. You can find your machine's MAC address and IP address.

For example:

- MAC Address : 00:15:99:41:A2:78
- IP Address : 192.0.0.192

Setting IPv6 addresses

Machine supports following IPv6 addresses for network printing and managements.

- **Link-local Address:** Self-configured local IPv6 address. (Address starts with FE80.)
- **Stateless Address:** Automatically configured IPv6 address by a network router.
- **Stateful Address:** IPv6 address configured by a DHCPv6 server.
- **Manual Address:** Manually configured IPv6 address by a user.

Manual address configuration

1. Start a web browser such as Internet Explorer that supports IPv6 addressing as a URL. (See "Using CentreWare IS (Phaser 3160N only)" on page 46.)

 Address must be enclosed in '['']' brackets.

 For IPv4, enter the IPv4 address (http://xxx.xxx.xxx.xxx) in the address field and press the Enter key or click **Go**.

2. When the **CentreWare IS** window opens, click **Properties > Protocol**.
3. Click **TCP/IP**.
4. Enable the **Manual Address** in the **TCP/IPv6** section.

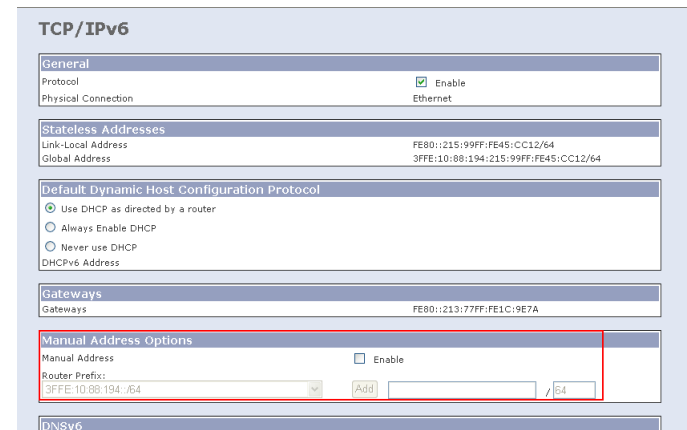

5. Select the **Router Prefix** and click the **Add** button, then the router prefix will automatically be entered into the address field. Enter the rest of address. (ex:3FFE:10:88:194::AAAA. "A" is the hexadecimal 0 through 9, A through F.)
6. Click the **Save changes** button.

Installing printer driver

Driver installation for network printer in IPv6 network environment is same as TCP/IPv4. (See "Installing drivers for network connected machine" on page 25.)

Select TCP/IP Port and when the list of machines are displayed, simply select your machine's IPv6 address.

Using CentreWare IS

1. Start a web browser such as Internet Explorer that supports IPv6 addressing as a URL .
2. Select one of the IPv6 addresses (**Link-local Address, Stateless Address, Stateful Address, Manual Address**) from **Network Configuration Report**.
3. Enter the IPv6 addresses. (ex: http://[FE80::215:99FF:FE66:7701])

basic setup

After installation is complete, you may want to set the machine's default settings. Refer to the next section if you would like to set or change values. This chapter gives you step-by-step instructions for setting up the machine.

This chapter includes:

- Altitude adjustment
- Setting the default tray and paper
- Using power saving feature
- Changing font setting (Phaser 3160B and Phaser 3160N only)

ALTITUDE ADJUSTMENT

The print quality is affected by atmospheric pressure, which is determined by the height of the machine above sea level. The following information will guide you on how to set your machine to the best print quality or best quality of print.

Before you set the altitude value, find the altitude where you are using the machine.

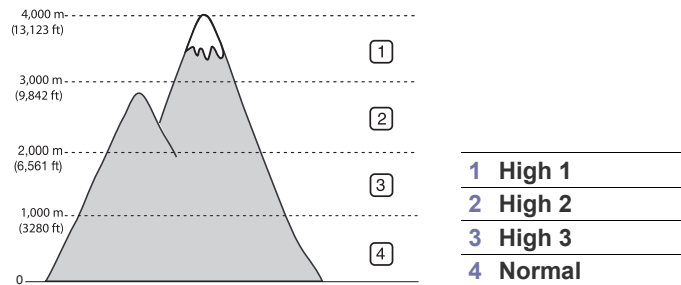

For Phaser 3140 and 3155

1. Install the driver. (See "Installing driver for USB connected machine" on page 22 or "Installing drivers for network connected machine" on page 25.)
2. Click the Windows **Start** menu.
 - For Windows 2000, select **Settings > Printers**.
 - For Windows XP/2003, select **Control Panel > Printers and Faxes**.
 - For Windows 2008/Vista, select **Control Panel > Hardware and Sound > Printers**.
3. Select the your machine's driver and right-click to open **Properties**.
4. In printer driver properties, select **Printer**.
5. Select necessary options in the **Altitude Adjustment** drop-down list.
6. Click **OK**.

For Phaser 3160B and 3160N

You can altitude adjustment in the Printer Settings Utility.

1. From the **Start** menu, select **Programs** or **All Programs >** your printer driver name **> Printer Settings Utility**.
2. Select necessary options in the **Altitude Adjustment** drop-down list.
3. Click the **Apply** button.

This can also be adjusted via CentreWare IS. (Phaser 3160N only)

SETTING THE DEFAULT TRAY AND PAPER

You can select the tray and paper you would like to keep using for printing job.

In the computer

Windows

1. Click the Windows **Start** menu.
2. For Windows 2000, select **Settings > Printers**.
 - For Windows XP/2003 select **Control Panel > Printers and Faxes**.
 - For Windows 2008/Vista select **Control Panel > Hardware and Sound > Printers**.
3. Right-click your machine and press **Printing Preferences**.
4. Click **Paper** tab.
5. Select paper options, such as size, source and type.
6. Press **OK**.

 If you want to use special-sized paper-such as a billing paper, select **Custom** in the **Paper** tab in the **Printing Preferences**. (See "Opening printing preferences" on page 38.)

Macintosh

Macintosh does not support this function. Macintosh users need to change the default setting manually each time they want to print using other settings.

1. Open a Macintosh application and select the file you want to print.
2. Open the **File** menu and click **Print**.
3. Go to **Paper Feed** pane.
4. Open the **File** menu and click **Print**.
5. Go to **Paper Feed**.
6. Set appropriate tray from which you want to print.
7. Go to **Paper** pane.
8. Set paper type to correspond to the paper loaded in the tray from which you want to print.
9. Click **Print** to print.

USING POWER SAVING FEATURE

When you are not using the machine for a while, use this feature to save power.

For Phaser 3140 and 3155

1. Install the driver. (See "Installing driver for USB connected machine" on page 22 or "Installing drivers for network connected machine" on page 25.)
2. Click the Windows **Start** menu.
 - For Windows 2000, select **Settings > Printers**.
 - For Windows XP/2003, select **Control Panel > Printers and Faxes**.
 - For Windows 2008/Vista, select **Control Panel > Hardware and Sound > Printers**.
3. Select the your machine's driver and right-click to open **Properties**.
4. In printer driver properties, select **Printer**.
5. Select the time you want, in the **Power Save** drop-down list.
6. Click **OK**.

For Phaser 3160B and 3160N

You change power save in the Printer Settings Utility.

1. from the **Start** menu, select **Programs** or **All Programs > your printer driver name > Printer Settings Utility**.
2. Select the time you want, in the **Power Save** drop-down list.
3. Click the **Apply** button.

This can also be adjusted via CentreWare IS. (Phaser 3160N only)

CHANGING FONT SETTING (PHASER 3160B AND PHASER 3160N ONLY)

Your machine has preset the font for your region or country.

If you want to change the font or set the font for special condition, such as the DOS environment, you can change the font setting as follows:

1. Turn your networked computer on and open the web browser.
2. From the **Start** menu, select **Programs** or **All Programs > your printer driver name > Printer Settings Utility**.
3. Click **Emulation**.
4. Confirm if **PCL** is selected in **Emulation Setting**.
5. Click **Setting**.
6. Select your preferred font in the **Symbol Set** list.
7. Click **Apply**.



Following information shows the proper font list for corresponding languages.

- **Russian:** CP866, ISO 8859/5 Latin Cyrillic
- **Hebrew:** Hebrew 15Q, Hebrew-8, Hebrew-7 (Israel only)
- **Greek:** ISO 8859/7 Latin Greek, PC-8 Latin/Greek
- **Arabic & Farsi:** HP Arabic-8, Windows Arabic, Code Page 864, Farsi, ISO 8859/6 Latin Arabic
- **OCR:** OCR-A, OCR-B

media and tray

This chapter provides information on how to load print media into your machine.

This chapter includes:

- Selecting print media
- Changing the tray size
- Loading paper in the tray
- Printing on special media
- Using the output support

SELECTING PRINT MEDIA

You can print on a variety of print media, such as plain paper, envelopes, labels, and transparencies. Always use print media that meet the guidelines for use with your machine.

Guidelines to select the print media

Print media that does not meet the guidelines outlined in this user guide may cause the following problems:

- Poor print quality
- Increased paper jams
- Premature wear on the machine.

Properties, such as weight, composition, grain, and moisture content, are important factors that affect the machine's performance and the output quality. When you choose print materials, consider the following:

- The type, size and weight of the print media for your machine are described in print media specifications. (See "Print media specifications" on page 66.)
- Desired outcome: The print media you choose should be appropriate for your project.
- Brightness: Some print media are whiter than others and produce sharper, more vibrant images.
- Surface smoothness: The smoothness of the print media affects how crisp the printing looks on the paper.

- Some print media may meet all of the guidelines in this section and still not produce satisfactory results. This may be the result of improper handling, unacceptable temperature and humidity levels, or other variables over which cannot be controlled.
- Before purchasing large quantities of print media, ensure that it meets the requirements specified in this user guide.

- Using print media that does not meet these specifications may cause problems, requiring repairs. Such repairs are not covered by the warranty or service agreements.

The amount of paper put into the tray may differ according to media type used. (See "Print media specifications" on page 66.)

Media sizes supported in each mode

MODE	SIZE	TYPE	SOURCE
Simplex printing	For details about paper size, see "Print media specifications" on page 66.	For details about paper type, see "Print media specifications" on page 66.	<ul style="list-style-type: none">• tray 1• manual tray
Duplex printing (Manual) ^a	Letter, A4, Legal, US Folio, Oficio	Plain, Color, Preprinted, Recycled, Bond, Archive	<ul style="list-style-type: none">• tray 1

a. 75 to 90 g/m² (20~24 lb bond) only

CHANGING THE TRAY SIZE

The tray is preset to Letter or A4 size, depending on your country. To change the size, you need to adjust the paper guides.

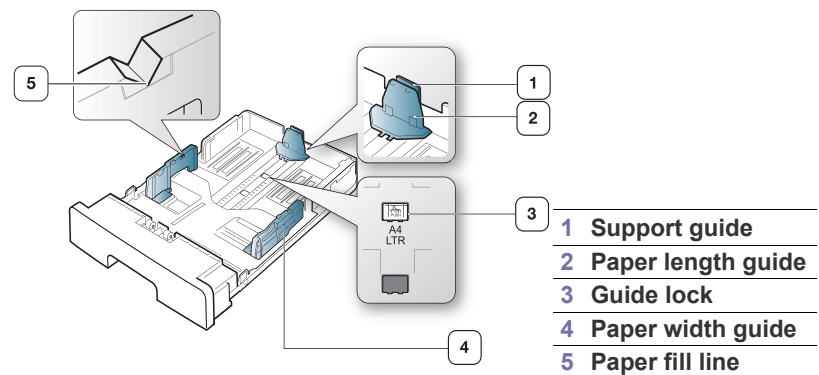

1. With one hand press and hold the guide lock, and with the other hand, hold the paper length guide and support guide together. Slide the paper length guide and support guide to locate them in the correct paper size slot.

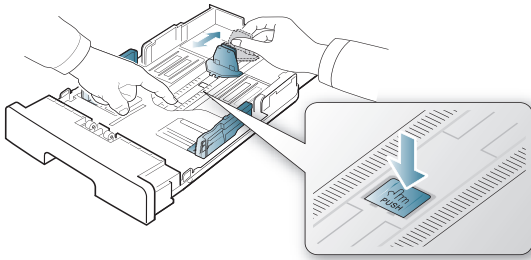

2. Flex or fan the edge of the paper stack to separate the pages before loading papers. Insert the paper into the tray.

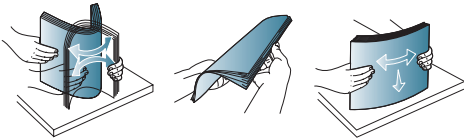

3. After inserting paper into the tray, adjust the support guide so that it lightly touches the paper stack.

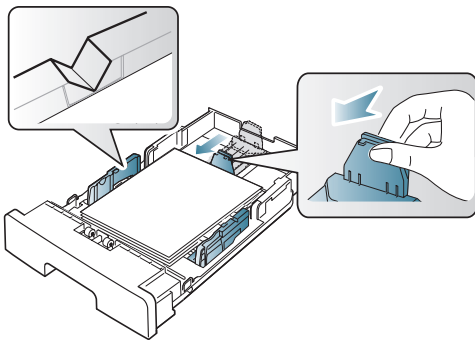

4. Squeeze the paper width guides and slide them to the desired paper size marked at the bottom of the tray.

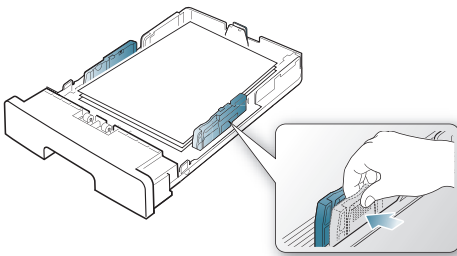

- Make sure not to overfill the tray. Overfilling the tray may cause a paper jam.
- Do not push the paper width guide too far causing the media to buckle.
- If you do not adjust the paper width guide, it may cause paper jams.



- Do not use a paper with more than 6 mm curl.

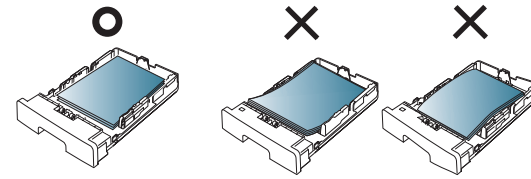

LOADING PAPER IN THE TRAY

Tray 1

1. Pull out the paper tray. And adjust the tray size to the media size you are loading. (See "Changing the tray size" on page 32.)
2. Flex or fan the edge of the paper stack to separate the pages before loading papers.



3. And place paper with the side you want to print facing down.

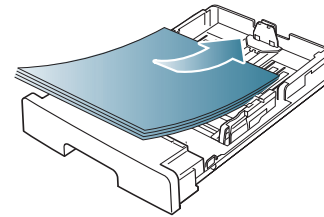

4. Set the paper type and size for the tray 1. (See "Setting the default tray and paper" on page 30.)

- If you experience problems with paper feeding, check whether the paper meets the media specification. (See "Print media specifications" on page 66.)

Manual tray





The manual tray can hold special sizes and types of print material, such as postcards, note cards, and envelopes. It is useful for single page printing on letterhead or colored paper.

Tips on using the manual tray

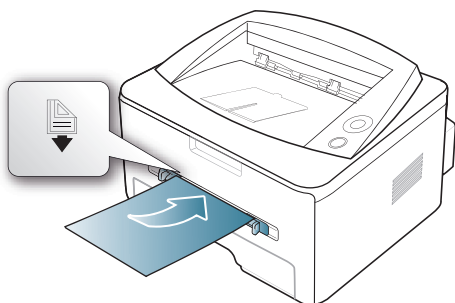
- If you select **Manual Feeder** for **Source** from your software application, you need to press  (cancel button) each time you print a page and load only one type, size and weight of print media at a time in the manual tray.
- To prevent paper jams, do not add paper while printing. This also applies to other types of print media.
- Print media should be loaded face up with the top edge going into the manual tray first and be placed in the center of the tray.
- Always load the specified print media only to avoid paper jams and print quality problems. (See "Print media specifications" on page 66.)
- Flatten any curl on postcards, envelopes, and labels before loading them into the manual tray.

1. Load the paper in the manual tray.



-  Do not force the paper beyond the surface with  mark when loading.
 - When printing the special media, you must follow the loading guideline. (See "Printing on special media" on page 34.)
 - When papers overlap when printing using manual tray, open tray 1 and remove overlapping papers then try printing again.
 - When paper does not feed well while printing, push the paper in manually until it starts feeding automatically.
2. Squeeze the manual tray paper guides and adjust them to the width of the paper. Do not force them too much, or the paper will bend resulting in a paper jam or skew.
 3. To print in application, open an application and start the print menu.
 4. Open **Printing Preferences**. (See "Opening printing preferences" on page 38.)
 5. Press the **Paper** tab in **Printing Preferences**, and select an appropriate paper type.
 -  For example, if you want to use a label, set the paper type to **Label**.
 6. Select **Manual Feeder** in paper source, then press **OK**.
 7. Start printing in application.
-  If you are printing multiple pages, load the next sheet after the first page prints out, and press the  (cancel button). Repeat this step for every page to be printed.

PRINTING ON SPECIAL MEDIA

The table below shows the available special media for each tray.

-  When using special media, we recommend you feed one paper at a time. Check the maximum input number of media for each tray. (See "Print media specifications" on page 66.)

TYPES	TRAY 1	MANUAL TRAY
Plain	•	•
Thick	•	•
Thin	•	•
Bond		•
Color		•
CardStock		•

TYPES	TRAY 1	MANUAL TRAY
Labels		•
Transparency		•
Envelope		•
Preprinted		•
Cotton		•
Recycled	•	•
Archive	•	•

(•: supported, Blank: Not supported)

The media types are shown in the **Printing Preferences**. This paper type option allows you to set the type of paper to be loaded in the tray. This setting appears in the list, so that you can select it. This will let you get the best quality printout. If not, the desired print quality may not be achieved.

- **Plain:** Normal plain paper. Select this type if your machine is monochrome and printing on the 60 to 90 g/m² (16 to 24 lb).
- **Thick:** 90 to 105 g/m² (24 to 28 lb) thick paper.
- **Thin:** 60 to 70 g/m² (16 to 19 lb) thin paper.
- **Bond:** 105 to 120 g/m² (28 to 32 lb) bond.
- **Color:** 75 to 90 g/m² (20 to 24 lb) color-background paper.
- **CardStock:** 90 to 163 g/m² (24 to 43 lb) cardstock.
- **Labels:** 120 to 150 g/m² (32 to 40 lb) labels.
- **Transparency:** 138 to 146 g/m² (37 to 39 lb) transparency paper.
- **Envelope:** 75 to 90 g/m² (20 to 24 lb) envelope.
- **Preprinted:** 75 to 90 g/m² (20 to 24 lb) preprinted/letterhead paper.
- **Cotton:** 75 to 90 g/m² (20 to 24 lb) cotton paper.
- **Recycled:** 75 to 90 g/m² (20 to 24 lb) recycled paper.
 -  When you use recycled paper as a used paper, printouts might be wrinkled.
- **Archive:** 70 to 90 g/m² (19 to 24 lb) If you need to keep the print-out for a long period time, such as archives, select this option.

Envelope

Successful printing on envelopes depends upon the quality of the envelopes.

To print an envelope, the stamp area is on the left side and the end of the envelope with the stamp area enters the printer first and center of the manual tray.

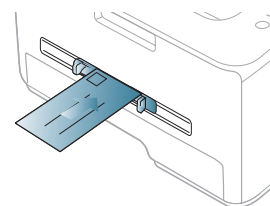

If envelopes are printed out with wrinkles, crease or black bold lines, open the rear cover and pull down the pressure lever and try printing again. Keep the rear cover opened during printing.

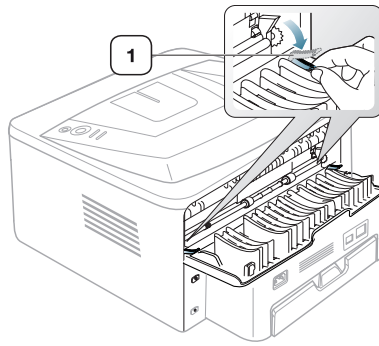

1 Pressure lever

- When selecting envelopes, consider the following factors:
 - Weight:** The weight of the envelope paper should not exceed 90 g/m² otherwise a jam may occur.
 - Construction:** Prior to printing, envelopes should lie flat and should not contain air.
 - Condition:** Envelopes should not be wrinkled, nicked, nor damaged.
 - Temperature:** Use envelopes that are compatible with the heat and pressure of the machine during operation.
- Use only well-constructed envelopes with sharp and well-creased folds.
- Do not use stamped envelopes.
- Do not use envelopes with clasps, snaps, windows, coated lining, self-adhesive seals, or other synthetic materials.
- Do not use damaged or poorly made envelopes.
- Be sure the seam at both ends of the envelope extends all the way to the corner of the envelope.

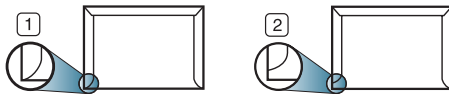

1 Acceptable

2 Unacceptable

- Envelopes with a peel-off adhesive strip or with more than one flap that folds over to seal must use adhesives compatible with the machine's fusing temperature (about 170°C(338 °F) for 0.1 second. The extra flaps and strips might cause wrinkling, creasing, or jams, and may even damage the fuser.
- For the best print quality, position margins no closer than 15 mm from the edges of the envelope.
- Avoid printing over the area where the envelope's seams meet.

Transparency

To avoid damaging the machine, use only transparencies designed for use in laser printers.

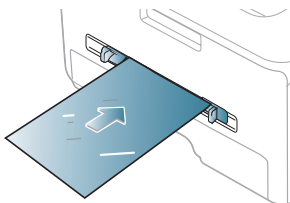

- Transparencies used in the machine must be able to withstand machine's fusing temperature.
- Place them on a flat surface after removing them from the machine.
- Do not leave unused transparencies in the paper tray for long periods of time. Dust and dirt may accumulate on them, resulting in spotty printing.
- To avoid smudging caused by fingerprints, handle them carefully.
- To avoid fading, do not expose printed transparencies to prolonged sunlight.
- Ensure that transparencies are not wrinkled, curled, or have any torn edges.
- Do not use transparencies that separate from the backing sheet.
- To prevent transparencies from sticking to each other, do not let the printed sheets stack up as they begin printed out.

Labels

To avoid damaging the machine, use only labels designed for use in laser machines.

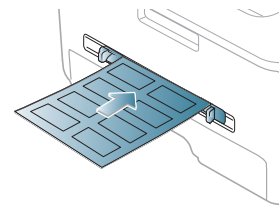

- When selecting labels, consider the following factors:
 - Adhesives:** The adhesive material should be stable at your machine's fusing temperature (about 170°C(338 °F)).
 - Arrangement:** Only use labels with no exposed backing between them. Labels can peel off sheets that have spaces between the labels, causing serious jams.
 - Curl:** Prior to printing, labels must lie flat with no more than 13 mm of curl in any direction.
 - Condition:** Do not use labels with wrinkles, bubbles, or other indications of separation.
- Make sure that there is no exposed adhesive material between labels. Exposed areas can cause labels to peel off during printing, which can cause paper jams. Exposed adhesive can also cause damage to machine components.
- Do not run a sheet of labels through the machine more than once. The adhesive backing is designed for only a single pass through the machine.
- Do not use labels that are separating from the backing sheet or are wrinkled, bubbled, or otherwise damaged.

Card stock/ Custom-sized paper

Postcards, cards and other custom-sized materials can be printed with this machine.

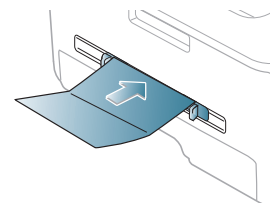

- Do not print on media smaller than 76 mm (3.00 inches) wide or 127 mm (5.00 inches) long.
- In the software application, set margins at least 6.4 mm (0.25 inches) away from the edges of the material.
- If media weight is over 160 g/m² (43 lb), try printing in the rear cover (face up).

Letterhead/ Preprinted paper

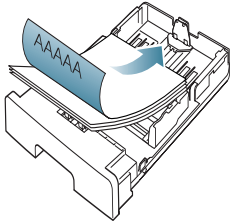
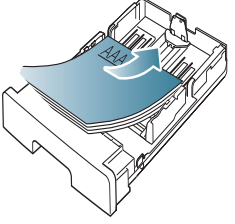
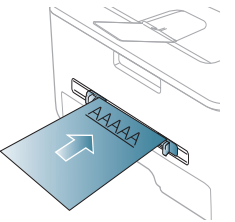
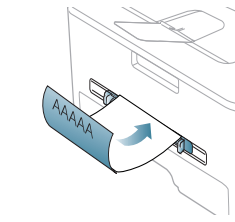
	SINGLE-SIDED	DOUBLE-SIDED
Tray1	Face down 	Face up 
Manual tray	Face up 	Face down 

- !**
- Letterhead/ Preprinted paper must be printed with heat-resistant ink that will not melt, vaporize, or release hazardous emissions when subjected to the machine's fusing temperature (about 170°C(338 °F) for 0.1 second.
 - Letterhead/ Preprinted paper ink must be non-flammable and should not adversely affect machine rollers.
 - Forms and letterhead should be sealed in a moisture-proof wrapping to prevent changes during storage.
 - Before you load letterhead/preprinted paper, verify that the ink on the paper is dry. During the fusing process, wet ink can come off preprinted paper, reducing print quality.

Photo

- Make sure not to use the inkjet photo paper with this machine. It could cause damage to the machine.

Glossy

- Load one paper to the manual tray at a time, glossy side facing up.

USING THE OUTPUT SUPPORT

-  The surface of the output tray may become hot if you print a large number of pages at once. Make sure that you do not touch the surface, and do not allow children near it.

The printed pages stack on the output support, and the output support will help the printed pages to align. The printer sends output to the output tray by default. To use the output tray, make sure that the rear cover is closed.

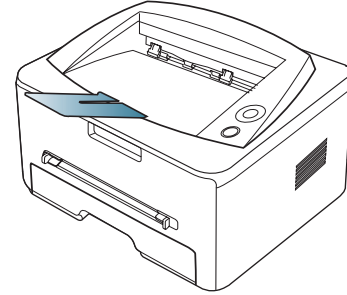

This chapter explains common printing tasks.

This chapter includes:

- Printer driver features
- Basic printing
- Opening printing preferences
- Using help
- Using special print features

 The procedures in this chapter are mainly based on Windows XP.

PRINTER DRIVER FEATURES

Your printer drivers support the following standard features:

- Paper orientation, size, source, and media type selection
- Number of copies

In addition, you can use various special printing features. The following table shows a general overview of features supported by your printer drivers:

 Some models or operating system may not support the certain feature(s) in the following table.

Printer driver

FEATURE	WINDOWS	MACINTOSH	LINUX
Machine quality option	•	•	•
Poster printing	•		
Multiple pages per sheet	•	•	•
Booklet printing (manual)	•		
Fit to page printing	•	•	
Reduce and enlarge printing	•		
Different source for first page	•	•	
Watermark	•		
Overlay	•		
Double-sided printing (manual)	•		

(• : supported, Blank: Not supported)





BASIC PRINTING

Your machine allows you to print from various Windows, Macintosh, or Linux applications. The exact steps for printing a document may vary depending on the application you use.

 • Your **Printing Preferences** window that appears in this user guide

- Changing the default print settings
- Setting your machine as a default machine
- Printing to a file (PRN)
- Macintosh printing
- Linux printing

may differ depending on the machine in use. However, the composition of the **Printing Preferences** window is similar. Check the operating system(s) that are compatible with your machine.

- When you select an option in **Printing Preferences**, you may see a warning mark, , or . An exclamation mark () means you can select that certain option but it is not recommended, and () mark means you cannot select that option due to the machine's setting or environment.

The following procedure describes the general steps required for printing from various Windows applications.

-  Macintosh basic printing. (See "Macintosh printing" on page 42.)
- Linux basic printing. (See "Linux printing" on page 44.)

The following **Printing Preferences** window is for Notepad in Windows XP. Your **Printing Preferences** window may differ, depending on your operating system or the application you are using.

1. Open the document you want to print.
2. Select **Print** from the **File** menu. The **Print** window appears.
3. Select your machine from the **Select Printer** list.

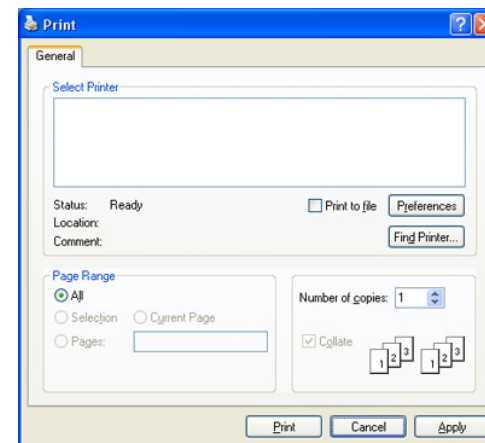

The basic print settings including the number of copies and print range are selected within the **Print** window.



 To take advantage of the printer features provided by your printer driver, click **Properties** or **Preferences** in the application's **Print** window to change the print setting. (See "Opening printing preferences" on page 38.)

4. To start the print job, click **OK** or **Print** in the **Print** window.

Canceling a print job

If the print job is waiting in a print queue or print spooler, cancel the job as follows:

1. Click the Windows **Start** menu.
 - For Windows 2000, select **Settings > Printers**.
 - For Windows XP/2003, select **Control Panel > Printers and Faxes**.
 - For Windows 2008/Vista, select **Control Panel > Hardware and Sound > Printers**.
2. Double-click your machine.
3. From the **Document** menu, select **Cancel**.

 You can also access this window by simply double-clicking the machine icon () in the Windows task bar. You can also cancel the current job by pressing  on the control panel.

OPENING PRINTING PREFERENCES

You can preview the settings you selected on the upper right of the **Printing Preferences**.

1. Open the document you want to print.
2. Select **Print** from the file menu. The **Print** window appears.
3. Select your machine from the **Select Printer**.
4. Click **Properties** or **Preferences**.

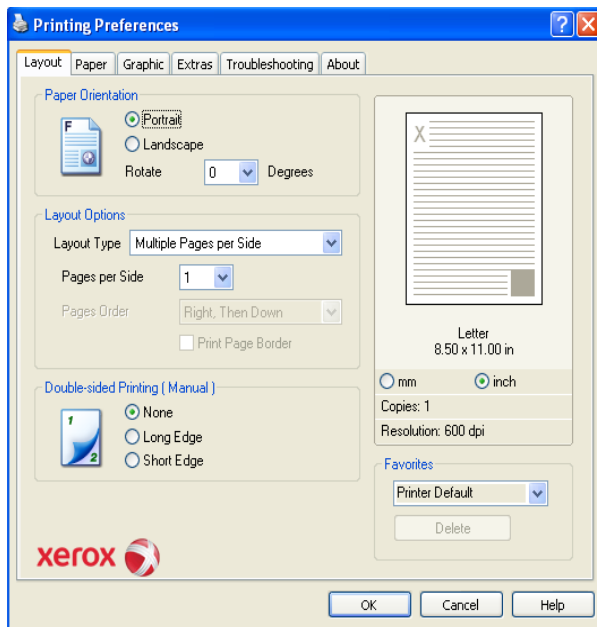

Using a favorite setting

The **Favorites** option, which is visible on each preferences tab except for **Xerox** tab, allows you to save the current preferences settings for future use.

To save a **Favorites** item:

1. Change the settings as needed on each tab.
2. Enter a name for the item in the **Favorites** input box. Click **Save**.

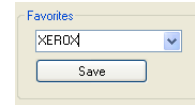

3. When you save **Favorites**, all current driver settings are saved. To use a saved setting, select it from the **Favorites** drop down list. The machine is now set to print according to the setting you selected. To delete saved setting, select it from the **Favorites** drop down list and click **Delete**.

You can also restore the printer driver's default settings by selecting **Printer Default** from the **Favorites** drop down list.

USING HELP

Click the question mark from the upper-right corner of the window and click on any option you want to know about. Then a pop up window appears with information about that option's feature which is provided from the driver.

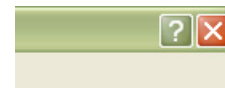

Your printer has a help screen that can be activated by clicking the **Help** button in the printer properties window. These help screens give detailed information about the printer features provided by the printer driver.

 The help menu might not be available in some applications.

USING SPECIAL PRINT FEATURES

Special print features include:

- "Printing multiple pages on one sheet of paper" on page 38.
- "Printing posters" on page 39.
- "Printing booklets (Manual)" on page 39.
- "Printing on both sides of paper (Manual)" on page 39.
- "Change percentage of your document" on page 39.
- "Fitting your document to a selected paper size" on page 40.
- "Using Troubleshooting tab" on page 40.
- "Using watermarks" on page 40.
- "Using overlay" on page 40.
- "Graphics tab options" on page 41.

Printing multiple pages on one sheet of paper

You can select the number of pages to print on a single sheet of paper. To print more than one page per sheet, the pages will be reduced in size and arranged in the order you specify. You can print up to 16 pages on one sheet.

1. To change the print settings from your software application, access **Printing Preferences**. (See "Opening printing preferences" on page 38.)
2. Click the **Layout** tab, select **Multiple Pages Per Side** in the **Layout Type** drop-down list.
3. Select the number of pages you want to print per sheet (2, 4, 6, 9, or 16) in the **Pages per Side** drop-down list.
4. Select the page order from the **Page Order** drop-down list, if necessary.
5. Check **Print Page Border** to print a border around each page on the sheet.

6. Click the **Paper** tab, select the **Size**, **Source**, and **Type**.
7. Click **OK** or **Print** until you exit the **Print** window.

Printing posters

This feature allows you to print a single-page document onto 4, 9, or 16 sheets of paper, for the purpose of pasting the sheets together to form one poster-size document.

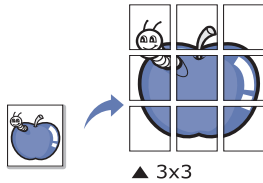

1. To change the print settings from your software application, access **Printing Preferences**. (See "Opening printing preferences" on page 38.)
2. Click the **Layout** tab, select **Poster Printing** in the **Layout Type** drop-down list.
3. Select the page layout you want.
Specification of the page layout:
 - **Poster 2x2**: Document will be enlarged and be divided into 4 pages.
 - **Poster 3x3**: Document will be enlarged and be divided into 9 pages.
 - **Poster 4x4**: Document will be enlarged and be divided into 16 pages.
4. Select the **Overlap** value. Specify **Overlap** in millimeters or inches by selecting the radio button to make it easier to paste the sheets together.

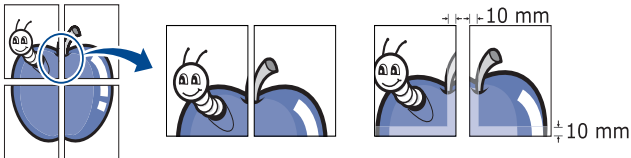

5. Click the **Paper** tab, select the **Size**, **Source**, and **Type**.
6. Click **OK** or **Print** until you exit the **Print** window.
7. You can complete the poster by pasting the sheets together.



Printing booklets (Manual)

This feature prints your document on both sides of a paper and arranges the pages so that the paper can be folded in half after printing to produce a booklet.

-  If you want to make a booklet, you need to print on Letter, Legal, A4, US Folio, or Oficio sized print media.



1. To change the print settings from your software application, access the **Printing Preferences**. (See "Opening printing preferences" on page 38.)
2. Click the **Layout** tab, select **Booklet Printing** from the **Layout Type** drop-down list.
3. Click the **Paper** tab, select the **Size**, **Source**, and **Type**.

-  The **Booklet Printing** option is not available for all paper sizes. In order to find out the available paper size for this feature, select the available paper size in the **Size** option on the **Paper** tab.
If you select an unavailable paper size, this option can be automatically canceled. Select only available paper. (paper without  or  mark).

4. Click **OK** or **Print** until you exit the **Print** window.
5. After printing, fold and staple the pages.

Printing on both sides of paper (Manual)

You can print on both sides of a paper; duplex. Before printing, decide how you want your document oriented. You can use this feature with Letter, Legal, A4, US Folio, or Oficio sized paper. (See "Print media specifications" on page 66.)

-  We recommend not to print on both sides of the special media, such as labels, envelopes, or thick paper to print on both sides of paper. It may cause a paper jam or damage the machine.

1. To change the print settings from your software application, access **Printing Preferences**. (See "Opening printing preferences" on page 38.)
2. Click the **Layout** tab.
3. From the **Double-Sided Printing (Manual)** section, select the binding option you want.
 - **None**
 - **Long Edge**: This option is the conventional layout used in bookbinding.

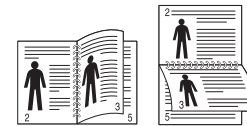

- **Short Edge**: This option is the conventional layout used in calendars.



4. Click the **Paper** tab, select the **Size**, **Source**, and **Type**.
5. Click **OK** or **Print** until you exit the **Print** window.

-  The machine prints every other page of the document first. After that, a message appears on your computer. Follow the on-screen instructions to complete the printing job.

Change percentage of your document

You can change the size of a document to appear larger or smaller on the printed page by typing in a percentage you want.

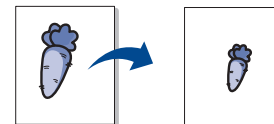

1. To change the print settings from your software application, access **Printing Preferences**. (See "Opening printing preferences" on page 38.)
2. Click the **Paper** tab.
3. From the **Scaling Printing**, select **Reduce/Enlarge** in the **Printing Type** drop-down list.
4. Enter the scaling rate in the **Percentage** input box.
You can also click the up/down arrows to select the scaling rate.
5. Select the **Size**, **Source**, and **Type** in **Paper Options**.
6. Click **OK** or **Print** until you exit the **Print** window.

Fitting your document to a selected paper size

This printer feature allows you to scale your print job to any selected paper size regardless of the document size. This can be useful when you want to check fine details on a small document.

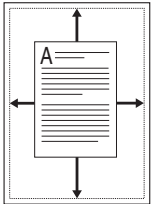

1. To change the print settings from your software application, access **Printing Preferences**. (See "Opening printing preferences" on page 38.)
2. Click the **Paper** tab.
3. From the **Scaling Printing**, select **Fit to Page** in the **Printing Type** drop-down list.
4. Select the paper size you want from the **Fit to Page**.
5. Select the **Size**, **Source**, and **Type** in **Paper Options**.
6. Click **OK** or **Print** until you exit the **Print** window.

Using Troubleshooting tab

Click the Troubleshooting tab to access the following feature:

- **Printer Information Page:** To print information pages or to perform diagnostic actions, select an item from the list below and click **Print**
- **Web Links:** If you have an Internet connection and a browser installed, click one of the web links to connect to a web page directly from the driver.

Using watermarks

The watermark option allows you to print text over an existing document. For example, you use it when you want to have large gray letters reading "DRAFT" or "CONFIDENTIAL" printed diagonally across the first page or all pages of a document.



There are several predefined watermarks that come with the machine. They can be modified, or you can add new ones to the list.

Using an existing watermark

1. To change the print settings from your software application, access **Printing Preferences**. (See "Opening printing preferences" on page 38.)
2. Click the **Extras** tab, and select the desired watermark from the **Watermark** drop-down list. You will see the selected watermark in the preview image.
3. Click **OK** or **Print** until you exit the print window.

Creating a watermark

1. To change the print settings from your software application, access **Printing Preferences**. (See "Opening printing preferences" on page 38.)
2. From the **Extras** tab, select **Edit** from the **Watermark** drop-down list. The **Edit Watermarks** window appears.
3. Enter a text message in the **Watermark Message** box. You can enter up to 256 characters. The message displays in the preview window.
When the **First Page Only** box is checked, the watermark prints on the first page only.
4. Select watermark options.
You can select the font name, style, size, and shade from the **Font Attributes** section, as well as set the angle of the watermark from the **Message Angle** section.
5. Click **Add** to add a new watermark to the **Current Watermarks** list.
6. When you have finished editing, click **OK** or **Print** until you exit the **Print** window.

To stop printing the watermark, select **None** from the **Watermark** drop-down list.

Editing a watermark

1. To change the print settings from your software application, access **Printing Preferences**. (See "Opening printing preferences" on page 38.)
2. Click the **Extras** tab, select **Edit** from the **Watermark** drop-down list. The **Edit Watermarks** window appears.
3. Select the watermark you want to edit from the **Current Watermarks** list and change the watermark message and options.
4. Click **Update** to save the changes.
5. Click **OK** or **Print** until you exit the **Print** window.

Deleting a watermark

1. To change the print settings from your software application, access **Printing Preferences**. (See "Opening printing preferences" on page 38.)
2. Click the **Extras** tab, select **Edit** from the **Watermark** drop-down list. The **Edit Watermarks** window appears.
3. Select the watermark you want to delete from the **Current Watermarks** list and click **Delete**.
4. Click **OK** or **Print** until you exit the **Print** window.

Using overlay

An overlay is text and/or images stored in the computer hard disk drive (HDD) as a special file format that can be printed on any document. Overlays are often used to take the place of letterhead paper. Rather than using preprinted letterhead, you can create an overlay containing exactly the same information that is currently on your letterhead. To print a letter

with your company's letterhead, you do not need to load preprinted letterhead paper in the machine just print the letterhead overlay on your document.

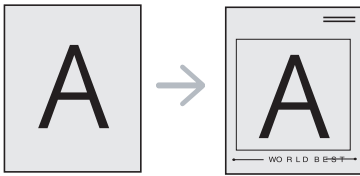

Creating a new page overlay

To use a page overlay, you must create a new page overlay containing your logo or image.

1. Create or open a document containing text or an image for use in a new page overlay. Position the items exactly as you wish them to appear when printed as an overlay.
2. To save the document as an overlay, access **Printing Preferences**. (See "Opening printing preferences" on page 38.)
3. Click the **Extras** tab, and select **Edit** from the **Text** drop-down list. **Edit Overlay** window appears.
4. In the **Edit Overlay** window, click **Create Overlay**.
5. In the **Save As** window, type a name of up to eight characters in the **File name** box. Select the destination path, if necessary. (The default is C:\Formover.)
6. Click **Save**. The name appears on the **Overlay List**.
7. Click **OK** or **Print** until you exit the **Print** window.
8. The file is not printed. Instead, it is stored on your computer hard disk drive.

 The overlay document size must be the same as the document you print with the overlay. Do not create an overlay with a watermark.

Using a page overlay

After an overlay has been created, it is ready to be printed with your document. To print an overlay with a document:

1. Create or open the document you want to print.
2. To change the print settings from your software application, access **Printing Preferences**. (See "Opening printing preferences" on page 38.)
3. Click the **Extras** tab.
4. Select the desired overlay from the **Text** drop-down list.
5. If the overlay file you want does not appear in the **Text** drop-down list, select **Edit** from the list and click **Load Overlay**. Select the overlay file you want to use.

If you have stored the overlay file you want to use in an external source, you can also load the file when you access the **Open** window.

After you select the file, click **Open**. The file appears in the **Overlay List** box and is available for printing. Select the overlay from the **Overlay List** box.

6. If necessary, check **Confirm Page Overlay When Printing** box. If this box is checked, a message window appears each time you submit a document for printing, asking you to confirm your wish to print an overlay on your document.
If this box is not checked and an overlay has been selected, the overlay automatically prints with your document.
7. Click **OK** or **Print** until you exit the **Print** window.
The selected overlay prints on your document.

 The resolution of the overlay document must be the same as that of the document you will print with the overlay.



Deleting a page overlay

You can delete page overlays that you no longer use.

1. In the **Printing Preferences** window, click the **Extras** tab.
2. Select **Edit** in the **Overlay** drop down list.
3. Select the overlay you want to delete from the **Overlay List** box.
4. Click **Delete**.
5. When a confirming message window appears, click **Yes**.
6. Click **OK** or **Print** until you exit the **Print** window.

Graphics tab options

Use the following **Graphics** options to adjust the print quality for your specific printing needs.

1. To change the print settings from your software application, access **Printing Preferences**. (See "Opening printing preferences" on page 38.)
2. Click the **Graphics** tab.
 -  • This options you can select may vary depending on your printer model.
 - Refer to the online help for each option's information provided from the **Printing Preferences**.
 - **Resolution**: The higher the setting, the sharper the clarity of printed characters and graphics. The higher setting also may increase the time it takes to print a document.
 - **Toner Save Mode** : Selecting this option extends the life of your toner cartridge and reduces your cost per page without a significant reduction in print quality.
 - **Printer Setting**: If you select this option, this feature is determined by the setting you've made from the machine.
 - **On**: Select this option to allow the printer to use less toner on each page.
 - **Off**: If you do not need to save toner when printing a document, select this option.
 - **Advanced Options**
 - **Print All Text To Black**: When the **Print All Text To Black** option is checked, all text in your document prints solid black, regardless of the color it appears on the screen.
 - **Print All Text To Darken**: When the **Print All Text To Darken** option is checked, all text in your document is allowed to print darker than on a normal document.
 - **Fine Edge**: Press the **Smart Color** tab. It allows users to preserve the details of nature photo, and improve contrast and readability among gray scaled colors, when printing color documents in grayscale.
 - **Darkness**: The option adjusts the toner density on print outputs. The values are **Normal**, **Light**, and **Dark**.
 -  For Phaser 3160B and Phaser 3160N, you can adjust the darkness in the Printer Settings Utility.

3. Click **OK** or **Print** until you exit the **Print** window.

CHANGING THE DEFAULT PRINT SETTINGS

1. Click the Windows **Start** menu.
 - For Windows 2000, select **Settings** and then **Printers**.
 - For Windows XP/2003, select **Control Panel** > **Printers and Faxes**.

- For Windows 2008/Vista, select **Control Panel > Hardware and Sound > Printers**.
2. Select your machine.
 3. Right-click on the printer driver icon and select **Printing Preferences**.
 4. Change the settings on each tab.
 5. Click **OK**.

 Most Windows applications will override settings you specify in the printer driver. Change all print settings available in the software application first, and change any remaining settings using the printer driver.

SETTING YOUR MACHINE AS A DEFAULT MACHINE

1. Click the Windows **Start** menu.
 - For Windows 2000, select **Settings > Printers**.
 - For Windows XP/2003, select **Control Panel > Printers and Faxes**.
 - For Windows 2008/Vista, select **Control Panel > Hardware and Sound > Printers**.
2. Select your machine.
3. Right-click your machine and select **Set as Default Printer**.

PRINTING TO A FILE (PRN)

You will sometimes need to save the print data as a file.

 The PRN file saves data in a format that is only recognized by the selected printer. The file can only be sent to the printer later using third-party software (not provided).

To create a file:

1. Check the **Print to file** box at the **Print** window.

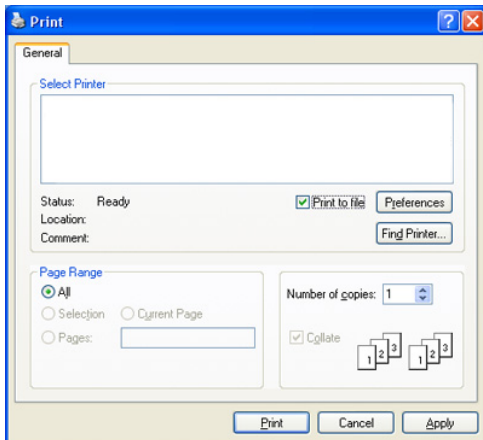

2. Click **Print**.
3. Type in the destination path and the file name, and then click **OK**.
For example c:\Temp\file name.

 If you type in only the file name, the file is automatically saved in My Documents.

MACINTOSH PRINTING

This chapter explains how to print using Macintosh. You need to set the print environment before printing.

- USB connected (See "Macintosh" on page 23.)
- Network connected (See "Macintosh" on page 26.)

Printing a document

When you print with a Macintosh, you need to check the printer driver setting in each application you use. Follow the steps below to print from a Macintosh:

1. Open an application and select the file you want to print.
2. Open the **File** menu and click **Page Setup (Document Setup** in some applications).
3. Choose your paper size, orientation, scaling, other options, and make sure that your machine is selected. Click **OK**.

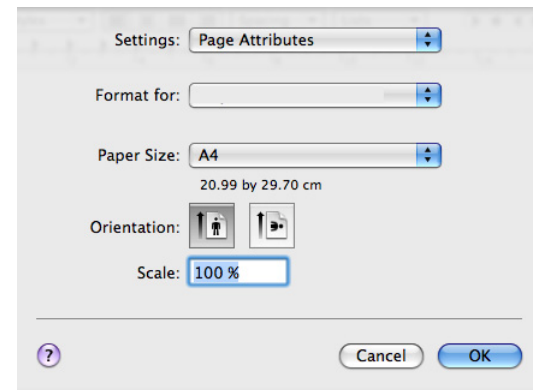

4. Open the **File** menu and click **Print**.
5. Choose the number of copies you want and indicate which pages you want to print.
6. Click **Print**.

Changing printer settings

You can use advanced printing features when using your machine.

Open an application and select **Print** from the **File** menu. The machine name, which appears in the printer properties window may differ depending on the machine in use. Except for the name, the composition of the printer properties window is similar to the following.

 The setting options may differ depending on printers and Macintosh OS version.

Layout

The **Layout** tab provides options to adjust how the document appears on the printed page. You can print multiple pages on one sheet of paper. Select **Layout** from the drop-down list under **Orientation** to access the following features.

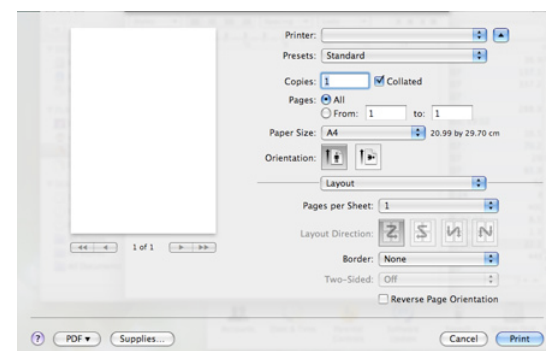

- **Pages per Sheet:** This option determines how many pages to be

printed on one page. (See "Printing multiple pages on one sheet of paper" on page 44.)

- **Layout Direction:** This option allows you to select the printing direction on a page similar to the examples on UI.
- **Border:** This option allows you to print a border around each page on the sheet.
- **Reverse Page Orientation:** This option allows you to rotate paper 180 degrees.

Graphics

The **Graphics** tab provides options for selecting **Resolution**. Select **Graphics** from the drop-down list under **Orientation** to access the graphic features.

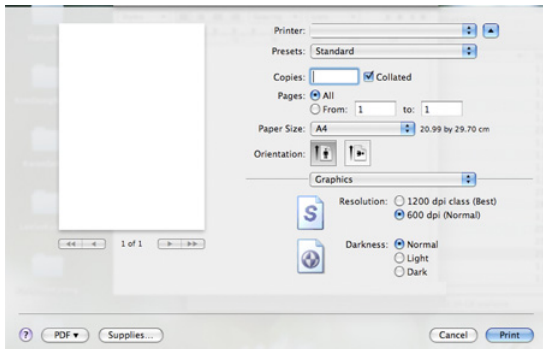

- **Resolution (Quality):** This option allows you to select the printing resolution. The higher the setting, the sharper the clarity of printed characters and graphics. The higher setting also may increase the time it takes to print a document.

- **Darkness:** This option allows you to enhance printouts. The available options are **Normal**, **Light**, and **Dark**.

 For Phaser 3160B and Phaser 3160N, you can adjust the darkness in the Printer Settings Utility.

Paper

Set **Paper Type** to correspond to the paper loaded in the tray from which you want to print. This will let you get the best quality printout. If you load a different type of print material, select the corresponding paper type.

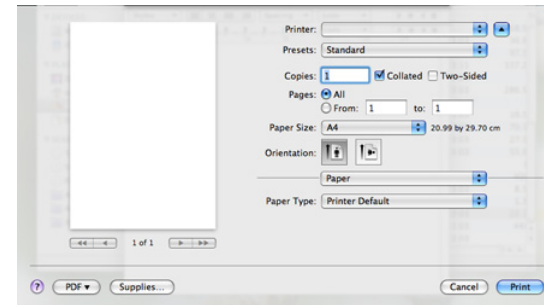

Printer Settings

The **Printer Settings** tab provides **Toner Save Mode**, **Reprint When Jammed**, and **Power Save** options. Select **Printer Settings** from the drop-down list under **Orientation** to access the following features:

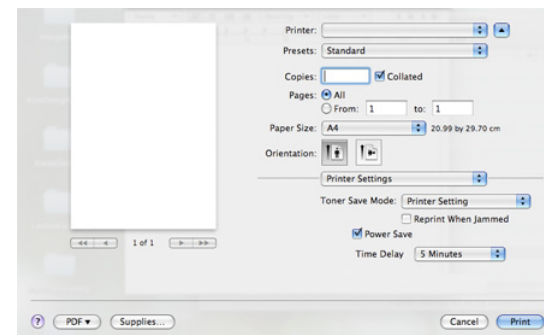

- **Toner Save Mode :** Selecting this option extends the life of your toner cartridge and reduces your cost per page without a significant reduction in print quality.
 - **Printer Setting:** If you select this option, this feature is determined by the setting you've made from machine.
 - **On:** Select this option to allow the printer to use less toner on each page.
 - **Off:** If you do not need to save toner when printing a document, select this option.
- **Reprint When Jammed:** When this option is checked, the machine retains the image of a printed page until the machine signals that the page has successfully exited the machine. If a paper jam occurs, the printer will reprint the last page sent from the computer after you have cleared the jam. (Phaser 3140 and Phaser 3155 only)
- **Power Save:** When this option is checked, the machine turns to the power save mode after the selected time.

 For Phaser 3160B and Phaser 3160N, you change power save in the Printer Settings Utility.

Printing multiple pages on one sheet of paper

You can print more than one page on a single sheet of paper. This feature provides a cost-effective way to print draft pages.

1. Open an application, and select **Print** from the **File** menu.
2. Select **Layout** from the drop-down list under **Orientation**. In the **Pages per Sheet** drop-down list, select the number of pages you want to print on one sheet of paper.

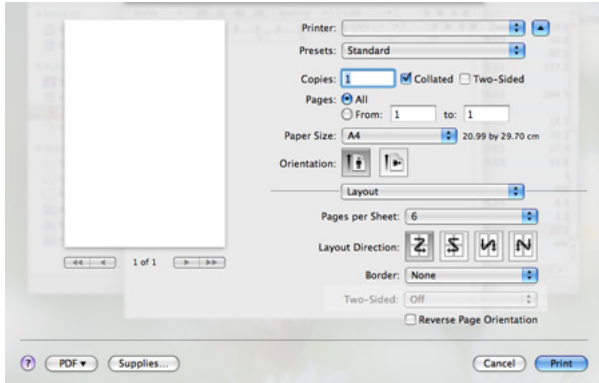

3. Select the other options you want to use.
4. Click **Print**, then the machine prints the selected the number of pages you want to print on one sheet of paper.

LINUX PRINTING

Printing from applications

There are a lot of Linux applications that allow you to print using Common UNIX Printing System (CUPS). You can print on your machine from any such application.

1. Open an application, and select **Print** from the **File** menu.
2. Select **Print** directly using `lpr`.
3. In the LPR GUI window, select the model name of your machine from the printer list and click **Properties**.

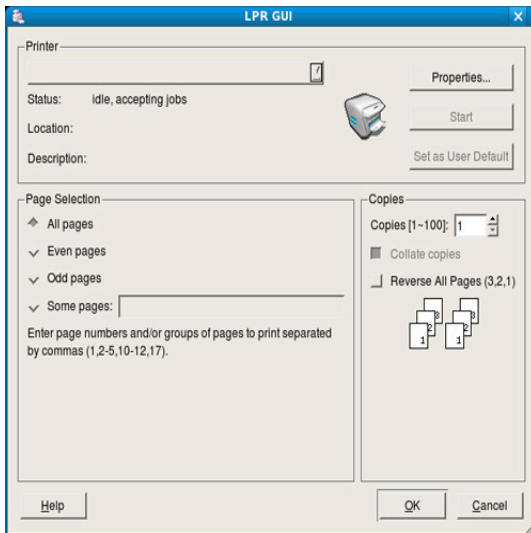

4. Change the print job properties using the following four tabs displayed at the top of the window.

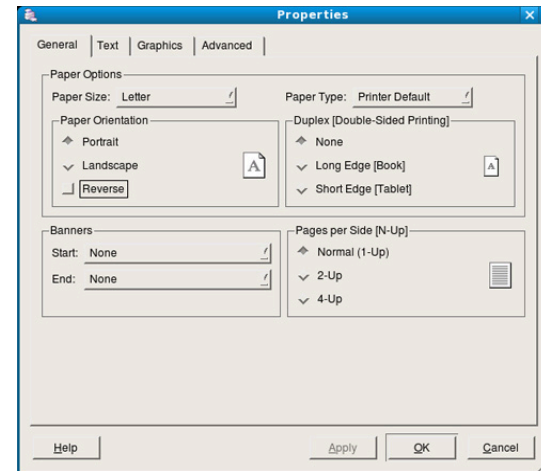

- **General:** This option allows you to change the paper size, the paper type, and the orientation of the documents. It enables the duplex feature, adds start and end banners, and changes the number of pages per sheet.
- **Text:** This option allows you to specify the page margins and set the text options, such as spacing or columns.
- **Graphics:** This option allows you to set image options that are used when printing images/files, such as color options, image size, or image position.
- **Advanced:** This option allows you to set the print resolution, paper source, and destination.

 If an option is grayed out, it means that the grayed out option is not supported.

5. Click **Apply** to apply the changes and close the **Properties** window.
6. Click **OK** in the **LPR GUI** window to start printing.
7. The Printing window appears, allowing you to monitor the status of your print job.
To abort the current job, click **Cancel**.

Printing files

You can print many different types of files on your machine using the standard CUPS way, directly from the command line interface. The CUPS `lpr` utility allows you to do that. But the drivers package replaces the standard `lpr` tool by a much more user-friendly LPR GUI program.

To print any document file:

1. Type `lpr <file_name>` from the Linux shell command line and press Enter. The **LPR GUI** window appears.
When you type only `lpr` and press **Enter**, the **Select file(s) to print** window appears first. Just select any files you want to print and click **Open**.
2. In the **LPR GUI** window, select your machine from the list, and change the print job properties.
3. Click **OK** to start printing.

Configuring printer properties

Using the **Printer Properties** window provided by the **Printers configuration**, you can change the various properties for your machine as a printer.

1. Open the **Unified Driver Configurator**.
If necessary, switch to **Printers configuration**.
2. Select your machine on the available printers list and click **Properties**.
3. The **Printer Properties** window opens.

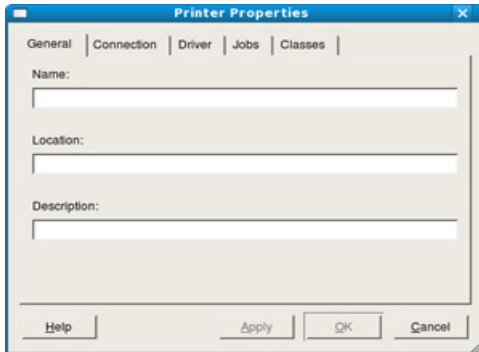

The following five tabs display at the top of the window:

- **General:** This option allows you to change the printer location and name. The name entered in this tab displays on the printer list in **Printers configuration**.
 - **Connection:** This option allows you to view or select another port. If you change the machine port from USB to parallel or vice versa while in use, you must re-configure the machine port in this tab.
 - **Driver:** Allows you to view or select another printer driver. By clicking **Options**, you can set the default device options.
 - **Jobs:** This option shows the list of print jobs. Click **Cancel job** to cancel the selected job and select the **Show completed jobs** check box to see previous jobs on the job list.
 - **Classes:** This option shows the class that your machine is in. Click **Add to Class** to add your machine to a specific class or click **Remove from Class** to remove the machine from the selected class.
4. Click **OK** to apply the changes and close the **Printer Properties** window.

management tools

This chapter introduces management tools provided to help you make full use of your machine.

This chapter includes:

- Using CentreWare IS (Phaser 3160N only)
- Using utility applications

- Using SetIP program (Phaser 3160N only)
- Using the Unified Linux Driver Configurator

USING CENTREWARE IS (PHASER 3160N ONLY)

 Your CentreWare IS window that appears in this user guide may differ depending on the machine in use.

If you have connected your machine to a network and set up TCP/IP network parameters correctly, you can manage the machine via CentreWare IS, an embedded web server. Use CentreWare IS to:

- View the machine's device information and check its current status.
- Change TCP/IP parameters and set up other network parameters.
- Change printer preference.
- Set the email notifications advising of the machine's status.
- Get support for using the machine.

To access CentreWare IS:

1. Access a web browser, such as Internet Explorer, from Windows.
Enter the machine IP address (<http://xxx.xxx.xxx.xxx>) in the address field and press the Enter key or click **Go**.
2. Your machine's embedded website opens.

CentreWare IS overview

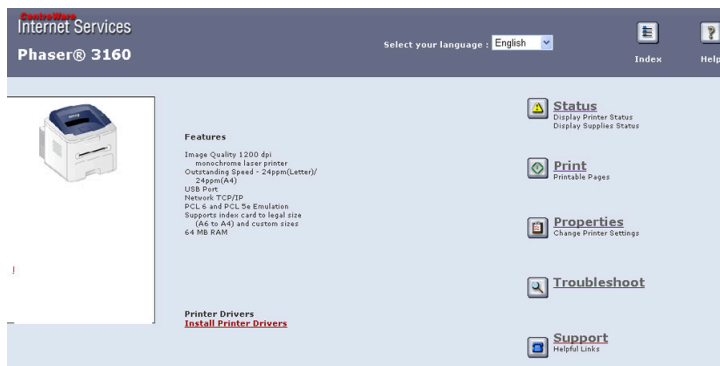

- **Status tab:** This tab gives you general information about your machine.
- **Print tab:** This tab allows you to print help pages, demo pages, configuration pages and download a firmware.
- **Properties tab:** This tab allows you to view and change the network environment. You can set things, such as TCP/IP, enabling Ether Talk and so on.
- **Troubleshoot tab:** This tab allows you to print a menu map, PCL font list and a cleaning page.
- **Support tab:** This tab allows you to connect to Xerox website or download drivers by selecting Link.

USING UTILITY APPLICATIONS

 To use this program, you need the following system requirements:

- Windows. Check for windows operating system(s) compatible with your machine. (See "System requirements" on page 21.)
- Mac OS X 10.3 or higher
- Linux. Check for Linux systems that are compatible with your machine. (See "System requirements" on page 21.)

If you need to know the exact model name of your machine, you can check the supplied software CD.

Understanding Status Monitor

If an error occurs while printing, the Status Monitor window appears, showing the error.

You can also launch Status Monitor manually. Double-click the Status Monitor icon on the Windows task bar (in Windows).

Or, from the **Start** menu, select **Programs** or **All Programs** > **your printer driver name** > **Status Monitor**.

-  If you have already installed more than one Xerox machine, first select the correct machine model you want in order to access the corresponding Status Monitor.
Right-click the Status Monitor icon and select your machine.
- The Status Monitor window and its contents shown in this user guide may differ depending on the machine or operating system in use.

The Status Monitor program displays the current status of the machine, the level of toner remaining in the toner cartridge(s), and various other types of information. You can also change settings.

Changing the Status Monitor Program Settings

Right-click the Status Monitor icon and select **Options**. Select the settings you want from the **Options** window.

Using Printer Settings Utility (Phaser 3160B, Phaser 3160N only)

Using the Printer Settings Utility, you can configure and check print . Some machines do not have this feature.

1. From the **Start** menu, select **Programs** or **All Programs** > **your printer driver name** > **Printer Settings Utility**.
2. Change the settings.
3. To send the changes to the printer, click the **Apply** button.

Using Onscreen Help

For more information about Printer Settings Utility, click .

Opening the Troubleshooting Guide

Find solutions for problems by using the **Troubleshooting Guide**.

Double click the Status Monitor icon on the Windows task bar.

Or, from the **Start** menu, select **Programs** or **All Programs** > **your printer driver name** > **Troubleshooting Guide**.

USING SETIP PROGRAM (PHASER 3160N ONLY)

This program is for the network IP setting using the MAC address which is the hardware serial number of the network printer card or interface.

It is especially for the network administrator to set several network IPs at the same time.

-  TCP/IPv6 is not supported by this program.
- You can only use the SetIP program when your machine is connected to a network.

Windows

The following procedure is based on the Windows XP operating system.

Installing the program

- Make sure that the machine is connected to your computer and powered on.
- Insert the supplied software CD into your CD-ROM drive.
 - The software CD should automatically run and an installation window appear.
 - If the installation window does not appear, click **Start** and then **Run**. Type X:**Setup.exe**, replacing "X" with the letter which represents your drive. Click **OK**.
 - If you use Windows Vista, click **Start** > **All programs** > **Accessories** > **Run**. Type X:**Setup.exe** replacing "X" with the letter which represents your drive and click **OK**.
 - If the **AutoPlay** window appears in Windows Vista, click **Run Setup.exe** in **Install or run program** field, and click **Continue** in the **User Account Control** windows.
- Click **Install SetIP Utility(Optional)**.
- Click **Next** > **Next**.
- Click **Finish**.

Printing out the machine's MAC address

In ready mode, press and hold the Ⓞ (cancel button) for about 7 seconds. You can find your machine's MAC address and IP address.

Setting network values

- Print the machine's network configuration report to find your machine's MAC address.
- From the Windows **Start** menu, select **All Programs** > **SetIP** > **SetIP**.
- Click to open the TCP/IP configuration window.
- Enter the network card's MAC address, IP address, subnet mask, default gateway, and then click **Apply**.
 -  When you enter the MAC address, enter it without a colon(:).
- The machine prints the network configuration report. Confirm all the settings are correct.
- Close the SetIP program.

Macintosh

SetIP program should be automatically installed during the printer driver installation.

Printing out the machine's MAC address

In ready mode, press and hold the Ⓞ (cancel button) for about 7 seconds. You can find your machine's MAC address and IP address.

Setting network values

If you want to change your network printer IP setting, follow the below instruction.

-  If you select **Typical installation for a network printer** during the printer driver installation, the SetIP program automatically runs after the installation. Go to step 4.

- Print the machine's network configuration report to find your machine's MAC address.
- Open the **Library** folder > **Printers** > **Xerox** > **your printer model name** > **SetIP**.
- Double click the **SetIPApplet.html** file.
- The certificate window appears, click **Trust**.
- Click to open the TCP/IP configuration window.
- Enter the network card's MAC address, IP address, subnet mask, default gateway, and then click **Apply**.
 -  When you enter the MAC address, enter it without a colon(:).
- The machine prints the network configuration report. Confirm all the settings are correct.
- Close the SetIP program.

Linux

SetIP program should be automatically installed during the printer driver installation.

Printing out the machine's MAC address

In ready mode, press and hold the Ⓞ (cancel button) for about 7 seconds. You can find your machine's MAC address and IP address.

Setting network values

- Print the machine's network configuration report to find your machine's MAC address.
- Open the **/opt/Xerox/mfp/share/utills/**.
- Double click the **SetIPApplet.html** file.
- Click to open the TCP/IP configuration window.
- Enter the network card's MAC address, IP address, subnet mask, default gateway, and then click **Apply**.
 -  When you enter the MAC address, enter it without a colon(:).
- The machine prints the network configuration report. Confirm all the settings are correct.
- Close the SetIP program.

USING THE UNIFIED LINUX DRIVER CONFIGURATOR

The supplied software CD provides you with the Unified Linux Driver package for using your machine with a Linux computer.

Unified Linux Driver Configurator is a tool primarily intended for configuring machine devices.

After the driver is installed on your Linux system, the Unified Linux Driver Configurator icon will automatically be created on your desktop.

Opening the Unified Driver Configurator

1. Double-click the **Unified Driver Configurator** on the desktop.
You can also click the **Startup** Menu icon and select **Xerox Unified Driver > Unified Driver Configurator**.
2. Click each button on the left to switch to the corresponding configuration window.

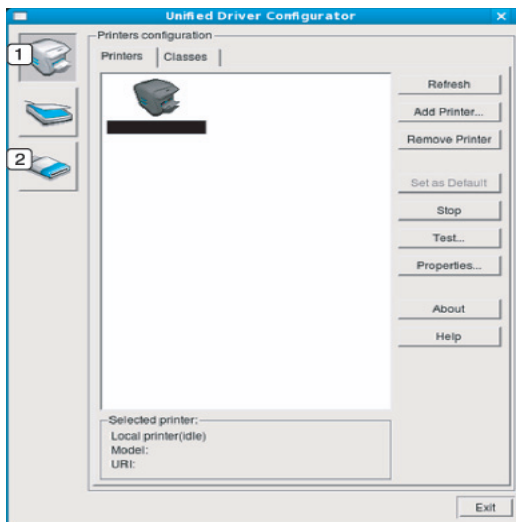

- 1 **Printers Configuration**
- 2 **Ports Configuration**

 To use the on screen help, click **Help**.

3. After changing the configurations, click **Exit** to close the Unified Driver Configurator.

Printers configuration

Printers configuration has the two tabs: **Printers** and **Classes**.

Printers tab

View the current system's printer configuration by clicking on the machine icon button on the left side of the Unified Driver Configurator window.

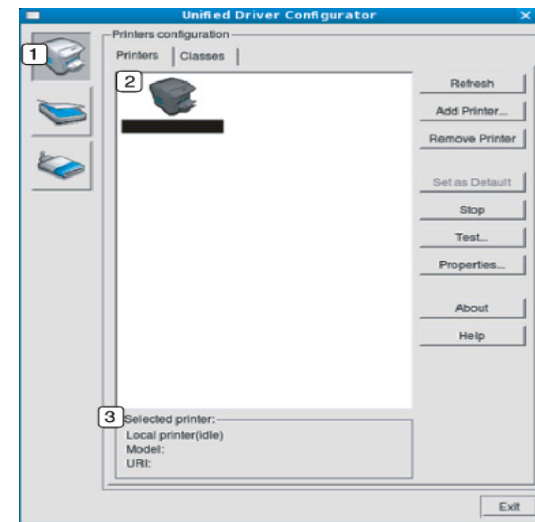

- 1 Switches to **Printers configuration**.
- 2 Shows all of the installed machine.
- 3 Shows the status, model name and URI of your machine.

The printer control buttons are, as follows:

- **Refresh:** Renews the available machines list.
- **Add Printer:** Allows you to add a new machines.
- **Remove Printer:** Removes the selected machine.
- **Set as Default:** Sets the current selected machine as a default machine.
- **Stop/Start:** Stops/starts the machine.
- **Test:** Allows you to print a test page to ensure the machine is working properly.
- **Properties:** Allows you to view and change the printer properties.

Classes tab

The Classes tab shows a list of available machine classes.

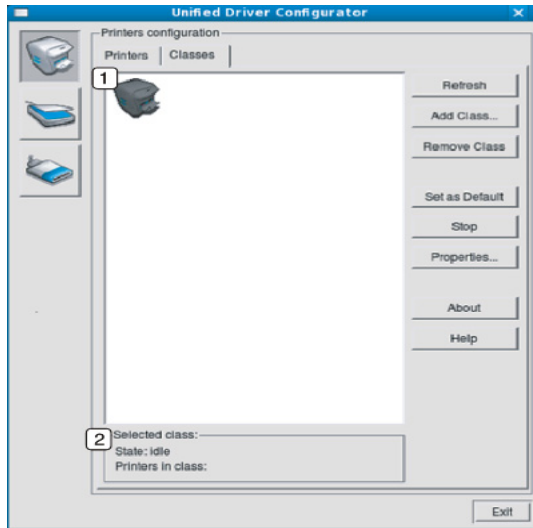

- | | |
|---|--|
| 1 | Shows all of the machine classes. |
| 2 | Shows the status of the class and the number of machines in the class. |
- **Refresh:** Renews the classes list.
 - **Add Class:** Allows you to add a new machine class.
 - **Remove Class:** Removes the selected machine class.

Ports configuration

In this window, you can view the list of available ports, check the status of each port and release a port that is stalled in a busy state when its owner has terminated the job for any reason.

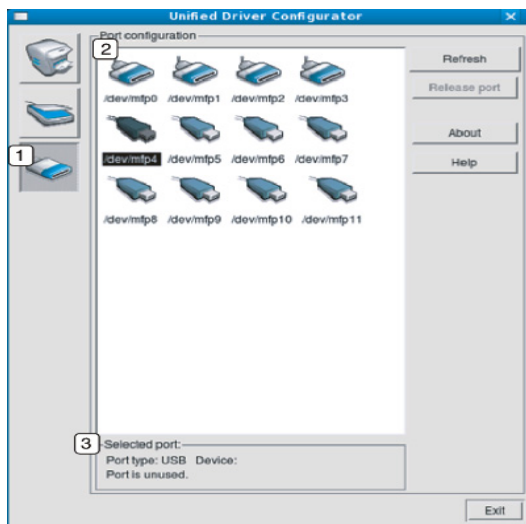

- | | |
|---|---|
| 1 | Switches to Ports configuration . |
| 2 | Shows all of the available ports. |
| 3 | Shows the port type, device connected to the port, and status |

- **Refresh:** Renews the available ports list.
- **Release port:** Releases the selected port.

maintenance

This chapter provides information for maintaining your machine and the toner cartridge.

This chapter includes:

- Printing a machine report
- Using toner low alert (Phaser 3160B and Phaser 3160N only)
- Cleaning a machine
- Storing the toner cartridge
- Tips for moving & storing your machine

PRINTING A MACHINE REPORT

You can print a configuration page to view current printer settings, or to help troubleshoot printer problems.

In ready mode, press and hold the Ⓞ (cancel button) for about 7 seconds, then release.

A configuration page prints out.

For Phaser 3140 and Phaser 3155 this information is provided on the demo page.

USING TONER LOW ALERT (PHASER 3160B AND PHASER 3160N ONLY)

If the amount of toner in the cartridge is low, the ⚠ LED blinks red. You can set the option for this ⚠ LED to blink or not.

1. Ensure that you have installed the printer driver with the provided Printer Software CD.
2. From the **Start** menu, select **Programs** or **All Programs** > **your printer driver name** > **Printer Settings Utility**.
3. Click **Setting** > **Toner Low Alert**. Select the appropriate setting and then click **Apply**.

CLEANING A MACHINE

If printing quality problems occur or if you use your machine in a dusty environment, you need to clean your machine regularly to keep the best printing condition and use your machine longer.

- ⚠ • Cleaning the cabinet of the machine with cleaning materials containing large amounts of alcohol, solvent, or other strong substances can discolor or distort the cabinet.
- If your machine or the surrounding area is contaminated with toner, we recommend you use cloth or tissue dampened with water to clean it. If you use a vacuum cleaner, toner blows in the air and might be harmful to you.

Cleaning the outside

Clean the machine cabinet with a soft, lint-free cloth. Dampen the cloth slightly with water, but be careful not to let any water drip onto or into the machine.

Printing a cleaning sheet (Phaser 3160B and Phaser 3160N only)

If you are experiencing blurred or smeared printouts, you can clear the problem by printing a cleaning sheet, provided by some machines, or by printing several blank pages.

To print the cleaning sheet:

In ready mode, press and hold the Ⓞ (cancel button) for about 10 seconds, then release.

- **OPC cleaning sheet:** Cleans the OPC drum of the toner cartridge.

This process will produce a page with toner debris, which should be discarded.

Your machine automatically picks up a sheet of paper from the tray and prints out a cleaning sheet with dust or toner particles on it.

Cleaning the inside

During the printing process, paper, toner, and dust particles can accumulate inside the machine. This buildup can cause print quality problems, such as toner specks or smearing. Cleaning the inside of the machine clears and reduces these problems.

1. Turn the machine off and unplug the power cord. Wait for the machine to cool down.
2. Open the front cover and pull the toner cartridge out. Set it on a clean flat surface

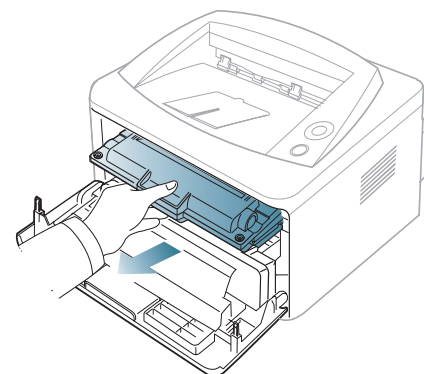

- ⚠ • To prevent damage to the toner cartridge, do not expose it to light for more than a few minutes. Cover it with a piece of paper, if necessary.
- Do not touch the green surface underside of the toner cartridge. Use the handle on the cartridge to avoid touching this area.

3. With a dry, lint-free cloth, wipe away any dust and spilled toner from the toner cartridge area.

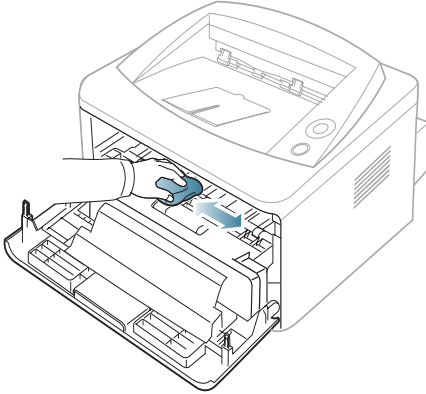

! While cleaning the inside of the machine, be careful not to damage the transfer roller or any other inside parts. Do not use solvents such as benzene or thinner to clean. Printing quality problems can occur and cause damage to the machine.

4. Locate the long strip of glass (LSU) inside the machine and gently swab the glass to see if dirt turns the white cotton black.

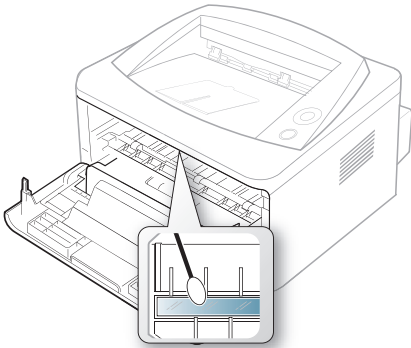

5. Reinsert the toner cartridge and close the front cover.
6. Plug in the power cord and turn the machine on.

STORING THE TONER CARTRIDGE

Toner cartridges contain components that are sensitive to light, temperature, and humidity. Xerox suggests users follow the recommendations to ensure the optimum performance, highest quality, and longest life from your new Xerox toner cartridge.

Store this cartridge in the same environment as the printer it will be used in; this should be in controlled office temperature and humidity conditions. The toner cartridge should remain in its original, unopened package until installation – If original packaging is not available, cover the top opening of the cartridge with paper and store in a dark cabinet.

Opening the cartridge package prior to use dramatically shortens its useful shelf and operating life. Do not store on the floor. If the toner cartridge is removed from the printer, always store the cartridge:

- Inside the protective bag from the original package.
- Store lying flat (not standing on end) with the same side facing up as if they were installed in the machine.
- Do not store consumables in;
 - Temperature greater than 40°C (104°F).

- Humidity range less than 20% and not greater than 80%.
- An environment with extreme changes in humidity or temperature.
- Direct sunlight or room light.
- Dusty places.
- A car for a long period of time.
- An environment where corrosive gases are present.
- An environment with salty air.

Handling instructions

- Do not touch the surface of the photosensitive drum in the cartridge.
- Do not expose the cartridge to unnecessary vibrations or shock.
- Never manually rotate the drum, especially in the reverse direction; this can cause internal damage and toner spillage.

Use of non-Xerox and refilled toner cartridge

Xerox does not recommend or approve the use of non-Xerox brand toner cartridges in your printer including generic, store brand, refilled, or remanufactured toner cartridges.

! Xerox's printer warranty does not cover damage to the machine caused by the use of a refilled, remanufactured, or non-Xerox brand toner cartridge.

Estimated cartridge life

Estimated cartridge life (the life of the toner cartridge yield) depends on the amount of toner that print jobs require. The actual print-out number may vary depending on the print density of the pages you print on, operating environment, printing interval, media type, and/or media size. For example, if you print a lot of graphics, the consumption of the toner is high and you may need to change the cartridge more often.

TIPS FOR MOVING & STORING YOUR MACHINE

- When moving the machine, do not tilt or turn it upside down. Otherwise, the inside of the machine may be contaminated by toner, which can cause damage to the machine or bad print quality.
- When moving the machine, make sure the machine is held securely.

troubleshooting

This chapter gives helpful information for what to do if you encounter an error.

This chapter includes:

- Redistributing toner
- Tips for avoiding paper curls
- Tips for avoiding paper jams
- Clearing paper jams
- Solving other problems

REDISTRIBUTING TONER

When the toner cartridge is near the end of its life:

- White streaks or light printing occurs.
- The  LED blinks red.

If this happens, you can temporarily improve print quality by redistributing the remaining toner in the cartridge. In some cases, white streaks or light printing will still occur even after you have redistributed the toner.

1. Open the front cover.
2. Pull the toner cartridge out.

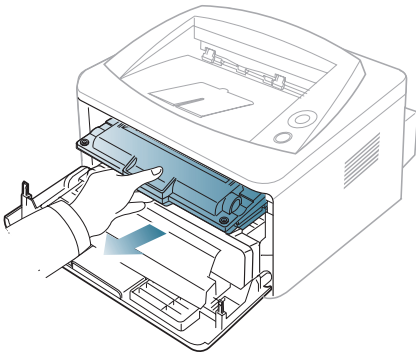

3. Thoroughly roll the cartridge five or six times to distribute the toner evenly inside the cartridge.

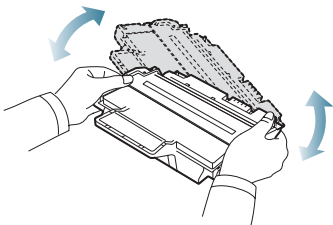

 If toner gets on your clothing, wipe it off with a dry cloth and wash clothing in cold water. Hot water sets toner into fabric.

 Do not touch the green underside of the toner cartridge. Use the handle on the cartridge to avoid touching this area.

4. Hold the toner cartridge by the handle and slowly insert the cartridge into the opening in the machine.

Tabs on the sides of the cartridge and corresponding grooves within the machine will guide the cartridge into the correct position until it locks into place completely.

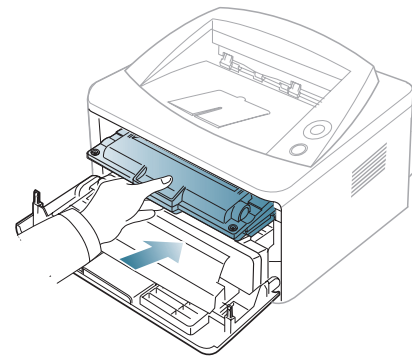

5. Close the front cover. Ensure that the cover is securely closed.

TIPS FOR AVOIDING PAPER CURLS

1. Open the rear cover.
2. Pull down the pressure lever on each side.

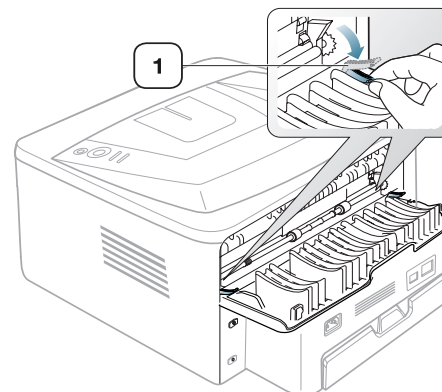

1 Pressure lever

 Keep the rear cover opened during printing. Only use when the printout has more than 20 mm curl.



TIPS FOR AVOIDING PAPER JAMS

By selecting the correct media types, most paper jams can be avoided. When a paper jam occurs, refer to the next guidelines.

- Ensure that the adjustable guides are positioned correctly. (See "Loading paper in the tray" on page 33.)
- Do not overload the tray. Ensure that the paper level is below the paper capacity mark on the inside of the tray.
- Do not remove paper from the tray while your machine is printing.
- Flex, fan, and straighten paper before loading.
- Do not use creased, damp, or highly curled paper.
- Do not mix paper types in a tray.
- Use only recommended print media.
- Ensure that the recommended side of the print media is facing down in the tray, or facing up in the manual tray.

CLEARING PAPER JAMS

If a paper jam occurs, the  LED on the control panel lights orange. Find and remove the jammed paper.

To resume printing after clearing paper jams, you must open and close the front cover.

-  To avoid tearing the paper, pull the jammed paper out slowly and gently. Follow the instructions in the following sections to clear the jam.

In tray

1. Open and close the front cover. The jammed paper is automatically ejected from the machine.
If the paper does not exit, go to the next step.
2. Pull out tray.

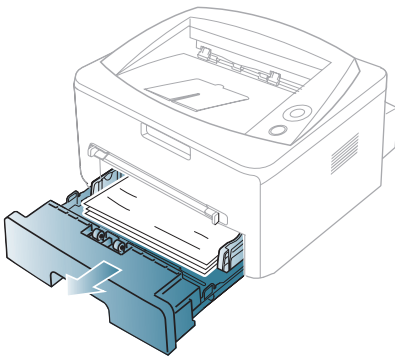

3. Remove the jammed paper by gently pulling it straight out.

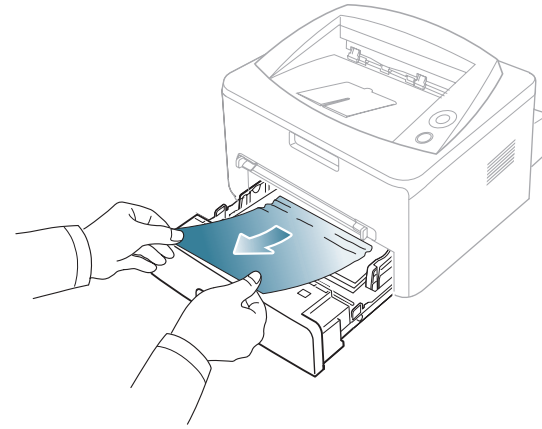

If the paper does not move when you pull, or if you do not see the paper in this area, check the fuser area around the toner cartridge. (See "Inside the machine" on page 54.)

4. Insert tray back into the machine until it snaps into place. Printing automatically resumes.

In the manual tray

1. If the paper is not feeding properly, pull the paper out of the machine.

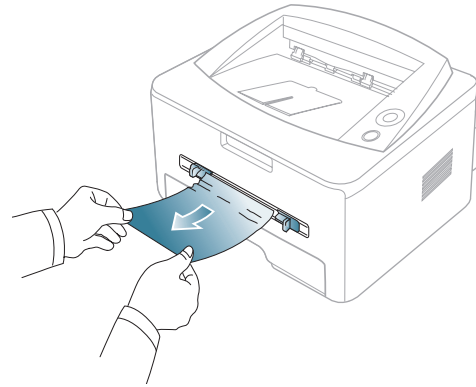

2. Open and close the front cover to resume printing.

Inside the machine

 The fuser area is hot. Take care when removing paper from the machine.

1. Open the front cover and pull the toner cartridge out, lightly pushing it down.

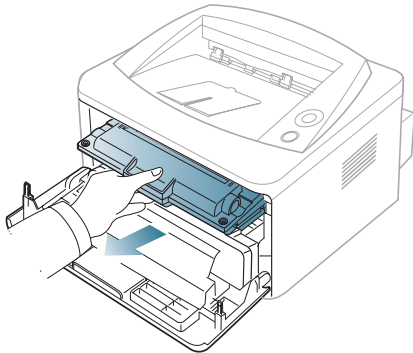

2. Remove the jammed paper by gently pulling it straight out.

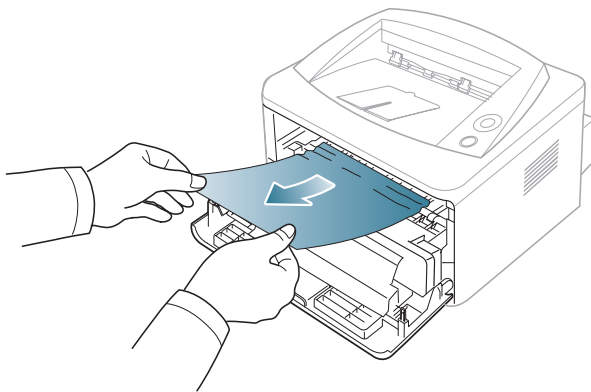

3. Replace the toner cartridge and close the front cover. Printing automatically resumes.

In exit area

1. Open and close the front cover. The jammed paper is automatically ejected from the machine.
If you do not see the jammed paper, go to next step.
2. Gently pull the paper out of the output tray.



If you do not see the jammed paper or if there is any resistance when you pull, stop and go to the next step.

3. Open the rear cover.
4. Pull the pressure levers down and remove the paper.
Return the pressure levers to their original position.

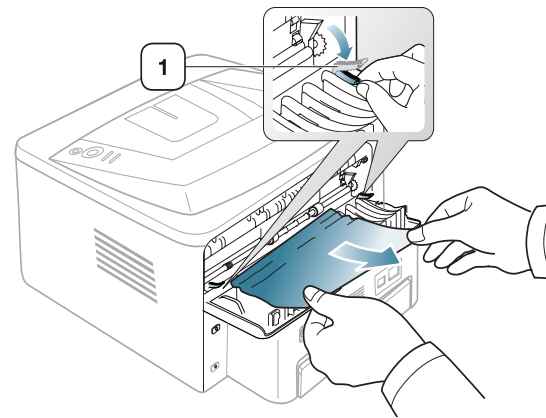

1 Pressure lever

5. Pull the fuser cover levers down and remove the paper.
Return the fuser cover levers to their original position.

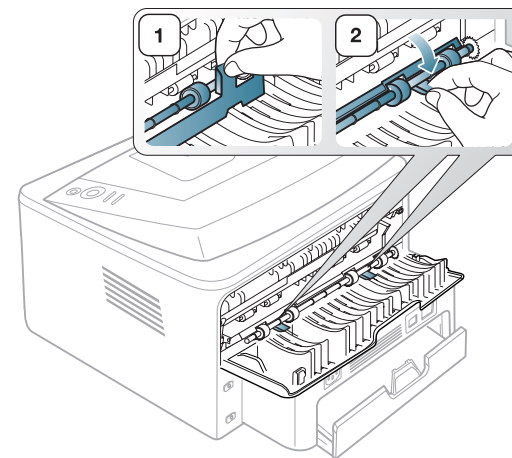

 The fuser area is hot. Take care when removing paper from the machine.

6. Close the rear cover.
7. Open and close front cover, printing automatically resumes.

SOLVING OTHER PROBLEMS

The following chart lists some conditions that may occur and the recommended solutions. Follow the suggested solutions until the problem is corrected. If the problem persists, call for service.

Power problems

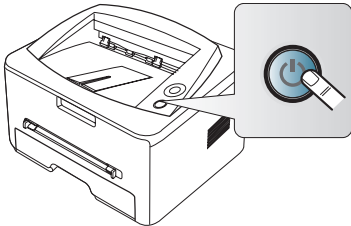
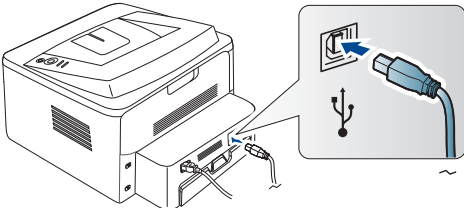
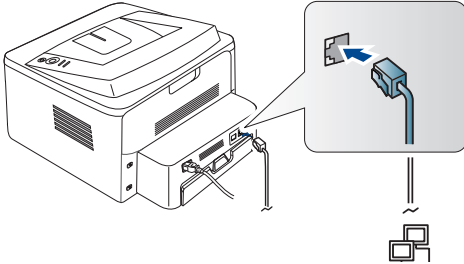
CONDITION	SUGGESTED SOLUTIONS
The machine is not receiving power, or the connection cable between the computer and the machine is not connected properly.	<ul style="list-style-type: none"> Plug in the power cord and press  (power) on the control panel.  <ul style="list-style-type: none"> Disconnect the machine cable and reconnect it. <ul style="list-style-type: none"> - For Local Printing  <ul style="list-style-type: none"> - For Network Printing (Phaser 3160N only) 

Paper feeding problems

CONDITION	SUGGESTED SOLUTIONS
Paper jams during printing.	Clear the paper jam. (See "Clearing paper jams" on page 53.)
Paper sticks together.	<ul style="list-style-type: none"> Check the maximum paper capacity of the tray. (See "Print media specifications" on page 66.) Make sure that you are using the correct type of paper. (See "Print media specifications" on page 66.) Remove paper from the tray and flex or fan the paper. Humid conditions may cause some paper to stick together.
Multiple sheets of paper do not feed.	Different types of paper may be stacked in the tray. Load paper of only one type, size, and weight.
Paper does not feed into the machine.	<ul style="list-style-type: none"> Remove any obstructions from inside the machine. Paper has not been loaded correctly. Remove paper from the tray and reload it correctly. There is too much paper in the tray. Remove excess paper from the tray. The paper is too thick. Use only paper that meets the specifications required by the machine. (See "Print media specifications" on page 66.)
The paper keeps jamming.	<ul style="list-style-type: none"> There is too much paper in the tray. Remove excess paper from the tray. If you are printing on special materials, use the manual tray. An incorrect type of paper is being used. Use only paper that meets the specifications required by the machine. (See "Print media specifications" on page 66.) There may be debris inside the machine. Open the front cover and remove any debris.
Transparencies stick together in the paper exit.	Use only transparencies specifically designed for laser printers. Remove each transparency as it exits from the machine.
Envelopes skew or fail to feed correctly.	Ensure that the paper guides are against both sides of the envelopes.

Printing problems

CONDITION	POSSIBLE CAUSE	SUGGESTED SOLUTIONS
The machine does not print.	The machine is not receiving power.	Check the power cord connections.
	The machine is not selected as the default machine.	Select your machine as your default machine in your Windows.
	Check the machine for the following: <ul style="list-style-type: none"> The front cover is not closed. Close the front cover. Paper is jammed. Clear the paper jam. (See "Clearing paper jams" on page 53.) No paper is loaded. Load paper. (See "Loading paper in the tray" on page 33.) The toner cartridge is not installed. Install the toner cartridge. If a system error occurs, contact your service representative.	
	The connection cable between the computer and the machine is not connected properly.	Disconnect the machine cable and reconnect it.
	The connection cable between the computer and the machine is defective.	If possible, attach the cable to another computer that is working properly and print a job. You can also try using a different machine cable.
	The port setting is incorrect.	Check the Windows printer setting to make sure that the print job is sent to the correct port. If the computer has more than one port, make sure that the machine is attached to the correct one.
	The machine may be configured incorrectly.	Check the Printing Preferences to ensure that all of the print settings are correct. (See "Opening printing preferences" on page 38.)
	The printer driver may be incorrectly installed.	Repair the machine software. (See "Installing driver for USB connected machine" on page 22, "Installing drivers for network connected machine" on page 25.)
	The machine is malfunctioning.	Check the LEDs on the control panel to see if the machine is indicating a system error. Contact a service representative.

CONDITION	POSSIBLE CAUSE	SUGGESTED SOLUTIONS
The machine does not print.	The document size is so big that the hard disk space of the computer is insufficient to access the print job.	Get more hard disk space and print the document again.
	The output tray is full.	It can hold up to 80 sheets of plain paper. Once the paper is removed from the output tray, the machine resumes printing.
The machine selects print materials from the wrong paper source.	The paper option that was selected in the Printing Preferences may be incorrect.	For many software applications, the paper source selection is found under the Paper tab within the Printing Preferences . Select the correct paper source. See the printer driver help screen. (See "Opening printing preferences" on page 38.)
A print job is extremely slow.	The job may be very complex.	Reduce the complexity of the page or try adjusting the print quality settings.
Half the page is blank.	The page orientation setting may be incorrect.	Change the page orientation in your application. See the printer driver help screen.
	The paper size and the paper size settings do not match.	Ensure that the paper size in the printer driver settings matches the paper in the tray. Or, ensure that the paper size in the printer driver settings matches the paper selection in the software application settings you use.



CONDITION	POSSIBLE CAUSE	SUGGESTED SOLUTIONS
The machine prints, but the text is wrong, garbled, or incomplete.	The machine cable is loose or defective.	Disconnect the machine cable and reconnect. Try a print job that you have already printed successfully. If possible, attach the cable and the machine to another computer that you know works and try a print job. Finally, try a new machine cable.
	The wrong printer driver was selected.	Check the application's printer selection menu to ensure that your machine is selected.
	The software application is malfunctioning.	Try printing a job from another application.
	The operating system is malfunctioning.	Exit Windows and reboot the computer. Turn the machine off and back on again.
	If you are in a DOS environment, the font setting for your machine may be set incorrectly.	See "Changing font setting (Phaser 3160B and Phaser 3160N only)" on page 31.
Pages print, but they are blank.	The toner cartridge is defective or out of toner.	Redistribute the toner, if necessary. If necessary, replace the toner cartridge.
	The file may have blank pages.	Check the file to ensure that it does not contain blank pages.
	Some parts, such as the controller or the board, may be defective.	Contact a service representative.
The machine does not print PDF file correctly. Some parts of graphics, text, or illustrations are missing.	Incompatibility between the PDF file and the Acrobat products.	<p>Printing the PDF file as an image may enable the file to print. Turn on Print As Image from the Acrobat printing options.</p> <p> It will take longer to print when you print a PDF file as an image.</p>

CONDITION	POSSIBLE CAUSE	SUGGESTED SOLUTIONS
The print quality of photos is not good. Images are not clear.	The resolution of the photo is very low.	Reduce the photo size. If you increase the photo size in the software application, the resolution will be reduced.
Before printing, the machine emits vapor near the output tray.	Using damp paper can cause vapor during printing.	This is not a problem. Just keep printing.
The machine does not print special- sized paper, such as billing paper.	Paper size and paper size setting do not match.	Set the correct paper size in the Custom in the Paper tab in the Printing Preferences . (See "Opening printing preferences" on page 38.)

Printing quality problems

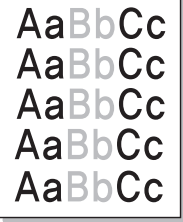
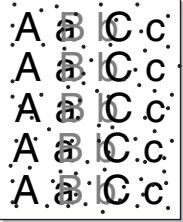
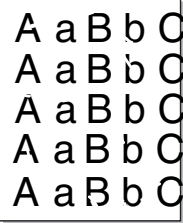
If the inside of the machine is dirty or paper has been loaded improperly, there might be a reduction in print quality. See the table below to clear the problem.

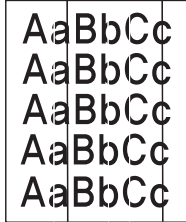
CONDITION	SUGGESTED SOLUTIONS
<p>Light or faded print</p> 	<ul style="list-style-type: none"> If a vertical white streak or faded area appears on the page, the toner supply is low. You may be able to temporarily extend the toner cartridge life. (See "Redistributing toner" on page 52.) If this does not improve the print quality, install a new toner cart The paper may not meet paper specifications; for example, the paper may be too moist or rough. (See "Print media specifications" on page 66.) If the entire page is light, the print resolution setting is too low or the toner save mode is on. Adjust the print resolution and turn the toner save mode off. See the help screen of the printer driver. A combination of faded or smeared defects may indicate that the toner cartridge needs cleaning. (See "Cleaning the inside" on page 50.) The surface of the LSU part inside the machine may be dirty. (See "Cleaning the inside" on page 50.)
<p>Toner specks</p> 	<ul style="list-style-type: none"> The paper may not meet specifications; for example, the paper may be too moist or rough. (See "Print media specifications" on page 66.) The transfer roller may be dirty. Clean the inside of your machine. Contact a service representative. The paper path may need cleaning. Contact a service representative.
<p>Dropouts</p> 	<p>If faded areas, generally rounded, occur randomly on the page:</p> <ul style="list-style-type: none"> A single sheet of paper may be defective. Try reprinting the job. The moisture content of the paper is uneven or the paper has moist spots on its surface. Try a different brand of paper. (See "Print media specifications" on page 66.) The paper lot is bad. The manufacturing processes can cause some areas to reject toner. Try a different kind or brand of paper. Change the printer option and try again. Go to Printing Preferences, click Paper tab, and set type to Thick. (See "Opening printing preferences" on page 38.) If these steps do not correct the problem, contact a service representative.

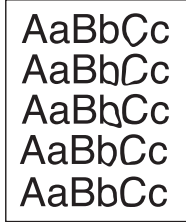
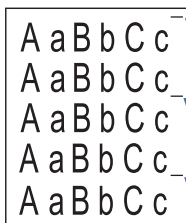
CONDITION	SUGGESTED SOLUTIONS
<p>White Spots</p> 	<p>If white spots appear on the page:</p> <ul style="list-style-type: none"> The paper is too rough and a lot of dirt from a paper falls to the inner devices within the machine, so the transfer roller may be dirty. Clean the inside of your machine. (See "Cleaning the inside" on page 50.) The paper path may need cleaning. (See "Cleaning the inside" on page 50.)
<p>Vertical lines</p> 	<p>If black vertical streaks appear on the page:</p> <ul style="list-style-type: none"> The surface (drum part) of the toner cartridge inside the machine has probably been scratched. Remove the toner cartridge and install a new one. (See "Replacing the toner cartridge" on page 62.) <p>If white vertical streaks appear on the page:</p> <ul style="list-style-type: none"> The surface of the LSU part inside the machine may be dirty. (See "Cleaning the inside" on page 50.)
<p>Black background</p> 	<p>If the amount of background shading becomes unacceptable:</p> <ul style="list-style-type: none"> Change to a lighter weight paper. (See "Print media specifications" on page 66.) Check the environmental conditions: very dry conditions or a high level of humidity (higher than 80% RH) can increase the amount of background shading. Remove the old toner cartridge and, install a new one. (See "Replacing the toner cartridge" on page 62.)
<p>Toner smear</p> 	<p>If toner smears on the page:</p> <ul style="list-style-type: none"> Clean the inside of the machine. (See "Cleaning the inside" on page 50.) Check the paper type and quality. (See "Print media specifications" on page 66.) Remove the toner cartridge and then, install a new one. (See "Replacing the toner cartridge" on page 62.)
<p>Vertical repetitive defects</p> 	<p>If marks repeatedly appear on the printed side of the page at even intervals:</p> <ul style="list-style-type: none"> The toner cartridge may be damaged. If you still have the same problem, remove the toner cartridge and, install a new one. (See "Replacing the toner cartridge" on page 62.) Parts of the machine may have toner on them. If the defects occur on the back of the page, the problem will likely correct itself after a few more pages. The fusing assembly may be damaged. Contact a service representative.

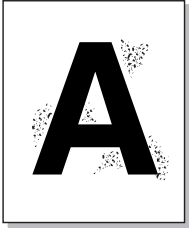
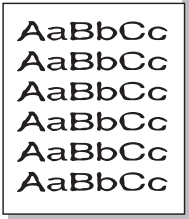
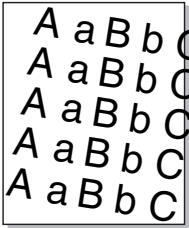
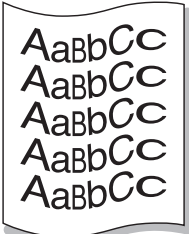
CONDITION	SUGGESTED SOLUTIONS
Background scatter 	<p>Background scatter results from bits of toner randomly distributed on the printed page.</p> <ul style="list-style-type: none"> The paper may be too damp. Try printing with a different batch of paper. Do not open packages of paper until necessary so that the paper does not absorb too much moisture. If background scatter occurs on an envelope, change the printing layout to avoid printing over areas that have overlapping seams on the reverse side. Printing on seams can cause problems. If background scatter covers the entire surface area of a printed page, adjust the print resolution through your software application or in Printing Preferences. (See "Opening printing preferences" on page 38.)
Misformed characters 	<ul style="list-style-type: none"> If characters are improperly formed and producing hollow images, the paper stock may be too slick. Try different paper. (See "Print media specifications" on page 66.)
Page skew 	<ul style="list-style-type: none"> Ensure that the paper is loaded properly. Check the paper type and quality. (See "Print media specifications" on page 66.) Ensure that the guides are not too tight or too loose against the paper stack.
Curl or wave 	<ul style="list-style-type: none"> Ensure that the paper is loaded properly. Check the paper type and quality. Both high temperature and humidity can cause paper curl. (See "Print media specifications" on page 66.) Turn the stack of paper over in the tray. Also try rotating the paper 180° in the tray.

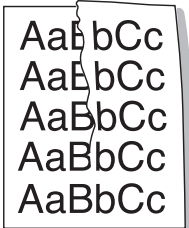
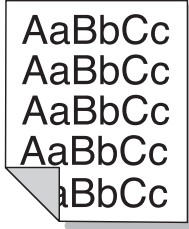
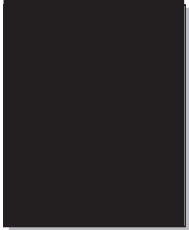
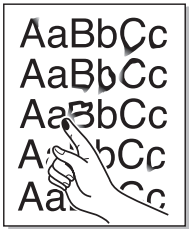
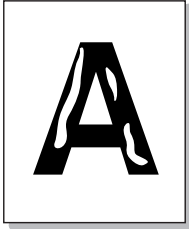
CONDITION	SUGGESTED SOLUTIONS
Wrinkles or creases 	<ul style="list-style-type: none"> Ensure that the paper is loaded properly. Check the paper type and quality. (See "Print media specifications" on page 66.) Turn the stack of paper over in the tray. Also try rotating the paper 180° in the tray.
Back of printouts are dirty 	<p>Check for leaking toner. Clean the inside of the machine. (See "Cleaning the inside" on page 50.)</p>
Solid Color or Black pages 	<ul style="list-style-type: none"> The toner cartridge may not be installed properly. Remove the cartridge and reinsert it. The toner cartridge may be defective. Remove the toner cartridge and install a new one. (See "Replacing the toner cartridge" on page 62.) The machine may require repair. Contact a service representative.
Loose toner 	<ul style="list-style-type: none"> Clean the inside of the machine. (See "Cleaning the inside" on page 50.) Check the paper type and quality. (See "Print media specifications" on page 66.) Remove the toner cartridge and then, install a new one. (See "Replacing the toner cartridge" on page 62.) If the problem persists, the machine may require repair. Contact a service representative.
Character Voids 	<p>Character voids are white areas within parts of characters that should be solid black:</p> <ul style="list-style-type: none"> If you are using transparencies, try another type of transparency. Because of the composition of transparencies, some character voids are normal. You may be printing on the wrong surface of the paper. Remove the paper and turn it around. The paper may not meet paper specifications. (See "Print media specifications" on page 66.)

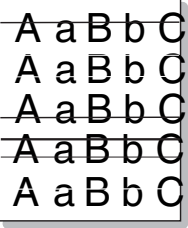
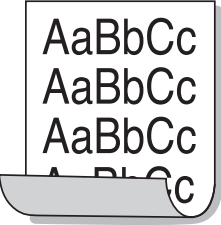
CONDITION	SUGGESTED SOLUTIONS
<p>Horizontal stripes</p> 	<p>If horizontally aligned black streaks or smears appear:</p> <ul style="list-style-type: none"> • The toner cartridge may be installed improperly. Remove the cartridge and reinsert it. • The toner cartridge may be defective. Remove the toner cartridge and install a new one. (See "Replacing the toner cartridge" on page 62.) • If the problem persists, the machine may require repair. Contact a service representative.
<p>Curl</p> 	<p>If the printed paper is curled or paper does not feed into the machine:</p> <ul style="list-style-type: none"> • Turn the stack of paper over in the tray. Also try rotating the paper 180° in the tray. • Change the printer option and try again. Go to Printing Preferences, click Paper tab, and set type to Thin. (See "Opening printing preferences" on page 38.)
<p>An unknown image repeats on a few sheets or loose toner, light print, or contamination occurs.</p>	<p>Your machine is probably being used at an altitude of 1,000 m (3,281 ft) or above. The high altitude may affect the print quality, such as loose toner or light imaging. Change the correct altitude setting to your machine. (See "Altitude adjustment" on page 30.)</p>

Common Windows problems

CONDITION	SUGGESTED SOLUTIONS
<p>"File in Use" message appears during installation.</p>	<p>Exit all software applications. Remove all software from the startup group, then restart Windows. Reinstall the printer driver.</p>
<p>"General Protection Fault", "Exception OE", "Spool 32", or "Illegal Operation" messages appear.</p>	<p>Close all other applications, reboot Windows and try printing again.</p>
<p>"Fail To Print", "A printer timeout error occurred" messages appear.</p>	<p>These messages may appear during printing. Just keep waiting until the machine finishes printing. If the message appears in ready mode or after printing has been completed, check the connection and/or whether an error has occurred.</p>

 Refer to Microsoft Windows user guide that came with your computer for further information on Windows error messages.

Common Linux problems

CONDITION	SUGGESTED SOLUTIONS
<p>The machine does not print.</p>	<ul style="list-style-type: none"> • Check if the printer driver is installed in your system. Open Unified Driver Configurator and switch to the Printers tab in Printers configuration window to look at the list of available machines. Make sure that your machine is displayed on the list. If not, open Add new printer wizard to set up your device. • Check if the machine is started. Open Printers configuration and select your machine on the printers list. Look at the description in the Selected printer pane. If its status contains Stopped string, press the Start button. After that normal operation of the machine should be restored. The "stopped" status might be activated when some problems in printing occurred. • Check if your application has special print option such as "-oraw". If "-oraw" is specified in the command line parameter, then remove it to print properly. For Gimp front-end, select "print" -> "Setup printer" and edit command line parameter in the command item.
<p>The machine does not print whole pages, and output is printed on half the page.</p>	<p>It is a known problem that occurs when a color machine is used on version 8.51 or earlier of Ghostscript, 64-bit Linux OS, and has been reported to bugs.ghostscript.com as Ghostscript Bug 688252. The problem is solved in AFPL Ghostscript v. 8.52 or above. Download the latest version of AFPL Ghostscript from http://sourceforge.net/projects/ghostscript/ and install it to solve this problem.</p>
<p>I encounter error "Cannot open port device file" when printing a document.</p>	<p>Avoid changing print job parameters (via LPR GUI, for example) while a print job is in progress. Known versions of CUPS server break the print job whenever print options are changed and then try to restart the job from the beginning. Since Unified Linux Driver locks the port while printing, the abrupt termination of the driver keeps the port locked and unavailable for subsequent print jobs. If this situation occurs, try to release the port by selecting Release port in Port configuration window.</p>

 Refer to Linux user guide that came with your computer for further information on Linux error messages.

Common Macintosh problems

CONDITION	SUGGESTED SOLUTIONS
The machine does not print PDF files correctly. Some parts of graphics, text, or illustrations are missing.	Printing the PDF file as an image may enable the file to print. Turn on Print As Image from the Acrobat printing options.  It will take longer to print when you print a PDF file as an image.
The document has printed, but the print job has not disappeared from the spooler in Mac OS X10.3.2.	Update your MAC OS to OS MAC OS X 10.3.3. or higher.
Some letters are not displayed normally during the Cover page printing.	Mac OS cannot create the font during the Cover page printing. The English alphabet and numbers are displayed normally on the Cover page.
When printing a document in Macintosh with Acrobat Reader 6.0 or higher, colors print incorrectly.	Make sure that the resolution setting in your machine driver matches the one in Acrobat Reader.

 Refer to Macintosh user guide that came with your computer for further information on Macintosh error messages.

This chapter provides information on purchasing supplies and maintenance parts available for your machine.

This chapter includes:

- How to purchase
- Available supplies
- Available maintenance parts
- Replacing the toner cartridge

 Available accessories may differ from country to country. Contact your sales representatives to obtain the list of available accessories.

HOW TO PURCHASE

To order Xerox-authorized supplies, accessories and, maintenance parts, contact your local Xerox dealer or the retailer where you purchased your machine. You can also visit www.xerox.com/office/support, select your country/region, and obtain information on calling for service.

AVAILABLE SUPPLIES

When supplies reach their lifespan, you can order the following types of supplies for your machine:

TYPE	AVERAGE YIELD ^a	PART NAME
Standard yield toner cartridge	Approx. 1,500 pages	108R00908
High yield toner cartridge	Approx. 2,500 pages	108R00909

a. Declared yield value in accordance with ISO/IEC 19752.

To replace a toner cartridge: (See "Replacing the toner cartridge" on page 62.)

 Depending on the options and job mode used, the toner cartridge's lifespan may differ.

 You must purchase supplies, including toner cartridges, in the same country where you purchased your machine. Otherwise, supplies will be incompatible with your machine since the system configuration of these vary from country to country.

 Xerox does not recommend using non-genuine Xerox toner cartridge such as refilled or remanufactured. Xerox cannot guarantee non-genuine Xerox toner cartridge's quality. Service or repair required as a result of using non-genuine Xerox toner cartridges will not be covered under the machine warranty.

AVAILABLE MAINTENANCE PARTS

To avoid print quality and paper feed problems resulting from worn parts and to maintain your machine in top working condition, the following parts will need to be replaced after printing the specified number of pages or when the life span of each item has expired.

PARTS	AVERAGE YIELD ^a
Transfer roller	Approx. 50,000 pages
Fuser unit	Approx. 50,000 pages
Pickup roller	Approx. 50,000 pages
Cassette unit	Approx. 50,000 pages

a. It will be affected by operating system used, computing performance, application software, connecting method, media type, media size and job complexity.

To purchase maintenance parts, contact the source where you bought the machine.

Replacing maintenance parts can be performed only by an authorized service provider, dealer, or the retailer where you bought the machine. The warranty does not cover the replacement of any maintenance parts after their lifespan.

REPLACING THE TONER CARTRIDGE

When the toner cartridge is empty:

- The Status Monitor program window appears on the computer telling you the toner cartridge needs to be replaced.
- The machine stops printing.

At this stage, the toner cartridge needs to be replaced. Check the type of the toner cartridge for your machine. (See "Available supplies" on page 62.)

1. Open the front cover.
2. Pull the toner cartridge out.

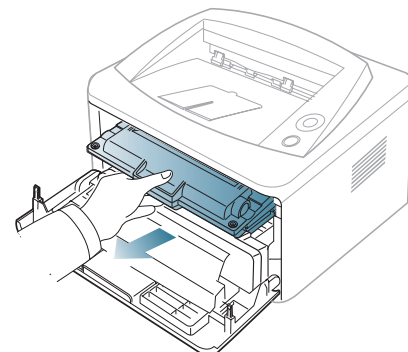

3. Take a new toner cartridge out of its package.

4. Remove the paper protecting the toner cartridge by pulling the packing tape.

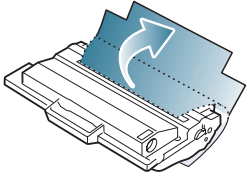

5. Locate the sealing tape at the end of the toner cartridge. Carefully pull the tape completely out of the cartridge and discard it.

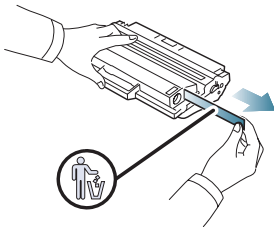

- The sealing tape should be longer than 60 cm when correctly removed.
- Holding the toner cartridge, pull the sealing tape straight to remove it from the cartridge. Be careful not to cut the tape. If this happens, you cannot use the toner cartridge.
- Refer to the helpful pictures on the cartridge wrapping paper.

6. Slowly shake the cartridge five or six times to distribute the toner evenly inside the cartridge. It will assure maximum copies per cartridge.

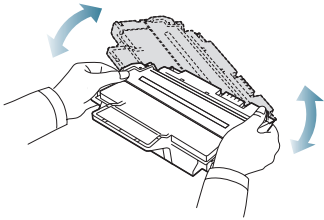

- If toner gets on your clothing, wipe it off with a dry cloth and wash clothing in cold water. Hot water sets toner into fabric.



- Do not touch the green underside of the toner cartridge. Use the handle on the cartridge to avoid touching this area.

7. Hold the toner cartridge by the handle and slowly insert the cartridge into the opening in the machine.

Tabs on the sides of the cartridge and corresponding grooves within the machine will guide the cartridge into the correct position until it locks into place completely.

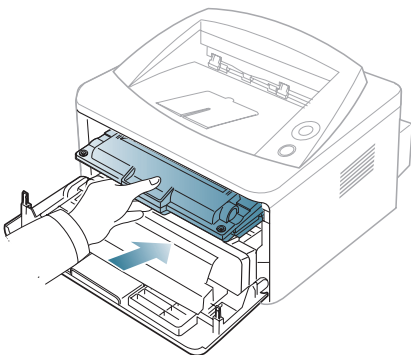

8. Close the front cover. Make sure that the cover is securely closed.

specifications

This chapter guides you about this machine's specifications.

This chapter include:

- Hardware specifications
- Environmental specifications
- Electrical specifications
- Print media specifications

 The specification values here are based on preliminary data. See www.xerox.com/office/support for current information.

HARDWARE SPECIFICATIONS

ITEM		DESCRIPTION
Dimension	Height	230 mm (9.05 inches)
	Depth	389 mm (15.31 inches)
	Width	360 mm (14.17 inches)
Weight	Machine with cartridge	<ul style="list-style-type: none">• Phaser 3140, Phaser 3155, Phaser 3160B: 7.46 Kg (16.45 lbs)• Phaser 3160N: 7.51 Kg (16.56 lbs)

ENVIRONMENTAL SPECIFICATIONS

ITEM		DESCRIPTION
Noise Level ^a	Ready mode	26 dB(A)
	Printing mode	<ul style="list-style-type: none">• Phaser 3140: 50 dB(A)• Phaser 3155, Phaser 3160B, Phaser 3160N: 51 dB(A)
Temperature	Operation	10 to 32 °C (50 to 90 °F)
	Storage (unpacked)	0 to 40 °C (32 to 104 °F)
Humidity	Operation	20 to 80% RH
	Storage (unpacked)	10 to 80% RH

a. Sound Pressure Level, ISO 7779. Configuration tested: machine basic installation, A4 paper, simplex printing.

ELECTRICAL SPECIFICATIONS

 Power requirements are based on the country/region where the device is sold. Do not convert operating voltages. Doing so might damage the device and void the product warranty.

ITEM		DESCRIPTION
Power rating^a	110 volt models	AC 110 - 127 V
	220 volt models	AC 220 - 240 V
Power consumption	Average operating mode	Less than 360 W
	Ready mode	Less than 60 W
	Power save mode	<ul style="list-style-type: none">• Phaser 3140: Less than 4.5 W• Phaser 3155, Phaser 3160B, Phaser 3160N: Less than 6.5 W
	Power off mode	Less than 0.8 W

a. See the rating label on the machine for the correct voltage, frequency (hertz) and type of current for your machine.

PRINT MEDIA SPECIFICATIONS

TYPE	SIZE	DIMENSIONS	PRINT MEDIA WEIGHT ^a /CAPACITY ^b	
			TRAY1	MANUAL TRAY
Plain paper	Letter	216 x 279 mm (8.50 x 11.00 inches)	60 to 105 g/m ² (16 to 28 lb bond) • 250 sheets of 80g/m ² (20 lb bond)	60 to 163 g/m ² (16 to 43 lb bond) • 1 sheet stacking
	Legal	216 x 356 mm (8.50 x 14.00 inches)		
	US Folio	216 x 330 mm (8.50 x 13.00 inches)		
	A4	210 x 297 mm (8.27 x 11.69 inches)		
	Oficio	216 x 343 mm (8.50 x 13.50 inches)		
	JIS B5	182 x 257 mm (7.17 x 10.12 inches)	60 to 90 g/m ² (16 to 24 lb bond) • 150 sheets of 80 g/m ² (20 lb bond)	
	ISO B5	176 x 250 mm (6.93 x 9.84 inches)		
	Executive	184 x 267 mm (7.25 x 0 inches)		
	A5	148 x 210 mm (5.83 x 8.27 inches)		
	A6	105 x 148 mm (4.13 x 5.83 inches)		
Envelope	Envelope Monarch	98 x 191 mm (3.87 x 7.50 inches)	Not available in tray1.	75 to 90 g/m ² (20 to 24 lb bond) • 1 sheet stacking
	Envelope No. 10	105 x 241 mm (4.12 x 9.50 inches)		
	Envelope DL	110 x 220 mm (4.33 x 8.66 inches)		
	Envelope C5	162 x 229 mm (6.38 x 9.02 inches)		
	Envelope C6	114 x 162 mm (4.49 x 6.38 inches)		
Thick paper	Refer to the Plain paper section	Refer to the Plain paper section	90 g/m ² (28 lb bond)	90 g/m ² (32 lb bond) • 1 sheet stacking
Thin paper	Refer to the Plain paper section	Refer to the Plain paper section	60 to 70 g/m ² (16 to 19 lb bond)	60 to 70 g/m ² (16 to 19 lb bond) • 1 sheet stacking
Transparency	Refer to the Plain paper section	Refer to the Plain paper section	Not available in tray1.	138 to 146 g/m ² (36.81 to 38.91 lb bond) • 1 sheet stacking
Labels ^c	Letter, Legal, US Folio, A4, JIS B5, ISO B5, Executive, A5, Statement	Refer to the Plain paper section	Not available in tray1.	120 to 150 g/m ² (32 to 40 lb bond) • 1 sheet stacking
Card stock	Letter, Legal, US Folio, A4, JIS B5, ISO B5, Executive, A5, Statement, PostCard 4x6	Refer to the Plain paper section	Not available in tray1.	105 to 163 g/m ² (28 to 43 lb bond) • 1 sheet stacking
Minimum size (custom)		76 x 127 mm (3.00 x 5.00 inches)	60 to 105 g/m ² (16 to 28 lb bond)	
Maximum size (custom)		216 x 356 mm (8.50 x 14.02 inches)		

a. If media weight is over 120 g/m² (32 lb), load a paper into the tray one by one.

b. Maximum capacity may differ depending on media weight, thickness, and environmental conditions.

c. Smoothness: 100 to 250 (sheffield)

 The following glossary helps you get familiar with the product by understanding the terminologies commonly used with printing as well as mentioned in this user guide.

AppleTalk

AppleTalk is a proprietary suite of protocols developed by Apple, Inc for computer networking. It was included in the original Macintosh (1984) and is now deprecated by Apple in favor of TCP/IP networking.

BIT Depth

A computer graphics term describing the number of bits used to represent the color of a single pixel in a bitmapped image. Higher color depth gives a broader range of distinct colors. As the number of bits increases, the number of possible colors becomes impractically large for a color map. 1-bit color is commonly called as monochrome or black and white.

BMP

A bitmapped graphics format used internally by the Microsoft Windows graphics subsystem (GDI), and used commonly as a simple graphics file format on that platform.

BOOTP

Bootstrap Protocol. A network protocol used by a network client to obtain its IP address automatically. This is usually done in the bootstrap process of computers or operating systems running on them. The BOOTP servers assign the IP address from a pool of addresses to each client. BOOTP enables 'diskless workstation' computers to obtain an IP address prior to loading any advanced operating system.

CCD

Charge Coupled Device (CCD) is a hardware which enables the scan job. CCD Locking mechanism is also used to hold the CCD module to prevent any damage when you move the machine.

Collation

Collation is a process of printing a multiple-copy job in sets. When collation is selected, the device prints an entire set before printing additional copies.

Control Panel

A control panel is a flat, typically vertical, area where control or monitoring instruments are displayed. They are typically found in front of the machine.

Coverage

It is the printing term used for a toner usage measurement on printing. For example, 5% coverage means that an A4 sided paper has about 5% image or text on it. So, if the paper or original has complicated images or lots of text on it, the coverage will be higher and at the same time, a toner usage will be as much as the coverage.

CSV

Comma Separated Values (CSV). A type of file format, CSV is used to exchange data between disparate applications. The file format, as it is used in Microsoft Excel, has become a pseudo standard throughout the industry, even among non-Microsoft platforms.

Default

The value or setting that is in effect when taking a printer out of its box state, reset, or initialized.

DHCP

A Dynamic Host Configuration Protocol (DHCP) is a client-server networking protocol. A DHCP server provides configuration parameters specific to the DHCP client host requesting, generally, information required by the client host to participate on an IP network. DHCP also provides a mechanism for allocation of IP addresses to client hosts.

DIMM

Dual Inline Memory Module (DIMM), a small circuit board that holds memory. DIMM stores all the data within the machine like printing data, received fax data.

DNS

The Domain Name Server (DNS) is a system that stores information associated with domain names in a distributed database on networks, such as the Internet.

Dot Matrix Printer

A dot matrix printer refers to a type of computer printer with a print head that runs back and forth on the page and prints by impact, striking an ink-soaked cloth ribbon against the paper, much like a typewriter.

DPI

Dots Per Inch (DPI) is a measurement of resolution that is used for scanning and printing. Generally, higher DPI results in a higher resolution, more visible detail in the image, and a larger file size.

Duplex

A mechanism that will automatically flip over a sheet of paper so that the machine can print (or scan) on both sides of the paper. A printer equipped with a Duplex can print double-sided of paper.

Duty Cycle

Duty cycle is the page quantity which does not affect printer performance for a month. Generally the printer has the lifespan limitation such as pages per year. The lifespan means the average capacity of print-outs, usually within the warranty period. For example, if the duty cycle is 48,000 pages per month assuming 20 working days, a printer limits 2,400 pages a day.

Emulation

Emulation is a technique of one machine obtaining the same results as another.

An emulator duplicates the functions of one system with a different system, so that the second system behaves like the first system. Emulation focuses on exact reproduction of external behavior, which is in contrast to simulation, which concerns an abstract model of the system being simulated, often considering its internal state.

Ethernet

Ethernet is a frame-based computer networking technology for local area networks (LANs). It defines wiring and signaling for the physical layer, and frame formats and protocols for the media access control (MAC)/data link layer of the OSI model. Ethernet is mostly standardized as IEEE 802.3. It has become the most widespread LAN technology in use during the 1990s to the present.

EtherTalk

A suite of protocols developed by Apple Computer for computer networking. It was included in the original Macintosh (1984) and is now deprecated by Apple in favor of TCP/IP networking.

FTP

A File Transfer Protocol (FTP) is a commonly used protocol for exchanging files over any network that supports the TCP/IP protocol (such as the Internet or an intranet).

Fuser Unit

The part of a laser printer that melts the toner onto the print media. It consists of a hot roller and a back-up roller. After toner is transferred onto the paper, the fuser unit applies heat and pressure to ensure that the toner stays on the paper permanently, which is why paper is warm when it comes out of a laser printer.

Gateway

A connection between computer networks, or between a computer network and a telephone line. It is very popular, as it is a computer or a network that allows access to another computer or network.

Grayscale

A shades of gray that represent light and dark portions of an image when color images are converted to grayscale; colors are represented by various shades of gray.

Halftone

An image type that simulates grayscale by varying the number of dots. Highly colored areas consist of a large number of dots, while lighter areas consist of a smaller number of dots.

IEEE

The Institute of Electrical and Electronics Engineers (IEEE) is an international non-profit, professional organization for the advancement of technology related to electricity.

IEEE 1284

The 1284 parallel port standard was developed by the Institute of Electrical and Electronics Engineers (IEEE). The term "1284-B" refers to a specific connector type on the end of the parallel cable that attaches to the peripheral (for example, a printer).

Intranet

A private network that uses Internet Protocols, network connectivity, and possibly the public telecommunication system to securely share part of an organization's information or operations with its employees. Sometimes the term refers only to the most visible service, the internal website.

IP address

An Internet Protocol (IP) address is a unique number that devices use in order to identify and communicate with each other on a network utilizing the Internet Protocol standard.

IPM

The Images Per Minute (IPM) is a way of measuring the speed of a printer. An IPM rate indicates the number of single-sided sheets a printer can complete within one minute.

IPP

The Internet Printing Protocol (IPP) defines a standard protocol for printing as well as managing print jobs, media size, resolution, and so forth. IPP can be used locally or over the Internet to hundreds of printers, and also supports access control, authentication, and encryption, making it a much more capable and secure printing solution than older ones.

ISO

The International Organization for Standardization (ISO) is an international standard-setting body composed of representatives from national standards bodies. It produces world-wide industrial and commercial standards.

JPEG

Joint Photographic Experts Group (JPEG) is a most commonly used standard method of lossy compression for photographic images. It is the format used for storing and transmitting photographs on the World Wide Web.

LDAP

The Lightweight Directory Access Protocol (LDAP) is a networking protocol for querying and modifying directory services running over TCP/IP.

LED

A Light-Emitting Diode (LED) is a semiconductor device that indicates the status of a machine.

MAC address

Media Access Control (MAC) address is a unique identifier associated with a network adapter. MAC address is a unique 48-bit identifier usually

written as 12 hexadecimal characters grouped in pairs (e. g., 00-00-0c-34-11-4e). This address is usually hard-coded into a Network Interface Card (NIC) by its manufacturer, and used as an aid for routers trying to locate machines on large networks.

MFP

Multi Function Peripheral (MFP) is an office machine that includes the following functionality in one physical body, so as to have a printer, a copier, a fax, a scanner and etc.

NetWare

A network operating system developed by Novell, Inc. It initially used cooperative multitasking to run various services on a PC, and the network protocols were based on the archetypal Xerox XNS stack. Today NetWare supports TCP/IP as well as IPX/SPX.

OPC

Organic Photo Conductor (OPC) is a mechanism that makes a virtual image for print using a laser beam emitted from a laser printer, and it is usually green or gray colored and a cylinder shaped.

An exposing unit of a drum is slowly worn away by its usage of the printer, and it should be replaced appropriately since it gets scratches from grits of a paper.

OSI

Open Systems Interconnection (OSI) is a model developed by the International Organization for Standardization (ISO) for communications. OSI offers a standard, modular approach to network design that divides the required set of complex functions into manageable, self-contained, functional layers. The layers are, from top to bottom, Application, Presentation, Session, Transport, Network, Data Link and Physical.

PCL

Printer Command Language (PCL) is a Page Description Language (PDL) developed by HP as a printer protocol and has become an industry standard. Originally developed for early inkjet printers, PCL has been released in varying levels for thermal, matrix printer, and page printers.

PDF

Portable Document Format (PDF) is a proprietary file format developed by Adobe Systems for representing two dimensional documents in a device independent and resolution independent format.

PostScript

PostScript (PS) is a page description language and programming language used primarily in the electronic and desktop publishing areas. - that is run in an interpreter to generate an image.

Printer Driver

A program used to send commands and transfer data from the computer to the printer.

Print Media

The media like paper, envelopes, labels, and transparencies which can be used on a printer, a scanner, a fax or, a copier.

PPM

Pages Per Minute (PPM) is a method of measurement for determining how fast a printer works, meaning the number of pages a printer can produce in one minute.

PRN file

An interface for a device driver, this allows software to interact with the device driver using standard input/output system calls, which simplifies many tasks.

Protocol

A convention or standard that controls or enables the connection, communication, and data transfer between two computing endpoints.

PS

See PostScript.

RADIUS

Remote Authentication Dial In User Service (RADIUS) is a protocol for remote user authentication and accounting. RADIUS enables centralized management of authentication data such as usernames and passwords using an AAA (authentication, authorization, and accounting) concept to manage network access.

Resolution

The sharpness of an image, measured in Dots Per Inch (DPI). The higher the dpi, the greater the resolution.

SMB

Server Message Block (SMB) is a network protocol mainly applied to share files, printers, serial ports, and miscellaneous communications between nodes on a network. It also provides an authenticated Inter-process communication mechanism.

SMTP

Simple Mail Transfer Protocol (SMTP) is the standard for e-mail transmissions across the Internet. SMTP is a relatively simple, text-based protocol, where one or more recipients of a message are specified, and then the message text is transferred. It is a client-server protocol, where the client transmits an email message to the server.

Subnet Mask

The subnet mask is used in conjunction with the network address to determine which part of the address is the network address and which part is the host address.

TCP/IP

The Transmission Control Protocol (TCP) and the Internet Protocol (IP); the set of communications protocols that implement the protocol stack on which the Internet and most commercial networks run.

TCR

Transmission Confirmation Report (TCR) provides details of each transmission such as job status, transmission result and number of

pages sent. This report can be set to print after each job or only after failed transmissions.

TIFF

Tagged Image File Format (TIFF) is a variable-resolution bitmapped image format. TIFF describes image data that typically come from scanners. TIFF images make use of tags, keywords defining the characteristics of the image that is included in the file. This flexible and platform-independent format can be used for pictures that have been made by various image processing applications.

Toner Cartridge

A kind of bottle within a machine like printer which contains toner. Toner is a powder used in laser printers and photocopiers, which forms the text and images on the printed paper. Toner can be melted by the heat of the fuser, causing it to bind to the fibers in the paper.

UNC Path

Uniform Naming Convention (UNC) is a standard way to access network shares in Window NT and other Microsoft products. The format of a UNC path is: \\<servername>\<sharename>\<Additional directory>

URL

Uniform Resource Locator (URL) is the global address of documents and resources on the Internet. The first part of the address indicates what protocol to use, the second part specifies the IP address or the domain name where the resource is located.

USB

Universal Serial Bus (USB) is a standard that was developed by the USB Implementers Forum, Inc., to connect computers and peripherals. Unlike the parallel port, USB is designed to concurrently connect a single computer USB port to multiple peripherals.

Watermark

A watermark is a recognizable image or pattern in paper that appears lighter when viewed by transmitted light. Watermarks were first introduced in Bologna, Italy in 1282; they have been used by papermakers to identify their product, and also on postage stamps, currency, and other government documents to discourage counterfeiting.

A

adjusting
tray size 30

B

booklet printing 39

booklets 39

C

CentreWare IS
general information 46

change percentage of your document 39

cleaning
inside 50
outside 50

cleaning a machine 50

control panel 18

convention 12

D

duplex printing (manual)
printer driver 39

F

favorites settings, for printing 38

features 14
machine features 64
power saving feature 31
print media feature 66
printer driver 37
supplied software 21

font setting 31

front view 16

G

glossary 67

I

information 7

J

jam
clearing paper 53
tips for avoiding paper jams 53

L

Linux
common Linux problems 60
driver installation for network connected
27
driver installation for USB cable connected
23
printer properties 45
printing 44
supplied softwares 21
system requirements 21
unified driver configurator 48
using SetIP 28
using setip program 47

loading
paper in manual tray 33
paper in the tray1 33
special media 34

M

Macintosh
common Macintosh problems 61
driver installation for network connected
26
driver installation for USB cable connected
23
printing 42
sharing a machine locally 24
supplied softwares 21
system requirements 21
using SetIP 28
using setip program 47

maintenance parts 62

manual tray
loading 33
tips on using 33
using special media 34

N

network

driver installation
Linux 27
Macintosh 26
Windows 25
installing environment 25
introducing network programs 25
IPv6 configuration 29
SetIP program 27, 28, 47
using a wired network 27

N-up printing

Macintosh 44
Windows 38

O

output support 36

overlay printing
create 41
delete 41
print 41

P

placing a machine 20
adjusting the altitude 30
spacing 20

poster, print 39

power saver
using power save mode 31

print media

card stock 35
envelope 34
glossy paper 36
guidelines 32
labels 35
letterhead paper 36
output support 66
photo paper 36
preprinted paper 36
setting the default tray and paper
in the computer 30
transparency 35

print resolution, set
Linux 44
Macintosh 43

printer driver
features 37

printer properties

- Linux 45
- printing
 - changing the default print settings 41
 - fitting your document to a selected paper size 40
 - Linux 44
 - Macintosh 42
 - multiple pages on one sheet of paper
 - Macintosh 44
 - Windows 38
 - poster 39
 - printing a document
 - Windows 37
 - printing on both sides of paper
 - Windows 39
 - printing to a file 42
- printing a document
 - Linux 44
 - Macintosh 42
- problems
 - paper feeding problems 55
 - printing quality problems 58

R

- rear view 17
- reports
 - network MAC address 47

S

- safety
 - information 7
- SetIP program 27, 28, 47
- specifications
 - general 64
 - print media 66
- Status Monitorl
 - general information 46
- supplies
 - available supplies 62
 - estimated toner cartridge life 51
 - ordering 62
 - replacing toner cartridge 62

T

- toner cartridge
 - estimated life 51
 - handling instructions 51
 - non-Xerox and refilled 51
 - redistributing toner 52
 - replacing the cartridge 62
 - storing 51

- tray

- adjusting the width and length 32
- changing the tray size 32
- loading paper in manual tray 33
- turning on the machine 19

U

- understanding the control panel 19
 - cancel button 19
- USB cable
 - driver installation 22
- using help 38
- using overlay in windows 40
- using setip program
 - Linux 47
 - Macintosh 47
 - Windows 47
- using watermarks in windows 40

W

- watermark
 - create 40
 - delete 40
 - edit 40
 - print 40
- Windows
 - common Windows problems 60
 - driver installation for network connected 25
 - driver installation for USB cable connected 22
 - printing 37
 - sharing a machine locally 24
 - supplied software 21
 - system requiremnets 21
 - using SetIP 27
 - using setip program 47

Free Manuals Download Website

<http://myh66.com>

<http://usermanuals.us>

<http://www.somanuals.com>

<http://www.4manuals.cc>

<http://www.manual-lib.com>

<http://www.404manual.com>

<http://www.luxmanual.com>

<http://aubethermostatmanual.com>

Golf course search by state

<http://golfingnear.com>

Email search by domain

<http://emailbydomain.com>

Auto manuals search

<http://auto.somanuals.com>

TV manuals search

<http://tv.somanuals.com>