

Xerox: XC351, XC355, XC356,

User Guide

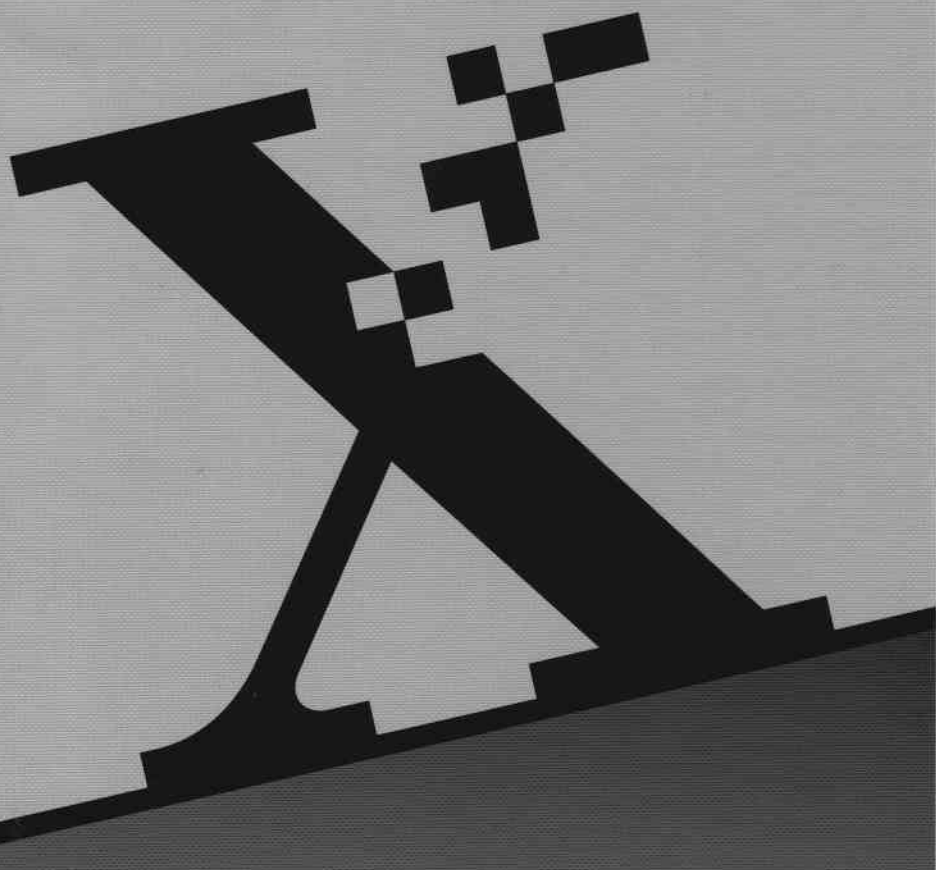

THE DOCUMENT COMPANY
XEROX

FCC Compliance in the USA

WARNING: This equipment has been tested and found to comply with the limits for a Class B digital device pursuant to Part 15 of the FCC Rules. These limits are designed to provide reasonable protection against harmful interference in a residential installation. This equipment generates, uses and can radiate radio frequency energy and, if not installed and used in accordance with the instructions, may cause harmful communications. However, there is no guarantee that interference will not occur in a particular installation. If this equipment does cause harmful interference to radio or television reception, which can be determined by turning the equipment off and on, the user is encouraged to try to correct the interference by one or more of the following measures:



- Reorient or relocate the receiving antenna.
- Increase the separation between the equipment and the receiver.
- Connect the equipment into an outlet on a different circuit than the receiver.
- Consult the dealer or an experienced radio/TV technician for help.

EME Compliance in Canada

This Class B digital apparatus meets all requirements of the Canadian Interference-Causing Equipment regulations.

©1997 XEROX CORPORATION. XEROX®, The Document Company®, the stylized X, and the identifying product names and numbers herein are registered trademarks of XEROX CORPORATION. Xerox Canada Ltd. is the licensee of all the trademarks. All non-Xerox brands and product names are trademarks or registered trademarks of their respective companies.

Table of Contents

Safety Notes	1
How to Obtain a French or Spanish User Guide	4
Space Requirements	4
Helpful Hints	5
Getting to Know Your Copier	6
Rear View	7
Underside View	7
Unpacking	8
Installation	9
Control Panel	11
Paper Specifications	12
Making Copies on the XC351	13
Making Copies on the XC355 and XC356	14
Copy Quality	16
Two-Sided Copying	17
Setting Copy Exposure Range	18
 Paper Supply Indicator (XC355 and XC356)	19
 Misfeed Removal	20
Paper Feed Slot	20
Exit Area	20
Internal Area	21
 Toner Cartridge Replacement	23
Toner Cartridge Yield	25
Drum Cartridge Replacement	26
Problem Solving	29
Problem Solving Chart	29
Status Code Chart	31

Servicing Your Copier	32
Ordering Supplies	32
Copier Maintenance	33
Document Glass and Cover.....	33
Lens.....	33
Packing the Copier	34
Technical Data	36
3-Year Limited Warranty	38
In the USA.....	38
In Canada.....	40
It's Illegal	42
In the USA.....	42
In Canada.....	42
Xerox Guarantee	43
Material Safety Data Sheet	44

Introduction

Congratulations on acquiring your new Xerox Copier. The features, ease of operation, and reliability of the copier allow you to concentrate on your business and leave the copying to your copier and Team Xerox experts.

Supplies

To order supplies for your copier, call or visit your local retailer. If your store does not stock these items, you may call the following number.

In the United States and Canada:

Xerox SupplyNet toll free at: **1 – 800 – 822 – 2200**

Toner Cartridge: 6R737

Copy Cartridge: 13R83

Information

To get answers for any other questions you might have regarding your copier, to register your warranty by phone, or for assistance with the installation of your copier you may call:

1 – 800 – TEAM – XRX (1 – 800 – 832 – 6979)

Service

A Customer Service Support Representative will assist you in keeping your copier operational and, if required, will arrange for service. Call our experts at:

1 – 800 – TEAM – XRX (1 – 800 – 832 – 6979)

The following information will be needed when you call Xerox:

Machine Type: **XC** _____

Machine serial number: _____



(Located on the back cover of the copier above the power receptacle.)

Visit the Xerox Web site at: <http://www.xerox.com/soho.html>

Safety Notes

Your copier and supplies have been designed and tested to meet strict safety requirements. These include safety agency examination and approval, and compliance to established environmental standards. Please read the following instructions carefully before operating the copier and refer to them as needed to ensure the continued safe operation of your copier.

Follow all warnings and instructions marked on or supplied with the product.

Symbology:  = High Voltage,  = Heated Surface.

Unplug this copier from the wall outlet before cleaning. Always use materials specifically designated for this copier. Use of other materials may result in poor performance and could create a hazardous situation.

Do not use aerosol cleaners. Follow the instructions in this User Guide for proper cleaning methods.

Never use supplies or cleaning materials for purposes other than what they were intended. Keep all supplies and materials out of reach of children.

Do not use this copier near water, wet locations, or outdoors.

Do not place this copier on an unstable cart, stand, or table. The copier may fall, causing personal injury or serious damage to the copier.

This product is equipped with a 3-wire grounding type plug (e.g., a plug having a third grounding pin). This plug will fit only into a grounding-type power outlet. This is a safety feature. To avoid risk of electric shock, contact your electrician to replace the receptacle if you are unable to insert the plug into the outlet. Never use a grounding adapter plug to connect the copier to a power source receptacle that lacks a ground connection terminal.

This copier should be operated from the type of power source indicated on the marking label. If you are not sure of the type of power available, consult your local power company.

Safety Notes

Do not allow anything to rest on the power cord. Do not locate the copier where persons will step on the cord.

The power supply cord is the disconnect device for this equipment. Insure that installation is near the outlet and is easily accessible.

Your machine is equipped with an energy saving device to conserve power when the machine is not in use. The machine may be left on continuously.

Slots and Openings in the cabinet and in the back and sides of the copier are provided for ventilation. To ensure reliable operation of the copier and to protect it from overheating, these openings must not be blocked or covered. The copier should never be located near or over a radiator or heat register. This copier should not be placed in a built-in installation unless proper ventilation is provided.

Never push objects of any kind into the slots of the copier as they may touch dangerous voltage points or short out parts which could result in a fire or electric shock.

Never spill liquid of any kind on the copier.

Never remove covers or guards that require a tool for removal. There are no casual operator serviceable areas within these covers.

Never defeat interlock switches. Machines are designed to restrict operator access to unsafe areas. Covers, guards, and interlock switches are provided to ensure that the machine will not operate with covers opened.

Use of an extension cord with this copier is not recommended or authorized. Users should check building codes and insurance requirements if an extension cord is to be used. Ensure that the total ampere ratings of the products plugged into the extension cord do not exceed the extension cord ampere rating. Also, make sure that the total amperage of all products plugged into the wall outlet does not exceed the outlet rating.

Safety Notes

Avoid direct viewing of the document lights. The lamps are bright and, while not harmful, they may cause an annoying afterimage. Always keep the document cover closed during operation and storage.

Avoid exposing the drum cartridge to light for extended periods of time.

Do not touch the red photoreceptor. Scratches or smudges that appear on the photoreceptor will result in poor copy quality and may shorten the service life.

Do not put your hands into the fuser area, located just inside the exit area, as you may be burned.

Ozone: This product produces ozone during normal operation. The ozone produced is dependent on copy volume and is heavier than air. Providing the correct environmental parameters, as specified in the Xerox installation procedures, will ensure that concentration levels meet safe limits.

If you need additional safety information concerning the copier or Xerox supplied materials, you may call the following toll-free number:

In the United States or Canada: 1 - 800 - 828 - 6571.

How to Obtain a French or Spanish User Guide

Au Canada et aux États-Unis, pour obtenir la version française du présent guide d'utilisation, veuillez composer:

1 - 800 - TEAM - XRX (1 - 800 - 832 - 6979)

À l'extérieur des États-Unis et du Canada, veuillez communiquer avec votre représentant Xerox.

Para obtener la versión en español dentro de los Estados Unidos y Canadá llame al:

1 - 800 - TEAM - XRX (1 - 800 - 832 - 6979)

Fuera de los Estados Unidos y Canadá llame a su representante local de Xerox.

Space Requirements

After selecting a location that meets the conditions listed in the **Helpful Hints** section, ensure that there is sufficient space around the copier.

XC351

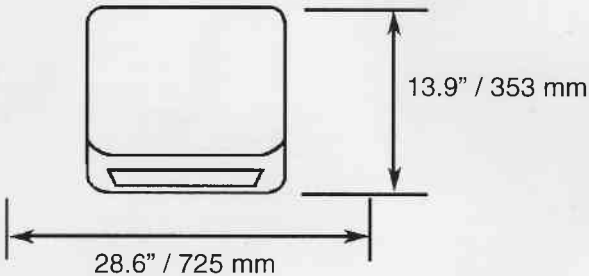

XC355 and XC356

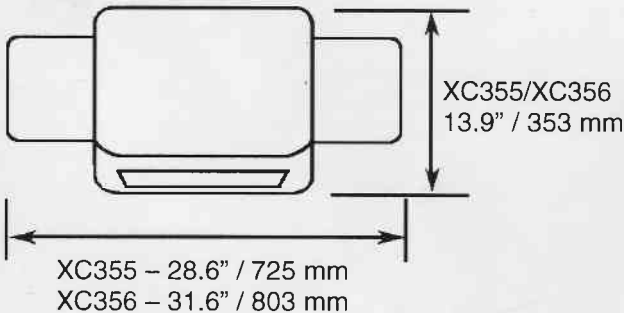

Helpful Hints

Care of your copier

- Do not place heavy objects on any surface of the copier.
- Take care not to place liquids on or near the copier.
- Avoid placing clips or staples on any copier surface.

Maintenance

- Clean the Document Glass daily and as required.
- Do not apply cleaning liquids or sprays directly to the copier; apply to the cloth first.
- Store copy paper in a dry area, on a flat surface, and in a closed cabinet.
- Wrap partially-used reams of paper tightly.

Copier location

For reliable copier operation and copy quality, Xerox recommends:

- Place your copier in a well-ventilated room.
- Recommended environment:
 - Temperature: 50° to 90°F / 10° to 32°C.
 - Humidity: 20% to 85%.
- Place the copier on a flat, level surface.
- Avoid locations that subject the copier to:
 - Direct sunlight.
 - Extreme changes in temperature or humidity.

Getting to Know Your Copier

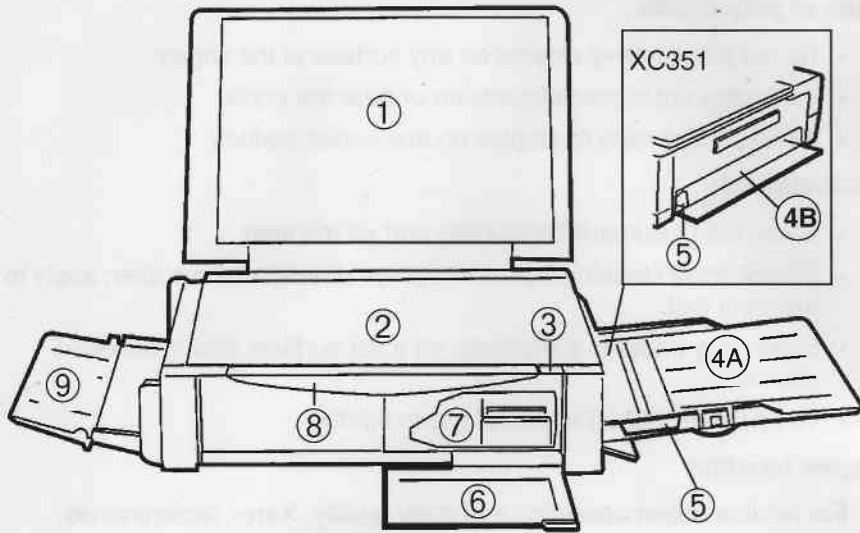

- ① Document Cover
- ② Document Glass
- ③ Front Cover Open Button
- ④A Paper Tray (XC355 and XC356 copiers)
- ④B Paper Feed Slot (XC351 copier)
- ⑤ Paper Guide
- ⑥ Front Cover
- ⑦ Toner Cartridge (Starter Cartridge included)
- ⑧ Control Panel
- ⑨ Exit Tray (XC355 and XC356 copiers)

Getting to Know Your Copier

Rear View

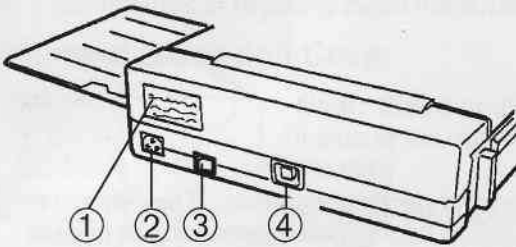

- ① Copier Serial Number
- ② Power Cord Receptacle
- ③ Power Switch
- ④ Documentation Glass Release Button

Underside View

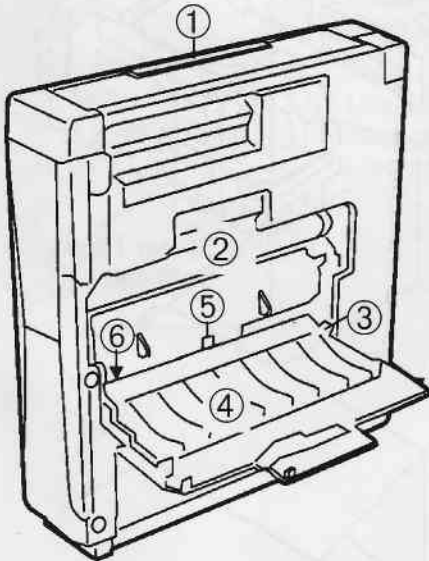

- ① Handle
- ② Drum Cartridge
- ③ Bottom Cover Release Lever
- ④ Bottom Cover
- ⑤ Drum Cartridge Release Lever
- ⑥ Fusing Area

Unpacking

Remove the contents:

- Copier
- User Guide
- Starter Cartridge
- Power Cord
- Packing Material

IMPORTANT: Save the carton and packing materials. They should be used to repack the copier if it has to be shipped for servicing or in case you move.

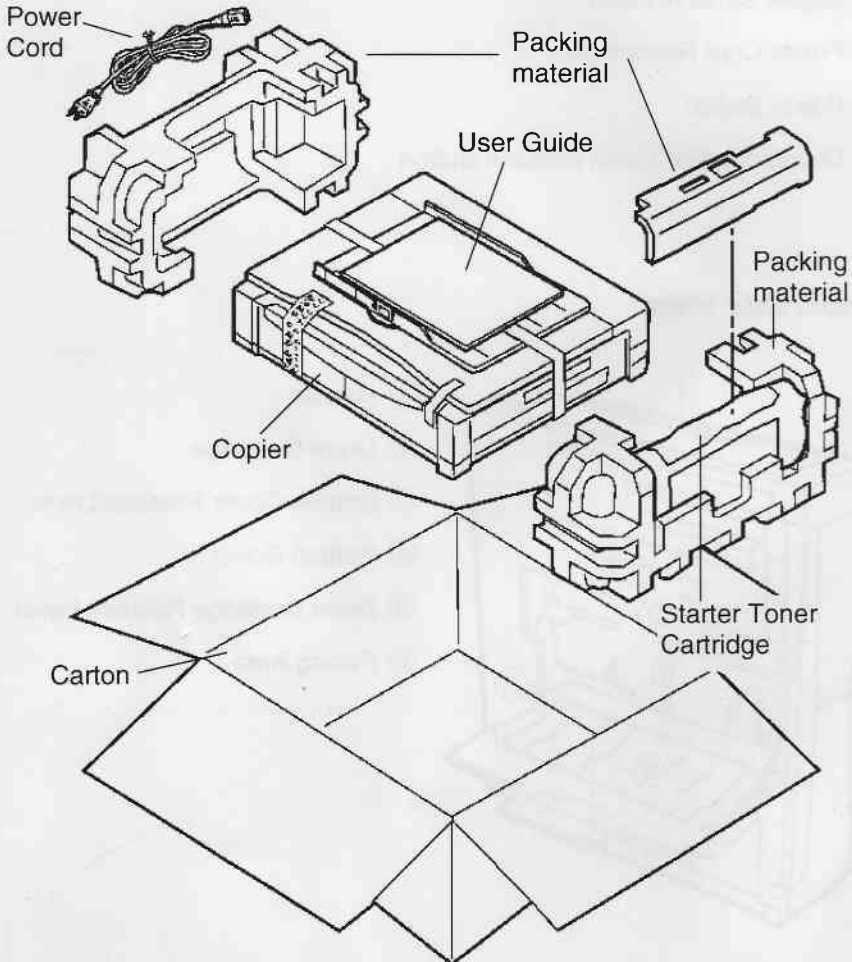

Installation

If the copier is moved from a cold place to a warm place, condensation may form inside the copier. Operation of the copier in this condition will cause poor copy quality and malfunctions. Leave the copier at room temperature for at least 2 hours before use.

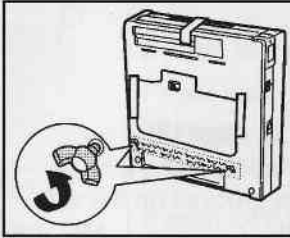

1. Remove the copier from the bag.
2. Remove the thumbscrews, tape and the label from the bottom of the copier.

Note: The thumbscrews are there to prevent pressure on the fuser roll during shipment. *Failure to remove the thumbscrew will cause a paper jam when operating the copier.*

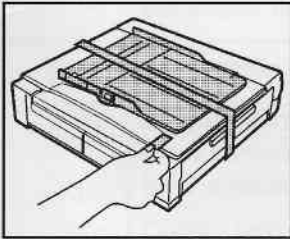

3. Remove all the pieces of tape from the copier and then place the copier on a level surface.

XC351 skip to step 5

4. Remove the paper tray from the top of the copier.

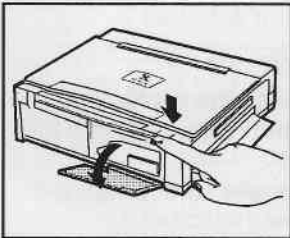

5. Press the button to open the front cover.

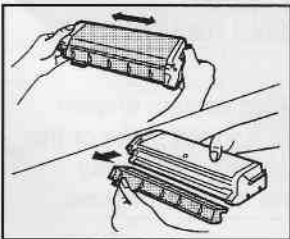

6. Vigorously shake the toner cartridge horizontally four or five times.
7. Remove the toner cartridge cover.

Installation

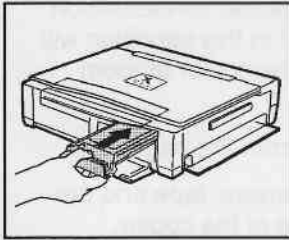

- Slide the toner cartridge in until it locks in place.
- Close the front cover.

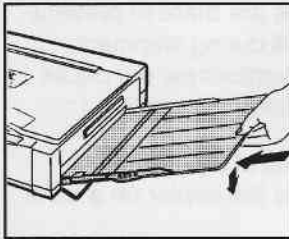

XC351 skip to step 12

- Install the paper tray by inserting it at an upward angle into the grooves on the side of the paper feed slot.

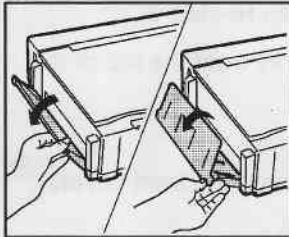

- Open and unfold the exit tray.

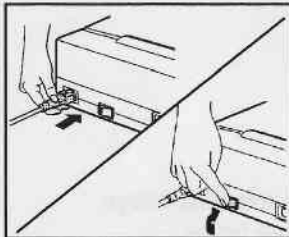

- Plug the power cord into the copier and then plug the other end of the cord into the nearest outlet.

Note: Ensure that the power cord is inserted firmly.

- Turn the power on.

Note: Wait approximately 1 minute for the Ready indicator to light.

CAUTION: Prior to making copies, ensure that the areas to the right and left sides of the copier are free of obstructions which may prevent free motion of the document glass.

Control Panel

XC351

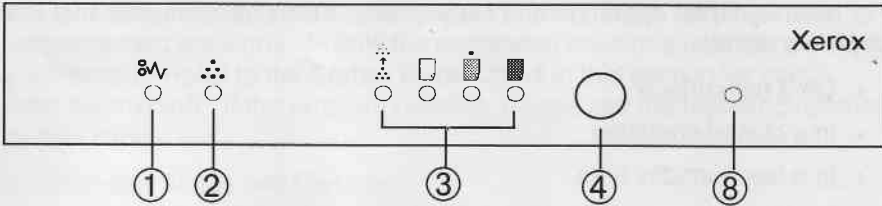

XC355 and XC356

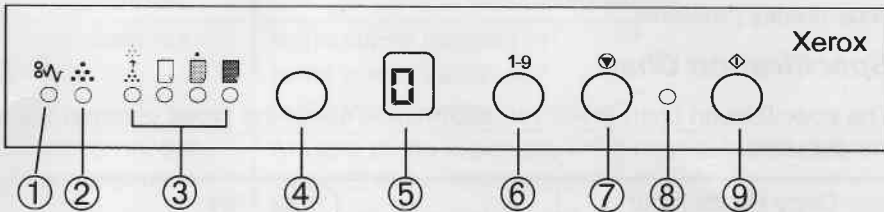

- ① **Misfeed Indicator:** The indicator will light when a misfeed occurs. Refer to the **Misfeed Removal** section of this manual for instruction.
- ② **Toner Cartridge Replacement Indicator:** Refer to **Toner Cartridge Replacement** section of this manual for instruction.
- ③ **Exposure Settings:** Five exposure settings, Auto, Toner Save, Light, Manual or Dark are available to select from.
- ④ **Exposure Button:** Successive pushes of the button will change the selected exposure setting.
- ⑤ **Quantity Display:** Copy quantity or status codes appear in this area.
- ⑥ **Copy Quantity Button:** Select up to 9 copies, or "C" mode, up to 20 copies.
- ⑦ **Clear/Stop Copy Button:** Press this key to stop the copier or to clear copy quantity. If the key is pressed consecutively, all programming will be cleared.
- ⑧ **Ready Indicator:** When the light is ON (not flashing), the copier is ready to make copies. When the light is flashing, after Start is pressed, the copier is warming up and copying will begin automatically.
- ⑨ **Start Print Button:** Press this key to begin copying.

Paper Specifications

Paper Storage

For reliable copier operation and copy quality, Xerox recommends that the paper be stored:

- On a flat surface
- In a closed container
- In a low humidity area
- In a tightly wrapped container, if the ream is partially used.

Note: Paper affected by humidity, and curled paper can cause jams and copy quality problems.

Specification Chart

The specification chart gives you information about the types of paper that can be used.

Copy Paper Input	Paper Tray
Paper sizes	XC351 and XC355: 4x6" to 8.5x11"/ A6 to A4 XC356: 4x6" to 8.5x14" A6 to 216x356 mm
Paper weights (white or colored)	Optimum 20 lb/ 75 gsm Range 16 to 24 lb /60 to 90 gsm
Capacity (20 lb /75 gsm)	XC351: Single sheet feed XC355 and XC356: Approximately 50 sheets
Letterhead Paper	Yes
Predrilled Paper	Yes
Labels *	Yes (Max 1)
Transparencies *	Yes (Max 1)

* Use labels and transparencies specifically designed for copiers (high temperatures).

Making Copies on the XC351

The Auto Start feature allows you to program the copier while it is warming up. You can select the exposure setting, insert a sheet of paper, and walk away from the copier. Copying will start automatically as soon as the copier is warmed up.

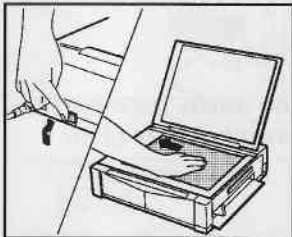

1. Turn the power on.
2. Open the document cover.
3. Place the original **face down**, between the marks, in the **upper right corner** of the document glass.

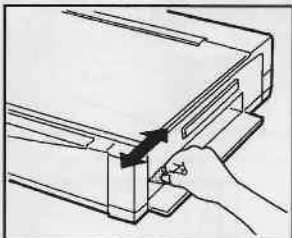

4. Set the paper guide to the width of the copy paper.

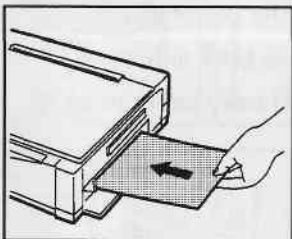

5. Insert a sheet of copy paper into the paper feed slot.

- Copying will start automatically.
- Approximately 90 seconds after the last copy is made the copier enters the auto power saver mode and the Ready indicator starts flashing. Copying is possible in the Auto Power Saver Mode, but the first copy may take a few seconds longer than usual.

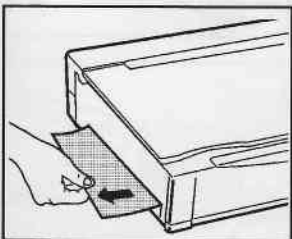

6. Remove the copies one at a time.
- Wait for the ready indicator to light before inserting the next sheet of copy paper.
 - Approximately 1 minute after the last copy is made, the exposure setting will return to the auto mode.

Making Copies on the XC355 and XC356

The Auto Start feature allows you to program any feature while the copier is warming up. You can program all the features, press the Start button, and walk away from the copier. Copying will start automatically as soon as the copier is warmed up.

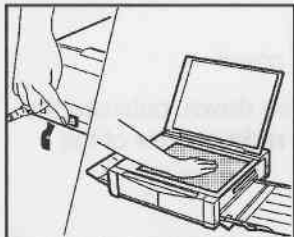

1. Turn the power on.
2. Open the document cover.
3. Place the original **face down**, between the marks, in the **upper right corner** of the document glass.

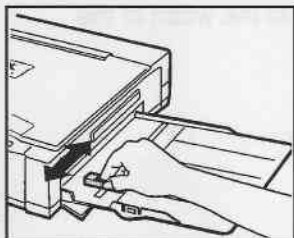

4. Set the paper guide to the width of the copy paper.

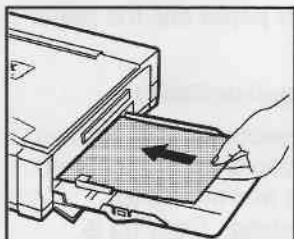

5. Place copy paper in the paper tray.
 - Do not fill above the MAX line.
 - Special paper and heavy paper must be fed individually.

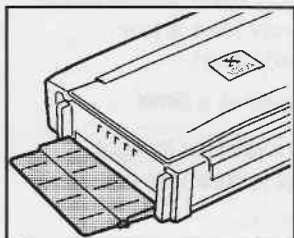

6. Ensure that the exit tray is fully opened.

Making Copies on the XC355 and XC356

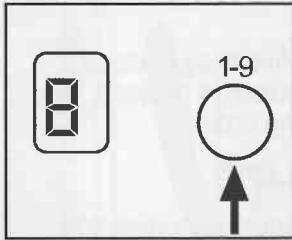

7. To make from 1 to 9 copies, press the Copy Quantity button to set the number of copies.

8. The copy quantity display normally reads 1, and will increase by one number each time the Copy Quantity button is pressed.

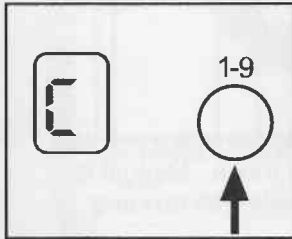

9. To make more than 9 copies, press the Copy Quantity button until C is displayed (after 9). The copier will now make up to 20 copies. If there are less than 20 sheets of paper in the paper tray, the copier will make copies until the tray is empty and the letter P appears in the copy quantity display.

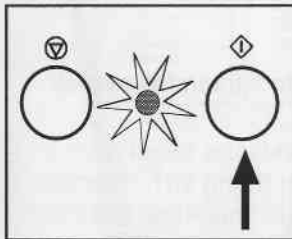

10. Press the Start button when the Ready indicator lights.

- When making the first copies after turning the power switch on, copying will start a few seconds after pressing the Start button.
- To stop copying, press the Stop Clear button.
- Approximately 1 minute after the last copy is made, the exposure setting will return to the auto mode, and the copy quantity will return to 1.
- Approximately 90 seconds after the last copy is made the copier enters the auto power saver mode and the Ready indicator starts flashing. Copying is possible in the Auto Power Saver Mode, but the first copy may take a few seconds longer than usual.

Copy Quality

Copy Contrast

To compensate for light or dark originals there are five copy contrast settings to choose from. Each time the Exposure button is pressed, the selection will scroll to the next setting in the following order:

1 – Auto, 2– Manual, 3 – Light, 4 – Dark, 5 – Toner Save.

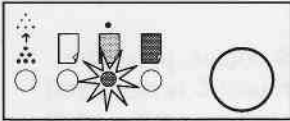

In the **Auto** mode, the copier automatically selects the exposure based on the original darkness and background.

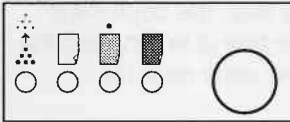

Select the **Manual** mode (no indicators will light) to cancel the Auto mode. Manual is useful for copying originals with text and photos.

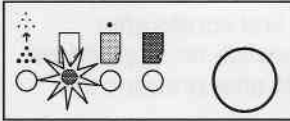

Select the **Light** mode to lighten the overall copy quality.

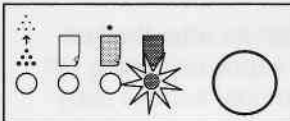

Select the **Dark** mode to darken the overall copy quality.

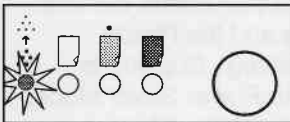

Select to the **Toner Save** mode to lower the cost of copying by decreasing overall copy density on each page. This feature can be used when making draft copies.

Two-Sided Copying

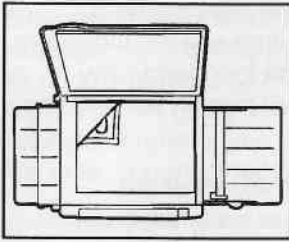

1. Place the first original **face down** on the document glass and make a copy.

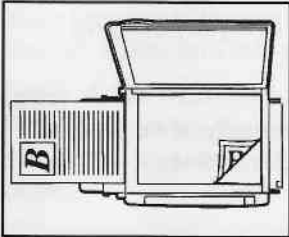

2. Place the second original **face down** on the document glass in the **opposite** orientation from the first original.

Note: The orientation of the second original must be in reverse of the first original to get a correct two-sided copy.

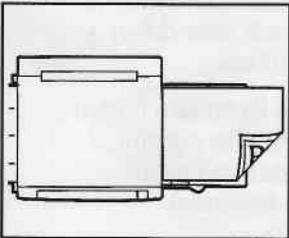

3. Place the first copy **face down** on the paper tray or into the paper feed slot.
 - Remove each two-sided copy promptly. Do not let the copies stack up.

Setting Copy Exposure Range

The copy exposure range may be adjusted when the copy image is consistently too dark or too light. The Exposure button and the indicators on the control panel are used to enter and select the long term copy density changes. The new copy exposure range will remain set until this process is used again.



Select the **Light** mode when the majority of the originals have a dark background or are photographs.



Select the **Auto** mode for normal everyday copying (many different kinds of originals).



Select the **Dark** mode when the majority of originals have light printed areas, such as pencil lines.

Note: In the following procedure, it is important to complete step 2 immediately after completing step 1, as the copier will time out in approximately 10 seconds and return to the ready mode.

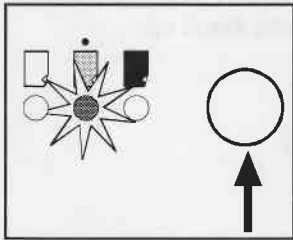

1. Press and hold the Exposure button until the indicator for the current exposure setting starts to flash (approximately 10 seconds).
2. Press and release the Exposure button until the flashing light is under the indicator for the appropriate exposure range.
 - If power is interrupted while setting copy exposures, no change will be made to the current exposures range.

Approximately 5 seconds after selecting the appropriate indicator the exposure indicator will go out, the auto and ready indicators will light, and the new copy exposure range will be set.

XC355 and XC356 Copiers only

Note: Pressing the Clear button will have no effect during this procedure.

P Paper Supply Indicator (XC355 and XC356)

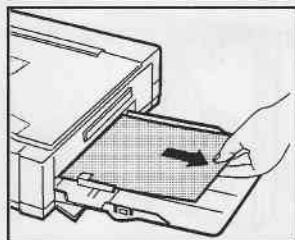
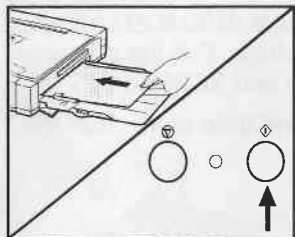
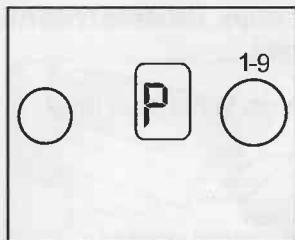

1. **P** will flash in the **Copy Quantity** display when the paper tray is empty or the paper has not been fed all the way into the copier.
2. If there is no paper in the paper tray, add paper and then press the **Start** button to finish copying.
 - **P** will disappear and the number of remaining copies will appear in the Copy Quantity display.
 - If you turn the power off, the selected copy conditions and the number of remaining copies will be cleared.
3. If the copy paper has not been fed all the way into the copier, gently pull it out.
 - If the misfed paper is difficult to remove, remove the paper tray. Pull the paper out.
 - When the misfeed has been cleared and the **Start** button is pressed, **P** will disappear in the copy quantity display and copying will resume.
 - Do not reuse paper that has misfed.

⚠ Misfeed Removal

If the **⚠ Misfeed** indicator flashes and the copier stops, a misfeed has occurred. Follow the steps below to clear the misfeed.

Note: The **⚠ Misfeed** indicator will light if the copier is not on a level surface.

Paper Feed Slot

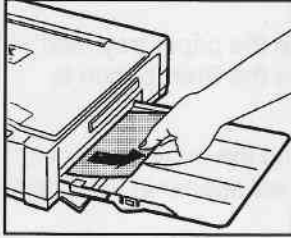

1. Carefully remove the misfed paper.
 - If the misfed paper is difficult to remove, remove the paper tray. Pull the copy paper out. (XC355 and XC356 only.)
2. Turn the power off and then on to clear the misfeed indicator.

Exit Area

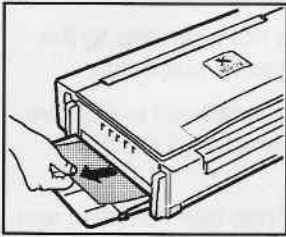

1. Carefully remove the misfed paper.
2. Turn the power off and then on to clear the Misfeed indicator.

Misfeed Removal

Internal Area

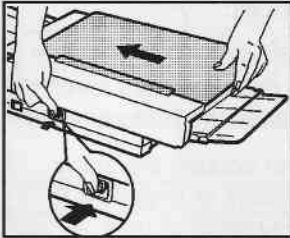

1. Turn off the power switch.
2. Press and hold the document glass release button on the rear of the copier and return the document glass to the center of the copier.

XC351 skip to step 5

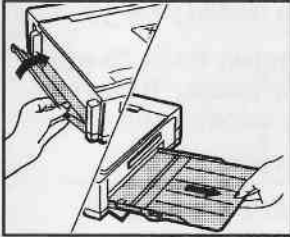

3. Fold up the exit tray.
4. Remove the paper tray.

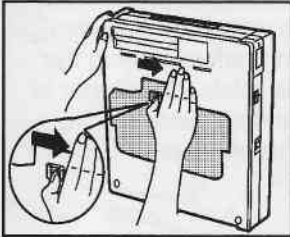

5. Lift the copier by the handle and stand it up with the document exit area on the bottom.
6. Push the tab to the right to open the bottom cover.

⚠ Misfeed Removal

Internal Area

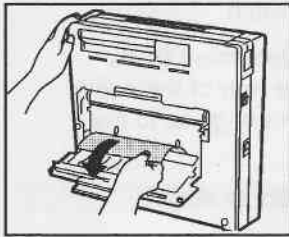

CAUTION:

When removing the misfed paper, be careful not to touch the bottom cover release lever, springs or other parts inside the bottom cover.

Be careful not to touch or scratch the shiny surface of the copy cartridge or expose it to the light for an extended period of time.

7. Carefully remove the misfed paper.
 - If the paper accidentally tears, be sure to remove all of the pieces. Be careful not to damage the corotron wire.
8. Close the bottom cover securely.
9. Set the copier back to the normal operating position.

Note: Failure to set the copier back to the normal operating position before turning the power on may cause the misfeed indicator to flash. In this case, set the copier in the normal operating position and turn the power off and then on.

10. Turn the power on.
 - Ensure that the indicator disappears.
11. If the misfeed indicator does not disappear, repeat steps 1 through 9.

❖ Toner Cartridge Replacement

When insufficient toner is detected at the start of copying, the toner cartridge replacement indicator will light and the copier searches for toner for up to 1 minute. During the time that the copier is searching for toner the document glass will slide back and forth. If the copier detects insufficient toner again, the indicator will flash and the copier will stop. At this time, you must replace the toner cartridge.

During multiple sheet copying of a dark original, the toner cartridge replacement indicator may flash and the copier may stop even though toner remains in the cartridge. If this occurs, turn the power switch off and then on again, and restart copying.

Note: A few more copier may be made by using this procedure. Vigorously shake the cartridge horizontally 4 or 5 times, tap the top of the cartridge (label side), with your hand then reinsert the cartridge into the copier.

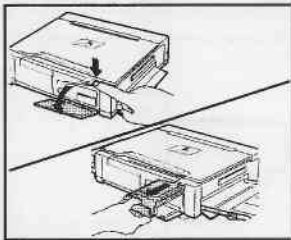

1. Turn off the power switch.
2. Press the front cover open button and open the front cover.
3. Press down on the catch and pull the toner cartridge out of the copier.

Note: Help the environment by recycling your used toner cartridge. Refer to the Xerox Green Team brochure packed with the toner cartridge for instructions on returning the used toner cartridge to Xerox.

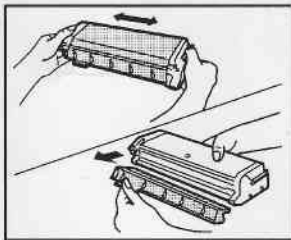

4. Vigorously shake the new toner cartridge horizontally four or five times and then remove the cover.
- Save the box and toner cartridge cover to pack the toner cartridge for shipping or moving.

❖ Toner Cartridge Replacement

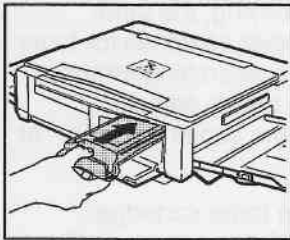

5. Install the new toner cartridge. Push it in until it locks in place.
6. Close the front cover.
7. Turn on the power.
 - After installing a new toner cartridge and pressing the start button, the document glass will move back and forth, and the toner cartridge replacement indicator will light for up to 1 minute before copying starts.



Toner Cartridge Yield

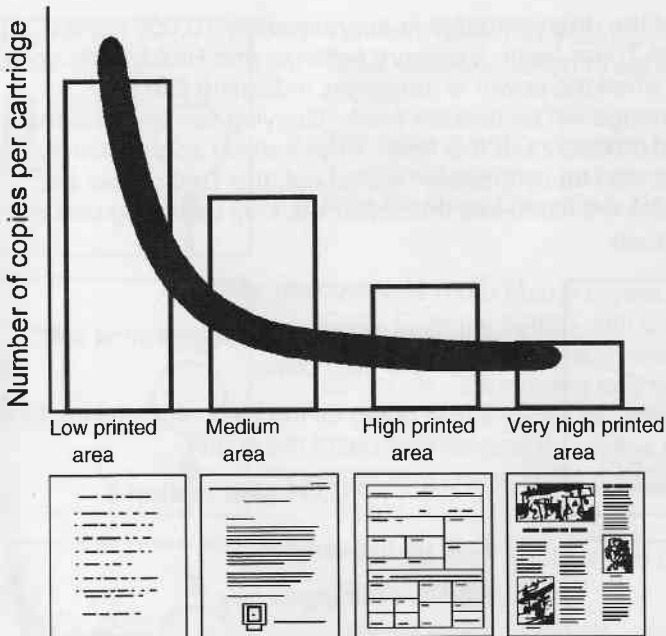

The main factor affecting toner cartridge yield is the printed area of a document. The graph is a sample representation of how the number of copies per cartridge decreases as the printed area increases.

Other factors which can affect the toner cartridge yield are:

- The size of the document being copied.
- Dark backgrounds.
- Leaving the platen cover open.
- Double sided copying will use more toner per ream of paper.
- High humidity.

To get the most from your toner cartridge:

- Always copy with the document cover closed.
 - Leave the copier on during the day. Switch off the copier at the end of the working day.
 - Copy with the exposure control set to Auto exposure unless you need to adjust for the background of your original.
 - Operate the copier in a dry environment whenever possible.
-
-

Drum Cartridge Replacement

The useful life of the drum cartridge is approximately 10,000 copies. At 9,700 copies, the Toner Save, Exposure settings, and Ready indicators will flash slowly when the power is turned on, indicating that the replacement cartridge will be needed soon. Copying can be performed using the normal procedure at this time. After making approximately 300 additional copies the Ready Indicator will go out, the Toner Save and Contrast Indicators will flash, and the copier will stop operating until the cartridge is replaced.

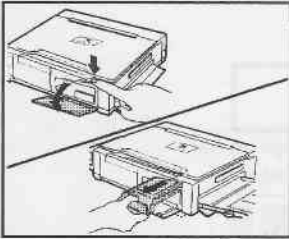

1. Turn off the power switch.
2. Press the front cover open button and open the front cover.
3. Press down on the catch and pull the toner cartridge out of the copier.

XC351 skip to step 6

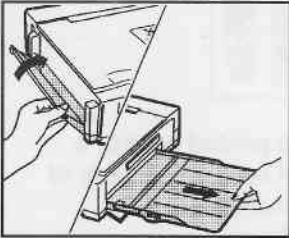

4. Fold up the exit tray.
5. Remove the paper tray.

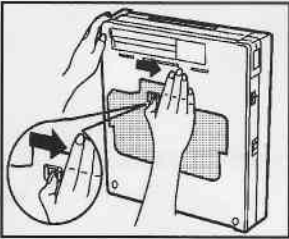

6. Lift the copier by the handle and stand it up with the document exit area on the bottom.
7. Push the bottom cover tab to the right to open the cover.

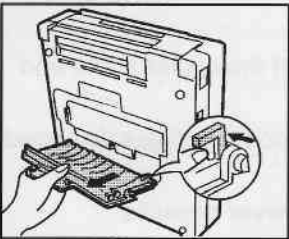

8. Push the bottom cover release lever to the left and remove the bottom cover.

Drum Cartridge Replacement

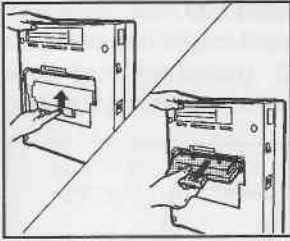

9. Push the drum cartridge release lever up to release the drum cartridge.

10. Remove the drum cartridge.

Note: Help the environment by recycling your used drum cartridge. Refer to the Xerox Green Team brochure packed with the drum cartridge for instructions on returning the used drum cartridge to Xerox.

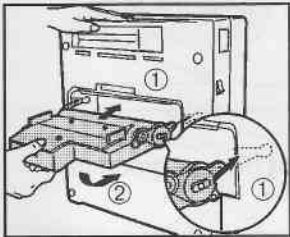

11. ① Install the top of the new drum cartridge along the grooves on both sides.

12. ② Rotate the drum cartridge in until it clicks into position.

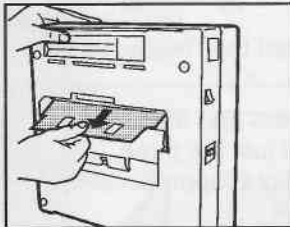

13. Remove the black cover from the drum cartridge.

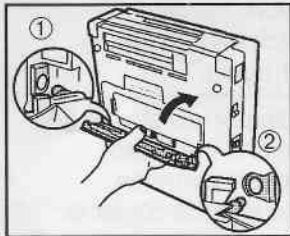

14. Reinstall the bottom cover by placing the tab at the lower left into the hole in the copier as shown ①, and by inserting the right side at an angle ②.

15. Close the bottom cover.

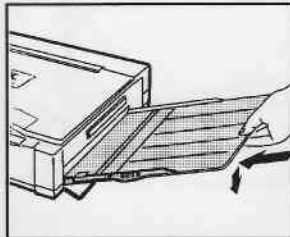

16. Lower the copier to the running position.

XC351 skip to step 19

17. Install the paper tray by inserting it at an upward angle into the grooves on the side of the paper feed slot.

Drum Cartridge Replacement

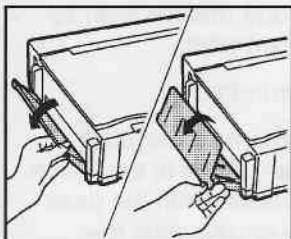

18. Unfold and open the exit tray.

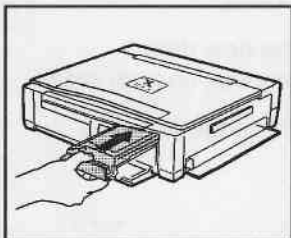

19. Reinstall the toner cartridge. Push it in until it locks in place. Close the front cover.

The following steps **must** be performed to reset the copier.

20. While holding the Exposure button, turn on the power switch.

- All indicators, except the Ready indicator, will light.

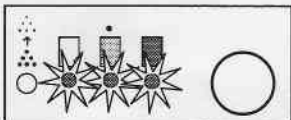

21. Release and then press and hold the exposure button until just the three exposure indicators light (approximately 4 seconds).

Note: If the three exposure indicators do not light, turn the power switch off and then perform steps 20 and 21 again.

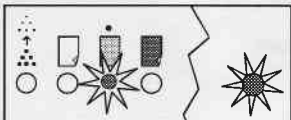

The center exposure indicator will stay lit (the outside lights will go out) and the Ready indicator will light. The drum cartridge counter reset is complete and the copier is now ready for operation.

Problem Solving

Problem Solving Chart

The following chart lists some conditions that may occur and the recommended solutions. Follow the suggested solutions until the problem is corrected. Refer to the **Status Code Chart** in this section for status code information. If the problem persists, please call the following number for assistance:

In the United States and Canada:

1 – 800 – TEAM – XRX (1 – 800 – 832 – 6979)

Condition	Possible Causes
Copier does not work.	Is the copier plugged in? Is the power switch on? Is the toner cartridge installed?
Copier is on, but does not copy	Are any of the indicators lit? (Refer to the Status Code Chart in this section.) Is the copier out of paper?
Blank copies	Is the original face down on the document glass?
Light or dark copies	Is the exposure control adjusted correctly? (Refer to the Copy Quality section.)
Copies are striped or lined or poor copy quality.	Is the document glass or the document cover dirty? Is the lens dirty? (Refer to the Copier Maintenance section.)
Copy paper misfeeds frequently.	Is the paper exit blocked? Is the paper guide adjusted to the correct paper width? Does the paper level in the paper tray exceed the maximum height line? (XC355 and XC356 only.) Is the copy paper damp? (Use only dry, flat copy paper.) Is special copy paper being used? Is there a small piece of paper caught in the copier?







Problem Solving

Problem Solving Chart

Condition	Possible Causes
Image rubs off the copy easily.	Is the copy paper too heavy? Is the copy paper damp? Is there a misfeed in the fusing area? (Refer to Misfeed Removal .) Have the two thumbscrews been removed from the bottom of the copier? (Refer to Installation .)
There are fewer copies from the toner cartridge than expected.	Originals contain pictures, solids, or heavy lines. Originals are forms, newsletters, books etc. The copier is being turned on and off frequently. The document cover is being left open while making copies.
Copier takes longer than usual to make the first copy and/or makes a clicking sound.	Toner supply may be low. Shake the toner cartridge. Take care not to touch the exposed toner on the left side of the toner cartridge. Ensure that you have a new toner cartridge in stock.
The document cover moves back and forth but no copies are made.	The copier is searching for toner. Refer to the Toner Cartridge Replacement section.

Problem Solving

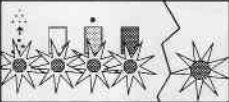
Status Code Chart

Status Code	Suggested Solution
	<p align="center">XC355 and XC356 Only</p> <p>Ensure that there is paper in the paper tray. Paper may not have fed all the way into the copier. (Refer to P Paper Supply Indicator.)</p>
L1 – L8 H2 – H4	<p align="center">XC355 and XC356 Only</p> <p>Switch OFF the main power. Wait approximately 5 seconds. Then switch ON the main power. If the status code continues, call for service.</p>
	<p>Copy paper has misfed. (Refer to  Misfeed Removal.)</p>
	<p>When the toner cartridge replacement indicator appears, the toner cartridge will need to be replaced soon. Be sure to have a replacement cartridge in stock.</p> <p>Copies will gradually become lighter until the copier stops and the indicator begins to blink. When this occurs the toner cartridge must be replaced.</p>
	<p>When the Toner Save, Copy Contrast, and Ready indicators flash the drum cartridge will need to be replaced soon. Be sure to have a replacement cartridge in stock. In approximately 300 copies, the Ready indicator will go out, the Toner Save and Contrast Indicators will flash, and the copier will stop operating until the cartridge is replaced. (Refer to the Drum Cartridge Replacement section of this manual for instructions.)</p>
	<p align="center">XC351 Only</p> <p>All lights, except the Ready indicator will light. Switch OFF the main power. Wait approximately 5 seconds. Then switch ON the main power. If the status code continues, call for service.</p>

Servicing Your Copier

In the USA and Canada

Should you be unable to resolve a problem after using the **Problem Solving** section of this manual, place a call to the Xerox Customer Support Center at:

1 – 800 – TEAM – XRX
(1 – 800 – 832 – 6979)

The Customer Support Representative can solve many problems over the phone. Please have the following information available before calling:

- The copier model number: **XC** _____
(on the control panel)
- The serial number _____
- (Located on the back cover of the copier, above the power receptacle.)
- The purchase date from your purchase receipt (required for warranty service).
- A description of the problem.
- Status Code (if any) or indicators displayed on the control panel.

Ordering Supplies

To order supplies for your copier, call or visit your local retailer. If your store does not stock these items, you may call:

Xerox SupplyNet toll free at:

1 – 800 – 822 – 2200

Toner Cartridge – 6R737

Drum Cartridge – 13R83

Copier Maintenance

Correct care is essential in order to get clean, sharp copies. Be sure to take a few minutes to regularly clean the copier.

Document Glass and Cover

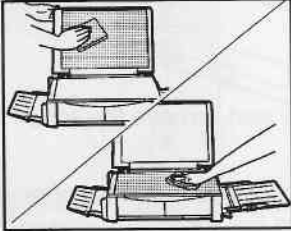

Note: Stains or dirt on the document glass or inside of the document cover will appear on the copy.

1. Wipe the document glass and cover with a soft, clean cloth.

Note: If necessary, dampen the cloth with water or a glass cleaner. **DO NOT** use thinner, benzene, or any other volatile cleaning agents.

Lens

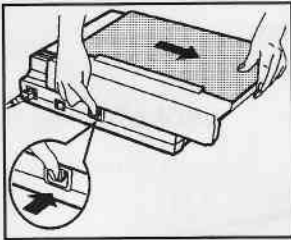

Note: If the copies start getting streaks or blotches, the lens may be dirty.

1. Turn off the power switch.
2. Press and hold the document glass release button and slide the document glass all the way to the left to access the lens.
3. Use a standard cotton swab. Place the swab at one end of the lens and wipe the full length of the lens.

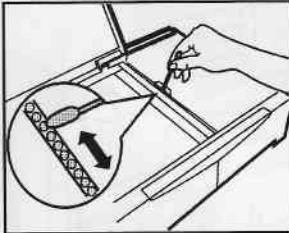

Packing the Copier

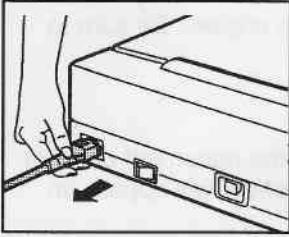

1. Turn off the power switch.
2. Disconnect the power cord.

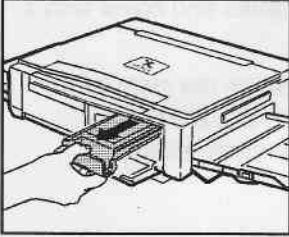

3. Open the front cover and remove the toner cartridge.
 - Reinstall the shipping cover on the toner cartridge and place the toner cartridge in the box for shipping.
4. Close the front cover.

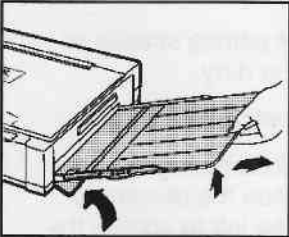

XC351 skip to step 7

5. Remove the paper tray.

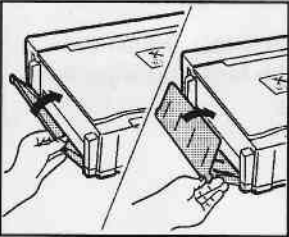

6. Fold up the exit tray.

Packing the Copier

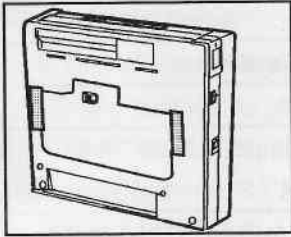

7. Use the handle to stand the copier upright.

- Never position the copier with the handle facing the side or bottom. This will cause toner to leak causing copier malfunctions.

8. Tape the bottom cover closed.

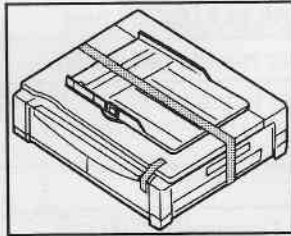

9. Lower the copier. Place the paper tray on top of the copier (XC355 and XC356 only).

10. Tape the document cover, paper tray, and exit tray, closed.

- Only the XC355 and XC356 will have a paper tray and exit tray.

11. If you have the original packaging, pack the copier in the carton as shown in the **Unpacking** section of this manual.

Technical Data

Type	Portable desktop
Copy System	Dry, electrostatic transfer system
Originals	Sheets, bound documents
Original size	XC351 and XC355: Maximum 8.5x11" /A4 XC356: Maximum 8.5x14"/ 216 mmx356 mm
Copy Size	XC351 and XC355: 4x6" to 8.5x11"/ A6 to A4 XC356: 4x6" to 8.5x14"/ A6 to 216x356 mm
Copy Speed	Approximately 3 copies per minute (all sizes)
First Copy Out Time	19 seconds (warm) 24 seconds (cold)
Copy Ratio	1:1 ±1%
Exposure System	Slit exposure with moving Document Glass
Paper Capacity	XC351: Single sheet feed XC355 and XC356: approximately 50 sheets of 20 lb/ 75 gsm
Multicopy	XC351: 1 copy XC355 and XC356: 1 to 9 copies +C (up to 20)
Developer System	Magnetic brush development with two components
Fusing System	Heat rollers
Light Source	Tungsten lamp
Power Supply	Reference the copier data plate.

Technical Data

Power Consumption	0.7 KW Maximum			
Operating dimensions	Copier	Width	Depth	Height
	XC351	26.6" 676 mm	13.9" 353 mm	3.9" 98 mm
	XC355	28.6" 725 mm	13.9" 353 mm	3.9" 98 mm
	XC356	31.6" 803 mm	13.9" 353 mm	3.9" 98 mm
Weight	XC351: 14.4 pounds (6.5 kg) XC355: 15.5 pounds (7 kg) XC356: 16 pounds (7.25 kg)			
Copier dimensions	Copier	Width	Depth	Height
	XC351	14.3" 362 mm	13.9" 353 mm	3.9" 98 mm
	XC355	14.9" 378 mm	13.9" 353 mm	3.9" 98 mm
	XC356	17.9" 455 mm	13.9" 353 mm	3.9" 98 mm

3-Year Limited Warranty

In the USA

TOTAL SATISFACTION GUARANTEE:

Xerox warrants that if you are not totally satisfied with the performance of the Xerox Copier which this warranty statement accompanies, at your option and upon your request, Xerox will exchange or repair it at any time within three (3) years after your purchase.

IMPORTANT: *This warranty applies only to Xerox copiers purchased and used in the United States. This warranty gives you specific legal rights, and you may also have other rights which vary from state to state.*

PROOF OF PURCHASE:

To obtain an exchange or repair, proof of purchase is required. **You must, within 10 days after purchase, mail the enclosed registration card to Xerox Corporation Desktop Products Group, P.O. Box 431, East Rochester, New York 14445-9983.** Also, when you make a warranty claim, you must present your original receipt or bill of sale to establish your date of purchase.

IF YOU HAVE A PROBLEM:

The first step is to call our trained Customer Support Representative at 1-800-TEAM-XRX, (1-800-832-6979). Many problems can be resolved over the phone. Before you call please be ready to provide the model of your copier, its serial number, date of purchase, a description of the problem, and a valid credit card number, should it be required (Mastercard, Visa or American Express).

HOW IS EXCHANGE OBTAINED?

Our exchange program is the easiest and quickest way to provide you with a fully operational copier. If you are not satisfied with the performance of your copier, you may request an exchange unit. Upon your authorization to accept an exchanged unit and with appropriate security (credit card authorization) we will, at no cost to you, promptly ship a copier in exchange for your defective unit. The exchange unit we ship to you will, at our option, be new or reconditioned by Xerox. You must then pack and return your defective unit to us. Upon its receipt, we will release your credit card security.

HOW IS WARRANTY REPAIR SERVICE OBTAINED?

If you prefer that we repair your copier instead of exchanging it for another unit, our Customer Service Representative will explain how to obtain repair service under this warranty. **Please save the original packaging materials in order to facilitate shipment.**

WHAT YOU MUST DO:

Your copier is designed to perform with a minimum amount of user maintenance. You are, however, responsible for the required user maintenance described in the User Guide provided with your copier. This required user maintenance includes the replacement of dry ink (toner) cartridges, drum (copy) cartridges, or film cartridges, and clearing paper misfeeds, cleaning the unit and other routine and preventive maintenance.

3-Year Limit Warranty

In the USA

WHAT THE WARRANTY DOES NOT COVER:

This warranty covers only defects in materials and workmanship provided by Xerox and does not cover equipment damage or malfunction from misuse, abuse, accident, act of God, defect in non-Xerox supplies, or non-Xerox alteration, modification or upgrade. Improper return shipping, packaging or shipping damage is not covered unless the unit is packaged and shipped in accordance with Xerox exchange procedures or via an authorized Xerox Service Access Center. Replacement of drum cartridges, dry ink cartridges, film cartridges and other supplies are customer maintenance responsibilities and are not covered by this warranty. Scheduled maintenance, as described in the user guide (including that required when a service indicator is "on") is not covered by this warranty. This limited warranty, provided by Xerox, is only for copiers purchased and used in the United States.

EXCHANGE AND REPAIR ARE YOUR ONLY REMEDIES:

Your only remedy under this warranty is the exchange or repair of your copier as described above. **Xerox will not be liable for any incidental or consequential damages resulting from your use of or inability to use your copier even if we know such damages are possible.**

***IMPORTANT:** Some states do not allow the exclusion or limitation of incidental or consequential damages, so the above limitation or exclusion may not apply to you.*

NO OTHER WARRANTY IS MADE BY XEROX:

No other warranty is made by Xerox. Any implied warranty of merchantability is limited to the duration of this express limited warranty and thereafter is disclaimed. No other warranty of any kind or type, whether express or implied will apply after the 3 year period. Xerox expressly disclaims any implied warranty of fitness for a particular purpose.

***IMPORTANT:** Some states do not allow limitations on how long an implied warranty lasts, so the above limitation may not apply to you.*

No reseller is authorized to modify the terms of this warranty. Any additional warranty offered by a reseller is the sole responsibility of the reseller. This warranty is offered only to the first end-user purchaser and is not valid for subsequent purchasers. The warranty period for an exchange copier expires three years after the date you purchased the copier which this warranty statement accompanies.

SERVICE AFTER YOUR THREE YEAR WARRANTY EXPIRES:

After your three year warranty expires you can obtain a low cost Xerox Maintenance Agreement by simply calling **1-800-TEAM XRX (1-800-832-6979)**. We recommend you call 90 days prior to warranty expiration to assure continuous service coverage.

**If you have questions about this warranty, phone us toll free at:
1-800-TEAM XRX (1-800-832-6979).**

Please record your: Model XC: _____

Serial No: _____

Date Purchased: _____

3-Year Limited Warranty

In Canada

TOTAL SATISFACTION GUARANTEE:

Xerox warrants that if you are not satisfied with the performance of the Xerox Copier which this warranty statement accompanies, at your option and upon your request, Xerox will repair or replace it at any time within three (3) years after your purchase. The replacement unit we ship to you will be fully reconditioned by Xerox.

IMPORTANT: *This warranty applies only to Xerox copiers purchased and used in Canada.*

PROOF OF PURCHASE:

To obtain a repair or replacement, proof of purchase is required. **You must, within 10 days after purchase, mail the enclosed registration card to Canadian Retail Operations, Xerox Canada Ltd, P.O. Box 3020, Stn LCD, Malton, Mississauga L4T9Z9.** Also, when you make a warranty claim, you must present your original receipt or bill of sale to establish your date of purchase.

IF YOU HAVE A PROBLEM:

The first step is to call our trained Customer Support Representative at **1-800-TEAM XRX (1-800-832-6979)**. Many problems can be resolved over the phone. Before you call please be ready to provide the model of your copier, its serial number, date of purchase, and a description of the problem.

HOW IS WARRANTY SERVICE OBTAINED?

Our Customer Support Representative will explain how to obtain repair/replacement service under this warranty. **Please save the original packaging materials in order to facilitate shipment.**

WHAT YOU MUST DO:

Your copier is designed to perform with a minimum amount of user maintenance. You are, however, responsible for the required user maintenance described in the User Guide provided with your copier. This required user maintenance includes the replacement of toner (dry ink) cartridges, drum (copy) cartridges, or film cartridges, and clearing paper misfeeds, cleaning the unit and other routine and preventive maintenance.

3-Year Limited Warranty

In Canada

WHAT THE WARRANTY DOES NOT COVER:

This warranty covers only defects in materials and workmanship provided by Xerox and does not cover equipment damage or malfunction from misuse, abuse, accident, act of God, defect in non-Xerox supplies, or non-Xerox alteration, modification or upgrade. Improper return shipping, packaging or shipping damage is not covered unless the unit is packaged and shipped in accordance with Xerox exchange procedures or via an authorized Xerox Service Access Center. Replacement of drum cartridges, dry ink cartridges, film cartridges and other supplies are customer maintenance responsibilities and are not covered by this warranty. Scheduled maintenance, as described in the user guide (including that required when a service indicator is "on") is not covered by this warranty. This limited warranty, provided by Xerox is only for copiers purchased and used in Canada.

REPAIR OR REPLACEMENT ARE YOUR ONLY REMEDIES:

Your only remedy under this warranty is the repair or replacement of your copier as described in this warranty. **Xerox will not be liable for any incidental or consequential damages resulting from your use of or inability to use your copier even if we know such damages are possible.**

NO OTHER WARRANTY IS MADE BY XEROX:

No other warranty is made by Xerox. Any implied warranty of merchantability is limited to the duration of this express limited warranty and thereafter is disclaimed. No other warranty of any kind or type, whether express or implied will apply after the 3 year period. Xerox expressly disclaims any implied warranty of fitness for a particular purpose.

No reseller is authorized to modify the terms of this warranty. Any additional warranty offered by a reseller is the sole responsibility of the reseller. This warranty is offered only to the first end-user purchaser and is not valid for subsequent purchasers. The warranty period for a replacement copier expires three years after the date you purchased the copier which this warranty statement accompanies.

SERVICE AFTER YOUR THREE YEAR WARRANTY EXPIRES:

After your three year warranty expires you can obtain a low cost Xerox Maintenance Agreement by simply calling 1 - 800 - TEAM - XRX (1 - 800 - 832 - 6979). We recommend you call 90 days prior to warranty expiration to assure continuous service coverage.

**If you have questions about this warranty, phone us toll free at:
1 - 800 - TEAM - XRX (1 - 800 - 832 - 6979).**

Please record your: Model XC: _____

Serial No: _____

Date Purchased: _____

It's Illegal

In the USA

It is against US law to copy copyrighted material without permission of the copyright owner unless the copying falls within the "Fair Use" or library reproduction rights of the copyright law. Further information on these U.S. provisions may be obtained from the Copyright Office, Library of Congress, Washington, D.C. 20550, or telephone the Copyright Office at (202) 707-9100 and ask for circular 21. Copying of other items may be prohibited. If you have any questions, seek legal advice.

In Canada

In Canada it is against the law to copy copyrighted material without permission of the copyright owner, unless the copying falls within the private study, research or criticism provision of the copyright law. Copying of other items may be prohibited. If you have any questions, seek legal advice.

Xerox Guarantee

Xerox Retail Total Satisfaction Guarantee

In the USA and Canada

At Xerox we are committed to the highest quality in the design, manufacture and service of all we sell. We measure our success by one standard: Total Customer Satisfaction.

Taking this commitment one step further, we now offer this exclusive Xerox Total Satisfaction Guarantee:

If you are not satisfied with your Xerox equipment, at your request, Xerox will replace it without charge to you with an identical model or a machine with comparable features and capabilities.

The term of the Xerox Total Satisfaction Guarantee is three years from purchase date.

This Xerox Total Satisfaction Guarantee applies to Xerox equipment acquired by you from an Authorized Xerox Retailer and continuously maintained by Xerox or its authorized representatives under our manufacturers warranty. This guarantee applies to all equipment acquired on or after September 5, 1990 and is not applicable to equipment damaged or destroyed due to reasons beyond the control or responsibility of Xerox.

We make this extraordinary offer to clearly demonstrate that at Xerox our measure of quality is our customers' satisfaction.

Refer to the product warranty discussed earlier in this manual for additional details or call the following number:

1 - 800 - TEAM - XRX

(1 - 800 - 832 - 6979)

Material Safety Data Sheet

XEROX

Material Safety Data Sheet

MSDS No: A-0198

Date: 12/2/94

Revision: 4/29/97

Manufacturer: Xerox Corporation Telephone # (s): Safety Information: (800) 828-6571
Rochester, NY 14644 Health Emergency: (716) 422-2177

Transportation Emergency: (716) 422-1230

Section I - Product Identification

Trade Names/Synonyms: 5201/5203/5305/5306, XC351/XC355/XC356

Black Dry Ink Cartridge

Part No.: 6R737

Chemical Name: None

WHMIS Status: This is not a WHMIS controlled product.

Ingredients (% by wt.)

Ingredients (% by wt.)	CAS No.
Iron powder (50-60%)	7439-89-6
Styrene/acrylate copolymer (40-50%)	25767-47-9
Carbon black (<6%)	1333-86-4
C.I. Solvent Black 7 (<2%)	8005-02-5
Polypropylene (<3%)	9003-07-0
Magnetite (<2%)	1317-61-9

Section II - Emergency and First Aid

Primary Route of Entry:

Inhalation

Eyes:

Flush with water.

Skin:

Exposure:

Wash with soap and water.

Inhalation:

Remove from exposure.

Ingestion:

Dilute stomach contents with several glasses of water.

Symptoms of Overexposure:

Minimal respiratory tract irritation may occur as with exposure to large amounts of any non-toxic dust.

Medical Conditions Generally Aggravated by

None when used as described by product literature.

Additional Information:

None.

Section III - Toxicology and Health Information

This material has been evaluated by Xerox Corporation.

Oral LD₅₀: >5 g/kg (rats) practically non-toxic.

Dermal LD₅₀: >5 g/kg (rabbits) practically non-toxic.¹

Inhalation LC₅₀: >5 mg/l (rats, 4 hr exposure) practically non-toxic.¹ >20 mg/l (calculated 1 hr exposure)¹

Eye Irritation: Not an irritant.

Skin Sensitization: Not a sensitizer.¹

Skin Irritation: Not an irritant.

Human Patch: Non-irritating, non-sensitizing.

Mutagenicity: No mutagenicity detected in Ames, WP₂, Yeast D7, and Mouse Lymphoma Assays.

Carcinogens: None present

Aquatic LC₅₀: N.D.

TLV: 10 mg/m³ (total dust)

PEL: 15 mg/m³ (total dust)
5 mg/m³ (respirable dust)

STEL: N.E.

Ceiling: N.E.

XEL²: 2.5 mg/m³ (total dust)
0.4 mg/m³ (respirable dust)

Material Safety Data Sheet

Additional Information: The results obtained from a Xerox sponsored, Chronic Toner Inhalation Study, demonstrated no lung change in rats for the lowest (1mg/m³) exposure level (i.e. the level most relevant to potential human exposure). A very slight degree of fibrosis was noted in 25% of the animals at the middle (4mg/m³) exposure level, while a slight degree of fibrosis was noted in all the animals at the highest (16 mg/m³) exposure level. These findings are attributed to "lung overloading", a generic response to excessive amounts of any dust retained in the lungs for a prolonged period. This study was conducted using a special test toner to comply with EPA testing protocol. The test toner was ten times more respirable than commercially available Xerox toner, and would not be functionally suitable for Xerox equipment.

¹Based on testing of similar xerographic toner materials. ²XEL-Xerox Exposure Limit

N.A. - Not Applicable N.E. -None Established N.D. -Not Determined

602E03300

XEROX Trade Name: 5201/5203/5305/5306, XC351/XC355/XC356 Black Dry Ink Cartridge

MSDS No.: A-0198

Section IV - Physical Data

Appearance/Odor:	Black powder / faint odor	Softening Range:	85°C to 100°C
Boiling Point:	N.A.	Melting Point:	N.A.
Solubility in Water:	Negligible	Specific Gravity (H₂O=1):	>1
Evaporation Rate:	N.A.	Vapor Pressure (mm Hg):	N.A.
Vapor Density (Air=1):	N.A.	pH:	N.A.
Volatile:	N.A. % (Wt.)	N.A. % (Vol.)	

Section V - Fire and Explosion Data

Flash Point (Method Used):	N.D.
Flammable Limits:	LEL: N.A., UEL: N.A.
NFPA 704:	Health - 0, Fire - 3, Reactivity - 0
Extinguishing Media:	Water, dry chemical, carbon dioxide or foam.
Special Fire Fighting Procedures:	Avoid inhalation of smoke. Wear protective clothing and self-contained breathing apparatus.
Fire and Explosion Hazards:	Toner is a combustible powder. Like most organic materials in powder form, it can form explosive mixtures when dispersed in air.

Section VI -Reactivity Data

Stability:	Stable
Hazardous Polymerization:	Will Not Occur
Hazardous Decomposition Products:	Products of combustion may be toxic. Avoid breathing smoke.
Incompatibility (Materials to Avoid):	None known

Section VII - Special Protection Information

Respiratory Protection:	None required when used as intended in Xerox equipment.
Eye Protection:	None required when used as intended in Xerox equipment.
Protective Gloves:	None required when used as intended in Xerox equipment.
Other:	For use other than normal customer - operating procedures (such as in bulk toner processing facilities), goggles and respirators may be required. For more information, contact Xerox.

Section VIII - Special Precautions

Handling and Storage:	Use with adequate ventilation.
Conditions to Avoid:	Avoid prolonged inhalation of excessive dust.

Section IX- Spill, Leak, and Disposal Procedures

For Spills or Leakage: Sweep up or vacuum spilled toner and carefully transfer into sealable waste container. Sweep slowly to minimize generation of dust during clean-up. If a vacuum is used, the motor must be rated as dust tight. A conductive hose bonded to the machine should be used to reduce static buildup (See Section V). Residue can be removed with soap and cold water. Garments may be washed or dry cleaned, after removal of loose toner.

Waste Disposal Method: This material is not a hazardous waste according to Federal Regulation 40 CFR 261 when disposed. State and Local requirements however, may be more restrictive. Consult with the appropriate State and Local waste disposal authorities for additional information.

Section X - Transportation Information

DOT Proper Shipping Name:	N.A. (Not Regulated)	ID Number:	N.A.
Hazard Classification:	N.A.	Packing Group:	N.A.

602E03300

The MSDS may not be the latest version. To obtain the latest version you may call 1-800-828-6571, or visit their Web site at: <http://ids.xbs.xerox.com/ehs/msds/>

Free Manuals Download Website

<http://myh66.com>

<http://usermanuals.us>

<http://www.somanuals.com>

<http://www.4manuals.cc>

<http://www.manual-lib.com>

<http://www.404manual.com>

<http://www.luxmanual.com>

<http://aubethermostatmanual.com>

Golf course search by state

<http://golfingnear.com>

Email search by domain

<http://emailbydomain.com>

Auto manuals search

<http://auto.somanuals.com>

TV manuals search

<http://tv.somanuals.com>