

DIGITAL KEYBOARD

# OWNER'S MANUAL

---

## — PSR-E473

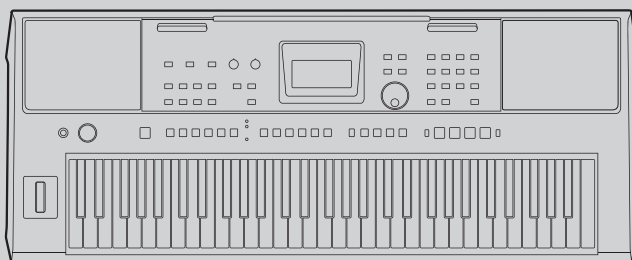

## — PSR-EW425

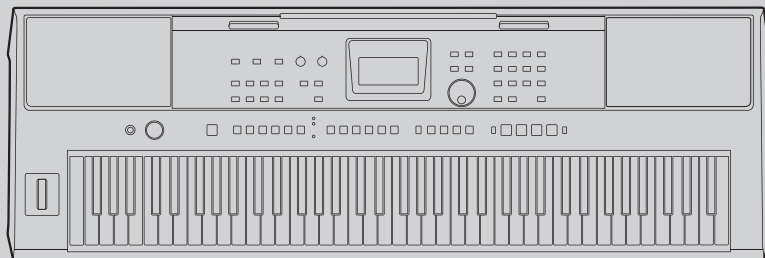

Before using the instrument, be sure to read  
“PRECAUTIONS” on pages 5 – 7.

## FCC INFORMATION (U.S.A.)

### 1. IMPORTANT NOTICE: DO NOT MODIFY THIS UNIT!

This product, when installed as indicated in the instructions contained in this manual, meets FCC requirements. Modifications not expressly approved by Yamaha may void your authority, granted by the FCC, to use the product.

### 2. IMPORTANT:

When connecting this product to accessories and/or another product use only high quality shielded cables. Cable/s supplied with this product MUST be used. Follow all installation instructions. Failure to follow instructions could void your FCC authorization to use this product in the USA.

### 3. NOTE:

This product has been tested and found to comply with the requirements listed in FCC Regulations, Part 15 for Class "B" digital devices. Compliance with these requirements provides a reasonable level of assurance that your use of this product in a residential environment will not result in harmful interference with other electronic devices. This equipment generates/uses radio frequencies and, if not installed and used according to the instructions found in the users manual, may cause interference harmful to the operation of other electronic devices. Compliance with FCC regulations does not guarantee

that interference will not occur in all installations. If this product is found to be the source of interference, which can be determined by turning the unit "OFF" and "ON", please try to eliminate the problem by using one of the following measures:

- Relocate either this product or the device that is being affected by the interference.
- Utilize power outlets that are on different branch (circuit breaker or fuse) circuits or install AC line filter/s.
- In the case of radio or TV interference, relocate/reorient the antenna. If the antenna lead-in is 300 ohm ribbon lead, change the lead-in to co-axial type cable.

If these corrective measures do not produce satisfactory results, please contact the local retailer authorized to distribute this type of product. If you cannot locate the appropriate retailer, please contact Yamaha Corporation of America, 6600 Orangethorpe Ave., Buena Park, CA90620, USA.

The above statements apply ONLY to those products distributed by Yamaha Corporation of America or its subsidiaries.

\* This applies only to products distributed by Yamaha Corporation of America.

(529-M04 FCC class B YCA 01)

### COMPLIANCE INFORMATION STATEMENT (Supplier's declaration of conformity procedure)

Responsible Party : Yamaha Corporation of America  
Address : 6600 Orangethorpe Ave., Buena Park, Calif. 90620  
Telephone : 714-522-9011  
Type of Equipment : Digital Keyboard  
Model Name : PSR-E473, PSR-EW425

This device complies with Part 15 of the FCC Rules.

Operation is subject to the following two conditions:

- 1) this device may not cause harmful interference, and
- 2) this device must accept any interference received including interference that may cause undesired operation.

\* This applies only to products distributed by Yamaha Corporation of America.

(FCC SDOC)

The model number, serial number, power requirements, etc., may be found on or near the name plate, which is at the bottom of the unit. You should note this serial number in the space provided below and retain this manual as a permanent record of your purchase to aid identification in the event of theft.

**Model No.**

---

**Serial No.**

---

(bottom\_en\_01)

**Information for users on collection and disposal of old equipment and used batteries:**



These symbols on the products, packaging, and/or accompanying documents mean that used electrical and electronic products and batteries should not be mixed with general household waste.

For proper treatment, recovery and recycling of old products and used batteries, please take them to applicable collection points, in accordance with your national legislation.



By disposing of these products and batteries correctly, you will help to save valuable resources and prevent any potential negative effects on human health and the environment which could otherwise arise from inappropriate waste handling.



For more information about collection and recycling of old products and batteries, please contact your local municipality, your waste disposal service or the point of sale where you purchased the items.

**For business users in the European Union:**

If you wish to discard electrical and electronic equipment, please contact your dealer or supplier for further information.



**Information on Disposal in other Countries outside the European Union:**

These symbols are only valid in the European Union. If you wish to discard these items, please contact your local authorities or dealer and ask for the correct method of disposal.

**Note for the battery symbol (bottom two symbol examples):**

This symbol might be used in combination with a chemical symbol. In this case it complies with the requirement set by the EU Battery Directive for the chemical involved.

Cd

(weee\_battery\_eu\_en\_02)

## For the AC adaptor

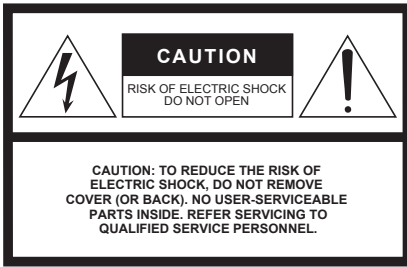

### Explanation of Graphical Symbols



The lightning flash with arrowhead symbol within an equilateral triangle is intended to alert the user to the presence of uninsulated “dangerous voltage” within the product’s enclosure that may be of sufficient magnitude to constitute a risk of electric shock to persons.



The exclamation point within an equilateral triangle is intended to alert the user to the presence of important operating and maintenance (servicing) instructions in the literature accompanying the product.

# IMPORTANT SAFETY INSTRUCTIONS

- 1 Read these instructions.
- 2 Keep these instructions.
- 3 Heed all warnings.
- 4 Follow all instructions.
- 5 Do not use this apparatus near water.
- 6 Clean only with dry cloth.
- 7 Do not block any ventilation openings. Install in accordance with the manufacturer’s instructions.
- 8 Do not install near any heat sources such as radiators, heat registers, stoves, or other apparatus (including amplifiers) that produce heat.
- 9 Do not defeat the safety purpose of the polarized or grounding-type plug. A polarized plug has two blades with one wider than the other. A grounding type plug has two blades and a third grounding prong. The wide blade or the third prong are provided for your safety. If the provided plug does not fit into your outlet, consult an electrician for replacement of the obsolete outlet.
- 10 Protect the power cord from being walked on or pinched particularly at plugs, convenience receptacles, and the point where they exit from the apparatus.

- 11 Only use attachments/accessories specified by the manufacturer.
- 12 Use only with the cart, stand, tripod, bracket, or table specified by the manufacturer, or sold with the apparatus. When a cart is used, use caution when moving the cart/apparatus combination to avoid injury from tip-over.
- 13 Unplug this apparatus during lightning storms or when unused for long periods of time.
- 14 Refer all servicing to qualified service personnel. Servicing is required when the apparatus has been damaged in any way, such as power-supply cord or plug is damaged, liquid has been spilled or objects have fallen into the apparatus, the apparatus has been exposed to rain or moisture, does not operate normally, or has been dropped.



### WARNING

TO REDUCE THE RISK OF FIRE OR ELECTRIC SHOCK, DO NOT EXPOSE THIS APPARATUS TO RAIN OR MOISTURE.

(UL60065\_03)

# PRECAUTIONS

## PLEASE READ CAREFULLY BEFORE PROCEEDING

Please keep this manual in a safe and handy place for future reference.

### For the AC adaptor



#### WARNING

- This AC adaptor is designed for use with only Yamaha electronic instruments. Do not use for any other purpose.
- Indoor use only. Do not use in any wet environments.



#### CAUTION

- When setting up, make sure that the AC outlet is easily accessible. If some trouble or malfunction occurs, immediately turn off the power switch of the instrument and disconnect the AC adaptor from the outlet. When the AC adaptor is connected to the AC outlet, keep in mind that electricity is flowing at the minimum level, even if the power switch is turned off. When you are not using the instrument for a long time, make sure to unplug the power cord from the wall AC outlet.

### For the instrument



#### WARNING

**Always follow the basic precautions listed below to avoid the possibility of serious injury or even death from electrical shock, short-circuiting, damages, fire or other hazards. These precautions include, but are not limited to, the following:**

#### Power supply/AC adaptor

- Do not place the power cord near heat sources such as heaters or radiators. Also, do not excessively bend or otherwise damage the cord, or place heavy objects on it.
- Only use the voltage specified as correct for the instrument. The required voltage is printed on the name plate of the instrument.
- Use the specified adaptor (page 72) only. Using the wrong adaptor can result in damage to the instrument or overheating.
- Use only the supplied power cord/plug.
- Check the electric plug periodically and remove any dirt or dust which may have accumulated on it.

#### Do not open

- This instrument contains no user-serviceable parts. Do not open the instrument or attempt to disassemble or modify the internal components in any way. If it should appear to be malfunctioning, discontinue use immediately and have it inspected by qualified Yamaha service personnel.

#### Water warning

- Do not expose the instrument to rain, use it near water or in damp or wet conditions, or place on it any containers (such as vases, bottles or glasses) containing liquids which might spill into any openings. If any liquid such as water seeps into the instrument, turn off the power immediately and unplug the power cord from the AC outlet. Then have the instrument inspected by qualified Yamaha service personnel.
- Never insert or remove an electric plug with wet hands.

#### Fire warning

- Do not put burning items, such as candles, on the unit. A burning item may fall over and cause a fire.

#### Battery

- Follow the precautions below. Failure to do so might result in explosion, fire, overheating or battery fluid leakage.
  - Do not tamper with or disassemble batteries.
  - Do not dispose of batteries in fire.
  - Do not attempt to recharge batteries that are not designed to be charged.
  - Keep the batteries separate from metallic objects such as necklaces, hairpins, coins, and keys.

- Use the specified battery type (page 72) only.
- Use new batteries, all of which are the same type, same model, and made by the same manufacturer.
- Always make sure all batteries are inserted in conformity with the +/- polarity markings.
- When the batteries run out, or if the instrument is not to be used for a long time, remove the batteries from the instrument.
- When using Ni-MH batteries, follow the instructions that came with the batteries. Use only the specified charger device when charging.
- Keep batteries away from small children who might accidentally swallow them.
- If the batteries do leak, avoid contact with the leaked fluid. If the battery fluid should come in contact with your eyes, mouth, or skin, wash immediately with water and consult a doctor. Battery fluid is corrosive and may possibly cause loss of sight or chemical burns.

### If you notice any abnormality

- When one of the following problems occur, immediately turn off the power switch and disconnect the electric plug from the outlet. (If you are using batteries, remove all batteries from the instrument.) Then have the device inspected by Yamaha service personnel.
  - The power cord or plug becomes frayed or damaged.
  - It emits unusual smells or smoke.
  - Some object has been dropped into the instrument.
  - There is a sudden loss of sound during use of the instrument.
  - If any cracks or breakages exist on the instrument.



## CAUTION

**Always follow the basic precautions listed below to avoid the possibility of physical injury to you or others, or damage to the instrument or other property. These precautions include, but are not limited to, the following:**

### Power supply/AC adaptor

- Do not connect the instrument to an electrical outlet using a multiple-connector. Doing so can result in lower sound quality, or possibly cause overheating in the outlet.
- When removing the electric plug from the instrument or an outlet, always hold the plug itself and not the cord. Pulling by the cord can damage it.
- Remove the electric plug from the outlet when the instrument is not to be used for extended periods of time, or during electrical storms.

### Location

- Do not place the instrument in an unstable position where it might accidentally fall over.
- Before moving the instrument, remove all connected cables, to prevent damage to the cables or injury to anyone who might trip over them.
- When setting up the product, make sure that the AC outlet you are using is easily accessible. If some trouble or malfunction occurs, immediately turn off the power switch and disconnect the plug from the outlet. Even when the power switch is turned off, electricity is still flowing to the product at the minimum level. When you are not using the product for a long time, make sure to unplug the power cord from the wall AC outlet.
- Use only the stand specified for the instrument. When attaching it, use the provided screws only. Failure to do so could cause damage to the internal components or result in the instrument falling over.

### Connections

- Before connecting the instrument to other electronic components, turn off the power for all components. Before turning the power on or off for all components, set all volume levels to minimum.
- Be sure to set the volumes of all components at their minimum levels and gradually raise the volume controls while playing the instrument to set the desired listening level.

### Handling

- Do not insert a finger or hand in any gaps on the instrument.
- Never insert or drop paper, metallic, or other objects into the gaps on the panel or keyboard. This could cause physical injury to you or others, damage to the instrument or other property, or operational failure.
- Do not rest your weight on, or place heavy objects on the instrument, and do not use excessive force on the buttons, switches or connectors.
- Do not use the instrument/device or headphones for a long period of time at a high or uncomfortable volume level, since this can cause permanent hearing loss. If you experience any hearing loss or ringing in the ears, consult a physician.

Yamaha cannot be held responsible for damage caused by improper use or modifications to the instrument, or data that is lost or destroyed.

- Always turn the power off when the instrument is not in use.
- Even when the [ ⏻ ] (Standby/On) switch is in standby status (display is off), electricity is still flowing to the instrument at the minimum level. When you are not using the instrument for a long time, make sure you unplug the power cord from the wall AC outlet.
- Make sure to discard used batteries according to local regulations.

## **NOTICE**

To avoid the possibility of malfunction/ damage to the product, damage to data, or damage to other property, follow the notices below.

### **■ Handling**

- Do not use the instrument in the vicinity of a TV, radio, stereo equipment, mobile phone, or other electric devices. Otherwise, the instrument, TV, or radio may generate noise.  
When you use the instrument along with an app on your smart device such as a smartphone or tablet, we recommend that you set to on after enabling "Airplane Mode" on that device in order to avoid noise caused by communication.
- Depending on the condition of surrounding radio waves, the instrument may possibly malfunction.
- Do not expose the instrument to excessive dust or vibrations, or extreme cold or heat (such as in direct sunlight, near a heater, or in a car during the day) to prevent the possibility of disfiguration, damage to the internal components or unstable operation. (Verified operating temperature range: 5° – 40°C, or 41° – 104°F.)
- Do not place vinyl, plastic or rubber objects on the instrument, since this might discolor the instrument.
- Do not press the LCD screen with your finger because it is a sensitive, precision-made part. Doing so might cause an appearance abnormality, such as a stripe on the LCD, although this abnormality should disappear again within a short time.

### **■ Maintenance**

- When cleaning the instrument, use a soft and dry/slightly damp cloth. Do not use paint thinners, solvents, alcohol, cleaning fluids, or chemical-impregnated wiping cloths.

### **■ Saving data**

- Some of the data of this instrument (page 68) are retained when the power is turned off. However, the saved data may be lost due to some failure, an operation mistake, etc. Save your important data onto USB flash drive/an external device such as a computer (page 59). Before using a USB flash drive, make sure to refer to page 56.
- To protect against data loss through USB flash drive damage, we recommend that you save your important data onto spare USB flash drive or an external device such as a computer as backup data.

## **Information**

### **■ About copyrights**

- Copying of the commercially available musical data including but not limited to MIDI data and/or audio data is strictly prohibited except for your personal use.
- This product incorporates and bundles contents in which Yamaha owns copyrights or with respect to which Yamaha has license to use others' copyrights. Due to copyright laws and other relevant laws, you are NOT allowed to distribute media in which these contents are saved or recorded and remain virtually the same or very similar to those in the product.
  - \* The contents described above include a computer program, Accompaniment Style data, MIDI data, WAVE data, voice recording data, a score, score data, etc.
  - \* You are allowed to distribute medium in which your performance or music production using these contents is recorded, and the permission of Yamaha Corporation is not required in such cases.

### **■ About functions/data bundled with the instrument**

- Some of the preset songs have been edited for length or arrangement, and may not be exactly the same as the original.

### **■ About the appearance of this product**

- This product may appear to have lines or scratches on the surface. The apparent lines or scratches are called "weld lines." They occur during the process of modeling the case and do not affect the functionality of the product.

### **■ About this manual**

- The illustrations and LCD screens as shown in this manual are for instructional purposes only.
- Windows is a registered trademark of Microsoft® Corporation in the United States and other countries.
- iPhone, iPad are trademarks of Apple Inc., registered in the U.S. and other countries.
- The company names and product names in this manual are the trademarks or registered trademarks of their respective companies.

# Table of Contents

Special Features .....	9
Compatible Format and Functions .....	10
Included Accessories .....	10
About the Manuals .....	11
<b>Panel Controls and Terminals</b> .....	<b>12</b>
<b>Setting Up</b> .....	<b>16</b>
Power Requirements .....	16
Turning the Power On/Off .....	18
Using a Keyboard Stand .....	19
<b>Basic Operations and Display Items</b> .....	<b>20</b>
Basic operations .....	20
Selecting Data .....	21
Display Items .....	22
<b>Using the Common Functions</b> .....	<b>23</b>
Using the Metronome .....	23
Changing the Tempo .....	23
Boosting the Entire Volume of the Instrument (Mega Boost) ...	23
<b>Playing a Variety of Instrument Voices</b> .....	<b>24</b>
Selecting a Main Voice .....	24
Adding a layer - Dual Voice .....	24
Playing a Split Voice in the Left-and Right-hand Areas ...	25
Calling Up Optimum Panel Settings—One Touch Setting (OTS) ...	25
Adding Harmony/Using Arpeggio .....	26
Adding Articulation Effects .....	27
<b>Adding Effects to Performance and Playback</b> .....	<b>28</b>
Adding DSP Effects .....	28
Adding Motion Effects .....	29
<b>Creating Original Sounds via the Knobs</b> .....	<b>30</b>
Assigning Functions to the Knobs .....	30
Using the Knobs .....	30
<b>Playing with Rhythm and Auto Accompaniment (Styles) 31</b>	
Playing with Styles .....	31
Style Playback Variations .....	32
Style Sync Stop .....	32
Turning Each Style Track On/Off .....	32
Setting the Fingering Type .....	33
Setting the Smart Chord Key .....	33
Changing the Voices for Each Part of a Style (Style Revoicing) ...	33
<b>Playing Back Songs or Audio Files</b> .....	<b>34</b>
Playing Back a Demo Song .....	35
Playing Back a Song .....	35
Playing Back an Audio File .....	36
Song/Audio File Transport Controls: Fast Forward, Fast Reverse, and Pause .....	36
Playing a Specified Section of a Song Repeatedly (A-B Repeat) ..	37
Muting Each Track .....	37
<b>Connecting and Using a Microphone</b> .....	<b>38</b>
Connecting a Microphone .....	38
Disconnecting the Microphone .....	39
<b>Playing with Groove Creator</b> .....	<b>40</b>
Playing Back a Groove .....	40
Changing the Groove Sound .....	40
<b>Using Quick Sampling</b> .....	<b>42</b>
Playing Back a Sample .....	42
Looping a Sample .....	42
Getting Ready for Sampling .....	43
Sampling External Audio .....	43
Restoring the Default Samples .....	45
Sampling a WAV File from a USB Flash Drive .....	45
Saving a Sample to a USB Flash Drive .....	45
<b>Recording Your Performance</b> .....	<b>46</b>
Recording a New User Song .....	46
Track Structure of a Song .....	47
Recording a User Song to a Specified Track .....	47
Clearing a User Song (Song Clear) .....	48
Clearing a Specified Track from a User Song (Track Clear) ....	49
Recording/Saving Audio Files to a USB Flash Drive .....	49
<b>Saving Your Favorite Settings (Registration Memory) 51</b>	
Saving Panel Settings to the Registration Memory .....	51
Recalling Panel Settings from Registration Memory .....	52
Specifying Panel Settings to be Maintained Across Registration Memory Changes (Freeze) .....	52
<b>Connecting to External Devices</b> .....	<b>53</b>
Connecting Headphones .....	53
Using a Pedal (Footswitch) .....	53
Playing Sound from External Speakers .....	53
Playing an External Audio Device with the Built-in Speakers ...	54
Using the Melody Suppressor .....	54
Using with a Computer or Smart Device .....	54
<b>Connecting a USB Flash Drive</b> .....	<b>56</b>
Using USB Flash Drives .....	57
Exiting the File Control Display .....	58
Formatting a USB Flash Drive .....	58
Saving Data to a USB Flash Drive .....	59
Loading User Data from a USB Flash Drive .....	59
Deleting Data in a USB Flash Drive .....	59
File-related Message List .....	60
<b>The Functions</b> .....	<b>61</b>
Basic Procedure in the Function Display .....	61
<b>Backup and Initialization</b> .....	<b>68</b>
Backup Data .....	68
Initializing the Instrument .....	68
<b>Troubleshooting</b> .....	<b>69</b>
<b>Specifications</b> .....	<b>71</b>
<b>Index</b> .....	<b>73</b>



## Special Features

### For PSR-E473 and PSR-EW425

#### Next Generation Sound



Thanks to the latest tone generator, the expressive power is enhanced, giving you strong, dynamic sound and presence in just a single instrument. The maximum polyphony is 64 sounds, and two DSP Effect systems are built in: DSP1 for the main sound and DSP2 which can be assigned to specific parts (page 28). Furthermore, you can use the delay effect with both DSP1 and DSP2.

#### Mega Boost Function



By pressing the [MEGA BOOST] button, you can increase the volume by up to +6 dB, with special processing separate from the normal volume control (page 23). Just with this single instrument, you can get a powerfully dynamic sound—even without connecting external speakers.

#### Mic Input



Since this instrument has a built-in microphone input terminal and can be battery-powered (page 16), you can perform with a microphone even when there is no electrical outlet. You can also apply effects such as Reverb and Chorus to the mic input, or switch to the talk settings for making announcements between songs (page 38).



820

With 820 types of Voices and 290 types of Styles (automatic accompaniment), you can play with sounds that match the music you want to play (pages 24 and 31). Moreover, you can intuitively select Voices and Styles by category, such as instrument type and music genre—making it exceptionally easy to set up for performing (page 21).



290



Authentically recreate the special performance techniques unique to each instrument by using S.Art Lite Voices (page 27).



Enhance the sound with various DSP Effects (page 28), and apply dynamically changing effects (Motion Effects) with the touch of a single button to add exciting changes to the sound (page 29).



Four simple and intuitive sampling pads give you powerful tools to spice up your performances (page 42). You can record sound on the pad with the sampling function and play it back in a loop.



Enjoy fingertip control over all the dynamic nuances of your performance with the touch-response capable keyboard (page 62).



Use the knobs for real-time control over filter sweeps, distortion, and reverb as you perform (page 30).



Use the wheel for expressively detailed and dynamic pitch-bending in real time as you play (page 15).



Connect a USB flash drive to record audio (page 46), save your original Songs, etc. (page 56).



Connect this instrument to a computer for audio and MIDI communication, and for backing up internal data (page 54).



Use the convenient OUTPUT jacks to output the sound to external speakers or a mixer, for playing onstage and in live performance venues (page 53).

### For PSR-EW425 only



76

The large 76-key keyboard gives you greater performance flexibility, even when playing with both hands with the Split function (page 25).



Incredibly realistic organ Voices let you play various organ sounds and give you full use of the wide key range of this instrument.

**Thank you for purchasing this Yamaha Digital Keyboard!**

**The instrument is a portable keyboard with featuring a wide variety of sounds and functions.**

**We recommend that you read this manual carefully so that you can fully take advantage of the advanced and convenient functions of the instrument. We also recommend that you keep this manual in a safe and handy place for future reference.**

## Compatible Format and Functions



### GM System Level 1

“GM System Level 1” is an addition to the MIDI standard which ensures that any GM-compatible music data can be accurately played by any GM-compatible tone generator, regardless of manufacturer. The GM mark is affixed to all software and hardware products that support GM System Level.



### XGlite

As its name implies, “XGlite” is a simplified version of Yamaha’s high-quality XG tone generation format. Naturally, you can play back any XG song data using an XGlite tone generator. However, keep in mind that some songs may play back differently compared to the original data, due to the reduced set of control parameters and effects.



### USB

USB is an abbreviation for Universal Serial Bus. It is a serial interface for connecting a computer with peripheral devices.



### STYLE FILE FORMAT (SFF)

The Style File Format is Yamaha’s original style file format which uses a unique conversion system to provide high-quality automatic accompaniment based on a wide range of chord types.

## Included Accessories

- Owner’s Manual (this book) x 1
- Music rest x 1
- AC adaptor x 1\*
- Online Member Product Registration x 1

\* May not be included depending on your area. Check with your Yamaha dealer.

### Attaching the Music Rest

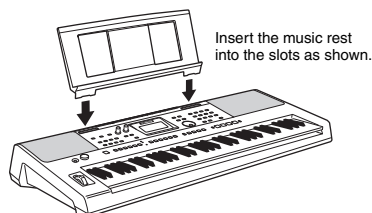

## About the Manuals

This instrument has the following documents and instructional materials.

### ■ Included Documents

- **Owner's Manual (this book)**  
Explains how to use the basic functions of the instrument.

### ■ Online Materials (Downloadable from the web)

- **Reference Manual**  
Explains how to make detailed settings for the functions of the instrument.
- **Data List**  
Contains preset content lists, such as those of Voices, Styles, Grooves and Effects.
- **Smart Device Connection Manual**  
Explains how to connect the instrument to smart devices, such as smartphones, tablets, etc.
- **Computer-related Operations**  
Contains instructions such as how to connect this instrument to a computer, how to send and receive data, etc.

To obtain these manuals, access the Yamaha Downloads, and then enter the model name for searching the desired files.

**Yamaha Downloads** <https://download.yamaha.com/>

#### **NOTE**

For a general overview of MIDI and how you can effectively use it, search for "MIDI Basics" (only in English, German, French and Spanish) on the website above.

### ■ Video Manual

Special video manuals are available that explain how to use this product, letting you see and hear how to enjoy playing with Styles and other features.



Scan the code at left or access the website below.

[https://www.yamaha.com/2/portable\\_keyboards/](https://www.yamaha.com/2/portable_keyboards/)

\*If subtitles for your own language are not displayed, set them with the "Subtitles/closed captions ©" and "Settings" button at the lower right on the YouTube screen.



"Settings" button (Sets language of the subtitles, etc.)

"Subtitles/closed captions(c)" button (Switches the subtitle display on/off.)

### ■ Song book

To obtain the Song Book, access the Yamaha Downloads above, and then enter the model name on the "Documents and Data" page.



**Song Book** (only in English, French, German, Spanish and Japanese)

Contains music scores for the preset Songs (excluding the Demo Songs) of this instrument and the optional Songs.



**B**

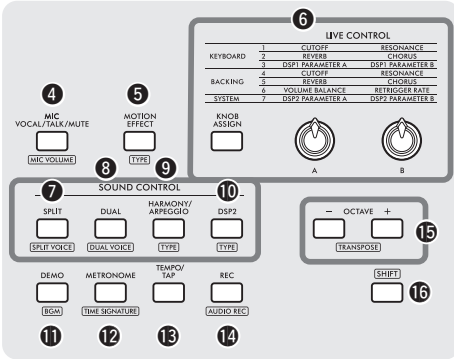

**4 [MIC VOCAL/TALK/MUTE] button** ..... page 38  
Switches the microphone type (VOCAL/TALK/MUTE).

**[MIC VOLUME]** : Calls up the Mic volume setting display.

**5 [MOTION EFFECT] button** ..... page 29  
Holding down this button adds various dynamic effects to the sound in real time.

**[TYPE]** : Calls up the Motion Effect type selection display.

**LIVE CONTROL**

**6 [KNOB ASSIGN] button, [A]/[B] knobs** ..... page 30  
Assigns a function to each knob for controlling the sound in real time.

**SOUND CONTROL**

**7 [SPLIT] button** ..... page 25  
Divides the entire keyboard into two sections, and lets you play in different Voices by your right and left hands.

**[SPLIT VOICE]** : Calls up the Voice selection display for the left-hand part.

**8 [DUAL] button** ..... page 24  
Layers two different Voices.

**[DUAL VOICE]** : Calls up the Voice selection display for the layered part.

**9 [HARMONY/ARPEGGIO] button** ..... page 26  
Turns the Harmony effect or Arpeggio function on or off.

**[TYPE]** : Calls up the Harmony type or Arpeggio type selection display.

**10 [DSP2] button** ..... page 28  
Turns the DSP2 effect on or off.

**[TYPE]** : Calls up the DSP2 type selection display.

**11 [DEMO] button** ..... page 35  
Plays back Demo Songs repeatedly.

**[BGM]** : Calls up the Song group (Demo group) setting display to play back the Songs repeatedly.

**12 [METRONOME] button** ..... page 23  
Turns the metronome on or off.

**[TIME SIGNATURE]** : Calls up the time signature setting display for metronome playback.

**13 [TEMPO/TAP] button** ..... page 23  
Calls up the tempo setting display.

**14 [REC] button** ..... page 46  
Records your performance to the instrument in MIDI format.

**[AUDIO REC]** : Records your performance to the USB flash drive in Audio format (page 49).

**15 OCTAVE [-]/[+] buttons**  
Shifts the pitch of the Main Voice and Dual Voice up or down in octave units.

**[TRANPOSE]** : Transposes the pitch of the entire instrument in semitone steps.

**16 [SHIFT] button** ..... page 12  
Holding down this button lets you call up alternate functions for panel buttons that have assigned alternate functions.

**C**

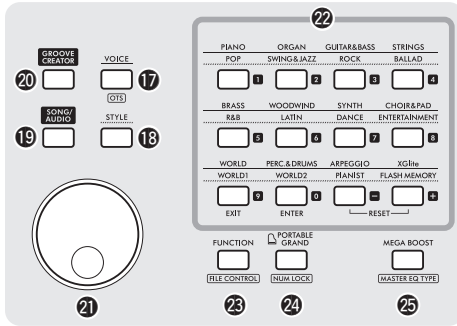

**17 [VOICE] button** ..... page 24  
Press this button to select Voices.

**[OTS]** : Calls up the optimum panel settings for the current Song, Style or Groove.

**18 [STYLE] buttons**..... page 31  
Press this button to select Styles.

**19 [SONG/AUDIO] buttons** ..... page 34  
Press this button to use the Song or Audio function.

**20 [GROOVE CREATOR] buttons**..... page 40  
Press this button to use the Groove Creator function.

**21 Dial** ..... page 21  
For changing the item or value.

**22 Category/Number input buttons, [EXIT] button, [ENTER] button** ..... page 21

For selecting the desired Voice or Style by category. Also for selecting the desired data by inputting numbers when NUM LOCK is turned on. In the other cases, the buttons in the lowest row are used as [EXIT] and [ENTER] buttons.

**23 [FUNCTION] button** ..... page 61  
Calls up the Function Setting display.

**[FILE CONTROL]** : Calls up the File Control (USB flash drive operation) display (page 57).

**24 [PORTABLE GRAND] button**  
Calls up the Grand Piano Voice.

**[NUM LOCK]** : Enables the buttons **22** to be used as number input buttons (page 21).

**25 [MEGA BOOST] button**..... page 23  
Boosts the entire volume of the instrument for more powerful sound.

**[MASTER EQ TYPE]** : Calls up the Master EQ type selection display.

**D**

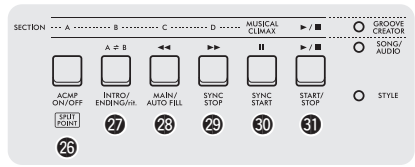

**26 – 31 Playback control buttons**

Controls playback of Style, Song/Audio, or Groove, depending on which lamp is lit.

- When the [STYLE] lamp is lit..... page 31
- When the [SONG/AUDIO] lamp is lit..... page 34
- When the [GROOVE CREATOR] lamp is lit ..... page 40

**[SPLIT POINT]** : Calls up the Split Point setting display.

**E**

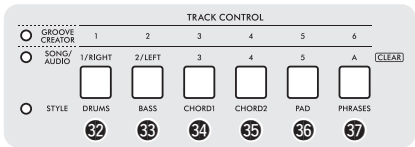

**32 – 37 [TRACK CONTROL] buttons**

Turns the track of the Style, Song/Audio, or Groove on or off, depending on which lamp is lit.

- When the [STYLE] lamp is lit..... page 32
- When the [SONG/AUDIO] lamp is lit..... page 37
- When the [GROOVE CREATOR] lamp is lit ..... page 40

**[CLEAR]** : Clears (or delete) the data of the corresponding track for the current User Song (page 49).

**F**

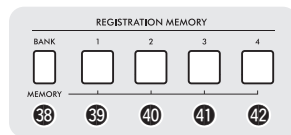

**38 – 42 [REGISTRATION MEMORY] buttons**

..... page 51

For saving the panel settings (page 15) or calling up the saved settings.

**G**

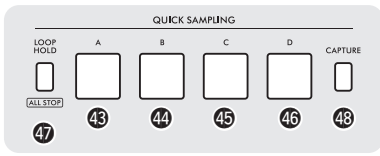

**QUICK SAMPLING**

- 43 – 46 [A] – [D] pads** ..... page 42  
Plays back the sample assigned to each pad.
- 47 [LOOP HOLD] button** ..... page 42  
While holding down this button, pressing one of the [A] – [D] pads plays the selected sample repeatedly in a loop.  
**[ALL STOP]** : Stops playback of all samples.
- 48 [CAPTURE] button** ..... page 43  
Enters the Quick Sampling mode.

**H**

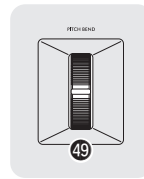

- 49 [PITCH BEND] wheel**  
Bends the pitch of the keyboard-played sound up or down by moving this upward or downward.

**Panel Settings**

By using the controls on the panel, you can make various settings as described here. These settings of the instrument are together referred to as "panel settings" in this manual.

**■ Rear Panel**

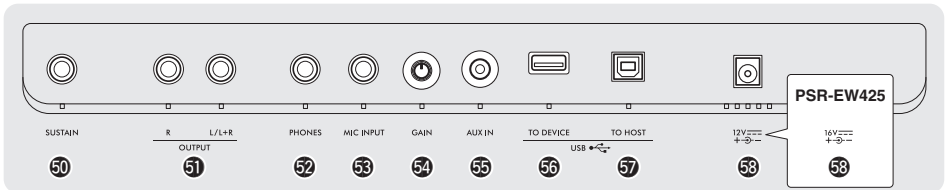

- 50 [SUSTAIN] jack** ..... page 53  
For connecting a separately sold footswitch.
- 51 OUTPUT [L+R], [R] jacks** ..... page 53  
For connecting powered speakers.
- 52 [PHONES] jack** ..... page 53  
For connecting headphones.
- 53 [MIC INPUT] jack** ..... page 38  
For connecting a microphone.
- 54 [GAIN] knob** ..... page 38  
For adjusting the input level of the connected microphone.
- 55 [AUX IN] jack** ..... page 54  
For connecting an audio player.
- 56 [USB TO DEVICE] terminal** ..... page 56  
For connecting a USB flash drive.
- 57 [USB TO HOST] terminal** ..... page 54  
For connecting a computer or a smart device.
- 58 DC IN jack** ..... page 16  
For connecting the AC adaptor.

# Setting Up

## Power Requirements

Although the instrument will run either from an AC adaptor or batteries, Yamaha recommends use of an AC adaptor whenever possible.

### NOTICE

*You should use an AC adaptor when executing USB flash drive operations, since battery power may not be reliable enough to last through these crucial operations.*

## Using an AC Adaptor

Connect the AC adaptor in the order shown in the illustration.

### PSR-E473

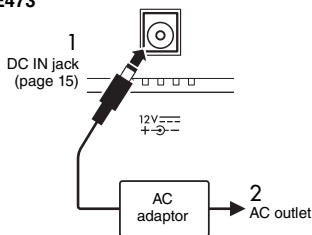

### PSR-EW425

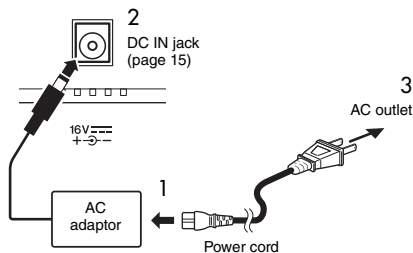

The shape of the plug may differ depending on your area.

### WARNING

- Use the specified AC adaptor (page 72) only. Using the wrong AC adaptor can result in damage to the instrument or overheating.
- When using the AC adaptor with a removable plug, make sure to keep the plug attached to the AC adaptor. Using the plug alone can cause electric shock or fire.
- Never touch the inner metallic section when attaching the plug to avoid electric shock, short circuit, or damage. Also be careful that there is no dust between the AC adaptor and plug.

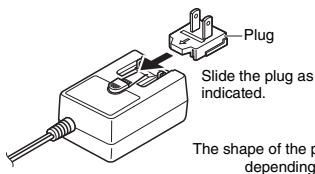

### CAUTION

*When setting up the product, make sure that the AC outlet you are using is easily accessible. If some trouble or malfunction occurs, immediately turn the power off and disconnect the plug from the outlet.*

### NOTE

*When disconnecting the AC adaptor, follow this procedure in reverse order.*

## Using Batteries

This instrument requires the following batteries:

- **PSR-E473:** Six "AA" size alkaline (LR6), manganese (R6), or Ni-MH rechargeable (HR6) batteries.
- **PSR-EW425:** Six "D" size alkaline (LR20), manganese (R20) or Ni-MH rechargeable (HR20) batteries.

The Alkaline batteries or rechargeable Ni-MH batteries are recommended for the instrument, since other types may result in poorer battery performance.

### NOTICE

*When using Ni-MH batteries, follow the instructions that came with the batteries.*

- 1 Make sure that the power of the instrument is off.
- 2 Open the battery compartment cover located on the instrument's bottom panel.

### PSR-E473

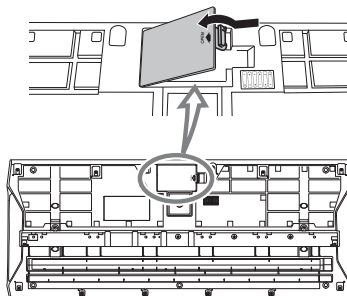



PSR-EW425

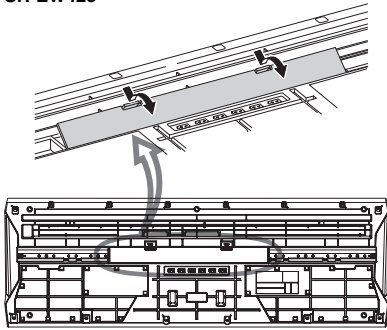

- 3 Insert the six new batteries, putting them in the correct direction according to the illustration.

PSR-E473

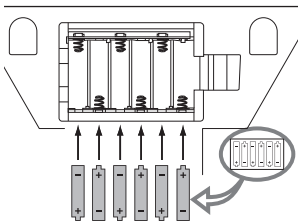

PSR-EW425

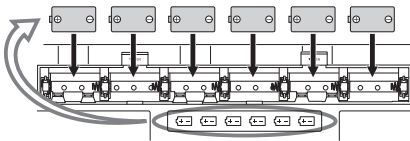

- 4 Replace the compartment cover, making sure that it locks firmly in place.
- 5 Change the battery type settings, according to the type you are using (see below).

**NOTICE**

- Connecting or disconnecting the AC adaptor with batteries installed may turn the power off, resulting in loss of data being recorded or transferred at the time.
- When battery power becomes too low for proper operation, the volume may be reduced, the sound may be distorted, and other problems may occur. When this happens, make sure to replace all batteries with new ones or already recharged ones.

**NOTE**

- This instrument cannot charge the batteries. Use only the specified charger device when charging.
- Power will be automatically drawn from the AC adaptor if an AC adaptor is connected, even while batteries are installed in the instrument.

**Setting the battery type**

You need to change the battery type setting on this instrument, depending on the battery type to be used. To change the setting, first turn on the power to the instrument, then choose the battery type you would like to use. Alkaline (and manganese) batteries are chosen by default. For details, refer to page 67 (Function 081).

**NOTICE**

Failure to set the battery type may shorten the amount of the battery life. Make sure to set the battery type correctly.

**Checking the power status**

You can check on the screen whether the battery or the AC adaptor is used as the power source. If batteries are used, you can check the remaining capacity.





 : The batteries are used.  
No display: The AC adaptor is used.

**NOTE**

The battery icon does not appear even when batteries are inserted if the AC adaptor is plugged in to the AC outlet.

**Remaining battery power indication**

	Indicates that no power left. The power will be turned off immediately.
	Indicates that remaining power is insufficient for operation. Before the power runs out, replace all the batteries with new ones, or fully recharged ones (when using rechargeable types). Note that the instrument may not work properly, including unusually soft volume and poor sound quality when remaining power becomes low.
	Indicates that the remaining power is sufficient.

## Turning the Power On/Off

- 1 Turn down the [MASTER VOLUME] control to “MIN.”

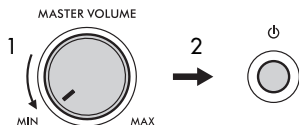

- 2 Press the [⏻] (Standby/On) switch to turn the power on.
- 3 Adjust the volume of the entire keyboard sound by using the [MASTER VOLUME] control while playing the keyboard.

### CAUTION

Do not use the instrument for a long period of time at a high or uncomfortable volume level, since this can cause permanent hearing loss.

- 4 Press and hold the [⏻] (Standby/On) switch for about a second to turn the power off.

### CAUTION

Even when the power is off, a small amount of electricity is still being consumed by the instrument. When you are not using the instrument for a long time, make sure to unplug the AC adaptor from the wall AC outlet.

### NOTICE

Press only the [⏻] (Standby/On) switch when turning the power on. Do not any other operations such as pressing keys, buttons, or the pedal. Doing so may cause the instrument to malfunction.

## Setting the Auto Power Off Function

To prevent unnecessary power consumption, this instrument features an Auto Power Off function that automatically turns the power off if the instrument is not operated for a specified period of time. The amount of time that elapses before the power is automatically turned off is 30 minutes by default; however, you can change the setting (page 67, Function 080).

### Disabling Auto Power Off (simple method)

Turn the power on while holding down the lowest key on the keyboard. This starts the instrument with the Auto Power Off function disabled.

#### PSR-E473



The lowest key

#### PSR-EW425

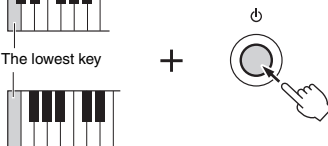

### NOTICE

In order to protect the devices from damage, when the instrument is not operated for a specified period of time while connected to an external device such as an amplifier, speaker or computer, make sure to turn off the power to the instrument and the connected devices following the instructions in the Owner's Manual. If you do not want the power to turn off automatically when a device is connected, disable Auto Power Off.

#### NOTE

- Generally, the data and settings are maintained even when the power is turned off. For details, see page 68.

## Using a Keyboard Stand

The following keyboard stands (sold separately) can be used.

- PSR-E473: L-2C
- PSR-EW425: L-6

### When using the L-6 Keyboard Stand (PSR-EW425)

The exterior size of PSR-EW425 exceeds the limits as described in the L-6 Assembly Instructions. However, we have determined through tests that the stand can be safely used for the instrument. When setting the instrument, place it on the center of the stand as shown in the illustration.

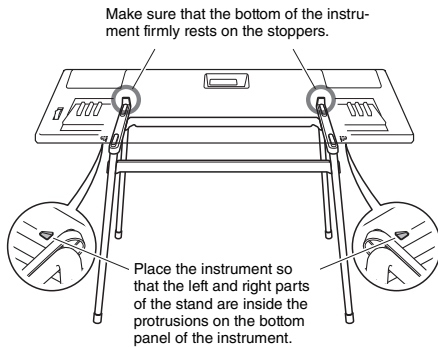

#### CAUTION

*Do not place the instrument in an unstable position where it might accidentally slip down. This could cause physical injury to you or others, as well as damage to the instrument or other property.*

# Basic Operations and Display Items

## Basic operations

This instrument features four basic functions: Voice, Style, Song/Audio and Groove Creator. To use this instrument, select a basic function first, and then select the desired data to use for your performance.

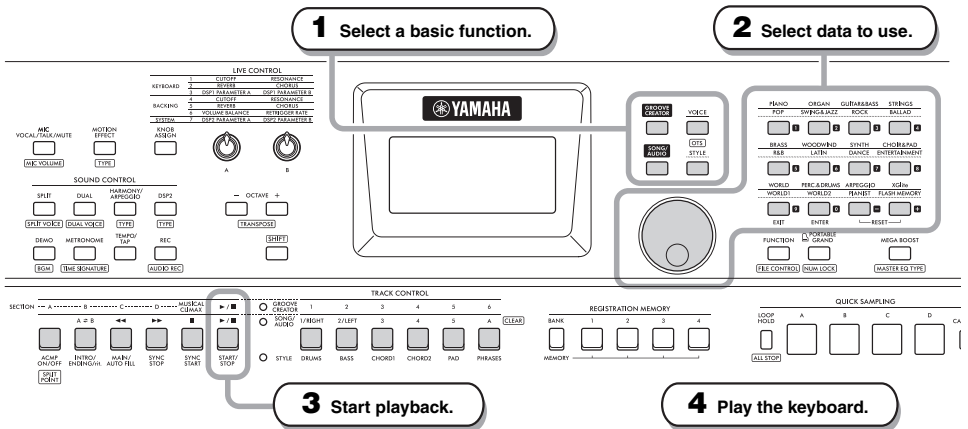

- 1 Select the desired function by pressing one of the [VOICE], [SONG/AUDIO], [GROOVE CREATOR], and [STYLE] buttons.**

When you select a basic function, the current setting value for the selected function will be shown.

**NOTE**

Only one of the Style, Song/Audio, Groove Creator function can be used. The lamp (located beside the TRACK CONTROL buttons) of the currently selected function lights up.

- 2 Select the desired data (Voice, Style, Song/Audio or Groove).**

The data can be selected by one of the following methods.

- By using the dial
- By selecting a category (only for Voices and Styles)
- By inputting the number directly

For details on each operation, refer to “Selecting Data” on page 21.

- 3 Press the [START/STOP] to start playback of Style, Song, Audio or Groove.**

**NOTE**

Press the [START/STOP] button again to stop playback.

- 4 Play the keyboard with the selected Voice.**

**NOTE**

You can also use the One Touch Setting (OTS) function (page 25) to call up the optimum panel settings (Voice, tempo, etc.) for selected Song, Style, or Groove.

## Selecting Data

You can select data (Voice, Style, etc.) by using the dial, category button or number input buttons.

### By using the dial

Rotate the dial clockwise to increase the number, or counterclockwise to decrease the number.

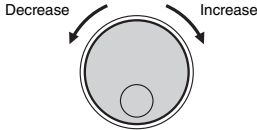

**NOTE**

In most procedures described throughout this manual, the dial is used for selecting items or changing values. Note however, that in most cases in which the dial can be used to change values, the number input buttons can also be used.

### By selecting a category (only for Voices and Styles)

The category names for Voices are in the upper row, and category names for Styles are in the lower row. Pressing the same category button repeatedly selects the successive Voices or Styles in the category in order.



### By inputting the number directly

Input the number directly pressing the number input buttons by referring to the Data List on the website (page 11). You can also use the [+], [-] buttons to increase or decrease the number.

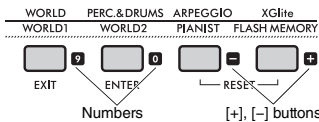

**NOTE**

- To select a Voice or Style by this method, you need to turn on NUM LOCK. For details, see "Number Input On/Off" at the right column.
- Holding down the [+ ] or [- ] button can continuously increase or decrease the number in the corresponding direction. Pressing both buttons simultaneously restores the default setting.

### Number Input mode On/Off (Only for Voices and Styles)

To input numbers when selecting Voices or Styles, you need to turn on NUM LOCK to change the category buttons to the number input buttons.

While holding down the [SHIFT] button, press the [PORTABLE GRAND] button to enable the number input mode and turn on the NUM LOCK indication in the display.



Doing the same operation again exit from the number input mode and turns off the indication.

**NOTE**

The number input mode cannot be used when selecting Song, Audio, or Groove.

## Display Items

The display shows the current instrument settings, such as Voice, Style, Song, Audio and Groove.

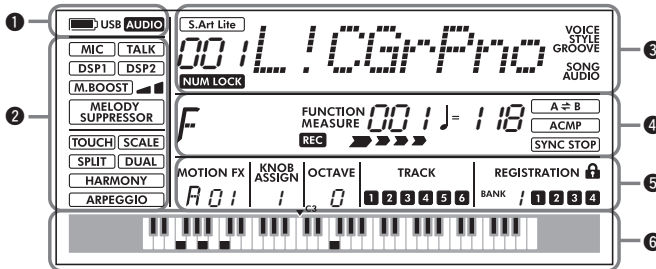

### 1 Power/USB status

Indicates the battery status and the USB flash drive status.



Battery status (page 17)



USB USB flash drive connection status (page 57)



Appears while playing back or recording an Audio file (page 49)

### 2 Function status (1)

Indicates the on/off status of each function.



Microphone (page 38)



DSP effect (page 28)



Mega Boost (page 23)



Melody Suppressor (page 54)



Touch Response (page 62)



Scale Tune (page 65)



Split (page 25)



Dual (page 24)



Harmony (page 26)



Arpeggio (page 26)

### 3 Main display

Indicates the current contents, number, and setting value, etc. Each indication at right or left shows the following status.



S.Art Lite Voice is selected (page 27)



Numbering input is effective (page 21)



Indicates the specific content to which the current number and name shown belongs. For example, when a Voice is selected, "VOICE" appears.

### 4 Playback/Recording status, Function number

Indicates the playback or recording status including the detected chord and tempo. While in the Function Setting (page 61), the function number is shown.



The chord played in the Auto Accompaniment area (page 31), or the chord specified by the Song playback



- While in the Function Setting: function number (page 61)
- During Song/Groove playback: measure number



Beat



While recording or in recording standby (page 46)



Tempo (page 23)



A-B repeat (page 37) is on



Auto Accompaniment (page 31) is on



Syncho Stop (page 32) is on

### 5 Function status (2)

Indicates the settings for each function.



Motion Effect type (page 29)



Function number for the LIVE CONTROL knobs (page 30)



Octave Shift status (page 62) for the Main Voice



On/off status of each track for the current Song/Style/Groove (pages 32, 37, 40)



Registration Memory status (page 51)

- Bank number
- Memory numbers which contain the data
- Freeze on/off

### 6 Keyboard

Indicates which key you've pressed.

# Using the Common Functions

This section explains about the common operations for each basic function, and the functions that affect the entire instrument.

## Using the Metronome

The metronome can be used for effective practice.

- 1 Press the [METRONOME] button to start the metronome.



- 2 Press the [METRONOME] button again to stop the metronome.

### Adjusting the Metronome Volume

The volume can be adjusted in the Function Setting (page 65, Function 061).

### Setting the Time Signature

The Time Signature can be set in the Function Setting (page 65, Functions 059, 060). For details, refer to the Reference Manual on the website (page 11).

## Changing the Tempo

The tempo of the Metronome, Style (page 31), Song (page 34) and Groove (page 40) can be changed.

- 1 Press the [TEMPO/TAP] button to call up "Tempo" in the display.

The current tempo value appears.

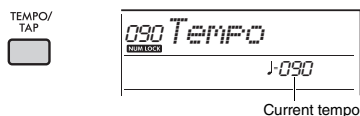

- 2 Rotate the dial to change the tempo.
- 3 Press the [VOICE] button to exit from the Tempo display.

You can also exit from the Tempo display by pressing one of the buttons below.

- GROOVE CREATOR] button
- SONG/AUDIO] button
- [STYLE] button

## Using the Tap Tempo Function

During playback of a Style or Song, you can change the tempo by tapping the [TEMPO/TAP] button twice at the desired tempo. When Style and Song are stopped, tapping the [TEMPO/TAP] button (four times for a 4/4 time signature) starts playback of the rhythm part of the Style at the tempo you tapped.



## Boosting the Entire Volume of the Instrument (Mega Boost)

The Mega Boost function increases the volume of the instrument by up to about 6dB, allowing you to enjoy a more powerful performance without having to connect external speakers. The level changes in the following order each time you press the [MEGA BOOST] button.

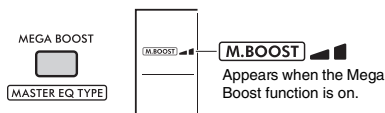

- [M.B.OOST] (1 bar) : Increase in volume (by approx. +3dB)
- [M.B.OOST] (2 bars) : Maximum increase in volume (by approx. +6dB)
- (No indication): Mega Boost off

### NOTICE

- If you use the microphone when the Mega Boost function is on, acoustic feedback may occur. If this happens, try resolving the problem by:
  - Turning down the microphone volume.
  - Turning down the Mega Boost level.
  - Turning off the Mega Boost function.
- When the Mega Boost function is turned on, the sound may be distorted depending on the selected Voice or Style.

### NOTE

- When a set of headphones is connected, the Mega Boost function is turned off automatically.
- The Mega Boost function is effective not only for the built-in speaker but also for the output from the OUTPUT [L/L+R], [R] jacks.

# Playing a Variety of Instrument Voices

This instrument features various instrumental Voices including piano. Not only can you play just one single Voice (Main Voice), but you can also layer a different Voice (Dual Voice) with the Main Voice, or play a different Voice (Split Voice) in the left-hand area of the keyboard from the right-hand area.

## Selecting a Main Voice

### 1 Press the [VOICE] button.

The Voice number and name will be shown.  
For a list of available Voices, refer to the Data List on the website (page 11).

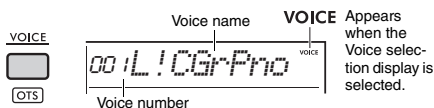

### 2 Use the category buttons or the dial to select the desired Voice. (Refer to page 21.)

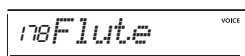
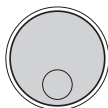
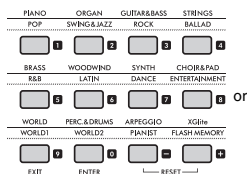

### 3 Play the keyboard.

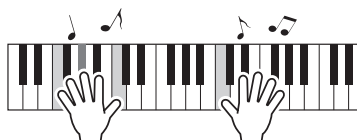

## Adding a layer - Dual Voice

In addition to the Main Voice, you can layer a second, different Voice over the entire keyboard as a "Dual Voice."

### 1 Press the [DUAL] button to turn on the layer.

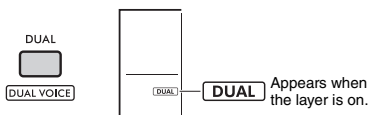

Although turning on Dual will select a Dual Voice suitable for the current Main Voice, you can also select a different Dual Voice.

### 2 Play the keyboard.

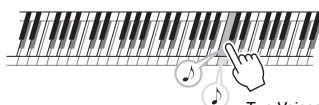

Two Voices will sound at the same time.

Press the [DUAL] button again to turn the layer off.

### Changing a Dual Voice

While holding down the [SHIFT] button, press the [DUAL] button to call up the "D.Voice" setting (page 62, Function 015).



## Playing a Split Voice in the Left- and Right-hand Areas

By dividing the keyboard into two separate areas as shown in the figure below, you can play different Voices in the left hand and right hand areas.

The Voice that is played in the left-hand area is called a “Split Voice.”

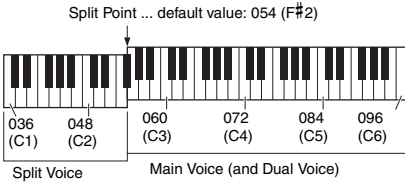

### 1 Press the [SPLIT] button to turn Split on.

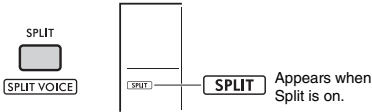

The keyboard is divided into left- and right-hand areas at the Split Point. You can play a Split Voice in the left-hand area while playing a Main Voice and Dual Voice in the right hand area of the keyboard.

The Split Voice and the Split Point can be changed as desired.

### 2 Play the keyboard.

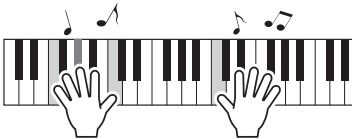

Press the [SPLIT] button again to turn Split off.

### Changing a Split Voice

While holding down the [SHIFT] button, press the [SPLIT] button. The “S.Voice” setting (page 63, Function 025) appears. Rotate the dial to change the voice.

### Changing the Split Point

Press the [STYLE] button, and then hold down the [SHIFT] button while pressing the [SPLIT] button.

The “SplitPnt” setting (page 62, Function 004) appears. Rotate the dial to change the setting.

### Adjusting the Volume of a Split Voice

Adjust the Function Settings (page 63, Function 026).

## Calling Up Optimum Panel Settings—One Touch Setting (OTS)

You can call up the optimum panel settings (Voice, tempo, etc.) for the currently selected Song, Style, or Groove.

To do so, press the [SONG/AUDIO], [STYLE], or [GROOVE CREATOR] button, and then select Voice number 000 “OTS” (page 24). (Or, alternately, hold down the [SHIFT] button and press the [VOICE] button.)

## Preset Voice Types

001–294	Instrument Voices.
295–322 (Drum/SFX Kit)	Various drum/percussion or SFX sounds are assigned to individual keys. For details on assigning instruments to keys, refer to the “Drum/SFX Kit List” in the Data List on the website (page 11).
323–362	Used for Arpeggio performance (page 26). When these are selected, the Arpeggio will automatically be turned on.
363–820	XGLite Voices, which is a simplified (light) version of Yamaha’s high-quality sound source format “XG” (page 10).
000	Selecting this automatically calls up the most suitable Voice and panel setups for the current Style, Song or Groove. This function is called the One Touch Setting (OTS).

## Adding Harmony/Using Arpeggio

You can add effects such as Harmony, Tremolo, and Echo to the the Voice played on the keyboard, or use the Arpeggio function to automatically arpeggiate chords. There are a variety of effects available for each Harmony type and Arpeggio type. For details, refer to “Effect Type List” in the Data List on the website (page 11).

### 1 Press the [HARMONY/ARPEGGIO] button.

The Harmony effect or the Arpeggio function is turned on.

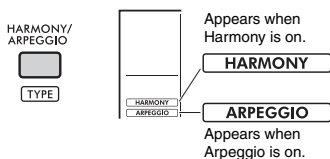

Turning on Harmony or Arpeggio will select a Harmony type or an Arpeggio type suitable for the current Main Voice. You can use the Function Settings (page 64, Function 050) to select a different Harmony type or Arpeggio type.

### 2 Press a note or notes to add a Harmony or to trigger an Arpeggio.

The method of sounding differs depending on the Harmony type. Refer to “Playing Each Harmony Type” (in the right column), and the Harmony Type List in the Data List on the website (page 11) when playing the keyboard.

Arpeggio phrases will differ depending on the number of keys you press and the area of the keyboard.

### 3 Press the [HARMONY/ARPEGGIO] button again to turn the Harmony or Arpeggio off.

#### Playing Each Harmony Type

- Harmony types 01 to 05



Turn ACMP on (page 31) and play a melody with the right-hand keys while playing chords in the Auto Accompaniment area of the keyboard.

- Harmony types 06 to 12 (Trill)



Hold down two keys.

- Harmony types 13 to 19 (Tremolo)



Keep holding down the keys.

- Harmony types 20 to 26 (Echo)



Play the keys.

#### NOTE

- When Split (page 25) is on, Arpeggio is applied only to the Split Voice. When Split is off, Arpeggio is applied to the Main and Dual Voices. Arpeggio cannot be applied to the Split and Main/Dual Voices simultaneously.
- Selecting a Voice number between 353 and 362 will turn on Split automatically, as well as Arpeggio. When one of those Voices is selected, Arpeggio is applied only to the Split Voice and is triggered only by playing a key to the left of the Split Point.
- By assigning the Arpeggio Hold function to the footswitch, the Arpeggio will continue to play after the note is released. For details, refer to the Reference Manual on the website (page 11).

#### Adjusting the Harmony Volume

You can adjust the Harmony volume in the Function Settings (page 64, Function 051).

#### Adjusting the Arpeggio Velocity

You can adjust the Arpeggio velocity in the Function Settings (page 64, Function 052).

## Adding Articulation Effects

Articulation reproduces playing techniques for particular instruments, such as guitar harmonics. Articulation is added to your performance only while the **[ARTICULATION]** button is pressed. Voices to which Articulation can be added are called S.Art Lite (Super Articulation Lite) Voices.

### 1 Select the desired S.Art Lite Voice.

When you select an S.Art Lite Voice, an indication appears in the display. In addition, S.Art Lite Voices are marked with “\*\*\*\*” on the Voice List in the Data List on the website (page 11).

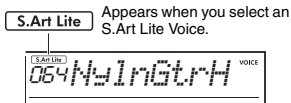

Appears when you select an S.Art Lite Voice.

### 2 Press the **[ARTICULATION]** button while playing the keyboard.



ARTICULATION



Release the **[ARTICULATION]** button to turn Articulation off.

### Examples of Articulation effect

If you select Guitar, you can use the following operations to realistically reproduce playing techniques that are unique to the guitar.

#### Example: Voice Number 064 “S.Art Lite Nylon Guitar Harmonics”

Hold the **[ARTICULATION]** button while playing the keyboard to recreate guitar harmonics.

#### Example: Voice Number 068 “S.Art Lite Distortion Guitar”

Press the **[ARTICULATION]** button to make scratch noises.

The optimal Articulation for a Voice is applied only if the S.Art Lite Voice is selected.

In other cases, Articulation is not added. Instead, a modulation effect is applied to the produced sound.

### Using a Pedal to Add Articulation

If the Articulation function is applied to a pedal (foot-switch) in the Function Settings (page 64, Function 054), you can conveniently step on the pedal to apply the effect as you play.

#### NOTE

- Articulation is only applied to the Main Voice.
- S.Art Lite Voices sound differently depending on the velocity.

# Adding Effects to Performance and Playback

You can expand your range of expression by adding effects to keyboard performances, Style/Song/Groove playback, and microphone input.

## Adding DSP Effects

This instrument is equipped with two DSPs (digital signal processors) for applying digital effects that enhance the sound (DSP1, DSP2). DSP1 applies DSP effects to the Main Voice, and DSP2 applies DSP effects to specified parts in the Function Settings (page 63, Function 043).

For details about the types of DSP effects available, refer to the “Effect Type List” in the Data List on the website (page 11).

### DSP1 Settings

When you select a Main Voice, the optimal type of DSP1 effect is automatically selected.

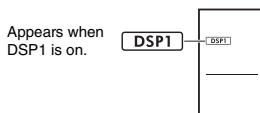

If you want to change the DSP1 effect type or turn DSP1 off, make these changes in the Function Settings (page 63, Function 041).

### DSP2 Settings

The DSP2 effect is not automatically selected. You can utilize this effect by turning DSP2 on/off and selecting the type and target for the effect yourself.

1 Press the [DSP2] button to turn DSP2 on.

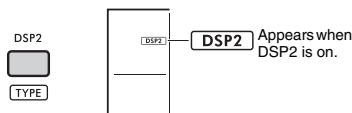

2 While holding down the [SHIFT] button, press the [DSP2] button to call up the “DSP2Type” settings.

The current DSP2 type appears.

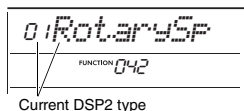
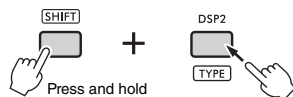

3 Rotate the dial to select the desired DSP2 type.

4 Press the [ENTER] button to exit the “DSP2Type” settings.

5 Rotate the dial until Function 043 “DSP2Part” appears.

6 Press the [ENTER] button to call up the “DSP2Part” settings.

The current part that is targeted appears.

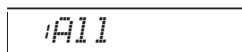

7 Rotate the dial to select the target part for the DSP2 effect.

The target parts correspond to the setting value are as listed below.

1	All	All parts from 2 to 5
2	Keyboard	Main, Dual, and Split Voices
3	Backing	Style, Groove, Song playback, MIDI input
4	Mic	Microphone input
5	Sampling	Sampling pad playback

8 Press the [FUNCTION] button to exit the Function Settings.

9 Play the part selected in Step 7, and make sure that the DSP2 effect is applied.

10 Press the [DSP2] button again to turn DSP2 off.

### Limitations when recording a User Song (MIDI)

DSP1 and DSP2 settings (type, on/off, target part) are not recorded in User Songs. However, you can record your performance with DSP effects and save it as an audio file to a USB flash drive.

### NOTE

- DSP1 and DSP2 settings can be memorized to and called up from Registration Memory (page 51).
- For more details about the DSP1, DSP2 and other effects, refer to the block diagram in the Reference Manual on the website (page 11).

## Adding Motion Effects

You can add dynamic effects to your performance. Motion effects are added only while the [MOTION EFFECT] button is pressed and held.

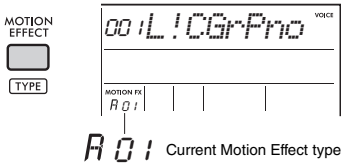

There are various types of Motion Effects, such as filter effects, pitch effects, and modulation effects. For details about the different types of Motion Effects available, refer to “Effect Type List” in the Data List on the website (page 11).

### Changing the Motion Effect Type

- While holding down the [SHIFT] button, press the [MOTION EFFECT] button to call up the Type selection display.

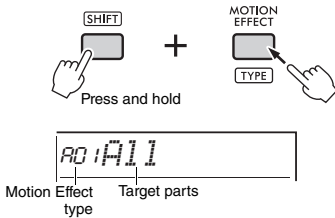

- Rotate the dial to select the desired type. While holding down the [SHIFT] button, press the [+] button or the [-] button to move to the first type in each effect group.
- Press the [EXIT] button to exit the Type selection display.

### Target parts of Motion Effect type

Target parts of each type is displayed as follows on the type selection display.

Display	Target Parts
All	All parts below
Keyboard	Main, Dual, and Split Voices
StyGrv	Style, Groove
StyGrvDr	Rhythm parts of Style and Groove
StyGrvAc	ACMP (accompaniment) parts of Style and Groove
Sampling	Sampling pad playback
KbSampl	Main, Dual, and Split Voices, Sampling pad playback

# Creating Original Sounds via the Knobs

The two knobs can be used to add variations to the sound being played, transforming the sound in a variety of musical ways. Select the desired function combination printed above the knobs, and then rotate the knobs as you play, for more expressive and dynamic performance.

## Assigning Functions to the Knobs

Repeatedly press the [KNOB ASSIGN] button to sequentially assign the function combinations provided: 1 → 2 → 3 → 4 → 5 → 6 → 7 → 1 ... etc.

LIVE CONTROL			
KEYBOARD	1	CUTOFF	RESONANCE
	2	REVERB	CHORUS
BACKING	3	DSP1 PARAMETER A	DSP1 PARAMETER B
	4	CUTOFF	RESONANCE
SYSTEM	5	REVERB	CHORUS
	6	VOLUME BALANCE	RETRIGGER RATE
	7	DSP2 PARAMETER A	DSP2 PARAMETER B



A

B

The current combination is shown in the display.

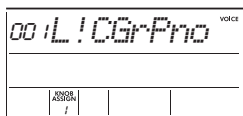

KNOB ASSIGN

! Functions assigned to the knobs

The target differs depending on the function.

Function	Target
1 Cutoff; Resonance	Key-board Main Voice, Dual Voice
2 Reverb; Chorus	
3 DSP1 Parameter A; DSP1 Parameter B	Main Voice
4 Cutoff; Resonance	Backing Style, Groove
5 Reverb; Chorus	
6 Volume balance; Retrigger rate	
7 DSP2 Parameter A; DSP2 Parameter B	System Selected part in the Function Settings (page 63, Function 043)

For details about the functions assigned to the knobs, refer to the Reference Manual on the website (page 11).

### NOTE

- Only selecting a function combination will not affect the sound even if the knob arrow is not at the center position. The selected function only works when the knob is moved.
- Depending on the panel settings or how you move the knob, you may not notice any change to the parameter value, or you may hear a noise, or the knob may not work properly, even if you rotate it.
- Some types of DSP1 effects do not change even if the function assignment is set to 3 and the knob is turned.
- Function assignments can also be changed by holding down the [KNOB ASSIGN] button and pressing the OCTAVE [-]/[+] buttons.

## Using the Knobs

Here is an example of how to use the knobs.

### 1 Select the desired Voice (page 24).

In this example, we will use Voice No.197 "SquareLd" (Square Lead) as a synth-lead type Voice.

### 2 Press the [KNOB ASSIGN] button several times to assign Function 1 to the knob.

The number 1 appears on the display (below "KNOB ASSIGN").

### 3 Rotate knob B all the way to the right (maximum), and then play the keyboard with your right hand while operating knob A with your left.

Cutoff Resonance

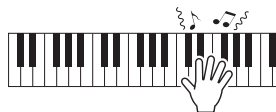

### NOTICE

If you have added an effect to the Main Voice and then change that Voice, the settings created via the knobs will be replaced with the default settings of the new Voice. If you want to keep the settings you have created, make sure to memorize them to the Registration Memory (page 51) before selecting a different Voice.

### NOTE

Rotating a knob to the right while the volume is set to a high level may result in distortion. If this occurs, reduce the volume level.

For more specific examples, refer to "Playing Like a DJ" in the Reference Manual on the website (page 11).

# Playing with Rhythm and Auto Accompaniment (Styles)

This instrument is equipped with rhythms and accompaniment patterns in a variety of genres, called Styles. You can use the Auto Accompaniment (ACMP) function for a Style to play the appropriate accompaniment simply by playing chords with your left hand. This allows you to enjoy being accompanied by a band or orchestra, even when you are playing alone.

## Playing with Styles

### 1 Press the [STYLE] button.

The Style number and name will be shown.

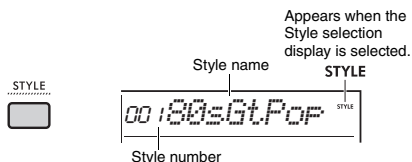

### 2 Press the category buttons or rotate the dial to select the desired Style.

For details about Style numbers and names, refer to the Data List on the website (page 11).

### 3 Press the [ACMP ON/OFF] button to turn on the Auto Accompaniment (ACMP).

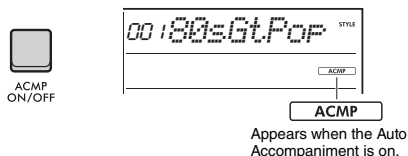

The area of the keyboard to the left of the Split Point becomes the "Auto Accompaniment area" and is used only for specifying the chords.

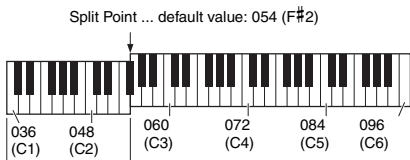

Auto Accompaniment area

#### NOTE

- The Split Point can be changed as desired (page 62).
- Even if you play in the Auto Accompaniment area (left-hand area), the Main Voice and Dual Voice do not sound, only the chords are recognized. However, when Split is on, you will hear the Split Voice.

### 4 Press the [SYNC START] button to turn Sync Start on.

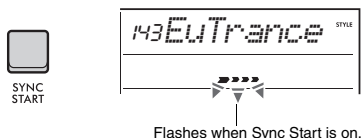

The Style playback is set to standby, and the Style starts playing back when you play a chord.

### 5 Play a chord in the Auto Accompaniment area to start playback of the Style.

Play a melody with the right hand and chords with the left hand.

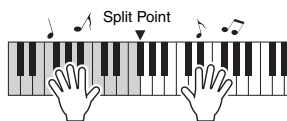

For details about playing chords, refer to the Reference Manual on the website (page 11).

#### NOTE

Instead of playing chords normally, you can also use Smart Chord to play chords with one finger. For details, refer to "Setting the Fingering Type" (page 33).

### 6 Press the [START/STOP] button to stop Style playback.



#### Playing Back Only the Rhythm Part

In Step 3, if you press the [START/STOP] button without pressing the [ACMP ON/OFF] button, only the rhythm part will play back.

#### NOTE

For Styles that do not have any rhythm data, there will be no sound when you try to play back only the rhythm part. In that case, the accompaniment will play back only if you turn ACMP on and play chords in the Auto Accompaniment area.

## Style Playback Variations

Styles have Intro, Main A/B, and Ending sections. The Main A section is played as default pattern, but you can add variations to a performance by switching sections. The operations for switching to each section are described below.

### Intro:

While playback is stopped, press the **[INTRO/ENDING/rit.]** button. When playback starts, after the Intro finishes, it automatically switches to either Main A or Main B.

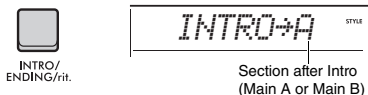

### Main A/B:

Press the **[MAIN/AUTO FILL]** button. If playback is stopped, it switches between Main A and Main B. If during playback, an Auto Fill is inserted when switching between Main A and Main B.



### Auto Fill:

A short, dynamic riff or rhythmic break is inserted automatically when switching between Main A and Main B.

### Ending:

During playback, press the **[INTRO/ENDING/rit.]** button. The Section switches to the Ending. When the Ending finishes, Style playback stops automatically.

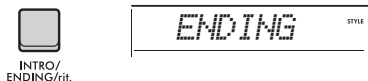

You can have the Ending gradually slow down (ritardando) and end, by pressing the **[INTRO/ENDING/rit.]** button again while the Ending is playing back.

## Adjusting the Volume of the Style

You can adjust the volume balance between Style playback and your keyboard performance. Adjust it in the Function Settings (page 63, Function 031).

## Changing the Tempo

Refer to "Changing the Tempo" on page 23.

## Style Sync Stop

When you press the **[SYNC STOP]** button to turn on this function, the Style will only play while pressing chords in the Auto Accompaniment area of the keyboard. Releasing all the notes will stop Style playback. Press the **[SYNC STOP]** button again to turn it off.

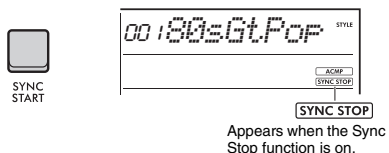

### NOTE

This function can be used when ACMP is turned on.

## Turning Each Style Track On/Off

A Style consists of multiple tracks. To play back or mute specific tracks, use the **TRACK CONTROL** buttons to turn individual tracks on and off.

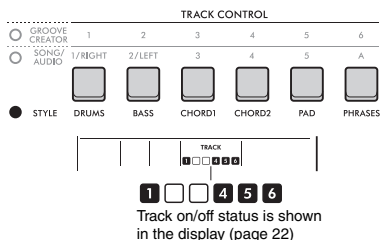

### NOTE

Up to two Track buttons can be pressed simultaneously when turning Tracks on or off.



## Setting the Fingering Type

When playing back a Style, the method for playing chords in the Auto Accompaniment area is called a Fingering Type. This instrument has two Fingering Types.

### ● Multi-Finger (default)

Play the entire notes of a chord to play back the Auto Accompaniment. However, you can also easily play major, minor, seventh, and minor seventh chords by simply pressing one to three keys.

### ● Smart Chord

Play only the root note of a chord to play back Auto Accompaniment. However, in order to use Smart Chord for Auto Accompaniment, you need to set the key for the song you are performing (Smart Chord Key).

#### **NOTE**

For details about how to play chords for each Fingering Type, refer to the Reference Manual on the website (page 11).

- 1 Press the [FUNCTION] button.
- 2 Rotate the dial until “FingType” (page 63, Function 032) appears on the display.



- 3 Press the [ENTER] button.  
The current Fingering Type appears.

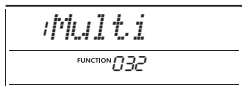

- 4 Rotate the dial to select “Multi” or “SmartChd.”
- 5 Press the [FUNCTION] button to exit the Function Settings.

## Setting the Smart Chord Key

If you selected Smart Chord as the Fingering Type, set the key of the song based on the number of sharps (#) and flats (b) shown on the score before you start playing. This key is called the “Smart Chord Key.”

Use the following steps to set the Smart Chord Key.

- 1 Press the [FUNCTION] button to call up the Function Settings.
- 2 Rotate the dial until “S.ChdKey” (Function 033) appears.

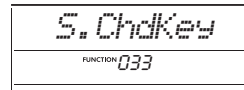

- 3 Press the [ENTER] button.  
The current Smart Chord Key appears.

- 4 Rotate the dial to set the Smart Chord Key appropriate for the score.

For example, if you want to play the following score, set the Smart Chord Key to “FL2” (two flats; see page 63).



- 5 Press the [FUNCTION] button to exit the Function Settings.

## Changing the Voices for Each Part of a Style (Style Revoicing)

This instrument allows you to change the Voices that are used in each track of a Style, such as drums and phrases. For details, refer to the Reference Manual on the website (page 11).

# Playing Back Songs or Audio Files

With this instrument, you can play back Songs (MIDI data) and audio files. In addition to listening to the playback, you can play the keyboard along with the Song or audio file playback.

## **Song (MIDI Data)**

This instrument can play Preset Songs, Songs you recorded on this instrument, or commercially available Songs. MIDI data is comprised of your keyboard performance information, such as pressing/releasing keys, etc. The performance information refers to which keys are played, at what timing, and at what strength—just as in a musical score, and the information is not a recording of the actual sound itself. Based on the recorded performance information, the tone generator outputs the corresponding sound. Since information such as keyboard parts and Voices is also recorded, individual parts can be turned on and off and Voices can be changed. This makes it a very useful tool for practicing. With this instrument, you can export a User Song from the internal memory to a USB flash drive as a MIDI file. In addition, you can play back external MIDI files as a Song, by transferring the files from a computer into the internal memory using Storage Mode (pages 55, 66), or by connecting a USB flash drive containing the files to the instrument.

This instrument can play back SMF (Standard MIDI File) format data.

## **Song Category**

The Songs are categorized according to their characteristics.

Song Number	Song Category	
001-003	Main Demo	Gives you an idea of the advanced capabilities of this instrument.
004-011	Voice Demo	Demonstrates many useful Voices of this instrument.
012-015	Piano Solo	Provides enjoyable piano solo performances.
016-020	Piano Ensemble	Features piano ensemble pieces. Enjoy the sound of piano and orchestra.
021-030	Piano Accompaniment	Provides enjoyable piano accompaniment in a variety of genres.
031-040	User	Contains Songs you have recorded yourself (page 46).
041-	Downloads	Contains Songs transferred from a computer (downloaded songs) (page 54).
	USB	Contains Songs in the USB flash drive.

### **NOTE**

- For Songs following 041, numbers are assigned in the following sequence: Songs transferred from a computer, Songs in the USB flash drive. When you transfer a Song from a computer, the transferred Song will be inserted before the first USB Song number, moving all USB Song numbers later in sequence.
- Songs that are larger than 250 KB cannot be played back.

## **Audio File**

An audio file is a recording of the performed sound itself. This data is recorded in the same way as that used in recording with voice recorders, etc. This data can be played with a portable music player, etc., allowing you to easily let other people listen to your performance.

You can play back audio files (WAV files of 44.1 kHz, 16-bit, stereo) contained in a USB flash drive with this instrument.

## Playing Back a Demo Song

Press the [DEMO] button.

Demo Songs 001–003 are played back in sequence. Playback will repeat continuously, starting again from the first Song (001).



To stop playback, press the [DEMO] or [▶/■] (Start/Stop) button.

## Continuous Playback as Background Music

When you press the [DEMO] button, Song numbers 001 to 003 are played continuously as background music by default. However, you can change the Songs that are targeted for continuous playback, or set a random playback sequence. For details, refer to the Reference Manual on the website (page 11).

## Playing Back a Song

1 Press the [SONG/AUDIO] button. The SONG icon appears.

If the AUDIO icon appears, press the [SONG/AUDIO] button again. If “NoUSB” is displayed instead of the SONG icon, wait a few seconds for the SONG icon to appear.

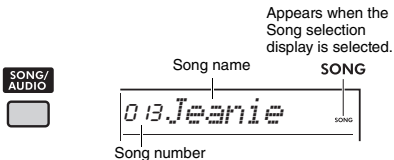

2 Rotate the dial to select a Song.

For a list of preset Songs, refer to the Data List on the website (page 11). You can select User Songs, downloaded Songs, and Songs in the USB flash drive in the same way.

**NOTE**

- The selectable Songs are number 004 and later. When selecting the number 001 to 003, press the [DEMO] button.
- By holding down the [SHIFT] button and pressing the [-]/[+] button, you can conveniently select the first Song in each category (page 34) in order.

3 Press the [▶/■] (Start/Stop) button to start playback.

To stop playback, press the [▶/■] (Start/Stop) button again.

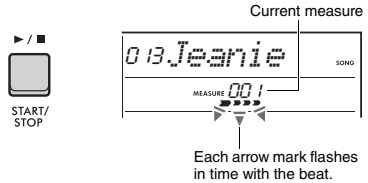

**NOTE**

If playback of a Song in the USB flash drive or a downloaded Song produces distorted sound, decrease the Song volume (page 63) to reduce the distortion, and then adjust the master volume (page 12).

## Adjusting the Song Volume

You can adjust the volume balance between Song playback and your keyboard performance. Adjust this in the Function Settings (page 63, Function 035).

## Changing the Tempo

Refer to “Changing the Tempo” on page 23.

## Playing Back an Audio File

### NOTICE

*Do not disconnect the USB flash drive or turn off the power to the instrument during playback of an audio file. Otherwise, damage to the data may occur.*

### 1 Connect a USB flash drive to the [USB TO DEVICE] terminal.

For details, refer to “Connecting a USB Flash Drive” on page 56.

### 2 Press the [SONG/AUDIO] button. The AUDIO icon appears.

If the SONG icon appears, press the [SONG/AUDIO] button again.

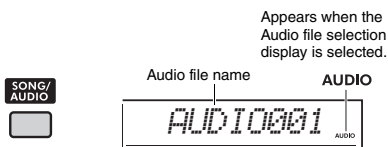

### 3 Rotate the dial to select the desired audio file.

You can also use the [-]/[+] buttons the top right side of the panel. Press the [-] and [+] buttons simultaneously to instantly jump to the first audio file.

### 4 Press the [▶/■] (Start/Stop) button to start playback of the audio file.

During playback, “PLY” and the time elapsed is shown on the display. To stop playback, press the [▶/■] (Start/Stop) button again.

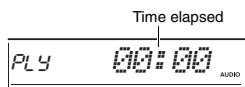

#### NOTE

The following operations cannot be executed for audio file playback.

- Changing the Voice
- A-B Repeat
- Muting a track
- Changing the tempo

## Message List

Message	Description
NoUSB	No USB flash drive is connected.
NoFile	There is no audio file in the USB flash drive.
ErrLoad	Cannot load the audio file because the format is not compatible with this instrument.
USB Err	The USB flash drive may have a problem. <ul style="list-style-type: none"> <li>• Check if the USB flash drive is included on the Compatible Device List on the website (page 56).</li> <li>• Format the USB flash drive (page 58).</li> </ul>

## Song/Audio File Transport Controls: Fast Forward, Fast Reverse, and Pause

### [▶▶] (Fast Forward) button

During playback, press this button to rapidly skip ahead to a later point in the Song or audio file. For a Song, pressing this button while playback is stopped will increase the measure number.



### [◀◀] (Fast Reverse) button

During playback, press this button to rapidly return to an earlier point in the Song or audio file. For a Song, Fast Reverse returns by measure. Pressing this button while playback is stopped will decrease the measure number.

### [||] (Pause) button

During playback, press this button to pause the Song or audio file. Press it again to start from that point.

#### NOTE

- During playback of a Song, if A-B repeat is set, the Fast Reverse and Fast Forward will only work within the range between A and B.
- The [◀◀], [▶▶], and [||] buttons cannot be used for Demo Song playback started by using the [DEMO] button.
- When you fast-reverse the Song with the DSP2 turned on, the DSP2 Effect may not function or sound as expected. If this happens, turn the DSP2 off and then back on, or stop playing the Song once to restore the DSP2 state.

## Playing a Specified Section of a Song Repeatedly (A-B Repeat)

You can play back only a specific section of a Song (MIDI data) repeatedly by setting the A point (start point) and B point (end point) in one-measure increments.

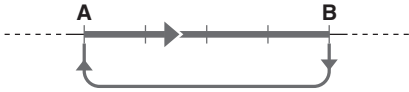

- 1 **Start playback of the Song (page 35).**
- 2 **When playback reaches the point you want to specify as the start point, press the [A ⇌ B] (A-B Repeat) button to set the (A point).**  
 “A- REPEAT” appears on the display for a few seconds.
- 3 **When playback reaches to the point you want to specify as the end point, press the [A ⇌ B] (A-B Repeat) button again to set the B point.**  
 The specified A-B section of the Song will now play repeatedly.  
 “A-b REPEAT” appears on the display for a few seconds, and the A-B Repeat icon appears.
- 4 **To cancel repeat playback, press the [A ⇌ B] (A-B Repeat) button again.**  
 “oFF REPEAT” appears on the display for a few seconds.  
 To stop playback, press the [▶/■] (Start/Stop) button.

**NOTE**

- If you want to set start point A to the top of the Song, press the [A ⇌ B] (A-B Repeat) button before starting playback.
- If you want to set end point B to the end of the Song, specify only the A point and play back the Song to the end.



## Muting Each Track

Each track of a Song plays different parts, such as the melody, rhythm, and accompaniment, etc. Each of the tracks can be muted so that you can play the muted part yourself. To mute a track, press the corresponding button for that track ([1/RIGHT] to [5], [A]). To unmute the track, press the same button again.

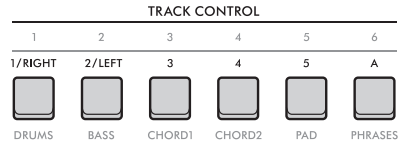

The status of each track is shown in the display.

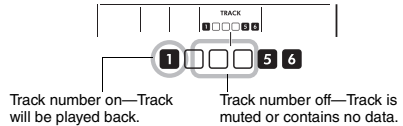

**NOTE**

Up to two Track buttons can be pressed simultaneously when turning Tracks on or off.

# Connecting and Using a Microphone

By connecting a microphone to the [MIC INPUT] jack, you can sing along with your keyboard performance while applying reverb and chorus effects to your vocals. Sound that is input from the microphone is played from the built-in speakers. You can also switch to the Talk setting when you want to talk between songs.

## ⚠ CAUTION

Before connecting the instrument to external devices, turn off the power of all the devices. Also, before turning the power on or off, make sure to set all volume levels to minimum. Otherwise, damage to the devices or electrical shock may occur.

## Connecting a Microphone

- 1 Before turning the instrument on, turn down the [MASTER VOLUME] control to "MIN."

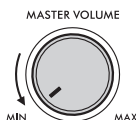

- 2 Set the [GAIN] knob on the rear panel to the center position.



- 3 Connect a microphone to the [MIC INPUT] jack (standard mono phone jack) on the rear panel.

If the microphone has a switch, switch it on before Step 4.

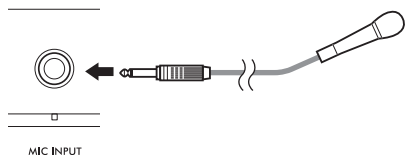

### NOTE

Make sure to use a dynamic microphone.

- 4 Turn the instrument on.

- 5 Adjust the overall volume by using the [MASTER VOLUME] control.

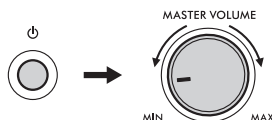

- 6 While holding down the [SHIFT] button, press the [MIC VOCAL/TALK/MUTE] button to call up the Mic Volume setting display.



- 7 While singing into the microphone, turn the dial to adjust the volume of the microphone.

If you cannot get a suitable microphone volume from turning this dial, adjust the [GAIN] knob on the rear panel.

- 8 Press the [FUNCTION] button to exit the Function Settings.

- 9 Sing into the microphone while playing the keyboard and playing back a Song.

## Using the Talk Function

Press the **[MIC VOCAL/TALK/MUTE]** button to switch the Mic type to Talk.

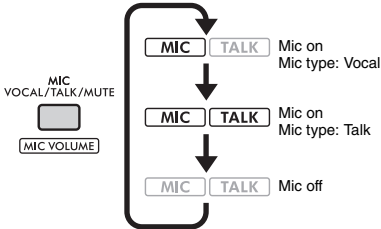

When the Mic type is set to Talk, the reverb and chorus are turned off and the microphone is panned to the center.

## Panning the Microphone

You can adjust the microphone's pan (position) setting. Make this setting in the Function Settings (page 64, Function 045).

## Adding Reverb and Chorus to the Microphone

You can add effects to the microphone for vocals, such as Reverb to make it sound as if you are singing in a concert hall, or Chorus to add depth and natural movement to your voice. Make these settings in the Function Settings (page 64).

- **Reverb: Function 046**
- **Chorus: Function 047**

## Disconnecting the Microphone

- 1 Turn the volume down by turning the **[MASTER VOLUME]** control all the way to the left.

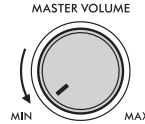

- 2 Turn the instrument off.
- 3 Disconnect the microphone from the **[MIC INPUT]** jack.

# Playing with Groove Creator

The Groove Creator function lets you combine rhythmic preset patterns and phrases (each called a Groove) from a variety of dance music genres for dynamic and powerful performances.

Try out the expressive performance features, such as changing keys in the left-hand area of the keyboard and rotating the knobs for dynamic sound variations.

## Playing Back a Groove

- 1 Press the [GROOVE CREATOR] button, and use the dial to select the desired Groove.

ACMP is automatically turned on, and the keyboard is divided into the Auto Accompaniment area (page 31) and melody area.

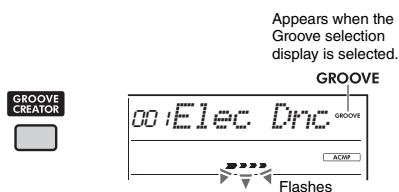

### NOTE

- By holding down the [SHIFT] button and pressing the [-] or [+] button, you can select the first Groove in each genre in order.
- For a list of available Grooves and details about genres and categories, refer to the Data List on the website (page 11).

- 2 Press the [▶/■] (Start/Stop) button to start Groove playback.

You can also start playback by playing the keys in the Auto Accompaniment area (page 31).



Use the following operations to make various changes to the sound during Groove playback. For details, refer to “Changing the Groove Sound” on the right.

- 3 Press the [▶/■] (Start/Stop) button to stop Groove playback.

### Adjusting the Volume of the Groove

You can adjust the volume balance between Groove playback and your keyboard performance. Adjust the Function Settings (page 63, Function 034).

### Changing the Tempo

Refer to “Changing the Tempo” on page 23.

### Using the Tap Function

Refer to “Using the Tap Tempo Function” on page 23.

## Changing the Groove Sound

You can make various changes to the sound by performing the following operations while playing back the Groove.

- **Turning each track on/off**

Use the TRACK CONTROL [1]-[6] buttons to turn individual tracks on/off.

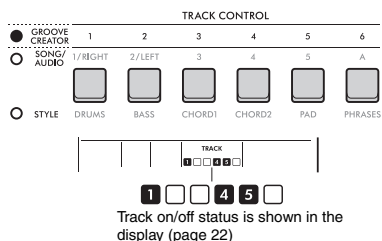

### NOTE

Up to two Track buttons can be pressed simultaneously when turning Tracks on or off.

- **Changing sections**

Use the SECTION [A]-[D] buttons to change sections.

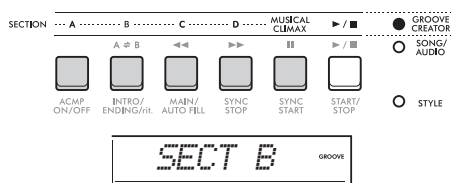

- **Using the [MUSICAL CLIMAX] button**

When you press the button, a negative count (indicating a lead-in) appears on the display.

As the lead-in approaches 0, the Groove builds in intensity and variation and comes to a musical climax when the count reaches 0.

You can create dynamic and powerful performances by switching to another section or another Groove at a climax.

Moreover, this can also be used as an Ending; the Groove stops after the count reaches 0 and an Ending phrase is played.



### ● Using the Retrigger function

Groove Retrigger is a function which repeats the first part of the current Groove, for a rhythmic break effect. For details about how to use this function, refer to the Reference Manual on the website (page 11).

### ● Changing the key

Play the keyboard in the Auto Accompaniment area (page 31).

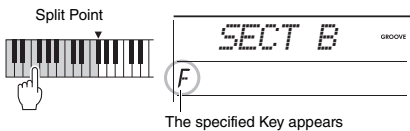

### ● Changing the sound via the Knobs

Press the [KNOB ASSIGN] button several times to select Function 4, 5, or 6, and turn the Knob. For details about Knob effects, refer to page 30.

### ● Playing Arpeggios in the right-hand area

Select the Arpeggio type in the Function Settings (page 64, Function 050), press the [HARMONY/ARPEGGIO] button to turn the Arpeggio on, and then play the notes in the right-hand area of the keyboard. For details about Arpeggios, refer to page 26.

#### NOTE 4

- When Split is on, Arpeggio is applied only when you play the keyboard in the left-hand area. At the same time, the Key of the Groove also changes.
- When you select a Voice from 353 to 362, Split and Arpeggio are turned on automatically.

# Using Quick Sampling

This instrument features an extremely convenient and powerful Quick Sampling function for sampling audio and playing it back with the pads.

## Sampling

Sampling is a technology that lets you record a short portion of a song or a sound, and use the sound (called a “sample”) as part of your performance. Unlike audio files, the samples can be used in various ways: to add special sound effects, or to play in a loop for a repeating rhythmic pattern.

There are three types of audio input that can be sampled.

- Audio from an external device connected to the [AUX IN] jack (page 54)
- Vocals from a microphone connected to the [MIC INPUT] jack (page 38)
- Audio from a computer, smartphone, or tablet connected to the [USB TO HOST] terminal (page 54)

WAV files saved on a USB flash drive can also be sampled (page 45).

A set of samples (already sampled audio) are already built into this instrument. Try playing them to see how powerful the sampling features are!

## Playing Back a Sample

- 1 Press one of the QUICK SAMPLING [A]-[D] pads.

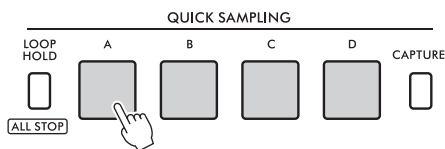

The pad lights up and plays back a sample while you press it.

If you continue to press the pad, the sample plays to the end and then stops. This is called “One-shot playback.”

- 2 Release the QUICK SAMPLING pad.

If the sample is still playing back, the pad’s light goes off and sample playback stops.

## Looping a Sample

- 1 While holding the [LOOP HOLD] button, press one of the QUICK SAMPLING [A]-[D] pads.

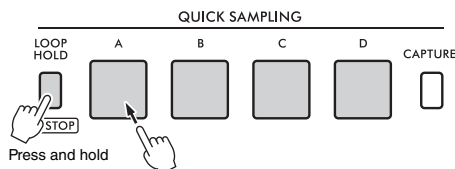

Even if you release the pad, it will remain lit and the sample playback will continue.

When the sample reaches the end, it plays back again from the beginning and repeats indefinitely. This is called “Loop playback,” and helps you build a rhythmic basis for your performance.

- 2 Press the QUICK SAMPLING pad that is lit.

The pad’s light goes off and Loop playback of the sample stops.

### NOTE

- The QUICK SAMPLING [A]-[D] pads operate independently of each other. Each can be used for One-shot playback or Loop playback.
- All four samples can be played back simultaneously.
- To stop the playback of all samples at once, hold down the [SHIFT] button while pressing the [LOOP HOLD] button.
- The volume of the samples for each QUICK SAMPLING pad can be changed in the Function Settings (page 64, Function 049).
- Playing back the pad uses the tone generator channels for polyphony.
- On rare occasions, the sound of the pad might be silent during loop playback, even though the pad was lit, if a large number of notes are played at the same time, such as with Style playback. To enable the pad to sound again in that case, press that pad to turn it off, and then perform step 1 again. If the condition persists, try to reduce the number of notes used at the same time when playing.

## Getting Ready for Sampling

Connect an external device for sampling, and adjust the volume level for recording.

### NOTE

If the volume of the audio input is too low, the instrument cannot sample the sound.

- 1 Set the volume level of this instrument to minimum.
- 2 Connect an external device for sampling.  
For details about how to connect external devices, refer to the following pages.
  - [AUX IN] jack: page 54
  - [MIC INPUT] jack: page 38
  - [USB TO HOST] terminal: page 54
- 3 Make sure the volume of the audio input is set high enough.

- **[AUX IN] jack:**  
Set the volume of the external device to maximum.
- **[MIC INPUT] jack:**  
Set the [GAIN] knob on the rear panel to its highest setting.
- **[USB TO HOST] terminal:**  
On the computer or smart device, set the playback volume for the MIDI file or audio file to maximum.

### NOTE

- When the sound is too low even though the volume of the external device connected to the [AUX IN] jack is set to maximum, adjust the "AuxInVol" in the Function Settings (page 66, Function 068). However, if you increase the volume to more than 50, the sound may be distorted.
- When the audio input is too low even though the playback volume on the computer or smart device is set to maximum, adjust the "USBInVol" in the Function Settings (page 66, Function 069).

- 4 Adjust the volume you hear from the instrument speakers by turning the [MASTER VOLUME] control.

### NOTE

The volume from the speakers has no effect on sampling results.

## Sampling External Audio

Sample the audio input, and save it to one of the QUICK SAMPLING [A]-[D] pads.

### NOTE

- The sampling rate is 44.1 kHz, 16-bit, stereo.
- The samples can also be saved to a USB flash drive (page 45).

- 1 Get ready for sampling.

Prepare for audio input. For details, refer to "Getting Ready for Sampling."

### NOTICE

The sampling operation will overwrite and erase previously existing samples. Save important data you want to keep to a USB flash drive (page 45).

### NOTE

- If you want to use the Melody Suppressor (page 54) when sampling, be sure to set it before entering sampling mode.
- If you want to automatically cut the silent sections at the beginning and end of sampling, set "BlankCut" in the Function Settings (page 64, Function 048) to "ON."

- 2 Press the [CAPTURE] button to enter the Quick Sampling mode.

"PressA-D" appears on the display.

CAPTURE

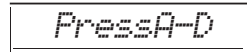

### NOTE

To cancel sampling, exit Quick Sampling mode by pressing the [CAPTURE] button again.

- 3 Press the desired QUICK SAMPLING pad to which the sample is to be assigned.

The pad flashes, and "Start?" appears on the display.

A

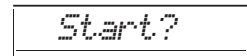

### NOTE

To switch to a different pad, either press a different pad or press the [EXIT] button.

- 4 Pause playback on the external device at the beginning of the sound or phrase you want to sample, or prepare to record the sound with the microphone.

## 5 Press the pad that is flashing to start sampling.

“Sampling” appears on the display.

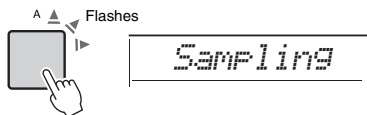

### NOTICE

*Do not disconnect the USB flash drive during the sampling operation. The operation of the instrument may become unstable, and sampling may not be performed properly.*

#### NOTE

You can also press the [ENTER] button to start sampling.

## 6 Start playback on the external device, or input sound to the microphone.

#### NOTE

*If the input volume from the external device or microphone is too low, “LowInput” appears on the display and sampling is canceled. Then, the instrument returns to the status described in Step 3.*

## 7 Stop audio input at the end of the sound or phrase you want to sample.

If you are using an external device, stop playback. If you are using a microphone, stop inputting sound to it.

## 8 Press the lit pad again to stop sampling.

“Writing!” appears briefly on the display, and then the sample is overwritten and stored. The pad’s light goes off, the sampling ends, and the instrument returns to the status described in Step 2.

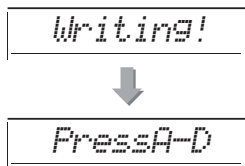

#### NOTE

*Sampling time is limited to a maximum of 9.6 seconds. When the time limit is reached, sampling stops automatically and the recorded sample (up to that point) is stored to the instrument.*

## 9 Press the [CAPTURE] button to exit Quick Sampling mode.

## 10 Press the Quick Sampling pad to play back the sample.

### To sample during audio playback

Once you are familiar with the sampling operation, streamline the operation by starting and stopping sampling while the sound of the external device is playing back.

1. Perform Steps 2 and 3 of “Sampling External Audio” (page 43).
2. Stop playback on the external device a few measures before the sound or phrase you want to sample.
3. Start playback on the external device.
4. Press the pad that is flashing at the point where you want to start sampling.
5. When you want to stop sampling, press the pad again.
6. Stop playback on the external device, and then check what you have just sampled.

#### NOTE

*If there is silence that you want to keep it in the sample, but is cut automatically, set “BlankCut” in the Function Settings (page 64, Function 048) to “OFF”*

## Restoring the Default Samples

This operation lets you restore the default samples for each Quick Sampling pad. However, keep in mind that this deletes the samples you have assigned to the pads.

### NOTICE

*Restoring the default samples overwrites any samples that you have assigned to the pads. Save important samples you want to keep to a USB flash drive (page 56) before restoring the default samples.*

- 1 Press the [CAPTURE] button to enter the Quick Sampling mode.
- 2 While holding the [SHIFT] button, press the Quick Sampling pad that has the sample you want to delete.  
The pad flashes, and “ClrSMPL?” appears on the display.

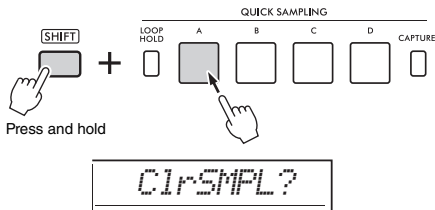

- 3 Press the [ENTER] button.  
The Quick Sampling pad's light comes on, and “Sure?” appears on the display.  
To cancel this operation, press the [EXIT] button.  
If you cancel the operation, the Quick Sampling pad's light goes off and the instrument returns to the status described in Step 2.
- 4 Press the [ENTER] button again.  
“Writing!” appears briefly on the display, the Quick Sampling pad's light goes off, and the default sample is restored.
- 5 Press the [CAPTURE] button to exit Quick Sampling mode.

## Sampling a WAV File from a USB Flash Drive

You can import WAV files that are stored on a USB flash drive into the internal memory as samples, and assign them to Quick Sampling pads. For details, refer to the Reference Manual on the website (page 11).

## Saving a Sample to a USB Flash Drive

Samples that are assigned to Quick Sampling pads [A] to [D] can individually be saved to a USB flash drive as sample files. Sample files that have been saved to a USB flash drive can be imported and re-assigned to the pads. For details, refer to the Reference Manual on the website (page 11).

# Recording Your Performance

On this instrument, there are two different ways you can record your performances: **Song (with MIDI)**, and **Audio**.

## Song Recording

You can record your performances to the internal memory as User Songs. This approach makes editing easy, as you can record to individual tracks, erase tracks after recording, and re-record individual tracks, etc. You can record a maximum of 10 User Songs and up to a total of about 19,000 notes. User Songs can be exported to a USB flash drive as MIDI files, which can be played and edited on other MIDI devices or sequencers (page 59).

## Audio Recording

You can record your performances and save them to a USB flash drive as audio files. You can also record audio from the [MIC INPUT] jack, the [AUX IN] jack, and the [USB TO HOST] terminal. Audio files are in WAV format (44.1 kHz, 16 bit, stereo), and the maximum recording time is 80 minutes. These audio files can be transferred to and played back on computers and smart devices.

## Recording a New User Song

This section explains how to record a new Song to the internal memory without specifying a track.

1 **Make the desired settings including the Main Voice selection.**

2 **Make the desired settings for recording your performance.**

- If you want to record only the melody performance, press the [SONG/AUDIO] button.
- If you want to record a performance with a Style, press the [STYLE] button.
- If you want to record a performance with a Groove, press the [GROOVE CREATOR] button.

3 **Press the [REC] button to enter the Record Ready mode.**

This operation selects the lowest-numbered unrecorded User Song from 031 to 040 (User 1 to 10) as the recording target.

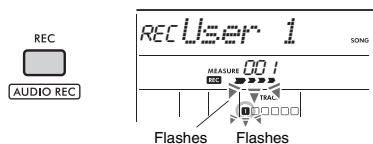

### NOTE

The ACMP on/off status cannot be changed while in Record Ready mode.

To exit from this mode, press the [REC] button again.

4 **Start recording.**

The operation to start recording differs depending on the button you pressed in Step 2.

- [SONG/AUDIO] button: Play any note to start recording.
- [STYLE] button: Play a chord in the Auto Accompaniment area to start recording with Style playback. Press the [START/STOP] button to start playback of the rhythm only, and then play the keyboard to start recording.
- [GROOVE CREATOR] button: Specify a chord in the Auto Accompaniment area or press the [START/STOP] button to start recording with Groove playback.



The current measure will be shown on the display while recording.

5 **Press the [▶/■] (Start/Stop) or [REC] button to stop recording.**



After you finish recording, "Writing!" appears to indicate storing the recorded data. When the data is stored, the recorded track numbers in the display will light.

**NOTICE**

**Never attempt to turn the power off when "Writing!" is shown in the display. Doing so can result in data loss.**

**NOTE**

If you are using a Style or the Groove Creator for a performance, you can also automatically end recording in the following ways.

- **Style:** Press the [INTRO/ENDING/rit.] button, and wait for playback of the Style to end.
- **Groove Creator:** Press the [MUSICAL CLIMAX] button, and wait for playback of the Groove to end.

## 6 To play back the recorded Song, press the [▶/■] (Start/Stop) button.

**NOTE**

When recording Groove playback with the Retrigger function, note that the beat indicator in the display and the metronome and Arpeggio playback are not synchronized with playback of the recorded Song.

### Limitations when recording a Song

- The on/off status of ACMP cannot be changed.
- Playback cannot be changed between Style and Groove.
- The Groove number can be changed, but the Style number cannot.
- When you use Style/Groove, the following parameters cannot be changed: Reverb Type, Chorus Type, Time Signature, and Style/Groove Creator Volume.
- Performances with Quick Sampling pads [A] to [D] cannot be recorded.
- The audio input from an external device (playback sound on the connected computer or audio device) cannot be recorded.

## Track Structure of a Song

A Song contains six tracks.

- **Melody Tracks [1/RIGHT] to [5]**  
For recording melody performances.
- **Accompaniment Track [A]**  
For recording a chord progression (for the Style) or key changes (for the Groove).

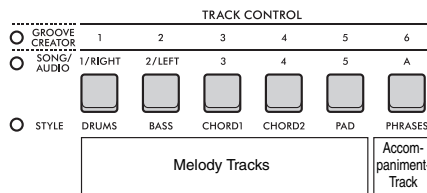

If you make a recording without specifying a track, the melody is recorded to Track [1/RIGHT] and the accompaniment (Style chords/Groove keys) is recorded to Track [A]. At this time, if an existing User Song was selected beforehand, the data on Track [1/RIGHT] and Track [A] for that Song will be overwritten. You can also record each track one by one (e.g., only the right-hand part or the left-hand part) to create a complete piece that may be difficult to play all at once.

## Recording a User Song to a Specified Track

This section explains how to record a User Song to a specified track. This is useful when you want to record additional performances to an already recorded User Song, or re-record only one track of an already recorded User Song.

### 1 Press the [SONG/AUDIO] button. The SONG icon appears.

If the AUDIO icon appears, press the [SONG/AUDIO] button again. If "No USB" is displayed instead of the SONG icon, wait a few seconds for the SONG icon to appear.



### 2 Rotate the dial to select the desired User Song from 031 to 040 (User 1 to 10) as the recording target.

### 3 Specify the track to record and overwrite, and enter Record Ready mode.

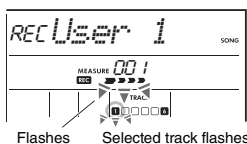

- **If you want to record only the melody:**  
While holding down the [REC] button, press the button for the track you want to record to ([1/RIGHT] to [5]).

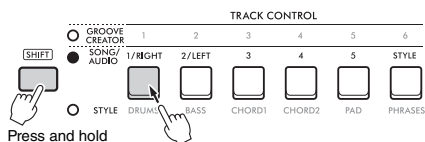

- **If you want to record only the Style:**  
Press the [STYLE] button, and select a Style. While holding down the [REC] button, press the [A] button. ACMP is automatically turned on.

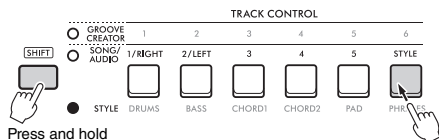

- **If you want to record only the Groove:**  
Press the [GROOVE CREATOR] button, and then select the desired Groove. ACMP is automatically turned on. While holding down the [REC] button, press the [A] button.

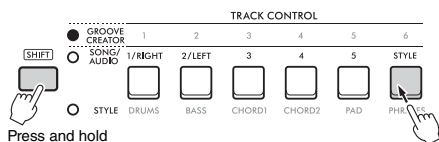

### 4 Same as Steps 4 to 6 in “Recording a New User Song” (page 46).

**NOTE**

If the internal memory becomes full while recording, an alert message will appear and recording will stop automatically. In this case, delete unnecessary data by the Clear functions (below), and then execute the recording again.

## Clearing a User Song (Song Clear)

This lets you clear all tracks of a User Song.

- 1 Press the [SONG/AUDIO] button. The **SONG** icon appears.  
If the **AUDIO** icon appears, press the [SONG/AUDIO] button again. If “No USB” is displayed instead of the **SONG** icon, wait a few seconds for the **SONG** icon to appear.
- 2 Rotate the dial to select the User Song from 031 to 040 (User 1 to 10) to be cleared.
- 3 While holding down the [1/RIGHT] button press the [A] button.

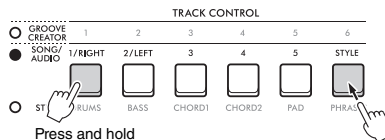

A confirmation message will appear on the display.



- 4 Press the [ENTER] button.  
“Sure?” appears on the display. To cancel this operation, press the [EXIT] button.
- 5 Press the [ENTER] button again to clear the Song.  
“Writing!” appears briefly on the display, and then the Song is cleared.



## Clearing a Specified Track from a User Song (Track Clear)

This lets you clear individual tracks from a User Song.

- 1 Press the [SONG/AUDIO] button. The **SONG** icon appears.  
If the **AUDIO** icon appears, press the [SONG/AUDIO] button again. If “No USB” is displayed instead of the **SONG** icon, wait a few seconds for the **SONG** icon to appear.
- 2 Rotate the dial to select the User Song from 031 to 040 (User 1 to 10) to be cleared.
- 3 While holding down the [SHIFT] button, press the button for the track you want to clear ([1/RIGHT] to [5], [A]).

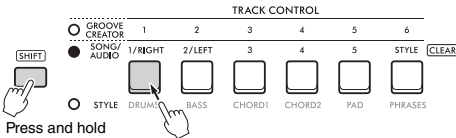

A confirmation message will appear on the display.

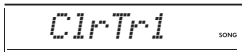

- 4 Press the [ENTER] button.  
“Sure?” appears on the display. To cancel this operation, press the [EXIT] button.
- 5 Press the [ENTER] button again to clear the Song.  
“Writing!” appears briefly on the display, and then the data on the selected Track is cleared.

## Recording/Saving Audio Files to a USB Flash Drive

This lets you record your performances to a USB flash drive as audio files.

### NOTICE

Before using a USB flash drive, be sure to refer to “Precautions when using the [USB TO DEVICE] terminal” (page 56).

### NOTE

When using the audio recording function, be sure to use an AC adaptor. The audio recording function is not available when using batteries.

- 1 Connect a USB flash drive to the [USB TO DEVICE] terminal.
- 2 Make the desired settings for your performance.

Depending on the selected function, the data that can be recorded is limited to the following:

- When **Style** is selected:

Style, keyboard performance, and audio (from [MIC INPUT]/[AUX IN]/[USB TO HOST] jacks)

- When **Song** is selected:

Keyboard performance and audio (from [MIC INPUT]/[AUX IN]/[USB TO HOST] jacks)

- When **Groove Creator** is selected:

Groove, keyboard performance, and audio (from [MIC INPUT]/[AUX IN]/[USB TO HOST] jacks)

### NOTE

Metronome clicks and Songs cannot be recorded.

- 3 While holding the [SHIFT] button, press the [REC] button to enter Record Ready mode for audio recording.

**AUDIO** and “PressREC” appear on the top left of the display.

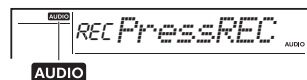
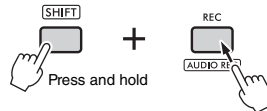

### NOTE

To exit from this status, hold down the [SHIFT] button and press the [REC] button again.

#### 4 Press the [REC] button to start recording.

The elapsed time is shown on the display during recording.

The maximum recording time is 80 minutes or until the memory of the USB flash drive becomes full.

When recording the Style or Groove, press the [▶/■] (Start/Stop) button to start/stop the Style/Groove..

**NOTICE**

*Do not disconnect the USB flash drive or turn off the power to the instrument during recording. Otherwise, damage to the data may occur.*

**NOTE**

*The [▶/■] (Start/Stop) button only starts/stops the Style or Groove. It does not start/stop recording.*

#### 5 Press the [REC] button to stop recording.

“Writing!” appears to indicate storing the recorded performance. After storing, “Complete” appears, and then the recorded audio file name will be shown as “AUDIO\*\*\*\*\*” (\*\*\*\*\*: number).

**NOTICE**

*Never attempt to turn the power off when “Writing!” is shown in the display. Doing so can result in data loss.*

#### 6 Press the [▶/■] (Start/Stop) button to play back the recorded audio file.

### Recording-related Message List

Message	Description
NoUSB	No USB flash drive is connected.
UseAdpt	Power is now being drawn from batteries. Use an AC adaptor.
FileFull	The total number of files in the USB flash drive exceeds the capacity. Delete unnecessary data or use another USB flash drive.
Unformat	The USB flash drive is unformatted. Format the USB flash drive (page 58).
Protect	The USB flash drive is protected.
TimeUp	The recording time exceeds 80 minutes. The recording automatically stops and the audio file will be saved.
DiskFull	The USB flash drive has become full. The recording automatically stops and the audio file will be saved.
USB Err	The USB flash drive may have a problem. <ul style="list-style-type: none"> <li>• Check if the USB flash drive is included on the online Compatible Device List (page 56).</li> <li>• Format the USB flash drive (page 58).</li> </ul>

# Saving Your Favorite Settings (Registration Memory)

The Registration Memory function allows you to save (or “register”) panel settings such as Voices and Styles to a Registration Memory button, and then instantly recall your custom panel settings by simply pressing a single button. The registered settings for four Registration Memory buttons make one Bank, and you can register up to eight Banks.

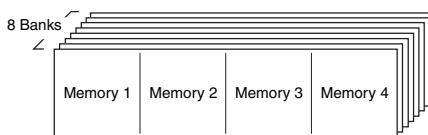

Up to 32 settings (eight banks of four each) can be memorized.

**NOTE**

At the time of purchase, setting examples are registered in Banks 1 to 8.

## Saving Panel Settings to the Registration Memory

1 Make the desired settings, such as those for Voice, Style, and Groove.

**NOTE**

Data cannot be saved to Registration Memory during Song playback.

2 Press the [BANK/MEMORY] button to select a Bank number (1 to 8).



The Registration Memory number, to which settings are saved, lights.

3 While holding down the [BANK/MEMORY] button, press the desired button, [1] to [4].

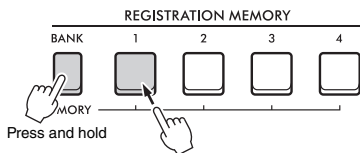

“MemOK” appears on the display, and the Registration Memory number flashes. When the setting is saved, the Registration Memory number lights up.

**NOTICE**

If you select a Registration Memory number that already contains data, the previous data is deleted and overwritten by the new data.

### Parameters that can be saved to Registration Memory

- **Style settings:** Style number, ACMP on/off, Style volume, Track on/off, Main section A/B, Tempo, Fingering type, Smart chord key
- **Groove settings:** Groove number, Groove volume, Section, Track on/off, Tempo
- **Voice settings**
  - **Main Voice settings:** Voice number and all settings of the related Functions (page 62)
  - **Dual Voice settings:** Dual on/off and all settings of the related Functions
  - **Split Voice settings:** Split on/off and all settings of the related Functions
- **Effect settings:** Reverb Type, Chorus Type, Motion Effect Type
- **Harmony/Arpeggio settings:** Harmony/Arpeggio on/off and all settings of the related Functions
- **DSP:** DSP2 on/off, DSP1/2 type, DSP2 effect target part, and parameter values of Knobs A/B
- **Other settings:** Transpose, Pitch Bend Range, Knob Assign, Split Point, Scale Tune, Sampling Pad Volume, Pedal Function

**NOTE**

Samples of the Quick Sampling function (page 42) are not saved in the Registration Memory.

## Recalling Panel Settings from Registration Memory

- 1 Press the [BANK] button to select a Bank number (1 to 8).

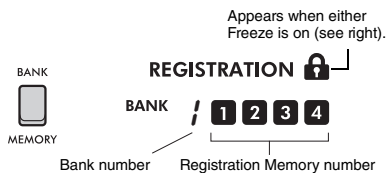

The Registration Memory number, to which settings are saved, lights.

- 2 Press the desired [MEMORY] button, [1] to [4].

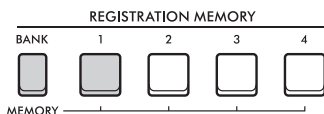

The recalled Registration Memory number appears in the display for a few seconds, indicating that the desired panel settings have been recalled.



### NOTE

When the [SONG] lamp is lit, the Style or Groove Creator settings will not be recalled even if you press the [REGISTRATION MEMORY] button to which the Style or Groove Creator settings are saved. If this happens, after pressing the [STYLE] or [GROOVE CREATOR] button, press the Registration Memory button to recall the Style and Groove Creator settings.

## Specifying Panel Settings to be Maintained Across Registration Memory Changes (Freeze)

Various settings can be saved in Registration Memory and recalled with a single operation. However, in some cases you might want to use the Registration Memory without changing specific settings, depending on the performance situation. For example, you might want to switch between Voice settings and Effect settings without changing the Style. In such cases, if "Style Freeze" is turned on, Style related settings are maintained (frozen) without changing, even if you press a [REGISTRATION MEMORY] button.

Make each of the freeze settings in the Function Settings (page 66).

- **Style Freeze (StyleFrz): Function 073**
- **Transpose Freeze (TransFrz): Function 074**
- **Voice Freeze (VoiceFrz): Function 075**

# Connecting to External Devices

## CAUTION

Before connecting the instrument to external devices, turn off the power of all the devices. Also, before turning the power on or off, make sure to set all volume levels to minimum. Otherwise, damage to the devices or electrical shock might occur.

## Connecting Headphones

Connect headphones to the [PHONES] jack. The instrument's speakers are automatically shut off when a plug is inserted into this jack.

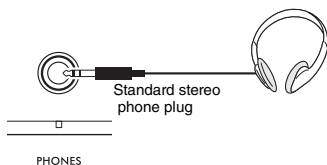

## CAUTION

Do not use headphones for a long period of time at a high or uncomfortable volume level. Doing so can cause permanent hearing loss.

## NOTE

If you set Function 079 "Speaker" in the Function Settings (page 66) to something other than "1 (HPSwitch)," you can turn the speaker on or off regardless of whether or not headphones are connected.

## Using a Pedal (Footswitch)

By connecting a footswitch (FC5 or FC4A, sold separately) to the [SUSTAIN] jack, you can control three functions: Sustain, Articulation (page 27), and Arpeggio (page 26).

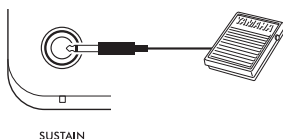

By default, the Sustain function is assigned to the footswitch. Similar to the damper pedal on a piano, while you press the footswitch you can still hear a note sustain even after you release the keyboard. Make settings for functions other than Sustain in the Function Settings (page 64, Function 054).

## NOTE

- Plug or unplug the footswitch while the power is off. Also, do not press the footswitch when turning the power on. Doing so changes the polarity of the footswitch, resulting in reversed operation.
- Sustain is not applied to Split Voices (page 25).
- Some Voices will not decay until you release the footswitch.

## Playing Sound from External Speakers

If you use the [OUTPUT] jacks to connect to powered speakers, you can produce a louder, more powerful sound for more dynamic performances.

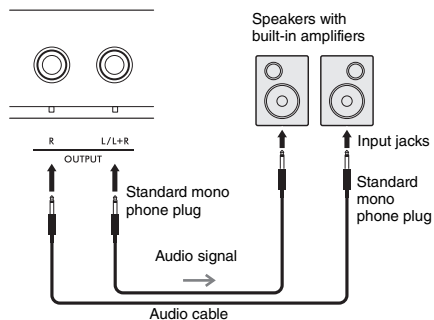

You can use the instrument's [MASTER VOLUME] control to adjust the volume that is output to external devices.

## NOTICE

- To avoid damaging external devices, first turn on the power to the instrument, and then to the external device. When turning off the power, first turn off the power to the external device, and then to the instrument.
- The Auto Power Off function (page 18) might automatically turn off the instrument at undesirable times. If the instrument will not be operated for a certain period of time, either turn off the power to external devices or disable the Auto Power Off function.
- Do not connect the output from the [OUTPUT] jacks directly to the [AUX IN] jack. In addition, when using the [OUTPUT] jacks to connect to an external device, do not connect the output jacks of the external device to the [AUX IN] jack. Doing so will cause the audio that is input to the [AUX IN] jack to be output from the [OUTPUT] jacks, resulting in feedback that could damage both devices.

## NOTE

- Use audio cables and adaptor plugs with zero resistance.
- When connecting to a monaural device, use the [L/L+R] jack.

## Turning Off the Keyboard's Speakers

Set Function 079 "Speaker" in the Function Settings (page 66) to "3 (SP Off)."

## Playing an External Audio Device with the Built-in Speakers

By connecting an audio device such as a smartphone to the instrument's [AUX IN] jack, you can output the sound of the audio device through the instrument's speakers. This lets you play the keyboard along with the playback of your audio device, for practice or performance.

### NOTICE

To avoid damaging devices, first turn on the power to the external device, and then to the instrument. When turning off the power, first turn off the power to the instrument, then to the external device.

### 1 Connect the headphone jack of an audio device to the instrument's [AUX IN] jack by using an audio cable.

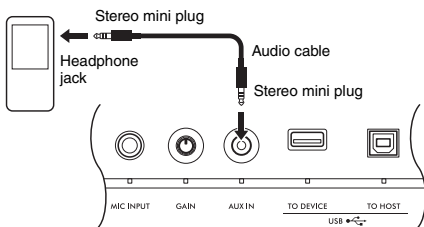

### NOTE

If you are using a computer or a smart device such as a smartphone or tablet, you can also connect it to the [USB TO HOST] terminal to play audio on that device from the instrument (page 55).

### 2 Turn on the audio device, and then the instrument.

### 3 Start playback of the connected audio device.

The sound of the audio device is output through the instrument's speakers.

### 4 Adjust the volume balance between the audio device and the instrument.

Adjust the audio playback volume on the audio device, then adjust the entire volume by rotating the [MASTER VOLUME] control on the instrument.

### NOTE

- To adjust the balance between the volume of the external audio input and the volume of the Song/Style/Groove, press the [KNOB ASSIGN] button, select Function 6, and then turn Knob A (page 30).
- The audio input volume from the [AUX IN] jack can be adjusted in the Function Settings (page 66, Function 068). If you increase the volume to more than 50, the audio device sound might be distorted.

### 5 Play the keyboard along with the sound of the audio device.

### NOTE

You can cancel or lower the volume of the melody part of audio playback. Refer to the procedure in "Using the Melody Suppressor".

### 6 After finishing your performance, stop playback of the audio device.

## Using the Melody Suppressor

When you output audio from an external audio device or a computer connected to the [AUX IN] jack or the [USB TO DEVICE] or [USB TO HOST] terminal through the instrument, this function lets you lower the volume of the melody part of audio playback. You can use the function to practice the melody part along with the audio playback.

Make these settings in the Function Settings (page 66).

- Function 071 "Melody Suppressor":**  
Turns the Melody Suppressor function on and off.
- Function 072 "Melody Suppressor Pan":**  
Adjusts the position for suppressing a melody.

### NOTE

When an audio device is connected to the [USB TO HOST] terminal, and "Audio Loop Back" (page 66, Function 070) is set to OFF, the Melody Suppressor function cannot be used.

## Using with a Computer or Smart Device

By connecting a computer or smart device such as a smartphone or tablet to the [USB TO HOST] terminal, you can do the following.

- Transfer files, such as Songs and Styles
- Send and receive MIDI data
- Send and receive audio data (USB Audio Interface function)
- Use smart device apps

For information on how to connect to a computer and how to transfer data, refer to the Computer-related Operations on the website (page 11).

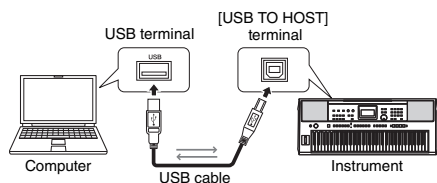

For details about how to connect to a smart device, refer to the Smart Device Connection Manual on the website (page 11).

#### NOTICE

- Use an **AB type USB cable of less than 3 meters**.
- **USB 3.0 cables cannot be used.**

## Transferring Files (including Songs and Styles)

You can transfer a MIDI file to the instrument and play it as a downloaded song, or transfer a Style file to the instrument and use it as a built-in Style. You can also transfer and store backup files to a different device.

#### When transferring files to and from a computer:

Turn on "Storage Mode" (page 66, Function 076) in Function Settings to use the instrument as an external storage device.

#### When transferring files to and from a smart device:

Use the "MusicSoft Manager" app. Refer to the following website for details.

<https://www.yamaha.com/kbdapps/>

#### NOTE

- Only turn on Storage Mode when transferring files to and from a computer. While Storage Mode is on, you cannot play or operate the instrument, or send/receive MIDI data and audio data.
- The maximum file size that can be transferred to the instrument is approximately 1.72 MB in total.
- The files transferred to the instrument are sorted according to the following file name order: symbol → number → alphabet.

#### Files that can be transferred

- **MIDI files (Extension: .MID)**  
MIDI files that have been created with other instruments or computers can be transferred to this instrument as Songs.
- **Style files (Extension: .STY)**  
Style files that have been created with other devices can be transferred to this instrument.
- **Backup files (Extension: .BUP)**  
Data in the instrument can be saved as a single backup file. For details about what information is saved, refer to "Backup Data" (page 68).

#### NOTE

- With this instrument, User Songs cannot be transferred to external devices via the [USB TO HOST] terminal. To export User Songs, save them to a USB Flash Drive (page 59).
- The maximum size of a single Style file is 50 KB. Files that exceed this limit will not be recognized by the instrument.

## Sending and Receiving MIDI Data

You can listen to MIDI files played on a computer or smart device through the instrument's speakers, or send a performance on the instrument as MIDI data to a computer or smart device.

## Sending and Receiving Audio Data (USB Audio Interface Function)

You can listen to audio files played on a computer or smart device through the instrument's speakers, or send a performance on the instrument as audio data to a computer or smart device.

A driver must be installed to send/receive audio data to/from a computer running on Windows. For details, refer to the Computer-related Operations document on the website (page 11).

#### NOTICE

*If you are using a DAW (digital audio workstation) with this instrument, set "Audio Loop Back" (page 66, Function 070) to OFF.*

*If the function is instead set to ON, a mixture of audio data and instrument audio will be sent to the DAW, which might cause feedback and noise.*

#### NOTE

- The volume can be adjusted on the computer or smart device, and also by using the instrument's [MASTER VOLUME] control. In addition, you can adjust the volume of the audio input from the [USB TO HOST] terminal in the Function Settings (page 66, Function 069).
- When outputting audio playback from the instrument to a computer, such as when layering audio input from the [USB TO HOST] terminal over performance audio from the instrument and recording it to a computer, the [MASTER VOLUME] control cannot be used to adjust the volume.

## Using Smart Device Apps

Using smart device apps with the instrument expands the range of possibilities, such as recording and immediately sharing a performance.

Please refer to the following website for information about compatible smart devices and apps.

<https://www.yamaha.com/kbdapps/>

# Connecting a USB Flash Drive

By connecting a USB flash drive (sold separately) to the [USB TO DEVICE] terminal, you can save data created on the instrument, such as User Songs and parameter settings. The saved data can be recalled to the instrument for future use.

## NOTICE

You should use an AC adaptor when executing USB flash drive operations. Battery power might not be reliable enough to last through these crucial operations. When you try executing certain functions, the "UseAdpt" indication might appear and the selected function cannot be executed unless an AC adaptor is used..

## Precautions when using the [USB TO DEVICE] terminal

This instrument features a built-in [USB TO DEVICE] terminal. When connecting a USB device to the [USB TO DEVICE] terminal, be sure to observe the following.

### NOTE

For more information about the handling of USB devices, refer to the owner's manual of the USB device.

### Compatible USB devices

#### • USB Flash Drive

Other USB devices such as a USB hub, computer keyboard or mouse cannot be used.

Compatible USB devices are listed under "Materials/Data" on the following website. Be sure to check this website before purchasing devices.

Support/inquiries:

<https://download.yamaha.com/>

Although USB devices 1.1 to 3.0 can be used on this instrument, the amount of time for saving to or loading from the USB device might differ depending on the type of data or the status of the instrument.

## NOTICE

The rating of the [USB TO DEVICE] terminal is a maximum of 5 V/500 mA. Do not connect USB devices that have a rating above this, since this can cause damage to the instrument itself.

### Connecting a USB device

Insert a plug that matches the shape of the [USB TO DEVICE] terminal, and pay attention to its vertical orientation.

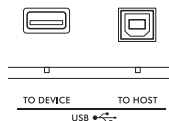

## NOTICE

- Avoid connecting or disconnecting the USB device while executing playback/recording and file management operations (such as Save, Copy, Delete, and Format), or when accessing the USB device. Failure to observe this might result in "freezing" of the operation of the instrument or corruption of the USB device and the data.
- When connecting then disconnecting the USB device (and vice versa), make sure to wait a few seconds between the two operations.
- Do not use extension cables to connect USB devices; connect the device directly.

## Using a USB Flash Drive

By connecting the instrument to a USB flash drive, you can save data you've created to the connected device, as well as read data from the connected device.

### Number of USB flash drives that can be used

Only one USB flash drive can be connected to the [USB TO DEVICE] terminal.

### Formatting a USB flash drive

You should format the USB flash drive only with this instrument (page 58). A USB flash drive formatted on another device might not operate properly.

## NOTICE

The format operation overwrites any previously existing data. Make sure that the USB flash drive you are formatting does not contain important data.

### To protect your data (write-protect)

Some USB flash drives have a write-protect function to prevent accidental erasure of data. To prevent important data from being inadvertently erased, apply the write-protect provided with each USB flash drive. If you are saving data to the USB flash drive, make sure to disable write-protect.

### Turning off the instrument

When turning off the instrument, make sure that the instrument is NOT accessing the USB flash drive by playback/recording or file management (such as during Save, Copy, Delete, and Format operations). Failure to do so might corrupt the USB flash drive and the data.



## Using USB Flash Drives

### NOTICE

Before using a USB flash drive, be sure to read “Precautions when using the [USB TO DEVICE] terminal” on page 56.

### NOTE

Messages might appear on the display during File Control procedures to aid in operation. Refer to the Message List on page 60 for details.

- 1 Connect a USB flash drive to the [USB TO DEVICE] terminal, and wait until “USB” appears on the left corner of the display. The “USB” indication confirms that the connected USB flash drive has been mounted or recognized.

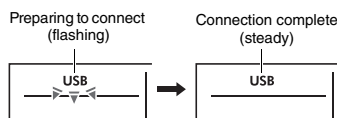

- 2 While holding down the [SHIFT] button, press the [FUNCTION] button to call up the File Control display.

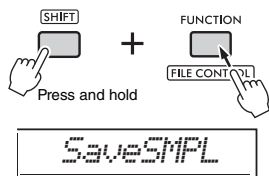

- If “UnFormat” followed by “Format?” appears:

This indicates that the connected USB flash drive requires formatting. Execute the Format operation by following the instructions starting with step 2 on page 58.

### NOTE

- The File Control display cannot be called up in the following situations.
  - During playback and recording of Styles, Grooves, or Songs
  - During Quick Sampling mode or Audio mode
  - When “USB” does not appear even if you have connected a USB flash drive to the [USB TO DEVICE] terminal.
- No sound will be produced if the keyboard is played while the File Control display is showing. Only buttons related to File Control operations will be active.

- 3 Rotate the dial to select an operation, and then press the [ENTER] button.

For details, refer to the table on the right.

## File Control Display List

Display	File Control function	Reference	
SaveSMPL	Saving a Sample to a USB Flash Drive	Reference Manual (Page 11)	
LoadSMPL	Loading a Sample from a USB Flash Drive		
Del SMPL	Deleting a Sample in a USB Flash Drive		
DelAUDIO	Deleting an Audio Song in a USB Flash Drive		
SaveSMF	Saving an SMF File in a USB Flash Drive		
Del SMF	Deleting an SMF File in a USB Flash Drive		
SaveUSER	Saving User Data (User File) to a USB Flash Drive		
LoadUSER	Loading User Data (User File) from a USB Flash Drive		
Del USER	Deleting User Data (User File) in a USB Flash Drive		
LoadSTY	Loading a Style File		
Imp.WAV	Loading a WAV File from a USB Flash Drive		
Format?	Formatting a USB Flash Drive		Page 58
Exit?	Exiting the File Control Display		Page 58

### Valid file locations in the USB flash drive

If you manage the files in the USB flash drive by using a computer, etc., make sure to store the files either in the USB flash drive's root directory or a first-level/second-level folder in the root directory. Files stored in third-level folders cannot be selected and played by the instrument.

#### USB Flash Drive

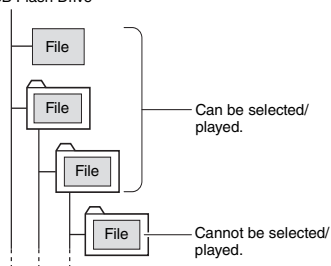

### NOTE

If there is a large amount of data in the USB flash drive, it might take some time to read the files.

### File name displays

File names containing Japanese half-width katakana characters will only be properly displayed if the instrument's display language is set to “Japanese” (page 67, Function 082). All display information other than file names will be displayed in English even if “Japanese” is selected.

## Exiting the File Control Display

- 1 Rotate the dial until “Exit?” appears.

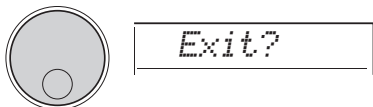

- 2 Press the [ENTER] button to exit the File Control display.



**NOTE**

You can also press one of the following buttons to exit the File Control display.

- [EXIT] button
- [FUNCTION] button
- [VOICE] button
- [SONG/AUDIO] button
- [STYLE] button
- [GROOVE CREATOR] button
- [PORTABLE GRAND] button

## Formatting a USB Flash Drive

The Format operation lets you prepare commercially available USB flash drives for use with the instrument.

**NOTICE**

*The format operation overwrites any previously existing data. Make sure that the USB flash drive you are formatting does not contain important data.*

- 1 Perform steps 1 to 3 of “Using a USB Flash Drive” (page 57) to display “Format?”

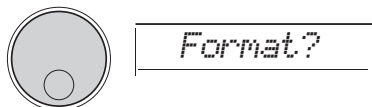

- 2 Press the [ENTER] button. The confirmation message “Sure?” will appear.



To cancel the operation, press the [EXIT] button.

- 3 Press the [ENTER] button to format the USB flash drive.

After a while, the “Complete” message indicating completion of the operation appears, and a folder named “USER FILES” will be created in the USB flash drive. The instrument returns to the display described in Step 1.

**NOTICE**

*The Format operation cannot be cancelled during execution. Never turn off the power or disconnect the USB flash drive during the operation. Doing so might result in data loss.*

- 4 Exit the File Control display. For details about this operation, refer to “Exiting the File Control Display” in the left column of this page.

## Saving Data to a USB Flash Drive

The following types of data on this instrument can be saved to a USB flash drive. For details about how to save each type of data, refer to the Reference Manual on the website (page 11).

### User Data

The following three types of data on this instrument are called "User data." User data is saved as a single "User File" (.usr).

- **All 10 User Songs (page 34)**
- **Style data transferred from a computer and read into Styles 291 to 300**
- **All Registration Memory settings (page 51)**

### User Songs

User Songs are converted to MIDI files (SMF, format 0) and are saved one song at a time.

#### SMF (Standard MIDI File) format

This is a format for recording the content played on the keyboard as MIDI data. Format 0 and format 1 are available. A large number of MIDI devices are compatible with SMF Format 0, and most commercially available MIDI files are provided in SMF Format 0.

### Samples

Samples that are assigned to Quick Sampling pads are individually saved as sample files for each pad.

## Loading User Data from a USB Flash Drive

The following types of data saved to a USB flash drive can be loaded in this instrument. For details about how to load each type of data, refer to the Reference Manual on the website (page 11).

### User Data

All of the User data in a User File (.usr) is imported. All 10 User Songs, Style data in Styles 291 to 300, and all Registration Memory data in the instrument will be replaced with the data imported from the USB flash drive.

### Style Data

Style files (.sty) created externally can be imported into Styles 291 to 300 and used in the same way as built-in Styles.

### Sample Data

Sample files are imported and re-assigned to the Quick Sampling pads. Audio files (WAV files) can also be saved as new samples.

#### NOTE

*MIDI files cannot be imported as User Songs. MIDI files can be played as files on a USB flash drive, or transferred to the instrument's internal memory and played as a downloaded Song (pages 34, 57).*

## Deleting Data in a USB Flash Drive

You can delete the following files in a USB flash drive. For details about how to delete these files, refer to the Reference Manual on the website (page 11).

- **User files**
- **MIDI files**
- **Audio files (WAV files)**
- **Sample files**

## File-related Message List

Message	Meaning
Can'tUse	Files cannot be used at this time, because the USB flash drive is reading or writing.
Complete	An operation, such as saving or transferring data, is complete.
DataErr	The data is not in the correct format.
DiskFull	Data cannot be saved because the flash drive has become full. Delete any unnecessary data or use another USB flash drive.
Error	There is an error in the file, or an error occurred during the operation.
FileFull	The file(s) cannot be saved, because the number of files exceeds the capacity. Delete any unnecessary data or use another USB flash drive.
NoData	There is no data in the memory.
NoFile	There are no files in the memory.
Ovr (Flashes)	Communication with the USB flash drive has been shut down because of overcurrent to the USB flash drive. Disconnect the USB flash drive from the <b>[USB TO DEVICE]</b> terminal and then restart the instrument.
Protect	Writing is not possible because the USB flash drive is write-protected. Turn off the write-protect switch or use another USB flash drive that is not write-protected.
UnFormat	An unformatted USB flash drive is connected.
UseAdpt	If a battery is used to power the instrument, writing to a USB flash drive is not possible. Use an AC adaptor.

# The Functions

The “Functions” provide access to a range of detailed instrument parameters such as Tuning, Split Point, Voices, and Effects. Find the desired item in the Function List (page 62-67), and then follow the instructions below.

## Basic Procedure in the Function Display

- 1 Press the [FUNCTION] button to call up the Function Settings.



- 2 Rotate the dial until the desired item and Function appear in the display, or use the [+] and [-] buttons.

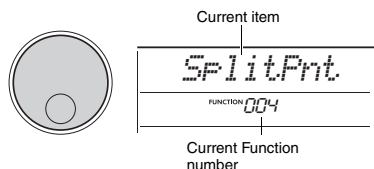

- 3 When the desired Function appears on the display, press the [ENTER] button. The current value for that Function appears.

### NOTE

The following functions are executed as soon as this operation is performed.

- Song Melody Voice (Function 036)
- Initial Send (Function 067)

- 4 Use the dial or the [+] and [-] buttons to set the value of the selected function.

To restore the default value, press the [+] and [-] buttons simultaneously.

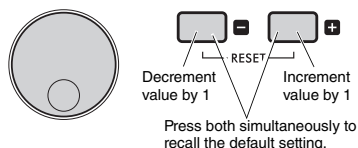
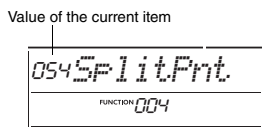

Press both simultaneously to recall the default setting.

### NOTE

Changing the value will directly change the setting.

- 5 Press the [ENTER] button to exit the Value Settings display.

The instrument returns to the display described in Step 2.

Some Function settings are maintained even if you turn off the power, and can be transferred to a computer as Backup data. For details, refer to page 68.

- 6 Press the [FUNCTION] button to exit the Function Settings display.

### NOTE

You can also press one of the following buttons to exit the Function Settings display.

- [VOICE] button
- [STYLE] button
- [SONG] button
- [GROOVE CREATOR] button

● Function List

Function Number	Function	Display	Range/Settings	Default Value	Description	Backup
<b>Overall</b>						
001	Transpose	<i>TransPos</i>	-12 to 12	0	Sets the pitch in semitones.	
002	Tuning	<i>Tuning</i>	427.0 Hz to 453.0 Hz	440.0 Hz	Determines the pitch of the entire instrument in increments of approximately 0.2 Hz.	✓
003	Pitch Bend Range	<i>PB Range</i>	01 to 12	2	Determines the range of change for pitch bending.	
004	Split Point	<i>SplitPnt</i>	036 to 096 (C1 to C6; PSR-E473)/ 028 to 103 (E0 to G6; PSR-EW425)	054 (F#2)	Determines the point for dividing the keyboard into left and right areas. The specified key and the keys to the left of it become the left-hand area (Auto Accompaniment area).	✓
005	Touch Response	<i>TouchRes</i>	1 (Soft) 2 (Medium) 3 (Hard) 4 (Fixed)	2 (Medium)	Determines the sensitivity when playing the keyboard (the rate at which the volume changes depending on the strength with which you play the keyboard). <ul style="list-style-type: none"> <li>• 1 (Soft): Allows maximum loudness to be produced with relatively light key pressure.</li> <li>• 2 (Medium): Produces a fairly "standard" keyboard response.</li> <li>• 3 (Hard): Requires strong playing to produce high volume.</li> <li>• 4 (Fixed): All notes are produced at the same volume no matter how hard the keyboard is played.</li> </ul>	✓
<b>Main Voice</b>						
006	Volume	<i>M. Volume</i>	000 to 127	*	Determines the volume of the Main Voice.	
007	Octave	<i>M. Octave</i>	-2 to +2	*	Determines the octave range for the Main Voice.	
008	Pan	<i>M. Pan</i>	L63 to L01, C, R01 to R63	*	Determines the panning (position where audio is heard) of the Main Voice.	
009	Reverb Depth	<i>M. Reverb</i>	000 to 127	*	Determines the amount of Reverb applied to the Main Voice.	
010	Chorus Depth	<i>M. Chorus</i>	000 to 127	*	Determines the amount of Chorus applied to the Main Voice.	
011	Attack Time	<i>M. Attack</i>	000 to 127	064	Determines how fast the volume of the Main Voice reaches the Attack level. The larger the value, the slower the attack rate. The smaller the value, the faster the attack rate.	
012	Release Time	<i>M. Releas</i>	000 to 127	064	Determines how fast the volume of the Main Voice falls to 0 when the note is released. The larger the value, the longer the sustain. The smaller the value, the shorter the sustain.	
013	Filter Cutoff	<i>M. Cutoff</i>	000 to 127	064	Determines the cutoff frequency. The higher the value, the brighter the sound.	
014	Filter Resonance	<i>M. Reso.</i>	000 to 127	064	Determines the amount of Resonance applied at the cutoff frequency. Increasing the Resonance to emphasize the frequencies at the cutoff frequency results in an exaggerated peak.	
<b>Dual Voice</b>						
015	Voice	<i>D. Voice</i>	001 to 820	*	Selects a Dual Voice.	
016	Volume	<i>D. Volume</i>	000 to 127	*	Determines the volume of the Dual Voice.	
017	Octave	<i>D. Octave</i>	-2 to +2	*	Determines the octave range for the Dual Voice.	
018	Pan	<i>D. Pan</i>	L63 to L01, C, R01 to R63	*	Determines the panning (stereo position where audio is heard) of the Dual Voice.	
019	Reverb Depth	<i>D. Reverb</i>	000 to 127	*	Determines the amount of Reverb applied to the Dual Voice.	
020	Chorus Depth	<i>D. Chorus</i>	000 to 127	*	Determines the amount of Chorus applied to the Dual Voice.	
021	Attack Time	<i>D. Attack</i>	000 to 127	064	Determines how fast the volume of the Dual Voice reaches the Attack level. The larger the value, the slower the attack rate. The smaller the value, the faster the attack rate.	
022	Release Time	<i>D. Releas</i>	000 to 127	064	Determines how fast the volume of the Dual Voice falls to 0 when the note is released. The larger the value, the longer the sustain. The smaller the value, the shorter the sustain.	
023	Filter Cutoff	<i>D. Cutoff</i>	000 to 127	064	Determines the cutoff frequency. The higher the value, the brighter the sound.	
024	Filter Resonance	<i>D. Reso.</i>	000 to 127	064	Determines the amount of Resonance applied at the cutoff frequency. Increasing the Resonance to emphasize the frequencies at the cutoff frequency, results in an exaggerated peak.	

Function Number	Function	Display	Range/Settings	Default Value	Description	Backup
<b>Split Voice</b>						
025	Voice	<i>S.Voice</i>	001 to 820	089 (FingerBass)	Selects a Split Voice.	
026	Volume	<i>S.Volume</i>	000 to 127	*	Determines the volume of the Split Voice.	
027	Octave	<i>S.Octave</i>	-2 to +2	*	Determines the octave range for the Split Voice.	
028	Pan	<i>S.Pan</i>	L63 to L01, C, R01 to R63	*	Determines the panning (stereo position where audio is heard) of the Split Voice.	
029	Reverb Depth	<i>S.Reverb</i>	000 to 127	*	Determines the amount of Reverb applied to the Split Voice.	
030	Chorus Depth	<i>S.Chorus</i>	000 to 127	*	Determines the amount of Chorus applied to the Split Voice.	
<b>Style</b>						
031	Volume	<i>StyleVol</i>	000 to 127	100	Determines the volume of the Style.	✓
032	Fingering Type	<i>FingType</i>	1 (Multi) 2 (Smart Chord)	1 (Multi)	When playing back a Style, this determines the method for playing chords (Fingering Type) in the Auto Accompaniment area. <ul style="list-style-type: none"> <li>1 (Multi): Play the notes of a chord to play back Auto Accompaniment. However, for major, minor, seventh, and minor seventh chords, you can play them by pressing only 1 to 3 keys on the keyboard.</li> <li>2 (Smart Chord): Play only the root note of a chord to play back Auto Accompaniment.</li> </ul>	✓
033	Smart Chord Key	<i>S.ChdKey</i>	FL7 to FL1, SP0, SP1 to SP7	SP0	If Smart Chord is selected as the Fingering Type, this determines the key of the song based on the number of sharps (#) and flats (b) shown on the score. If the key is set correctly, simply play the root note of a chord and the chord that matches the song will be played automatically. <ul style="list-style-type: none"> <li>FL7 to FL1: When a song has 1 to 7 flats (b)</li> <li>SP0: When a song has no sharps or flats</li> <li>SP1 to SP7: When a song has 1 to 7 sharps (#)</li> </ul>	
<b>Groove</b>						
034	Volume	<i>GrooveVol</i>	000 to 127	100	Determines the volume of the Groove.	✓
<b>Song</b>						
035	Volume	<i>SongVol</i>	000 to 127	100	Determines the volume of the Song.	✓
036	Song Melody Voice	<i>MelodyVc</i>	-	-	Changes the Melody Voice of the Song to be the same as the currently selected Main Voice. If the [ENTER] button is pressed while the Function name is displayed, it will be executed immediately. Changes to Melody Voice are temporary and are not saved to the Song. If the Song is loaded again, the original settings will be restored.	
<b>Effects</b>						
037	Reverb Type	<i>Reverb</i>	Refer to the data list	**	Determines the type of Reverb.	
038	Reverb Total Level	<i>RevLevel</i>	000 to 127	64	Determines the volume of the Reverb effect.	
039	Chorus Type	<i>Chorus</i>	Refer to the data list	**	Determines the type of Chorus.	
040	Master EQ Type	<i>MasterEQ</i>	1 (Standard) 2 (Piano) 3 (Bright) 4 (Mild)	1 (Standard)	Adjusts the loudness of specific frequencies for the total sound. If Mega Boost is on, "-- (M Boost 1/2)" is displayed. <ul style="list-style-type: none"> <li>1 (Standard): Standard setting</li> <li>2 (Piano): Optimum for solo piano performance</li> <li>3 (Bright): Lowers the mid range for a brighter sound</li> <li>4 (Mild): Lowers the high range for a softer sound</li> </ul>	
<b>DSP</b>						
041	DSP1 Type	<i>DSP1Type</i>	Refer to the data list	*	Determines the type of DSP1 effect, or turns DSP1 off.	
042	DSP2 Type	<i>DSP2Type</i>	Refer to the data list	01	Determines the type of DSP2 effect.	
043	DSP2 Part	<i>DSP2Part</i>	1 (All) 2 (Keyboard) 3 (Backing) 4 (Mic) 5 (Sampling)	1 (All)	Determines which parts DSP2 effects are applied to. For details, refer to page 28.	

## The Functions

Function Number	Function	Display	Range/Settings	Default Value	Description	Backup
<b>Microphone</b>						
044	Volume	<i>MicVol</i>	000 to 127	Depends on the mic type	Determines the volume of the microphone input.	✓
045	Pan	<i>MicPan</i>	L63 to L01, C, R01 to R63	Depends on the mic type	Determines the panning (stereo position where audio is heard) of the microphone input. However, if the microphone is off or the Mic type is set to "TALK," "---" is displayed and this option cannot be set.	✓
046	Reverb Depth	<i>MicRev</i>	000 to 127	Depends on the mic type	Determines the amount of Reverb applied to the microphone input. However, if the Microphone is off or the Mic type is set to "TALK," "---" is displayed and this value cannot be set.	✓
047	Chorus Depth	<i>MicChor</i>	000 to 127	Depends on the mic type	Determines the amount of Chorus applied to the Microphone input. However, if the Microphone is off or the Mic type is set to "TALK," "---" is displayed and this value cannot be set.	✓
<b>Sampling</b>						
048	Blank Cut	<i>BlankCut</i>	ON/OFF	ON	When set to "ON," determines whether silent areas are cut automatically at the beginning and end of Samples.	✓
049	Sampling Pad Volume	<i>SmplVol</i>	000 to 127	100	Determines the volume of Samples that are saved to the Quick Sampling pads.	
<b>Harmony/Arpeggio</b>						
050	Harmony Type/ Arpeggio Type	<i>Harm/Arp</i>	Refer to the data list	*	Determines the Harmony type or Arpeggio type.	
051	Harmony Volume	<i>HarmVol</i>	000 to 127	*	Determines the volume of the Harmony effect.	
052	Arpeggio Velocity	<i>ArpVelo</i>	1 (Original) 2 (Key)	Depends on the Arpeggio type	Confirms/changes how to determine the velocity of the audio generated by the Arpeggio function. • 1 (Original): Uses the default value for each type. • 2 (Key): Uses the velocity of the pressed key. These settings are temporary and are not saved for each type. When a type is selected again, the default value is restored.	
053	Arpeggio Quantize	<i>Quantize</i>	1 (OFF) 2 (1/8) 3 (1/16)	Depends on the Arpeggio type	Confirms/changes the Arpeggio Quantize settings. Arpeggio Quantize is a function that corrects the timing of the Arpeggio audio so that it matches the playback of the Song/Style/Groove. • 1 (OFF): No correction is made. • 2 (1/8): Corrects the timing to sync with 8th notes. • 3 (1/16): Corrects the timing to sync with 16th notes.	
<b>Pedal</b>						
054	Pedal Function	<i>Pd1Func</i>	1 (Sustain) 2 (Arpeggio Hold) 3 (Sus+ArpeggioH) 4 (Art.)	1 (Sustain)	Determines the Function assigned to the footswitch connected to the [SUSTAIN] jack. • 1 (Sustain): While you press the footswitch you can still hear a note sustain even after you release the keyboard. • 2 (Arpeggio Hold): During Arpeggio playback, while you press the footswitch the Arpeggio continues to sound even if you release the keyboard. • 3 (Sus+ArpeggioH): Both Functions described in 1 and 2 above are applied at the same time. • 4 (Art.): While you press the footswitch, an Articulation effect is applied.	



Function Number	Function	Display	Range/Settings	Default Value	Description	Backup
<b>Scale Tuning</b>						
055	Scale	<i>Scale</i>	1 (Equal) 2 (Pure Maj) 3 (Pure min) 4 (Bayat) 5 (Rast)	1 (Equal)	Determines the temperament to use. If the temperament is changed, the pitch of each key will change. <ul style="list-style-type: none"> <li>• 1 (Equal): Equal temperament</li> <li>• 2 (Pure Maj): Pure Major</li> <li>• 3 (Pure min): Pure Minor</li> <li>• 4 (Bayat): Bayat (Arabic)</li> <li>• 5 (Rast): Rast (Arabic)</li> </ul> If a unique temperament is set using Functions 057 and 058, "(Edited)" appears in the Scale display. If the value is changed and 1 to 5 is selected, the unique temperament setting will be lost.	
056	Base Note	<i>BaseNote</i>	01 (C), 02 (C $\sharp$ ), 03 (D), 04 (E $\flat$ ), 05 (E), 06 (F), 07 (F $\sharp$ ), 08 (G), 09 (A $\flat$ ), 10 (A), 11 (B $\flat$ ), 12 (B)	01 (C)	Determines the tonic note of the scale. Make sure to specify the appropriate base note, if you select a scale other than Equal Temperament, or create an original scale via Scale Tune function.	
057	Tuning Note	<i>TuneNote</i>	01 (C), 02 (C $\sharp$ ), 03 (D), 04 (E $\flat$ ), 05 (E), 06 (F), 07 (F $\sharp$ ), 08 (G), 09 (A $\flat$ ), 10 (A), 11 (B $\flat$ ), 12 (B)	01 (C)	Determines the pitch of individual notes. You can use this Function to set your own temperament. <ul style="list-style-type: none"> <li>• 057 "Tuning Note": Selects the notes to set the pitch.</li> <li>• 058 "Tuning": Determines the pitch of the note. Determines the difference from equal temperament in units of 1 cent (a unit of pitch that is 1/100th of a semitone).</li> </ul>	
058	Tuning	<i>Tune</i>	-64 to 63	Depends on the Scale	If the value for Function 055 "Scale" is changed after making the above settings, all unique temperament settings will be erased. When a unique temperament is set, saving it to the Registration Memory (page 51) is recommended.	
<b>Metronome</b>						
059	Time Signature Numerator	<i>TimeSigh</i>	00 to 60	**	Determines the time signature of the Metronome.	
060	Time Signature Denominator	<i>TimeSigD</i>	Half note, Quarter note, Eighth note, Sixteenth note	**	Determines the length of each metronome beat.	
061	Metronome Volume	<i>MetroVol</i>	000 to 127	100	Determines the volume of the Metronome.	✓
<b>MIDI</b>						
062	Local Control	<i>Local</i>	ON/OFF	ON	Determines whether the instrument's keyboard controls the internal tone generator (ON) or not (OFF). When this is set to OFF, the internal sound will not sound even if you play the keyboard.	
063	External Clock	<i>ExtClock</i>	ON/OFF	OFF	Determines whether the instrument synchronizes to the internal clock (OFF) or an external clock (ON). When you want to sync the Style or Arpeggio performance with the tempo of a computer app or an external device, set this to [ON].	
064	Keyboard Out	<i>KbdOut</i>	ON/OFF	ON	Determines whether MIDI messages generated via keyboard performance are transmitted (ON) or not (OFF) from the [USB TO HOST] terminal.	
065	Style Out	<i>StyleOut</i>	ON/OFF	OFF	Determines whether MIDI messages generated via Style playback are transmitted (ON) or not (OFF) from the [USB TO HOST] terminal.	
066	Song Out	<i>SongOut</i>	ON/OFF	OFF	Determines whether MIDI messages generated via Song playback are transmitted (ON) or not (OFF) from the [USB TO HOST] terminal.	
067	Initial Send	<i>InitSend</i>	-	-	Allows you to send the data of the panel settings to a computer. If the [ENTER] button is pressed while the Function name is displayed, it will be executed immediately. When you record your keyboard performance to a computer app via MIDI, it is best to execute this Function immediately after starting recording.	

# The Functions

Function Number	Function	Display	Range/Settings	Default Value	Description	Backup
<b>Audio</b>						
068	[AUX IN] Audio Volume	<i>AuxInVol</i>	000 to 127	50	Determines the volume of audio playback that is input from the [AUX IN] jack.	✓
069	[USB TO HOST] [USB TO DEVICE] Audio Volume	<i>USBInVol</i>	000 to 127	100	Determines the volume of audio playback that is input from the [USB TO HOST] and [USB TO DEVICE] terminals.	✓
070	Audio Loop Back	<i>Loopback</i>	ON/OFF	ON	Determines whether Audio sound input from the [USB TO HOST] terminal is returned to the computer or not with the performance played on the instrument. If you want to output only the sound played on this instrument to the computer, set this parameter to "OFF."	✓
071	Melody Suppressor	<i>MelodySP</i>	ON/OFF	OFF	When the audio of an external audio device or a computer connected to the [AUX IN] terminal or the [USB TO HOST] terminal is output through this instrument, determines whether to cancel or lower the volume of the melody part (ON) or not (OFF).	
072	Melody Suppressor Pan	<i>SupprPan</i>	L63 to L01, C, R01 to R63	C	When Melody Suppressor is on, determines where in the left to right panning (stereo position of audio) to cancel or lower the volume of the audio.	
<b>Registration Freeze</b>						
073	Style Freeze	<i>StyleFrz</i>	ON/OFF	OFF	When calling up a Registration Memory, setting this to "ON" prevents the Style setting from changing and instead maintains (freezes) it at the current setting.	✓
074	Transpose Freeze	<i>TransFrz</i>	ON/OFF	OFF	When calling up a Registration Memory, setting this to "ON" prevents the Transpose setting from changing and instead maintains (freezes) it at the current setting.	✓
075	Voice Freeze	<i>VoiceFrz</i>	ON/OFF	OFF	When calling up a Registration Memory, setting this to "ON" prevents the Voice setting from changing and instead maintains (freezes) it at the current setting.	✓
<b>Storage</b>						
076	Storage Mode	<i>Storage</i>	ON/OFF	OFF	Set to "ON" when transferring files between the instrument and a computer. While Storage Mode is on, you cannot play the instrument.	
<b>Demo</b>						
077	Demo Group	<i>DemoGrp</i>	1 (Demo) 2 (Preset) 3 (User) 4 (Download) 5 (USB) 6 (AUDIO)	1 (Demo)	Determines the target for continuous playback when the [DEMO] button is pressed. <ul style="list-style-type: none"> <li>• 1 (Demo): Preset Songs 001 to 003</li> <li>• 2 (Preset): All Preset Songs 001 to 030</li> <li>• 3 (User): All User Songs</li> <li>• 4 (Download): All Songs transferred from a computer</li> <li>• 5 (USB): All Songs (MIDI files) in the connected USB flash drive</li> <li>• 6 (AUDIO): All Audio files (WAV files) in the connected USB flash drive</li> </ul>	✓
078	Playback Mode	<i>PlayMode</i>	1 (Normal) 2 (Random)	1 (Normal)	Determines the Song order for continuous playback when the [DEMO] button is pressed. <ul style="list-style-type: none"> <li>• 1 (Normal): Playback in the order of Song numbers</li> <li>• 2 (Random): Playback in random order</li> </ul>	✓
<b>Speaker</b>						
079	Speaker	<i>Speaker</i>	1 (HPSwitch) 2 (SP On) 3 (SP Off)	1 (HPSwitch)	Determines whether to output audio from the instrument's speakers. <ul style="list-style-type: none"> <li>• 1 (HPSwitch): When headphones are connected, audio is output from the headphones but not the speakers. When headphones are not connected, audio is output from the speakers.</li> <li>• 2 (SP On): Audio is output from the speakers, regardless of whether or not headphones are connected.</li> <li>• 3 (SP Off): Audio is not output from the speakers, regardless of whether or not headphones are connected.</li> </ul>	

Function Number	Function	Display	Range/Settings	Default Value	Description	Backup
<b>AC</b>						
080	Auto Power Off	<i>AutoOff</i>	OFF, 5/10/15/ 30/60/120 (minutes)	30 minutes	Determines the time that will elapse before the instrument's power is automatically turned off. When set to "OFF," the power does not turn off automatically.	✓
081	Battery	<i>Battery</i>	1 (Alkaline) 2 (Ni-MH)	1 (Alkaline)	Determines the type of batteries to use. <ul style="list-style-type: none"> <li>• 1 (Alkaline): Alkaline batteries, manganese batteries</li> <li>• 2 (Ni-MH): Rechargeable nickel metal hydride batteries</li> </ul>	✓
<b>Language</b>						
082	Language	<i>Language</i>	1 (English) 2 (Japanese)	1 (English)	Determines the language for displaying the names of files on USB flash drives, and files transferred from a computer to the instrument. However, double-byte characters are not displayed even if "2 (Japanese)" is selected.	✓

\* The appropriate value is automatically set for each Voice.

\*\* The appropriate value is automatically set for each Style, Song and Groove Creator.

**NOTE 4**

The MIDI and Audio settings are designed specifically for convenient use for when an external device such as a computer is connected to the [USB TO HOST] terminal (page 54).

# Backup and Initialization

## Backup Data

The following Backup parameters will be maintained even if the power is turned off.

### Backup parameters (each time)

- **User Songs** (page 34)
- **Styles loaded from external devices** (Styles 291 to 300) (\*)
- **Samples saved to Quick Sampling pads** (page 42)  
\* For details about how to load Style files, refer to the Reference Manual on the website (page 11).

### Backup parameters when turning off the power

- **Registration Memory** (page 51)
- **Function settings:** (page 62 to 67)  
Settings with a check mark in the "Backup" column in the Function List are backed up.

In addition to the Backup parameters above, all the files (including Style files that have not been loaded) transferred from the connected computer will be maintained, even if you turn off the power.

### NOTICE

- *Backups are executed automatically when the power is turned off. However, please note that backups are not executed and the settings will be lost if the power is turned off in the following situations.*
- *Disconnected AC adaptor*
- *Power failure*
- *Low or no battery power*

### Backup files (.BUP)

Backup files (.BUP) that can be transferred to a computer or smart device contain the following data.

- **User Songs** (Songs 031 to 040)
- **Styles loaded from external devices** (Styles 291 to 300)
- **Data described in "Backup parameters when turning off the power" above**

For details about how to transfer backup files, refer to page 55.

## Initializing the Instrument

You can erase the backup parameter settings described above, and then restore all the default factory settings. The instrument can be initialized with the following two methods.

### Backup Clear

This operation initializes the backup parameters. While holding down the highest white key, press the [  ] (**Standby/On**) switch to turn the power on.

#### PSR-E473

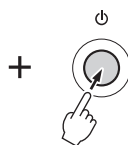
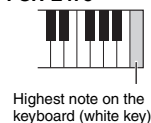

#### PSR-EW425

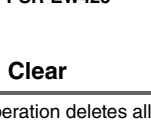

### Flash Clear

This operation deletes all the Songs and Styles that have been transferred from a computer. However, data that has been loaded into Styles 291 to 300 will not be deleted.

While simultaneously holding the highest white key and the three highest black keys, press the [  ] (**Standby/On**) switch to turn the power on.

#### PSR-E473

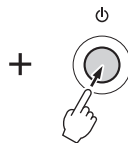
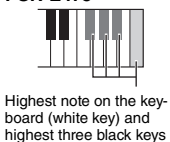

#### PSR-EW425

### NOTICE

*Keep in mind that this operation also deletes any data you have purchased and loaded. Be sure to save important data to a computer. For details, refer to the Computer-related Operations on the website (page 11).*

# Troubleshooting

Problem	Possible Cause and Solution
When the instrument is turned on after pressing the [⏻] (Standby/On) switch, a popping sound is temporarily produced.	This is normal and indicates that the instrument is receiving electrical power. When turning on the power, turn the [MASTER VOLUME] all the way down.
When the instrument is turned on after pressing the [⏻] (Standby/On) switch, power is turned off suddenly and unexpectedly.	If an AC adaptor other than the one specified is used, power might be turned off suddenly and unexpectedly. Use only the specified AC adaptor (page 72).
When using a mobile phone, noise is produced in the instrument's speakers and/or headphones.	Using a mobile phone in close proximity to the instrument might produce interference. To prevent this, turn off the mobile phone or use it further away from the instrument.
The instrument automatically turns off even when no operation is performed.	This is normal. This occurs due to the Auto Power Off function (page 18).
<ul style="list-style-type: none"> <li>• The volume is too low.</li> <li>• The sound quality is poor.</li> <li>• The Style/Groove/Song/Arpeggio stops unexpectedly or will not play.</li> <li>• The recorded data of the song, etc. does not play correctly.</li> <li>• The LCD display suddenly goes dark, and all panel settings are reset.</li> <li>• The instrument turns off when a USB flash drive is connected.</li> </ul>	The battery power is low or empty. Replace all the batteries with completely new ones or completely recharged ones, or use the AC adaptor.
No sound is produced even when the keyboard is played, or when a Song, Style, or Groove is played back.	Check if a set of headphones is connected to the [PHONES] jack. Either unplug the headphones, or set Function 079 "Speakers" (page 66) to "2 (SP On)."
	Function 079 "Speakers" (page 66) is set to "3 (SP Off)." Set it to either "1 (HPSwitch)" or "2 (SP On)."
	Function 062 "Local Control" (page 65) is set to OFF. Normally, this parameter should be set to ON.
The footswitch (for sustain) seems to produce the opposite effect. For example, pressing the footswitch cuts off the sound and releasing it sustains the sounds.	This happens either because you were stepping on the footswitch while turning the power on, or the footswitch was connected/disconnected while the power is on. Turn off the power, and then turn it on again while being careful not to step on the footswitch.
Not all of the Voices seem to sound when playing the keyboard, or the sound seems to be cut off when playing Arpeggio, Style, Song, Groove Creator or the QUICK SAMPLING pads.	You have exceeded 64 simultaneous notes, which is the maximum polyphony (the maximum amount of notes that can be played simultaneously) of this instrument. If the Main, Dual, and Split Voices are being used along with playback of Arpeggio, Style, Groove or Song, some notes/sounds may be omitted (or "stolen").
The sound of the Voice changes from note to note.	This is normal. The tone generation method uses multiple recordings (samples) of an instrument across the range of the keyboard; thus, the actual sound of the Voice may be slightly different from note to note.
The keyboard performance and playback of Style/Song/Groove Creator produces an unexpected or inappropriate sound, and cannot be restored to the normal status.	An unintended setting was made due to operation of the LIVE CONTROL knob. To undo this, reset the panel settings by turning off DSP2, changing the Voice, Style, Song or Groove Creator, or pressing the [PORTABLE GRAND] button.
The Style, Song or Groove Creator does not start even when the [START/STOP] button is pressed. The Arpeggio does not start even when the note is pressed with the Arpeggio turned on.	Function 063 "External Clock" (page 65) is set to ON. Normally, this parameter should be set to OFF.
The volume of the Style, Song or Groove Creator is too low.	Check the volume setting for each function (page 63).
The chords played in the left-hand area cannot be recognized even when ACMP is turned on.	The setting for Function 004 "Split Point" (page 62) is not correct. Set it to an appropriate value.

Problem	Possible Cause and Solution
Style parts other than the Rhythm part produce no sound.	Style (ACMP) is not on. Press the [ACMP ON/OFF] button to display the ACMP indicator. (page 31)
When a particular Style is selected, no rhythm is played even when the [START/STOP] button is pressed.	This is normal. For styles that do not have any rhythm data, there will be no sound when you try to play back only the rhythm part. In that case, the accompaniment will play back only if you turn ACMP on and play chords in the Auto Accompaniment area.
The ACMP indicator does not appear on the display when the [ACMP ON/OFF] button is pressed.	A Style has not been selected. When using a Style, press the [STYLE] button to turn on the [STYLE] lamp.
The instrument does not respond when operated.	Function 076 "Storage Mode" (page 66) is set to ON. Set Storage Mode to OFF.
The Style does not play back according to the chord that is played.	The setting for Function 032 "Fingering Type" (pages 33, 63) does not fit with how the chords are being played. Check the settings. For details about how these settings affect the way the instrument recognizes the played chords, refer to the Reference Manual on the website (page 11).
	If Function 032 "Fingering Type" (pages 33, 63) is set to "1 (Multi)," the following responses to User operations may occur. However, this is normal. <ul style="list-style-type: none"> <li>• If similar chords are played in succession (such as a minor seventh chord followed by a minor chord with the same root note), the Style might not change.</li> <li>• If only two keys are played, the optimum chord will be detected based on the played chord immediately before.</li> <li>• If an octave is played, only the root note will be heard in the accompaniment.</li> </ul>
The Smart Device app does not recognize the instrument.	Function 076 "Storage Mode" (page 66) is set to ON. Set Storage Mode to OFF.

Refer to also to the Message Lists (pages 36, 50, 60) as required.

# Specifications

			PSR-E473	PSR-EW425
<b>Product Name</b>			Digital Keyboard	
<b>Size/Weight</b>	Dimensions (W x D x H)		992 mm x 404 mm x 136 mm (39-1/16" x 15-7/8" x 5-3/8")	1200 mm x 404 mm x 136 mm (47-1/4" x 15-7/8" x 5-3/8")
	Weight		7.0 kg (15 lbs., 7 oz.) (not including batteries)	8.3 kg (18 lbs., 5 oz.) (not including batteries)
<b>Control Interface</b>	Keyboard	Number of Keys	61	76
		Touch Response	Soft, Medium, Hard, Fixed	
	Other Controllers	Pitch Bend Wheel	Yes	
		Knobs	2	
Panel	Language	English		
<b>Voices</b>	Tone Generation	Tone Generation Technology	AWM Stereo Sampling	
	Polyphony (max.)		64	
	Preset	Number of Voices	820 (294 Panel Voices + 28 Drum/SFX kits + 40 Arpeggio + 458 XGlite Voices)	820 (294 Panel Voices + 28 Drum/SFX kits + 40 Arpeggio + 458 XGlite Voices)
	Compatibility		GM, XGlite	
<b>Effects</b>	Types	Reverb	12	
		Chorus	5	
		Master EQ	4	
		DSP	DSP1:41 DSP2:12	
<b>Accompaniment Styles</b>	Preset	Number of Styles	290	
		Fingering	Multi finger, Smart Chord	
		Style Control	ACMP ON/OFF, SYNC START, SYNC STOP, START/STOP, INTRO/ENDING/rit., MAIN/AUTO FILL, TRACK ON/OFF	
	External Styles		10	
	Other Features	One Touch Setting (OTS)	Yes	
Compatibility		Style File Format (SFF)		
<b>Groove Creator</b>	Preset	Number of Grooves	35	
		Number of Sections	5 (4 Sections + 1 Musical Climax/Ending)	
<b>Songs (MIDI)</b>	Preset	Number of Preset Songs	30	
		Number of Songs	10	
	Recording	Number of Tracks	6 (5 Melody + 1 Style/Groove Creator)	
		Data Capacity	Approx. 19,000 notes (when only "melody" tracks are recorded)	
	Format	Playback	SMF (Formats 0 & 1)	
Recording		Original File Format (SMF 0 conversion function)		
<b>USB Audio Recorder</b>	Recording Time (max.)		80 minutes (approx. 0.9 GB) per Song	
	Format	Playback	WAV(44.1 kHz, 16 bit, stereo)	
		Recording	WAV(44.1 kHz, 16 bit, stereo)	
<b>Quick Sampling</b>	Sampling Type		Oneshot, Loop	
	Samples (Preset/User)		4	
	Sampling Time		Approx. 9.6 sec	
	Sampling Sources		AUX IN, MIC INPUT, USB audio interface, WAV format files	
	Sampling Format		Original File Format (16 bit, stereo)	
Sampling Rate		44.1 kHz		
<b>Functions</b>	Voices	Dual	Yes	
		Split	Yes	
		Harmony	26	
		Arpeggio	152	
		Articulation	Yes	

## Specifications

		PSR-E473		PSR-EW425	
<b>Functions</b>	Registration Memory	Number of Buttons	4 (x 8 banks)		
		Control	Freeze		
	Overall Controls	Metronome	Yes		
		Tempo Range	11 – 280		
		Transpose	-12 to 0, 0 to +12		
		Tuning	427.0 – 440.0 – 453.0 Hz (approx. 0.2Hz increments)		
		Octave Button	Yes		
		Scale Type	5 types		
	Miscellaneous	PIANO Button	Yes		
		Demo	Yes		
		Melody Suppressor	Yes		
		Crossfade	Yes		
		USB audio interface	44.1 kHz, 16 bit, stereo		
		Motion Effect	57		
	Mega Boost	2 steps (approx. +3 dB, and +6 dB)			
<b>Storage and Connectivity</b>	Storage	Internal Memory	Approx. 1.72 MB		
		External Drives	USB flash drive		
	Connectivity	DC IN	12 V	16 V	
		Headphones	Standard stereo phone jack		
		Microphone	Yes		
		Sustain Pedal	Yes		
		AUX IN	Stereo mini jack		
		OUTPUT	Standard stereo phone jacks: L/L+R, R		
		USB TO DEVICE	Yes		
		USB TO HOST	Yes		
<b>Sound System</b>	Amplifiers	6 W + 6 W		12 W + 12 W	
	Speakers	12cm x 2			
<b>Power Supply</b>	AC Adaptor	PA-150 or an equivalent recommended by Yamaha (Output : DC 12V, 1.5 A)		PA-300C (Output : DC 16 V, 2.4 A )	
	Batteries	Six "AA" size alkaline(LR6), manganese (R6) or Ni-MH rechargeable (HR6) batteries		Six "D" size alkaline(LR20), manganese (R20) or Ni-MH rechargeable (HR20) batteries	
	Power Consumption	9 W (When using PA-150 AC adaptor)		11 W (When using PA-300C AC adaptor)	
	Auto Power Off	Yes		Yes	
<b>Included Accessories</b>	<ul style="list-style-type: none"> <li>• Owner's Manual</li> <li>• AC adaptor* (PA-150 or an equivalent recommended by Yamaha)</li> <li>* May not be included depending on your area. Check with your Yamaha dealer.</li> <li>• Music Rest</li> <li>• Online Member Product Registration</li> </ul>		<ul style="list-style-type: none"> <li>• Owner's Manual</li> <li>• AC adaptor* (PA-300C or an equivalent recommended by Yamaha)</li> <li>* May not be included depending on your area. Check with your Yamaha dealer.</li> <li>• Music Rest</li> <li>• Online Member Product Registration</li> </ul>		
<b>Separately Sold Accessories</b> (May not be available depending on your area.)	<ul style="list-style-type: none"> <li>• AC adaptor: PA-150 or an equivalent recommended by Yamaha</li> <li>• Keyboard Stand: L-2C</li> <li>• Headphones: HPH-150/HPH-100/HPH-50</li> <li>• Subwoofer: KS-SW100</li> <li>• Footswitch: FC4A/FC5</li> <li>• Wireless MIDI adaptor: UD-BT01</li> </ul>		<ul style="list-style-type: none"> <li>• AC adaptor: PA-300C or an equivalent recommended by Yamaha</li> <li>• Keyboard Stand: L-6</li> <li>• Headphones: HPH-150/HPH-100/HPH-50</li> <li>• Subwoofer: KS-SW100</li> <li>• Footswitch: FC4A/FC5</li> <li>• Wireless MIDI adaptor: UD-BT01</li> </ul>		

\* The contents of this manual apply to the latest specifications as of the publishing date. To obtain the latest manual, access the Yamaha website then download the manual file. Since specifications, equipment or separately sold accessories may not be the same in every locale, please check with your Yamaha dealer.



# Index

- A**  
A-B Repeat ..... 37  
AC Adaptor ..... 16  
ACMP ..... 31  
Arpeggio ..... 26  
Articulation ..... 27  
Audio File ..... 34, 36  
Audio Recording ..... 46  
Auto Accompaniment area ..... 31  
Auto Fill ..... 32  
Auto Power Off ..... 18, 67
- B**  
Background Music ..... 35  
Backup ..... 68  
Backup Clear ..... 68  
Batteries ..... 16
- C**  
Category (Song) ..... 34  
Category (Voice, Style) ..... 21  
Chord ..... 31  
Chorus ..... 39  
Chorus Type ..... 63  
Computer ..... 54  
Computer-related Operations .. 11
- D**  
Data List ..... 11  
Demo Song ..... 35  
Display ..... 22  
Downloaded songs ..... 34  
DSP ..... 28  
Dual Voice ..... 24
- E**  
Effect ..... 28  
Ending ..... 32  
External Audio Device ..... 54  
External Clock ..... 65  
External Speakers ..... 53
- F**  
Fast Forward ..... 36  
Fast Reverse ..... 36  
File Control display ..... 57, 58  
Fingering Type ..... 33  
Flash Clear ..... 68  
Footswitch ..... 53  
Format ..... 58  
Freeze ..... 52  
Functions ..... 61
- G**  
Groove ..... 40  
Groove Creator ..... 40
- H**  
Harmony ..... 26  
Headphones ..... 53
- I**  
Included Accessories ..... 10  
Increase in volume ..... 23  
Initialization ..... 68  
Intro ..... 32
- K**  
Keyboard Stand ..... 19  
Knob ..... 30
- L**  
Language ..... 67  
Local Control ..... 65  
Loop playback ..... 42
- M**  
Main A/B ..... 32  
Main Voice ..... 24  
Master EQ Type ..... 63  
Mega Boost ..... 23  
Melody Suppressor ..... 54  
Message List ..... 36, 50, 60  
Metronome ..... 23  
Microphone ..... 38  
MIDI ..... 34, 55, 65  
MIDI Basics ..... 11  
Motion Effect ..... 29  
Multi-Finger ..... 33  
Music Rest ..... 10  
MUSICAL CLIMAX ..... 40
- O**  
One Touch Setting ..... 25  
One-shot playback ..... 42  
OTS ..... 25
- P**  
Pause ..... 36  
Pedal ..... 53  
PITCH BEND ..... 15  
Pitch Bend Range ..... 62  
PORTABLE GRAND ..... 14  
Power ..... 12, 16, 18
- Q**  
Quick Sampling ..... 42
- R**  
Recording ..... 46  
Reference Manual ..... 11  
Registration Memory ..... 51  
Retrigger ..... 41  
Reverb ..... 39  
Reverb Type ..... 63
- S**  
S.Art Lite Voice ..... 27  
Sample ..... 42  
Sampling ..... 42  
Scale Tuning ..... 65  
Section (Groove) ..... 40  
Section (Style) ..... 32  
SHIFT ..... 12  
Smart Chord ..... 33  
Smart Chord Key ..... 33  
Smart Device ..... 54  
Smart Device Connection  
Manual ..... 11  
Song ..... 34, 35  
Song book ..... 11  
Song Recording ..... 46  
Specifications ..... 71  
Split Point ..... 31, 62  
Split Voice ..... 25  
Style ..... 31  
Style Revoicing ..... 33  
Sustain ..... 53  
Sync Start ..... 31  
Sync Stop ..... 32
- T**  
Talk ..... 39  
Tap Tempo ..... 23  
Tempo ..... 23  
Touch Response ..... 62  
Track (Groove) ..... 40  
Track (Song) ..... 37, 47  
Track (Style) ..... 32  
Transferring Files ..... 55  
Transpose ..... 62  
Troubleshooting ..... 69  
Tuning ..... 62
- U**  
USB Audio Interface Function .. 55  
USB Flash Drive ..... 56  
USB TO DEVICE ..... 56  
USB TO HOST ..... 54  
User Song ..... 34, 46
- V**  
Video Manual ..... 11  
Voice ..... 24  
Volume ..... 12



**Important Notice:**

**U.S. LIMITED WARRANTY for Customers in the United States**

For detailed information about this Yamaha product and warranty service, please either visit the following website address (printable file is available at our website) or contact Customer Service at the address or telephone number identified below.

**Website Address:**

Yamaha.io/**pkbwarranty**

**Customer Service:**

Yamaha Corporation of America  
6600 Orangethorpe Avenue, Buena Park, CA 90620-1273  
Telephone: 800-854-1569

# Important Notice: Guarantee Information for customers in European Economic Area (EEA) and Switzerland

<p><b>Important Notice: Guarantee Information for customers in EEA* and Switzerland</b></p> <p>For detailed guarantee information about this Yamaha product, and Pan-EEA* and Switzerland warranty service, please either visit the website address below (Printable file is available at our website) or contact the Yamaha representative office for your country. * EEA: European Economic Area</p>	<p><b>English</b></p>
<p><b>Wichtiger Hinweis: Garantie-Information für Kunden in der EWR* und der Schweiz</b></p> <p>Für nähere Garantie-Information über dieses Produkt von Yamaha, sowie über den Pan-EWR*- und Schweizer Garantieservice, besuchen Sie bitte entweder die folgend angegebene Internetadresse (eine druckfähige Version befindet sich auch auf unserer Webseite), oder wenden Sie sich an den für Ihr Land zuständigen Yamaha-Vertrieb. * EWR: Europäischer Wirtschaftsraum</p>	<p><b>Deutsch</b></p>
<p><b>Remarque importante: informations de garantie pour les clients de l'EEE* et la Suisse</b></p> <p>Pour des informations plus détaillées sur la garantie de ce produit Yamaha et sur le service de garantie applicable dans l'ensemble de l'EEE ainsi qu'en Suisse, consultez notre site Web à l'adresse ci-dessous (le fichier imprimable est disponible sur notre site Web) ou contactez directement Yamaha dans votre pays de résidence. * EEE : Espace Economique Européen</p>	<p><b>Français</b></p>
<p><b>Belangrijke mededeling: Garantie-informatie voor klanten in de EER* en Zwitserland</b></p> <p>Voor gedetailleerde garantie-informatie over dit Yamaha-product en de garantieservice in heel de EER* en Zwitserland, gaat u naar de onderstaande website (u vind een afdrukbaar bestand op onze website) of neemt u contact op met de vertegenwoordiging van Yamaha in uw land. * EER: Europese Economische Ruimte</p>	<p><b>Nederlands</b></p>
<p><b>Aviso importante: información sobre la garantía para los clientes del EEE* y Suiza</b></p> <p>Para una información detallada sobre este producto Yamaha y sobre el soporte de garantía en la zona EEE* y Suiza, visite la dirección web que se incluye más abajo (la versión del archivo para imprimir está disponible en nuestro sitio web) o póngase en contacto con el representante de Yamaha en su país. * EEE: Espacio Económico Europeo</p>	<p><b>Español</b></p>
<p><b>Avviso importante: informazioni sulla garanzia per i clienti residenti nell'EEA* e in Svizzera</b></p> <p>Per informazioni dettagliate sulla garanzia relativa a questo prodotto Yamaha e l'assistenza in garanzia nei paesi EEA* e in Svizzera, potete consultare il sito Web all'indirizzo riportato di seguito (è disponibile il file in formato stampabile) oppure contattare l'ufficio di rappresentanza locale della Yamaha. * EEA: Area Economica Europea</p>	<p><b>Italiano</b></p>
<p><b>Aviso importante: informações sobre as garantias para clientes da AEE* e da Suíça</b></p> <p>Para obter uma informação pormenorizada sobre este produto da Yamaha e sobre o serviço de garantia na AEE* e na Suíça, visite o site a seguir (o arquivo para impressão está disponível no nosso site) ou entre em contato com o escritório de representação da Yamaha no seu país. * AEE: Área Económica Europeia</p>	<p><b>Português</b></p>
<p><b>Σημαντική σημείωση: Πληροφορίες εγγύησης για τους πελάτες στον ΕΟΧ* και Ελλάδα</b></p> <p>Για λεπτομερείς πληροφορίες εγγύησης σχετικά με το προϊόν προϊόν της Yamaha και την κάλυψη εγγύησης σε όλες τις χώρες του ΕΟΧ και την Ελλάδα, επισκεφτείτε την παρακάτω ιστοσελίδα (Εκτυπώσιμη μορφή είναι διαθέσιμη στην ιστοσελίδα μας) ή απευθυνθείτε στην αντιπροσωπεία της Yamaha στη χώρα σας. * ΕΟΧ: Ευρωπαϊκός Οικονομικός Χώρος</p>	<p><b>Ελληνικά</b></p>
<p><b>Viktigt: Garantierinformation för kunder i EES-området* och Schweiz</b></p> <p>För detaljerad information om denna Yamaha-produkt samt garantier i hela EES-området* och Schweiz kan du antingen besöka nedanstående webbadress (en utskriftsvänlig fil finns på webbplatsen) eller kontakta Yamahas office/representant i ditt land. * EES: Europeiska Ekonomiska Samarbetsområdet</p>	<p><b>Svenska</b></p>
<p><b>Viktig merknad: Garantierinformasjon for kunder i EØS* og Sveits</b></p> <p>Detaljert informasjon om dette Yamaha-produktet og garantier i hele EØS-området* og Sveits kan fås enten ved å besøke nettadressen nedenfor (utskriftsversjon finnes på våre nettsider) eller kontakte Yamahas kontore/landet der du bor. * EØS: Det europeiske økonomiske samarbeidsområdet</p>	<p><b>Norsk</b></p>
<p><b>Vigtig oplysning: Garantioplysninger til kunder i EØ* og Schweiz</b></p> <p>De kan finde detaljerede garantioplysninger om dette Yamaha-produkt og den fælles garantierordening for EØ* (og Schweiz) ved at besøge det websted, der er angivet nedenfor (der findes en fil, som kan udskrives, på vores websted), eller ved at kontakte Yamahas nationale repræsentationskontor i det land, hvor De bor. * EØ: Det Europæiske Økonomiske Område</p>	<p><b>Dansk</b></p>
<p><b>Tärkeä ilmoitus: Taku tiedot Euroopan talousalueen (ETA)* ja Sveitsin asiakkaille</b></p> <p>Tämän Yamaha-tuotteen sekä ETA-alueen ja Sveitsin takuuta koskevat yksityiskohtaiset tiedot saatte alla olevasta nettiosoitteesta. (Tulostettava tiedosto saatavissa sivustallamme.) Voitte myös ottaa yhteyttä paikalliseen Yamaha-edustajaan. *ETA: Euroopan talousalue</p>	<p><b>Suomi</b></p>
<p><b>Ważne: Warunki gwarancyjne obowiązujące w EOG* i Szwajcarii</b></p> <p>Aby dowiedzieć się więcej na temat warunków gwarancyjnych tego produktu firmy Yamaha i serwisu gwarancyjnego w całym EOG* i Szwajcarii, należy odwiedzić wskazaną poniżej stronę internetową (Plik gotowy do wydruku znajduje się na naszej stronie internetowej) lub skontaktować się z przedstawicielstwem firmy Yamaha w swoim kraju. * EOG – Europejski Obszar Gospodarczy</p>	<p><b>Polski</b></p>
<p><b>Dôležité oznámenie: Záruční informace pro zákazníky v EHS* a ve Švýcarsku</b></p> <p>Podrobné záruční informácie o tomto produkte Yamaha a záručníms servisu v celom EHS* a vo Švajcarsku náleznete na nižšie uvedené webové adrese (soubor k tisku je dostupný na našich webových stránkach) nebo se můžete obrátiť na zastupení firmy Yamaha ve své zemi. * EHS: Evropský hospodářský prostor</p>	<p><b>Česky</b></p>
<p><b>Fontos figyelmeztetés: Garancia-információk az EGT* területén és Svájcban élő vásárlók számára</b></p> <p>A jelen Yamaha termékre vonatkozó részletes garancia-információk, valamint az EGT*-re és Svájcra kiterjedő garanciális szolgáltatás tekintetében keresse fel webhelyünket az alábbi címen (a webhelyen nyomtatható fájl is található), vagy pedig lépjen kapcsolatba az országában működő Yamaha képviselői irodával. * EGT: Európai Gazdasági Térség</p>	<p><b>Magyar</b></p>
<p><b>Oluline märkus: Garantiteave Euroopa Majanduspiirkonna (EMP)* ja Šveitsi klientidele</b></p> <p>Täpsemate teabete saamiseks selle Yamaha toote garantii ning kogu Euroopa Majanduspiirkonna ja Šveitsi garantiteeninduse kohta, külastage palun veebisaiti alljärgneval aadressil (meie saidil on saadaval printitav fail) või pöörduge Teie regiooni Yamaha esinduse poole. * EMP: Euroopa Majanduspiirkond</p>	<p><b>Eesti keel</b></p>
<p><b>Svarīgās paziņojums: garantijas informācija klientiem EEZ* un Šveicā</b></p> <p>Lai saņemtu detalizētu garantijas informāciju par šo Yamaha produktu, kā arī garantijas apkalpošanu EEZ* un Šveicā, lūdzam apmeklētiet zemāk norādīto tīmekļa vietnes adresi (tīmekļa vietnē ir pieejams drukājams fails) vai sazinieties ar jūsu valsts apkalpojotāju Yamaha pārstāvniecību. * EEZ: Eiropas Ekonomikas zona</p>	<p><b>Latviešu</b></p>
<p><b>Démosio: informacija dėl garantijos pirkėjams EEE* ir Šveicarijoje</b></p> <p>Jei reikia išsames informacijos apie šį „Yamaha“ produktą ir jo techninę priežiūrą visoje EEE* ir Šveicarijoje, apsilankykite mūsų svetainėje toliau nurodytu adresu (svetainėje yra spausdinamas failas) arba kreipkitės „Yamaha“ atstovų bei savo šaliai. *EEE – Europos ekonominė erdvė</p>	<p><b>Lietuvių kalba</b></p>
<p><b>Dôležité upozornenie: Informácie o záruke pre zákazníkov v EHP* a Švajčiarsku</b></p> <p>Podrobné informácie o záruke týkajúce sa tohto produktu od spoločnosti Yamaha a garancijnom servise v EHP* a Švajčiarsku nájdete na webovej stránke uvedenej nižšie (na našej webovej stránke je k dispozícii súbor na tlač) alebo sa obráťte na zástupcu spoločnosti Yamaha vo svojej krajine. * EHP: Európsky hospodársky priestor</p>	<p><b>Slovenčina</b></p>
<p><b>Pomembno obvestilo: Informacije o garanciji za kupce v EGP* in Švici</b></p> <p>Za podrobne informacije o tem Yamahinih izdelkih ter garancijskem servisu v celotnem EGP in Švici, obiščite spletno mesto, ki je navedeno spodaj (natisljiva datoteka je na voljo na našem spletnem mestu), ali se obrnite na Yamahinega predstavnika v svoji državi. * EGP: Evropski gospodarski prostor</p>	<p><b>Slovensčina</b></p>
<p><b>Важно съобщение: Информация за гаранцията за клиенти в ЕИП* и Швейцария</b></p> <p>За подробна информация за гаранцията за този продукт на Yamaha и гаранционното обслужване в паневропейската зона на ЕИП* и Швейцария или посетете посочения подолу уеб сайт (на нашия уеб сайт има файл за печат), или се свържете с представителния офис на Yamaha във вашата страна. * ЕИП: Европейско икономическо пространство</p>	<p><b>Български език</b></p>
<p><b>Notificare importantă: Informații despre garanție pentru clienții din SEE* și Elveția</b></p> <p>Pentru informații detaliate privind acest produs Yamaha și serviciul de garanție Pan-SEE* și Elveția, vizitați site-ul la adresa de mai jos (fișierul imprimabil este disponibil pe site-ul nostru) sau contactați biroul reprezentanței Yamaha din țara dumneavoastră. * SEE: Spațiul Economic European</p>	<p><b>Limba română</b></p>
<p><b>Važna obavijest: Informacije o jamstvu za države EGP-a i Švicarske</b></p> <p>Za detaljne informacije o jamstvu za ovaj Yamahin proizvod te jamstvenom servisu za cijeli EGP i Švicarsku, molimo Vas da posjetite web-stranicu navedenu u nastavku ili kontaktirate ovlaštenog Yamahinog dobavljača u svojoj zemlji. * EGP: Evropski gospodarski prostor</p>	<p><b>Hrvatski</b></p>

<https://europe.yamaha.com/warranty/>

For details of products, please contact your nearest Yamaha representative or the authorized distributor listed below.

## NORTH AMERICA

### CANADA

**Yamaha Canada Music Ltd.**  
135 Milner Avenue, Toronto, Ontario M1S 3R1,  
Canada  
Tel: +1-416-298-1311

### U.S.A.

**Yamaha Corporation of America**  
6600 Orange thorpe Avenue, Buena Park, CA 90620,  
U.S.A.  
Tel: +1-714-522-9011

## CENTRAL & SOUTH AMERICA

### MEXICO

**Yamaha de México, S.A. de C.V.**  
Av. Insurgentes Sur 1647 Piso 9, Col. San José  
Insurgentes, Delegación Benito Juárez, CDMX,  
C.P. 03900, México  
Tel: +52-55-5804-0600

### BRAZIL

**Yamaha Musical do Brasil Ltda.**  
Praça Professor José Lannes, 40-Cjs 21 e 22, Brooklin  
Paulista Novo CEP 04571-100 - São Paulo - SP,  
Brazil  
Tel: +55-11-3704-1377

### ARGENTINA

**Yamaha Music Latin America, S.A.,  
Sucursal Argentina**  
Olga Cossetтини 1553, Piso 4 Norte,  
Madero Este-C1107CEK,  
Buenos Aires, Argentina  
Tel: +54-11-4119-7000

### PANAMA AND OTHER LATIN AMERICAN REGIONS/ CARIBBEAN REGIONS

**Yamaha Music Latin America, S.A.**  
Edificio Torre Davivienda, Piso: 20  
Avenida Balboa, Marbella, Corregimiento de Bella  
Vista, Ciudad de Panamá, Rep. de Panamá  
Tel: +507-269-5311

## EUROPE

### THE UNITED KINGDOM/IRELAND

**Yamaha Europe GmbH (UK)**  
Sherbourne Drive, Tilbrook, Milton Keynes,  
MK7 8BL, U.K.  
Tel: +44-1908-366700

### GERMANY

**Yamaha Music Europe GmbH**  
Siemensstrasse 22-34, 25462 Rellingen, Germany  
Tel: +49-4101-303-0

### SWITZERLAND/LIECHTENSTEIN

**Yamaha Music Europe GmbH, Branch  
Switzerland in Thalwil**  
Seestrasse 18a, 8800 Thalwil, Switzerland  
Tel: +41-44-3878080

### AUSTRIA/CROATIA/CZECH REPUBLIC/ HUNGARY/ROMANIA/SLOVAKIA/ SLOVENIA

**Yamaha Music Europe GmbH, Branch Austria**  
Schleiergasse 20, 1100 Wien, Austria  
Tel: +43-1-60203900

### POLAND

**Yamaha Music Europe**  
Sp.z o.o. Oddział w Polsce  
ul. Wielicka 52, 02-657 Warszawa, Poland  
Tel: +48-22-880-08-88

### BULGARIA

**Dinacord Bulgaria LTD.**  
Bul. Iskarsko Shose 7 Targovskii Zentar Ewropa  
1528 Sofia, Bulgaria  
Tel: +359-2-978-20-25

### MALTA

**Olimpus Music Ltd.**  
Valletta Road, Mosta MST9010, Malta  
Tel: +356-2133-2093

### NETHERLANDS/BELGIUM/ LUXEMBOURG

**Yamaha Music Europe, Branch Benelux**  
Clarissenhof 5b, 4133 AB Vianen, The Netherlands  
Tel: +31-347-358040

### FRANCE

**Yamaha Music Europe**  
7 rue Ambroise Croizat, Zone d'activités de Pariest,  
77183 Croissy-Beaubourg, France  
Tel: +33-1-6461-4000

### ITALY

**Yamaha Music Europe GmbH, Branch Italy**  
Via Tinelli N.67/69 20855 Gerno di Lesmo (MB),  
Italy  
Tel: +39-039-9065-1

### SPAIN/PORTUGAL

**Yamaha Music Europe GmbH Ibérica, Sucursal  
en España**  
Ctra. de la Coruña km. 17,200, 28231  
Las Rozas de Madrid, Spain  
Tel: +34-91-639-88-88

### GREECE

**Philippos Nakas S.A. The Music House**  
19h klm. Leof. Lavriou 190 02 Peania - Attiki,  
Greece  
Tel: +30-210-6686260

### SWEDEN

**Yamaha Music Europe GmbH Germany Filial  
Scandinavia**  
JA Wettergrensgata 1, 400 43 Göteborg, Sweden  
Tel: +46-31-89-34-00

### DENMARK

**Yamaha Music Denmark,  
Filial of Yamaha Music Europe GmbH, Tyskland**  
Generatorvej 8C, ST. TH., 2860 Søborg, Denmark  
Tel: +45-44-92-49-00

### FINLAND

**F-Musikkii Oy**  
Antaksentie 4  
FI-01510 Vantaa, Finland  
Tel: +358 (09)6185111

### NORWAY

**Yamaha Music Europe GmbH Germany -  
Norwegian Branch**  
Grini Næringspark 1, 1332 Østerås, Norway  
Tel: +47-6716-7800

### ICELAND

**Hjodfaerahusid Eh.**  
Siduluma 20  
IS-108 Reykjavik, Iceland  
Tel: +354-525-5050

### CYPRUS

**Nakas Music Cyprus Ltd.**  
Nikis Ave 2k  
1086 Nicosia  
Tel: +357-22-511080  
**Major Music Center**  
21 Ali Riza Ave, Ortakoy  
P.O.Box 475 Lefkoşa, Cyprus  
Tel: (392) 227 9213

### RUSSIA

**Yamaha Music (Russia) LLC.**  
Room 37, entrance 7, bld. 7, Kievskaya street,  
Moscow, 121059, Russia  
Tel: +7-495-626-5005

### OTHER EUROPEAN REGIONS

**Yamaha Music Europe GmbH**  
Siemensstrasse 22-34, 25462 Rellingen, Germany  
Tel: +49-4101-303-0

## AFRICA

**Yamaha Music Gulf FZE**  
JAFZA-16, Office 512, P.O.Box 17328,  
Jebel Ali FZE, Dubai, UAE  
Tel: +971-4-801-1500

## MIDDLE EAST

### TURKEY

**Yamaha Music Europe GmbH  
Merkezi Almanya Türkiye İstanbul Subesi**  
Mor Sumbul Sokak Varyap Meridian Business  
1.Blok No:1 113-114-115  
Bati Atasehir Istanbul, Turkey  
Tel: +90-216-275-7960

### ISRAEL

**RBX International Co., Ltd.**  
P.O.Box 10245, Petach-Tikva, 49002  
Tel: (972) 3-925-6900

### OTHER REGIONS

**Yamaha Music Gulf FZE**  
JAFZA-16, Office 512, P.O.Box 17328,  
Jebel Ali FZE, Dubai, UAE  
Tel: +971-4-801-1500

## ASIA

### THE PEOPLE'S REPUBLIC OF CHINA

**Yamaha Music & Electronics (China) Co., Ltd.**  
2F, Yunhedasha, 1818 Xinzha-lu, Jingan-qu,  
Shanghai, China  
Tel: +86-400-051-7700

### HONG KONG

**Tom Lee Music Co., Ltd.**  
11/F, Silvercord Tower 1, 30 Canton Road,  
Tsimshatsui, Kowloon, Hong Kong  
Tel: +852-2737-7688

### INDIA

**Yamaha Music India Private Limited**  
P-401, JMD Megapolis, Sector-48, Sohna Road,  
Gurugram-122018, Haryana, India  
Tel: +91-124-485-3300

### INDONESIA

**PT Yamaha Musik Indonesia Distributor**  
Yamaha Music Center Bldg. Jalan Jend. Gatot  
Subroto Kav. 4, Jakarta 12930, Indonesia  
Tel: +62-21-520-2577

### KOREA

**Yamaha Music Korea Ltd.**  
11F, Prudential Tower, 298, Gangnam-daero,  
Gangnam-gu, Seoul, 06253, Korea  
Tel: +82-2-3467-3300

### MALAYSIA

**Yamaha Music (Malaysia) Sdn. Bhd.**  
No.8, Jalan Perbandaran, Kelana Jaya, 47301  
Petaling Jaya, Selangor, Malaysia  
Tel: +60-3-78030900

### SINGAPORE

**Yamaha Music (Asia) Private Limited**  
Block 202 Hougang Street 21, #02-00,  
Singapore 530202, Singapore  
Tel: +65-6740-9200

### TAIWAN

**Yamaha Music & Electronics Taiwan Co., Ltd.**  
2F., No.1, Yuandong Rd., Banqiao Dist.,  
New Taipei City 22063, Taiwan (R.O.C.)  
Tel: +886-2-7741-8888

### THAILAND

**Siam Music Yamaha Co., Ltd.**  
3, 4, 15, 16th Fl., Siam Motors Building,  
891/1 Rama 1 Road, Wangmai,  
Pathumwan, Bangkok 10330, Thailand  
Tel: +66-2215-2622

### VIETNAM

**Yamaha Music Vietnam Company Limited**  
15th Floor, Nam A Bank Tower, 201-203 Cach  
Mang Thang Tam St., Ward 4, Dist.3,  
Ho Chi Minh City, Vietnam  
Tel: +84-28-3818-1122

### OTHER ASIAN REGIONS

[https://asia-latinamerica-mea.yamaha.com/  
index.html](https://asia-latinamerica-mea.yamaha.com/index.html)

## OCEANIA

### AUSTRALIA

**Yamaha Music Australia Pty. Ltd.**  
Level 1, 80 Market Street, South Melbourne,  
VIC 3205 Australia  
Tel: +61-3-9693-5111

### NEW ZEALAND

**Music Works LTD**  
P.O.Box 6246 Wellesley, Auckland 4680,  
New Zealand  
Tel: +64-9-634-0099

### REGIONS AND TRUST TERRITORIES IN PACIFIC OCEAN

[https://asia-latinamerica-mea.yamaha.com/  
index.html](https://asia-latinamerica-mea.yamaha.com/index.html)

**Head Office/Manufacturer: Yamaha Corporation** 10-1, Nakazawa-cho, Naka-ku, Hamamatsu, 430-8650, Japan

DMI30

**Importer (European Union): Yamaha Music Europe GmbH** Siemensstrasse 22-34, 25462 Rellingen, Germany

**Importer (United Kingdom): Yamaha Music Europe GmbH (UK)** Sherbourne Drive, Tilbrook, Milton Keynes, MK7 8BL, United Kingdom

Yamaha Global Site <https://www.yamaha.com/>

Yamaha Downloads <https://download.yamaha.com/>

Manual Development Group

© 2021 Yamaha Corporation

Published 7/2021 POIN-A1

VEF4780

## Free Manuals Download Website

<http://myh66.com>

<http://usermanuals.us>

<http://www.somanuals.com>

<http://www.4manuals.cc>

<http://www.manual-lib.com>

<http://www.404manual.com>

<http://www.luxmanual.com>

<http://aubethermostatmanual.com>

Golf course search by state

<http://golfingnear.com>

Email search by domain

<http://emailbydomain.com>

Auto manuals search

<http://auto.somanuals.com>

TV manuals search

<http://tv.somanuals.com>