

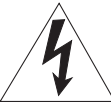

RX-V765

AV Receiver

IMPORTANT SAFETY INSTRUCTIONS



CAUTION

RISK OF ELECTRIC SHOCK

DO NOT OPEN



CAUTION: TO REDUCE THE RISK OF ELECTRIC SHOCK, DO NOT REMOVE COVER (OR BACK). NO USER-SERVICEABLE PARTS INSIDE. REFER SERVICING TO QUALIFIED SERVICE PERSONNEL.

• Explanation of Graphical Symbols



The lightning flash with arrowhead symbol, within an equilateral triangle, is intended to alert you to the presence of uninsulated “dangerous voltage” within the product’s enclosure that may be of sufficient magnitude to constitute a risk of electric shock to persons.



The exclamation point within an equilateral triangle is intended to alert you to the presence of important operating and maintenance (servicing) instructions in the literature accompanying the appliance.

Note to CATV system installer:

This reminder is provided to call the CATV system installer’s attention to Article 820-40 of the NEC that provides guidelines for proper grounding and, in particular, specifies that the cable ground shall be connected to the grounding system of the building, as close to the point of cable entry as practical.

- 1 Read these instructions.
- 2 Keep these instructions.
- 3 Heed all warnings.
- 4 Follow all instructions.
- 5 Do not use this apparatus near water.
- 6 Clean only with dry cloth.
- 7 Do not block any ventilation openings. Install in accordance with the manufacturer’s instructions.
- 8 Do not install near any heat sources such as radiators, heat registers, stoves, or other apparatus (including amplifiers) that produce heat.
- 9 Do not defeat the safety purpose of the polarized or grounding-type plug. A polarized plug has two blades with one wider than the other. A grounding type plug has two blades and a third grounding prong. The wide blade or the third prong are provided for your safety. If the provided plug does not fit into your outlet, consult an electrician for replacement of the obsolete outlet.
- 10 Protect the power cord from being walked on or pinched particularly at plugs, convenience receptacles, and the point where they exit from the apparatus.
- 11 Only use attachments/accessories specified by the manufacturer.
- 12 Use only with the cart, stand, tripod, bracket, or table specified by the manufacturer, or sold with the apparatus. When a cart is used, use caution when moving the cart/apparatus combination to avoid injury from tip-over.
- 13 Unplug this apparatus during lightning storms or when unused for long periods of time.
- 14 Refer all servicing to qualified service personnel. Servicing is required when the apparatus has been damaged in any way, such as power-supply cord or plug is damaged, liquid has been spilled or objects have fallen into the apparatus, the apparatus has been exposed to rain or moisture, does not operate normally, or has been dropped.



FCC INFORMATION (for US customers)

1 IMPORTANT NOTICE: DO NOT MODIFY THIS UNIT!

This product, when installed as indicated in the instructions contained in this manual, meets FCC requirements. Modifications not expressly approved by Yamaha may void your authority, granted by the FCC, to use the product.

2 IMPORTANT: When connecting this product to accessories and/or another product use only high quality shielded cables. Cable/s supplied with this product **MUST** be used. Follow all installation instructions. Failure to follow instructions could void your FCC authorization to use this product in the USA.

3 NOTE: This product has been tested and found to comply with the requirements listed in FCC Regulations, Part 15 for Class “B” digital devices. Compliance with these requirements provides a reasonable level of assurance that your use of this product in a residential environment will not result in harmful interference with other electronic devices.

This equipment generates/uses radio frequencies and, if not installed and used according to the instructions found in the users manual, may cause interference harmful to the operation of other electronic devices.

Compliance with FCC regulations does not guarantee that interference will not occur in all installations. If this product is found to be the source of interference, which can be determined by turning the unit “OFF” and “ON”, please try to eliminate the problem by using one of the following measures:

Relocate either this product or the device that is being affected by the interference.

Utilize power outlets that are on different branch (circuit breaker or fuse) circuits or install AC line filter/s.

In the case of radio or TV interference, relocate/reorient the antenna. If the antenna lead-in is 300 ohm ribbon lead, change the lead-in to coaxial type cable.

If these corrective measures do not produce satisfactory results, please contact the local retailer authorized to distribute this type of product. If you can not locate the appropriate retailer, please contact Yamaha Electronics Corp., U.S.A. 6660 Orangethorpe Ave, Buena Park, CA 90620.

The above statements apply **ONLY** to those products distributed by Yamaha Corporation of America or its subsidiaries.

Caution: Read this before operating your unit.

- 1 To assure the finest performance, please read this manual carefully. Keep it in a safe place for future reference.
- 2 Install this sound system in a well ventilated, cool, dry, clean place – away from direct sunlight, heat sources, vibration, dust, moisture, and/or cold. Allow ventilation space of at least 30 cm on the top, 20 cm on the left and right, and 20 cm on the back of this unit.
- 3 Locate this unit away from other electrical appliances, motors, or transformers to avoid humming sounds.
- 4 Do not expose this unit to sudden temperature changes from cold to hot, and do not locate this unit in an environment with high humidity (i.e. a room with a humidifier) to prevent condensation inside this unit, which may cause an electrical shock, fire, damage to this unit, and/or personal injury.
- 5 Avoid installing this unit where foreign objects may fall onto this unit and/or this unit may be exposed to liquid dripping or splashing. On the top of this unit, do not place:
 - Other components, as they may cause damage and/or discoloration on the surface of this unit.
 - Burning objects (i.e. candles), as they may cause fire, damage to this unit, and/or personal injury.
 - Containers with liquid in them, as they may fall and liquid may cause electrical shock to the user and/or damage to this unit.
- 6 Do not cover this unit with a newspaper, tablecloth, curtain, etc. in order not to obstruct heat radiation. If the temperature inside this unit rises, it may cause fire, damage to this unit, and/or personal injury.
- 7 Do not plug in this unit to a wall outlet until all connections are complete.
- 8 Do not operate this unit upside-down. It may overheat, possibly causing damage.
- 9 Do not use force on switches, knobs and/or cords.
- 10 When disconnecting the power cable from the wall outlet, grasp the plug; do not pull the cable.
- 11 Do not clean this unit with chemical solvents; this might damage the finish. Use a clean, dry cloth.
- 12 Only voltage specified on this unit must be used. Using this unit with a higher voltage than specified is dangerous and may cause fire, damage to this unit, and/or personal injury. Yamaha will not be held responsible for any damage resulting from use of this unit with a voltage other than specified.
- 13 To prevent damage by lightning, keep the power cord and outdoor antennas disconnected from a wall outlet or the unit during a lightning storm.
- 14 Do not attempt to modify or fix this unit. Contact qualified Yamaha service personnel when any service is needed. The cabinet should never be opened for any reasons.
- 15 When not planning to use this unit for long periods of time (i.e. vacation), disconnect the AC power plug from the wall outlet.
- 16 Install this unit near the AC outlet and where the AC power plug can be reached easily.
- 17 Be sure to read the “Troubleshooting” section on common operating errors before concluding that this unit is faulty.
- 18 Before moving this unit, press **(A) MAIN ZONE ON/OFF** to set this unit to the standby mode, and disconnect the AC power plug from the wall outlet in the main room.
- 19 **VOLTAGE SELECTOR** (Asia and General models only)
The **VOLTAGE SELECTOR** on the rear panel of this unit must be set for your local main voltage **BEFORE** plugging into the AC wall outlet. Voltages are:
 -AC 110/120/220/230–240 V, 50/60 Hz (General model)
 - AC 220/230–240 V, 50/60 Hz (Asia model)
- 20 The batteries shall not be exposed to excessive heat such as sunshine, fire or like.
- 21 Excessive sound pressure from earphones and headphones can cause hearing loss.
- 22 When replacing the batteries, be sure to use batteries of the same type. Danger of explosion may happen if batteries are incorrectly replaced.

WARNING

TO REDUCE THE RISK OF FIRE OR ELECTRIC SHOCK, DO NOT EXPOSE THIS UNIT TO RAIN OR MOISTURE.

As long as this unit is connected to the AC wall outlet, it is not disconnected from the AC power source even if you turn off this unit by **(A) MAIN ZONE ON/OFF**. In this state, this unit is designed to consume a very small quantity of power.

FOR CANADIAN CUSTOMERS

To prevent electric shock, match wide blade of plug to wide slot and fully insert.
This Class B digital apparatus complies with Canadian ICES-003.

POUR LES CONSOMMATEURS CANADIENS

Pour éviter les chocs électriques, introduire la lame la plus large de la fiche dans la borne correspondante de la prise et pousser jusqu'au fond.
Cet appareil numérique de la classe B est conforme à la norme NMB-003 du Canada.

IMPORTANT

Please record the serial number of this unit in the space below.

MODEL:

Serial No.:

The serial number is located on the rear of the unit. Retain this Owner's Manual in a safe place for future reference.

Contents

INTRODUCTION

PREPARATION

OPERATION

ADVANCED OPERATION

APPENDIX

English

INTRODUCTION

Features.....	2
About this manual.....	3
Supplied accessories.....	3
Part names and functions.....	4
Front panel.....	4
Rear panel.....	5
Front panel display.....	6
Remote control.....	7
Quick start guide.....	8

PREPARATION

Preparing remote control.....	9
Installing batteries in the remote control.....	9
Using the remote control.....	9
Connections.....	10
Placing speakers.....	10
Connecting speakers.....	11
Information on jacks and cable plugs.....	14
Connecting a video monitor.....	15
Connecting other components.....	16
Connecting a multi-format player or an external decoder.....	18
Connecting an external amplifier.....	18
Using REMOTE IN/OUT jacks.....	19
Connecting a Yamaha iPod universal dock or Bluetooth™ wireless audio receiver.....	19
Connecting a camcorder or portable audio player.....	19
Connecting the FM and AM antennas.....	20
Connecting the power cable.....	20
Turning this unit on and off.....	20
Optimizing the speaker setting for your listening room (YPAO).....	21
Using Auto Setup.....	21
When an error message is displayed during measurement.....	23
When a warning message is displayed after measurement.....	23

BASIC OPERATION

Playback.....	24
Basic procedure.....	24
Using the SCENE function.....	24
Muting audio output temporarily (MUTE).....	25
Adjusting high/low frequency sound (tone control).....	25
Enjoying pure hi-fi sound (Pure Direct mode).....	25
Using your headphones.....	26
Displaying input signal information.....	26
Changing information on the front panel display.....	26
Enjoy the sound field programs.....	27
Selecting sound field programs.....	27
Enjoying unprocessed input sources (Straight decoding mode).....	30
Enjoying sound field programs without surround speakers (Virtual CINEMA DSP).....	30
Enjoy sound field programs with headphones (SILENT CINEMA™).....	30
Enjoying more spatial sound fields (CINEMA DSP 3D mode).....	30
FM/AM tuning.....	31
Tuning into the desired FM/AM station (Frequency tuning mode).....	31
Registering FM/AM stations and tuning in (Preset tuning mode).....	31
XM® Satellite Radio tuning (U.S.A. model only).....	33
Connecting XM Mini-Tuner Home Dock.....	33
Activating XM Satellite Radio.....	33
XM Satellite Radio operations.....	34
Registering XM Satellite Radio channels.....	35
Displaying the XM Satellite Radio information.....	36

SIRIUS Satellite Radio™ tuning (U.S.A. model only).....	37
Connecting the SiriusConnect™ tuner.....	37
Activating SIRIUS Satellite Radio™ subscription.....	37
SIRIUS Satellite Radio™ operations.....	37
Registering the SIRIUS Satellite Radio™ channels.....	39
Setting the Parental Lock.....	40
Displaying the SIRIUS Satellite Radio™ information.....	41
Using iPod™.....	42
Controlling iPod™.....	42
Using Bluetooth™ components.....	44
Pairing the Bluetooth™ wireless audio receiver and your Bluetooth™ component.....	44
Playback of the Bluetooth™ component.....	44
Other functions.....	45
Using the sleep timer.....	45
Using the HDMI™ control function.....	45

ADVANCED OPERATION

Setting the option menu for each input source (OPTION menu).....	46
OPTION menu items.....	46
Outputting a video signal input from another input source during reproducing a multi-channel audio signal.....	48
Editing surround decoders/sound field programs.....	49
Setting sound field parameters.....	49
Sound field parameters.....	49
Changing various settings of this unit (SETUP menu).....	53
Basic operation of the SETUP menu.....	54
Speaker Setup.....	54
Sound Setup.....	56
Function Setup.....	57
DSP Parameter.....	59
Memory Guard.....	59
Using multi-zone configuration.....	60
Connecting Zone2.....	60
Controlling Zone2.....	61
Controlling other components with the remote control.....	62
Setting remote control codes.....	63
Resetting all remote control codes.....	63
Advanced setup.....	64

APPENDIX

Troubleshooting.....	66
General.....	66
HDMI™.....	69
Tuner (FM/AM).....	70
XM Satellite Radio (U.S.A. model only).....	70
SIRIUS Satellite Radio™ (U.S.A. model only).....	71
Remote control.....	72
iPod™.....	73
Bluetooth™.....	74
Auto Setup (YPAO).....	74
Glossary.....	77
Sound field program information.....	79
Information on HDMI™.....	79
Specifications.....	80
Index.....	81

(at the end of this manual)

List of remote control codes.....	i
-----------------------------------	---

INTRODUCTION

Features

■ Built-in 7-channel power amplifier

- Minimum RMS Output Power (20 Hz-20 kHz, 0.08% THD, 8 Ω)
- FRONT L/R: 95 W + 95 W
- CENTER: 95 W
- SURROUND L/R: 95 W + 95 W
- SURROUND BACK L/R: 95 W + 95 W

■ Speaker/Preout outputs

- Speaker jacks (7-channel + presence 2-channel), preout output jacks (7-channel, and subwoofer preout jack x 2)

■ Input/Output terminals

Input terminals

- HDMI input x 4
- Audio/Video input
 - [Audio] Digital input (coaxial) x 2, digital input (optical) x 2, analog input x 2
 - [Video] Component video x 2, composite video x 4
- Audio input (analog) x 2
- Multi-channel audio input x 1
- Dock input x 1
- V-AUX input
 - [Audio] Analog x 1, stereo mini jack x 1
 - [Video] Composite video x 1

Output terminals

- Monitor output
 - [Audio/Video] HDMI x 1
 - [Video] Component video x 1, Composite video x 1
- Audio/Video output
 - [Audio] Analog x 1
 - [Video] Composite video x 1
- Audio output
 - Analog x 1
- Zone2 output
 - Analog x 1

Other terminals

- Remote input x 1, Remote output x 1
- Trigger output x 1

■ Proprietary Yamaha technology for the creation of sound fields

- CINEMA DSP 3D
- Compressed Music Enhancer mode
- Virtual CINEMA DSP
- SILENT CINEMA™

■ Digital audio decoders

- Dolby TrueHD, Dolby Digital Plus
- DTS-HD Master Audio, DTS-HD High Resolution Audio, DTS Express
- Dolby Digital, Dolby Digital EX
- DTS, DTS 96/24, DTS-ES Matrix 6.1, DTS-ES Discrete 6.1

- Dolby Pro Logic, Dolby Pro Logic II, Dolby Pro Logic IIx
- DTS NEO:6
- Neural Surround (U.S.A. model only)
- DSD

■ Radio tuners

- FM/AM tuning capability
- XM Satellite Radio tuning capability, using XM Mini-Tuner and Home Dock, sold separately (U.S.A. model only)
- SIRIUS Satellite Radio tuning capability, using SiriusConnect tuner, sold separately (U.S.A. model only)

■ HDMI™

(High-Definition Multimedia Interface)

- HDMI interface for standard, enhanced or high-definition video as well as multi-channel digital audio
 - Automatic audio and video synchronization (lip sync) information capability
 - Deep Color video signal (30/36 bit) transmission capability
 - “x.v.Color” video signal transmission capability
 - High refresh rate and high resolution video signals capability
 - High definition digital audio format signals capability
- Analog video to HDMI digital video up-conversion (composite video → HDMI, component video → HDMI) capability for monitor out
- Analog video input up-scaling for HDMI digital video output 480i or 480p → 720p, 1080i or 1080p
- HDMI control capability

■ DOCK jack

- DOCK jack to connect a Yamaha iPod universal dock (such as YDS-11, sold separately) or Bluetooth wireless audio receiver (such as YBA-10, sold separately)



■ Automatic speaker setup features

- “YPAO” (Yamaha Parametric Room Acoustic Optimizer) for automatically optimizing speaker outputs suitable for listening environments

■ Other features

- 192-kHz/24-bit D/A converter
- OSD (on-screen display) menus that allow you to optimize this unit to suit your individual audiovisual system
- Pure Direct mode for pure hi-fi sound for all sources
- Adaptive dynamic range controlling capability
- SCENE function that allows you to change input sources and sound field programs with one key
- Sleep timer
- Multi-zone function

About this manual

- Some operations can be performed by using either the keys on the front panel or the ones on the remote control. In case the key names differ between the front panel and the remote control, the key name on the remote control is given in parentheses.
- This manual is printed prior to production. Design and specifications are subject to change in part as a result of improvements, etc. In case of differences between the manual and product, the product has priority.
- “**MAIN ZONE ON/OFF**” or “**HDMI 1**” (example) indicates the name of the parts on the front panel or the remote control. Refer to the “Controls diagram” or “Part names and functions” on page 4 for the information about each position of the parts.
-  indicates a tip for your operation.
-  indicates the page describing the related information.



Manufactured under license from Dolby Laboratories. Dolby, Pro Logic and the double-D symbol are trademarks of Dolby Laboratories.



Manufactured under license under U.S. Patent No's: 5,451,942;5,956,674;5,974,380;5,978,762;6,226,616;6,487,535 & other U.S. and worldwide patents issued & pending. DTS is a registered trademark and the DTS logos, Symbol, DTS-HD and DTS-HD Master Audio are trademark of DTS, Inc. © 1996-2007 DTS, Inc. All Rights Reserved.



Neural Surround™ name and related logos are trademarks owned by Neural Audio Corporation.

iPod™

“iPod” is a trademark of Apple Inc., registered in the U.S. and other countries.

Bluetooth™

Bluetooth is a registered trademark of Bluetooth SIG and is used by Yamaha in accordance with a license agreement.



“HDMI,” the “HDMI” logo and “High-Definition Multimedia Interface” are trademarks, or registered trademarks of HDMI Licensing LLC.

x.v.Color™

“x.v.Color” is a trademark of Sony Corporation.



“SILENT CINEMA” is a trademark of Yamaha Corporation.



SIRIUS, XM and all related marks and logos are trademarks of Sirius XM Radio Inc. and its subsidiaries. All rights reserved. **Service not available in Alaska and Hawaii.**

Supplied accessories

Check that you received all of the following parts.

- Remote control (see page 9)
- Batteries (AAA, R03, UM-4) x 2 (see page 9)
- Optimizer microphone (see page 21)
- AM loop antenna (see page 20)
- Indoor FM antenna (see page 20)
- Controls diagram

Part names and functions

Front panel

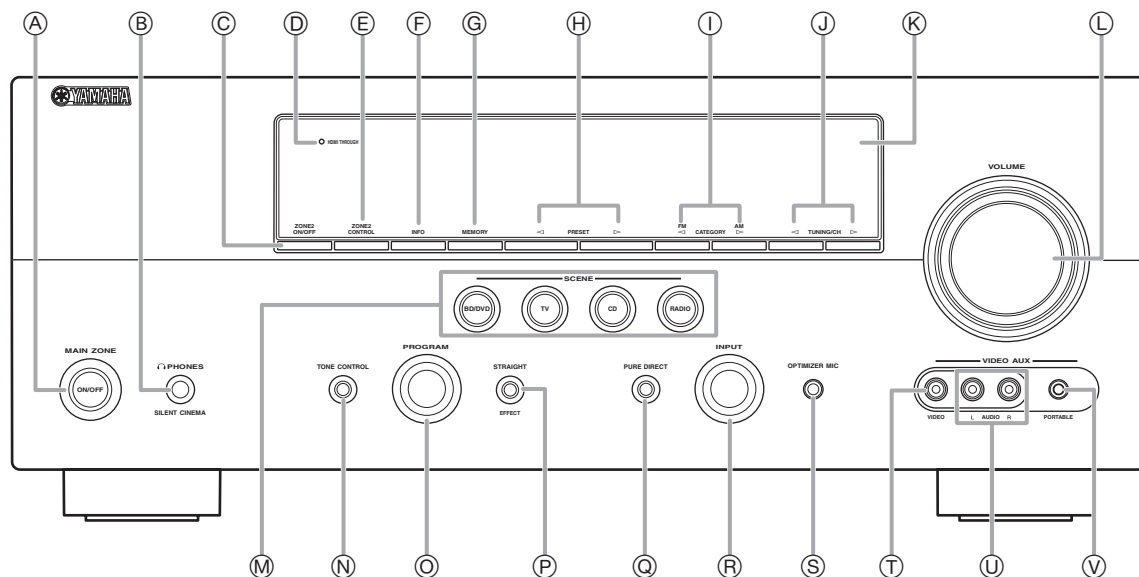

- A MAIN ZONE ON/OFF**
Turns this unit on and off (see page 20).
- B PHONES jack**
For connecting headphones (see page 26).
- C ZONE2 ON/OFF**
Switches Zone2 between on and off (see page 61).
- D HDMI THROUGH**
During standby, lights up under the following conditions:
- the HDMI control function is enabled (see page 57).
 - an HDMI signal input to this unit passes through this unit and output (see page 57).
- E ZONE2 CONTROL**
Enables operation of a receiver set in Zone2, including input source switching, volume control and tuner operation, with the main amplifier or remote control after this key is pressed.
- F INFO**
Changes information on the front panel display, such as input source and sound field program name (see page 26).
- G MEMORY**
Registers FM/AM stations as preset stations (see page 32) or XM/SIRIUS channels as preset channels (see page 35).
- H PRESET $\triangleleft / \triangleright$**
Selects an FM/AM preset station (see page 32) or an XM/SIRIUS preset channel (see page 35).
- I FM/AM (CATEGORY $\triangleleft / \triangleright$)**
Changes the tuner bands between FM and AM.
Select a channel category for a XM/SIRIUS.
- J TUNING/CH $\triangleleft / \triangleright$**
Changes FM/AM frequencies or XM/SIRIUS tuner channels.
- K Front panel display**
Displays information on this unit (see page 6).
- L VOLUME control**
Controls the volume of this unit (see page 24).
- M SCENE**
Switches between linked sets of input sources and sound field programs (see page 24).
- N TONE CONTROL**
Adjusts high-frequency/low-frequency output of speakers/headphones (see page 24).
- O PROGRAM selector**
Changes sound field programs (see page 27).
- P STRAIGHT**
Toggles between the selected sound field program and straight decoding mode (see page 30).
- Q PURE DIRECT**
Changes mode to Pure Direct mode (see page 25). This key lights up when Pure Direct mode is on.
- R INPUT selector**
Selects an input source (see page 24).
- S OPTIMIZER MIC jack**
For connecting the supplied optimizer microphone and adjusting output characteristics of speakers (see page 21).
- T VIDEO (VIDEO AUX) jack**
For connecting the video output cable of a camcorder or game console (see page 19).
- U AUDIO L/R (VIDEO AUX) jack**
For connecting the audio output cable of a camcorder or game console (see page 19).
- V PORTABLE (VIDEO AUX) jack**
For connecting the audio output cable of a portable music player (see page 19).

Rear panel

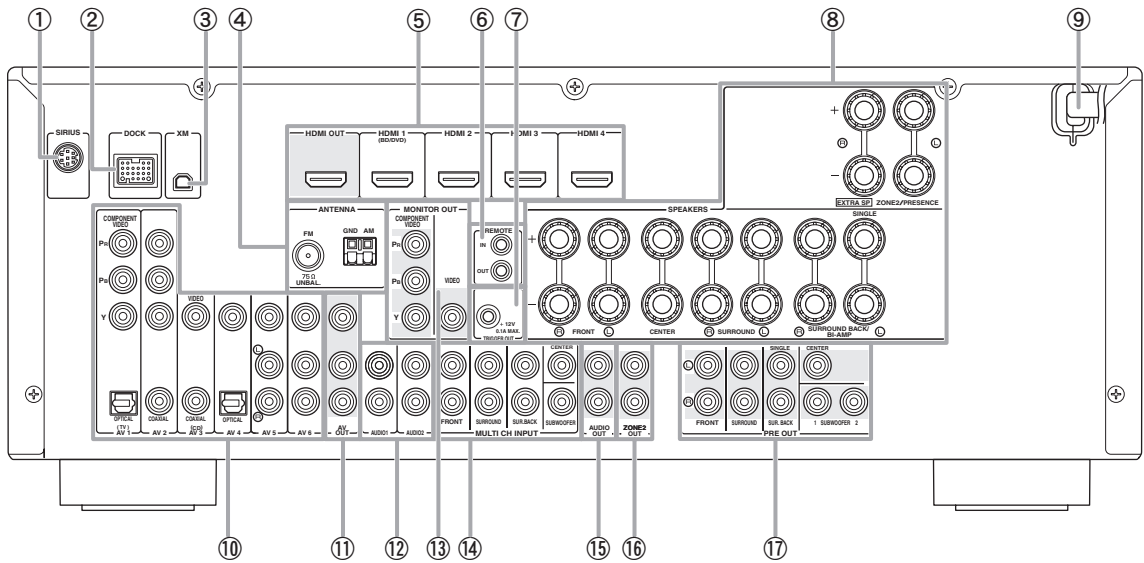

- ① **SIRIUS jack**
For connecting a SiriusConnect tuner (sold separately) (see page 37).
- ② **DOCK jack**
For connecting a Yamaha iPod universal dock (YDS-11, sold separately) or a Bluetooth wireless audio receiver (YBA-10, sold separately) (see page 19).
- ③ **XM jack**
For connecting XM Mini-Tuner in XM Mini-Tuner Home Dock (separately sold) (see page 33).
- ④ **ANTENNA jacks**
For connecting supplied FM and AM antennas (see page 20).
- ⑤ **HDMI OUT/HDMI 1-4 jacks**
For connecting an HDMI-compatible video monitor or external components for HDMI inputs 1-4 (see page 16).
- ⑥ **REMOTE IN/OUT jacks**
For connecting an external component that supports the remote control function (see page 19).
- ⑦ **TRIGGER OUT jack**
For connecting an external terminal with a trigger input terminal to operate it linked with operation of this unit. For example, when an electric screen that supports a trigger input is connected, it opens and closes linked with operation of an input source selected in this unit.
- ⑧ **SPEAKERS terminals**
For connecting front right and left, center, surround and surround back speakers (see page 11). Connect the presence speakers (see page 12) or the speakers for Zone2 (see page 60) to the EXTRA SP jacks.
- ⑨ **Power Cable**
Connect this cable to an AC wall outlet (see page 20).
- ⑩ **AV 1-6 jacks**
For connecting external components for audio/video inputs 1-6 (see page 16).
- ⑪ **AV OUT jacks**
Outputs audio/video signals from a selected analog input source to an external component (see page 17).
- ⑫ **AUDIO 1/2 jacks**
For connecting external components for audio inputs 1-2 (see page 17).
- ⑬ **MONITOR OUT terminals**
Outputs video signals from this unit to a video monitor, such as a TV (see page 15).
- ⑭ **MULTI CH INPUT terminals**
For connecting a player that supports a multi-channel output (see page 18).
- ⑮ **AUDIO OUT jacks**
Outputs audio signals from a selected analog input source to an external component (see page 17).
- ⑯ **ZONE2 OUT jacks**
Outputs sound of this unit to an external amplifier set in a different zone.
- ⑰ **PRE OUT terminals**
For connecting a subwoofer with built-in amplifier (see page 11) or an external power amplifier (see page 18).

Front panel display

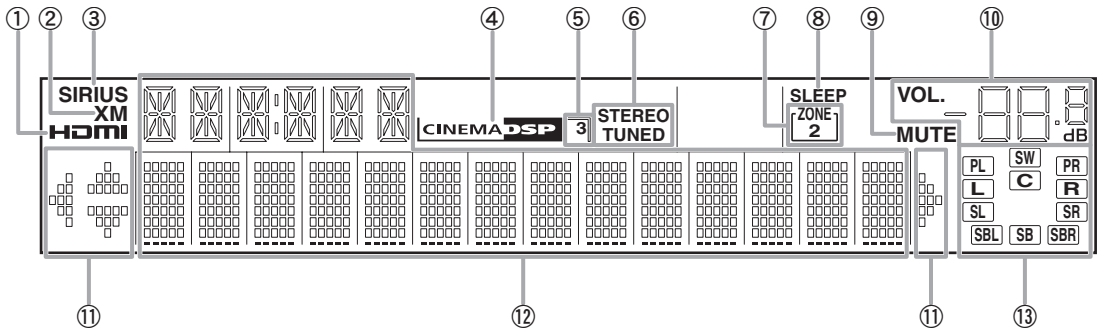

- ① **HDMI indicator**
Lights up during normal communication when HDMI is selected as an input source.
- ② **XM indicator**
Lights up when an XM tuner is selected as an input source.
- ③ **SIRIUS indicator**
Lights up when a SiriusConnect tuner is selected as an input source.
- ④ **CINEMA DSP indicator**
Lights up when a sound field program that uses CINEMA DSP is selected.
- ⑤ **CINEMA DSP 3D indicator**
Lights up when CINEMA DSP 3D is activated.
- ⑥ **Tuner indicator**
Lights up during receiving radio broadcast signals from an FM/AM station (see page 31).
- ⑦ **ZONE2 indicator**
Lights up when Zone2 is turned on (see page 60).
- ⑧ **SLEEP indicator**
Lights up when the sleep timer is activated (see page 45).
- ⑨ **MUTE indicator**
Flashes when audio is muted.
- ⑩ **VOLUME indicator**
Displays volume levels.
- ⑪ **Cursor indicators**
Light up when corresponding cursors on the remote control are available for operations.
- ⑫ **Multi information display**
Displays menu items and settings for the current operation.
- ⑬ **Speaker indicators**
Indicate speaker terminals from which signals are currently output.

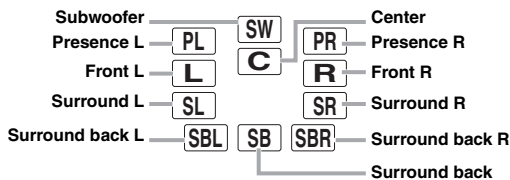

Remote control

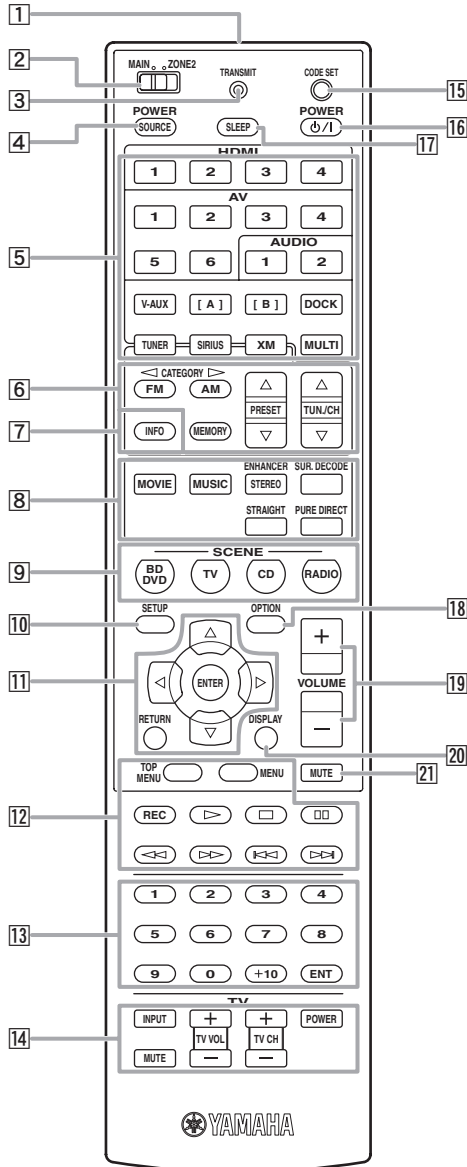

- 1 Remote control signal transmitter**
Transmits infrared signals.
- 2 MAIN/ZONE2**
Switches the zone to be operated by the remote control between the Main zone and Zone2 (see page 61).
- 3 TRANSMIT**
Lights up when a signal is output from the remote control.
- 4 SOURCE POWER**
Switches an external component on and off.
- 5 Input selection keys**
HDMI 1-4 Selects HDMI inputs 1 through 4.
AV 1-6 Selects AV inputs 1 through 6.
AUDIO 1/2 Selects AUDIO inputs 1 and 2.
V-AUX Selects the V-AUX jack on the front panel of this unit.

- [A]/[B]** To control external components using the **12 External component operation keys** separately from operations of this unit (see page 62).
- DOCK** Selects a Yamaha iPod universal dock/Bluetooth wireless audio receiver connected to the DOCK jack.
- TUNER** Selects the FM/AM tuner.
- SIRIUS** Selects a SiriusConnect tuner as an input source.
- XM** Selects an XM tuner as an input source.
- MULTI** Selects a signal input from the MULTI CH INPUT jack on the rear panel as an input source.

- 6 Tuner keys**
FM Select the FM band or AM band.
AM
(CATEGORY </> / >) Select a channel category for a XM/SIRIUS.
MEMORY Presets radio stations.
PRESET Δ / ∇ Select a preset station.
TUN./CH Δ / ∇ Change FM/AM frequencies or XM/SIRIUS tuner channels.
- 7 INFO**
Changes information on the front panel display, such as input source and sound field program name (see page 26).
- 8 Sound selection keys**
Selects sound field programs (see page 27).
- 9 SCENE**
Switches between linked sets of input sources and sound field programs (see page 24).
- 10 SETUP**
Displays the SETUP menu (see page 54).
- 11 Cursors Δ / ∇ / \leftarrow / \rightarrow / ENTER / RETURN**
Cursors Δ / ∇ / \leftarrow / \rightarrow Select menu items displayed on the front panel display or on a video monitor, or change settings.
ENTER Confirms a selected item.
RETURN Returns to the previous screen or ends the menu display.
- 12 External component operation keys**
Operate recording, playback etc. of external components (see page 62).
- 13 Numeric keys**
Enter numbers.
- 14 TV control keys**
Enables operations of a monitor such as a TV and a projector.
- 15 CODE SET**
Sets remote control codes for external component operations (see page 63).
- 16 POWER**
Switches this unit on and standby.
- 17 SLEEP**
Switches the sleep timer operations (see page 45).
- 18 OPTION**
Displays the OPTION menu (see page 46).
- 19 VOLUME +/-**
Adjust the volume of this unit (see page 24).
- 20 DISPLAY**
When XM or SIRIUS is selected as an input source: Displays or does not display the OSD on the video monitor.
When an iPod is connected: Changes the operation mode of the iPod connected to the Yamaha iPod universal dock (see page 42).
- 21 MUTE**
Turns the mute function of the sound output on and off (see page 25).

Quick start guide

When you use this product for the first time, perform the steps below. See the related pages for details of operations and settings.

Step 1: Prepare items for setup

Prepare speakers, DVD player, cables, and other items necessary for setup.

For example, prepare the following items for setting up a 7.1-channel sound system.

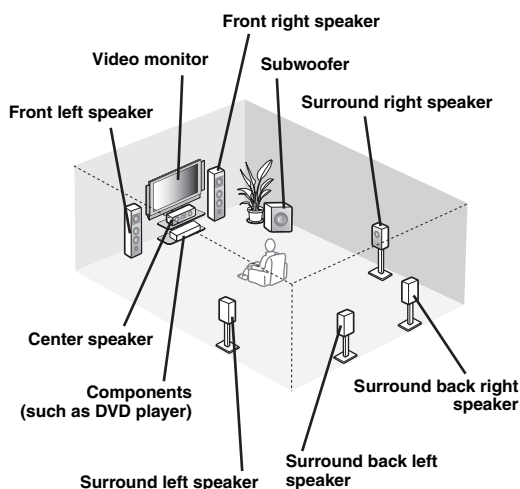

Requirements		qty.
Speakers	Front speaker	2
	Center speaker	1
	Surround speaker	2
	Surround back speaker	2
Active subwoofer		1
Speaker cable		5
Subwoofer cable		1
Reproduction component such as DVD player		1
Video monitor such as TV		1
Video cable or HDMI cable		2
Audio cable		2



- Prepare at least two (front) speakers. Speakers other than front speakers may be used in the following order of preference:
 - 1 Two surround speakers
 - 2 One center speaker
 - 3 One or two surround back speakers
- If your video monitor is a CRT, we recommend that you use magnetically shielded speakers.
- An audio cable is not required when you use an HDMI cable.

Step 2: Set up your speakers

Place your speakers in the room and connect them to this unit.

- **Placing speakers** P. 10
- **Connecting speakers** P. 11



- This unit has a YPAO (Yamaha Parametric Room Acoustic Optimizer) that automatically optimizes this unit based on room acoustic characteristics (audio characteristics of the speakers, speaker positions, and room acoustics, etc.). You can enjoy good balanced sound without special knowledge by using the YPAO technology (see page 21).

Step 3: Connect your components

Connect your TV, DVD player, or other components.

- **Connecting a video monitor** P. 15
- **Connecting other components** P. 16
- **Connecting a multi-format player or an external decoder** P. 18
- **Connecting an external amplifier** P. 18
- **Connecting a Yamaha iPod universal dock or Bluetooth wireless audio receiver** P. 19
- **Connecting the FM and AM antennas** P. 20
- **Connecting an XM Mini-Tuner Home Dock** P. 33
- **Connecting a SiriusConnect tuner** P. 37

Step 4: Turn on the power

Connect the power cable and turn on this unit.

- **Connecting the power cable** P. 20
- **Turning this unit on and off** P. 20

Step 5: Select the input source and start playback

Select the component connected in the step 3 as an input source and start playback.

- **Basic procedure** P. 24
- **Selecting sound field programs** P. 27



- This unit supports the SCENE function that changes the input source and sound field program at one time. Four SCENES are preset for different purposes for Blu-ray disc, DVD and CD. You can select a SCENE from those just by pressing a remote control key. See page 24 for details.

PREPARATION

Preparing remote control

Installing batteries in the remote control

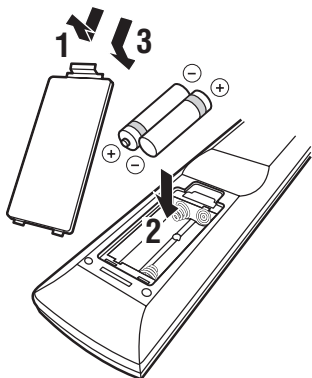

- 1** Take off the battery compartment cover.
- 2** Insert the two supplied batteries (AAA, R03, UM-4) according to the polarity markings (+ and -) on the inside of the battery compartment.
- 3** Snap the battery compartment cover back into place.

Notes

- Change all batteries if you notice the following conditions:
 - the operation range of the remote control narrows.
 - the transmit indicator does not flash or is dim.
- Do not use old batteries together with new ones.
This may shorten the life of the new batteries or cause old batteries to leak.
- Do not use different types of batteries (such as alkaline and manganese batteries) together. Specification of batteries may be different even though they look the same.
- If you find leaking batteries, discard the batteries immediately, taking care not to touch the leaked material. If the leaked material comes into contact with your skin or gets into your eyes or mouth, rinse it away immediately and consult a doctor. Clean the battery compartment thoroughly before installing new batteries.
- Dispose of the old batteries correctly in accordance with your local regulations.
- If the remote control is without batteries for more than 2 minutes, or if exhausted batteries remain in the remote control, the contents of the memory may be cleared. In such a case, install new batteries and set the remote control code.

Using the remote control

The remote control transmits a directional infrared ray. Be sure to aim the remote control directly at the remote control sensor on this unit during operation.

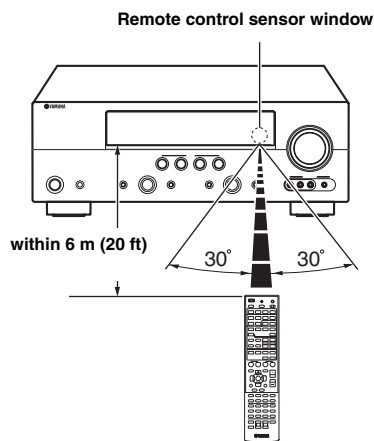

Notes

- Do not spill water or other liquids on the remote control.
- Do not drop the remote control.
- Do not leave or store the remote control in the following conditions:
 - places of high humidity, such as near a bath
 - places of high temperatures, such as near a heater or stove
 - places of extremely low temperatures
 - dusty places
- ☀️ You can operate external components with this remote control by setting the remote control code. See page 62 for details.

Placing speakers

This unit supports up to 7.1-channel surround playback. We recommend the following speaker layout in order to obtain the optimum surround effect.

7.1-channel speaker layout

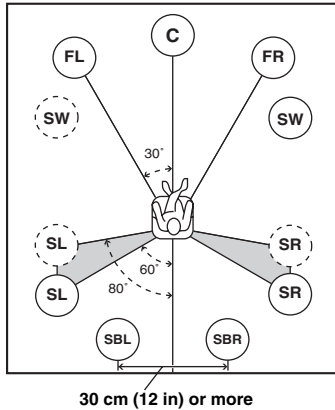

6.1-channel speaker layout

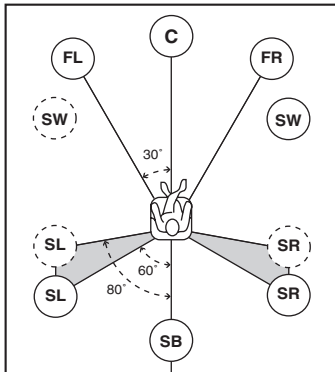

5.1-channel speaker layout

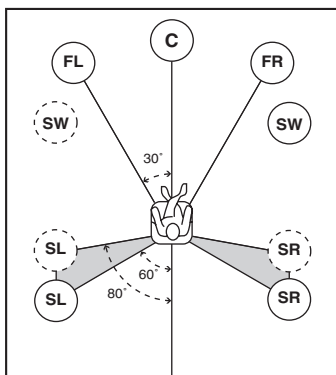

Speaker channels

■ Front left and right speakers (FL and FR)

The front speakers output the front channel sounds (stereo sound) and effect sounds. Place these speakers at an equal distance from the ideal listening position. When using a screen, the appropriate top positions of the speakers are about 1/4 of the screen from the bottom.

■ Center speaker (C)

The center speaker outputs the center channel sounds (dialog, vocals, etc.). Place it halfway between the left and right speakers. When using a TV, place the speaker just above or just under the center of the TV with the front surfaces of the TV and the speaker aligned. When using a screen, place it just under the center of the screen.

■ Surround left and right speakers (SL and SR)

The surround speakers output effect sounds and surround sounds. Place them at the rear left and rear right facing the listening position.

To obtain a natural sound flow in the 5.1-channel speaker layout, place them slightly further back than in the 7.1-channel speaker layout.

■ Surround back left and right speakers (SBL and SBR) / Surround back speaker (SB)

The surround back left and right speakers output rear effect sounds. Place them at the rear of the room facing the listening position at least 30 cm away from each other, ideally at the same distance as that between the front left and right speakers.

In the 6.1-channel speaker layout, surround back left and right channel sound signals are mixed down and output from the single surround back speaker.

In the 5.1-channel speaker layout, surround back left and right channel sound signals are output from the surround left and right speakers.

■ Subwoofer (SW)

The subwoofer speaker outputs bass sounds and low-frequency effect (LFE) sounds included in Dolby Digital and DTS signals. Use a subwoofer with a built-in amplifier, such as the Yamaha Active Servo Processing Subwoofer System. Place it exterior to the front left and right speakers facing slightly inward to reduce reflections from a wall.

Connecting speakers

When you connect speakers, connect them to the respective jacks as follows, according to your speaker layout.



- You can connect up to two subwoofers. When two subwoofers are connected, the same sound is output from them.

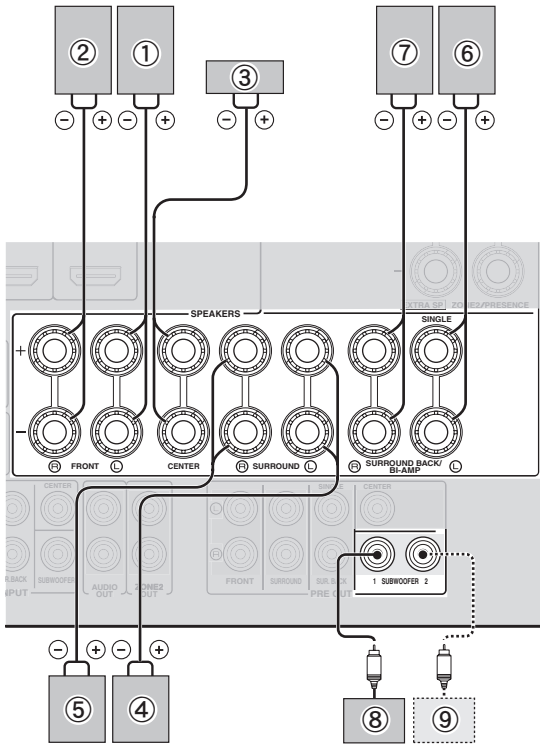

7.1-channel

Speakers	Jacks on this unit
① Front speaker L	FRONT (L)
② Front speaker R	FRONT (R)
③ Center speaker	CENTER
④ Surround speaker L	SURROUND (L)
⑤ Surround speaker R	SURROUND (R)
⑥ Surround back speaker L	SURROUND BACK/BI-AMP (L)
⑦ Surround back speaker R	SURROUND BACK/BI-AMP (R)
⑧ Subwoofer 1	SUBWOOFER 1
⑨ Subwoofer 2 (optional)	SUBWOOFER 2

6.1-channel

Speakers	Jacks on this unit
① Front speaker L	FRONT (L)
② Front speaker R	FRONT (R)
③ Center speaker	CENTER
④ Surround speaker L	SURROUND (L)
⑤ Surround speaker R	SURROUND (R)
⑥ Surround back speaker	SURROUND BACK/BI-AMP (SINGLE)
⑧ Subwoofer 1	SUBWOOFER 1
⑨ Subwoofer 2 (optional)	SUBWOOFER 2

5.1-channel

Speakers	Jacks on this unit
① Front speaker L	FRONT (L)
② Front speaker R	FRONT (R)
③ Center speaker	CENTER
④ Surround speaker L	SURROUND (L)
⑤ Surround speaker R	SURROUND (R)
⑧ Subwoofer 1	SUBWOOFER 1
⑨ Subwoofer 2 (optional)	SUBWOOFER 2

Presence speakers

You can connect presence speakers (PL/PR) that output front effect sounds to this unit. With CINEMA DSP sound field programs (see page 27) and their CINEMA DSP 3D functions, a sound with a richer and more spacial presence can be created. You can adjust the vertical position of center sound such as a dialog (see page 54).

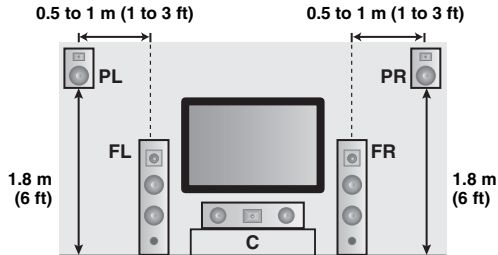

To use the presence speakers, connect them to the EXTRA SP jacks and set “Extra SP Assign” in “Speaker Setup” in the SETUP menu to “Presence” (see page 54).

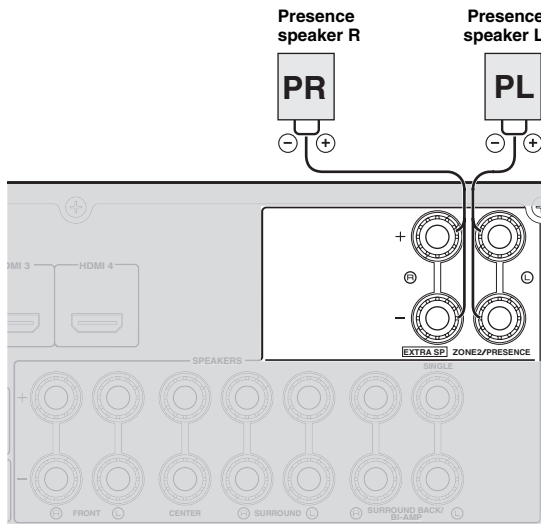

- Although you can connect both surround back speakers and presence speakers to this unit, you cannot output sounds from those speakers at the same time. This unit automatically selects speakers to output sounds according to the selected input source and sound field program.
- You can connect Zone2 speakers with a multi-zone function to the EXTRA SP jacks. For details, see page 60.

Connecting the speaker cable

Caution

- A speaker cable is a pair of insulated cables running side by side in general. One of the cables is colored differently or striped to indicate a polarity. Connect one end of the colored/striped cable to the “+” (red) terminal of this unit and the other end to that of your speaker, and connect one end of the other cable to the “-” (black) terminal of this unit and the other end to that of your speaker.
- Before connecting the speakers, be sure to disconnect the power cable.
- Do not let the bare speaker wires touch each other or any metal part of this unit. This could damage this unit and/or speakers. If the circuit shorts out, “CHECK SP WIRES!” appears on the front panel display when this unit is turned on.
- If your video monitor is a CRT, use magnetically shielded speakers. If images on the monitor are still distorted even when you use the magnetically shielded speakers, place the speakers away from the monitor.
- Use speakers with an impedance of 6-ohm or larger. Set speaker impedance in “ADVANCED SETUP” before connecting the speakers. You can also use 4-ohm speakers as the front speakers when you set “SP IMP” to “6ΩMIN” (see page 64).

- 1 Remove approximately 10 mm (0.4 in) of insulation from the end of each speaker cable and then twist bare wires of the cable together so that they will not cause a short circuits.

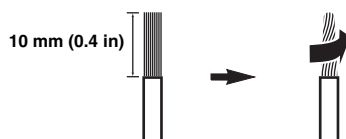

- 2 Loosen the knob, insert the twisted bare wires into the hole, and then tighten the knob.

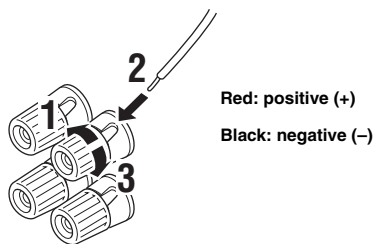

- You can connect the presence speakers (see page 12) or the speakers in the second zone (Zone2) (see page 60) to the EXTRA SP jacks.

Connecting the banana plug (Except U.K., Europe, Russian, Asia and Korea models)

Tighten the knob, and then insert the banana plug into the end of the terminal.

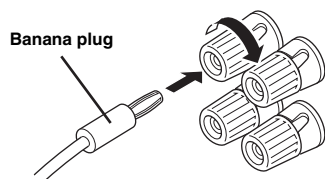

Using bi-amplification connections

You can connect speakers that support bi-amplification connections to this unit. To connect the speakers via a bi-amp connection, connect them to the FRONT jacks and SURROUND BACK/BI-AMP jacks as illustrated.

To enable the bi-amp connection, connect the power cable to the wall outlet, display the ADVANCED SETUP menu and set “BI AMP” to “ON” (see page 64).

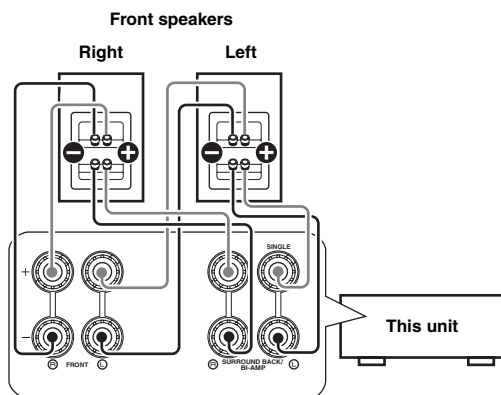

Caution

Before making bi-amplification connections, remove any brackets or cables that connect a woofer with a tweeter. Refer to the instruction manuals of speakers for details.

When not making bi-amplification connections, make sure that the brackets or cables are connected before connecting the speaker cables.

Note

- You cannot use surround back speakers or extra speakers (presence and Zone2 speakers) when bi-amplification connections are made.

Information on jacks and cable plugs

This unit has the following input and output jacks. Use jacks and cables appropriate for components that you are connecting.

■ Audio jacks

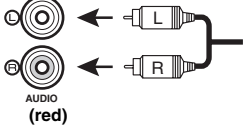
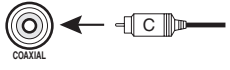
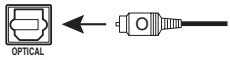
Jack and cables	Description
AUDIO jacks (white) 	To transmit conventional analog (stereo) signals. Use stereo pin cables. Connect red plugs to red jacks (R) and white plugs to white jacks (L).
COAXIAL jacks (orange) 	To transmit coaxial digital audio signals. Use pin cables for digital audio signals.
OPTICAL jacks 	To transmit optical digital audio signals. Use optical fiber cables for optical digital audio signals.

■ Video jacks

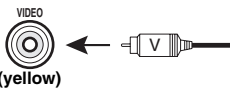
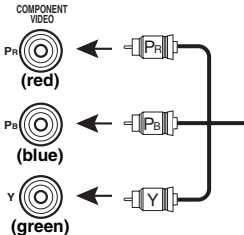
Jack and cables	Description
VIDEO jacks 	To transmit conventional composite video signals. Use video pin cables.
COMPONENT VIDEO jacks 	To transmit component video signals that include luminance (Y), chrominance blue (Pb) and chrominance red (Pr) components. Use component video cables.

■ Video/audio jacks

Jack and cables	Description
HDMI jacks 	To transmit digital video and digital audio signals. Use HDMI cables.



- We recommend that you use a commercially available 19-pin HDMI cable no longer than 5 meters (16 feet) with the HDMI logo printed on it.
- If you connect this unit to a component that has a DVI jack, an HDMI/DVI-D cable is required.
- You can check error information on HDMI connections (see page 79).

A video signal input to this unit is output from the jacks in MONITOR OUT for the same kind of signal as the input signal.

For example, if a VCR with a composite output signal and a DVD player with a component video output signal are connected, connect both VIDEO jack and COMPONENT VIDEO jack in MONITOR OUT to the video monitor.

If an HDMI input compatible monitor is connected, this unit automatically converts an analog signal that is input from a video input jack to a digital video signal, and then outputs it from the HDMI OUT jack.

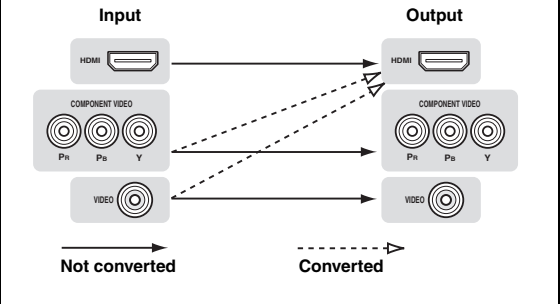

Connecting a video monitor

Connect a video monitor such as a TV or projector to an output jack of this unit. You can select one of the following three types according to the input signal format supported by the video monitor: HDMI OUT, COMPONENT VIDEO and VIDEO (composite video).

Note

- Make sure that this unit and video monitor are unplugged from the AC wall outlets.

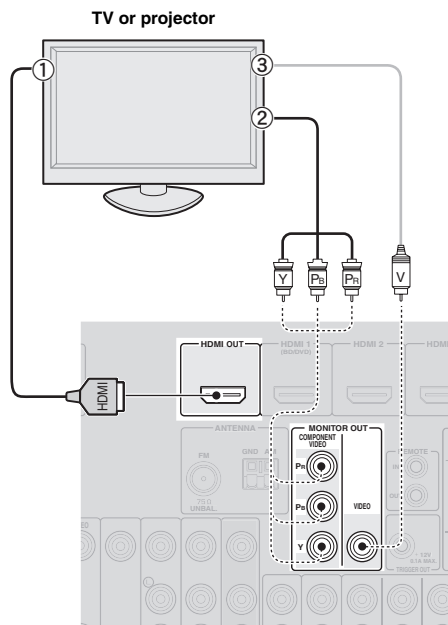

■ To connect an HDMI video monitor

Jacks on components	Jacks on this unit
① HDMI input	HDMI OUT



- This unit supports the HDMI control function. By connecting a TV that supports the HDMI control, operations of this unit can be controlled with the remote control of the TV. For details, see page 45.

■ To connect component video monitor

Note

- Only video signals input from this unit via the COMPONENT VIDEO jack are output from the COMPONENT VIDEO jack.

Jacks on components	Jacks on this unit
② Component video output	MONITOR OUT (COMPONENT VIDEO)

■ To connect composite video monitor

Note

- Only video signals input from this unit via the VIDEO jacks are output from the VIDEO jacks.

Jacks on components	Jacks on this unit
③ Video input (composite)	MONITOR OUT (VIDEO)

Outputting sound of a TV from this unit

To output sound of a TV from this unit, connect an audio output terminal of the TV to any of the AV 1-6 jacks. If the TV supports an optical digital output, we recommend that you use the AV 1. Connecting to the AV 1 allows you to switch an input source to the AV input 1 with a just a single key operation using the SCENE function (see page 24).

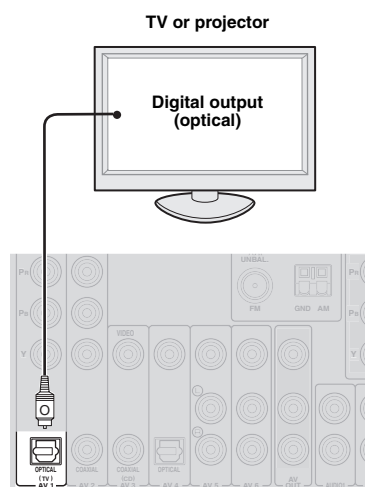

Note

- If the video monitor connected to this unit supports the HDMI control function, we recommend that you connect its audio output jack to the OPTICAL jack of the AV1 jacks of this unit. By doing so, this unit automatically turns on and "TV" of SCENE is automatically selected when you turn on the video monitor. You can obtain the same result even if you connect the audio output jacks to the AV2-6, AUDIO1-2 or V-AUX jacks by assigning those jacks to TV in advance (see page 24).

Connecting other components

This unit has input and output jacks for respective input and output sources. You can reproduce sound and movies from input sources selected with the front panel display or remote control.

Note

- Make sure that this unit and other components are unplugged from the AC wall outlets.

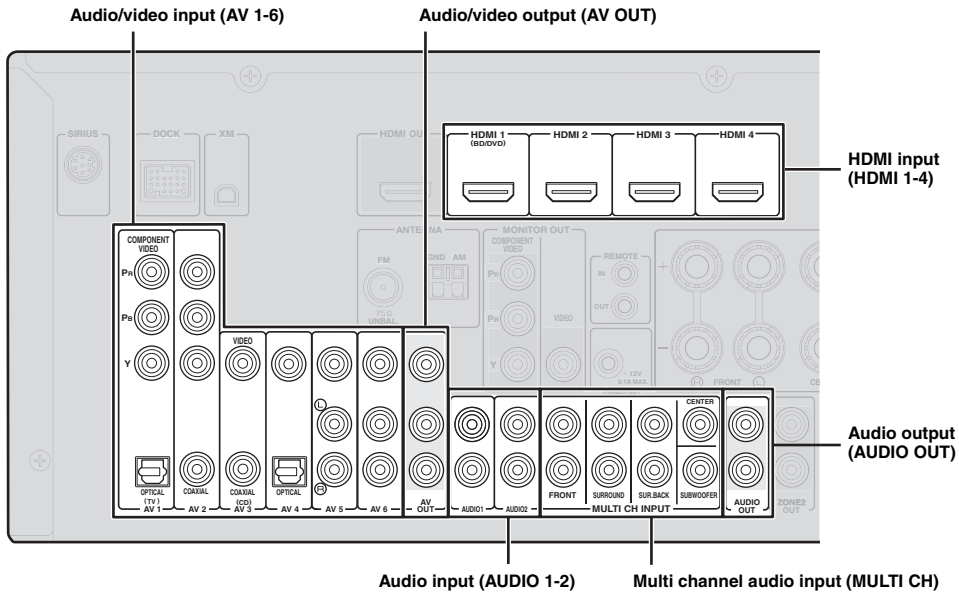

■ Audio and video player/Set-top box

Output jacks on the connected external component			Input sources/jacks of this unit	
External components	Signals	Output jacks		
External component with HDMI output	Audio/Video	HDMI output	HDMI1 (BD/DVD)	HDMI 1
			HDMI2	HDMI 2
			HDMI3	HDMI 3
			HDMI4	HDMI 4
External component with component video output	Audio Video	Optical digital output	AV1 (TV)	OPTICAL
		Component video output		COMPONENT VIDEO
	Audio Video	Coaxial digital output	AV2	COAXIAL
		Component video output		COMPONENT VIDEO
External component with composite video output	Audio Video	Coaxial digital output	AV3 (CD)	COAXIAL
		Composite video output		VIDEO
	Audio Video	Optical digital output	AV4	OPTICAL
		Composite video output		VIDEO
	Audio Video	Analog audio output	AV5	AUDIO
		Composite video output		VIDEO
Audio Video	Analog audio output Composite video output	AV6	AUDIO VIDEO	



- Input sources in parentheses are recommended to connect to the respective jacks. If a component is compatible with the SCENE function, you can switch the input source to that component with a single key operation using the SCENE function (see page 24).
- You can change the name of the input source displayed on the front panel display or the video monitor as necessary (see page 59).
- See page 60 on how to use ZONE2 OUT jack.

■ Audio player

Output jacks on the connected external component		Input sources/jacks of this unit	
External components	Output jacks		
External component with optical digital output	Optical digital output	AV 1 (TV)	OPTICAL
		AV 4	OPTICAL
External component with coaxial digital output	Coaxial digital output	AV 2	COAXIAL
		AV 3 (CD)	COAXIAL
External component with analog audio output	Analog audio output	AV 5	AUDIO
		AV 6	AUDIO
		AUDIO 1	AUDIO
		AUDIO 2	AUDIO



- We recommend connecting the coaxial digital output terminal of a CD player to the AV3 jack.

About audio/video output jacks

Among the analog audio and analog video signals input to this unit via input terminals, the audio/video signals of the selected input sources are output from the AV OUT jack and AUDIO OUT jack. An HDMI input signal, COMPONENT VIDEO input signal or digital audio input signal cannot be output. When using the AV OUT jacks or AUDIO OUT jacks, connect them as follows:

When using the AV OUT jacks: connect them to composite video and analog audio input jacks of an external component.

When using the AUDIO OUT jacks: connect them to analog audio jacks of an external component.

Connecting a multi-format player or an external decoder

This unit has 8 sets of input jacks (FRONT L/R, CENTER, SURROUND L/R, SUR. BACK and SUBWOOFER) to input multi-channel analog sound signals. If your playback component, such as a DVD player or SACD player, has multi-channel analog output capability, you can enjoy up to 7.1-channel multi-channel sound. To output multi-channel sound, connect the audio output jacks of your playback component to the MULTI CH INPUT jacks of this unit, and set the input source of this unit to "MULTI CH." For details on how to change input sources, see page 24.

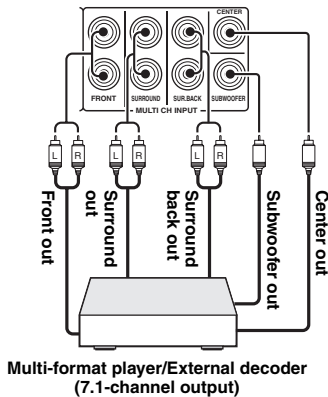

Notes

- When you select "MULTI CH" as the input source, the digital sound field processor is automatically disabled.
- Since this unit does not redirect signals input at the MULTI CH INPUT jacks to accommodate for missing speakers, connect at least a 5.1-channel speaker system when using this feature.
- When the input source is switched to "MULTI CH," images input from a component connected to "AV1-6" or "V-AUX" can be displayed on a video monitor (see page 48). If your DVD player does not support multi-channel digital output, connect it to these input jacks.

Connecting an external amplifier

The same channel signals are output from the jacks of the PRE OUT terminals as from their corresponding SPEAKERS terminals. When connecting an external power amplifier (pre-main amplifier) to enhance speaker output, connect the input terminals of the power amplifier to the PRE OUT terminals of this unit.

Note

- When a component is connected to the PRE OUT terminals, do not connect speakers to the SPEAKERS terminals corresponding to those PRE OUT terminals.

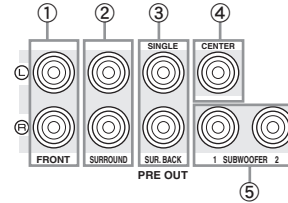

- FRONT (PRE OUT) jacks**
Front channel output jacks.
 - SURROUND (PRE OUT) jacks**
Surround channel output jacks.
 - SUR. BACK (PRE OUT) jacks**
Surround back output jacks. When you only connect one external amplifier for the surround back channel, connect it to the SUR. BACK (SINGLE) jack.
- ☼
- To output surround back channel signals through these jacks, set "Sur.B L/R SP" to any parameter except for "None" in "Speaker Setup" (see page 55).
- CENTER (PRE OUT) jack**
Center channel output jack.
 - SUBWOOFER (PRE OUT) 1/2 jack**
Connect a subwoofer with a built-in amplifier. When two subwoofers are connected, the same sound is output from them.

Using REMOTE IN/OUT jacks

When the components are the Yamaha products and have the capability of the transmission of the remote control signals, connect the REMOTE IN and REMOTE OUT jacks to the remote control input and output jack with the monaural analog mini cable as follows.

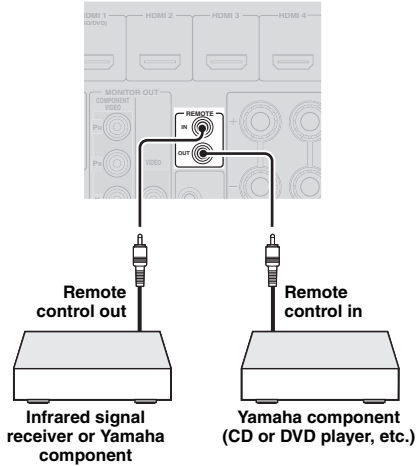

- If your Yamaha component supports the SCENE link playback function, remote connection automatically starts playback when you press **SCENE** (or **SCENE**) to select a SCENE.
- If the component connected to the REMOTE OUT jack is not a Yamaha product, set "SCENE IR" in the ADVANCED SETUP menu to "OFF" (see page 64).

Connecting a Yamaha iPod universal dock or Bluetooth™ wireless audio receiver

This unit has the DOCK jack, to which you can connect a Yamaha iPod universal dock (YDS-11, sold separately) or a Bluetooth wireless audio receiver (YBA-10, sold separately). You can play an iPod or a Bluetooth component with this unit by connecting it to the DOCK jack.

Use a dedicated cable for connection between the dock/receiver and this unit.

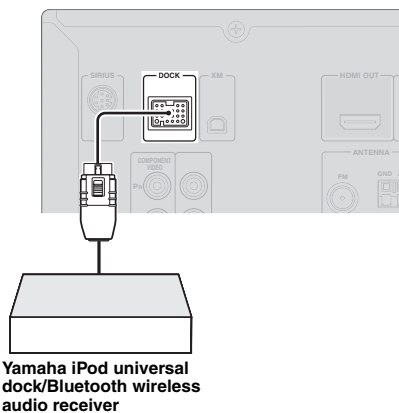

Connecting a camcorder or portable audio player

The V-AUX terminals on the front panel are useful for connecting a camcorder, a game console or a portable music player to this unit. Be sure to turn down the volume of this unit and other components before making connections.

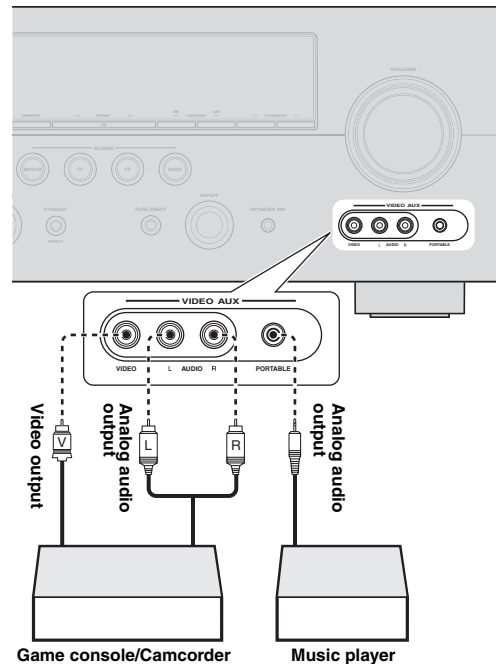

- To connect a component to the PORTABLE jack, use a 3.5 mm stereo mini plug cable.
- When external components are connected both the PORTABLE jack and AUDIO jack, sound input from the PORTABLE jack is output.

Connecting the FM and AM antennas

An indoor FM antenna and an AM loop antenna are supplied with this unit. Connect these antennas properly to the respective jacks.

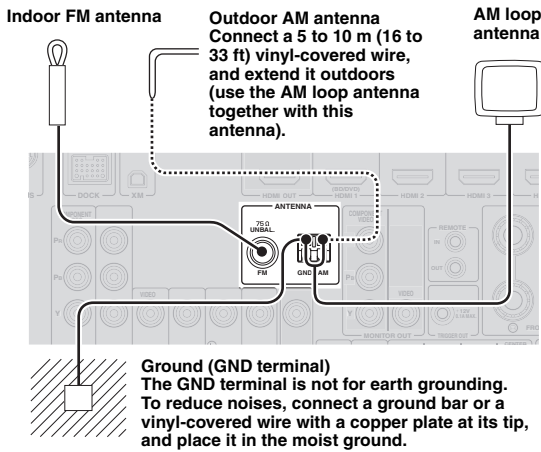

- The supplied antennas are normally sensitive enough to obtain good reception.
- Position the AM loop antenna away from this unit.
- If you cannot get good reception, we recommend that you use an outdoor antenna. For more details, consult the nearest authorized Yamaha dealer or service center.
- Always use the AM loop antenna even when the outdoor antenna is connected.

Assembling the AM loop antenna

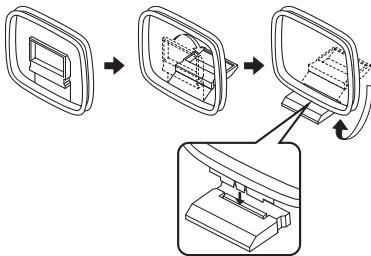

Connecting the AM loop antenna

The wires of the AM loop antenna have no polarity. You can connect either wire to the AM terminal and the other to the GND terminal.

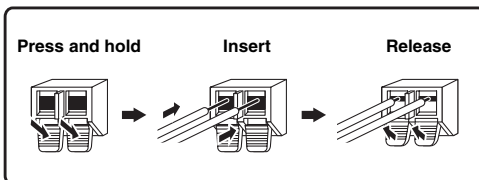

Connecting the power cable

After all connections are complete, plug the AC power cable of this unit into an AC wall outlet.

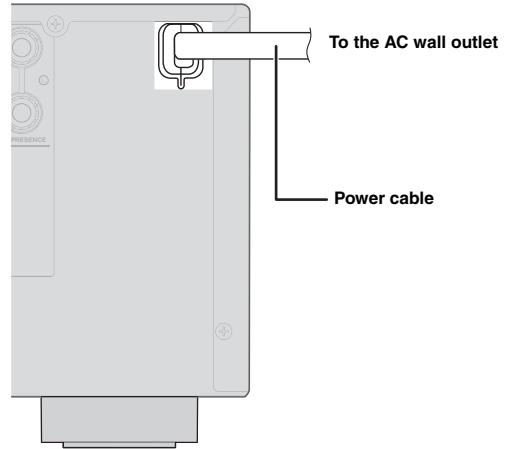

Turning this unit on and off

- 1 Press **(A) MAIN ZONE ON/OFF** (or **(16) POWER**) to turn on this unit.
- 2 Press **(A) MAIN ZONE ON/OFF** (or **(16) POWER**) again to turn off this unit (standby).



- The unit needs a few seconds until ready to play back.
- You can also turn on this unit by pressing **(M) SCENE** (or **(9) SCENE**).
- This unit consumes a small amount of electricity even during standby. We recommend disconnecting the power cable from the AC wall outlet.

Caution

Do not unplug this unit while it is turned on. Doing so may damage this unit or cause the settings of this unit to be saved incorrectly.

Optimizing the speaker setting for your listening room (YPAO)

This unit has a Yamaha Parametric Room Acoustic Optimizer (YPAO). With the YPAO, this unit automatically adjusts the output characteristics of your speakers based on speaker position, speaker performance, and the acoustic characteristics of the room. We recommend that you first adjust the output characteristics with the YPAO when you use this unit.

Notes

- Loud test tones may be output during the automatic setup procedure. Do not allow small children to enter the room during the procedure.
- To achieve the best results, make sure the room is as quiet as possible while the automatic setup procedure is in progress. If there is too much ambient noise, the results may not be satisfactory.



- You can manually adjust the output characteristics of your speakers with “2 Manual Setup” in the SETUP menu. For details, see page 54.

“MIC ON. View OSD MENU” appears on the front panel display. The following menu screen appears on the video monitor.

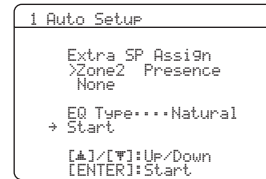

- You can bring up the above menu screen from the SETUP menu (see page 54).

Using Auto Setup

1 Check the following points.

Before starting the automatic setup, check the following.

- All speakers and subwoofer are connected properly.
- Headphones are disconnected from this unit.
- The video monitor is connected properly.
- This unit and the video monitor are turned on.
- This unit is selected as the video input source of the video monitor.
- The connected subwoofer is turned on and the volume level is set to about half way (or slightly less).
- The crossover frequency controls of the connected subwoofer are set to the maximum.

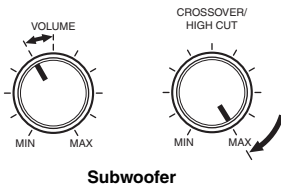

2 Connect the supplied optimizer microphone to the OPTIMIZER MIC jack on the front panel.

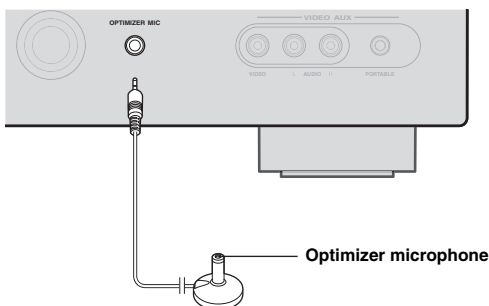

3 Place the optimizer microphone at your normal listening position on a flat level surface with the omni-directional microphone heading upward.

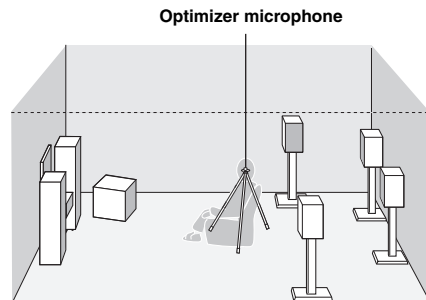

- It is recommended that you use a tripod or something similar to fix the optimizer microphone at the same height as your ears would be when seated in your listening position. You can fix the optimizer microphone to the tripod with the attaching screw of the tripod.

4 When the speakers are connected to EXTRA SP jacks, press **[Cursor]** repeatedly to select “Extra SP Assign,” and then press **[Cursor]** to select how to use EXTRA SP jacks from “Zone2,” “Presence” or “None.”

If this unit does not work when you press **[Cursor]**, press **[SETUP]** once and then operate this unit.

5 To select a sound character for adjustment, press [F1]Cursor ▾ to select “EQ Type” and then press [F1]Cursor </>.

If this unit does not work when you press [F1]Cursor, press [F10]SETUP once and then operate this unit. This unit has a parametric equalizer that adjusts the output levels for each frequency range. The equalizer is adjusted to produce a cohesive sound field based on automatically measured speaker characteristics. In “EQ Type,” you can select the following parametric equalizer characteristics suitable for the desired sound characteristics.

Natural

Adjusts all speakers to achieve natural sound. Select this if sounds in the high frequency range seem too strong when “EQ Type” is set to “Flat.”

Flat

Adjusts each speaker to obtain the same characteristics. Select this if your speakers have similar qualities.

Front

Adjusts each speaker to obtain the same characteristics as the front left and right speakers. Select this if your front left and right speakers have significantly better qualities than the other speakers.

6 Press [F1]Cursor ▾ to select “Start” and then press [F1]ENTER to start the setup procedure.

A countdown starts and a measurement starts in 10 seconds. A loud test tone is output during measurement.

Notes

- During the automatic setup procedure, do not perform any operation on this unit.
- To cancel the automatic setup procedure, press [F1]Cursor △.

Measurement takes about 3 minutes. To obtain precise results, stay where you will not disturb the measurement, such as to the side of or behind the speakers or outside the room.

When measurement is successfully completed, “YPAO Complete” appears on the front panel display and the results appear on the video monitor.

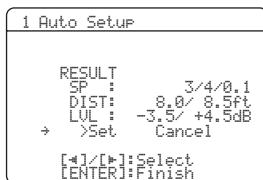

SP

Displays the number of speakers connected to this unit in the following order:
Total of Front, Center, and Presence/Total of Surround and Surround Back/Subwoofer

DIST

Displays the speaker distance from the listening position in the following order:

Closest speaker distance/Farthest speaker distance

LVL

Displays the speaker output levels in the following order:

Lowest speaker output level/Highest speaker output level

Notes

- If “ERROR” appears on the video monitor during the automatic setup procedure, measurement is canceled and the type of error is displayed. For details, see “When an error message is displayed during measurement” (see page 23).
- If problems occur during measurement, “WARNING (XX)” (xx indicates the number of warning) appears above “RESULT” (see page 23).

7 Press [F1]ENTER.

The speaker characteristics are adjusted according to measurement results.

To cancel the operation, press [F1]Cursor </> to select “Cancel” and press [F1]ENTER.

When the following screen appears, remove the optimizer microphone. The automatic setup procedure is now complete.



The optimizer microphone is sensitive to heat. Store it in a cool place and away from direct sunlight after measurement. Do not leave it in a place where it will be subjected to high temperatures such as on an AV component.

☀

- If you do not want to apply the measurement results, select “Cancel.”
- Perform the automatic setup procedure again if you change the number or positions of speakers.
- If you press [F1]ENTER before removing the optimizer microphone, “1 Auto Setup” of “Speaker Setup” in the SETUP menu (see page 54) is displayed.

When an error message is displayed during measurement

Press **[F1]Cursor** **▽** once, and select “Retry” or “Exit” using **[F1]Cursor** **</>** and then press **[F1]ENTER**.

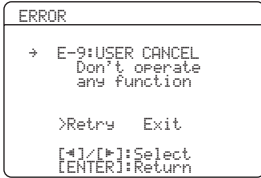

Retry

Performs the automatic setup procedure again.

Exit

Terminates the measurement and the automatic setup procedure.



- See page 74 for details on error messages.
- When “E-5:NOISY” appears, you can continue measurement. To continue measurement, select “Proceed.” However, we recommend that you solve the problem first and then perform measurement again.

When a warning message is displayed after measurement

If a problem occurs during measurement, “WARNING” is displayed on the result display screen. Check the error and solve the problems.

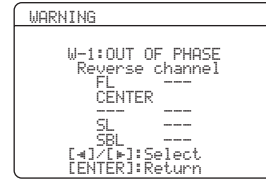

- See page 75 for details on warning messages.
- Optimization will not be performed while a warning message is displayed. We recommend that you solve the problem and perform the automatic setup procedure again.

1 If “→” is displayed on the left of “WARNING” on the result display screen, press **[F1]ENTER**.

Details of the warning message are displayed. If there are multiple warning messages, you can display the next message using **[F1]Cursor** **>**.

2 To return to the top result display, press **[F1]ENTER** again.

BASIC OPERATION

Playback

Basic procedure

- 1 Turn on external components (TV, DVD player, etc.) connected to this unit.
- 2 Rotate the **INPUT selector** (or press the **Input selection keys**) to select an input source.

The name of the selected input source is displayed for a few seconds.

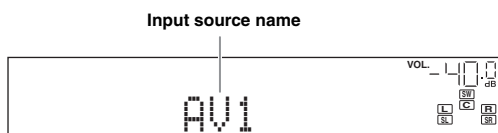

- You can change the input source name displayed on the front panel display or on the video monitor as necessary (see page 59).

- 3 Play the external component that you have selected as the source input, or select a radio station on the tuner.

Refer to the instruction manuals provided with the external component for details on playback. For selecting radio stations or playback of an iPod or Bluetooth component using this unit, see the following.

- FM/AM radio tuning (see page 31)
- XM/SIRIUS Satellite Radio tuning (see page 33 and 37)
- Using iPod (see page 42)
- Using Bluetooth components (see page 44)

- 4 Turn the **VOLUME control** to adjust the volume (or press **VOLUME +/-**).

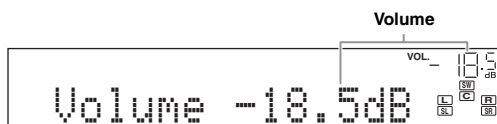

Note

When you play back a DTS-CD, noise may be output in some conditions, which may cause a speaker malfunction. Make sure that the volume is set to low before starting playback. If noise is output, do the following.

- 1) When only noise is output

If a DTS bitstream signal is not properly input to this unit, only noise is output. Connect the playback component to this unit by digital connection and play back the DTS-CD. If the condition is not improved, the problem may result from the playback component. Consult the manufacturer of the playback component.

- 2) When noise is output during playback or skip operation

Before playing back the DTS-CD, display the OPTION menu after selecting the input source and set "Decoder Mode" to "DTS" (see page 47).

Using the SCENE function

This unit has four SCENE keys that allow you to change input sources and sound field programs with one key. A set of input source and sound program suitable for a certain situation, such as playing back movies or music, is assigned to each key by default.

	Input source	Sound field program
BD/DVD	HDMI1	Straight
TV	AV1	Straight
CD	AV3	Straight
RADIO	TUNER	7ch Enhancer



- This unit turns on when **SCENE** (or **SCENE**) is pressed during standby.
- If a Yamaha DVD player that can receive SCENE control signals is connected to the REMOTE OUT jack of this unit, the DVD player automatically turns on and starts playback when **SCENE** (or **SCENE**) is pressed (see page 19). For details, refer to the instruction manual of the DVD player.

Selecting a SCENE

Press **SCENE** (or **SCENE**).

Registering input source/sound field program

Select the desired input source/sound field program, and press down **Ⓜ**SCENE (or **ⓑ**SCENE) until “SET Complete” appears on the front panel display.

When the OSD is displayed on the video monitor, “SCENE Setting Complete” appears on the video monitor.



- If you are using the remote control for an external component, set that external component too whenever SCENE setting is performed. For more details, see the next section.

Switching remotely controlled external components linked to SCENE selections

You can operate an external component with the remote control of this unit by setting a remote control code for the external component for each input source. Setting remote control codes for desired input sources allows you to switch between external components linked to SCENE selections.

When you change the SCENE key settings, change settings of the external component as well by following the steps below.

- 1 Register the remote control code of an external component to the desired input source (see page 62).

Note

- Remote control codes cannot be registered to TUNER, SIRIUS, or XM input sources.

- 2 Press **ⓓ**Input selection keys on the remote control for the input source whose remote control code was registered in step 1 for about 3 seconds while pressing down **ⓑ**SCENE key whose assignment you want to change.

The external component can now be controlled remotely just by selecting the **ⓑ**SCENE key.

Muting audio output temporarily (MUTE)

- 1 Press **ⓓ**MUTE on the remote control to mute the audio output.

The MUTE indicator on the front panel display flashes while audio output is muted.

- 2 Press **ⓓ**MUTE again to resume audio output.

Adjusting high/low frequency sound (tone control)

You can adjust the balance of the high frequency range (Treble) and low frequency range (Bass) of sounds output from the front left and right speakers to obtain desired tone.



- The tone control of the speakers or headphones can be set separately. Set the headphone tone control with the headphones connected.

- 1 Press **Ⓝ**TONE CONTROL on the front panel repeatedly to select “Treble” or “Bass.”

The current setting is displayed on the front panel display.



- 2 Rotate the **Ⓞ**PROGRAM selector to adjust the output level in those frequency ranges.

Adjustable range: -10.0 dB to +10.0 dB

The display returns to the previous screen soon after you release the selector.

Notes

- The tone control settings are not effective during playback in Pure Direct mode.
- If you set the balance extremely off, sounds may not match those from other channels well.

Enjoying pure hi-fi sound (Pure Direct mode)

Use Pure Direct mode to enjoy the pure high fidelity sound of the selected source. When Pure Direct mode is activated, this unit plays back the selected source with the least circuitry.

Press **Ⓞ**PURE DIRECT (or **ⓓ**PURE DIRECT) to turn the Pure Direct mode on or off.

The following features are disabled in Pure Direct mode.

- sound field program and tone control
- display and operation of the OPTION menu and SETUP menu
- multi-zone function



- The front panel display turns off in Pure Direct mode. It turns on again when Pure Direct mode is turned off.

Using your headphones

Plug your headphones in the **ⓑPHONES** jack on the front panel.

When you select a sound field program while using the headphones, the mode is automatically set to SILENT CINEMA mode.

Notes

- When you connect headphones, no signals are output from the SPEAKERS terminals.
- When multi-channel signals are processed, sounds in all channels are divided to left and right channels. When the input source is set to "MULTI CH," only front L/R sound is output from the headphones.

Displaying input signal information

When HDMI-4 or AV1-4 is selected as the input source, you can display audio/video signal information.



- Input signal information is displayed on both a video monitor and the front panel display.

1 Select the desired input source, and press **18**OPTION.

The OPTION menu for the selected input source is displayed (see page 46).

2 Press **11**Cursor Δ / ∇ to select "Signal Info," and press **11**ENTER.

Information on input signals is displayed. See page 47 on information displayed on the screen.



- You can change items of information displayed on the front panel display using **11**Cursor Δ / ∇ .
- If an HDMI related error occurs, error information is displayed at the bottom of the screen.

3 To end the information display, press **18**OPTION.

Changing information on the front panel display

You can display information on the front panel display such as the names of the currently selected sound field program and surround decoders on the front panel display. To change the display, press **ⓔ**INFO (or **7**INFO) repeatedly. The following information can be displayed on the front panel display.

- Currently selected input source name (Input)
- Currently selected sound field program name (DSP Program)
- Currently selected surround decoder (Audio Decoder)
- Currently set FM/AM tuner frequency (Frequency)
- XM/SIRIUS tuner information (Channel, Category, Artist/Song, Antenna, Composer)
- iPod playback information (Song, Album, Artist, List)

For example, if you select HDMI1 and display "DSP Program," the following screen appears on the front panel display.

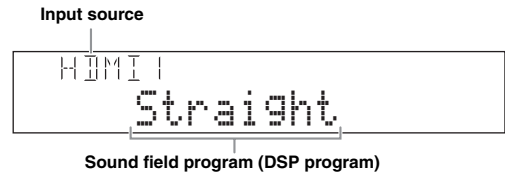

The information on each input source that can be displayed is shown in the table below.

Input source	Items
HDMI-4	Input DSP Program Audio Decoder
AV1-6	
AUDIO1-2	
V-AUX	
MULTI CH	Input
FM/AM	Frequency DSP Program Audio Decoder
XM	Channel
SIRIUS	Category Artist/Song Composer (SIRIUS only) Antenna DSP Program Audio Decoder
iPod (Simple remote mode)	Input DSP Program Audio Decoder
iPod (Menu browse mode)	(Play information display) Artist Album Song DSP Program Audio Decoder (Play menu display) List
Bluetooth	Input DSP Program Audio Decoder

Enjoy the sound field programs

This unit is also equipped with a Yamaha digital sound field processing (DSP) chip. You can enjoy multi-channel sounds for almost all input sources using various sound field programs stored on the chip and a variety of surround decoders.

Selecting sound field programs

■ Selecting a sound field program on the front panel

Rotate the **PROGRAM selector** to select a desired sound field program.

■ Selecting a sound field program with the remote control

Perform the following operations depending on the category of the sound field programs.

- Sound field programs for movies/TV programs..... Press **[8] MOVIE** repeatedly.
- Sound field programs for music Press **[8] MUSIC** repeatedly.
- Stereo reproduction Press **[8] STEREO** repeatedly.
- Multi-channel stereo reproduction Press **[8] STEREO** repeatedly.
- Compressed Music Enhancer Press **[8] STEREO** repeatedly.
- Surround decoder Press **[8] SUR. DECODE** repeatedly.

For example, if you select “Sci-Fi” in “MOVIE,” the following screen appears on the front panel display.

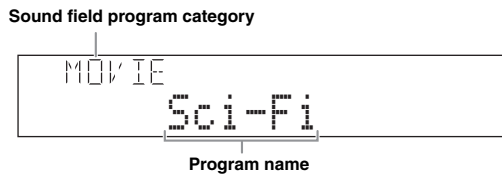

Notes

- Sound field programs are stored for each input source. When you change the input source, the sound field program previously selected for that input source is applied again.
- When you play back the Dolby Digital Plus, Dolby TrueHD, DTS Express, DTS-HD Master Audio, or DTS-HD High Resolution Audio sources, sound is reproduced in straight decode mode.
- If the sampling frequency of an input source is higher than 96 kHz, this unit does not apply any sound field programs.

Sound field program descriptions

This unit provides sound field programs for multiple categories including music, movies and stereo reproduction. Select a sound field program based on your listening preference, not merely on the name of the program, etc.



- You can check what speakers are currently outputting signals with the speaker indicators on the front panel display (see page 6).
- Each program can adjust sound field elements (sound field parameters). For details, see page 49.
- **CINEMA DSP** in the table indicates the sound field program with CINEMA DSP.

For movie/TV program sources (MOVIE) **CINEMA DSP**

Program	Descriptions
Standard	Creates a sound field that emphasizes the surrounding feeling without disturbing the original acoustic positioning of multi-channel audio such as Dolby Digital and DTS. The design concept of this sound field is “an ideal movie theater,” in which the audience is surrounded by beautiful reverberations from the left, right and rear.
Spectacle	Creates a spectacular sound field that produces a sense of magnificent scale. This sound field program features a wide dynamic range that reproduces a broad theater sound field matching cinemascope and wider-screen movies, from tiny sound effects to big acoustics.
Sci-Fi	Creates a clear sound field that allows you to enjoy the finely elaborated sound design of the latest science fiction and SFX movies. Different atmospheres can be vividly reproduced while dialog, sound effects and background music are clearly separated.
Adventure	Creates a sound field ideal for action and adventure movies, reproducing a sense of power by reducing reverberations and emphasizing a horizontal soundscape. A clear and powerful atmosphere is reproduced while maintaining separation of audio channels and sound clarity with a shallower depth of feeling.

Enjoy the sound field programs

Program	Descriptions
Drama	Creates a calm sound field suitable for different genres of movies, from serious dramas to musicals and comedies. Sound is produced with discreet reverberation yet with a three-dimensional feeling. Spatial sound effects and background music are reproduced with soft reverberations around the center position, which reduces fatigue from watching movies for a long time.
Mono Movie	Creates a sound field that allows you to enjoy old monaural movies in an atmosphere of a movie theater of those days. A comfortable space with a feeling of depth is reproduced by adding soundscape and reasonable reverberation to the original sound.
Sports	Creates a lively sound field suitable for stereo sports broadcasts and TV studio shows. In sports broadcasts, the voices of sports commentators and analysts are output from the center while the crowd's cheers and other sounds are suitably spread out, creating a realistic stadium atmosphere that makes you feel as if you are really there.
Action Game	Creates a sound field designed for action games such as car racing and FPS games. The presence of various sound effects is enhanced while maintaining a clear feeling of direction by limiting each channel's sound effect range using reflection data, which produces a realistic and powerful playing environment.
Roleplaying Game	Creates a sound field designed for roleplaying games and adventure games. Depth and a three-dimensional feel to the game are produced by combining movie sound field effects and the sound design used in "Action Game." In movie scenes, movie-like surround effects are produced.

For audio music sources (MUSIC)



Program	Descriptions
Hall in Munich	Creates a sound field designed by simulating a concert hall with about 2,500 seats in Munich, which is a typical European concert venue with elegant wooden interior walls. A rich, delicate and beautiful sound is produced, creating a relaxing atmosphere. The seat setting is a left center orchestra seat.
Hall in Vienna	Creates a sound field designed by simulating a concert hall with about 1,700 seats in Vienna, which is a traditional middle-size shoebox type concert venue. In this hall, complex omnidirectional reflections bounce off pillars and carvings to produce a characteristically rich sound.
Chamber	Creates a sound field designed by simulating a relatively large room with a high ceiling such as a palace chamber. It produces pleasant reverberations suitable for court music and chamber music.
Cellar Club	Creates a realistic live sound field designed by simulating a live house with a low ceiling and intimate atmosphere. It features a powerful sound that makes you feel as if you are right in front of a small stage.
The Roxy Theatre	Creates a sound field designed by simulating a rock music live house with up to about 460 seats in Los Angeles. The seat setting is a left center seat.
The Bottom Line	Creates a sound field designed by simulating "The Bottom Line," a famous New York jazz club which has a floor occupied by 300 wide seats. It produces clear reverberations. The seat setting is in front of the stage.
Music Video	Creates a sound field designed by simulating a concert venue where live performances of pop, rock and jazz music take place. You can indulge yourself in a hot live atmosphere created by a presence sound field that emphasizes the vividness of vocals and solos and the beat of the drums, and by a surround sound field that reproduces a big live venue atmosphere.

For stereo reproduction (STEREO)

Program	Descriptions
2ch Stereo	Produces front stereo sound. This is standard playback mode.



- When multi-channel signals are input, they are downmixed to 2 channels and output from the front left and right speakers.

For multi-channel stereo reproduction (STEREO)



Program	Descriptions
7ch Stereo	Produces front and rear sound for a large area. This playback mode is suitable for BGM at a house party. Sound is output from a maximum of seven speakers.

The Compressed Music Enhancer (ENHNCR)

Program	Descriptions
Straight Enhancer	Dynamically reproduces sound from 2-channel or multi-channel compressed sound data with the same number of channels as its source sound.
7ch Enhancer	Dynamically reproduces sound from compressed sound data in 7 channels regardless of the source sound channels.

Surround decode mode (SUR.DEC)

Reproduces sound from 2-channel sound sources in up to 7 channels using a surround decoder.

Decoder	Descriptions
Pro Logic	Reproduces sound using the Dolby Pro Logic decoder. This is suitable for all kinds of sound sources.
PLIIx Movie / PLII Movie	Reproduces sound using the Dolby Pro Logic IIx (or Dolby Pro Logic II) decoder. This is suitable for movies. You cannot select the Dolby Pro Logic IIx decoder in the following conditions: <ul style="list-style-type: none"> • When no surround back speakers are connected • When headphones are connected
PLIIx Music / PLII Music	Reproduces sound using the Dolby Pro Logic IIx (or Dolby Pro Logic II) decoder. This is suitable for music. You cannot select the Dolby Pro Logic IIx decoder in the following conditions: <ul style="list-style-type: none"> • When no surround back speakers are connected • When headphones are connected
PLIIx Game / PLII Game	Reproduces sound using the Dolby Pro Logic IIx (or Dolby Pro Logic II) decoder. This is suitable for games. You cannot select the Dolby Pro Logic IIx decoder in the following conditions: <ul style="list-style-type: none"> • When no surround back speakers are connected • When headphones are connected
Neo:6 Cinema	Reproduces sound using the DTS Neo:6 decoder. This is suitable for movies.
Neo:6 Music	Reproduces sound using the DTS Neo:6 decoder. This is suitable for music.
Neural Sur. (U.S.A. model only)	Performs Neural Surround processing for all sound sources. The Neural Surround decoder supports PCM (sampling rate of 96 kHz or lower), Dolby Digital, DTS Digital Surround (except for DTS 96/24), DSD and analog 2-channel input sources. When the Neural Surround decoder is selected and an unsupported signal is input, a multi-channel sound source is directly decoded to an appropriate channel without performing any additional effect processing. A Neural Surround incompatible PCM sound source is reproduced in stereo. The Neural Surround decoder is especially suitable for the XM HD Surround program of XM Satellite Radio.



- When multi-channel sound is input, sound is reproduced in straight decoding mode (see page 30).

Enjoying unprocessed input sources (Straight decoding mode)

In straight decoding mode, sounds are reproduced without sound field effect. 2-channel stereo sources are output from only the front left and right speakers. Multi-channel input sources are decoded straight into the appropriate channels and multi-channel sounds are reproduced without a sound field effect.

1 To enable straight decoding mode, press
Ⓟ **STRAIGHT** (or Ⓜ **STRAIGHT**).

“Straight” appears on the front panel display.

2 To cancel straight decoding mode, press
Ⓟ **STRAIGHT** (or Ⓜ **STRAIGHT**) again.

A sound field program name appears on the front panel display, and sound is reproduced with that sound field effect.

Enjoying sound field programs without surround speakers (Virtual CINEMA DSP)

Virtual CINEMA DSP allows you to enjoy DSP sound field surround effects even without any surround speakers by using virtual surround speakers. You can even enjoy Virtual CINEMA DSP using a minimal two-speaker system that does not include a center speaker. When “Sur. L/R SP” in the SETUP menu is set to “None” (see page 55), this unit operates in Virtual CINEMA DSP mode.

Note

- Virtual CINEMA DSP is not available in the following conditions even if you set “Sur. L/R SP” to “None” (see page 55).
 - headphone plug is connected to the PHONES jack.
 - 7ch Stereo of the field sound program is selected.
 - Pure Direct mode or straight decoding mode is used.

Enjoy sound field programs with headphones (SILENT CINEMA™)

SILENT CINEMA allows you to enjoy multi-channel sources with your headphones. SILENT CINEMA mode is automatically selected when you connect the headphone plug to the PHONES jack.

Note

- SILENT CINEMA mode is not available in the following conditions.
 - 2ch Stereo of the sound field program is selected.
 - Pure Direct mode or straight decoding mode is selected.

Enjoying more spatial sound fields (CINEMA DSP 3D mode)

CINEMA DSP 3D mode creates an intensive and accurate stereoscopic sound field in the listening room.

To use this unit in CINEMA DSP 3D mode, presence speakers are required. Do the following steps and then select a CINEMA DSP sound field program. When a sound field program runs in CINEMA DSP 3D mode, the CINEMA DSP 3D indicator on the front panel lights up.

- Connect the presence speakers to the EXTRA SP jacks (see page 12).
- Set “Extra SP Assign” to “Presence” (see page 54).
- Enable CINEMA DSP 3D in the SETUP menu (see page 49).

Note

- If headphones are connected to this unit, this unit plays back in SILENT CINEMA mode so CINEMA DSP 3D mode cannot be enabled.

FM/AM tuning

The FM/AM tuner of this unit provides the following two modes for tuning.

■ Frequency tuning mode

You can tune into a desired FM/AM station by searching or specifying its frequency.

■ Preset tuning mode

You can preset the frequencies of FM/AM stations by registering them to specific numbers, and later just select those numbers to tune in.

Note

- Adjust the FM/AM antennas connected to this unit for the best reception.

Tuning into the desired FM/AM station (Frequency tuning mode)

- 1 Rotate the **INPUT** selector (or press **TUNER**) to switch the input source to "TUNER."
- 2 Press **FM** (**FM**) or **AM** (**AM**) to select a band.
"FM" or "AM" appears on the front panel display according to the band that you have selected.
- 3 Press **TUNING/CH** \triangleleft / \triangleright (or **TUN./CH** \triangle / ∇) to specify the frequency.
To adjust the frequency to a higher range, press \triangleright (or \triangle). To adjust it to the lower range, press \triangleleft (or ∇). The TUNED indicator on the front panel display lights up when the tuner is tuned into a station. The STEREO indicator also lights up if the program being broadcasted is in stereo.

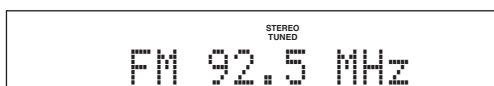

The frequency changes in the following manner according to how you press **TUNING/CH** \triangleleft / \triangleright (or **TUN./CH** \triangle / ∇).

When you press the key more than 1 second

The tuner searches the frequency of a station that is detectable around the current frequency. This is effective when the tuner can receive strong signals without any interference. Once the search starts, release the key.

When you press and release the key

The tuner increases or decreases the frequency in steps. Use this method when the tuner cannot receive strong signals and stations are skipped during the search.



- You can switch between stereo and monaural for FM broadcast in the OPTION menu (see page 48).

- 4 To tune in by direct frequency tuning, enter the frequency of the desired station using **Numeric keys** on the remote control.

Enter only integers. For example, if you want to set the frequency to 88.9 MHz, enter "889" using **Numeric keys**.

Notes

- When you press **Numeric keys** during preset tuning, a preset number is selected. Set tuning mode to frequency tuning mode using **TUNING/CH** \triangleleft / \triangleright (or **TUN./CH** \triangle / ∇) prior to the operation.
- "Wrong Station!" appears on the front panel display when you enter a frequency that is out of receivable range. Make sure that the entered frequency is correct.

Registering FM/AM stations and tuning in (Preset tuning mode)

You can register up to 40 FM/AM stations (Preset) using the automatic station preset feature or manual station preset feature.

Registering stations by automatic station preset

The tuner automatically detects FM stations with strong signals and registers up to 40 stations. AM stations cannot be automatically registered. Use manual station preset.

- 1 Rotate the **INPUT** selector (or press **TUNER**) to switch the input source to "TUNER."
- 2 Press **OPTION** on the remote control.
The OPTION menu screen for setting options of tuner input appears on the front panel display.

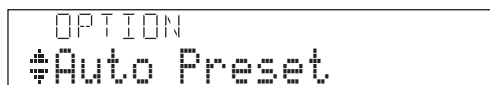
 - For details on the OPTION menu, see page 46.
 - The OPTION menu is displayed on the video monitor.
- 3 Select "Auto Preset," using **Cursor** \triangle / ∇ and press **ENTER**.



Automatic station preset starts about 5 seconds later from the lowest frequency upwards.

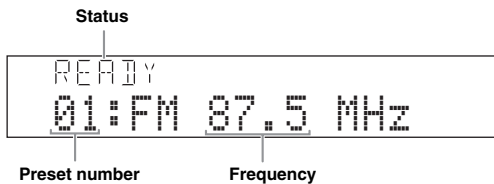

- You can select the preset number at which the preset starts by pressing **PRESET** \triangle / ∇ or **Cursor** \triangle / ∇ on the remote control while "READY" is displayed on the front panel display.
- To cancel registration, press **RETURN** on the remote control.



During the automatic station preset, the upper area of the screen changes as follows: SEARCH → MEMORY each time a station is registered. When registration is complete, “FINISH” appears and the OPTION menu screen automatically reappears. When you press **OPTION** on the remote control, the screen returns to the original state.

Registering stations by manual station preset

You can manually register AM stations or FM stations with weak signals.

1 Tune into a station referring to “Tuning into the desired FM/AM station (Frequency tuning mode)” (see page 31).

2 Press **MEMORY (or **MEMORY**).**
“Manual Preset” appears on the front panel display, followed soon by the preset number to which the station will be registered.



- By pressing down **MEMORY** (or **MEMORY**) for more than 2 seconds, you can skip step 3 and register the station to the lowest empty preset number or a preset number one higher than the last preset number.

3 Press **PRESET </> (or **PRESET** Δ / ▽) to select the preset number to which the station will be registered.**

When you select a preset number to which no station is registered, “Empty” appears on the display. When you select a registered preset number, a registered frequency is displayed on the right of the preset number.

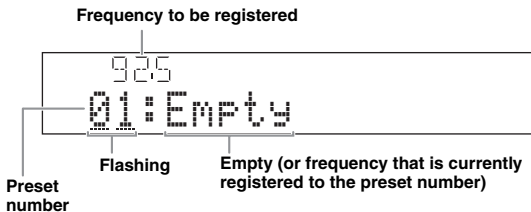

- You can select a preset number using the **Numeric keys**.

4 Press **MEMORY (or **MEMORY**) again to register.**

When registration is complete, the screen returns to the original state.



- To cancel registration, press **RETURN** on the remote control or leave the tuner without any operations for about 30 seconds.

Calling a preset station (Preset tuning)

You can call preset stations registered by automatic station preset or manual station preset.

Press **PRESET </> (or **PRESET** Δ / ▽) to select a preset number.**



- Preset numbers to which no stations are registered will be skipped.
- If no stations are registered, “No Presets” or “No Presets in Memory” appears on the display. See page 31 and register stations.
- You can directly select a preset number by pressing a **Numeric keys** while calling a preset station. “Empty” appears on the display if you enter a preset number to which no station is registered. “Wrong Num.” appears if you enter an invalid number.
- When you press **Numeric keys** during normal tuning, a preset number is selected. Set tuning mode to preset tuning mode using **PRESET** </> (or **PRESET** Δ / ▽) prior to the operation.

Clearing the preset station

1 Rotate the **INPUT selector (or press **TUNER**) to switch the input source to “TUNER.”**

2 Press **OPTION on the remote control.**
The OPTION menu screen for setting options of tuner input appears on the front panel display.

3 Display “Clear Preset” using the **Cursor Δ / ▽ and press **ENTER**.**

The following screen appears on the display.

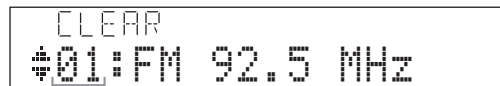

Preset number of the registered station you want to clear.



- You can cancel the operation and return to the OPTION menu screen by pressing **RETURN** on the remote control.

4 Select the preset number of the registered station you want to clear using the **Cursor Δ / ▽ and press **ENTER**.**

The preset station registered to the selected preset number is cleared. To clear the registration of multiple preset numbers, repeat the above steps.

To end the operation, press **OPTION**.

XM® Satellite Radio tuning (U.S.A. model only)

Listening to Satellite Radio

To listen to Satellite Radio, you'll need to connect either a SIRIUS or XM Satellite Radio tuner (sold separately) to your satellite-ready receiver. Satellite Radio is available to residents of the US (except Alaska and Hawaii).

Satellite Radio delivers a variety of commercial-free music from categories ranging from Pop, Rock, Country, R&B, Dance, Jazz, Classical and many more plus coverage of all the top professional and college sports including play by play games from select leagues and teams. Additional programming includes expert sports talk, uncensored entertainment, comedy, family programming, local traffic and weather and news from your most trusted sources.

Whether you purchase a SIRIUS or XM tuner, you'll need to activate and subscribe to begin enjoying the service. Easy to follow installation and setup instructions are provided with the satellite tuners. Whichever service you choose, there are a variety of programming packages available, including the option of adding "The Best of SIRIUS" programming to your XM tuner or "The Best of XM" programming to your SIRIUS tuner, enabling you to enjoy the most popular programming among both services. The "Best of" packages are not available to SIRIUS or XM Canada subscribers at this time. Family friendly packages are also available to restrict channels featuring content that may be inappropriate for children.

To subscribe to XM, U.S. customers should visit xmradio.com or call 1-800-XMRADIO (1-800-967-2346).

To subscribe to SIRIUS, U.S. customers can call 1-888-539-SIRI (1-888-539-7474) or visit sirius.com (US).

SIRIUS XM Radio Legal

SIRIUS, XM and all related marks and logos are trademarks of Sirius XM Radio Inc. and its subsidiaries. All other marks and logos are the property of their respective owners. All rights reserved. SIRIUS and XM subscriptions sold separately. Taxes and a one-time activation fee may apply. XM tuners and home docks or SIRIUS tuners (each sold separately) are required to receive the SIRIUS or XM satellite radio service. All programming and fees subject to change. It is prohibited to copy, decompile, disassemble, reverse engineer, hack, manipulate or otherwise make available any technology or software incorporated in receivers compatible with the SIRIUS or XM Satellite Radio Systems. **Service not available in Alaska and Hawaii.**

Connecting XM Mini-Tuner Home Dock

Connect XM Mini-Tuner and XM Mini-Tuner Home Dock (sold separately) to the XM jack on the rear panel of this unit. For details, see the instruction manuals provided with the XM Mini-Tuner Home Dock.

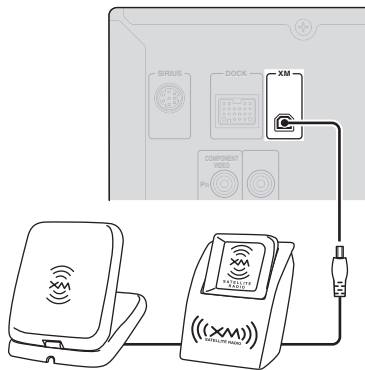

XM Mini-Tuner and XM Mini-Tuner Home Dock (sold separately)



- To ensure optimal reception of the XM Satellite Radio signals, the XM Mini-Tuner Home Dock must be placed at or near a southerly facing window with no obstacles in the path to the sky. You can mount it indoors or outdoors. Use the "Antenna" information on the front panel display or on the video monitor (see page 36) to check the antenna reception level and adjust the orientation of the antenna.

Notes

- If "CHECK ANTENNA," "CHECK XM TUNER" or "NO SIGNAL" appears on the front panel display, the connection and setting of the antenna, XM Mini-Tuner Home Dock, or XM Mini-Tuner may not be correct.
- When "UPGRADE XM TUNER" is displayed, it means that the connected antenna is old. See page 70 for details.

Activating XM Satellite Radio

Once you have installed the XM Mini-Tuner Home Dock, inserted the XM Mini-Tuner, connected the XM Mini-Tuner Home Dock to your XM Ready® home audio system, and installed the antenna, you are ready to subscribe and begin receiving XM programming. You can find your eight character XM Radio ID on the XM Mini-Tuner, on the XM Mini-Tuner package, or on XM Channel 0. Write down the XM Radio ID in the eight squares provided below for future reference.

--	--	--	--	--	--	--	--

Note

- The XM Radio ID does not use the letters "I," "O," "S" or "E" Activate your XM Satellite Radio service in the U.S. online at <http://activate.xmradio.com/> or call 1-800-XM-RADIO (1-800-967-2346). You will need a major credit card. XM will send a signal from the satellites to activate the full channel lineup. Activation normally takes 10 to 15 minutes, but during peak busy periods you may need to keep your XM Ready home audio system on for up to an hour. When you can access the full lineup on your XM Ready home audio system you are done.

XM Satellite Radio operations

1 Rotate the **INPUT** selector (or press **XM**) to select “XM” as the input source.

The XM Satellite Radio information (such as channel number, channel name, category, artist name and song title) for the currently selected channel appears on the front panel display and video monitor (see page 36).

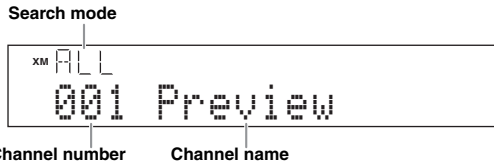

- When you select “XM” as the input source, this unit automatically calls the previously selected channel.

Note

- If a status message or an error message appears on the front panel display or on the video monitor, see “XM Satellite Radio” (see page 70).

2 Search for a channel by using one of the XM Satellite Radio search modes.

- To select a channel from the all channel list, see “All Channel Search mode” on this page.
- To select a channel by category, see “Category Search mode” on this page.
- To select a channel directly by entering the channel number, see “Direct number access mode” on this page.
- To select a channel from the preset channels, see “Calling a preset channel (Preset Search mode)” (see page 35).



- You can display the XM Satellite Radio information on the front panel display or on the OSD (see page 36).
- You can set the XM Satellite Radio preset channels (see page 35).

All Channel Search mode

Press **TUNING/CH** \triangleleft / \triangleright (or **TUN./CH** \triangle / ∇) repeatedly to search for a channel within all channels.

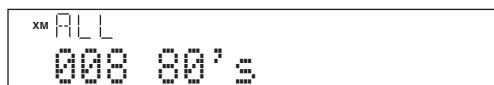

- You can search for a channel quickly by pressing and holding **TUNING/CH** \triangleleft / \triangleright (or **TUN./CH** \triangle / ∇).
- You can skip channels to the previous or next category by pressing **CATEGORY** \triangleleft / \triangleright (or **CATEGORY** \triangleleft / \triangleright).

Category Search mode

1 Press **CATEGORY** \triangleleft / \triangleright (or **CATEGORY** \triangleleft / \triangleright) to select the channel category.

“CAT” is displayed on the front panel display during the channel category selection. When you select the category, the first channel in the category is selected.

Category search mode The first channel in the category



Category name

Note

- If you don't operate within 10 seconds, the category search mode returns to “ALL” (All Channel Search mode).

2 While “CAT” is displayed on the front panel display, press **TUNING/CH** \triangleleft / \triangleright (or **TUN./CH** \triangle / ∇) repeatedly to search for a channel within the selected channel category.



- You can search for a channel quickly by pressing and holding **TUNING/CH** \triangleleft / \triangleright (or **TUN./CH** \triangle / ∇).

Note

- This unit skips the following channels in All Channel Search mode or Category Search mode. This is not a malfunction.
 - channels that are not currently in service
 - channels that you do not subscribe to

Direct number access mode

Press the **Numeric keys** on the remote control to enter the desired three-digit channel number.

For example, to enter the number 123, press “1,” “2” and then “3” of the **Numeric keys**.



- To display the Radio ID number on the front panel display, select channel “0.”
- When entering a one-digit or two-digit channel number, enter the number using the **Numeric keys** and then press **ENT** on the remote control to confirm your entry.
- This unit automatically accepts your entry if you do not press **ENT** within a few seconds after entering the number.
- If the selected channel is not available, an advisory message may appear. For details, see “XM satellite radio” on page 70.
- If this unit is in preset search mode (see next page), a preset number is selected instead of a channel number when you press the **Numeric keys**. To switch to direct number access mode, press **TUNING/CH** \triangleleft / \triangleright (or **TUN./CH** \triangle / ∇).

Registering XM Satellite Radio channels

You can use this feature to store up to 40 XM Satellite Radio channels. You can call any preset channel just by selecting a preset number as described in “Calling a preset channel (Preset Search mode)” on this page.

Registering preset channels

1 Search for a channel you want to set as a preset channel in one of the XM Satellite Radio search modes.

For details, see “XM Satellite Radio operations” (see page 34).



2 Press **MEMORY** (or **MEMORY**).

The front panel display changes as follows.

Currently registered channel
(or “---” if empty)



Preset number

Channel to be registered to the selected preset number



- To register the selected channel under an empty preset number automatically, press and hold **MEMORY** (or **MEMORY**) for more than 2 seconds instead of doing step 2. In this case, steps 3 and 4 are unnecessary.
- To cancel the preset operation, press **RETURN**.

3 Press **PRESET** (or **PRESET**) to select the preset number.

Note

- You can also select a preset number by pressing the **Numeric keys**.

4 Press **MEMORY** (or **MEMORY**).

The channel is registered to the selected preset number.

Calling a preset channel (Preset Search mode)

Prior to selecting a preset number in Preset Search mode, you must register an XM Satellite Radio channel to the preset number. For details, see “Registering preset channels” on this page.

Preset number



Press **PRESET** (or **PRESET**) repeatedly to change preset numbers (1 to 40).



- You can directly enter the preset number using the **Numeric keys** instead of selecting it using **PRESET** (or **PRESET**).

Clearing preset channels

You can clear the assignments of preset XM Satellite Radio channels.

1 Press **OPTION** on the remote control.

The OPTION menu is displayed on the front panel display.

2 Press **Cursor** repeatedly to select “Clear Preset” and then press **ENTER**.

3 Press **Cursor** to select the preset channel that you want to clear.

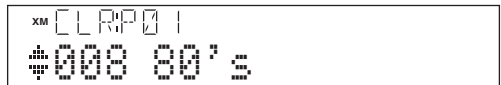

4 Press **ENTER** to execute the clearing of the selected preset channel.

To clear the registration of multiple preset channels, repeat the above steps. To end the operation, press **OPTION**.

Displaying the XM Satellite Radio information

You can display the XM Satellite Radio information on the front panel display or on the video monitor.

Note

- If a status message or an error message appears on the front panel display or the video monitor, see "XM Satellite Radio" (see page 70).

■ Front panel display

Press **Ⓜ** **INFO** (or **Ⓩ** **INFO**) repeatedly to toggle the XM Satellite Radio information display modes as shown below.

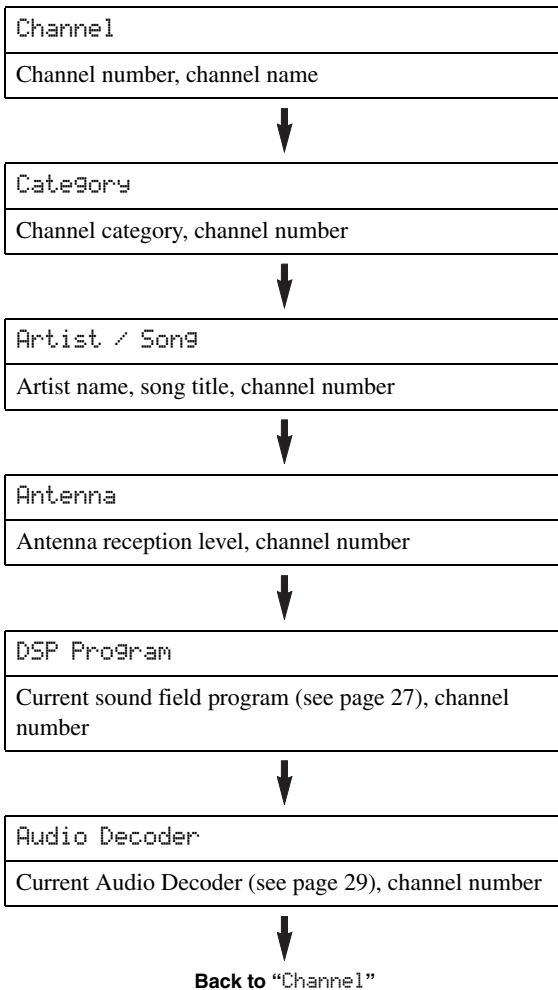

Front Panel Display (example)



- If the XM Satellite Radio information contains a character that this unit cannot recognize, the character is replaced by a blank.
- When an information is unavailable, "—" appears.

■ Video monitor (OSD)

Press **Ⓩ** **DISPLAY** on the remote control to turn on or off the information display.

The following information is displayed on the video monitor.

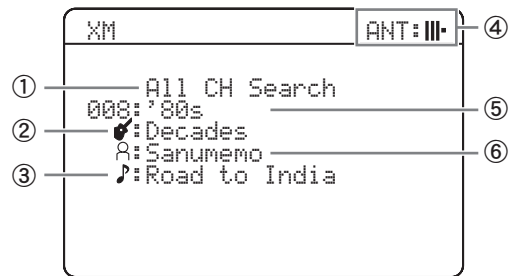

- ① Search mode (see page 34)
- ② Channel category
- ③ Song title
- ④ Antenna reception level
- ⑤ Channel number/name
- ⑥ Artist name



- To turn off the OSD, press **Ⓩ** **DISPLAY**.
- You can hold the music information screen or release it by **Ⓜ** **ENTER**.

SIRIUS Satellite Radio™ tuning (U.S.A. model only)

Connecting the SiriusConnect™ tuner

Connect the SiriusConnect tuner (sold separately) to the SIRIUS jack on the rear panel of this unit. For details, see the instruction manuals provided with the SiriusConnect tuner.

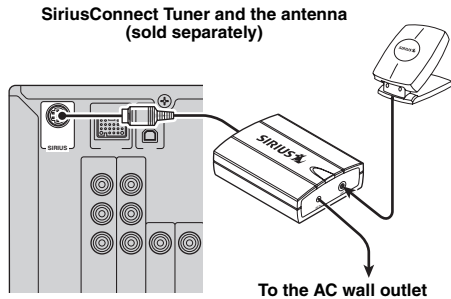

- To ensure optimal reception of the SIRIUS Satellite Radio signals, the antenna of the SiriusConnect tuner must be placed at or near a window with no obstacles in the path to the sky. The orientation of the antenna for the best reception differs depending on the area. Refer to the instruction manuals provided with the SiriusConnect tuner for the installation of the antenna. You can mount it indoors or outdoors.
- Use the Antenna information on the front panel display or the SIRIUS information screen on the video monitor (see page 41) to check the antenna reception level and adjust the orientation of the antenna.
- You need to connect the SiriusConnect tuner to the AC wall outlet.

Notes

- If “CHECK SR TUNER” or “ANTENNA ERROR” appears on the front panel display, the connection of the SiriusConnect tuner or antenna is incorrect. In such cases, check the connection of the SiriusConnect tuner and the antenna.
- If “NOT SUPPORTED” appears on the front panel display, this unit does not support the connected SiriusConnect tuner.

Activating SIRIUS Satellite Radio™ subscription

Before using the SIRIUS Satellite Radio feature, you need to activate your SIRIUS Satellite Radio subscription. To activate the subscription you need the Sirius ID which is uniquely assigned to the SiriusConnect tuner. Sirius ID is 12-digit number and it appears on the package of the SiriusConnect tuner, on the label of the SiriusConnect tuner, and when you tune into the SIRIUS Satellite Radio channel “0” (see next section).

Displaying the Sirius ID of your SiriusConnect tuner

- 1 Rotate the **ⓇINPUT selector** (or press **5[SIRIUS]**) to select “SIRIUS” as the input source.
- 2 Press **13[0]** and then **13[ENT]** to display the Sirius ID of your SiriusConnect tuner. “000 Sirius ID” and “xxxxxxxxxxxx” (“xxxxxxxxxxxx” indicates the 12-digit Sirius ID of your SiriusConnect tuner) appears alternately on the front panel display. Write down the Sirius ID in the space provided below.
ID: _____

- 3 Contact SIRIUS Satellite Radio to activate your subscription.

SIRIUS Satellite Radio online information

Contact for activation

URL: <https://activate.siriusradio.com/>

Phone: 1-888-539-SIRIUS (1-888-539-7474)



- Status messages appear on the front panel display or the video monitor during the activation. For details, see “SIRIUS Satellite Radio” (see page 71). Once the activation is finished, “SUB UPDATED” appears.

SIRIUS Satellite Radio™ operations

- 1 Rotate the **ⓇINPUT selector** (or press **5[SIRIUS]**) to select “SIRIUS” as the input source.

The cursor on the left of the SIRIUS indicator lights up on the front panel display and the SIRIUS Satellite Radio information (such as channel number, channel name, category, artist name, or song title) for the currently selected channel appears on the front panel display.

Search mode



Channel number Channel name



- When you select “SIRIUS” as the input source, this unit automatically calls the previously selected channel.

Notes

- Before activating your subscription, you can only select “184” or “000.”
- If a status message or an error message appears on the front panel display or on the OSD on the video monitor, see “SIRIUS Satellite Radio” (see page 71).

2 Search for a channel by using one of the SIRIUS Satellite Radio search modes.

- To select a channel from the all channel list, see “All Channel Search mode” on this page.
- To select a channel by category, see “Category Search mode” on this page.
- To select a channel directly by entering the channel number, see “Direct number access mode” on this page.
- To select a channel from the preset channels, see “Calling a preset channel (Preset Search mode)” (see page 39).



- You can display the SIRIUS Satellite Radio information on the front panel display or the video monitor (see page 41).
- If you tune into a channel that you do not subscribe, “CALL SIRIUS on the front panel display” or “CALL 888-539-SIRIUS TO SUBSCRIBE” on the video monitor appears.
- You can register SIRIUS Satellite Radio channels to the preset numbers (see page 39).

■ All Channel Search mode

Press **TUNING/CH** </> (or **TUN./CH** Δ / ▽) repeatedly to search for a channel within all channels.



- You can search for a channel quickly by pressing and holding **TUNING/CH** </> (or **TUN./CH** Δ / ▽).
- You can skip channels to the previous or next category by pressing **CATEGORY** </> (or **CATEGORY** </>).

■ Category Search mode

1 Press **CATEGORY** </> (or **CATEGORY** </>) to select the channel category.

“CAT” is displayed on the front panel display during channel category selection. When you select the category, the first channel in the category is selected.

Category search mode The first channel in the category



Category name

Note

- If you don't operate within 10 seconds, the category search mode returns to “ALL (All Channel Search).”

2 While “CAT” is displayed on the front panel display, press **TUNING/CH** </> (or **TUN./CH** Δ / ▽) repeatedly to search for a channel within the selected channel category.



- You can search for a channel quickly by pressing and holding **TUNING/CH** </> (or **TUN./CH** Δ / ▽).

Note

- This unit skips the following channels in All Channel Search mode or Category Search mode. This is not a malfunction.
 - channels that are locked (see page 40)
 - channels that are not currently in service
 - channels that you do not subscribe to

■ Direct number access mode

Press the **Numeric keys** on the remote control to enter the desired three-digit channel number.

For example, to enter the number 123, press “1,” “2” and then “3” of the **Numeric keys**.



- To display the SIRIUS ID number on the front panel display, select channel “0.”
- When entering a one-digit or two-digit channel number, enter the number using the **Numeric keys** and then press **ENT** on the remote control to confirm your entry.
- This unit automatically accepts your entry if you do not press **ENT** within a few seconds after entering the number.
- If the selected channel is locked, “PIN:___” appears on the front panel display. Enter the four-digit Parental Lock code number by using the **Numeric keys** or press **ENT** to cancel (see page 40).
- If the selected channel is not available, an advisory message may appear. For details, see “SIRIUS Satellite Radio” on page 71.
- If this unit is in preset search mode (see next page), a preset number is selected instead of a channel number when you press the **Numeric keys**. To switch to direct number access mode, press **TUNING/CH** </> (or **TUN./CH** Δ / ▽).

Registering the SIRIUS Satellite Radio™ channels

You can use this feature to store up to 40 SIRIUS Satellite Radio channels. You can then call any preset channel just by selecting preset channel group and number as described in “Calling a preset channel (Preset Search mode)” on this page.

Registering preset channels

1 Search for a channel you want to set as a preset channel in one of the SIRIUS Satellite Radio search modes.

For details, see “SIRIUS Satellite Radio operations” (see page 37).

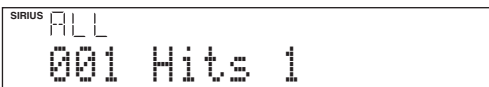

2 Press **MEMORY** (or **MEMORY**).

The front panel display changes as follows.

Currently registered channel
(or “---” if empty)



Preset number

Channel to be registered to the selected preset number



- To register the selected channel under an empty preset number automatically, press and hold **MEMORY** (or **MEMORY**) for more than 2 seconds instead of doing step 2. In this case, steps 3 and 4 are unnecessary.
- To cancel the preset operation, press **RETURN**.

3 Press **PRESET** </> (or **PRESET** Δ / ▽) to select the preset number.

Notes

- You can also select a preset number by pressing the **Numeric keys**.
- If you select a preset number being used (“*” appears next to the preset number), the current preset channel will be overwritten.

4 Press **MEMORY** (or **MEMORY**).

The channel is registered to the selected preset number.

Calling a preset channel (Preset Search mode)

Prior to selecting a preset number in Preset Search mode, you must register a SIRIUS Satellite Radio channel to the preset number. For details, see “Registering preset channels” on this page.



Press **PRESET** </> (or **PRESET** Δ / ▽) repeatedly to change the preset numbers (1 to 40).

Clearing preset channels

You can clear the assignments of preset SIRIUS Satellite Radio channels.

1 Press **OPTION** on the remote control.

The OPTION menu is displayed on the front panel display.

2 Press **Cursor** ▽ repeatedly to select “Clear Preset” and then press **ENTER**.

3 Press **Cursor** Δ / ▽ to select the preset channel that you want to clear.

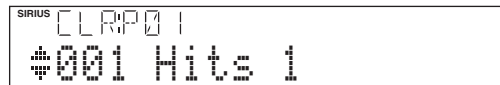

4 Press **ENTER** to execute the clearing of the selected preset channel.

To clear the registration of multiple preset channels, repeat the above steps. To end the operation, press **OPTION**.

Setting the Parental Lock

You can use the Parental Lock feature to limit the access to the desired SIRIUS Satellite channels. This unit automatically skips the locked channels when this unit is in the All Channel Search mode or Category Search mode and you search for a channel by pressing **[TUNING/CH </>]** (or **[TUN./CH Δ / ▽]**).

Setting the code number and the locking channels

You can set the Parental Lock code number (PIN) and select the channels to be locked.

- Press **[OPTION]** on the remote control. The OPTION menu is displayed on the front panel display and video monitor.
- Press **[Cursor ▽]** repeatedly to select “Parental Lock” and then press **[ENTER]**.
- Enter the desired 4-digit code number by using the **[Cursor Δ / ▽ / </>]**. If you have entered a code number before, enter the same code number.

The entered code number is needed for tuning in the channel or unlocking the channel. Write it down in the space provided below.
Code number: _____

- Press **[ENTER]**. A confirmation screen appears.

Note

- If a code number is already registered and you enter the different number, “Wrong” appears and the screen returns to step 3. Enter the correct code number.

- Press **[ENTER]** again to confirm the code number. “OK” appears and then the SIRIUS Satellite Radio channel list is displayed.
- Press **[Cursor </>]** to select a category of that channel and a channel you want to lock.

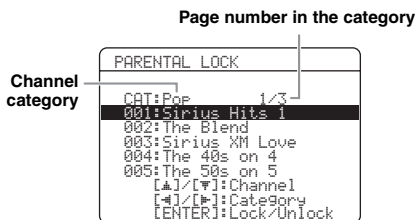

- Press **[Cursor Δ / ▽]** to select a channel you want to lock.

Notes

- You can also select a channel by using **[CATEGORY </>]** or **[TUN./CH Δ / ▽]**.
- While the SIRIUS Satellite Radio channel list screen is displayed, sound of the selected channel is output even the channel is locked.

- Press **[ENTER]** to lock the selected channel.

A check mark appears next to the locked channel on the video monitor. You can toggle channel lock and unlock as you press **[ENTER]**.

Locked channel

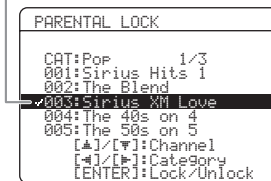

- Repeat steps 5 through 7 to lock all the desired channels.

- Press **[RETURN]** repeatedly to exit the “PARENTAL LOCK” screen.

This unit is tuned into the last channel you select in the PARENTAL LOCK screen. If the channel is locked, this unit is tuned into “184 SIRIUS Weather & Emergency” or “000 Sirius ID.”



- If you forget the Parental lock code or want to change it, reset it using “SR PIN” (see page 64).

Tuning into the locked channels

If you want to tune in the locked channels, set this unit to Direct number access mode or preset tuning mode. When you tune into the locked channel, “LOCKED” appears on the front panel display and video monitor, “LOCKED” appears on the front panel display and video monitor and then the screens change to the Parental Lock code input screen. Enter the Parental Lock code using the **[Numeric keys]**. To cancel this operation, press **[ENT]**.



Note

- If an incorrect number is entered, “Wrong” appears on the front panel display or the video monitor and this unit is tuned into the previously selected channel.

Displaying the SIRIUS Satellite Radio™ information

You can display the SIRIUS Satellite Radio information on the front panel display or on the video monitor.

Note

- If a status message or an error message appears on the front panel display or on the OSD, see “SIRIUS Satellite Radio” (see page 71).

■ Front panel display

Press **ⓂINFO** (or **7INFO**) repeatedly to toggle the SIRIUS Satellite Radio information display modes as shown below.

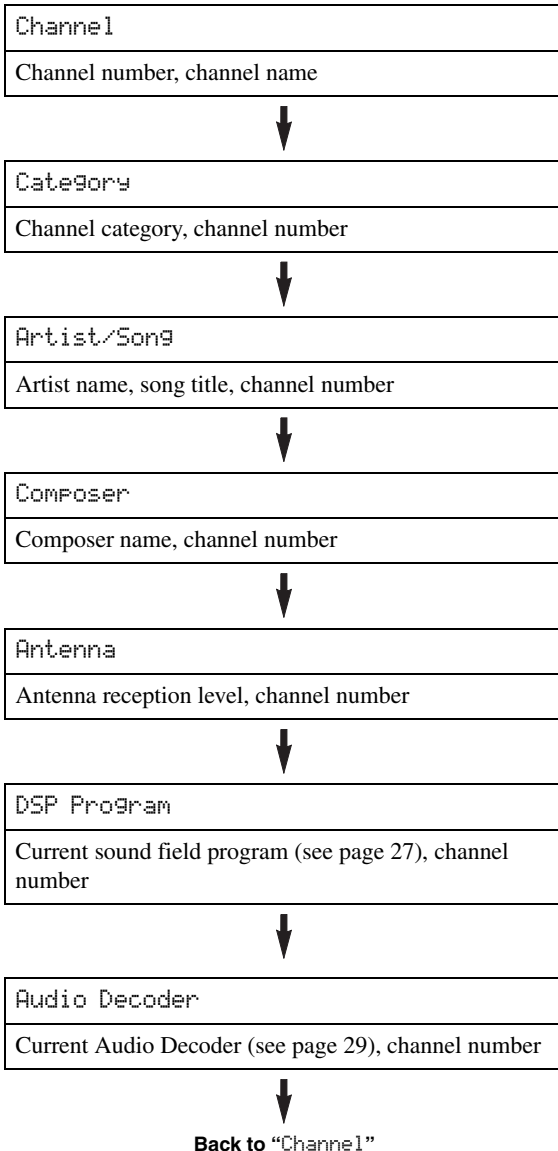

Front Panel Display (example)



- If the SIRIUS Satellite Radio information contains a character that cannot be recognized by this unit, the character will be displayed with a space.
- When the antenna of the SiriusConnect tuner cannot receive the signals, “ACQUIRING” appears on the front panel display.
- When an information is unavailable, “—” appears.

■ Video monitor (OSD)

Press **20DISPLAY** on the remote control to turn on or off the information display.

The following information is displayed on the video monitor.



- ① Search mode (see page 37)
- ② Channel category
- ③ Song title
- ④ Antenna reception level
- ⑤ Channel number/name
- ⑥ Artist name
- ⑦ Composer name



- To turn off the OSD, press **20DISPLAY**.
- You can hold the music information screen or release it by **11ENTER**.

Using iPod™

Once you have stationed your iPod in a Yamaha iPod universal dock (such as the YDS-11, sold separately) connected to the DOCK jack on the rear panel of this unit (see page 19), you can operate your iPod with the remote control of this unit using a menu displayed on the video monitor. You can also use the Compressed Music Enhancer mode of this unit to improve the sound quality of the compression artifacts (such as MP3 format) stored on your iPod (see page 29).

Notes

- iPod touch, iPod (Click and Wheel including iPod classic), iPod nano, and iPod mini are supported.
- Some features may not be compatible depending on the model or the software version of your iPod.
- Some features may not be available depending on the model of Yamaha iPod universal dock. The following sections describe the procedure when using the YDS-11.



- Once the connection between your iPod and this unit is complete, “iPod connected” appears on the front panel display.
- For a complete list of status messages that appear on the front panel display and video monitor, see the “iPod” section on page 73.

Controlling iPod™

You can control your iPod when you set it in the iPod universal dock and switch the input source to DOCK. The operations of your iPod can be done with the aid of the video monitor (menu browse mode) or without it (simple remote mode).

When you connect your iPod to this unit, you can perform the following operations with the remote control.

Key	Function
ENTER	Subsequent menu
△	Menu up
[11] ▽	Menu down
◀	Previous menu
▶	Subsequent menu
◀◀	Search backward (Press and hold)
▶▶	Search forward (Press and hold)
▶▶	Skip forward
◀◀	Skip backward
[12] □	Stop
⏸	Pause (Menu browse mode) Play/Pause (Simple remote mode)
▶	Play (Menu browse mode) Play/Pause (Simple remote mode)
[20] DISPLAY	Switch between Menu browse mode and Simple remote mode

Controlling iPod in simple remote mode

You can perform basic iPod operations (play, stop, skip, etc.) using the supplied remote control without displaying the menu on the video monitor. You can also directly control your iPod in this mode.

Controlling iPod in menu browse mode

You can perform advanced iPod operations using the remote control while looking at the menu displayed on the video monitor. You can browse the song files or video files stored on your iPod and displayed on the monitor. You cannot directly control your iPod in this mode.



- “_” (underscore) is displayed for characters that this unit cannot display.

1 Rotate the **Ⓑ INPUT selector (or press **[5]** DOCK repeatedly) to select “iPod (DOCK)” as the input source.**

2 Press **[20] DISPLAY on the remote control.**
The following screen appears on the video monitor.



3 Press **[11] Cursor **△** / **▽** to select “Music” or “Videos” and press **[11]** Cursor **▶**.**

- Select “Music” to browse music files.
- Select “Videos” to browse video files.

Note

- “Videos” will not be displayed when your iPod or Yamaha iPod universal dock do not support the browser function for browsing video files.

- 4** Press **[Cursor]** Δ / ∇ / \leftarrow / \rightarrow to select a menu item and then **[ENTER]** to start playback.

Menu items of “Music”

Playlists, Artists, Albums, Songs, Genres, Composers

- Playlists > Songs
- Artists > Albums > Songs
- Albums > Songs
- Songs
- Genres > Artists > Albums > Songs
- Composers > Albums > Songs

Menu items of “Videos”

Menu items vary depending on the files stored on your iPod.

■ Description of the play information display



- ① Track number/total tracks
- ② Artist name
- ③ Album title
- ④ Song title
- ⑤ Progress bar
- ⑥ Elapsed time
- ⑦ Shuffle and repeat icons
- ⑧ \blacktriangleright (playback), \parallel (pause), $\blacktriangleright\parallel$ (search forward) and $\parallel\blacktriangleleft$ (search backward)
- ⑨ Remaining time



- You can change information screens on the front panel display using **[INFO]** (or **[ZINFO]**) (see page 26). Items displayed on the front panel display vary depending on mode that is currently selected.

Shuffle/repeat playback

You can use a special playback function such as shuffle playback and repeat playback by setting the OPTION menu.

- 1** Press **[DISPLAY]** to switch to menu browse mode while “iPod (DOCK)” is selected as the input source.

To use the shuffle or repeat playback function in simple remote mode, set your iPod from its menu.

- 2** Press **[OPTION]**.

The OPTION menu is displayed.

- 3** Press **[Cursor]** Δ / ∇ to select the desired playback function, “Shuffle” or “Repeat,” then press **[ENTER]**.

The following playback styles are available depending on the playback function selected.

Shuffle: Plays back songs or albums in random order (Choices: Off, Songs, Albums).

- Select “Off” if you do not want to play back in random order.
- Select “Songs” to play back songs in random order.
- Select “Albums” to play back albums in random order.

Repeat: Plays back songs or albums repeatedly (Choices: Off, One, All).

- Select “Off” if you do not want to play back repeatedly.
- Select “One” to repeat each song.
- Select “All” to repeat all songs.

- 4** Select the desired style using **[Cursor]** \leftarrow / \rightarrow .

The style is selected. Playback starts with the function selected in step 3.

To return to the previous screen, press **[RETURN]**.

To return to the previous playback function, redo the above steps.



- When the shuffle function is on, “ \square ?” appears on the video monitor.
- When “Repeat” is set to “One” or “All,” “ \square ?” or “ \square ?” appears on the video monitor.

Using Bluetooth™ components

This unit supports A2DP (Advanced Audio Distribution Profile) of the Bluetooth profile. You can connect a Yamaha Bluetooth wireless audio receiver (such as YBA-10, sold separately) to the DOCK jack of this unit and enjoy the music contents stored in your Bluetooth component (such as a portable music player) without wiring between this unit and the Bluetooth component. You need to perform “Pairing” the connected Bluetooth wireless audio receiver and your Bluetooth component in advance.

Pairing the Bluetooth™ wireless audio receiver and your Bluetooth™ component

“Pairing” refers to the operation of registering a Bluetooth component for Bluetooth communications. Pairing must be performed when using a Bluetooth component with the Bluetooth wireless audio receiver connected to this unit for the first time or if the pairing data has been deleted.



- You only need the pairing operation for the first time that you use the Bluetooth component with the Bluetooth wireless audio receiver.
- Pairing requires operations on this unit and on the other component with which Bluetooth communications are to be established. If necessary, refer to the instruction manuals provided with other component.

■ Pairing the Bluetooth wireless audio receiver and your Bluetooth component

To ensure security, a time limit of 8 minutes is set for the pairing operation. We recommend that you read the instructions so that you fully understand them before starting.

1 Rotate the **ⓇINPUT selector (or press **5**DOCK repeatedly) to select “Bluetooth (DOCK)” as the input source.**

2 Turn on the Bluetooth component you want to pair with and set it to pairing mode.

For details on operation of the Bluetooth component, refer to its instruction manuals.

3 Press **18OPTION.**

The OPTION menu for DOCK input appears on the video monitor.

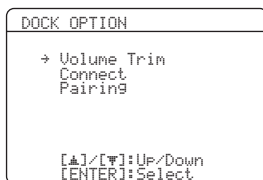

4 Press **11Cursor ▽ to select “Pairing” and press **11**ENTER.**

“Searching” appears on the front panel display and the pairing operation starts.



- To cancel pairing, press **11**RETURN.
- You can also start pairing operation by pressing and holding **Ⓢ**MEMORY on the front panel.

5 Make sure the Bluetooth component recognizes the Bluetooth wireless audio receiver.

If the Bluetooth have recognized the Bluetooth wireless audio receiver, “YBA-10 YAMAHA,” for instance, is displayed in the Bluetooth device list.

6 Select the Bluetooth wireless audio receiver from the Bluetooth device list, and enter a path key “0000” into the Bluetooth component.

When pairing is complete, “Completed” appears on the front panel display.



- The Yamaha Bluetooth wireless audio receiver can be paired with up to eight Bluetooth components. When pairing is conducted successfully with a ninth component and the pairing data is registered, the pairing data for the least recently used other component is cleared.

Playback of the Bluetooth™ component

1 Rotate the **ⓇINPUT selector (or press **5**DOCK repeatedly) to select “Bluetooth (DOCK)” as the input source.**

2 Press **18OPTION.**

3 Press **11Cursor ▽ repeatedly to select “Connect” and press **11**ENTER.**

After you execute “Connect,” communication with the Bluetooth component is established. When the connected Bluetooth wireless audio receiver recognizes the Bluetooth component, “BT Connected” appears on the front panel display.



- When you press **11**ENTER on the remote control, the connected Bluetooth wireless audio receiver searches and connects to the last connected Bluetooth component. If the Bluetooth wireless audio receiver cannot find the Bluetooth component, “Not found” appears on the front panel display.
- To disconnect the Bluetooth wireless audio receiver from the Bluetooth component, display the OPTION menu again, select “Disconnect,” and press **11**ENTER.

4 Start playback of the Bluetooth component.

Other functions

Using the sleep timer

You can set this unit to automatically return to standby after a set time has passed.

The sleep timer is useful if you want to go to sleep while this unit is playing or recording a source.

Press **[SLEEP]** repeatedly to set the amount of time.

Each time you press the key, the front panel display changes as shown below.

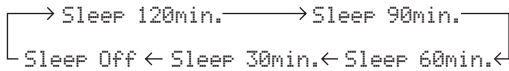

When the sleep timer is set, the SLEEP indicator on the front panel display lights up.

Press **[SLEEP]** on the remote control repeatedly until “Sleep Off” appears on the front panel display.

Using the HDMI™ control function

This unit supports the HDMI control function.

When a TV that supports the HDMI control function is connected with this unit via the HDMI connection, the following operations of this unit can be controlled with the TV remote control (except for some TVs).

- Switching between on and standby (linked to the TV)
- Volume control (up/down, mute)
- Switching the sound output between a TV and this unit.

When you use the HDMI control function, do the following referring to the instruction manuals of the TV.

- Turn on the HDMI control function on the TV.
- Connect the TV to this unit following the instructions for connecting the TV to an AV amplifier.



- The HDMI control-compatible components include Panasonic VIERA Link compatible TV, DVD player/recorder and Blu-ray Disc player.
- When a DVD recorder/Blu-ray recorder/HD DVD recorder that supports the HDMI control function is connected via the HDMI connection, its operations are also linked to those of this unit. For details, refer to its instruction manuals.
- We recommend that you use a TV, DVD recorder, Blu-ray recorder and HD DVD recorder of the same manufacturer.

1 Connect a TV that supports the HDMI control function to this unit via the HDMI connection.

2 Turn on all components connected to this unit via the HDMI connection.

For details on operations of external components, refer to instruction manuals provided with them.

3 Check the settings of those components and enable the HDMI control function.

This unit: Set “Control (SETUP menu → Function Setup → 1 HDMI)” to “On” in the SETUP menu (see page 57).

External components: Refer to their instruction manuals.

4 Turn off the TV.

All external components that support the HDMI control function turn off linked to the TV being turns off. If any component does not turn off, turn it off manually.

5 Turn on the TV.

Make sure that this unit turns on linked to the TV being turned on. If it does not turn on, turn it on manually.

6 Set the input of the TV according to the component connected to this unit such as [HDMI].

7 If a DVD recorder or Blu-ray recorder that supports the HDMI control function is connected to this unit, turn it on.

This unit: Make sure that the input source to which the DVD recorder or Blu-ray recorder is connected is selected. If another input source is selected, select the input source manually.

External component: Make sure that you can see images properly on the video monitor.



- You do not need to do step 1 through 7 from the second time.

8 Perform the following operations with the TV remote control to check the link.

- Turning on and off
- Adjusting volume
- Switching sound output components

Notes

- If this unit does not work linked with the TV, turn the TV off and back on or unplug the AC power plug and plug back in. Doing so may solve the problem.
- If the problem still persists, check the following:
 - This unit: Is the HDMI control function set to “On”?
(see page 57)
 - TV: Is the HDMI control function is enabled?



- If the TV connected to this unit supports the HDMI control function, you only need to connect its audio output jacks to the AV1 jacks of this unit, which are optical digital input jacks, and turn on the video monitor. TV of SCENE is automatically selected when you turn on the TV, and you can enjoy TV sound right away. When connecting the audio output jacks to the AV2-6, AUDIO1-2 or V-AUX jacks, assign those jacks to the TV beforehand (see page 24).

ADVANCED OPERATION

Setting the option menu for each input source (OPTION menu)

This unit has the OPTION menu of frequently used menu items for input sources compatible with this unit. The procedure for setting the OPTION menu items is described below.

1 Select an input source using the **[INPUT] selector (or **[5]** Input selection keys).**

2 Press **[OPTION] on the remote control.**
The OPTION menu appears. The displayed OPTION menu items differ depending on the input source. For details, see next section.

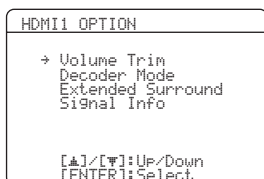

3 Select the desired menu item using **[Cursor] **▲** / **▼**, and press **[ENTER]**.**
Parameters of the selected menu item are displayed.

4 Change the setting of the selected menu item (or enable a function) using **[Cursor] **▲** / **▼** / **◀** / **▶** and **[ENTER]**.**
Details of the selected menu item are displayed.
Parameters you can set differ depending on the menu items.

5 To close the OPTION menu, press **[OPTION].**
You can also use **[RETURN]** to return to the previous screen or close the OPTION menu.



- If **[Cursor]** or other keys do not work after closing the OPTION menu, select the input source again using the **[5]** Input selection keys.

OPTION menu items

The following menu items are provided for each input source.

Input Source	Menu item			
HDMI1-4	Volume Trim	Decoder Mode	Extended Surround	Signal Info
AV1-4	Volume Trim	Decoder Mode	Extended Surround	Signal Info
AV5-6	Volume Trim			
AUDIO1-2	Volume Trim			
V-AUX	Volume Trim			
iPod (DOCK)	Volume Trim	Shuffle	Repeat	
Bluetooth (DOCK)	Volume Trim	Connect/ Disconnect	Pairing	
TUNER	Volume Trim	FM Mode	Auto Preset	Clear Preset
XM	Volume Trim	Clear Preset		
SIRIUS	Volume Trim	Parental Lock	Clear Preset	
MULTI CH	Volume Trim	Video Out		

Below is a detailed explanation of the menu items in this table.



- The default settings are marked with “*.”

■ Volume Trim

Input source: All
Adjustable range: -6.0 dB to 0.0 dB* to +6.0 dB
(in 0.5 dB steps)

Reduces any change in volume when switching input sources by correcting volume differences between input sources.

You can set this parameter for each input source.

■ **Decoder Mode**

Input source: HDMI1-4, AV1-4

Choices: Auto*/DTS

Selects DTS digital audio signals for reproduction.

Auto Automatically selects audio input signals.

DTS Selects DTS signals only. Other input signals are not reproduced.

■ **Extended Surround**

Input source: HDMI1-4, AV1-4

Choices: Auto*/PLIIX Movie/PLIIX Music/EX/ES/Off

Selects whether to reproduce multi-channel input signals in 6.1- or 7.1-channel when surround back speakers are used.

Auto Automatically selects the most suitable decoder according to whether a flag for reproducing surround back channel is present, and reproduces the signals in 6.1- or 7.1-channel.

PLIIX Movie Always reproduces signals in 6.1- or 7.1-channel using the PLIIX Movie decoder whether or not surround back channel signals are contained. You can select this parameter when two surround back speakers are connected.

PLIIX Music Always reproduces signals in 6.1- or 7.1-channel using the PLIIX Music decoder whether or not surround back channel signals are contained. You can select this parameter when one or two surround back speakers are connected.

EX/ES Automatically selects the most suitable decoder for input signals whether or not the flag for reproducing surround back channel is present, and always reproduces signals in 6.1-channel.

Off Always reproduces signals in 5.1-channel when 5.1-channel sound is input, whether or not the flag for reproducing surround back channel is present.

■ **Signal Info**

Input source: HDMI1-4, AV1-4

Displays information on audio and video signals on the video monitor and front panel display. You can change items to be displayed using **[Cursor] Δ / ▽**.

Signal Info parameters

■ **Audio information**

Information	Description
Format	Format of digital audio signals.
Channel	The number of input signal channels (front/surround/LFE). For example, if input signal channels are 3 front channels, 2 surrounds and LFE, "3/2/0.1" is displayed. If a channel that cannot be expressed as the above, a total number of channels such as "5.1ch" may be displayed.
Sampling	The sampling frequency of digital input signal.
Bitrate	The bit rate of input signal per second.

Notes

- "No Signal" is displayed when no signals are input and "---" is displayed when signals that this unit cannot recognize are input.
- The bit rate may vary during playback.

■ **Video information**

Information	Description
In	Format and resolution of video input signal.
Out	Format and resolution of video output signal.
Message	Error messages about HDMI signals and HDMI components. See the following for details of the error messages.

HDMI error message (appears only when an error has occurred)

HDCP Error	HDCP authentication failed.
Device Over	The number of HDMI components connected is over the limit.
Out of Res.	The connected monitor is not compatible with the video input signal.

■ FM Mode

Input source: TUNER

Choices: Stereo*/Mono

Sets FM broadcasting receiving mode.

Stereo Receives in stereo mode.

Mono Receives in monaural mode. You can get a better reception in monaural mode.

■ Auto Preset

Input source: TUNER

Automatically detects radio stations in the FM frequency band and registers them as preset stations (see page 31).

■ Clear Preset

Input source: TUNER, XM, SIRIUS

When TUNER is selected: See page 32.

When XM is selected: See page 35.

When SIRIUS is selected: See page 39.

■ Parental Lock

Input source: SIRIUS

Sets the Parental Lock (see page 40).

■ Shuffle

Input source: iPod (DOCK)

Choices: Off*/Songs*/Albums

Changes the shuffle playback style (see page 43).

■ Repeat

Input source: iPod (DOCK)

Choices: Off*/One*/All

Changes the repeat playback style (see page 43).

■ Connect/Disconnect

Input source: Bluetooth (DOCK)

Switches communication with a Bluetooth component on and off (see page 44).

■ Pairing

Input source: Bluetooth (DOCK)

Performs pairing of this unit and a Bluetooth component (see page 44).

■ Video Out

Input source: MULTI CH

Choices: AV1 to 6/V-AUX/Off*

When the multi-channel input is selected, outputs a signal input from another terminal to the video monitor. See “Outputting a video signal input from another input source during reproducing a multi-channel audio signal” on this page.

Outputting a video signal input from another input source during reproducing a multi-channel audio signal

When “MULTI CH” is selected as the input source, a video signal input from another terminal can be output to the video monitor. For example, even if an audio and video component such as a DVD player that does not support a multi-channel digital audio output, the video signal can be output to the video monitor while reproducing a multi-channel analog audio signal.

- 1 Rotate the **Ⓡ** INPUT selector (or press **5** MULTI) to change the input source to “MULTI CH.”
- 2 Press **18** OPTION on the remote control. The OPTION menu appears.
- 3 Press **11** Cursor **▲ / ▼** to display “Video Out,” and press **11** ENTER. The following screen appears.

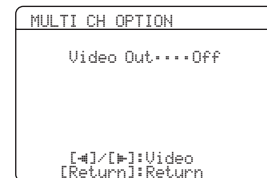

- 4 Press **11** Cursor **< / >** to select a video input jack to which a component to be used as a video input source is connected.
 - AV1-2 (COMPONENT VIDEO jacks)
 - AV3-6 (VIDEO jack)
 - V-AUX (VIDEO jack)
 - Off (no video input)
- 5 To end the setting, press **18** OPTION.

Editing surround decoders/sound field programs

Setting sound field parameters

Although the sound field programs would satisfy you as they are with the default parameters, you can arrange sound effect or decoders suitable for acoustical conditions of sources or rooms by setting the parameters (sound field elements).



- You can protect the sound field against the changes of parameters the sound filed parameters when “Memory Guard” of the SETUP menu is set to “On” (see page 59). To change the parameters, set it to “Off.”

1 Turn on the video monitor connected to this unit.

2 Press \square SETUP on the remote control.
The SETUP menu appears on the monitor.

3 Press \square Cursor Δ / ∇ to select “DSP Parameter” and press \square ENTER.

The screen changes as follows.

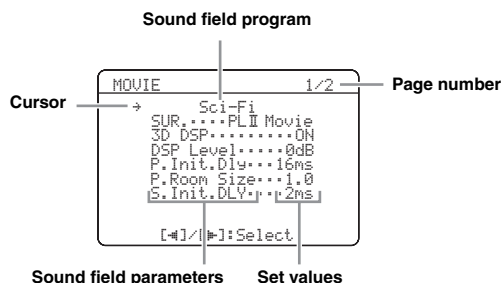

4 Press \square Cursor Δ / ∇ to move “ \rightarrow ” to the sound field program and press \square Cursor \triangleleft / \triangleright to select the sound field program.

5 Press \square Cursor Δ / ∇ to select the parameter that you want to change, and press \square Cursor \triangleleft / \triangleright to change the parameter.

An asterisk (*) appears on the left of the sound field parameter name displayed on the monitor when you change the parameter from its default setting. For details on functions and adjustable ranges of the sound field parameters, see “Sound field parameters” on this page.



- Repeat steps 4 and 5 to change other sound field program parameters.
- A complete list of the parameters of some sound field programs may exceed one page. In this case, press \square Cursor Δ / ∇ to scroll through pages.

6 To end the edit, press \square SETUP.

To initialize the parameters of the selected sound field program, \square Cursor ∇ repeatedly to select “Initialize” and then press, \square Cursor \triangleright . When the confirmation screen appears on the monitor, press \square Cursor \triangleright to confirm the initialization or \square Cursor \triangleleft to cancel it.

Sound field parameters



- The default settings are marked with “*.”

CINEMA DSP basic parameters

SUR.

Choices: PLIIx Movie*/Neo:6 Cinema

Selects a surround decoder to be used with a sound field program in the MOVIE category.

PLIIx Movie: Selects the Dolby Pro Logic IIx (Movie) decoder.

Neo:6 Cinema: Selects the Neo:6 (Cinema) decoder.

Note

- Surround decoders cannot be changed when used with the following MOVIE sound field programs.

- Mono Movie
- Sports
- Action Game
- Roleplaying Game

3D DSP

Choices: On*/Off

When CINEMA DSP 3D is enabled, sets whether to use sound field programs in CINEMA DSP 3D mode.

Note

- When the presence speakers are not used, the 3D DSP parameters are not displayed.

DSP Level

Adjustable range: -6 dB to 0 dB* to +3 dB

Fine adjusts an effect level (level of the sound field effect to be added). You can adjust the level of the sound field effect while checking sound levels. Adjust “DSP Level” as follows.

- The effect sound is too soft.
→Increase the effect level.
- The sound is dull.
→Reduce the effect level.
- The sound field effect is added too much.
→Reduce the effect level.

Dialog Lift

Choices: 0* to 5

Adjusts the vertical position of center sound such as dialogues when presence speakers are used. Increasing this parameter raises the position.

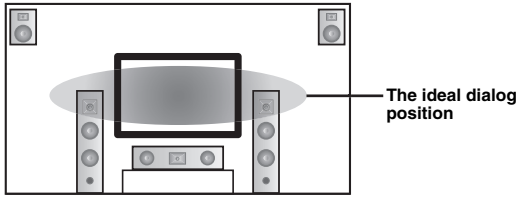

If the dialog seems to come out from a lower position than the video monitor screen, increase this parameter.

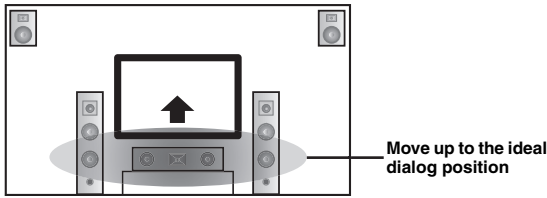

“0” (default) corresponds to the lowest position and “5” to the highest position.

Notes

- “Dialog Lift” is displayed only when the presence speakers are available.
- You cannot move the dialog position lower than the default setting.

Sound field parameters for the advanced configurations



- Some sound field programs have parameters for adjusting specific sound fields. The following letters are displayed next to the names of those parameters.
 - P (presence sound field)
 - S (surround sound field)
 - SB (surround back sound field)

Parameters for adjusting early-reflected sound

Parameter	Adjustable range
Init.Dly	1 to 99ms
P.Init.Dly	1 to 99ms
S.Init.Dly	1 to 49ms
SB Init.Dly	1 to 49ms

Adjust attenuation characteristics of early-reflected sound. You can create a lively sound field (with a high reverberant sound level) as you increase the value, and a dead sound field (with a low reverberant sound level) as you decrease the value. Creating either a lively sound field or a dead sound field in an actual music hall is determined by the acoustic absorption characteristics of reflection surfaces. A dead sound field is created when the attenuation time is short while a lively sound field is created when the attenuation time is long.

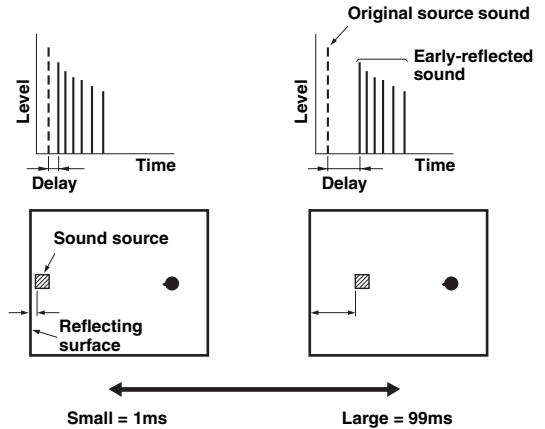

- We recommend that you adjust the size of corresponding sound field when you adjust the delay time.

Parameters for specifying room size

Parameter	Adjustable range
Room Size	
P.Room Size	0.1 to 2.0
S.Room Size	
SB Room Size	

Produce different senses of sound expansion according to room sizes specified. In a large size room such as a music hall, the duration from when reflected sound is heard until when the next reflected sound is heard is long. Thus, different senses of sound expansion can be created by changing the duration. 1.0 is the original room size. When this parameter is set to 2.0, each side of the room is defined as twice larger than the original room size.

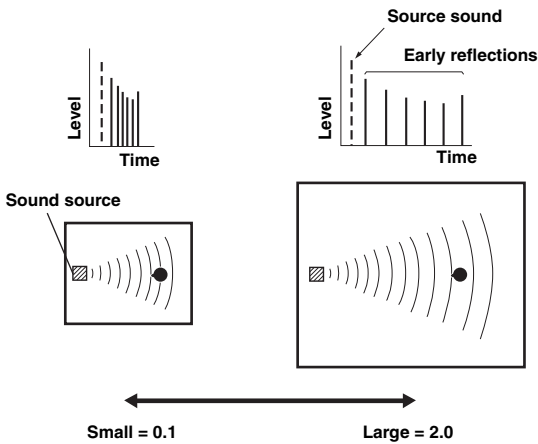

Parameters for defining attenuation characteristics of early-reflected sound

Parameter	Adjustable range
Liveness	0 to 10
S.Liveness	0 to 10
SB Liveness	0 to 10

Adjust the attenuation of reflected sound. You can create a lively sound field (with a high reverberant sound level) as you increase the value, and a dead sound field (with a low reverberant sound level) as you decrease the value. Creating either a lively sound field or a dead sound field in an actual music hall is determined by the acoustic absorption characteristics of reflection surfaces. A dead sound field is created when the attenuation time is short while a lively sound field is created when the attenuation time is long.

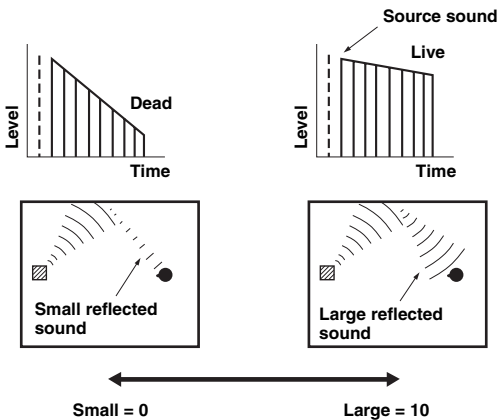

Parameters for adjusting reverberant sound

Parameter	Adjustable range
Rev.Time	1.0 to 5.0s
Rev.Delay	0 to 250ms
Rev.Level	0 to 100%

Rev.Time parameter adjusts the attenuation time of the rear reverberant sound based on the time that about 1kHz reverberant sound takes for 60dB of attenuation. Reverberant sound attenuates faster as you decrease the value. Rev.Time adjustment allows you to create a natural reverberant sound, by setting the attenuation time longer for a sound source or room with less echo, or shorter for a sound source or room with more echo.

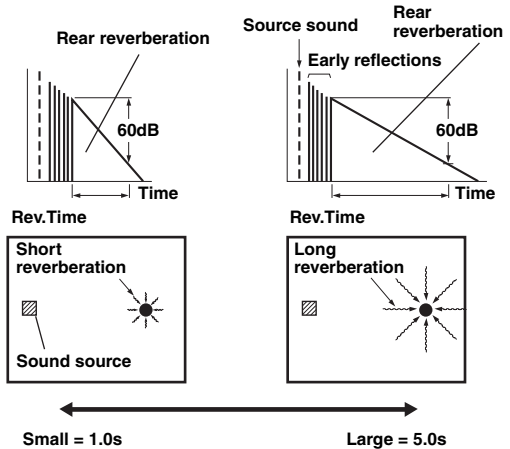

Rev.Delay parameter adjusts the time difference between the beginning of the direct sound and the beginning of the reverberation sound. The larger the value, the later the reverberation sound begins. Increasing the value of Rev.Delay allows you to create a reverberant sound in a wider area for the same Rev.Time.

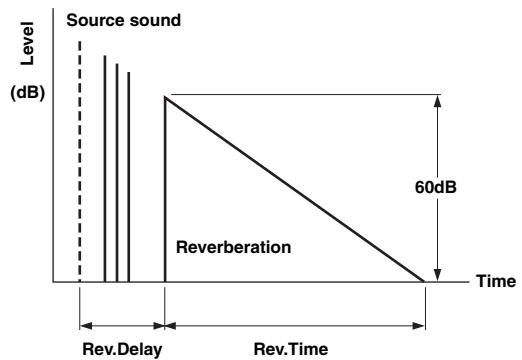

Rev.Level parameter adjusts the reverberation sound level. Increasing the value of Rev.Level makes the reverberation sound level higher, which allows you to create more echo.

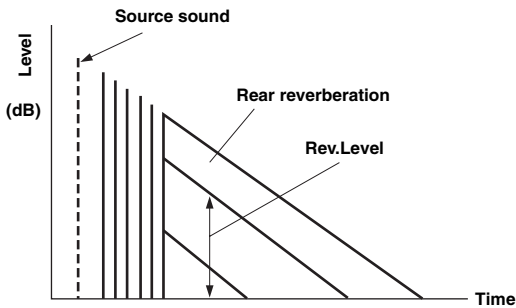

Parameters only usable in certain sound field programs

2ch Stereo only

Direct

Choices: Auto*/Off

Automatically bypasses the DSP circuit and tone control circuit when an analog sound source is selected as the input source. This creates a higher quality sound.

Auto Outputs sound by bypassing the DSP circuit and tone control circuit when the “Bass” and “Treble” tone controls are both set to 0 dB.

Off Does not bypass the circuits.



• See page 56 for equalizers that can be used with this unit.

7ch Stereo only

CT Level/SL Level/SR Level/
SB Level/PL Level/PR Level

Adjustable range: 0 to 100%

Adjusts the volume of the center (CT), surround L (SL), surround R (SR), surround back (SB), presence L (PL) and presence R (PR) channels in the 7ch Stereo program. The available parameters differ depending on the setting of the speakers.

Straight Enhancer/7ch Enhancer only

Effect Level

Choices: High*/Low

Adjusts the Compressed Music Enhancer effect level. To reduce the effect, set this parameter to “Low.”

Decoder parameters

You can customize decoder effects by setting the following parameters. For kinds of decoders, see page 29.

When PLIIx Music/PLII Music is selected

Panorama

Choices: Off*/On

Adjusts the soundscape of the front sound field. A small value increases the soundscape and a large value narrows it (makes the center more dominant).

Dimension

Adjustable range: -3 to STD* to +3

Adjusts the difference in level between the front sound field and the surround sound field. You can adjust the difference in level created by the software being played back to obtain the preferred sound balance. The surround sound gets stronger as you make the value more negative and the front sound gets stronger as you make the value more positive.

Center Width

Adjustable range: 0 to 3* to 7

Spreads the center sound toward left and right according to your preference. Set this parameter to 0 for outputting the center sound from the center speaker only, or to 7 for outputting it from the front left/right speaker.

When Neo:6 Music is selected

C. Image

Adjustable range: 0.0 to 0.3* to 1.0

Adjusts the front left and right channel output relative to the center channel to make the center channel more or less dominant as necessary.

Changing various settings of this unit (SETUP menu)

You can change various settings of this unit using the SETUP menu. See “Basic operation of the SETUP menu” on the next page, and other respective pages to change the settings.

■ List of SETUP menu items

Menu/Submenu	Function	Page
Speaker Setup	Sets items for speakers.	54
1 Auto Setup (YPAO)	Automatically adjusts output characteristics of speakers.	54
2 Manual Setup	Manually adjusts output characteristics of speakers.	54
A)Config	Sets speaker configurations, such as connection status of speaker and a size of the connected speaker (sound reproduction capacity), suitable for the listening environment.	54
B)Level	Separately adjusts volume of each speaker.	56
C)Distance	Adjusts timing at which each speaker outputs sound based on distances between speakers and the listening position.	56
D)Equalizer	Selects an equalizer that adjusts speaker output characteristics.	56
E)Test Tone	Generates test tones.	56
Sound Setup	Sets various items for sound outputs.	56
1 Dynamic Range	Adjusts dynamic ranges of speakers and headphones.	56
2 Lipsync	Adjusts delay in output timing between video signals and audio signals.	57
HDMI Auto	Sets on or off of automatic adjustments for delay between output timing between video signals input from the HDMI jack and audio signals.	57
Auto Delay	Fine adjusts a delay time of HDMI Auto.	57
Manual Delay	Manually fine adjusts the delay of audio and video output.	57
Function Setup	Set various items for HDMI and display.	57
1 HDMI	Sets various items for input sources.	57
Control	Selects on or off of HDMI control functions.	57
Standby Through	Selects on or off of output of HDMI signals input from the HDMI 1-4 jacks to the HDMI OUT jack when this unit is on standby.	57
Audio Output	Selects this unit or a component connected to this unit via the HDMI OUT jack of this unit for reproducing sound signals input from the HDMI 1-4 jacks.	57
Resolution	Sets resolution of the HDMI output that is converted from analogy video input signals.	57
Aspect	Set an aspect ratio of images reproduced by HDMI signals converted from analog video input signals.	58
2 Display	Set items for a monitor or the front panel display.	58
Dimmer	Sets brightness of the front panel display.	58
FL Scroll	Selects the way to display characters on the front panel display.	58
OSD Shift	Adjusts top and bottom positions of the OSD (on-screen display) menus.	58
3 Volume	Sets items for volumes.	58
Adaptive DRC	Adjusts the dynamic range (difference between the maximum volume and the minimum volume) in conjunction with the volume level.	58
Max Volume	Sets the maximum volume level so that the volume will not be accidentally increased.	58
Init. Volume	Sets the volume at the time this unit is turned on.	58
4 Input Rename	Changes input source names to be displayed on a video monitor or the front panel display.	59
5 Zone2	Sets the maximum volume level and initial volume level of Zone2.	59
Max Volume	Sets the maximum volume level so that the volume will not be accidentally increased.	59
Init. Volume	Sets the volume at the time this unit is turned on.	59
DSP Parameter	Sets parameters for the sound field programs.	59
Memory Guard	Protects some settings against accidental alteration.	59

Basic operation of the SETUP menu

The SETUP menu screen appears on both video display (OSD) and front panel display.

Video display (OSD)

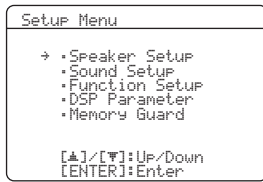

Front panel display

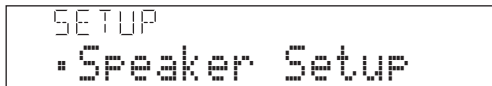

In this section, procedures of setting menus displayed on the video monitor are described.

1 Press **SETUP** on the remote control.

The SETUP menu screen appears.

2 Select a menu using **Cursor** Δ / ∇ , and press **ENTER**.

Items of the selected menu are displayed. For example, the following screen appears when you select "Function Setup."

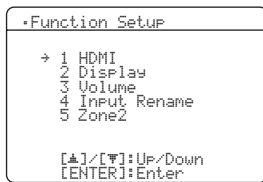

- You can return to the previous screen by pressing **RETURN**.

3 To display submenus, select a menu that you want to set using **Cursor** Δ / ∇ , and press **ENTER**.

For example, the following screen appears when you select "2 Display."



4 Select an item using **Cursor** Δ / ∇ , and change the setting of the item using **Cursor** \leftarrow / \rightarrow .

Some items in the Manual Setup menu of Speaker Setup take up a full screen. To display other items in the Manual Setup menu, press **Cursor** Δ / ∇ .

Example: A)Config

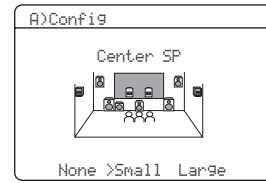

- You can change other items by repeating step 4.

5 To finish setting, press **SETUP**.



- If **Cursor** or other keys do not work after exiting the SETUP menu, select the input source again using **Input selection keys**.

Speaker Setup

You can set various items for speakers. Two kinds of adjustments are available. One is "1 Auto Setup (YPAO)" for automatic adjustment and another is "2 Manual Setup" for manual adjustment.



- The default settings are marked with "*".

1 Auto Setup

Automatically adjusts output characteristics of speakers to obtain optimum balance for the output sound based on positions and performances of the speakers and acoustic characteristics of the room, which are automatically measured. For details on operations, see page 21.

2 Manual Setup

Adjusts output characteristics of speakers based on manually set parameters.

After Auto Setup (YPAO) is performed, you can check automatically adjusted parameters in the Manual Setup menu. Fine adjust the parameters for your preference if necessary.

■ A)Config

Sets speaker configurations, such as connection status of speaker and a size of the connected speaker (sound reproduction capacity), suitable for the listening environment.



- The speaker configuration includes items for defining a speaker size: Large or Small. Large and Small refer to speakers with woofer diameters 16 cm or larger and smaller than 16 cm, respectively.

Extra SP Assign

Choices: Zone2*/Presence/None

Selects the application for EXTRA SP jacks.

Zone2 Assigns the EXTRA SP jacks for the speakers in the second zone.

Presence Assigns the EXTRA SP jacks for the Presence speaker.

None Disables the EXTRA SP jacks.

Note

- When setting "Extra SP Assign" to "Zone2" or "Presence," the surround back channel signals for main output is separately output from other channels.

LFE/Bass Out

Choices: SWFR/Front/Both*

Selects speaker(s) for outputting low-frequency components of the LFE (low-frequency effect sound) channel or other channels. The output status is as follows.

LFE channel signals

Parameter	Subwoofer	Front speakers	Other speakers
Both	Output	Not output	Not output
SWFR	Output	Not output	Not output
Front	Not output	Output	Not output

Low-frequency components of other channel signals

Parameter	Subwoofer	Front speakers	Other speakers
Both	[1]	[2]	[3]
SWFR	[4]	[3]	[3]
Front	Not output	[1]	[3]

- [1] Outputs low-frequency components of the front left and right channels and the channel of speaker, the size of which is set to "Small."
- [2] Outputs low-frequency components of the front left and right channels.
- [3] Outputs low frequency components when the sizes of speakers are set to "Large."
- [4] Outputs low-frequency components of the channel of speaker, the size of which is set to "Small."

Front SP

Choices: Small/Large*

Sets the sizes of front left and right speakers.

- Small** Select this when small speakers are connected. Low-frequency components of the front left and right channels are output from a subwoofer.
- Large** Select this when large speakers are connected.

Note

- When "LFE/Bass Out" is set to "Front," you can only select "Large." If "LFE/Bass Out" is changed to "Front," this parameter automatically switches to "Large" even when it is set to "Small."

Center SP

Choices: None/Small*/Large

Sets the size of center speaker.

- None** Select this when no center speaker is connected. Center channel signals are spread to front left and right speakers.
- Small** Select this when a small center speaker is connected. Low-frequency components of center channel are output from a subwoofer. If a subwoofer is not connected they are output from front speakers.
- Large** Select this when a large center speaker is connected.

Sur. L/R SP

Choices: None/Small*/Large

Sets sizes of left and right surround speakers.

- None** Select this when no surround speakers are connected. Surround channel signals are spread to front left and right speakers. "Sur.B L/R SP" automatically switches to "None" when this is selected.
- Small** Select this when small surround speakers are connected. Low-frequency components of surround channels are output from a subwoofer. If a subwoofer is not connected they are output from front speakers.
- Large** Select this when large surround speakers are connected.



- When "None" is selected, the sound field programs automatically enter the Virtual CINEMA DSP mode.

Sur. B L/R SP

Choices: None/SMLx1/SMLx2*/LRGx1/LRGx2

Sets sizes of left and right surround back speakers.

- None** Select this when no surround back speaker are connected. Surround back channel signals are output from the surround L/R speakers and subwoofer. If the subwoofer is disabled, they are output from the surround L/R speakers and front speakers.
- SMLx1** Select this when one small surround back speaker is connected.
- SMLx2** Select this when two small surround back speakers are connected.
- LRGx1** Select this when one large surround back speaker is connected.
- LRGx2** Select this when two large surround back speakers are connected.

Note

- When "None" is selected, "PLIIX Movie," "PLIIX Music," and "PLIIX Game" cannot be selected.

Crossover Freq.

Choices: 40Hz/60Hz/80Hz*/90Hz/100Hz/110Hz/120Hz/160Hz/200Hz

Sets the lower limit of the low frequency component output from a speaker with a size set to "Small (SMLx1/SMLx2)." Sound with a frequency below that limit is output from a subwoofer or front speakers.



- If your subwoofer has a volume control or a crossover frequency control, set the volume to half or the crossover frequency at the maximum.

Subwoofer Phase

Choices: Normal*/Reverse

Sets the phase of your subwoofer if bass sounds are lacking or unclear.

Normal Select this not to change the phase of your subwoofer.

Reverse Select this to reverse the phase of your subwoofer.

B)Level

Adjustable range: -10.0dB to +10.0dB (0.5 dB steps)
Defaults: "FR.L/FR.R/SWFR/PR.L/PR.R" 0dB
 "CNTR/SUR.L/SUR.R/SBL/SBR" -1.0dB

Separately adjusts volume of each speaker so that the sounds from speakers are at the same volume at the listening position. Items to be displayed vary depending on the number of speakers connected.



- When only one surround back speaker is connected, "SB" appears instead of "SBL" and "SBR."
- You can adjust the volume listening to test tones when you set "E)Test Tone" to "On" (see page 56).
- If your subwoofer has a volume control or a crossover frequency control, set the volume to half or the crossover frequency at the maximum.

C)Distance

Adjusts timing at which each speaker outputs sound so that sounds from speakers reach the listening position at the same time. Set the unit (Unit) first and then the distance of each speaker.

Unit

Choices: meters (m)/feet (ft)*

meters (m) Displays the speaker distance in meters.

feet (ft) Displays the speaker distance in feet.

Front L/Front R/Center/Sur. L/
 Sur. R/Sur.B L/Sur.B R/SWFR/
 PRNS L/PRNS R

Adjustable range: 0.30m to 24.00m (1.0ft to 80.0ft)
Defaults: 3.00m (10.0ft) "Front L/Front R/
 SWFR/PRNS L/PRNS R"
 2.60m (8.5ft) "Center"
 2.40m (8.0ft) "Sur. L/Sur. R/
 Sur. B L/Sur. B R/PRNS L/PRNS R"



- Different items are displayed depending on settings of "A)Config" (see page 54).
- When only one surround back speaker is connected, "Sur.B" appears instead of "Sur.B L" and "Sur.B R."

D)Equalizer

Adjusts sound quality and tone using a parametric graphic equalizer.

EQ Type Select

Choices: Auto PEQ/GEQ*/Off

Select an equalizer type.

Auto PEQ Uses a parametric equalizer selected in "1 Auto Setup." Characteristics of the currently used parametric equalizer (see page 21) are displayed below "Auto PEQ."

If Auto Setup is not executed, this parameter is not displayed.

GEQ Adjusts tone using a graphic equalizer. To display the adjustment menu, press **[ENTER]**.

Off Not use a graphic equalizer.

GEQ

Choices: 63Hz/160Hz/400Hz/1kHz/2.5kHz/
 6.3kHz/16kHz

Adjustable range: -6.0dB to 0dB* to +6.0dB (0.5 dB steps)

Adjusts sound quality of each speaker using a graphic equalizer. The graphic equalizer of this unit can adjust signal levels in 7 frequency ranges.

To adjust the signal level within each range, select the desired speaker with **[Cursor] </>** while "→" is displayed next to "Channel," then the desired frequency band with **[Cursor] Δ / ∇**, and adjust the signal level with **[Cursor] </>**.

E)Test Tone

Choices: Off*/On

Switches test tones on and off. To generate test tones select "On" using **[Cursor] </>**. When "On" is selected, you can adjust the settings of "2 Manual Setup" while listening to a test tone.

Off Does not generate test tones.

On Generates test tones.

Sound Setup

You can set various items for sound outputs.



- The default settings are marked with "*".

1 Dynamic Range

Choices: Min/Auto/STD/Max*

Selects the dynamic range adjustment method for reproducing bitstream signals.

Min/Auto (Min) Sets the dynamic range suitable for low volume or a quiet environment, such as at night, for bitstream signals except for Dolby TrueHD signals.

(Auto) Adjusts the dynamic range for Dolby TrueHD signals based on input signal information.

STD Sets the standard dynamic range recommended for regular home use.

Max Outputs sound without adjusting the dynamic range of the input signals.

■ 2 Lipsync

Adjusts delay between video output and audio output.

HDMI Auto

Choices: Off*/On

Automatically adjusts output timing of audio and video signals when a monitor that supports an automatic lip-sync function is connected to this unit.

- Off Select this when the connected monitor does not support the automatic lip-sync function or that function is not to be used. Set the correction time in “Manual Delay.”
- On Select this when the connected monitor supports the automatic lip-sync function. Fine adjust the correction time in “Auto Delay.”

Auto Delay

Adjustable range: 0* to 240ms (1 ms steps)

Fine adjusts the correction time when “HDMI Auto” is set to “On.” The actual correction time is displayed under in “Auto Delay” field and an offset time set by the user in “offset” field.

Manual Delay

Adjustable range: 0* to 240ms (1 ms steps)

Manually fine adjusts the correction time. Select this when the connected monitor does not support the automatic lip-sync function or you set “HDMI Auto” to “Off.”

Function Setup

You can set various items for HDMI and display.



- The default settings are marked with “*.”

1 HDMI

You can set items for HDMI.

■ Control

Choices: On/Off*

Selects on or off of HDMI control functions when a component that supports the HDMI control functions is connected with this unit.

When this is set to “On,” signals input from the HDMI 1-4 jacks are output to a monitor component even when this unit is on standby.

- On Enables the HDMI control function.
- Off Disables the HDMI control function.

■ Standby Through

Choices: On/Off*

Selects on or off of output of HDMI signals input from the HDMI 1-4 jacks to the HDMI OUT jack when this unit is on standby. When this parameter is set to “On” signals input from the HDMI 1-4 jacks can be output to a monitor component.

This item is not displayed when “Control” is set to “On.”

- On Outputs the HDMI signals to the HDMI OUT jack.
- Off Does not output the HDMI signals to the HDMI OUT jack.



- To enables pass-through output, any one of the input sources connected to the HDMI 1-4 jacks must be selected before switching to standby.
- During pass-through output, the HDMI THROUGH indicator on the front panel display lights up. While the indicator lights up, it consumes 1 to 3W of power depending on a condition of an HDMI signal passing through this unit.

■ Audio Output

Choices: AMP*/TV/AMP+TV

Selects this unit or a component connected to this unit via the HDMI OUT jack of this unit for reproducing sound signals input from the HDMI 1-4 jacks.

This item is not displayed when “Control” is set to “On.”

- AMP Outputs HDMI sound signals from the speakers connected to this unit.
- TV Outputs HDMI sound signals from the speakers of a TV connected to this unit. Sound output from the speakers connected to this unit is muted.
- AMP+TV Outputs HDMI sound signals from the speakers connected to this unit and the speakers of a TV connected to this unit.

Note

- When “TV” or “Amp+TV” is selected, signal formats of audio and video signals output from this unit to the monitor vary depending on specifications of the monitor.

■ Resolution

Choices: Through*/480P/720P/1080i/1080P

Upscales the resolution of HDMI output that is converted from analog video input signals and output from the HDMI OUT jack.

Notes

- Resolution of the HDMI output converted from 720p or 1080i video signals cannot be upscaled.
- When a video monitor is connected to this unit via the HDMI jack, this unit automatically detects a resolution that the monitor supports. An asterisk (*) appears on the left of the detected resolution.
- If this unit cannot detect the resolution that the monitor supports, set “MON.CHK” in the ADVANCED SETUP menu to “SKIP” (see page 64) and try it again.

■ Aspect

Choices: Through/16:9/Smart

Set a horizontal to vertical ratio (aspect ratio) of images reproduced by HDMI signals output from the HDMI OUT jack when the HDMI signals are converted from analog video input signals by a video conversion function.

- Through Outputs the video signals without changing the aspect ratio.
- 16:9 Outputs the video signals that displays 4:3 images on a 16:9 monitor with black bands on the right and left sides of the monitor screen.
- Smart Outputs the video signals that displays 4:3 images on a 16:9 monitor by stretching right and left of images to fit on the monitor screen.

Notes

- You cannot change the aspect ratio of the screen when "Resolution" is set to "Through."
- The setting is not effective for inputs with the aspect ratio other than 4:3.
- You cannot obtain an effect of the aspect ratio when video signals are input from the HDMI 1-4 jacks or 720p, 1080i or 1080p signals are input.

2 Display

You can change some parameters for a monitor or the front panel display.

■ Dimmer

Adjustable range: -4 to 0*

Sets brightness of the front panel display. As the value is lowered, the brightness of the front panel display is darkened.

Note

- The brightness of display does not become bright in Pure Direct mode even if the value is increased.

■ FL Scroll

Choices: Continue*/Once

Selects the way to scroll the screen when a total number of characters exceed a display area of the front panel display.

- Continue Repeatedly displays all characters by scrolling.
- Once Displays all characters by scrolling once, halts scrolling, and then displays first 14 characters.

■ OSD Shift

Adjustable range: -5 to 0* to +5

Adjusts top and bottom positions of the OSD (on-screen display) menus. To move up the screen, set this value larger. To move down the screen, set it smaller.

3 Volume

You can change some parameters for volumes.

■ Adaptive DRC

Choices: Auto/Off*

Adjusts the dynamic range in conjunction with the volume level. This function is useful when you are listening at lower volumes or at night. When this function is enabled, the dynamic range is adjusted as follows.

If the volume setting is low:

the dynamic range is narrow

If the volume setting is high:

the dynamic range is wide

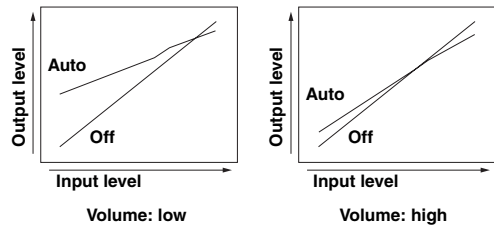

- Auto Adjusts the dynamic range automatically.
- Off Does not adjust the dynamic range automatically.



- The "Adaptive DRC" setting is effective for headphones.

■ Max Volume

Adjustable range: -30.0dB to +15.0dB/+16.5dB* (5.0 dB steps)

Sets the maximum volume level so that the volume will not be accidentally increased. For example, you can adjust the volume between -80.0 dB and -5.0 dB or mute when you set this parameter to "-5.0dB." The volume increases to the maximum level when this parameter is set to +16.5 dB (default).

■ Init. Volume

Choices: Off*/Mute/-80.0dB to +16.5dB (0.5 dB steps)

Sets the volume at the time this unit is turned on. When this parameter is set to "Off," the volume is set to a level that last time this unit is set to standby.

Note

- If the setting of "Max Volume" is lower than the setting of "Init. Volume," the setting of "Max Volume" becomes effective. For example, when you set "Max Volume" to "-30.0dB" and "Init. Volume" to "0.0dB," the volume is automatically set to "-30.0dB" at the next time this unit is turned on.

4 Input Rename

You can change input source names to be displayed on the front panel display.

You can select an input source that you want to change the name to be displayed using **[F1] Cursor**.

Selecting a name to be displayed from templates

Select an input source that you want to change the name, and select a name from the following templates using **[F1] Cursor**.

- | | |
|-------------|-------------|
| - Blu-ray | - Satellite |
| - DVD | - VCR |
| - SetTopBox | - Tape |
| - Game | - MD |
| - TV | - PC |
| - DVR | - iPod |
| - CD | - HD DVD |
| - CD-R | - "blank" |



- If you change the display name of an input source to your original one and select the input source, the current input source name and the template name are displayed. This is convenient if you want to cancel name change operation.

Entering an original name

Select an input source that you want to name, and press **[F1] ENTER**. You can enter up to 9 characters by selecting one character at a time with the following keys according to the following operation.

- [F1] Cursor** < / > For selecting characters that you want to change
- [F1] Cursor** Δ / ▽ For selecting characters to be entered
- [F1] ENTER** For entering the selected characters

The following characters are available for input.

A to Z, 0 to 9, a to z, symbols (#, *, -, +, etc.) and space

5 Zone2

You can set the maximum volume level and initial volume level of Zone2.



- This item is displayed only when "Extra SP Assign" is set to "Zone2."

■ Max Volume

Adjustable range: -30.0dB to +15.0dB / +16.5dB*
(5.0 dB steps)

Sets the maximum volume level of Zone2 so that the volume will not be accidentally increased. For example, you can adjust the volume between -80.0 dB and -5.0 dB or mute when you set this parameter to "-5.0dB."

■ Init. Volume

Choices: Off*/Mute/-80.0dB to +16.5dB (0.5 dB steps)

Sets the volume level of Zone2 when the power of Zone2 unit is turned on.

Note

- If the setting of "Max Volume" is lower than the setting of "Init. Volume," the setting of "Max Volume" becomes effective. For example, when you set "Max Volume" to "-30.0dB" and "Init. Volume" to "0.0dB," the volume is automatically set to "-30.0dB" at the next time this unit is turned on.

DSP Parameter

You can change some parameters for the sound field programs. For details, see page 49.

Memory Guard



- The default settings are marked with "*".

Choices: Off*/On

Protects settings of SETUP menu against accidental alteration.

Off

Does not protect settings.

On

Protects the settings of the SETUP menu (except for the Memory Guard setting).

Note

- When this parameter is switched to "On," "G" appears while the SETUP menu is displayed on the video monitor.

Using multi-zone configuration

This unit allows you to configure a multi-zone audio system. The Zone2 feature allows you to set this unit to reproduce separate input sources in the main zone and the second zone (Zone2). You can control this unit from the second zone using the supplied remote control.

Only analog signal can be sent to Zone2. If you want to output sound from Zone2, connect an external component to AV5-6 or AUDIO1-2 by analog connection. For example, if you want to output sound from an HDMI DVD player in Zone2, you must connect the component to this unit by both HDMI and analog connections.

Connecting Zone2

You need the following additional equipment to use the multi-zone functions of this unit:

- An infrared signal receiver in the second zone.
- An infrared signal emitter in the main zone. This emitter transmits infrared signals from the remote control to a CD player or a DVD player, etc. in the main zone via the infrared signal receiver in the second zone.
- An amplifier and speakers in the second zone.



- Since there are many possible ways to connect and use this unit in a multi-zone configuration, we recommend that you consult with your nearest authorized Yamaha dealer or service center about the Zone2 connections that best meet your requirements.
- Some Yamaha models can be directly connected to the REMOTE jacks of this unit. These models may not require an infrared signal emitter. Up to 6 Yamaha components can be connected as shown below.

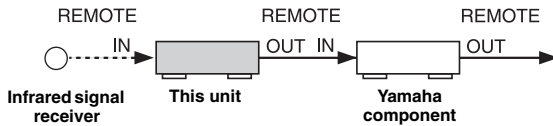

Using the external amplifier

You can connect the amplifier/receiver in the second zone and other components to this unit as follows.

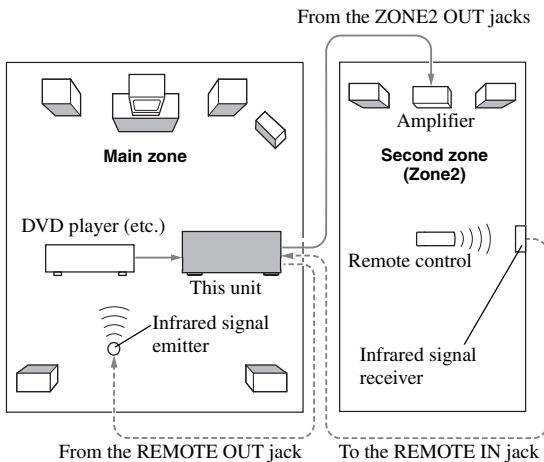

Note

- To avoid unexpected noise, DO NOT USE the Zone2 feature with CDs encoded in DTS.

Using the internal amplifier of this unit

Important safety notice

The EXTRA SP jacks of this unit should not be connected to a Passive Loudspeaker Selector Box or more than one loudspeaker per channel. Connection to a Passive Loudspeaker Selector Box or multiple speakers per channel could create an abnormally low impedance load resulting in amplifier damage. See this owner's manual for correct usage. Compliance with minimum speaker impedance information for all channels must be maintained at all times. This information is found on the back panel of this unit.

Connect the speakers in the second zone to the EXTRA SP jacks and then set the "Extra SP Assign" to "Zone2" (see page 54).

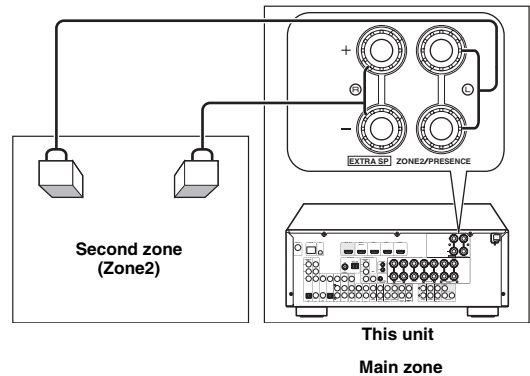

- You can use the speakers connected to the EXTRA SP jacks as the front speaker system of another zone. Set "Extra SP Assign" to "Zone2" (see page 54).
- When you use the internal amplifiers for the Zone2 speakers, you can adjust the volume level and set the initial volume and maximum volume of the Zone2 speakers (see page 59).

Controlling Zone2

You can select and control Zone2 by using the control keys on the front panel or on the remote control. The available operations are as follows:

- Selecting the input source (AV5-6, AUDIO1-2, V-AUX) of Zone2.
- Adjusting the volume of Zone2 (when a Zone2 speaker is connected to the EXTRA SP jack).
- Tuning into FM or AM when “TUNER” is selected as the input source of Zone2 (see page 31).
- Tuning into XM Satellite Radio when “XM” is selected as the input source of Zone2 (see page 33) (U.S.A. model only).
- Tuning into SIRIUS Satellite Radio when “SIRIUS” is selected as the input source of Zone2 (see page 37) (U.S.A. model only).
- Playing back music stored on your iPod stationed in a Yamaha iPod universal dock (such as YDS-11 sold separately) connected to the DOCK jack.
- You can play back music stored on a Bluetooth component via a Bluetooth wireless audio receiver (sold separately) connected to the DOCK jack (see page 44).

Note

- You must complete each step while the ZONE2 indicator is flashing on the front panel display. Otherwise, the Zone2 mode is automatically canceled and this unit returns to the normal operation mode. In this case, repeat the Zone2 selection procedure.

Controlling Zone2 with the front panel

■ Turning on Zone2

Press **Ⓞ** **ZONE2 ON/OFF** to turn on Zone2.

■ Activating the Zone2 operation mode

Press **Ⓢ** **ZONE2 CONTROL** to control Zone2.

The ZONE2 indicator flashes on the front panel display for approximately 10 seconds.

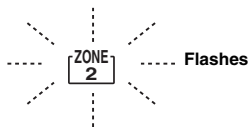

■ Operating Zone2

Rotate the **Ⓡ** **INPUT selector** to select the desired input source while the ZONE2 indicator on the front panel display is flashing.

- When AV5-6, AUDIO1-2 or V-AUX is selected, you can listening to the input source in Zone2.
- Select “TUNER” as the input source to use the TUNER features in Zone2. For details about the TUNER operations, see “FM/AM tuning” on page 31.
- Select “XM” as the input source to use the XM Satellite Radio features in Zone2. For details about the XM Satellite Radio operations, see “XM Satellite Radio tuning” on page 33.

- Select “SIRIUS” as the input source to use the SIRIUS Satellite Radio features in Zone2. For details about the SIRIUS Satellite Radio operations, see “SIRIUS Satellite Radio tuning” on page 37.
- Select “DOCK” as the input source to use iPod features in Zone2. For details about the iPod operations, see “Using iPod” on page 42.
- Select “DOCK” as the input source to use Bluetooth component features in Zone2. For details about the Bluetooth component operations, see “Using Bluetooth components” on page 44.

■ Setting Zone2 to standby

Press **Ⓞ** **ZONE2 ON/OFF** to set Zone2 to standby.

Controlling Zone2 with the remote control

■ Turning on Zone2

Set **Ⓡ** **MAIN/ZONE2** to the ZONE2 position, and press **Ⓟ** **POWER**.

■ Operating Zone2

Set **Ⓡ** **MAIN/ZONE2** to the ZONE2 position, and press one of the input selection keys to select the desired input source of Zone2.

Note

- **Ⓡ** **MUTE** and **Ⓡ** **VOLUME +/-** are available to control Zone2 with same procedure as mentioned above.

■ Setting Zone2 to standby

Set **Ⓡ** **MAIN/ZONE2** to the ZONE2 position, and press **Ⓟ** **POWER**, then set ZONE2 to standby.

Controlling other components with the remote control

You can control external components for a selected input source with the remote control. The keys available for controlling external components are as follows:

4 SOURCE POWER

Turns on and off an external component.

11 Cursor, ENTER, RETURN

Operates the menus of external components.

20 DISPLAY

Switches between the screens of external components.

12 External component operation keys

Function as a recording or playback key of an external component, or a menu display key.

13 Numeric keys

Function as numeric keys of an external component.

14 TV control keys

INPUT Switches video inputs of TV

MUTE Mute audio of TV

TV VOL +/- Controls the volume of TV

TV CH +/- Switches channels of TV

POWER Turns on and off TV



- You need to set the remote control code first to control external components.
- The remote control keys for controlling external components are available only when the external components have corresponding control keys.

The following remote control codes are assigned to input sources as factory default settings. For a complete list of available remote control codes, refer to “List of remote control codes” at the end of this manual.

Default remote control code settings

Input source	Category	Manufacturer	Default code
[HDMI1]	Blu-ray Disc	Yamaha	2018
[HDMI2]	—	—	—
[HDMI3]	—	—	—
[HDMI4]	—	—	—
[AV1]	—	—	—
[AV2]	—	—	—
[AV3]	CD	Yamaha	5013
[AV4]	—	—	—
[AV5]	—	—	—
[AV6]	—	—	—
[AUDIO1]	—	—	—
[AUDIO2]	—	—	—
[V-AUX]	—	—	—
[A]/[B]	—	—	—
[DOCK]	DOCK	Yamaha	5011
[TUNER]	Tuner	Yamaha	5007
[XM]	Tuner	Yamaha	5017
[SIRIUS]	Tuner	Yamaha	5009
[MULTI CH]	—	—	—

“—” indicates no assignment



- An external component that is controlled by the remote control can be automatically selected according to the **SCENE** key selection (see page 25).

Setting remote control codes

You can control other components by setting the appropriate remote control codes. For a complete list of available remote control codes, refer to “List of remote control codes” at the end of this manual.



- Each of the steps described in this section should be performed within one minute. Setting operation is automatically canceled when one minute has passed since the last step. If the operation is cancelled, start again from the beginning.

- 1 Press **[15]**CODE SET on the remote control using a pointed object such as the tip of a ballpoint pen.**
[3]TRANSMIT on the remote control blinks twice.

- 2 Press **[5]**Input selection keys corresponding to the input source whose remote control code you want to register.**

- 3 Enter a remote control code using **[13]**Numeric keys.**
Once the remote control code is registered, **[3]TRANSMIT** on the remote control blinks twice. If it fails, **[3]TRANSMIT** blinks six times. Repeat from step 1.

Resetting all remote control codes

You can clear all the remote control codes previously set, and reset all of them to the initial factory settings.



- Each of the steps described in this section should be performed within one minute. Setting operation is automatically canceled when one minute has passed since the last step. If the operation is cancelled, start again from the beginning.

- 1 Press **[15]**CODE SET on the remote control using a pointed object such as a tip of a ballpoint pen.**
[3]TRANSMIT on the remote control blinks twice.

- 2 Press **[10]**SETUP on the remote control.**

- 3 Enter “9981” using **[13]**Numeric keys.**
Once the initialization is complete, **[3]TRANSMIT** on the remote control blinks twice. If it fails, **[3]TRANSMIT** blinks six times. Repeat from step 1.

Advanced setup

The advanced setup includes more parameters for basic operation of this unit such as turning a bi-amp connection on and off and initializing user settings. This section describes what those parameters are and how to change them.

1 Set this unit to standby.

2 Press **Ⓐ**MAIN ZONE ON/OFF while pressing and holding **Ⓟ**STRAIGHT on the front panel.

The ADVANCED SETUP menu appears on the front panel display.



ADVANCED SETUP

3 Rotate the **Ⓞ**PROGRAM selector to select the parameter you want to change.



- Set values are placed in XXX of the following parameters on an actual display screen.
- The default setting are marked with “*.”

SP IMP. -XXX

Choices: 6ΩMIN/8ΩMIN*

Selects output impedance of this unit according to connected speakers. When you connect 4-ohm speakers to the FRONT jacks of the SPEAKERS terminals, set “SP IMP.” to “6ΩMIN.”

REMOTE ID -XXX

Choices: ID1*/ID2

Selects a remote control ID for this unit. When using multiple Yamaha AV receivers, you can operate them with a single remote control by setting them to have the same remote control ID. By setting the receivers to have different remote control IDs, you can operate them with their respective remote controls.

SR PIN -XXX

Choices: RESET/CANCEL*

Resets Parental lock cord when using SIRIUS Satellite tuner.

BI AMP - XXX

Choices: ON/OFF*

Switches on and off of bi-amp connection of main speakers. For bi-amp connection, see page 13.

SCENE IR -XXX

Choices: ON*/OFF

Selects whether or not to transmit the SCENE control signals to an external component connected to the REMOTE jacks on this unit when BD/DVD or CD SCENE function is selected. If “ON” is selected and a playback component that supports the SCENE link playback, such as a Yamaha DVD player, is connected to the REMOTE OUT jack of this unit, remote connection automatically starts playback when a different SCENE key is selected.

MON. CHK - XXXX

Choices: YES*/SKIP

Adds upscaling limitation on output signals to a video monitor connected to this unit via the HDMI OUT jack.

INIT-XXXXXXXXXX

Choices: DSP PARAM/VIDEO/ALL/CANCEL*

Initializes various settings stored in this unit. You can select an initialization method from the following.

DSP PARAM: Resets all parameters of sound field programs.

VIDEO: Resets video conversion settings (resolution/aspect) in the SETUP menu and the OSD menus display position.

ALL: Resets this unit to initial factory settings.

CANCEL: Initialization.

4 Press **Ⓟ**STRAIGHT a few times to select the value you want to change.

The value selected here becomes effective when this unit is turned on the next time. You can change multiple settings by repeating steps 3 and 4.

5 Press **Ⓐ**MAIN ZONE ON/OFF, turns off this system, and press **Ⓐ**MAIN ZONE ON/OFF again.

The value set in step 4 becomes effective, and this unit turns on. When you select initialization in step 3, the initialization is performed.

Setting a remote control ID

Two IDs are provided for the remote control of this unit. If another Yamaha amplifier is in the same room, setting a different remote control ID to this unit prevents unwanted operation of the other amplifier.

ID1 is set for both remote control and amplifier by default.

When you change the remote control ID, display “ADVANCED SETUP” (see the previous section) and change the ID for the amplifier too.



- Each of the steps described in this section should be performed within one minute. Setting operation is automatically canceled when one minute has passed since the last step. If the operation is cancelled, start again from the beginning.

1 Press **[15]CODE SET** on the remote control using a pointed object such as the tip of a ballpoint pen.

[3]TRANSMIT blinks twice.

2 Press **[10]SETUP** on the remote control.

3 Enter the desired remote control ID code.

To switch to ID1:

Enter “5019” using **[13]Numeric keys**.

To switch to ID2:

Enter “5020” using **[13]Numeric keys**.

Once the remote control code is registered,

[3]TRANSMIT blinks twice.

If it fails, **[3]TRANSMIT** blinks six times. Repeat from step 1.



- Initializing the remote control code (see page 63) returns it to ID1.

APPENDIX

Troubleshooting

Refer to the table below when this unit does not function properly. If the problem you are experiencing is not listed below or if the instruction below does not help, turn off this unit, disconnect the power cable, and contact the nearest authorized Yamaha dealer or service center.

General

Problem	Cause	Remedy	See page
This unit turns off soon after being turned on, or does not turn on after Ⓐ MAIN ZONE ON/OFF (or Ⓘ POWER) is pressed.	The power cable is not connected or the plug is not completely inserted.	Connect the power cable properly to an AC wall outlet.	—
	The speaker impedance setting is incorrect.	Set the speaker impedance to match your speakers.	64
	(When this unit is turned back on and “CHECK SP WIRES!” is displayed.) The protection circuitry has been activated because this unit was turned on while a speaker cable was shorted.	Make sure that all speaker cables between this unit and speakers are connected properly.	13
This unit cannot be turned off or does not work properly.	The internal microcomputer is frozen due to an external electric shock (such as lightning or excessive static electricity) or by a drop in power supply voltage.	Disconnect the power cable from the AC wall outlet, wait about 30 seconds and then plug it in again.	—
This unit suddenly enters the standby mode.	The internal temperature becomes too high and the overheat protection circuitry has been activated.	Wait about 1 hour for this unit to cool down and then turn it back on.	—
Sound/images suddenly go off.	The protection circuitry has been activated because of a short circuit, etc.	Check that the speaker impedance setting is correct.	64
		Check that the speaker wires are not touching each other and then turn this unit back on.	—
	The sleep timer has turned off this unit.	Turn on this unit, and play the source again.	—
“CHECK SP WIRES!” appears on the front panel display.	Speaker cables are short-circuited.	Make sure all speaker cables are connected correctly.	13
“Memory Guard!” is displayed on the front panel display and the setting cannot be changed.	“Memory Guard” in the SETUP menu is set to “On.”	Set “Memory Guard” to “Off.”	59
The picture is disturbed.	The video software is copy-protected.		

Problem	Cause	Remedy	See page
No sound.	Incorrect input or output cable connections.	Connect the cables properly. If the problem persists, the cables may be defective.	15-19
	Speaker connections are not secure.	Secure the connections.	11
	The HDMI components connected to this unit do not support the HDCP copy protection standards.	Connect HDMI components that support the HDCP copy protection standards.	79
	The HDMI audio output parameter in the SETUP menu (Function Setup → 1 HDMI → Audio Output) is set to "TV."	Set the parameter to an item other than "TV."	57
	No appropriate input source has been selected.	Select an appropriate input source with the Ⓡ INPUT selector (or 5 Input selection keys).	24
	The volume is turned down or muted.	Turn up the volume.	—
	Signals that this unit cannot reproduce are being input from a source component, such as a CD-ROM.	Use an input source whose signals are reproducible on this unit.	—
	A proper audio decoder is not selected.	Display the OPTION menu and set "Decoder Mode" to "Auto."	47
No picture.	The video signal output from this unit is not supported by a monitor connected to this unit via the HDMI OUT jack.	Displays the ADVANCED SETUP menu and select "VIDEO" in "INIT" to reset the video parameters.	64
		Displays the ADVANCED SETUP menu and set "MON.CHK" to "YES."	64
	The VIDEO jack is used to output a component video signal, or the COMPONENT VIDEO jacks are used to output a composite video signal.	If your video monitor does not support the HDMI connection, connect it to the COMPONENT VIDEO jacks and the VIDEO jack and select an appropriate video input on the monitor.	15
	Non-standard video signals are input.	Connect the monitor to this unit via the COMPONENT VIDEO jacks or the VIDEO jack.	15
	An appropriate video input is not selected on the video monitor.	Select an appropriate video input on the video monitor.	—

Problem	Cause	Remedy	See page
No sound is output from a specific speaker.	The speaker is in malfunction.	Check the Speaker indicators on the front panel display. If the corresponding indicator lights up, connect another speaker and check if sound is output. If sound is not output, this unit may be malfunction.	6, 10
	The playback component or speakers are not connected properly.	Connect the cables properly. If the problem persists, the cables may be defective.	11
	Output from that speaker is disabled.	Check the Speaker indicators on the front panel display. If the corresponding indicator is turned off, try the following. 1) Change the input source to another one. 2) With the selected sound field program, sound is not output from that speaker. Select another sound field program. 3) "None" may have been selected for that speaker on this unit. Display Speaker Setup in the SETUP menu and set respective parameters to enable output from that speaker (Speaker Setup → 2 Manual Setup → A)Config).	6, 24, 27, 55
	The volume of that speaker is set to the minimum in Speaker Setup in the SETUP menu.	Display Speaker Setup in the SETUP menu and adjust the volume (2 Manual Setup → B)Level).	56
	(If hardly any sound comes from one channel) Speaker output balance is not properly set.	Set the volume of each speaker to be balanced from "B)Level" in the SETUP menu (Speaker Setup → 2 Manual Setup → B)Level).	56
	Sound may not be output from certain channels depending on the input source or sound field program.	Try another sound field program.	27
Only the center speaker outputs substantial sound.	When a monaural source sound field program is applied, sound of all channels are output from the center speaker for some surround decoders.	Try another sound field program.	27
No sound is heard from the presence speakers.	This unit is in "STRAIGHT" mode.	Press ⓅSTRAIGHT (or ⓈSTRAIGHT) to exit "STRAIGHT" mode.	30
No sound is heard from the surround speakers.	This unit is in STRAIGHT mode and a monaural source is being played back.	Press ⓅSTRAIGHT (or ⓈSTRAIGHT) to exit STRAIGHT mode.	30
	Sound may not be output from certain channels depending on input sources or sound field programs.	Try another sound field program.	27
No sound is heard from the subwoofer.	A Dolby Digital or DTS signal is reproduced while the LFE channel setting (LFE/Bass Out) of the Speaker Setup in the SETUP menu is set to "Front."	Set "LFE/Bass Out" to "SWFR" or "Both."	55
	A 2-channel signal is reproduced while the LFE channel setting (LFE/Bass Out) of the Speaker Setup in the SETUP menu is set to "SWFR" or "Front."	Set "LFE/Bass Out" to "Both."	55
	The source does not contain LFE or low frequency signals.		

Problem	Cause	Remedy	See page
No sound is heard from the surround back speakers.	“Extended Surround” in the OPTION menu is set to “Off,” or an input signal does not contain a surround back flag with “Extended Surround” set to “Auto.”	Set “Extended Surround” other than “Off” or “Auto.”	47
The audio input sources cannot be played in the desired digital audio signal format.	The connected component is not set to output the desired digital audio signals.	Set the playback component properly referring to its instruction manuals.	—
There is noise interference from digital or radio frequency equipment.	This unit is too close to other digital or radio frequency equipment.	Move this unit further away from such equipment.	—
Noise/hum noise is heard.	Incorrect cable connection.	Connect the audio cables properly. If the problem persists, the cables may be defective.	—
	A DTS-CD is being played back.	1) When only noise is output If a DTS bitstream signal is not properly input to this unit, only noise is output. Connect the playback component to this unit by digital connection and play back the DTS-CD. If the condition is not improved, the problem may result from the playback component. Consult the manufacturer of the playback component. 2) When noise is output during playback or skip operation Before playing back the DTS-CD, display the OPTION menu after selecting the input source and set “Decoder Mode” to “DTS.”	16, 47
The volume cannot be increased or the sound is distorted.	The component connected to the output jacks of this unit is not turned on.	When the component connected to the output jacks of this unit is not turned on, the sound may be distorted or the volume may decrease due to the nature of AV receivers. Turn on all components connected to this unit.	—
	“Max Volume” is set to a low value.	Set it to a higher value.	58

HDMI™

Problem	Cause	Remedy	See page
No picture or sound.	The number of the connected HDMI components is over the limit.	Disconnect some of the HDMI components.	—
	The connected HDMI component does not support high-bandwidth digital copyright protection (HDCP).	Connect an HDMI component that supports HDCP.	16

Tuner (FM/AM)

	Problem	Cause	Remedy	See page		
FM	FM stereo reception is noisy.	You are too far from the station transmitter or the input from the antenna is weak.	Check the antenna connections.	20		
			Replace the outdoor antenna with a more sensitive multi-element antenna.	—		
			Switch to monaural mode.	48		
FM	There is distortion, and clear reception cannot be obtained even with a good FM antenna.	There is multi-path interference.	Adjust the antenna height or orientation, or place it in a different location.	—		
			The desired station cannot be tuned into with the automatic tuning method.	You are in an area far from a station or an input from the antenna is weak.	Replace an outdoor antenna with more sensitive multi element antenna.	—
					Tune in manually or by direct frequency tuning.	31
FM	The desired station cannot be tuned into with the automatic tuning method.	The signal is weak or the antenna connections are loose.	Adjust the AM loop antenna orientation.	20		
			Use the manual tuning method.	31		
			Automatic station preset does not work.	Automatic station preset is not available for AM stations.	Use manual station preset.	32
AM	There are continuous crackling and hissing noises.	Supplied AM loop antenna is not connected.	Connect the AM loop antenna correctly even if you use an outdoor antenna.	20		
		The noises may be caused by lightning, fluorescent lamps, motors, thermostats and other electrical equipment.	It is difficult to completely eliminate noise, but it can be reduced by installing and properly grounding an outdoor AM antenna.	20		
		There are buzzing and whining noises.	A TV set is being used nearby.	Move this unit away from the TV set.	—	

XM Satellite Radio (U.S.A. model only)

If an operation takes longer than usual or an error occurs, one of the following messages may appear on the front panel display. In this case, read the cause and follow the corresponding remedies.

Status message	Cause	Remedy	See page
CHECK XM TUNER	The XM Mini-Tuner is not installed in the XM Mini-Tuner Home Dock or the XM Mini-Tuner Home Dock is not connected to this unit.	Confirm the XM Mini-Tuner is fully seated in the dock and check the XM Mini-Tuner Home Dock cable is connected to this unit.	33
CHECK ANTENNA	The XM antenna is not connected to the XM Mini-Tuner Home Dock or the XM antenna cable has become damaged.	Check that the XM antenna is securely connected to the XM Mini-Tuner Home Dock and check the antenna cable for damage. Replace the XM antenna if the cable is damaged.	33
LOADING XM	The XM Mini-Tuner is acquiring audio or program information from the XM satellite signal. This message can also occur in weak XM signal conditions. Note that this unit may not respond to some operations while this message is displayed.	This message should disappear in a few seconds in good signal conditions. If you see this message often, reposition the XM antenna to get better signal reception. Check the antenna reception level from the "Antenna" information on the front panel display or "ANT" or "XM Information" on the video monitor.	36

Status message	Cause	Remedy	See page
NO SIGNAL	The XM Mini-Tuner is not receiving the XM satellite signal. Something may be blocking the XM antenna's view of the satellites or the antenna is not properly aimed.	Check for antenna obstructions and reposition the XM antenna to get better signal reception. Check the antenna reception level from the "Antenna" information on the front panel display, or "ANT" or "XM Information" on the video monitor. See instructions supplied with the XM Mini-Tuner and Dock for antenna installation information.	36
CH OFF AIR	The XM channel you selected is not currently broadcasting.	Check back at a later time; in the meantime, select another channel.	—
CH UNAUTH	You may be attempting to tune to an XM channel that is blocked or that you cannot receive with your XM subscription package.	Consult the latest channel guide at http://www.xmradio.com/ for the current list of channels. For information on receiving this channel, visit http://www.xmradio.com/ or contact XM Satellite Radio at 1-800-967-2346.	33
CH UNAVAIL	The selected channel is not available. The channel may have been reassigned to a different channel number. This message may occur initially with a new XM Mini-Tuner or an XM Mini-Tuner that has not received XM's signal for an extended period.	Consult the latest channel guide at http://www.xmradio.com/ for the current list of channels. For cases of a new XM Mini-Tuner or an XM Mini-Tuner that has not received XM's signal for an extended period, allow the XM Mini-Tuner to receive the XM satellite signal for at least 5 minutes and then try to select the channel again.	—
UPGRADE XM TUNER	This unit has detected a XM CNP1000 which is not compatible with this unit.	If you have connected the XM Mini-Tuner (CNP2000) and see this message, set this unit to standby, disconnect and reconnect the XM Mini-Tuner Home Dock and re-install the Mini-Tuner in the Home Dock and turn on this unit. If you continue to see this message with the XM Mini-Tuner, contact XM Satellite Radio at http://xmradio.com/ or 1-800-XMRADIO (1-800-967-2346). If you have an incompatible XM CNP1000, contact XM for information on upgrading to the XM Mini-Tuner.	—
- - - -	No artist name or song title is available for this selection.	No action required.	—

SIRIUS Satellite Radio™ (U.S.A. model only)

If an operation takes longer than usual or an error occurs, one of the following messages may appear on the front panel display. In this case, read the cause and follow the corresponding remedies.

Status message	Cause	Remedy	See page
ANTENNA ERROR	The antenna is not connected to the SiriusConnect tuner properly.	Check the connection of the antenna and SiriusConnect tuner.	37
SIRIUS LOADING	This unit is communicating with the SiriusConnect tuner.	The message disappears normally within several tens of seconds.	—
CHECK SR TUNER	The SiriusConnect tuner is not connected to the SIRIUS jack of this unit correctly.	Check the connection of the SiriusConnect tuner and this unit.	37
	The SiriusConnect tuner is not connected to the AC wall outlet.	Connect the power cable of the SiriusConnect tuner to the AC wall outlet.	37
NOT SUPPORTED	This unit does not support the connected SIRIUS Satellite Radio tuner.	Connect the SiriusConnect tuner that this unit supports,	37

Status message	Cause	Remedy	See page
ACQUIRING	The signal is too weak.	Adjust the orientation of the antenna of the SiriusConnect tuner. Check the antenna reception level from the "Antenna" information on the front panel display, or "ANT" or "SIRIUS Information" on the video monitor.	41
UPDATING	The SiriusConnect tuner is updating the channel list.	Wait until the updating is complete.	—
	The period of the subscription is end.	Contact SIRIUS Satellite Radio to renew the subscription.	37
F/W UPDATING	The SiriusConnect tuner is updating the firmware.	Wait until the updating is complete.	—
CALL SIRIUS (CALL 888-539- SIRIUS TO SUBSCRIBE)	The selected channel is not subscribed.	Contact SIRIUS Satellite Radio to subscribe the selected channel. URL: https://activate.siriusradio.com/ Phone: 1-888-539-SIRIUS (1-888-539-7474)	37
		Select another channel.	37
SUB UPDATED	The subscription information is updated.		
INVALID	The selected channel is currently out of service.	Select another channel.	37
Not Available	The operation you made is not available.		

Remote control

Problem	Cause	Remedy	See page
The remote control does not work or function properly.	Wrong distance or angle.	The remote control will function within a maximum range of 6 m (20 ft) and no more than 30 degrees offaxis from the front panel.	9
	Direct sunlight or lighting (from an inverter type of fluorescent lamp, strobe light, etc.) is striking the remote control sensor of this unit.	Adjust the lighting angle or reposition this unit.	—
	The batteries are weak.	Replace all batteries.	9
	The remote control ID of the remote control and this unit do not match.	Match the remote control ID of this unit and the remote control.	64

Problem	Cause	Remedy	See page
External components cannot be controlled by the remote control.	The remote control code is not correctly set.	Set the remote control code correctly using “List of remote control codes” at the end of this manual.	63
		Try setting another code of the same manufacturer using “List of remote control codes” at the end of this manual.	63
		<p>If this unit does not work when you press [1] Cursor, do the following.</p> <p>When the key does not work during DVD disc menu operation: press the [5] Input selection keys on the remote control again.</p> <p>When the key does not work during OPTION menu/ SETUP menu operation: press the key applicable for the current menu operation again.</p>	—
	Even if the remote control code is correctly set, there are some models that do not respond to the remote control.		

iPod™

Note

- In case of a transmission error without a status message appearing on the front panel display and on the OSD, check the connection of your iPod (see page 19).

Problem	Cause	Remedy	See page
Loading...	This unit is in the middle of recognizing the connection with your iPod.		
	This unit is in the middle of acquiring song lists from your iPod.		
Connect error	There is a problem with the signal path from your iPod to this unit.	Turn off this unit and reconnect the Yamaha iPod universal dock to the DOCK jack of this unit.	19
		Remove your iPod in the Yamaha iPod universal dock and then place it back in the dock.	19
Unknown iPod	The iPod being used is not supported by this unit.	Connect an iPod supported by this unit.	—
iPod Connected	Your iPod is properly placed in the Yamaha iPod universal dock.		
Disconnected	Your iPod is removed from the Yamaha iPod universal dock.		
Unable to play	This unit cannot play back the songs currently stored on your iPod.	Check that the songs currently stored on your iPod are playable.	—

Bluetooth™

Problem	Cause	Remedy	See page
Searching...	The Bluetooth wireless audio receiver and the Bluetooth component are in the middle of the pairing.	/	
	The Bluetooth wireless audio receiver and the Bluetooth component are in the middle of establishing the connection.		
Completed	The pairing is completed.		
Canceled	The pairing is canceled.		
BT Connected	The connection between the Yamaha Bluetooth wireless audio receiver and the Bluetooth component is established.		
Disconnected	The Bluetooth component is disconnected from the Yamaha Bluetooth wireless audio receiver.		
Not found	The Bluetooth component is not found.	During pairing: <ul style="list-style-type: none"> – pairing must be performed on the Bluetooth component and this unit simultaneously. Check if the Bluetooth component is in pairing mode. During connecting: <ul style="list-style-type: none"> – check if the Bluetooth component is turned on. – check if the Bluetooth component is within 10 m of the Yamaha Bluetooth wireless audio receiver. 	—

Auto Setup (YPAO)

Notes

- If an error or warning message is displayed, resolve the problem and run the automatic setup procedure again.
- Warning message “W-2” or “W-3” indicates that the adjusted settings may not be optimal.
- Depending on the speakers, warning message “W-1” may appear even if the speaker connections are correct.
- If error message “E-10” occurs repeatedly, contact a qualified Yamaha service center.

Before Auto Setup

Error message	Cause	Remedy	See page
Connect MIC!	Optimizer microphone is not connected.	Connect the supplied optimizer microphone to the OPTIMIZER MIC jack on the front panel.	21
Unplug HP!	Headphones are connected.	Unplug the headphones.	—
Memory Guard!	The parameters of this unit are protected.	Set “Memory Guard” to “Off.”	59

During Auto Setup

Error message	Cause	Remedy	See page
E-1:NO FRONT SP	Front L/R channel signals are not detected.	Check the front L/R speaker connections.	11
E-2:NO SUR. SP	Only one surround channel signal is detected.	Check the surround L/R speaker connections.	11

Error message	Cause	Remedy	See page
E-3:NO PRNS SP	Only one presence channel signal is detected.	Check the presence L/R speaker connections.	11
E-4:SBR->SBL	Only right surround back channel signal is detected.	If you connect only one surround back speaker, connect it to the L-side (SINGLE) jack.	11
E-5:NOISY	Measurement cannot be performed accurately due to loud ambient noise.	Run the automatic setup procedure again during a time when the environment is quiet.	—
		Turn off noisy electric equipment like air conditioners or move them away from the optimizer microphone.	—
E-6:CHECK SUR.	Surround back speakers are connected, though surround L/R speakers are not.	When using surround back speakers, you need to connect surround L/R speakers.	11
E-7:NO MIC	The optimizer microphone was unplugged during the “Auto Setup” procedure.	Do not touch the optimizer microphone during the automatic setup procedure.	21
E-8:NO SIGNAL	The optimizer microphone does not detect test tones.	Check whether the microphone is properly placed.	21
		Check whether the speakers are properly placed and connected.	11
		The optimizer microphone or OPTIMIZER MIC jack may be defective. Contact the nearest Yamaha dealer or service center.	21
		If a monitor such as a TV is connected to this unit via HDMI connection, sound may not be output from this unit due to the HDMI control function. In such a case, change the monitor setting, for example, change the sound output setting to an amplifier so that sound is output from this unit.	—
E-9:USER CANCEL	The automatic setup procedure was cancelled due to an inappropriate user operation.	Run the automatic setup procedure. Do not adjust the volume or do other operations during the procedure.	21
E-10:INTERNAL ERROR	An internal error occurred.	Run the automatic setup procedure again.	21

After Auto Setup

Error message	Cause	Remedy	See page
W-1:OUT OF PHASE	Speaker polarity is not correct. This message may appear depending on the speakers even when the speakers are connected correctly.	Check the polarities (+, -) of the displayed speaker. If they are correct, the speakers work properly even when this message is displayed.	11
W-2:OVER 24m (80ft.)	The distance between the speaker and the listening position is over 24 m (80 ft).	Bring the speaker within 24 m (80 ft.) area around the listening position.	—
W-3:LEVEL ERROR	The difference of volume level among speakers is excessive.	Recheck the speaker positions and make sure all speakers are placed in a similar environment.	—
		Check the polarities (+, -) of the speakers.	11
		We recommend that you use speakers with the same or similar specifications.	—
		Adjust the output volume of the subwoofer.	—

Error message	Cause	Remedy	See page
W-4:CHECK PRNS	Presence speakers were not detected during measurement with "Extra SP Assign" set to "Presence."	Check the presence speaker connections and perform measurement again. If presence speakers are not connected, set the "Extra SP Assign" to other than "Presence."	54
		If presence speakers are connected, set the "Extra SP Assign" to "Presence," and retry the automatic setup procedure.	54

■ Audio and video synchronization (lip sync)

Lip sync, an abbreviation for lip synchronization, is a technical term that involves both a problem and a capability of maintaining audio and video signals synchronized during post-production and transmission. Whereas the audio and video latency requires complex end-user adjustments, HDMI version 1.3 incorporates an automatic audio and video syncing capability that allows devices to perform this synchronization automatically and accurately without user interaction.

■ Bi-amplification connection

A bi-amplification connection uses two amplifiers for a speaker. One amplifier is connected to the woofer section of a loudspeaker while the other is connected to the combined mid and tweeter section. With this arrangement each amplifier operates over a restricted frequency range. This restricted range presents each amplifier with a much simpler job and each amplifier is less likely to influence the sound in some way.

■ Component video signal

With the component video signal system, the video signal is separated into the Y signal for the luminance and the PB and PR signals for the chrominance. Color can be reproduced more faithfully with this system because each of these signals is independent. The component signal is also called the “color difference signal” because the luminance signal is subtracted from the color signal. A monitor with component input jacks is required in order to output component signals.

■ Composite video signal

With the composite video signal system, the video signal is composed of three basic elements of a video picture: color, brightness and synchronization data. A composite video jack on a video component transmits these three elements combined.

■ Deep Color

Deep Color refers to the use of various color depths in displays, up from the 24-bit depths in previous versions of the HDMI specification. This extra bit depth allows HDTVs and other displays go from millions of colors to billions of colors and eliminate on-screen color banding for smooth tonal transitions and subtle gradations between colors. The increased contrast ratio can represent many times more shades of gray between black and white. Also Deep Color increases the number of available colors within the boundaries defined by the RGB or YCbCr color space.

■ Dolby Digital

Dolby Digital is a digital surround sound system that gives you completely independent multi-channel audio. With 3 front channels (front L/R and center), and 2 surround stereo channels, Dolby Digital provides 5 full-range audio channels. With an additional channel especially for bass effects, called LFE (Low Frequency Effect), the system has a total of 5.1-channels (LFE is counted as 0.1 channel). By using 2-channel stereo for the surround speakers, more accurate moving sound effects and surround sound environment are possible than with Dolby Surround. The wide dynamic range from maximum to minimum volume reproduced by the 5 full-range channels and the precise sound orientation generated using digital sound processing provide listeners with unprecedented excitement and realism. With this unit, any sound environment from monaural up to a 5.1-channel configuration can be freely selected for your enjoyment.

■ Dolby Digital Surround EX

Dolby Digital EX creates 6 full-bandwidth output channels from 5.1-channel sources.

For the best results, Dolby Digital EX should be used with movie sound tracks recorded with Dolby Digital Surround EX. With this additional channel, you can experience more dynamic and realistic moving sound especially with scenes with “fly-over” and “fly-around” effects.

■ Dolby Digital Plus

Dolby Digital Plus is an advanced audio technology developed for high-definition programming and media including HD broadcasts, and Blu-ray Disc. Selected as an optional audio standard for Blu-ray Disc, this technology delivers multichannel sound with discrete channel output. Supporting bitrates up to 6.0 Mbps, Dolby Digital Plus can carry up to 7.1 discrete audio channels simultaneously. Supported by HDMI version 1.3 and designed for the optical disc players and AV receivers/amplifiers of the future, Dolby Digital Plus also remains fully compatible with the existing multichannel audio systems that incorporate Dolby Digital.

■ Dolby Pro Logic II

Dolby Pro Logic II is an improved technique used to decode vast numbers of existing Dolby Surround sources. This new technology enables a discrete 5-channel playback with 2 front left and right channels, 1 center channel, and 2 surround left and right channels instead of only 1 surround channel for conventional Pro Logic technology. There are three modes available: “Music mode” for music sources, “Movie mode” for movie sources and “Game mode” for game sources.

■ Dolby Pro Logic IIx

Dolby Pro Logic IIx is a new technology enabling discrete multichannel playback from 2-channel or multi-channel sources. There are three modes available: “Music mode” for music sources, “Movie mode” for movie sources (for 2-channel sources only) and “Game mode” for game sources.

■ Dolby Surround

Dolby Surround is widely used with nearly all video tapes and laser discs, and in many TV and cable broadcasts as well. Dolby Surround uses a 4-channel analog recording system to reproduce realistic and dynamic sound effects: 2 front left and right channels (stereo), a center channel for dialog (monaural), and a surround channel for special sound effects (monaural). The surround channel reproduces sound within a narrow frequency range. The Dolby Pro Logic decoder built into this unit employs a digital signal processing system that automatically stabilizes the volume on each channel to enhance moving sound effects and directionality.

■ Dolby TrueHD

Dolby TrueHD is an advanced lossless audio technology developed for high-definition disc-based media including Blu-ray Disc. Selected as an optional audio standard for Blu-ray Disc, this technology delivers sound that is bit-for-bit identical to the studio master, offering a high-definition home theater experience. Supporting bitrates up to 18.0 Mbps, Dolby TrueHD can carry up to 8 discrete channels of 24-bit/96 kHz audio simultaneously. Dolby TrueHD also remains fully compatible with the existing multichannel audio systems and retains the metadata capability of Dolby Digital, allowing dialog normalization and dynamic range control.

■ DSD

Direct Stream Digital (DSD) technology stores audio signals on digital storage media, such as Super Audio CDs. Using DSD, signals are stored as single bit values at a high-frequency sampling rate of 2.8224 MHz, while noise shaping and oversampling are used to reduce distortion, a common occurrence with very high quantization of audio signals. Due to the high sampling rate, better audio quality can be achieved than that offered by the PCM format used for normal audio CDs. The frequency is equal to or higher than 100 kHz and the dynamic range is 120 dB. This unit can transmit or receive DSD signals via the HDMI jack.

■ DTS 96/24

DTS 96/24 offers an unprecedented level of audio quality for multi-channel sound on DVD video, and is fully backward-compatible with all DTS decoders. “96” refers to a 96 kHz sampling rate compared to the typical 48 kHz sampling rate. “24” refers to 24-bit word length. DTS 96/24 offers sound quality transparent to the original 96/24 master, and 96/24 5.1-channel sound with full-quality full-motion video for music programs and motion picture soundtracks on DVD video.

■ DTS Digital Surround

DTS Digital Surround was developed to replace the analog soundtracks of movies with a 5.1-channel digital sound track, and is now rapidly gaining popularity in movie theaters around the world. DTS, Inc. has developed a home theater system so that you can enjoy the depth of sound and natural spatial representation of DTS Digital Surround in your home. This system produces practically distortion-free 6-channel sound (technically, front left and right, center, surround left and right, and LFE 0.1 (subwoofer) channels for a total of 5.1 channels). This unit incorporates a DTS-ES decoder that enables 6.1-channel reproduction by adding the surround back channel to the existing 5.1-channel format.

■ DTS Express

This is an audio format for next-generation optical discs such as Blu-ray discs. It uses optimized low bit rate signals for network streaming. In the case of a Blu-ray disc, this format is used with secondary audio, enabling you to enjoy the commentary of the movie producer via the Internet while playing the main program.

■ DTS-HD High Resolution Audio

DTS-HD High Resolution Audio is a high resolution audio technology developed for high-definition disc-based media including Blu-ray Disc. Selected as an optional audio standard for Blu-ray Disc, this technology delivers sound that is virtually indistinguishable from the original, offering a high-definition home theater experience. Supporting bitrates up to 6.0 Mbps for Blu-ray Disc, DTS-HD High Resolution Audio can carry up to 7.1 discrete channels of 24-bit/96 kHz audio simultaneously.

DTS-HD High Resolution Audio also remains fully compatible with the existing multichannel audio systems that incorporate DTS Digital Surround.

■ DTS-HD Master Audio

DTS-HD Master Audio is an advanced lossless audio technology developed for high-definition disc-based media including Blu-ray Disc. Selected as an optional audio standard for Blu-ray Disc, this technology delivers sound that is bit-for-bit identical to the studio master, offering a high-definition home theater experience. Supporting bitrates up to 24.5 Mbps for Blu-ray Disc, DTS-HD Master Audio can carry up to 7.1 discrete channels of 24-bit/96 kHz audio simultaneously. Supported by HDMI version 1.3 and designed for the optical disc players and AV receivers/amplifiers of the future, DTS-HD Master Audio also remains fully compatible with the existing multichannel audio systems that incorporate DTS Digital Surround.

■ HDMI

HDMI (High-Definition Multimedia Interface) is the first industry-supported, uncompressed, all-digital audio/video interface. Providing an interface between any source (such as a set-top box or AV receiver) and an audio/video monitor (such as a digital television), HDMI supports standard, enhanced or high-definition video as well as multi-channel digital audio using a single cable. HDMI transmits all ATSC HDTV standards and supports 8-channel digital audio, with bandwidth to spare to accommodate future enhancements and requirements.

When used in combination with HDCP (High-bandwidth Digital Content Protection), HDMI provides a secure audio/video interface that meets the security requirements of content providers and system operators. For further information on HDMI, visit the HDMI website at “<http://www.hdmi.org/>”

■ LFE 0.1 channel

This channel reproduces low-frequency signals. The frequency range of this channel is from 20 Hz to 120 Hz. This channel is counted as 0.1 because it only enforces a low-frequency range compared to the full-range reproduced by the other 5/6 channels in Dolby Digital or DTS 5.1/6.1-channel systems.

■ Neural Surround

Neural Surround represents the latest advancement in surround technology and has been adopted by XM Satellite Radio for digital broadcast of surround recordings and live events in surround sound. Neural Surround employs psychoacoustic frequency domain processing which allows delivery of a more detailed sound stage with superior channel separation and localization of audio elements. System playback is scalable from 5.1 to 7.1 multi-channel surround playback.

■ Neo:6

Neo:6 decodes the conventional 2-channel sources for 6-channel playback by the specific decoder. It enables playback with the full-range channels with higher separation just like digital discrete signal playback. There are two modes available: “Music mode” for music sources and “Cinema mode” for movie sources.

■ PCM (Linear PCM)

Linear PCM is a signal format under which an analog audio signal is digitized, recorded and transmitted without using any compression. This is used as a method of recording CDs and DVD audio. The PCM system uses a technique for sampling the size of the analog signal per very small unit of time. Standing for “Pulse Code Modulation,” the analog signal is encoded as pulses and then modulated for recording.

■ Sampling frequency and number of quantized bits

When digitizing an analog audio signal, the number of times the signal is sampled per second is called the sampling frequency, while the degree of fineness when converting the sound level into a numeric value is called the number of quantized bits. The range of rates that can be played back is determined based on the sampling rate, while the dynamic range representing the sound level difference is determined by the number of quantized bits. In principle, the higher the sampling frequency, the wider the range of frequencies that can be played back, and the higher the number of quantized bits, the more finely the sound level can be reproduced.

■ “x.v.Color”

A color space standard supported by HDMI version 1.3. It is a more extensive color space than sRGB, and allows the expression of colors that could not be expressed before. While remaining compatible with the color gamut of sRGB standards, “x.v.Color” expands the color space and can thus produce more vivid, natural images. It is particularly effective for still pictures and computer graphics.

Sound field program information

■ CINEMA DSP

Since the Dolby Surround and DTS systems were originally designed for use in movie theaters, their effect is best felt in a theater having many speakers designed for acoustic effects. Since home conditions, such as room size, wall material, number of speakers, and so on, can differ so widely, it is inevitable that there are differences in the sound heard.

Based on a wealth of actually measured data, Yamaha CINEMA DSP provides the audiovisual experience of a movie theater in the listening room of your own home by using the Yamaha original sound field technology combined with various digital audio systems.

■ CINEMA DSP 3D

The actually measured sound field data contain the information of the height of the sound images. CINEMA DSP 3D feature achieves the reproduction of the accurate height of the sound images so that it creates the accurate and intensive stereoscopic sound fields in a listening room.

■ SILENT CINEMA

Yamaha has developed a natural, realistic sound effect DSP algorithm for headphones. Parameters for headphones have been set for each sound field so that accurate representations of all the sound field programs can be enjoyed on headphones.

■ Virtual CINEMA DSP

Yamaha has developed a Virtual CINEMA DSP algorithm that allows you to enjoy DSP sound field surround effects even without any surround speakers by using virtual surround speakers. It is even possible to enjoy Virtual CINEMA DSP using a minimal two-speaker system that does not include a center speaker.

■ Compressed Music Enhancer

The Compressed Music Enhancer feature of this unit enhances your listening experience by regenerating the missing harmonics in a compression artifact. As a result, flattened complexity due to the loss of high-frequency fidelity as well as lack of bass due to the loss of low-frequency bass is compensated, providing improved performance of the overall sound system.

Information on HDMI™

■ HDMI signal compatibility

Audio signals

Audio signal types	Audio signal formats	Compatible media
2ch Linear PCM	2ch, 32-192 kHz, 16/20/24 bit	CD, DVD-Video, DVD-Audio, etc.
Multi-ch Linear PCM	8ch, 32-192 kHz, 16/20/24 bit	DVD-Audio, Blu-ray Disc, HD DVD, etc.
DSD	2/5.1ch, 2.8224 MHz, 1 bit	SACD, etc.
Bitstream	Dolby Digital, DTS	DVD-Video, etc.
Bitstream (High definition audio)	Dolby TrueHD, Dolby Digital Plus, DTS-HD Master Audio, DTS-HD High Resolution Audio, DTS Express	Blu-ray Disc, HD DVD, etc.



- If the input source component can decode the bitstream audio signals of audio commentaries, you can play back the audio sources with the audio commentaries mixed down by using the following connections:
 - multi-channel analog audio input (see page 18)
 - DIGITAL INPUT OPTICAL (or COAXIAL)
- Refer to the supplied instruction manuals of the input source component, and set the component appropriately.

Notes

- When CPPM copy-protected DVD-Audio is played back, video and audio signals may not be output depending on the type of the DVD player.
- This unit is not compatible with HDCP-incompatible HDMI or DVI components.
- To decode audio bitstream signals on this unit, set the input source component appropriately so that the component outputs the bitstream audio signals directly (does not decode the bitstream signals on the component). Refer to the supplied instruction manuals for details.
- This unit is not compatible with the audio commentary features (for example, the special audio contents downloaded via Internet) of Blu-ray Disc or HD DVD. This unit does not play back the audio commentaries of the Blu-ray Disc or HD DVD contents.

Video signals

This unit is compatible with the video signals of the following resolutions:

- 480i/60 Hz
- 576i/50 Hz
- 480p/60 Hz
- 576p/50 Hz
- 720p/60 Hz, 50 Hz
- 1080i/60 Hz, 50 Hz
- 1080p/60 Hz, 50 Hz, 24 Hz

Specifications

AUDIO SECTION

- Minimum RMS Output Power for Front, Center, Surround, Surround back
20 Hz - 20 kHz, 0.08% THD, 8 Ω 95 W
- Dynamic Power (IHF)
Front Speakers 8/6/4/2 Ω 130/165/195/240 W
- Maximum Useful Output Power (JEITA)
[China, Korea, General and Asia models]
1 kHz, 10% THD, 8 Ω 135 W
- Maximum Output Power
[U.K., Europe, Russia and Asia models]
1 kHz, 0.7% THD, 4 Ω 145 W
- Dynamic Headroom [U.S.A. and Canada models]
8 Ω 1.4 dB
- IEC Output Power [U.K., Europe, Russia and Asia models]
Front Speakers 1 kHz, 0.08% THD, 8 Ω 105 W
- Input Sensitivity/Input Impedance
PHONO
[China, Korea, U.K., Europe, Russia, Australia, General and Asia models] 3.5 mV/47 kΩ
AV5, etc. 200 mV/47 kΩ
MULTI CH INPUT 200 mV/47 kΩ
- Maximum Input Voltage
PHONO (1 kHz, 0.1% THD)
[China, Korea, U.K., Europe, Russia, Australia, General and Asia models] 60 mV or more
AV5, etc. (1 kHz, 0.5% THD) 2.3 V or more
- Rated Output Voltage/Output Impedance
AUDIO OUT 200 mV/1.2 kΩ
PRE OUT 1.0 V/1.2 kΩ
SUBWOOFER (2ch Stereo & FRONT: Small)
..... 1.0 V/1.2 kΩ
ZONE2 OUT 200 mV/1.2 kΩ
- Headphone Jack Rated Output/Impedance
AV5, etc. (1 kHz, 50 mV, 8 Ω) 100 mV/470 Ω
- Frequency Response
AV5, etc. to FRONT 10 Hz to 100 kHz, +0/-3 dB
- RIAA Equalization Deviation
[China, Korea, U.K., Europe, Russia, Australia, General and Asia models]
PHONO 0 ± 0.5 dB
- Total Harmonic Distortion
PHONO to AUDIO OUT
[China, Korea, U.K., Europe, Russia, Australia, General and Asia models]
(20 Hz to 20 kHz, 1 V) 0.02% or less
AV5, etc. to FRONT, Pure Direct
(20 Hz to 20 kHz, 50 W, 8 Ω) 0.06% or less
- Signal to Noise Ratio (IHF-A Network)
PHONO Input Shorted (5.0 mV to AUDIO OUT)
[China and General models]
..... 86 dB or more
PHONO Input Shorted (5.0 mV to AUDIO OUT)
[Korea, U.K., Europe, Russia, Australia and Asia models]
..... 81 dB or more
AV5, etc. (Pure Direct) Input Shorted (250 mV to Front Speakers)
..... 100 dB or more
- Residual Noise (IHF-A Network)
Front Speakers 150 μV or less
- Channel Separation (1 kHz/10 kHz)
PHONO (Input Shorted)
[China, Korea, U.K., Europe, Russia, Australia, General and Asia models] 60 dB/55 dB or more
AV5, etc. (5.1 kΩ shortened) 60 dB/45 dB or more
- Volume Control MUTE / -80 dB to +16.5 dB
- Tone Control (Front Speakers)
BASS Boost/Cut ±10 dB at 50 Hz
BASS Turnover Frequency 350 Hz
TREBLE Boost/Cut ±10 dB at 20 kHz
TREBLE Turnover Frequency 3.5 kHz

- Filter Characteristics (fc=40/60/80/90/100/110/120/160/200 Hz)
H.P.F. (Front, Center, Surround, Surround back: Small)
..... 12 dB/oct.
L.P.F. (Subwoofer) 24 dB/oct.

VIDEO SECTION

- Video Signal Type (Gray Back)
[U.S.A., Canada, Korea and General models] NTSC
[Other models] PAL
- Signal Level
Composite 1 Vp-p/75 Ω
S-video [U.K., Europe and Russia models]
..... 1 Vp-p/75 Ω (Y), 0.286 Vp-p/75 Ω (C)
Component 1 Vp-p/75 Ω (Y), 0.7 Vp-p/75 Ω (CB/CR)
- Maximum Input Level 1.5 Vp-p or more
- Signal to Noise Ratio 50 dB or more
- Frequency Response [MONITOR OUT]
Component 5 Hz to 60 MHz, -3 dB

FM SECTION

- Tuning Range
[U.S.A. and Canada models] 87.5 to 107.9 MHz
[Asia and General models] 87.5/87.50 to 108.0/108.00 MHz
[Other models] 87.50 to 108.00 MHz
- 50 dB Quieting Sensitivity (IHF)
Mono 3.0 μV (20.8 dBf)
- Signal to Noise Ratio (IHF)
Mono/Stereo 74 dB/70 dB
- Harmonic Distortion (1 kHz)
Mono/Stereo 0.3/0.3%
- Antenna Input (unbalanced) 75 Ω

AM SECTION

- Tuning Range
[U.S.A. and Canada models] 530 to 1710 kHz
[Asia and General models] 530/531 to 1710/1611 kHz
[Other models] 531 to 1611 kHz

GENERAL

- Power Supply
[U.S.A. and Canada models] AC 120 V, 60 Hz
[General model] AC 110/120/220/230-240 V, 50/60 Hz
[China model] AC 220 V, 50 Hz
[Korea model] AC 220 V, 60 Hz
[Australia model] AC 240 V, 50 Hz
[U.K., Europe and Russia models] AC 230 V, 50 Hz
[Asia model] AC 220/230-240 V, 50/60 Hz
- Power Consumption
[U.S.A. and Canada models] 400 W/500 VA
[Other models] 400 W
- Standby Power Consumption
HDMI control off/Standby through off 0.2 W or less
HDMI control on/Standby through on/No Repeat 1.2 W or less
HDMI control on/Standby through on/Repeat 3 W or less
- Maximum Power Consumption
[Asia and General models] 590 W
- Dimensions (W x H x D) 435 x 171 x 365 mm
(17-1/8 x 6-3/4 x 14-3/8 in)
- Weight 11.0 kg (24.3 lbs)

* Specifications are subject to change without notice.

Index

■ Numerics

1 Dynamic Range, sound setup	56
1 HDMI, function setup	57
2 Display, function setup	58
2 Lipsync, sound setup	57
2ch Stereo, sound field program	28
3 Volume, function setup	58
3D DSP, sound field parameter	49
4 Input Rename, function setup	59
5.1-channel speaker layout	10
6.1-channel speaker layout	10
7.1-channel speaker layout	10
7ch Enhancer, sound field program	29
7ch Stereo, sound field program	28

■ A

A)Config, speaker setup	54
Action Game, sound field program	28
Adaptive DRC, 3 Volume, function setup	58
Adjusting high frequency sound	25
Adjusting low frequency sound	25
ADVANCED SETUP	64
Adventure, sound field program	27
All Channel Search mode, SIRIUS satellite radio	38
All Channel Search mode, XM satellite radio	34
AM antenna connection	20
AM tuning	31
ANTENNA jacks, rear panel	5
Aspect, 1 HDMI, function setup	58
AUDIO 1/2 jacks, rear panel	5
Audio and video player connection	16
AUDIO jack	14
Audio jack	14
AUDIO L/R jack, front panel	4
AUDIO OUT jacks, rear panel	5
Audio Output, 1 HDMI, function setup	57
Audio player connection	17
Auto Delay, 2 Lipsync, sound setup	57
Auto Preset, OPTION menu	48
Auto Setup (YPAO), troubleshooting	74
Automatic setup	21
AV 1-6 jacks, rear panel	5
AV OUT jacks, rear panel	5

■ B

B)Level, speaker setup	56
Basic operation, SETUP menu	54
BI-AMP connection switch, ADVANCED SETUP	64
Bluetooth component playback	44
Bluetooth wireless audio receiver connection	19
Bluetooth, troubleshooting	74

■ C

C)Distance, speaker setup	56
C.Image, decoder parameter	52
Category Search mode, SIRIUS satellite radio	38
Category Search mode, XM satellite radio	34
Cellar Club, sound field program	28
Center SP, A)Config, speaker setup	55
Center speaker	10
Center width, decoder parameter	52
Center, C)Distance, speaker setup	56
Chamber, sound field program	28
Changing information on the front panel display	26
CINEMA DSP 3D indicator, front panel display	6
CINEMA DSP basic parameter	49
CINEMA DSP indicator, front panel display	6
Clear Preset, OPTION menu	48

COAXIAL jack	14
CODE SET, remote control	7
COMPONENT VIDEO jack	14
Connect, OPTION menu	48
Connecting AM antenna	20
Connecting audio and video player	16
Connecting audio player	17
Connecting Bluetooth wireless audio Receiver	19
Connecting external amplifier	18
Connecting external decoder	18
Connecting FM antenna	20
Connecting iPod universal dock	19
Connecting multi-format player	18
Connecting power cable	20
Connecting projector	15
Connecting set-top box	16
Connecting speaker	11
Connecting speaker cable	13
Connecting the SiriusConnect	37
Connecting the SiriusConnect tuner	37
Connecting TV monitor	15
Connecting XM Mini-Tuner Home Dock	33
Connecting Zone2	60
Connection	10
Control, 1 HDMI, function setup	57
Controlling other component, remote control	62
Controlling Zone2	61
Crossover Freq., A)Config, speaker setup	56
CT Level, sound field parameter	52
Cursor indicator, front panel display	6
Cursors Δ / ∇ / \triangleleft / \triangleright , remote control	7

■ D

D)Equalizer, speaker setup	56
Decoder Mode, OPTION menu	47
Decoder parameter	52
Dialog Lift, sound field parameter	50
Dimension, decoder parameter	52
Dimmer, 2 Display, function setup	58
Direct number access mode, SIRIUS satellite radio	38
Direct number access mode, XM satellite radio	34
Direct, sound field parameter	52
Disconnect, OPTION menu	48
DISPLAY, remote control	7
Displaying input signal information	26
Displaying the SIRIUS Satellite Radio information	41
Displaying the XM Satellite Radio information	36
DOCK jack, rear panel	5
Drama, sound field program	28
DSP Level, sound field parameter	49
DSP Parameter, SETUP menu	59

■ E

E)Test Tone, speaker setup	56
Editing sound field program	49
Editing surround decoder	49
Effect Level, sound field parameter	52
ENTER, remote control	7
EQ Type Select, D)Equalizer, speaker setup	56
Extended Surround, OPTION menu	47
External component operation key, remote control	7
Extra SP Assign, A)Config, speaker setup	54

■ F

FL Scroll, 2 Display, function setup	58
FM antenna connection	20
FM Mode, OPTION menu	48
FM tuning	31
FM/AM (CATEGORY \triangleleft / \triangleright), front panel	4

Frequency tuning mode	31
Front L, C)Distance, speaker setup	56
Front left speaker	10
Front panel	4
Front panel display	6
Front panel display, front panel	4
Front R, C)Distance, speaker setup	56
Front right speaker	10
Front SP, A)Config, speaker setup	55
Function Setup, SETUP menu	57

■ H

Hall in Munich, sound field program	28
Hall in Vienna, sound field program	28
HDMI Auto, 2 Lipsync, sound setup	57
HDMI indicator, front panel display	6
HDMI information	79
HDMI jack	14
HDMI OUT/HDMI 1-4 jacks, rear panel	5
HDMI THROUGH, front panel	4
HDMI, troubleshooting	69
Headphones using	26
Hi-fi sound playback	25
High frequency sound adjustment	25

■ I

INFO, front panel	4
INFO, remote control	7
INIT, ADVANCED SETUP	64
Init. Volume, 3 Volume, function setup	58
Initialize setting, ADVANCED SETUP	64
Input selection key, remote control	7
INPUT selector, front panel	4
Input signal information displaying	26
Input source registration	25
Installing batteries, remote control	9
iPod playback	42
iPod universal dock connection	19
iPod, troubleshooting	73

■ L

LFE/Bass Out, A)Config, speaker setup	55
Low frequency sound adjustment	25

■ M

MAIN ZONE ON/OFF, front panel	4
MAIN/ZONE2, remote control	7
Manual Delay, 2 Lipsync, sound setup	57
Max Volume, 3 Volume, function setup	58
Memory guard, SETUP menu	59
MEMORY, front panel	4
MON.CHK, ADVANCED SETUP	64
MONITOR OUT terminals, rear panel	5
Mono Movie, sound field program	28
MULTI CH INPUT terminals, rear panel	5
Multi information display, front panel display	6
Multi-zone configuration	60
Music Video, sound field program	28
MUTE indicator, front panel display	6
MUTE, remote control	7

■ N

Numeric key, remote control	7
-----------------------------	---

■ O

OPTICAL jack	14
OPTIMIZER MIC jack, front panel	4
OPTION menu	46
OPTION, remote control	7
OSD Shift, 2 Display, function setup	58

■ P

Pairing Bluetooth components	44
Pairing, OPTION menu	48

Panorama, decoder parameter 52
 Parental Lock, OPTION menu 48
 PHONES jack, front panel 4
 PL Level, sound field parameter 52
 Placing speaker 10
 PORTABLE jack, front panel 4
 Power cable connection 20
 Power Cable, rear panel 5
 POWER, remote control 7
 PR Level, sound field parameter 52
 PRE OUT terminals, rear panel 5
 PRESET ◀/▶, front panel 4
 Preset Search mode,
 SIRIUS satellite radio 39
 Preset Search mode, XM satellite radio 35
 Preset tuning mode 31
 PRNS L, C)Distance, speaker setup 56
 PRNS R, C)Distance, speaker setup 56
 PROGRAM selector, front panel 4
 Projector connection 15
 PURE DIRECT, front panel 4

■ R

Registering input source 25
 Registering sound field program 25
 Registering the SIRIUS Satellite Radio
 channels 39
 Registering XM Satellite Radio channels 35
 Remote control 7
 Remote control code resetting 63
 Remote control code setting 63
 Remote control ID, ADVANCED SETUP 64
 Remote control signal transmitter,
 remote control 7
 Remote control, controlling other
 component 62
 Remote control, preparation 9
 Remote control, troubleshooting 72
 REMOTE ID, ADVANCED SETUP 64
 REMOTE IN/OUT jacks, rear panel 5
 Repeat playback, iPod 43
 Repeat, OPTION menu 48
 Resetting Parental lock cord,
 ADVANCED SETUP 64
 Resetting remote control code 63
 Resolution, 1 HDMI, function setup 57
 RETURN, remote control 7
 Roleplaying Game, sound field program 28

■ S

SB Level, sound field parameter 52
 SCENE function 24
 SCENE IR, ADVANCED SETUP 64
 SCENE, front panel 4
 SCENE, remote control 7
 Sci-Fi, sound field program 27
 Selecting SCENE 24
 Setting remote control code 63
 Setting the Parental Lock,
 SIRIUS satellite radio 40
 Set-top box connection 16
 SETUP menu 53
 SETUP menu basic operation 54
 SETUP, remote control 7
 Shuffle playback, iPod 43
 Shuffle, OPTION menu 48
 Signal Info parameter 47
 Signal Info, OPTION menu 47
 SILENT CINEMA 30
 SIRIUS indicator, front panel display 6
 SIRIUS jack, rear panel 5
 SIRIUS Satellite Radio tuning 37
 SIRIUS Satellite Radio, troubleshooting 71
 SL Level, sound field parameter 52
 SLEEP indicator, front panel display 6
 Sleep timer 45
 SLEEP, remote control 7
 Sound field parameter 49
 Sound field program editing 49

Sound field program registration 25
 Sound selection key, remote control 7
 Sound Setup, SETUP menu 56
 SOURCE POWER, remote control 7
 SP IMP., ADVANCED SETUP 64
 Speaker cable connection 13
 Speaker connection 11
 Speaker impedance, ADVANCED SETUP 64
 Speaker indicator, front panel display 6
 Speaker layout 10
 Speaker placement 10
 Speaker setup 54
 SPEAKERS terminals, rear panel 5
 Specifications 80
 Spectacle, sound field program 27
 Sports, sound field program 28
 SR Level, sound field parameter 52
 SR PIN, ADVANCED SETUP 64
 Standard, sound field program 27
 Standby Through, 1 HDMI, function setup 57
 Straight decoding mode 30
 Straight Enhancer, sound field program 29
 STRAIGHT, front panel 4
 Subwoofer 10
 Subwoofer Phase, A)Config, speaker setup 56
 Sur. L, C)Distance, speaker setup 56
 Sur. L/R SP, A)Config, speaker setup 55
 Sur. R, C)Distance, speaker setup 56
 SUR., sound field parameter 49
 Sur.B L, C)Distance, speaker setup 56
 Sur.B L/R SP, A)Config, speaker setup 55
 Sur.B R, C)Distance, speaker setup 56
 Surround back left speaker 10
 Surround back right speaker 10
 Surround back speaker 10
 Surround decoder editing 49
 Surround left speaker 10
 Surround right speaker 10
 SWFR, C)Distance, speaker setup 56

■ T

The Bottom Line, sound field program 28
 The Roxy Theatre, sound field program 28
 Tone control 25
 TONE CONTROL, front panel 4
 TRANSMIT, remote control 7
 TRIGGER OUT jack, rear panel 5
 Troubleshooting 66
 Tuner indicator, front panel display 6
 Tuner key, remote control 7
 Tuner, troubleshooting 70
 Tuning, AM 31
 Tuning, FM 31
 TUNING/CH ◀/▶, front panel 4
 Turning off 20
 Turning on 20
 TV control key, remote control 7
 TV monitor connection 15

■ U

Using the remote control 9

■ V

VIDEO jack 14
 Video jack 14
 VIDEO jack, front panel 4
 Video Out, OPTION menu 48
 Video/audio jack 14
 Virtual CINEMA DSP 30
 VOLUME +/-, remote control 7
 VOLUME control, front panel 4
 VOLUME indicator, front panel display 6
 Volume Trim, OPTION menu 46

■ X

XM indicator, front panel display 6
 XM jack, rear panel 5
 XM Satellite Radio tuning 33
 XM Satellite Radio, troubleshooting 70

■ Y

YPAO 21
 YPAO, troubleshooting 74

■ Z

ZONE2 CONTROL, front panel 4
 ZONE2 indicator, front panel display 6
 ZONE2 ON/OFF, front panel 4
 ZONE2 OUT jacks, rear panel 5

“**A** MAIN ZONE ON/OFF” or
 “**16** POWER” (example) indicates
 the name of the parts on the front
 panel or the remote control. Refer
 to the “Controls diagram” or “Part
 names and functions” on page 4.

List of remote control codes

TV		Ausind		Clatronic		Durabrand	
A.R. Systems	0274	Autovox	0249, 0257, 0259, 0260, 0328		0243, 0249, 0259, 0260, 0261, 0262, 0268, 0269, 0273, 0274, 0328	Dux	0077, 0097, 0133, 0225
Acme	0260	Aventura	0097			Dwin	0271
Acura	0261, 0273	Awa	0327, 0328	CMS	0327	Dynatron	0224
ADC	0259	Axion	0206	CMS Hightec	0328	Dynex	0268, 0271, 0274
Admiral	0100, 0224, 0257, 0258, 0259, 0264, 0265	Baird	0328	Coby	0151	Elbe	0181, 0182
Advent	0204	Bang & Olufsen	0230, 0257	Colortyme	0072, 0090		0243, 0250, 0274, 0328
Adventura	0107	Basic Line	0261, 0262, 0268, 0273, 0274, 0328	Commercial Solutions	0071	Elcit	0257
Adyson	0260, 0327, 0328	Bastide	0260, 0328	Concerto	0072, 0090	Electa	0270
Agashi	0327, 0328	Baur	0271, 0274	Concorde	0261, 0273	ELECTRO TECH	0261
Agazi	0259	Bazin	0328	Condor	0243, 0260, 0268, 0269, 0273, 0274, 0327	Electroband	0057, 0101
Aiko	0260, 0261, 0273, 0274, 0327, 0328	Beko	0243, 0269, 0274, 0282, 0351, 0357, 0372, 0380			Electrograph	0226
Aim	0274	Belcor	0090	Contec	0225, 0260, 0261, 0266, 0273, 0327	Electrohome	0072, 0090, 0101, 0102
Aiwa	0028, 0297	Bell & Howell	0065, 0100	Contec/Cony	0094, 0104	Element	0180
Akai	0063, 0096, 0101, 0205, 0231, 0261, 0262, 0268, 0271, 0273, 0274, 0327, 0328	Benq	0051, 0160, 0315	Continental Edison	0267	Elin	0260, 0268, 0271, 0273, 0274, 0327
Akiba	0262, 0274	Beon	0268, 0271, 0274			Elite	0262, 0268, 0274
Akura	0259, 0262, 0273, 0274	Best	0243	Cosmel	0261, 0273	Elman	0263
Alaron	0327	Bestar	0243, 0268, 0274	Craig	0104, 0225	Elta	0261, 0273, 0327
Alba	0243, 0260, 0261, 0262, 0266, 0269, 0271, 0273, 0274, 0294, 0300, 0327	Binatone	0260, 0328	Crosley	0088, 0119, 0249, 0257	Emerson	0065, 0072, 0077, 0082, 0085, 0090, 0094, 0095, 0097, 0104, 0105, 0119, 0225, 0243, 0257, 0274
Albatron	0222	Blue Sky	0262, 0274			Emprex	0200
Alcyon	0249	Blue Star	0270	Crown	0104, 0225, 0243, 0249, 0261, 0268, 0269, 0271, 0273, 0274	Envision	0072, 0090, 0096
Alleron	0105	Boots	0260, 0328	CS Electronics	0260, 0262, 0327	Epson	0156, 0201, 0309
Allorgan	0328	BPL	0270, 0274	CTC Clatronic	0263	Erres	0268, 0271, 0274
Allstar	0268, 0274	Bradford	0104, 0225	CTX	0159	ESA	0097
America Action	0225	Brandt	0267, 0272	Curtis Mathes	0065, 0071, 0072, 0085, 0088, 0090, 0096, 0099, 0224	ESC	0328
AMOi	0326	Brilliant	0228			Etron	0261
Amplivision	0243, 0260, 0275, 0328	Brinkmann	0274	CXC	0104, 0225	Eurofeel	0328
Amstrad	0259, 0261, 0262, 0273, 0274	Briovega	0257, 0268, 0271, 0274	Cybertron	0262	Euro-Feel	0259
Amtron	0104	Britannia	0260, 0327, 0328	Cytron	0202	Euroline	0271
Anam	0225, 0261	Brockwood	0090	Daewoo	0072, 0085, 0090, 0103, 0119, 0245, 0260, 0261, 0268, 0273, 0274, 0281, 0285, 0303, 0321, 0327, 0328, 0344, 0361, 0387	Euroman	0243, 0327, 0328
Anam National	0102, 0104	Broksonic	0063, 0225			Euromann	0259, 0260, 0268, 0274
Anglo	0261, 0273	Bruns	0257	Dainichi	0262, 0327	Europhon	0260, 0263, 0268, 0274, 0327, 0328
Anitech	0249, 0259, 0261, 0273, 0274	BTC	0262	Dansai	0259, 0268, 0271, 0274, 0327, 0328	Expert	0275
Ansonic	0243, 0250, 0261, 0263, 0273, 0274	Bush	0261, 0262, 0264, 0266, 0268, 0270, 0271, 0273, 0274, 0282, 0286, 0294, 0300, 0328, 0329, 0351, 0388, 0394, 0413	Dantax	0243, 0271	Exquisit	0274
AOC	0072, 0090, 0096, 0103	Capsonic	0259	Dawa	0274	Fenner	0261, 0273
Apex	0061, 0117, 0139	Carena	0274	Daytron	0072, 0085, 0090, 0261, 0273	Ferguson	0267, 0271, 0272
Arcam	0327, 0328	Carnivale	0096	De Graaf	0264	Fidelity	0260, 0264, 0274, 0327
Arcam Delta	0260	Carrefour	0266	Decca	0260, 0268, 0271, 0274, 0328	Filsai	0328
Aristona	0268, 0271, 0274	Carver	0088	Dell	0167, 0195	Finlandia	0264
Arthur Martin	0275	Cascade	0261, 0273, 0274	Denver	0308, 0312	Finlux	0249, 0257, 0260, 0263, 0268, 0271, 0274, 0328
ASA	0257, 0265	Casio	0317	Desmet	0268, 0271, 0274	FIRST LINE	0260, 0261, 0268
Asberg	0249, 0268, 0274	Cathay	0268, 0271, 0274	Diamant	0274	Firstline	0273, 0274, 0327, 0328
Astra	0261	CCE	0229, 0328	Diamond	0327	Fisher	0065, 0243, 0257, 0260, 0266, 0269, 0328
Asuka	0259, 0260, 0262, 0327, 0328	Celebrity	0057, 0101	DiamondVision	0213, 0221	Flint	0268, 0274
Atlantic	0260, 0268, 0271, 0274, 0327	Celera	0117	Dimensia	0099	Formenti	0249, 0257, 0258, 0260, 0271, 0327
Atori	0261, 0273	Centurion	0268, 0271, 0274	Disney	0137	Formenti/Phoenix	0327
Auchan	0275	Century	0257	Dixi	0261, 0268, 0271, 0273, 0274, 0328	Fortress	0257, 0258
Audiosonic	0243, 0260, 0261, 0262, 0268, 0271, 0274, 0328	CGE	0243, 0249	Dream Vision	0415, 0416	Fraba	0243, 0274
AudioTon	0243, 0260, 0328	Changhong	0117	DTS	0261, 0273	Friac	0243
Audiovox	0104, 0144, 0225	Chimei	0323	Dual	0260, 0274, 0328	Frontech	0259, 0261, 0264, 0265, 0273, 0328
		Cimline	0261, 0273	Dual-Tec	0260, 0261	Fujitsu	0023, 0024, 0025, 0105, 0328
		Citizen	0072, 0085, 0090, 0096, 0104	Dumont	0076, 0090, 0108, 0257, 0260, 0263, 0328	Fujitsu General	0328
		City	0261, 0273				
		Clarion	0225				
		Clarivox	0271				

Fujitsu Siemens	0425, 0426, 0427, 0428, 0429	Hinari	0261, 0262, 0266, 0268, 0271, 0273, 0274	Kaisui	0260, 0261, 0262, 0270, 0273, 0274, 0327, 0328	Magnavox	0072, 0088, 0090, 0091, 0095, 0096, 0098, 0114, 0115, 0129, 0134, 0176, 0178, 0189, 0210
Funai	0033, 0034, 0035, 0036, 0037, 0097, 0104, 0105, 0225, 0259	Hisawa Hisense Hitachi	0262, 0270, 0275 0165 0006, 0014, 0015, 0016, 0042, 0072, 0090, 0094, 0173, 0254, 0255, 0256, 0260, 0264, 0265, 0266, 0274, 0285, 0300, 0319, 0328, 0348, 0349, 0385, 0402, 0410	Kamosonic Kamp Kapsch Karcher	0260 0260, 0327 0265 0243, 0260, 0261, 0271, 0274	Magnum Majestic Mandor	0259, 0261 0100 0259
Futuretech	0104, 0225			Kawasho	0072, 0090, 0101, 0327	Manesth	0259, 0260, 0268, 0271, 0274, 0328
Galaxi	0269, 0274			KEC	0225	Marantz	0072, 0088, 0090, 0096, 0158, 0268, 0271, 0274
Galaxis	0243, 0274			Kendo	0243, 0263, 0264, 0274		
Gateway	0163, 0226, 0227			Kenwood	0072, 0090, 0096	Marelli	0257
GBC	0261, 0266, 0273			KIC	0328	Mark	0268, 0271, 0273, 0274, 0327, 0328
GE	0069, 0071, 0072, 0073, 0077, 0090, 0099, 0102, 0106, 0112, 0131	Hornlyphon	0268, 0274	Kingsley	0260, 0327		
Geant Casino	0275	Hoshai	0262	KLH	0117	Masuda	0328
GEC	0260, 0265, 0268, 0271, 0274, 0328	Huanyu	0260, 0327, 0328	Kloss Novabeam	0104, 0107	Matsui	0260, 0261, 0264, 0266, 0268, 0271, 0273, 0274, 0328, 0405
Geloso	0261, 0264, 0273	Hygashi	0260, 0261, 0273, 0327, 0328	Kneissel	0243, 0250, 0274		
General Technic	0261, 0273	Hyper	0260, 0261, 0273, 0327, 0328	Kolster	0268, 0274		
Genexxa	0262, 0265, 0268, 0274	Hypson	0259, 0260, 0268, 0270, 0271, 0274, 0275, 0328	Konka	0262	Matsushita	0067
GFM	0177, 0210			Korpel	0268, 0271, 0274	Maxent	0193, 0226
Giant	0328	Hyundai	0223	Korting	0243, 0257	Mediator	0268, 0271, 0274
Gibraltar	0076, 0090, 0096, 0108	Iberia	0274	Kosmos	0274	Medion	0259, 0261, 0274
GoldHand	0327	ICE	0259, 0260, 0261, 0262, 0268, 0273, 0274, 0327, 0328	Koyoda	0261	Megapower	0222
Goldline	0274			KTV	0085, 0096, 0104, 0225, 0229, 0260, 0328	Megatron	0072, 0077
GoldStar	0072, 0077, 0085, 0090, 0094, 0096, 0103, 0243, 0260, 0261, 0264, 0268, 0271, 0273, 0274, 0327, 0328	ICeS	0327	Kyoto	0327, 0328	MElectronic	0273, 0274, 0327, 0328
		Ilo	0198, 0203	Lasat	0243	Melvox	0275
		IMA	0104	Lenco	0261, 0273	Memorex	0065, 0072, 0077, 0100, 0103, 0133, 0219, 0261, 0273
		Imperial	0243, 0249, 0265, 0268, 0269, 0274	Lenoir	0260, 0261, 0273		
		Indiana	0268, 0271, 0274	Leyco	0259, 0268, 0271, 0274	Memphis	0261, 0273
Goodmans	0164, 0259, 0261, 0266, 0268, 0271, 0273, 0274, 0322, 0328, 0395, 0399, 0412	Infinity	0088	LG	0016, 0038, 0039, 0077, 0103, 0145, 0222, 0243, 0246, 0253, 0260, 0261, 0264, 0268, 0271, 0273, 0274, 0282, 0290, 0299, 0316, 0327, 0328, 0351, 0359, 0367, 0382, 0384, 0389, 0396	Mercury	0273, 0274
		InFocus	0168, 0277, 0313, 0397, 0430			Metz	0257
		Ingelen	0265			MGA	0072, 0077, 0090, 0096, 0103
Gorenje	0243, 0269	Ingersol	0261, 0273			Micromaxx	0259, 0261
GPM	0262	Initial	0203			Microstar	0259, 0261
GPX	0211	Inno Hit	0249, 0260, 0261, 0262, 0268, 0271, 0273, 0274, 0328			Midland	0069, 0071, 0073, 0076, 0085, 0106, 0108
Gradiente	0162						
Graetz	0265	Innovation	0259, 0261			Minerva	0249
Granada	0249, 0260, 0264, 0266, 0268, 0271, 0274, 0275, 0328	Insignia	0182, 0188, 0190, 0209	LG/GoldStar	0246	Minoka	0268, 0274
		Inteq	0076	Liesenk	0271	Mintek	0203
Grandin	0261, 0262, 0270, 0271	Interactive	0243	Liesenkotter	0274	Mitsubishi	0006, 0015, 0016, 0048, 0072, 0077, 0090, 0103, 0196, 0224, 0257, 0266, 0268, 0274, 0298, 0371
		Interbuy	0261, 0273	Life	0259, 0261		
Gronic	0328	Interfunk	0243, 0257, 0265, 0268, 0271, 0274	Lifetec	0259, 0261, 0273, 0274		
Grundig	0242, 0243, 0249, 0274, 0356	International	0327	Lloyds	0273		
Grunpy	0104, 0105, 0225	Intervision	0243, 0259, 0260, 0263, 0274, 0328	Loewe	0243, 0250, 0274, 0280, 0306, 0347	Mivar	0243, 0249, 0250, 0260, 0327, 0328
Haier	0187, 0207			Loewe Opta	0257, 0268, 0271		
Halifax	0259, 0260, 0327, 0328	Irradio	0249, 0261, 0262, 0268, 0271, 0273, 0274	Logik	0100	Monivision	0222
Hallmark	0072, 0077, 0090			Luma	0264, 0271, 0273, 0274	Montgomery Ward	0100
Hampton	0260, 0327, 0328	Isukai	0262, 0274	Lumatron	0264, 0268, 0271, 0274, 0328	Motion	0249
Hanseatic	0243, 0250, 0260, 0261, 0266, 0268, 0271, 0273, 0274, 0328	ITC	0260, 0328	Lux May	0268	Motorola	0102, 0224
		ITS	0262, 0268, 0270, 0274, 0327	Luxman	0072, 0090	MTC	0072, 0090, 0096, 0103, 0243, 0327
		ITT	0261, 0265	Luxor	0260, 0264, 0328	Multi System	0271
Hantarex	0261, 0273, 0274	ITV	0261, 0271, 0274	LXI	0061, 0065, 0071, 0072, 0073, 0077, 0088, 0099	Multitech	0104, 0225, 0229, 0243, 0260, 0261, 0263, 0264, 0266, 0271, 0273, 0274, 0327, 0328
Hantor	0274	Janeil	0107				
Harman/Kardon	0088	JBL	0088				
Harvard	0104, 0225	JC Penney	0072, 0073, 0085, 0090, 0099, 0103, 0106	M Electronic	0260, 0261, 0265, 0267, 0268, 0271	Murphy	0260, 0327
Harwood	0273, 0274			MAG	0050	NAD	0061, 0072, 0077
Havermy	0224			Magnadyne	0257, 0263, 0271	Naonis	0264
HCM	0259, 0260, 0261, 0270, 0273, 0274, 0328	JCB	0057, 0101	Magnafon	0249, 0260, 0263, 0327	NEC	0026, 0053, 0072, 0090, 0096, 0102, 0103, 0266, 0328
		Jensen	0072, 0090				
Hema	0273, 0328	JVC	0017, 0018, 0019, 0092, 0093, 0094, 0106, 0251, 0252, 0266, 0268, 0293, 0360, 0379				
Hewlett Packard	0146						
Higashi	0327						
HiLine	0274						

Neckermann	0243, 0257, 0260, 0264, 0268, 0269, 0271, 0274, 0328		0114, 0135, 0143, 0176, 0178, 0189, 0210, 0212, 0232, 0233, 0257, 0260, 0268, 0271, 0274, 0278, 0287, 0301, 0302, 0307, 0311, 0314, 0330, 0331, 0333, 0337, 0338, 0339, 0341, 0343, 0345, 0355, 0363, 0365, 0377, 0378, 0381, 0383, 0406, 0409, 0414	RCA	0071, 0072, 0073, 0074, 0075, 0090, 0099, 0102, 0103, 0109, 0120, 0179, 0218	SEI-Sinudyne Seleco Sencora Sentra Serino Sharp	0257, 0263, 0265 0264, 0265, 0266 0261, 0273 0273 0009, 0010, 0011, 0072, 0080, 0081, 0082, 0083, 0085, 0090, 0094, 0110, 0148, 0183, 0216, 0224, 0247, 0248, 0258, 0266, 0288, 0304, 0324, 0325, 0340, 0358, 0362, 0369, 0386, 0392, 0398, 0400, 0401, 0403	
NEI	0268, 0271, 0274			Realistic	0065, 0077, 0096, 0225			
Net-TV	0226			Recor	0274			
Neufunk	0273, 0274			Redstar	0274			
New Tech	0261, 0268			Reflex	0274			
New World	0262			Revox	0243, 0268, 0271, 0274			
NewTech	0273, 0274, 0328			Rex	0259, 0264, 0265			
Nicamagic	0260, 0327			RFT	0243, 0250, 0257			
Nikkai	0259, 0260, 0262, 0268, 0271, 0273, 0274, 0327, 0328			Rhapsody	0327			
Nikko	0072, 0077, 0096			R-Line	0268, 0271, 0274			
Noblisko	0249, 0260, 0263, 0327	Philips Magnavox Phoenix	0089, 0114, 0115 0243, 0257, 0268, 0271, 0274, 0327	Roadstar	0259, 0261, 0262, 0273	Sheng Chia Shogun	0224 0090	
Nokia	0265	Phonola	0257, 0268, 0271, 0274, 0327	Robotron	0257		0257, 0263, 0275	
Norcent	0155			Rowa	0327, 0328	Siarem	0257, 0263, 0274	
Nordic	0328			Royal Lux	0243	Sierra	0268, 0274	
Nordmende	0257, 0265, 0267, 0268	Pilot	0085, 0090, 0096	RTF	0257	Siesta	0243	
Nordvision	0271	Pioneer	0012, 0013, 0072, 0090, 0243, 0265, 0267, 0268, 0271, 0274, 0408	Runco	0076, 0096, 0108	Signature	0100	
Novatronic	0274			Saba	0257, 0265, 0267, 0272, 0376	Silva	0327	
Oceanic	0265, 0275			Saisho	0259, 0260, 0261, 0273, 0328	Silver	0266	
Okano	0243, 0269, 0274	Plantron	0259, 0268, 0273, 0274			Singer	0257, 0263, 0275	
Olevia	0052, 0140, 0149, 0154, 0157					Simudyne	0257, 0263, 0271, 0274	
ONCEAS	0260	Playsonic	0328	Salora	0264, 0265	Skantic	0265	
Onwa	0104, 0225	Polaroid	0117, 0152, 0184, 0220	Sambers	0249, 0263	Solavox	0265	
Opera	0274			Sampo	0072, 0085, 0090, 0096, 0226	Soniton	0243, 0328	
Oppo	0208	Poppy	0261, 0273	Samsung	0029, 0030, 0031, 0032, 0044, 0045, 0046, 0047, 0072, 0077, 0084, 0085, 0086, 0087, 0090, 0094, 0096, 0103, 0118, 0217, 0229, 0235, 0236, 0237, 0243, 0259, 0260, 0261, 0268, 0269, 0271, 0273, 0274, 0284, 0295, 0327, 0328, 0336, 0346, 0390, 0407		Sonolor	0265, 0275
Optimus	0065, 0067	Portland	0072, 0085, 0090, 0103			Sontec	0243, 0268, 0271, 0274	
Optoma	0194	Prandoni-Prince	0249, 0264			Sony	0041, 0057, 0058, 0059, 0060, 0101, 0116, 0125, 0126, 0127, 0142, 0169, 0170, 0171, 0172, 0174, 0234, 0261, 0266, 0276, 0289, 0292, 0393, 0411	
Optonica	0224	Precision	0260, 0328				0262, 0263	
Orbit	0268, 0274	Prima	0161, 0207, 0261, 0265, 0273				0104, 0105, 0225	
Orion	0121, 0192, 0261, 0268, 0271, 0273, 0274, 0282, 0329	Princeton	0222				0268, 0271, 0274	
Orline	0274	Prism	0069, 0106				0273, 0274	
Osaki	0259, 0260, 0262, 0274, 0328	Profex	0261, 0273				0270, 0277, 0090, 0104, 0105, 0225	
Oso	0262	Profi-Tronic	0268, 0274				0268, 0271, 0274	
Otto Versand	0258, 0260, 0266, 0268, 0270, 0271, 0274, 0328	Proline	0268, 0274				0097	
Pael	0260, 0327	Proscan	0071, 0073, 0099				0090, 0104, 0225	
Palladium	0243, 0260, 0269, 0274, 0328	Prosonic	0243, 0260, 0271, 0274, 0327, 0328				0260, 0261, 0262, 0268, 0273, 0274, 0328	
Palsonic	0328	Protech	0259, 0260, 0261, 0263, 0268, 0271, 0328	Sandra	0260, 0327, 0328	Sound & Vision	0262, 0263	
Panama	0259, 0260, 0261, 0273, 0274, 0327, 0328	Proton	0072, 0077, 0090, 0094	Sansui	0063, 0121, 0268, 0274	Soundesign	0072, 0077, 0090, 0104, 0105, 0225	
Panasonic	0006, 0007, 0066, 0067, 0068, 0069, 0070, 0102, 0106, 0113, 0147, 0215, 0241, 0265, 0274, 0279, 0310, 0332, 0334, 0368, 0374	Protron	0150	Sanyo	0020, 0021, 0022, 0049, 0065, 0090, 0141, 0191, 0243, 0250, 0260, 0266, 0273, 0291, 0327, 0328, 0370, 0373, 0391	Soundwave	0268, 0271, 0274	
Panavision	0274	PROVIEW	0050, 0164			Squareview	0097	
Pathe Cinema	0243, 0250, 0260, 0275, 0327	Provision	0271, 0274			SSS	0260, 0261, 0262, 0268, 0273, 0274, 0328	
Pausa	0261, 0273	Pulsar	0076, 0090, 0108			Standard	0260, 0261, 0262, 0268, 0273, 0274, 0328	
Penney	0061, 0069, 0071, 0077, 0096	Pye	0268, 0271, 0274, 0296, 0338	SBR	0271, 0274	Starlite	0104, 0225, 0271, 0273, 0274	
Perdio	0274, 0327	Pymi	0261, 0273	Sceptre	0166, 0185	Stenway	0270	
Perfekt	0274	Quandra Vision	0275	Schaub Lorenz	0265	Stern	0264, 0265	
Philco	0072, 0088, 0090, 0091, 0094, 0096, 0102, 0103, 0243, 0249, 0257, 0274	Quasar	0067, 0069, 0102, 0106	Schneider	0260, 0262, 0268, 0271, 0274, 0287, 0300, 0328, 0364, 0366	Strato	0273, 0274	
Philharmonic	0260, 0328	Quelle	0259, 0260, 0268, 0271, 0274, 0328			Stylandia	0328	
Philips	0040, 0088, 0089, 0090, 0091, 0094, 0098, 0099, 0102,	Questa	0266			Sunkai	0261	
		Radiolva	0274	Scotch	0072, 0077	Sunstar	0273, 0274	
		RadioShack	0065, 0071, 0077, 0096, 0225, 0274	Scott	0072, 0077, 0090, 0094, 0104, 0105, 0199, 0225	Sunwood	0261, 0268, 0273, 0274	
		RadioShack/Realistic	0072, 0085, 0090, 0094, 0099, 0104			Superla	0260, 0327, 0328	
		Radiola	0268, 0271, 0274, 0328	Sears	0061, 0065, 0071, 0072, 0073, 0077, 0088, 0090, 0097, 0099, 0105	Superscan	0095, 0224	
		Radiomarelli	0257, 0274			SuperTech	0273, 0274, 0327	
		Radiotone	0243, 0268, 0273, 0274	SEG	0259, 0260, 0263, 0266, 0271, 0273, 0274, 0300, 0327, 0328	Supra	0261, 0273	
		Rank	0266			Supre-Macy	0107	
						Supreme	0057, 0101	
						Susumu	0262	
						Sutron	0261, 0273	
						SVA	0197	
						Sydney	0260, 0327, 0328	
				SEI	0274			

Sylvania	0072, 0088, 0089, 0090, 0091, 0095, 0096, 0097, 0098, 0175, 0177, 0210	Triumph	0274	Adventura	1023	Dumont	1072, 1078
		Uher	0243, 0249, 0265, 0268, 0274	Adyson	1090	Durabrand	1032
		Ultravox	0257, 0260, 0263, 0274, 0327	Aiwa	1023, 1072, 1073, 1074	Dynatech	1023
Symphonic	0097, 0104, 0108, 0133, 0210, 0225	United	0274	Akai	1071, 1073	Echostar	1064
Syntax	0149	Unic Line	0274	Akiba	1079, 1090	Elbe	1091
Syntax-Brilliant	0149	United	0271	Akura	1073, 1079, 1090	Elcatech	1090
Sysline	0271	Universum	0243, 0249, 0259, 0268, 0269, 0271, 0274, 0328	Alba	1074, 1075, 1076, 1079, 1090, 1091	Electrohome	1021
Sytong	0327			Alienware	1066	Electrohome	1021
Tandy	0224, 0258, 0260, 0262, 0265, 0328	Univox	0274	Ambassador	1076	Elsay	1090
		Vector Research	0096	American High	1022	Elta	1079, 1090, 1091
Tashiko	0260, 0264, 0266, 0327, 0328	Vestel	0264, 0265, 0268, 0269, 0271, 0274, 0328	Amstrad	1072, 1090, 1091	Emerson	1021, 1022, 1023, 1070, 1090
Tatung	0102, 0227, 0260, 0268, 0271, 0274, 0328	Vexa	0261, 0271, 0273, 0274	Anitech	1079, 1090	ESC	1075, 1091
TCM	0259, 0261	Victor	0093, 0266, 0268	Apex	1010	Etzuko	1079, 1090
Teac	0274, 0328	VIDEOLÓGIC	0327	ASA	1077, 1078	Expressvu	1064
Tec	0260, 0261, 0273, 0328	Videologique	0260, 0262, 0327, 0328	Asa	1020	Ferguson	1073
Technics	0067, 0069, 0106	VideoSystem	0268, 0274	Asuka	1072, 1077, 1078, 1079, 1090	Fidelity	1072, 1090
TechniSat	0320, 0417, 0418, 0419	Videotechnic	0327, 0328	Audio Dynamics	1018	Finlandia	1078
		Vidikron	0088	Audiosonic	1091	Finlux	1072, 1073, 1078
Techwood	0069, 0072, 0090, 0106	Vidtech	0072, 0077, 0090, 0103	Audiovox	1021	Firstline	1074, 1077, 1079, 1090
TEDELEX	0328	Viewsonic	0153, 0186, 0226, 0318	Baird	1072, 1073, 1075, 1091	Fisher	1019
Teknika	0072, 0085, 0088, 0090, 0094, 0100, 0103, 0104, 0105, 0225	Viking	0107	Bang & Olufsen	1067	Flint	1074
Televia	0267	Viore	0198	Basic Line	1074, 1075, 1076, 1079, 1090, 1091	Formenti/Phoenix	1078
Telecor	0274, 0328	Visiola	0260, 0327	Baur	1078	Frontech	1076
Telefunken	0267, 0268, 0272, 0274	Vision	0268, 0274, 0328	Beaumarck	1020	Fuji	1022
		Vizio	0090, 0136, 0160, 0227, 0420, 0421, 0422, 0423, 0424	Bell & Howell	1019	Fujitsu	1072
Telegazi	0274	Vortec	0268, 0271, 0274	Bestar	1075, 1076, 1091	Funai	1023, 1072
Telemeister	0274	Voxson	0249, 0257, 0264, 0265, 0268, 0274	Black Panther Line	1075, 1091	Galaxy	1072
Telesonic	0274	Waltham	0260, 0274, 0328	Blaupunkt	1078	Garrard	1023
Telestar	0274	Wards	0072, 0077, 0088, 0090, 0091, 0096, 0098, 0099, 0100, 0103, 0105	Bondstec	1076, 1090	Gateway	1066
Teletech	0261, 0271, 0273, 0274			Broksonic	1054	GBC	1076, 1079
Teleton	0260, 0328	Watson	0268, 0271, 0274	Bush	1074, 1075, 1079, 1090, 1091, 1097, 1099, 1109, 1139	GE	1020, 1022
Televideon	0327	Watt Radio	0260, 0263, 0327	Calix	1021	GEC	1078
Televiso	0275	Waycon	0061	Candle	1020, 1021	Geloso	1079
Tensai	0261, 0262, 0268, 0273, 0274, 0328	Wega	0257, 0266, 0274	Canon	1022	General	1076
		Wegavox	0273	Cathay	1091	General Technic	1074
Tesmet	0268	Weltblick	0268, 0271, 0274, 0328	Catron	1076	GOI	1064
Tevion	0259, 0261	Westinghouse	0057, 0138, 0142	CGE	1072, 1073	GoldHand	1079, 1090
Textet	0260, 0273, 0327, 0328	White Westinghouse	0008, 0119, 0260, 0263, 0271, 0274, 0327	Cimline	1074, 1079, 1090	Goldstar	1018, 1021, 1072, 1077
Thomson	0238, 0239, 0240, 0260, 0267, 0268, 0272, 0274, 0335	Wincom	0055, 0056	CineVision	1058	Goodmans	1072, 1075, 1076, 1077, 1079, 1090, 1091
		Xrypton	0274	Citizen	1020, 1021	Gradiente	1023
Thorn	0072, 0077, 0090	Yamaha	0000, 0001, 0002, 0003, 0004, 0005, 0103	Clatronic	1076, 1090	Graetz	1073
TMK	0076			Colortyme	1018	Granada	1078
TNCi	0268, 0274, 0328	Yamishi	0274, 0328	Condor	1075, 1076, 1091	Grandin	1072, 1075, 1076, 1077, 1079, 1090, 1091
Tokai	0260, 0327	Yokan	0274	Craig	1020, 1021	Grundig	1078, 1079
Tokyo	0270	Yoko	0243, 0259, 0260, 0261, 0262, 0268, 0271, 0273, 0274, 0327, 0328	Crown	1075, 1076, 1079, 1090, 1091	Hanseatic	1077, 1078, 1091
Toshiba	0027, 0043, 0053, 0054, 0061, 0062, 0063, 0064, 0065, 0122, 0123, 0124, 0128, 0130, 0132, 0139, 0214, 0244, 0266, 0283, 0305, 0328, 0329, 0342, 0350, 0352, 0353, 0354, 0375, 0404	Zenith	0076, 0077, 0078, 0079, 0090, 0100, 0108, 0111	Curtis Mathes	1018, 1020, 1022	Harley Davidson	1023
Totevision	0085	Zanussi	0264, 0328	Cybernex	1020	Harman/Kardon	1018
Towada	0265, 0328			CyberPower	1066	Harwood	1090
Trakton	0328	ABS	1066	Daewoo	1023, 1075, 1076, 1091, 1116, 1141	HCM	1079, 1090
Trans Continens	0274, 0328			Dansai	1079, 1090, 1091	Headquarter	1019
Transtec	0327			Dantax	1074	Hewlett Packard	1066
Trident	0328			Daytron	1075, 1091	Hinari	1074, 1079, 1090, 1091
				DBX	1018	Hisawa	1074
				De Graaf	1078	Hitachi	1072, 1073, 1078, 1089, 1108, 1124
				Decca	1072, 1073, 1078	HNS	1060
				Dell	1066	Howard Computers	1066
				Denko	1090		1066
				DiamondVision	1050	HP	1066
				DigiFusion	1092	HTS	1064
				DIRECTV	1035, 1038, 1040, 1059, 1060, 1061, 1065	Hughes	1035, 1040, 1061
				Dish Network	1064	Hughes Network Systems	1038, 1060
				Dishpro	1064	Humax	1035, 1060, 1094
				Dual	1073, 1078, 1091	Hush	1066
						Hypson	1074, 1079, 1090, 1091

iBUYPOWER	1066	Multitech	1020, 1023, 1072,	Ricavision	1066	Telefunken	1073
Impego	1076		1076, 1078, 1079,	Roadstar	1075, 1077, 1079,	Teletech	1090, 1091
Imperial	1072		1090		1090, 1091	Tenosal	1079, 1090
Inno Hit	1075, 1076, 1078,	Murphy	1072	Royal	1090	Tensai	1072, 1077, 1079,
	1079, 1090, 1091	NEC	1018, 1019, 1073	Runco	1032		1090
Innovation	1074	Neckermann	1073, 1078	Saba	1073	Tevion	1074
Instant Replay	1022	NEI	1078	Saisho	1074, 1079	Thomson	1073, 1087
Interbuy	1077, 1090	Nesco	1079, 1090	Samsung	1006, 1020, 1038,	Thorn	1073
Interfunk	1078	Nikkai	1076, 1090, 1091		1040, 1046, 1060,	Tivo	1035, 1036, 1037,
Intervision	1072, 1091	Nikko	1021		1080, 1107, 1110,		1039, 1040, 1060,
Irradio	1077, 1079, 1090	Niveus Media	1066		1112, 1121, 1123,		1061, 1062
ITT	1073	Noblex	1020		1140, 1142	TMK	1020
ITV	1075, 1077, 1091	Nokia	1073, 1091	Samurai	1076, 1090	Tokai	1077, 1079, 1090
JC Penney	1018, 1019, 1020,	Nordmende	1073	Sanky	1032	Tonsai	1079
	1021, 1022	Northgate	1066	Sansui	1033, 1056, 1069,	Toshiba	1004, 1005, 1034,
JCL	1022	Oceanic	1072, 1073		1073		1051, 1063, 1066,
JVC	1011, 1012, 1013,	Okano	1074, 1090, 1091	Sanyo	1019, 1020, 1114		1073, 1078, 1086,
	1014, 1015, 1016,	Olympus	1022	Saville	1091		1099, 1102, 1119,
	1017, 1018, 1019,	Optimus	1021	SBR	1078		1144
	1028, 1035, 1064,	Orion	1033, 1069, 1074,	Schaub Lorenz	1072, 1073	Totevision	1020, 1021
	1073, 1085, 1117,		1097, 1139	Schneider	1072, 1074, 1075,	Touch	1066
	1130, 1131, 1133,	Orson	1072		1076, 1077, 1078,	Towada	1079, 1090
	1134, 1135, 1136	Osaki	1072, 1077, 1079,		1079, 1090, 1091	Towika	1079, 1090
Kaisui	1079, 1090		1090	Sears	1019, 1021, 1022	TVA	1076
Karcher	1078	Otto Versand	1078	SEG	1079, 1090, 1091	Uher	1077
Kendo	1074, 1075, 1076,	Palladium	1073, 1077, 1079,	SEI-Sinudyne	1078	UltimateTV	1065
	1090		1090	Seleco	1073	Ultravox	1091
Kenwood	1018, 1019, 1073	Panasonic	1007, 1008, 1009,	Sentra	1076, 1090	Unitech	1020
Kodak	1021, 1022		1022, 1026, 1042,	Sentron	1079, 1090	United Quick Star	1075, 1091
Korpel	1079, 1090		1043, 1068, 1082,	Sharp	1031, 1045, 1057,	Universum	1072, 1077, 1078
Kyoto	1090		1101, 1126, 1132		1081, 1115, 1137	Vector Research	1018
Lenco	1075	Pathe Marconi	1073	Shintom	1079, 1090	Video Concepts	1018
Leyco	1079, 1090	Perdio	1072	Shivaki	1077	Videon	1074
LG	1021, 1053, 1072,	Philco	1022, 1090	Shogun	1020	Videosonic	1020
	1077, 1088, 1100,	Philips	1022, 1030, 1035,	Siemens	1077	Viewsonic	1066
	1106, 1125, 1143		1038, 1039, 1040,	Silva	1077	Voodoo	1066
Lifetec	1074		1044, 1055, 1060,	Silver	1091	Wards	1020, 1021, 1022,
Linksys	1066		1078, 1084, 1095,	Singer	1022		1023
Lloyd's	1023		1096, 1104, 1105,	Sinudyne	1078	Weltblick	1077
Loewe Opta	1077, 1078		1111, 1113, 1122,	Solavox	1076	XR-1000	1022, 1023
Logik	1079, 1090		1124, 1127, 1128,	Sonic Blue	1041, 1068	Yamaha	1018, 1019
Lumatron	1075, 1091		1129	Sonneclair	1090	Yamishi	1079, 1090
Luxor	1090	Philips Magnavox	1030	Sonoko	1075, 1091	Yokan	1079, 1090
LXI	1021	Phonola	1078	Sontec	1077	Yoko	1076, 1077, 1079,
M Electronic	1072	Pilot	1021	Sony	1000, 1001, 1002,		1090
Magnavox	1022, 1032, 1044,	Pioneer	1078, 1118		1003, 1024, 1027,	Zenith	1032
	1070	Polaroid	1010, 1049		1036, 1062, 1066,	ZT Group	1066
Magnin	1021	Portland	1075, 1076, 1091		1083, 1098, 1103,		
Manesth	1079, 1090	Prinz	1072		1138	DVD	
Marantz	1018, 1019, 1022,	Profex	1079	Stack	1066	4Kus	2097
	1078	Proline	1072	Stack 9	1066	Accurian	2220
Mark	1091	Proscan	1065	Standard	1075, 1091	Advent	2169, 2201
Marta	1021	Prosonic	1074, 1091	Stern	1091	AEG	2312
Matsui	1074, 1077	Pulsar	1032	STS	1022	Airis	2318
Matsushita	1022	Pye	1052, 1078	Sunkai	1074	Aiwa	2272
Media Center PC	1066	Quarter	1019	Sunstar	1072	Akai	2170, 2195, 2225,
Mediator	1078	Quartz	1019	Suntronic	1072		2227
Medion	1074	Quasar	1022	Sunwood	1079, 1090	Akura	2310
MEI	1022	Quelle	1072, 1078	Superscan	1070	Alba	2018, 2232, 2247,
Memorex	1019, 1020, 1021,	Radialva	1090	Sylvania	1022, 1023, 1044,		2259, 2264
	1022, 1023, 1032,	RadioShack	1021		1052, 1070	Alco	2199
	1048, 1069, 1072,	RadioShack/Realistic	1019, 1020, 1021,	Symphonic	1023, 1044, 1090	Alize	2315
	1077		1022, 1023	Systemax	1066	Allegro	2215
Memphis	1079, 1090			Tagar Systems	1066	Amitech	2312
MGN Technology	1020	Radiola	1078	Taisho	1074	Amphion MediaWorks	
Micromaxx	1074	Radix	1021	Tandberg	1091		2145
Microsoft	1066	Randex	1021	Tandy	1019	AMW	2145, 2313
Microstar	1074	RCA	1020, 1022, 1025,	Tashiko	1021, 1072	Apex	2044, 2045, 2046,
Migros	1072		1035, 1040, 1047,	Tatung	1072, 1073, 1078		2047, 2076, 2208,
Mind	1066		1060, 1065	TCM	1074, 1093, 1120		2209
Mitsubishi	1029, 1072, 1078	Realistic	1019, 1020, 1021,	Teac	1023, 1091	Apple	2163
Motorola	1022		1022, 1023	Tec	1076, 1090, 1091	Arrgo	2216
MTC	1020	ReplayTV	1041, 1068	Technics	1022	Asono	2318
		Rex	1073	Teknika	1021, 1022, 1023	Aspire	2140, 2202
		RFT	1076, 1078, 1090	Teleavia	1073	Astar	2162

ATACOM	2318	Enzer	2302	LG	2080, 2107, 2115,	2252, 2256, 2260,
Audiovox	2111, 2199	Epson	2165		2116, 2141, 2188,	2268, 2282, 2332,
Avious	2317	ESA	2219		2211, 2215, 2237,	2333, 2343, 2344,
Awa	2313	Finlux	2304, 2312, 2317		2239, 2285, 2293,	2345, 2367, 2371,
Axion	2171	Fintec	2299		2295, 2348, 2370	2373, 2380, 2382,
Bang & Olufsen	2210	Fisher	2212	Life	2228	2385
Baze	2317	Funai	2219	Lifetec	2228	Phonotrend 2317
BBK	2318	Gateway	2097	Limit	2305	Pioneer 2012, 2013, 2014,
Bellagio	2313	GE	2079, 2206, 2209	Liquid Video	2204	2063, 2064, 2065,
Best Buy	2309	Gericom	2269	Liteon	2097, 2121, 2220	2066, 2067, 2113,
Blaupunkt	2209	GFM	2176	Loewe	2274	2134, 2207, 2230,
Blue Parade	2207	Giec	2300	LogicLab	2305	2236, 2265, 2266,
Boghe	2300	Global Solutions	2305	Magnavox	2075, 2096, 2178,	2267, 2297, 2322,
Brainwave	2312	Global Sphere	2305		2180, 2196, 2205,	2351, 2352, 2353,
Brandt	2198, 2238	Go Video	2135, 2215		2219, 2308	2354, 2355, 2356,
Broksonic	2192, 2195	Goodmans	2247, 2289, 2298,	Magnex	2317	2357, 2358, 2359,
Bush	2018, 2060, 2248,		2300, 2308, 2330,	Majestic	2314	2377
	2264, 2301, 2308,		2369	Marantz	2282	Pointer 2312
	2317, 2350, 2368	GPX	2177	Marquant	2312	Polaroid 2047, 2133, 2185
California Audio Labs		Gradiente	2197	Matsui	2198, 2296	Portland 2312
		Graetz	2302	McIntosh	2149	Powerpoint 2313
Cambridge Audio	2304	Greenhill	2209	Mecotek	2312	Prima 2174
CAT	2306, 2307	Grundig	2271	Medion	2228	Proceed 2208
CAVS	2146	Grunkel	2312, 2316	Memorex	2078, 2184, 2195	Proscan 2206
Centrum	2307	GVG	2299	MiCO	2300, 2304	Prosonic 2299, 2314
CGV	2304, 2312	H&B	2308	Micromaxx	2228	Prottron 2152
Changhong	2222	H_her	2318	Microsoft	2206	Provision 2308
Cinetec	2313	Haaz	2304, 2305	Microstar	2228	Pye 2194
CineVision	2191, 2215	Haier	2172	Minoka	2312	Qwestar 2198
Clatronic	2308, 2317	Harman/Kardon	2125, 2213	Minowa	2317	Raite 2302
Coby	2077, 2124, 2314	HiMAX	2309	Mintek	2167, 2209	RCA 2058, 2059, 2071,
Conia	2301	Hitachi	2008, 2033, 2108,	Mitsubishi	2081	2079, 2183, 2199,
Continental Edison			2302, 2309, 2320,	Mizuda	2308, 2309	2206, 2207, 2209
			2366	Monyka	2302	2310, 2312, 2314
Crown	2312	Hiteker	2208	Mustek	2232	RedStar 2203
C-Tech	2305	Home Tech Industries		Mx Onda	2304	Regent 2305
Curtis Mathes	2217		2318	Mystral	2316	Reoc 2315
CVG	2299	Hyundai	2316	Naiko	2312	Rimax 2215
CyberHome	2048, 2068, 2216,	Ilo	2167	Nesa	2209	Roadstar 2281, 2308
	2233, 2258	Initial	2167, 2209	Neufunk	2302	Ronin 2313
Cytron	2166	Innovation	2228	Nevir	2312	Rotel 2153
Daenyx	2313	Insignia	2080, 2175, 2219	Next Base	2221	Rowa 2200, 2301
Daewoo	2083, 2215, 2280,	Integra	2207	Nexxtech	2161	Rowsonic 2307
	2299, 2312, 2313,	Irradio	2103	NU-TEC	2301	Saba 2198, 2238
	2326, 2376	iSymphony	2164	Onkyo	2205, 2290	Sabaki 2305
Daewoo International		JBL	2213	Oopla	2097	Saivod 2312
		JVC	2049, 2050, 2051,	Oppo	2150, 2173	Sampo 2223
Dalton	2311		2052, 2053, 2054,	Optim	2303	Samsung 2031, 2032, 2033,
Dansai	2303, 2312		2055, 2056, 2057,	Optimus	2230	2034, 2035, 2082,
Daytek	2145, 2234, 2313		2070, 2242, 2261,	Orava	2308	2127, 2137, 2138,
Dayton	2313		2275, 2276, 2277,	Orbit	2313	2154, 2182, 2197,
DEC	2308		2278, 2339, 2340,	Orion	2027, 2060	2283, 2319, 2325,
Decca	2312		2341, 2342, 2386,	Oritron	2198, 2204	2346, 2347, 2349,
Denon	2105, 2147, 2197,		2387, 2389, 2390,	P&B	2308	2372, 2381
	2286		2391	Pacific	2305	Sansui 2027, 2195, 2304,
Denver	2288, 2308, 2310,	Jwin	2148	Panasonic	2015, 2016, 2017,	2305, 2312
	2314	Kansai	2314		2036, 2037, 2038,	Sanyo 2139, 2195, 2212,
Denzel	2302	Kawasaki	2199		2039, 2040, 2041,	2374
Desay	2159	Kennex	2312		2042, 2043, 2074,	ScanMagic 2232
Diamond	2304, 2305	Kenwood	2123, 2197, 2270		2089, 2104, 2108,	Schaub Lorenz 2312
DiamondVision	2179, 2186	KeyPlug	2312		2112, 2120, 2131,	Schneider 2226
Disney	2078, 2088	Kiiro	2312		2132, 2197, 2205,	Scientific Labs 2305
DK Digital	2257	Kingavon	2308		2244, 2245, 2246,	Scott 2243, 2311
Dmtech	2226	Kiss	2302		2253, 2254, 2255,	Seeltech 2318
Dual	2302	KLH	2199, 2209		2292, 2321, 2324,	SEG 2240, 2302, 2305,
Durabrand	2218	Koda	2308		2327, 2328, 2329,	2313
DVX	2305	Koss	2095, 2198, 2204		2331, 2383, 2388	Sharp 2009, 2010, 2084,
Easy Home	2309	KXD	2309	Parasound	2151	2122, 2142, 2143,
Eclipse	2304	Landel	2221	peeKTON	2318	2144, 2181, 2190,
E-Dem	2318	Lasonic	2214	Philips	2026, 2061, 2062,	2228, 2262, 2375
Electrohome	2312	Lawson	2305		2075, 2090, 2094,	Shinsonic 2167
Elin	2312	Lecson	2303		2096, 2097, 2103,	Sigmatek 2309, 2318
Elita	2263, 2312, 2315	Lenco	2308, 2312, 2317		2110, 2126, 2180,	Silva 2310
Emerson	2196, 2211, 2219	Lenox	2203, 2218		2193, 2205, 2231,	Singer 2304, 2305
Enterprise	2211				2235, 2241, 2251,	Skymaster 2279, 2305

Skyworth	2310	Woxter	2315, 2318	Alcatel	3066	Movie Time	3031, 3063
Slim Art	2312	Xbox	2206, 2229	Americast	3046	Mr Zapp	3055
SM Electronic	2305	Xlogic	2305, 2312	Amstrad	3048, 3068	Multichoice	3057
Sonic Blue	2215	XMS	2312	Antronix	3019, 3020	Multitech	3045
Sontech	2316	Xoro	2300	Archer	3020	NEC	3018
Sony	2005, 2006, 2007, 2020, 2021, 2022, 2023, 2024, 2025, 2069, 2072, 2073, 2085, 2086, 2087, 2091, 2092, 2093, 2102, 2128, 2129, 2130, 2249, 2250, 2323, 2334, 2335, 2336, 2360, 2361, 2362, 2363, 2364, 2365, 2384	Yamada	2097, 2313, 2315	Arcon	3048	NET Brazil	3007
Soundmaster	2305	Yamaha	2000, 2001, 2002, 2003, 2011, 2018, 2019, 2036, 2106, 2197, 2273	AT&T	3013	Nokia	3051
Soundmax	2305	Yamakawa	2302, 2313	Axis	3048	Noos	3055
Spectra	2313	Yukai	2232	Bell South	3046	NSC	3031
Spectroniq	2155	Zenith	2080, 2141, 2205, 2211, 2215	Cable Vision	3014	Oak	3024
Standard	2305			Cabletenna	3019	Pace	3011, 3043, 3084
Star Cluster	2305			Cabletime	3058	Palladium	3049
Starmedia	2308, 2318			Cableview	3005	Panasonic	3034, 3036, 3040
Sungale	2158			Clearmaster	3045	Paragon	3040
Sunkai	2312			ClearMax	3045	Philips	3021, 3022, 3029, 3049, 3053, 3054, 3055
Superscan	2196			Clyde Cablevision		Pioneer	3012, 3032, 3038, 3042, 3048, 3083, 3084
Supervision	2305			Colour Voice	3022	Popular Mechanics	
Sylvania	2094, 2180, 2189, 2196, 2219, 2224			Comcast	3006, 3010, 3039		3044
Symphonic	2062, 2180			Comcrypt	3057	Proscan	3015, 3016
Synn	2305			Comtronics	3023	Pulsar	3040
T.D.E. Systems	2316			Contec	3024	PVP Stereo Visual Matrix	
Tatung	2083, 2312			Coolmax	3045		3064
TCM	2228, 2379			COX	3006	Quasar	3040
Teac	2199, 2287, 2301, 2305			Cryptovision	3060	RadioShack	3041, 3045
Tec	2310			Director	3006	RCA	3005, 3036, 3076, 3077
Technics	2197			Eastern	3025	Realistic	3020
Technika	2312, 2317			Everquest	3041	Recoton	3044
Telefunken	2307			Fidelity	3048	Regal	3028
Tensai	2312			Filmnet	3057	Regency	3025
Tevion	2228, 2305, 2311			Filmnet Cablecrypt	3061	Rembrandt	3016
Theta Digital	2207			Filmnet Comcrypt	3061	Runco	3040
Thomson	2229, 2238, 2284, 2294			Finlux	3051	Sagem	3055
Tokai	2302, 2310			Focus	3044	Samsung	3011, 3023, 3032, 3042
Top Suxess	2318			Foxtel	3068	SAT	3048
Toshiba	2004, 2026, 2027, 2028, 2029, 2030, 2098, 2099, 2100, 2101, 2114, 2117, 2118, 2119, 2136, 2187, 2195, 2205, 2291, 2337, 2338, 2378			France Telecom	3054, 3055	Scientific Atlanta	3003, 3004, 3011, 3012, 3013, 3062, 3078, 3079, 3080, 3081, 3082, 3083, 3084
TRANScontinents	2313, 2317			Freebox	3069	Signal	3026, 3041
Transonic	2317			GC Electronics	3020	Signature	3016
Trio	2312			GE	3015, 3016	Sony	3014, 3047
Trutech	2160			GEC	3059	Sprucer	3036
TruVision	2309			Gemini	3026, 3041	Standard Component	3033
TSM	2318			General Instrument	3006, 3008, 3016, 3039, 3050, 3067, 3075	Starcom	3026, 3037, 3041, 3067
Umax	2315				3075	Stargate	3026, 3041
United	2317			Goldstar	3042	Starquest	3026, 3041
Urban Concepts	2205			Gooding	3049	Supercable	3008
US Logic	2167			Grundig	3048, 3049	Supermax	3045
Venturer	2199			Hamlin	3027, 3028	Tele+1	3057, 3061
Viewmaster	2318			Hirschmann	3051	Telepiu	3057
Vocopro	2156			Hitachi	3016	Thomson	3000, 3009
VocoStar	2157			HomeChoice	3056	TIME WARNER	3006
Waitec	2318			Humax	3001, 3002, 3071	Tocom	3017
Welltech	2300			ITT Nokia	3051	Torx	3067
Westinghouse	2109, 2168			Jasco	3041	Toshiba	3040
Wharfedale	2304, 2305			Jerrold	3006, 3008, 3016, 3026, 3037, 3041, 3050, 3064, 3067, 3075	Tristar	3045
				JVC	3049	Tudi	3052
				Kabel Deutschland		Tusa	3026, 3041
					3043, 3073, 3074	TV86	3031
				Macab	3055	Unika	3019, 3020
				Magnavox	3029	United Cable	3037, 3064
				Maspro	3049	Universal	3019, 3020
				Matsui	3049	Universum	3049, 3051
				MegaCable	3039	V2	3045
				Memorex	3030, 3040	Videoway	3065
				Minerva	3049	View Star	3024, 3029, 3031
				Mnet	3057		
				Motorola	3006, 3008, 3010, 3013, 3039, 3072, 3075		

Blu-ray Disc

LG	2115
Panasonic	2089, 2131, 2132
Pioneer	2134
Samsung	2035, 2127
Sharp	2142, 2143, 2144
Sony	2025
Yamaha	2018

DVR

Bush	2060
Panasonic	2037, 2038, 2039, 2040, 2041, 2042
Philips	2061, 2062
Pioneer	2063, 2064, 2065, 2066, 2067
RCA	2059
Samsung	2035
Yamaha	2036

DVD Recorder

Aspire	2140
Astar	2162
Broksonic	2192
Go Video	2135
Hitachi	2108
Insignia	2080
Irradio	2103
JVC	2054, 2055, 2056, 2057
LG	2107, 2115, 2141, 2188
Liteon	2121
Panasonic	2037, 2038, 2039, 2041, 2042, 2043, 2089, 2104, 2108, 2112
Philips	2090, 2096, 2097, 2126, 2193
Pioneer	2067, 2113
Pye	2194
Samsung	2034, 2082, 2138
Sansui	2027
Sanyo	2139
Sony	2022, 2023, 2024, 2085, 2086, 2087, 2102, 2128, 2129, 2130
Sylvania	2189
Toshiba	2030, 2099, 2100, 2101, 2114, 2117, 2118, 2119
Yamaha	2106

Cable

ABC	3004, 3015, 3016, 3017, 3037, 3040, 3067, 3080, 3081
ADB	3070
Adelphia	3003

Viewmaster	3045	Condor	4074, 4090, 4137	Fuba	4074, 4083, 4090,	Lasat	4074, 4088, 4090,
Vision	3045	Connexions	4074, 4092		4092, 4093, 4101,		4100, 4133, 4134,
Visiopass	3051, 3054, 3055	Conrad	4074, 4133, 4136,		4133		4137
Vortex View	3045		4137	Galaxis	4074, 4087, 4090,	Lasonic	4062
Wittenberg	3048	Conrad Electronic	4137, 4139		4091, 4096, 4098,	Lenco	4074, 4083, 4099,
Zenith	3035, 3040, 3046	Contec	4096		4133, 4140		4133, 4137, 4139
Zentek	3044	Coolsat	4050	GE	4015, 4016, 4061,	Leng	4095
		Cosat	4098		4151	Lennox	4098
		Coship	4063	General Instrument		Lenson	4136
		Crown	4089		4027, 4065	Lexus	4103
Sattelite		Daeryung	4092	GMI	4089	LG	4053, 4057, 4099
AB Sat	4138, 4139	Daewoo	4107, 4139	GOI	4039	Lifesat	4074, 4090, 4134,
AccessHD	4058	DDC	4085	Goldbox	4135		4139
ADB	4142	Delega	4085	GoldStar	4099	Lifetec	4090
AGS	4138	Dew	4096	Goodmans	4079, 4080, 4084	Lorenzen	4137
Akai	4101, 4103	Diamond	4097	Goodmind	4061	Lorraine	4099
Alba	4083, 4084, 4085,	Digiality	4137	Grandin	4077	Lupus	4074, 4090
	4086, 4108, 4139	Digital Stream	4059	Grothusen	4083, 4099	Luxor	4136
Aldes	4085, 4087, 4088	DIRECTV	4017, 4018, 4020,	Grundig	4084, 4086, 4093,	Lyonnaise	4102
Allsat	4098, 4101, 4103		4021, 4022, 4024,		4113, 4129, 4136,	Macab	4102
Allsonic	4074, 4087, 4090		4037, 4038, 4040,	Hänsel & Gretel	4137	Magnavox	4045, 4055
Alltech	4139		4041, 4043, 4045,	Hantor	4083, 4095	Manata	4077, 4138, 4139
Alpha	4103		4057, 4106, 4143,	Hanuri	4088	Manhattan	4084, 4088, 4098,
Alpha Digital	4058		4144, 4145, 4146,				4138
Alphastar	4031		4147, 4148, 4149,	Hauppauge	4126	Marantz	4101
Amitronica	4139		4150, 4151, 4152,	Heliocom	4137	Mascom	4088
Amstrad	4089, 4113, 4136,		4153, 4154, 4155,	Hinari	4085	Maspro	4084, 4139
	4139		4156, 4157	Hirschmann	4074, 4093, 4128,	Matsui	4138
Anglo	4139	Discoverer	4134		4136, 4137, 4138	Max	4137
Ankaro	4074, 4087, 4090,	Discovery	4138	Hisawa	4095	Mediabox	4135
	4139	Diseqc	4138	Hisense	4066	Mediamarkt	4089
Anttron	4083, 4086	Dish Network	4011, 4012, 4013,	Hitachi	4032, 4084, 4149,	Mediasat	4091, 4135, 4136
Apollo	4083		4014, 4019, 4039,		4153	Medion	4074, 4090, 4139
Armstrong	4089, 4103		4064	Homecast	4005, 4006, 4007	Medison	4139
Artec	4054	Dishpro	4039, 4064	Houston	4098	Mega	4101, 4103
Asat	4101, 4103	Distrisat	4103	HTS	4039	Memorex	4045
ASLF	4139	Ditrisat	4098	Hughes	4018, 4022, 4144,	Metronic	4077, 4078, 4083,
Astacom	4138	DNT	4092, 4101, 4103		4146, 4150, 4152		4086, 4087, 4088,
Astra	4089, 4091, 4100,	Drake	4026	Hughes Network Systems			4139
	4137, 4139	DStv	4140		4021	Metz	4093
Astro	4074, 4086, 4088,	Dune	4074	Humax	4051, 4075, 4076,	Micro electronic	4136, 4137, 4139
	4090, 4093, 4135,	Echostar	4011, 4019, 4039,		4110	Micro Technology	4139
	4136, 4137		4064, 4092, 4139	Huth	4087, 4089, 4094,	MicroGem	4056
AudioTon	4086, 4098	Einhell	4136, 4139		4095, 4096, 4098,	Micromaxx	4074, 4090
Aurora	4140	Elap	4138, 4139		4137, 4141	Microstar	4090
Austar	4140	Elekta	4088	Hypson	4077	Microtec	4139
Axiel	4138	Elsat	4139	Ilo	4066	Minerva	4093
Axis	4074, 4090, 4091,	Elta	4074, 4083, 4090,	Imex	4077	Mitsubishi	4084, 4093, 4152
	4096		4098, 4101, 4103	Innovation	4090	Mitsumi	4100
Best	4074, 4090	Emanon	4083	Insignia	4057	Morgan's	4089, 4100, 4101,
Blaupunkt	4093	Emme Esse	4074, 4090	Intertronic	4089		4103, 4139
Blue Sky	4139	Engel	4139	Intervision	4098, 4137	Motorola	4008, 4009, 4010,
Boca	4089, 4100, 4105,	Ep Sat	4084	ITT Nokia	4084		4065
	4139	EURIEULT	4077	Jerrold	4065	Multichoice	4140
Boston	4138	Eurodec	4102	Johansson	4095	Multitec	4134
Brain Wave	4095	Europa	4103, 4136, 4137	JOK	4138	Muratto	4099
Broadcast	4094	Europhon	4137	JSR	4098	Mysat	4139
Broco	4139	Eurosat	4089	JVC	4011, 4019, 4039,	Navex	4095
BSkyB	4113, 4123	Eurosky	4074, 4089, 4090,		4079	Neuhaus	4091, 4098, 4136,
BT	4138		4133, 4136, 4137	Kamm	4139		4137, 4139
Bubu Sat	4139	Eurostar	4089, 4133, 4137	Kathrein	4093, 4101, 4103,	Neusat	4139
Bush	4084, 4127	Eutelsat	4139		4109, 4112, 4120,	Next Level	4065
Bush	4136	Exator	4083, 4086		4133, 4138, 4139	NextWave	4141
Cambridge	4136	Expressvu	4039	Kathrein Eurostar	4133	Nikko	4089, 4139
Canal Satellite	4135	Fenner	4074, 4134, 4139	Klap	4138	Nokia	4084, 4122
Canal+	4135	Ferguson	4084, 4102, 4132	Konig	4137	Nordmende	4083, 4084, 4085,
CaptiveWorks	4049	Fidelity	4136	Kosmos	4099		4088, 4102
Channel Master	4060, 4085	Finlandia	4084	KR	4086	Nova	4140
Chaparral	4025	Finlux	4084	Kreiselmeyer	4093	Novis	4095
CHEROKEE	4138	FinnSat	4096, 4102	K-SAT	4139	Oceanic	4097
Chess	4134, 4139	Flair Mate	4139	Kyostar	4083	Octagon	4083, 4086, 4096
CityCom	4084, 4133, 4137	Foxtel	4140	L&S Electronic	4074	Okano	4089
Clatronic	4095	Freecom	4083, 4099, 4136			Optex	4098
CNT	4088	FTEmaximal	4074, 4139			Optus	4135, 4140, 4141
Comag	4000, 4001, 4002,						
	4003, 4004						
Commlink	4087						
Comtech	4096						

Orbitech	4083, 4134, 4135, 4136	Satcom	4094, 4137	Tivax	4058
OSat	4086	Satec	4139	Tivo	4150
Otto Versand	4093	Satelco	4074	Tokai	4103
Pace	4084, 4093, 4113, 4121, 4125, 4138	Satford	4094	Tonna	4084, 4094, 4098, 4136, 4139
Pacific	4097	Satmaster	4094	Toshiba	4144, 4152, 4153
Packsat	4138	Satplus	4134	Triad	4099
Palcom	4085	Schneider	4090, 4134, 4138	Triasat	4136
Palladium	4089, 4136	Schwaiger	4097, 4134, 4137	Triax	4093, 4133, 4136, 4139
Palsat	4134, 4136	SCS	4133	Turnsat	4139
Panasat	4140	Seemann	4089, 4091, 4092	Tvonics	4132
Panasonic	4043, 4044, 4046, 4084, 4113, 4118, 4143, 4148	SEG	4074, 4083, 4090, 4095	Twiner	4077, 4139
Panda	4084, 4137	Seleco	4098	UEC	4140
Pansat	4047	Servi Sat	4077, 4139	Uher	4134
Patriot	4138	Siemens	4093	UltimateTV	4020
Paysat	4045	Silva	4099	Uniden	4029, 4045
PCT	4060	Skantin	4139	Unisat	4089, 4096, 4103
Philco	4055	Skardin	4091	Unitor	4095
Philips	4021, 4022, 4045, 4084, 4101, 4103, 4111, 4115, 4135, 4138, 4150, 4152, 4153, 4155, 4156	Skinsat	4136	Universum	4093, 4133, 4137
Phoenix	4096	SKR	4139	US Digital	4066
Phonotrend	4084, 4087, 4098	Skymaster	4067, 4068, 4087, 4134, 4139	Variosat	4093
Pioneer	4124, 4135	Skymax	4101, 4103	Vega	4074
Polsat	4102	SkySat	4134, 4136, 4137, 4139	Ventana	4101, 4103
Predki	4095	Skyvision	4098	Viewsat	4048
Premiere	4098, 4135	SM Electronic	4134, 4139	Visiosat	4095, 4098, 4138, 4139
Priesner	4089	Smart	4133, 4139	Voom	4065
Primestar	4030	Sony	4017, 4020, 4135	Vortec	4083
Profile	4138	SR	4089, 4100	Welltech	4134
Promax	4084	Star Choice	4065	WeTeKom	4134, 4136
Prosat	4085, 4087	Starland	4139	Wevasat	4084
Proscan	4015, 4016, 4040, 4151	Starring	4095	Wewa	4084
Protek	4097	Start Trak	4083	Winersat	4095
Proton	4066	Strong	4074, 4083, 4086, 4090, 4099, 4140	Wisi	4084, 4092, 4093, 4136, 4137
Provision	4088	STS	4033	Woorisat	4088
Quadral	4074, 4085, 4087, 4090, 4138	STVI	4077	Worldsat	4138
Quelle	4093, 4133, 4137	Sumida	4089	Xrypton	4074
Quiero	4102	Sunny Sound	4074	XSat	4139
RadioShack	4065	Sunsat	4139	Zehnder	4074, 4088, 4090, 4131, 4133
Radiola	4101, 4103	Sunstar	4074, 4089, 4100	Zenith	4052, 4057, 4145
Radix	4092, 4119	Supermax	4141	Zodiac	4086
Rainbow	4086	Tandberg	4102		
RCA	4015, 4016, 4034, 4035, 4036, 4037, 4038, 4040, 4151, 4157	Tandy	4086		
Realistic	4028	Tantec	4084		
Redpoint	4091	TCM	4090		
Redstar	4074, 4090	Techniland	4094		
RFT	4087, 4101, 4103	TechniSat	4071, 4072, 4073, 4092, 4103, 4116, 4117, 4134, 4135, 4136		
Roadstar	4139	Technology	4140		
Roch	4077	Technosat	4141		
Rover	4074, 4139	Technowelt	4137		
Saba	4088, 4133, 4137, 4138	Teco	4089, 4100		
Sabre	4084	Telanor	4085		
Sagem	4069, 4102	Telasat	4133, 4137		
Sakura	4096	Telecom	4139		
Samsung	4018, 4021, 4023, 4041, 4042, 4081, 4082, 4083, 4114, 4150, 4154	Telefunken	4067, 4083, 4138		
SAT	4085, 4136	Teleka	4086, 4089, 4092, 4136, 4137		
Sat Cruiser	4141	Telemaster	4088		
Sat Partner	4083, 4086, 4088, 4095, 4099, 4136	Telesat	4137		
Sat Team	4139	Telestar	4134, 4135, 4136		
		Televess	4084, 4136		
		Telewire	4098		
		Tempo	4141		
		Tevion	4090, 4139		
		Thomson	4070, 4084, 4102, 4104, 4130, 4133, 4135, 4137, 4138, 4139		
		Thorens	4097		
		Thorn	4084		

CD

Yamaha 5000, 5013

CD Recoder

Yamaha 5001

MD

Yamaha 5002, 5003, 5004

Tape

Yamaha 5005, 5006

Tuner

Yamaha 5007, 5008, 5009,
5010, 5014, 5015,
5016, 5017, 5018

USB

Yamaha 5012, 5021

DOCK

Yamaha 5011, 5022

LD

Yamaha 2002



The letters in circles and the numbers in squares correspond to those in the Owner's Manual.

■ Front panel

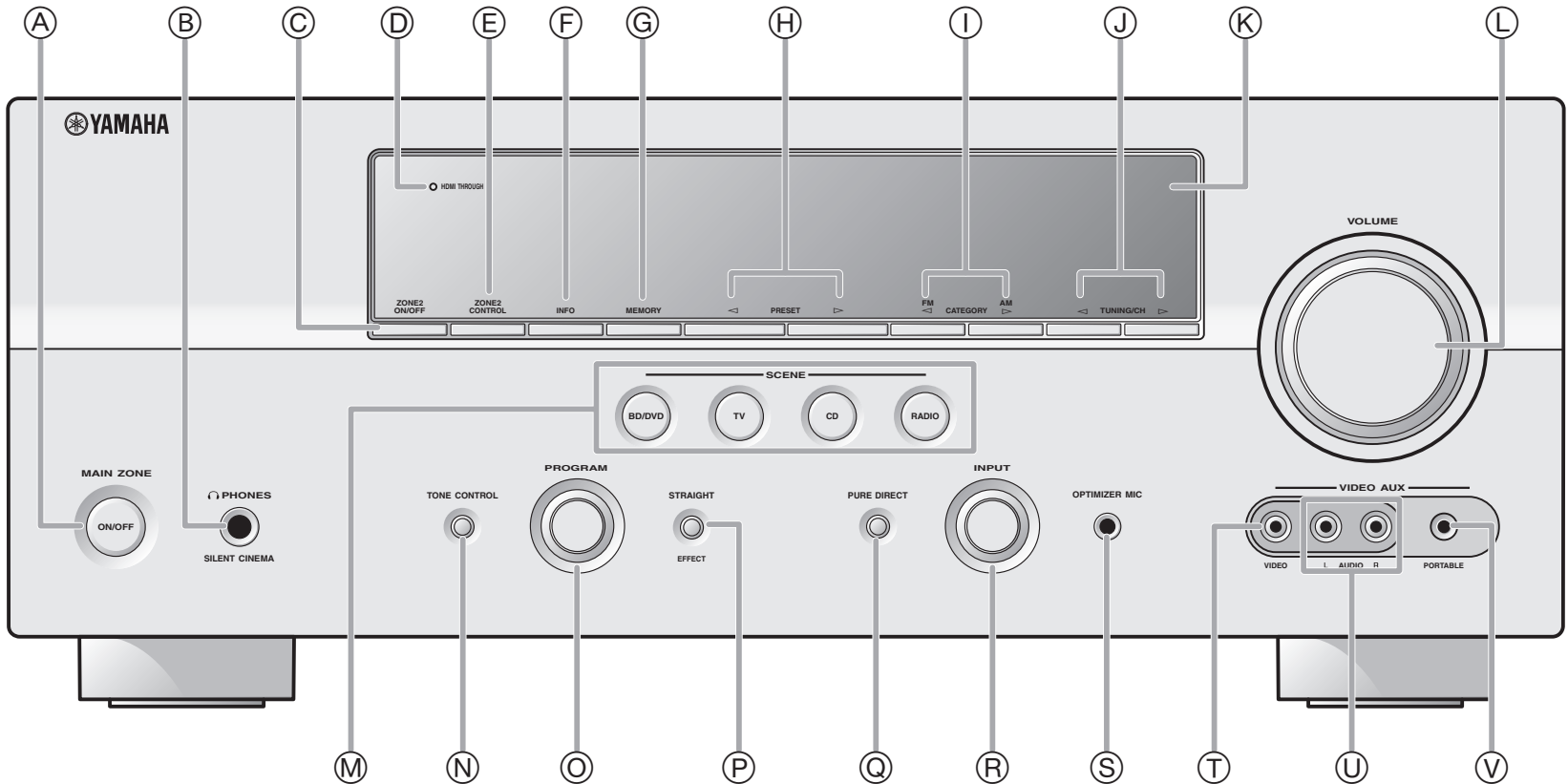

■ Remote control

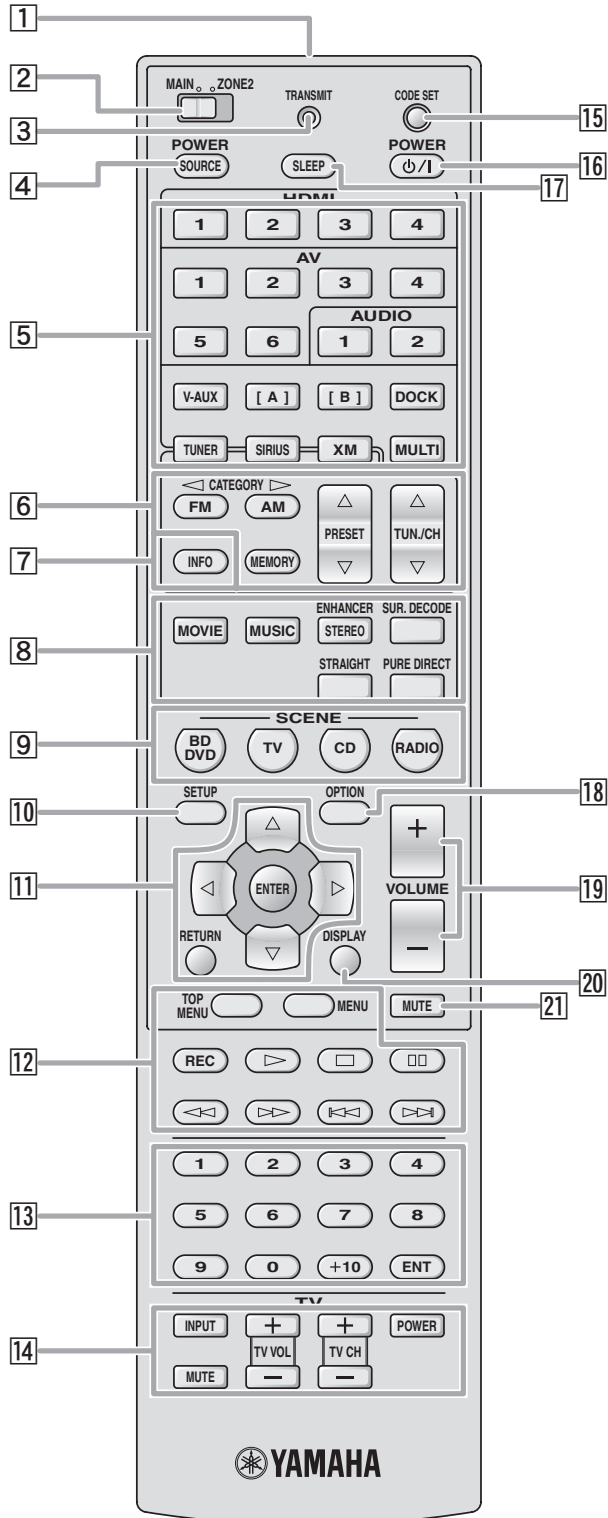

Free Manuals Download Website

<http://myh66.com>

<http://usermanuals.us>

<http://www.somanuals.com>

<http://www.4manuals.cc>

<http://www.manual-lib.com>

<http://www.404manual.com>

<http://www.luxmanual.com>

<http://aubethermostatmanual.com>

Golf course search by state

<http://golfingnear.com>

Email search by domain

<http://emailbydomain.com>

Auto manuals search

<http://auto.somanuals.com>

TV manuals search

<http://tv.somanuals.com>