

**Pioneer** *sound.vision.soul*

**AUDIO/VIDEO MULTI-CHANNEL  
RECEIVER**

**VSX-80TXV**

**VSX-80TXV-S**

**ELITE**

Register your product at

[www.pioneerelectronics.com](http://www.pioneerelectronics.com) (US)

[www.pioneerelectronics.ca](http://www.pioneerelectronics.ca) (Canada)

• **Protect your new investment**

The details of your purchase will be on file for reference in the event of an insurance claim such as loss or theft.

• **Receive free tips, updates and service bulletins on your new product**

• **Improve product development**

Your input helps us continue to design products that meet your needs.

• **Receive a free Pioneer newsletter**

Registered customers can opt in to receive a monthly newsletter.

Operating Instructions

**CAUTION** – TO PREVENT ELECTRIC SHOCK, DO NOT USE THIS (POLARIZED) PLUG WITH AN EXTENSION CORD, RECEPTACLE OR OTHER OUTLET UNLESS THE BLADES CAN BE FULLY INSERTED TO PREVENT BLADE EXPOSURE.

**ATTENTION** – POUR PREVENIR LES CHOCS ELECTRIQUES, NE PAS UTILISER CETTE FICHE POLARISEE AVEC UN PROLONGATEUR, UNE PRISE DE COURANT, OU UNE AUTRE SORTIE DE COURANT, SAUF SI LES LAMES PEUVENT ETRE INSEREES A FOND SANS EN LAISSER AUCUNE PARTIE A DECOUVERT.

D2-4-4-1\_EF

**WARNING** – TO PREVENT FIRE OR SHOCK HAZARD, DO NOT EXPOSE THIS APPLIANCE TO RAIN OR MOISTURE.

D1-4-2-1\_En

#### FEDERAL COMMUNICATIONS DECLARATION OF CONFORMITY

This device complies with part 15 of the FCC Rules. Operation is subject to the following two conditions: (1) This device may not cause harmful interference, and (2) this device must accept any interference received, including interference that may cause undesired operation.

Product Name: AUDIO/VIDEO MULTI-CHANNEL RECEIVER  
Model Number: VSX-80TXV, VSX-80TXV-S  
Responsible Party Name: PIONEER ELECTRONICS SERVICE INC.  
Address: 1925 E. DOMINGUEZ ST. LONG BEACH, CA 90801-1760, USA  
Phone: 310-952-2915

**IMPORTANT NOTICE** – THE SERIAL NUMBER FOR THIS EQUIPMENT IS LOCATED IN THE REAR. PLEASE WRITE THIS SERIAL NUMBER ON YOUR ENCLOSED WARRANTY CARD AND KEEP IN A SECURE AREA. THIS IS FOR YOUR SECURITY.

D1-4-2-6-1\_En

**NOTE:** This equipment has been tested and found to comply with the limits for a Class B digital device, pursuant to Part 15 of the FCC Rules. These limits are designed to provide reasonable protection against harmful interference in a residential installation. This equipment generates, uses, and can radiate radio frequency energy and, if not installed and used in accordance with the instructions, may cause harmful interference to radio communications. However, there is no guarantee that interference will not occur in a particular installation. If this equipment does cause harmful interference to radio or television reception, which can be determined by turning the equipment off and on, the user is encouraged to try to correct the interference by one or more of the following measures:

- Reorient or relocate the receiving antenna.
- Increase the separation between the equipment and receiver.
- Connect the equipment into an outlet on a circuit different from that to which the receiver is connected.
- Consult the dealer or an experienced radio/TV technician for help.

D8-10-1-2\_En

This Class B digital apparatus complies with Canadian ICES-003.

Cet appareil numérique de la Classe B est conforme à la norme NMB-003 du Canada.

D8-10-1-3\_EF

#### Information to User

Alteration or modifications carried out without appropriate authorization may invalidate the user's right to operate the equipment.

D8-10-2\_En

**CAUTION:** This product satisfies FCC regulations when shielded cables and connectors are used to connect the unit to other equipment. To prevent electromagnetic interference with electric appliances such as radios and televisions, use shielded cables and connectors for connections.

D8-10-3a\_En

**WARNING:** Handling the cord on this product or cords associated with accessories sold with the product will expose you to chemicals listed on proposition 65 known to the State of California and other governmental entities to cause cancer and birth defect or other reproductive harm.

**Wash hands after handling**

D36-P4\_A\_En

For U.S. and Australia Model



C67-7-3\_En



The lightning flash with arrowhead, within an equilateral triangle, is intended to alert the user to the presence of uninsulated "dangerous voltage" within the product's enclosure that may be of sufficient magnitude to constitute a risk of electric shock to persons.

**CAUTION**  
RISK OF ELECTRIC SHOCK  
DO NOT OPEN



The exclamation point within an equilateral triangle is intended to alert the user to the presence of important operating and maintenance (servicing) instructions in the literature accompanying the appliance.

D1-4-2-3\_En

# IMPORTANT SAFETY INSTRUCTIONS

**READ INSTRUCTIONS** — All the safety and operating instructions should be read before the product is operated.

**RETAIN INSTRUCTIONS** — The safety and operating instructions should be retained for future reference.

**HEED WARNINGS** — All warnings on the product and in the operating instructions should be adhered to.

**FOLLOW INSTRUCTIONS** — All operating and use instructions should be followed.

**CLEANING** — The product should be cleaned only with a polishing cloth or a soft dry cloth. Never clean with furniture wax, benzene, insecticides or other volatile liquids since they may corrode the cabinet.

**ATTACHMENTS** — Do not use attachments not recommended by the product manufacturer as they may cause hazards.

**WATER AND MOISTURE** — Do not use this product near water — for example, near a bathtub, wash bowl, kitchen sink, or laundry tub; in a wet basement; or near a swimming pool; and the like.

**ACCESSORIES** — Do not place this product on an unstable cart, stand, tripod, bracket, or table. The product may fall, causing serious injury to a child or adult, and serious damage to the product. Use only with a cart, stand, tripod, bracket, or table recommended by the manufacturer, or sold with the product. Any mounting of the product should follow the manufacturer's instructions, and should use a mounting accessory recommended by the manufacturer.

**CART** — A product and cart combination should be moved with care. Quick stops, excessive force, and uneven surfaces may cause the product and cart combination to overturn.



**VENTILATION** — Slots and openings in the cabinet are provided for ventilation and to ensure reliable operation of the product and to protect it from overheating, and these openings must not be blocked or covered. The openings should never be blocked by placing the product on a bed, sofa, rug, or other similar surface. This product should not be placed in a built-in installation such as a bookcase or rack unless proper ventilation is provided or the manufacturer's instructions have been adhered to.

**POWER SOURCES** — This product should be operated only from the type of power source indicated on the marking label. If you are not sure of the type of power supply to your home, consult your product dealer or local power company.

**LOCATION** — The appliance should be installed in a stable location.

**NONUSE PERIODS** — The power cord of the appliance should be unplugged from the outlet when left un-used for a long period of time.

## GROUNDING OR POLARIZATION

- If this product is equipped with a polarized alternating current line plug (a plug having one blade wider than the other), it will fit into the outlet only one way. This is a safety feature. If you are unable to insert the plug fully into the outlet, try reversing the plug. If the plug should still fail to fit, contact your electrician to replace your obsolete outlet. Do not defeat the safety purpose of the polarized plug.

- If this product is equipped with a three-wire grounding type plug, a plug having a third (grounding) pin, it will only fit into a grounding type power outlet. This is a safety feature. If you are unable to insert the plug into the outlet, contact your electrician to replace your obsolete outlet. Do not defeat the safety purpose of the grounding type plug.

**POWER-CORD PROTECTION** — Power-supply cords should be routed so that they are not likely to be walked on or pinched by items placed upon or against them, paying particular attention to cords at plugs, convenience receptacles, and the point where they exit from the product.

**OUTDOOR ANTENNA GROUNDING** — If an outside antenna or cable system is connected to the product, be sure the antenna or cable system is grounded so as to provide some protection against voltage surges and built-up static charges. Article 810 of the National Electrical Code, ANSI/NFPA 70, provides information with regard to proper grounding of the mast and supporting structure, grounding of the lead-in wire to an antenna discharge unit, size of grounding conductors, location of antenna-discharge unit, connection to grounding electrodes, and requirements for the grounding electrode. See Figure A.

**LIGHTNING** — For added protection for this product during a lightning storm, or when it is left unattended and unused for long periods of time, unplug it from the wall outlet and disconnect the antenna or cable system. This will prevent damage to the product due to lightning and power-line surges.

**POWER LINES** — An outside antenna system should not be located in the vicinity of overhead power lines or other electric light or power circuits, or where it can fall into such power lines or circuits. When installing an outside antenna system, extreme care should be taken to keep from touching such power lines or circuits as contact with them might be fatal.

**OVERLOADING** — Do not overload wall outlets, extension cords, or integral convenience receptacles as this can result in a risk of fire or electric shock.

**OBJECT AND LIQUID ENTRY** — Never push objects of any kind into this product through openings as they may touch dangerous voltage points or short-out parts that could result in a fire or electric shock. Never spill liquid of any kind on the product.

**SERVICING** — Do not attempt to service this product yourself as opening or removing covers may expose you to dangerous voltage or other hazards. Refer all servicing to qualified service personnel.

**DAMAGE REQUIRING SERVICE** — Unplug this product from the wall outlet and refer servicing to qualified service personnel under the following conditions:

- When the power-supply cord or plug is damaged.
  - If liquid has been spilled, or objects have fallen into the product.
  - If the product has been exposed to rain or water.
  - If the product does not operate normally by following the operating instructions. Adjust only those controls that are covered by the operating instructions as an improper adjustment of other controls may result in damage and will often require extensive work by a qualified technician to restore the product to its normal operation.
  - If the product has been dropped or damaged in any way.
  - When the product exhibits a distinct change in performance — this indicates a need for service.
- REPLACEMENT PARTS** — When replacement parts are required, be sure the service technician has used replacement parts specified by the manufacturer or have the same characteristics as the original part. Unauthorized substitutions may result in fire, electric shock, or other hazards.

**SAFETY CHECK** — Upon completion of any service or repairs to this product, ask the service technician to perform safety checks to determine that the product is in proper operating condition.

**WALL OR CEILING MOUNTING** — The product should not be mounted to a wall or ceiling.

**HEAT** — The product should be situated away from heat sources such as radiators, heat registers, stoves, or other products (including amplifiers) that produce heat.

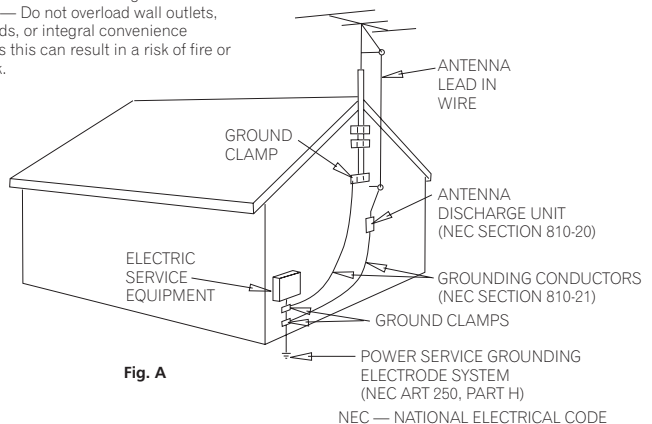

Fig. A

D1-4-2-2\_En

Thank you for buying this Pioneer product. Please read through these operating instructions so you will know how to operate your model properly. After you have finished reading the instructions, put them away in a safe place for future reference.

# Contents

## 01 Before you start

Features	6
Checking what's in the box	6
Ventilation	7
Installing the receiver	7
Loading the batteries	7

## 02 5 minute guide

Introduction to home theater	8
Listening to Surround Sound	8
Automatically setting up for surround sound (MCACC)	8
Problems when using the Auto MCACC Setup	10
Playing a source	10
Better sound using Basic Phase Control	10

## 03 Connecting your equipment

Rear panel	11
When making cable connections	12
About the video converter	12
Connecting your TV and DVD player	13
Connecting a satellite/cable receiver or other set-top box	13
Connecting a DVD/HDD recorder, VCR and other video sources	14
Using the component video jacks	14
Connecting digital audio sources	15
About the WMA9 Pro decoder	16
Connecting analog audio sources	16
Connecting a component to the front panel inputs	16
Installing your speaker system	17
Connecting the speakers	17
Placing the speakers	18
THX speaker system setup	19
Connecting antennas	19
Connecting external antennas	20
Plugging in the receiver	20
AC outlet	20

## 04 Controls and displays

Front panel	21
Operating range of remote control unit	22
Display	23
Remote control	24

## 05 Listening to your system

Auto playback	26
Listening in surround sound	26
Standard surround sound	26
Using the Home THX modes	27
Using the Advanced surround effects	27
Setting the effect options	27
Listening in stereo	28
Listening with Acoustic Calibration EQ	28
Choosing the input signal	29
Using surround back channel processing	29
Using the Virtual Surround Back mode	29
Using Midnight and Loudness	30
Using the Sound Retriever	30
Enhancing dialog	30
Using the tone controls	30

## 06 Using the tuner

Listening to the radio	31
Improving FM stereo sound	31
Tuning directly to a station	31
Saving station presets	31
Naming station presets	32
Listening to station presets	32

## 07 The System Setup menu

Making receiver settings from the System Setup menu	33
Surround back speaker setting	33
Manual MCACC setup	34
Fine Channel Level	34
Fine Speaker Distance	35
Acoustic Calibration EQ	35
Manual speaker setup	37
Speaker Setting	37
Crossover Network	38
Channel Level	38
Speaker Distance	39
THX Audio Setting	39
THX Speaker Setup	40

## 08 Other connections

Using XM Radio . . . . .	41
Connecting your XM Radio receiver . . . . .	41
Listening to XM Radio . . . . .	41
Using XM HD Surround . . . . .	42
Saving channel presets . . . . .	42
Connecting using HDMI . . . . .	42
About HDMI . . . . .	43
Connecting the multichannel analog inputs . . . . .	43
Selecting the multichannel analog inputs . . . . .	43
Second Zone speaker B setup . . . . .	44
Switching the speaker system . . . . .	44
Bi-amping your front speakers . . . . .	44
Bi-wiring your speakers . . . . .	45
Connecting additional amplifiers . . . . .	45
Multi-room listening . . . . .	46
Making multi-room connections . . . . .	46
Using the multi-room controls . . . . .	46
Connecting an IR receiver . . . . .	47
Switching components on and off using the 12 volt trigger . . . . .	48
Using this receiver with a Pioneer plasma display . . . . .	48
Using the SR+ mode with a Pioneer plasma display . . . . .	49

## 09 Other Settings

The Input Assign menu . . . . .	50
The Other Setup menu . . . . .	51
Dynamic Range Control Setup . . . . .	51
Dual Mono Setup . . . . .	52
LFE Attenuator Setup . . . . .	52
SR+ Setup for Pioneer plasma displays . . . . .	52
Video Converter Setup . . . . .	52
Multi-Room and IR receiver setup . . . . .	53
12 Volt Trigger setup . . . . .	53

## 10 Using other functions

Making an audio or a video recording . . . . .	54
Reducing the level of an analog signal . . . . .	54
Watching video and audio sources independently . . . . .	54
Using the sleep timer . . . . .	55
Dimming the display . . . . .	55
Switching the speaker impedance . . . . .	55
Resetting the system . . . . .	55

## 11 Controlling the rest of your system

Setting the remote to control other components . . . . .	56
Selecting preset codes directly . . . . .	56
Programming signals from other remote controls . . . . .	56
Erasing one of the remote control button settings . . . . .	57
Resetting the remote control presets . . . . .	57
Confirming preset codes . . . . .	57
Renaming input source names . . . . .	58

Direct function . . . . .	58
Multi Operation and System Off . . . . .	58
Programming a multi-operation or a shutdown sequence . . . . .	58
Using multi operations . . . . .	59
Using System off . . . . .	59
Controls for TVs . . . . .	60
Controls for other components . . . . .	60
Operating other Pioneer components with this unit's sensor . . . . .	61

## 12 Additional information

Troubleshooting . . . . .	62
Power . . . . .	62
No sound . . . . .	62
Other audio problems . . . . .	63
Video . . . . .	64
Settings . . . . .	64
Display . . . . .	65
Remote control . . . . .	65
HDMI . . . . .	66
XM radio messages . . . . .	66
Surround sound formats . . . . .	67
Dolby . . . . .	67
DTS . . . . .	67
Windows Media® Audio 9 Professional . . . . .	67
About THX . . . . .	68
Listening modes with different input signal formats . . . . .	69
Specifications . . . . .	71
Cleaning the unit . . . . .	71

This product is for general household purposes. Any failure due to use for other than household purposes (such as long-term use for business purposes in a restaurant or use in a car or ship) and which requires repair will be charged for even during the warranty period.

K041\_En

## Chapter 1: Before you start

### Features

- **Advanced Direct Energy design**

This receiver offers a new advancement in discrete design unique to Pioneer for high-power drivability, low distortion and stable imaging. Through symmetrical placement of power amplification units, this receiver generates equal amplifier power to all channels, eliminating the possibility of one channel dominating a particular sound field.

- **Easy setup using Multichannel Acoustic Calibration (MCACC)**

Setting up for home theater sound is as easy as connecting your speakers, a DVD player or other source, and your TV. The Auto Surround Setup provides a quick but accurate surround sound setup, while for complete surround sound control you still have access to the full range of surround sound settings.

- **THX Select2 certified design**

This receiver bears the THX Select2 logo, which means it has passed a rigorous series of quality and performance tests covering every aspect of the product. This includes testing of pre-amplifier and power amplifier performance and operation, and hundreds of other parameters in both the digital and analog domain, making your home theater experience as faithful as possible to what the director intended.

- **Dolby Digital and DTS decoding, including Dolby Digital EX, Dolby Pro Logic IIx, DTS 96/24 and DTS-ES**

Dolby Digital and DTS decoding brings theater sound right into your home with up to six channels of surround sound, including a special LFE (Low Frequency Effects) channel for deep, realistic sound effects.

The built-in Dolby Pro Logic IIx and DTS Neo:6 decoders not only provide full surround sound decoding for Dolby Surround sources, but will also generate convincing surround sound for any stereo source.

Also, with the addition of a surround back speaker, you can take advantage of the built-in Dolby Digital EX and DTS-ES decoders for six-channel surround sound.

- **Phase correction**

Based on Pioneer's unique Phase Control Technology, the Basic Phase Control feature incorporated into this receiver's design provides coherent sound reproduction through the use of phase matching for an optimal sound image at your listening position.

- **Sound Retriever**

The Sound Retriever feature employs new DSP technology that helps bring CD quality sound back to WMA, MP3 and MPEG-4 AAC audio files by restoring sound pressure and smoothing jagged artifacts left over after compression.

- **HDMI compatibility**

This receiver is compatible with the HDMI digital video format, providing you high-definition digital video and digital audio via a single cable.

- **Built-in video converter**

The built-in video converter provides output of all analog video signals to your TV or monitor (regardless of the type of connection), allowing you to connect components using component, S-video, and composite video connections as you like.

- **XM Ready**

With the new XM Radio terminal, you'll be up and running in no time, now that this receiver's enhanced compatibility makes XM HD Surround playback and on-screen control of XM Radio an added possibility.

- **Easy-to-use LCD remote control**

The remote control gives you not only complete control over every function of this receiver, but also over the main functions for other components in your home theater system. Using a system of preset codes, you can program the remote to operate a wide range of other equipment.

### Checking what's in the box

Please check that you've received the following supplied accessories:

- Setup microphone (cable: 16.4 ft.)
- Remote control unit
- AA/IEC R6P dry cell batteries x2
- AM loop antenna
- FM wire antenna
- Warranty card
- These operating instructions

## Ventilation

When installing this unit, make sure to leave space around the unit for ventilation to improve heat dispersal (at least 8 in. (20 cm) at the top). If not enough space is provided between the unit and walls or other equipment, heat will build up inside, interfering with performance and/or causing malfunctions.

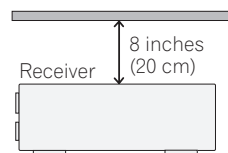

Slot and openings in the cabinet are provided for ventilation and to protect the equipment from overheating. To prevent fire hazard, do not place anything directly on top of the unit, make sure the openings are never blocked or covered with items (such as newspapers, table-cloths and curtains), and do not operate the equipment on thick carpet or a bed.

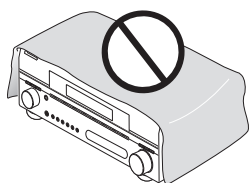

## Installing the receiver

- When installing this unit, make sure to put it on a level and stable surface.

Don't install it on the following places:

- on a color TV (the screen may distort)
- near a cassette deck (or close to a device that gives off a magnetic field). This may interfere with the sound.
- in direct sunlight
- in damp or wet areas
- in extremely hot or cold areas
- in places where there is vibration or other movement
- in places that are very dusty
- in places that have hot fumes or oils (such as a kitchen)

## Loading the batteries

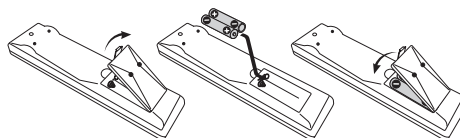

### Caution

Incorrect use of batteries may result in such hazards as leakage and bursting. Observe the following precautions:

- Never use new and old batteries together.
- Insert the plus and minus sides of the batteries properly according to the marks in the battery case.
- Batteries with the same shape may have different voltages. Do not use different batteries together.
- When disposing of used batteries, please comply with governmental regulations or environmental public instruction's rules that apply in your country or area.
- Do not use or store batteries in direct sunlight or other excessively hot place, such as inside a car or near a heater. This can cause batteries to leak, overheat, explode or catch fire. It can also reduce the life or performance of batteries.

## Chapter 2: 5 minute guide

### Introduction to home theater

Home theater refers to the use of multiple audio tracks to create a surround sound effect, making you feel like you're in the middle of the action or concert. The surround sound you get from a home theater system depends not only on your speaker setup, but also on the source and the sound settings of the receiver.

This receiver will automatically decode multichannel Dolby Digital, DTS, or Dolby Surround sources according to your speaker setup. In most cases, you won't have to make changes for realistic surround sound, but other possibilities (like listening to a CD with multichannel surround sound) are explained in *Listening to your system* on page 26.

### Listening to Surround Sound

This receiver was designed with the easiest possible setup in mind, so with the following quick setup guide, you should have your system hooked up for surround sound in no time at all. In most cases, you can simply leave the receiver in the default settings.

- Be sure to complete all connections before connecting this unit to an AC power source.

#### 1 Connect your TV and DVD player.

See *Connecting your TV and DVD player* on page 13 to do this. For surround sound, you'll want to hook up using a digital connection from the DVD player to the receiver.

#### 2 Connect your speakers and place them for optimal surround sound.

Connect your speakers as shown in *Installing your speaker system* on page 17.

Where you place the speakers will have a big effect on the sound. Place your speakers as shown below for the best surround sound effect. Also see *Placing the speakers* on page 18 for more on this.

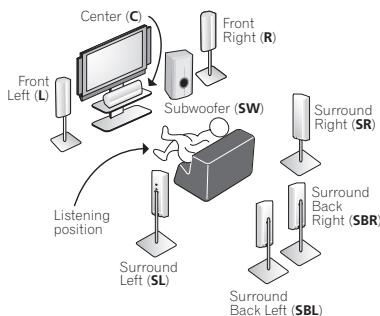

#### 3 Plug in the receiver and switch it on, followed by your DVD player, your subwoofer and the TV.

Make sure you've set the video input on your TV to this receiver. Check the manual that came with the TV if you don't know how to do this.

- Set the subwoofer volume to a comfortable level.

#### 4 Use the on-screen automatic MCACC setup to set up your system.

See *Automatically setting up for surround sound (MCACC)* below for more on this.

#### 5 Play a DVD, and adjust the volume to your liking.

Make sure that **DVD/LD** is showing in the receiver's display, indicating that the DVD input is selected. If it isn't, press **DVD** on the remote control to set the receiver to the DVD input.

In addition to the basic playback explained in *Playing a source* on page 10, there are several other sound options you can select. See *Listening to your system* on page 26 for more on this.

See also *Making receiver settings from the System Setup menu* on page 33 for more setup options.

### Automatically setting up for surround sound (MCACC)

The Auto MCACC Setup measures the acoustic characteristics of your listening area, taking into account ambient noise, speaker size and distance, and tests for both channel delay and channel level. After you have set up the microphone provided with your system, the receiver uses the information from a series of test tones to optimize the speaker settings and equalization for your particular room.

Make sure you do this before moving on to *Playing a source* on page 10.

#### Important

- Make sure the microphone and speakers are not moved during the Auto MCACC Setup.
- Before using the Auto MCACC Setup the headphones should be disconnected.

#### Caution

- The test tones used in the Auto MCACC Setup are output at high volume.



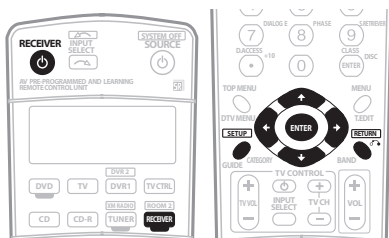

- 1 Switch on the receiver and your TV.
- 2 Connect the microphone to the MCACC SETUP MIC jack on the front panel.

Place the microphone so that it's about ear level at your normal listening position (use a tripod if possible). Make sure there are no obstacles between the speakers and the microphone.

- Push down on the **PUSH OPEN** tab to access the **MCACC SETUP MIC** jack:



- 3 Press **RECEIVER** on the remote, then press **SETUP**. An on-screen display (OSD) appears on your TV. Use the **↑/↓/←/→** buttons and **ENTER** to navigate through the screens and select menu items. Press **RETURN** to exit the current menu. Press **SETUP** at any time to cancel.<sup>1</sup>
- 4 Select 'Auto MCACC' from the System Setup menu then press **ENTER**.<sup>2</sup>

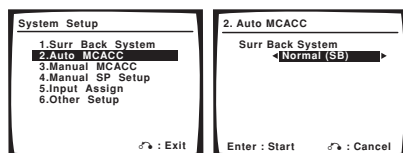

- 5 Make sure 'Normal (SB)' is selected then press **ENTER**.<sup>3</sup>
- 6 Follow the instructions on-screen. Make sure the microphone is connected, and if you're using a subwoofer, make sure it is switched on and set to a comfortable volume level.

- 7 Wait for the test tones to finish then confirm the speaker configuration in the OSD.

A progress report is displayed on-screen while the receiver outputs test tones to determine the speakers present in your setup. Try to be as quiet as possible while it's doing this.<sup>4</sup>

- With error messages (such as **Ambient Noise** or **Microphone Check**) select **RETRY** after checking for ambient noise (see *Problems when using the Auto MCACC Setup* below) and verifying the mic connection. If there doesn't seem to be a problem, you can simply select **OK** and continue.

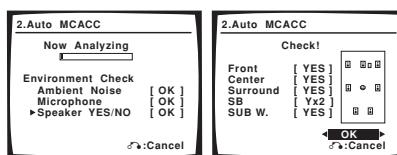

The configuration shown on-screen should reflect the actual speakers you have.<sup>5</sup>

If you see an error message (**ERR**) in the right side column (or the speaker configuration displayed isn't correct), there may be a problem with the speaker connection. If selecting **RETRY** doesn't work, turn off the power and check the speaker connections. If there doesn't seem to be a problem, you can simply use **↑/↓** to select the speaker and **←/→** to change the setting (and number for surround back) and continue.

- 8 Make sure 'OK' is selected, then press **ENTER**.

A progress report is displayed on-screen while the receiver outputs more test tones to determine the optimum receiver settings for channel level, speaker distance, and Acoustic Calibration EQ.

Again, try to be as quiet as possible while this is happening. It may take 3 to 8 minutes.

- 9 The Auto MCACC Setup has finished! Select '**SKIP**' to go back to the System Setup menu.

The settings made in the Auto MCACC Setup should give you excellent surround sound from your system, but it is also possible to adjust these settings manually using the System Setup menu (starting on page 33).<sup>6</sup>

#### Note

- 1 If you cancel the Auto MCACC Setup, or leave an error message for over three minutes, the screen saver will appear.
  - The OSD will not appear if you have connected using the HDMI output to your TV. Use component, S-video, or composite connections for system setup.
- 2 You can't use the System Setup menu when the XM Radio input source is selected (in either the main or sub room).
- 3 If you are planning on bi-amping your front speakers, or setting up a separate speaker system in another room, read through *Surround back speaker setting* on page 33 and make sure to connect your speakers as necessary before continuing to step 6.
  - If you have THX-certified speakers, make sure **YES** is selected in *THX Speaker Setup* on page 40.
- 4 Do not adjust the volume during the test tones. This may result in incorrect speaker settings.
- 5 If you're using the front panel display, the diagram in *Listening to Surround Sound* above indicates (in bold) how each speaker is displayed.
- 6 Depending on the characteristics of your room, sometimes identical speakers with cone sizes of around 5 inches will end up with different size settings. You can correct the setting manually using the *Manual speaker setup* on page 37.
  - The subwoofer distance setting may be farther than the actual distance from the listening position. This setting should be accurate (taking delay and room characteristics into account) and generally does not need to be changed.

## Problems when using the Auto MCACC Setup

If the room environment is not optimal for the Auto MCACC Setup (too much background noise, echo off the walls, obstacles blocking the speakers from the microphone) the final settings may be incorrect. Check for household appliances (air conditioner, fridge, fan, etc.), that may be affecting the environment and switch them off if necessary. If there are any instructions showing in the front panel display, please follow them.

- Some older TVs may interfere with the operation of the microphone. If this seems to be happening, switch off the TV when doing the Auto MCACC Setup.

## Playing a source

Here are the basic instructions for playing a source (such as a DVD disc) with your home theater system.

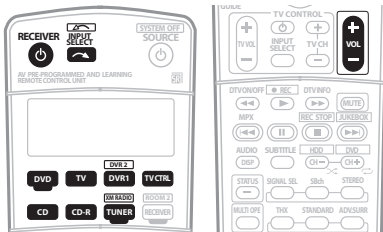

### 1 Switch on your system components and receiver.

Start by switching on the playback component (for example a DVD player), your TV<sup>1</sup> and subwoofer (if you have one), then the receiver (press **RECEIVER**).

- Make sure the setup mic is disconnected.

### 2 Select the input source you want to play.

You can use the input source buttons on the remote control, **INPUT SELECT**, or the front panel controls.<sup>2</sup>

### 3 Press **AUTO SURR** to select 'AUTO SURROUND' and start playback of the source.<sup>3</sup>

If you're playing a Dolby Digital or DTS surround sound DVD disc, you should hear surround sound. If you are playing a stereo source, you will only hear sound from the front left/right speakers in the default listening mode.

- See also *Listening to your system* on page 26 for information on different ways of listening to sources.

### 4 Use the volume control to adjust the volume level.

Turn down the volume of your TV so that all sound is coming from the speakers connected to this receiver.

#### Note

<sup>1</sup> Make sure that the TV's video input is set to this receiver. (For example, if you connected this receiver to the **VIDEO 1** jacks on your TV, make sure that the **VIDEO 1** input is now selected.)

<sup>2</sup> If you need to manually switch the input signal type press **SIGNAL SEL** (page 29).

<sup>3</sup> • You may need to check the digital audio output settings on your DVD player or digital satellite receiver. It should be set to output Dolby Digital, DTS and 88.2 kHz / 96 kHz PCM (2 channel) audio, and if there is an MPEG audio option, set this to convert the MPEG audio to PCM.

• Depending on your DVD player or source discs, you may only get digital 2 channel stereo and analog sound. In this case, the receiver must be set to a multichannel listening mode (see *Listening in surround sound* on page 26 if you need to do this) if you want multichannel surround sound.

<sup>4</sup> Phase matching is a very important factor in achieving proper sound reproduction. If two waveforms are 'in phase', they crest and trough together, resulting in increased amplitude, clarity and presence of the sound signal. If a crest of a wave meets a trough (as shown in the upper section of the diagram above) then the sound will be 'out of phase' and an unreliable sound image will be produced.

## Better sound using Basic Phase Control

This receiver's Basic Phase Control feature uses phase correction measures to make sure your sound source arrives at the listening position in phase, preventing unwanted distortion and/or coloring of the sound (see illustration below).

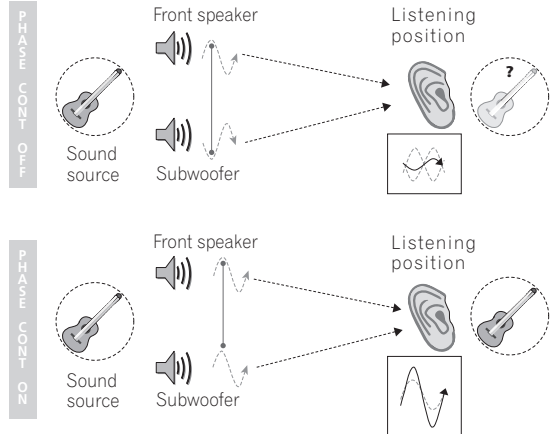

Phase Control technology provides coherent sound reproduction through the use of phase matching<sup>4</sup> for an optimal sound image at your listening position. The default setting is on and we recommend leaving Phase Control switched on for all sound sources.



- Press **RECEIVER** then **PHASE (PHASE CONTROL)** to switch on phase correction.

The **PHASE CONTROL** indicator on the front panel lights.

## Chapter 3

## Connecting your equipment

This receiver provides you with many connection possibilities, but it doesn't have to be difficult. This page explains the kinds of components you can connect to make up your home theater system.

## Rear panel

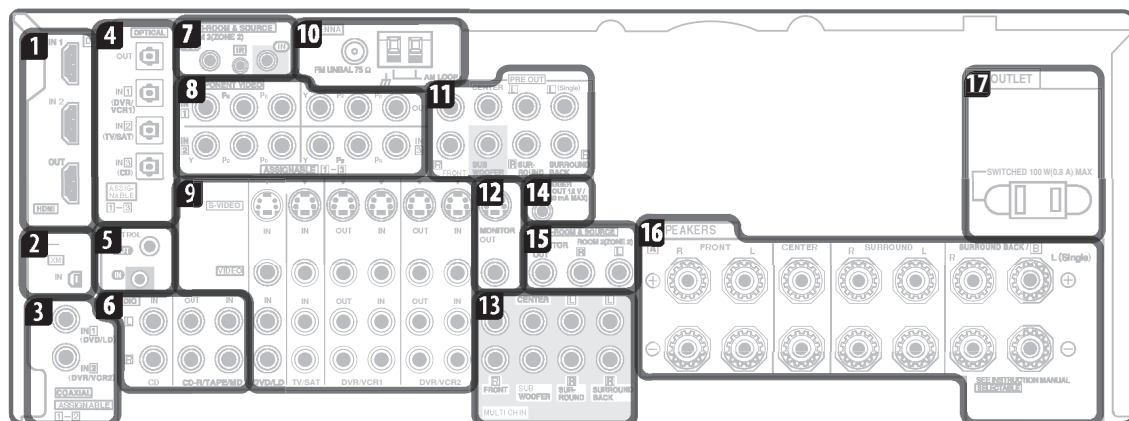
**Caution**

- Before making or changing the connections, switch off the power and disconnect the power cord from the power outlet. Plugging in should be the final step.

**1 HDMI connectors (x3)**

Two inputs and one output for high-quality audio/video connection to compatible HDMI devices.

→ *Connecting using HDMI* on page 42.

**2 XM Radio input**

→ *See Using XM Radio* on page 41.

**3 Coaxial digital audio inputs (x2)**

Use for digital audio sources, including DVD players/recorders, digital satellite receivers, CD players, etc.

→ *See also The Input Assign menu* on page 50 to assign the inputs.

**4 Optical digital audio output / input(s) (x4)**

Use the **OUT** jack for recording to a CD or MiniDisc recorder.

→ *Connecting digital audio sources* on page 15.

Use the **IN** jacks for digital audio sources, including DVD players/recorders, digital satellite receivers, CD players, etc.

→ *See also The Input Assign menu* on page 50 to assign the inputs.

**5 Control input/output**

Use to connect other Pioneer components so that you can control all your equipment from a single IR remote sensor.

→ *Operating other Pioneer components with this unit's sensor* on page 61.

**6 Stereo analog audio source inputs/(outputs) (x3)**

Use for connection to audio sources such as CD players, tape decks, turntables, etc.

→ *Connecting analog audio sources* on page 16.

**7 Remote input (multi-room and source)**

Use for connection to an external remote control sensor for use in a multi-room setup, for example.

→ *Connecting an IR receiver* on page 47.

**8 Component video connections (x4)**

Use the inputs to connect any video source that has component video output, such as a DVD recorder. Use the output for connection to a monitor or TV.

→ *Using the component video jacks* on page 14.

**9 Audio/video source inputs/(outputs) (x6)**

Use for connection to audio/visual sources, such as DVD players/recorders, VCRs, etc. Each set of inputs has jacks for composite video, S-video and stereo analog audio.

→ *Connecting a DVD/HDD recorder, VCR and other video sources* on page 14.

**10 AM and FM antenna terminals**

Use to connect indoor or outdoor antennas for radio broadcasts.

→ *Connecting antennas* on page 19.

**11 Multichannel pre-amplifier outputs**

Use to connect separate amplifiers for front, center, surround, surround back and subwoofer channels.

→ *Connecting additional amplifiers* on page 45 (see also *Installing your speaker system* on page 17 for powered subwoofer connection).

**12 Composite and S-video monitor outputs**

Use to connect monitors and TVs.

→ *Connecting your TV and DVD player* on page 13.

**13 Multichannel analog audio inputs**

7.1 channel inputs for connection to a DVD player with multichannel analog outputs.

→ *Connecting the multichannel analog inputs* on page 43.

**14 12V trigger jack (total 50 mA max.)**

Use to switch components in your system on and off according to the input function of the receiver.

→ *Switching components on and off using the 12 volt trigger* on page 48.

**15 Multi-room and source outputs**

Use to connect a second amplifier in a separate room.

→ *Multi-room listening* on page 46.

**16 Speaker terminals**

Use for connection to the main front, center, surround and surround back speakers.

→ *Installing your speaker system* on page 17.

**17 Switched AC power outlet (100 W/0.8 A max.)**

Use to power another component in the system. Power to the outlet switches on and off with the receiver.

→ *AC outlet* on page 20.

- When connecting optical cables, be careful when inserting the plug not to damage the shutter protecting the optical socket.

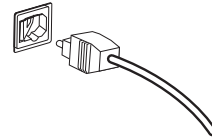

- When storing optical cable, coil loosely. The cable may be damaged if bent around sharp corners.

**About the video converter**

When the video converter is enabled, all analog video sources are output through all of the **MONITOR VIDEO OUT** jacks (HDMI and high-definition progressive component video cannot be converted).<sup>1</sup> See *Video Converter Setup* on page 52 to switch the video converter on or off.

If several video components are assigned to the same input function (see *The Input Assign menu* on page 50), the converter gives priority to component, S-video, then composite (in that order).

- For optimal video performance, THX recommends switching video conversion (in *Video Converter Setup* on page 52) **OFF**.

*This product incorporates copyright protection technology that is protected by U.S. patents and other intellectual property rights. Use of this copyright protection technology must be authorized by Macrovision Corporation, and is intended for home and other limited consumer uses only unless otherwise authorized by Macrovision. Reverse engineering or disassembly is prohibited.*

**When making cable connections**

- To avoid hum, do not lay connected cables over the top of the receiver.

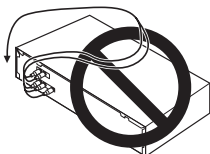
**Note**

<sup>1</sup> You must connect your monitor/TV to the receiver's HDMI/component video outputs when connecting these video sources. If the video signal does not appear on your TV or plasma display, try adjusting the resolution settings on your component or display. Note that some components (such as video game units) have resolutions that may not be converted. In this case, use an (analog) S-video or composite connection.

## Connecting your TV and DVD player

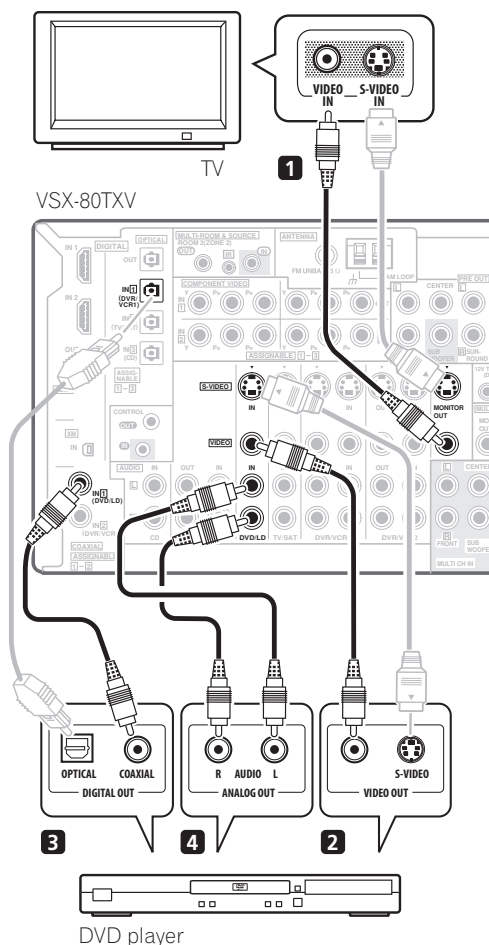

The diagram shows a basic setup of this receiver together with a TV and DVD player, with S-video or composite video connections. Different TVs and DVD players may offer alternative connections. See also *Using the component video jacks* on page 14 if your TV and/or DVD player has component video inputs/outputs. If your DVD player offers multichannel analog audio outputs, see *Connecting the multichannel analog inputs* on page 43.

### 1 Connect the MONITOR OUT video jack to a video input on your TV.

Use a standard RCA/phono jack video cable to connect to the composite video jack, or for higher quality video, use an S-video cable to connect to the S-video jack.

2 Connect a composite or S-video output on your DVD player to the DVD/LD VIDEO or DVD/LD S-VIDEO input. Connect using a standard video cable or an S-video cable.

3 Connect a coaxial-type<sup>1</sup> digital audio output on your DVD player to the COAXIAL 1 (DVD/LD) input. Use a coaxial cable designed for digital audio.

4 Connect the stereo audio outputs on your DVD player to the DVD/LD AUDIO inputs. Connect using a stereo RCA/phono jack cable.

- If your DVD player has multichannel analog outputs, you can connect these instead. See also *Connecting the multichannel analog inputs* on page 43.

## Connecting a satellite/cable receiver or other set-top box

Satellite and cable receivers, and terrestrial digital TV tuners are all examples of so-called 'set-top boxes'.

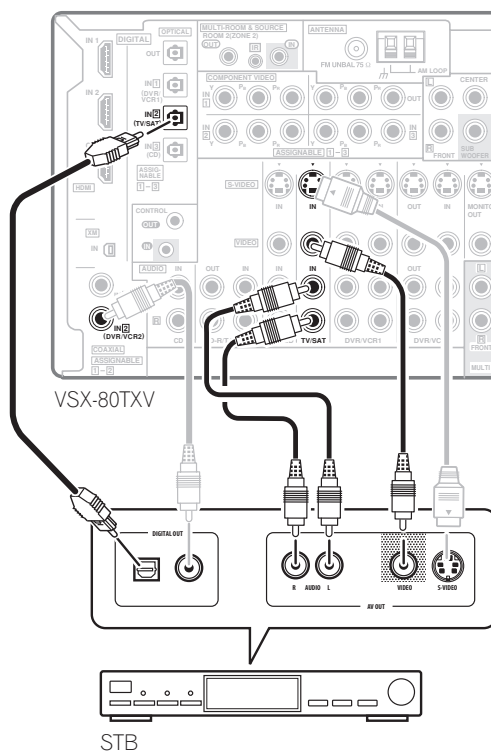

### 1 Connect the audio/video outputs on the set-top box to the TV/SAT AUDIO and VIDEO inputs.

Connect using a stereo RCA/phono jack cable and a video or S-video cable.

### Note

<sup>1</sup> If your DVD player only has an optical digital output, you can connect it to one of the optical inputs on this receiver using an optical cable. When you set up the receiver you'll need to tell the receiver which input you connected the player to (see *The Input Assign menu* on page 50).

**2** Connect an optical-type<sup>1</sup> digital audio output from your set-top box to the **OPTICAL 2 (TV/SAT)** input.<sup>2</sup> Use an optical cable for the connection.

## Connecting a DVD/HDD recorder, VCR and other video sources

This receiver has two sets of audio/video inputs and outputs suitable for connecting analog or digital video devices, including DVD/HDD recorders and VCRs.

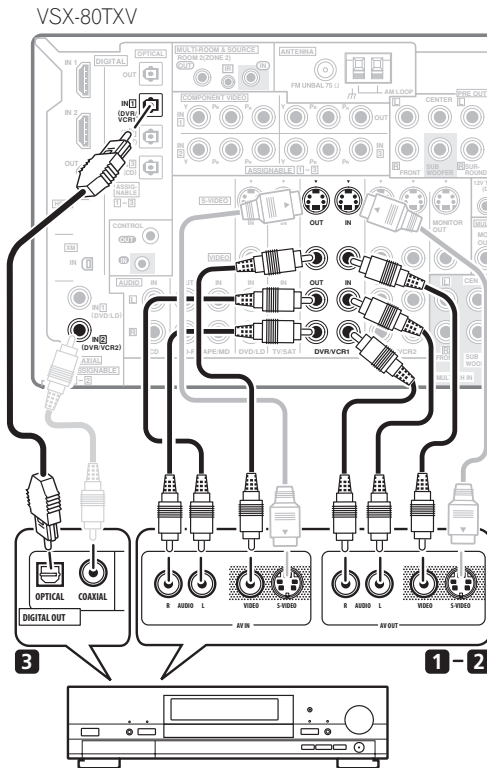

DVR, VCR, etc.

**1** Connect the audio/video outputs of the video player/recorder to the **DVR/VCR1 AUDIO and VIDEO** inputs.

Use a stereo RCA/phono jack audio cable for the audio connection and a video or S-video cable for the video connection.

- For a second recorder, use the **DVR/VCR2 IN** inputs.

**2** If the device can record, connect the **DVR/VCR1 AUDIO and VIDEO** outputs to the recorder's audio/video inputs.

Use a stereo RCA/phono jack audio cable for the audio connection and a video or S-video cable for the video connection.

- For a second recorder, use the **DVR/VCR2** outputs.

**3** If the device can output digital audio, connect an optical-type<sup>3</sup> digital audio output from the recorder to the **OPTICAL 1 (DVR/VCR1)** input.

Use an optical cable for the connection.<sup>4</sup>

- For a second recorder, use the **COAXIAL 2 (DVR/VCR2)** inputs.

## Using the component video jacks

Component video should give superior picture quality when compared to composite or S-video. You can also take advantage of progressive scan video (if your source and TV are both compatible), which delivers a very stable, flicker-free picture. See the manuals that came with your TV and source component to check whether they are compatible with progressive-scan video.

### Note

1 If your set-top box only has a coaxial digital output, you can connect it to one of the coaxial inputs on this receiver using a coaxial digital audio cable. When you set up the receiver you'll need to tell the receiver which input you connected the set-top box to (see *The Input Assign menu* on page 50).

2 If your satellite/cable receiver doesn't have a digital audio output, you can skip this step.

3 • In order to record, you must connect the analog audio cables (the digital connection is for playback only).  
• If your video component doesn't have a digital audio output, you can skip this step.

4 If your recorder only has a coaxial digital output, you can connect it to one of the coaxial inputs on this receiver using a coaxial digital audio cable. When you set up the receiver you'll need to tell the receiver which input you connected the recorder to (see also *The Input Assign menu* on page 50).

VSX-80TXV

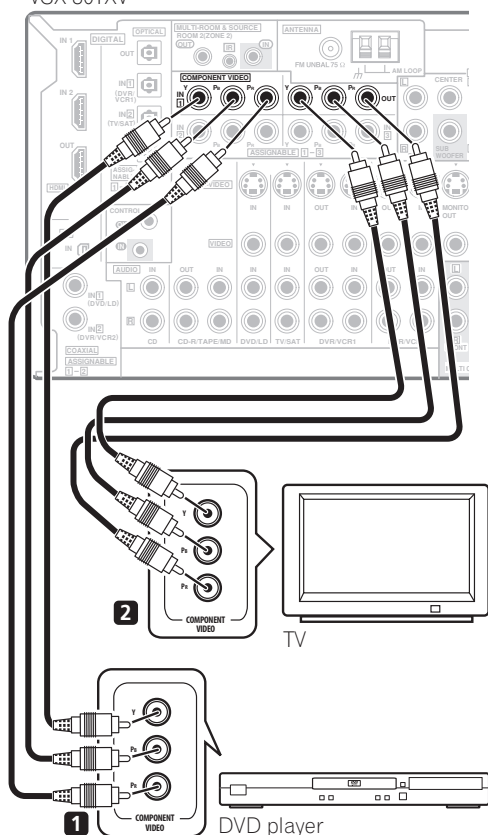

**1** Connect the component video outputs of your source to a set of ASSIGNABLE COMPONENT VIDEO inputs.

Connect using a three-way component video cable.

- Since they are assignable, it doesn't matter which component video inputs you use for which source. After connecting everything, you'll need to assign the component video inputs—see *The Input Assign menu* on page 50.

**2** Connect the COMPONENT VIDEO OUT jacks to the component video inputs on your TV or monitor.

Use a three-way component video cable.

## Connecting digital audio sources

This receiver has both digital inputs and outputs, allowing you to connect digital audio components for playback and for making digital recordings.

Most digital components also have analog connections. See *Connecting analog audio sources* on the following page if you want to connect these too.

VSX-80TXV

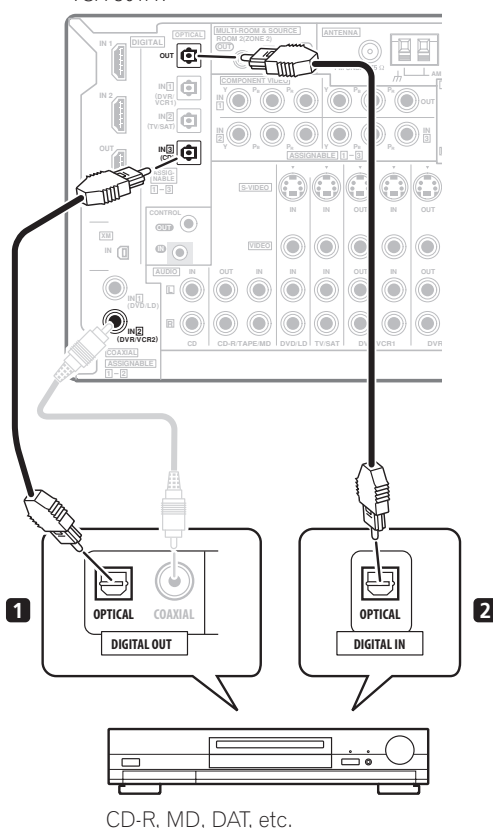

**1** Connect an optical-type<sup>1</sup> digital audio output on your digital component to the DIGITAL 3 (CD) input. Use an optical cable for the connection.

**2** For recording equipment, connect the optical-type DIGITAL output to a digital input on the recorder.

Use an optical cable to connect to the DIGITAL OUT.<sup>2</sup>

### Note

<sup>1</sup> If your digital component only has a coaxial digital output, you can connect it to one of the coaxial inputs on this receiver using a coaxial cable. When you set up the receiver you'll need to tell the receiver which input you connected the component to (see also *The Input Assign menu* on page 50).

• The digital outputs from other components can be connected to any spare digital audio inputs on this receiver. You can assign them when setting up the receiver (see also *The Input Assign menu* on page 50).

<sup>2</sup> In order to record some digital sources, you must make analog connections as explained in *Connecting analog audio sources* below.

### About the WMA9 Pro decoder

This unit has an on-board Windows Media® Audio 9 Professional<sup>1</sup> (WMA9 Pro) decoder, so it is possible to playback WMA9 Pro-encoded audio using a coaxial or optical digital connection when connected to a WMA9 Pro-compatible player. However, the connected PC, DVD player, set-top box, etc. must be able to output WMA9 Pro format audio signals through a coaxial or optical digital output.

### Connecting analog audio sources

This receiver features two stereo audio-only inputs. One of these inputs (**CD-R/TAPE/MD**) has corresponding outputs for use with audio recorders.

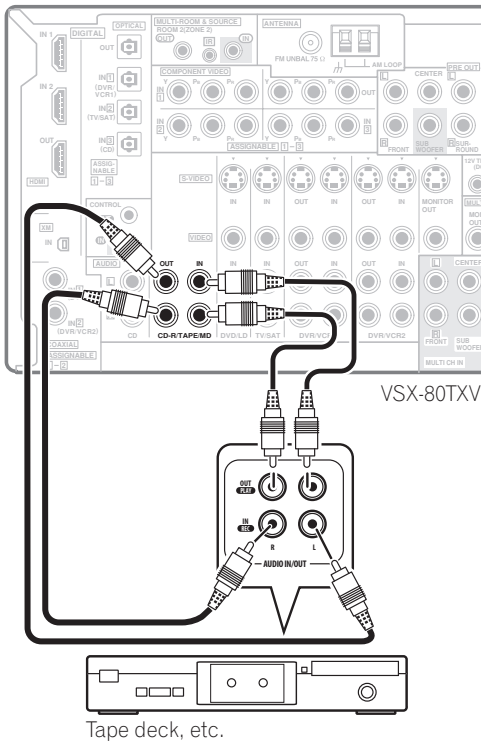

Tape deck, etc.

- **Connect the analog audio outputs of the source component to one of the AUDIO inputs.**

Connect using a stereo RCA/phono jack audio cable.

- If you're connecting a tape deck, MD recorder, etc., connect the analog audio outputs (**OUT**) to the analog audio inputs on the recorder.

### Connecting a component to the front panel inputs

The front panel inputs comprise a composite video jack (**VIDEO**), an S-Video jack (**S-VIDEO**), stereo analog audio inputs (**AUDIO L/R**) and an optical digital audio input (**DIGITAL**). You can use these connections for any kind of audio/video component, but they are especially convenient for portable equipment such as camcorders, video games and portable audio/video equipment.

- Push down on the **PUSH OPEN** tab to access the front video connections.

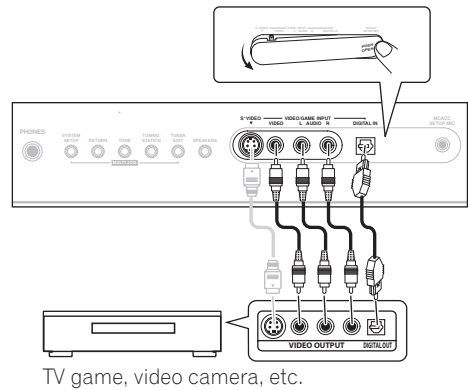

TV game, video camera, etc.

- Select these inputs by pressing **VIDEO/GAME** or using **INPUT SELECT** (remote) to select **VIDEO/GAME**.

#### Note

<sup>1</sup> • Microsoft, Windows Media®, and the Windows logo are trademarks, or registered trademarks of Microsoft Corporation in the United States and/or other countries.

• With WMA9 Pro, sound problems may occur depending on your computer system. Note that WMA9 Pro 96 kHz sources will be downsampled to 48 kHz.



## Installing your speaker system

To take full advantage of the receiver's surround sound capabilities connect front, center, surround and surround back speakers, as well as a subwoofer. Although this is ideal, other configurations with fewer speakers—no subwoofer or no center speaker, or even no surround speakers—will work. At the very least, front left and right speakers only are necessary. Note that your

main surround speakers should always be connected as a pair, but you can connect just one surround back speaker if you like (it must be connected to the left surround back terminal). You can use speakers with a nominal impedance between 6  $\Omega$  to 16  $\Omega$  (please see *Switching the speaker impedance* on page 55 if you plan to use speakers with an impedance of less than 8  $\Omega$ ).

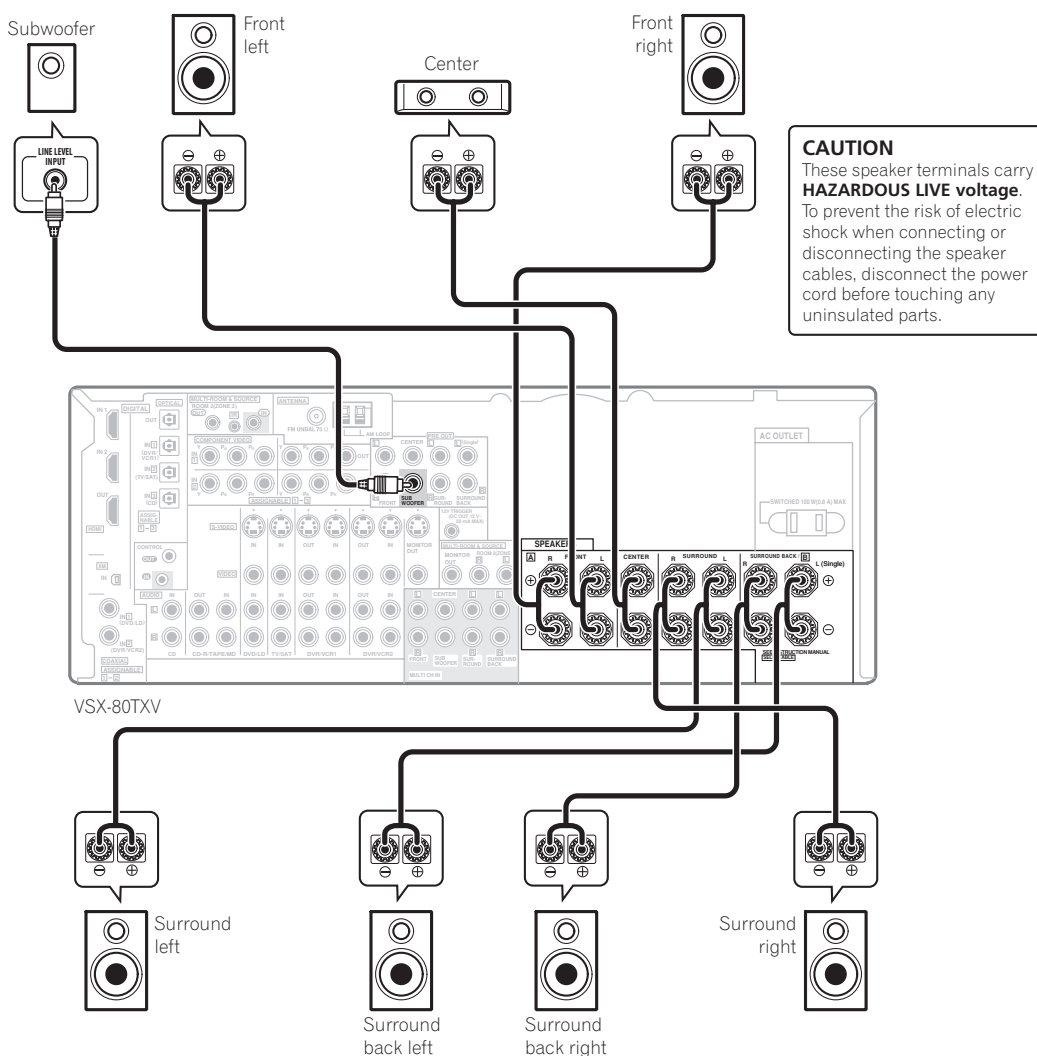

## Connecting the speakers

Each speaker connection on the receiver comprises a positive (+) and negative (-) terminal. Make sure to match these up with the terminals on the speakers themselves.

### Caution

- Make sure that all the bare speaker wire is twisted together and inserted fully into the speaker terminal. If any of the bare speaker wire touches the back panel it may cause the power to cut off as a safety measure.

### Bare wire connections

Make sure that the speaker cable you're going to use is properly prepared with about  $\frac{3}{8}$  in. of insulator stripped from each wire, and the exposed wire strands twisted together (*fig. A*).

To connect a terminal, unscrew the terminal a few turns until there is enough space to insert the exposed wire (*fig. B*). Once the wire is in position, tighten the terminal until the wire is firmly clamped (*fig. C*).

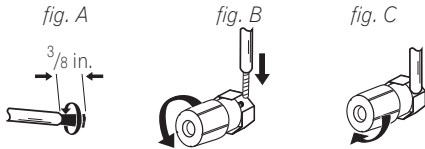

### Banana plug connections

If you want to use speaker cables terminated with banana plugs, screw the speaker terminal fully shut then plug the banana plug into the end of the speaker terminal.

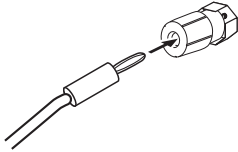

### Important

- Please refer to the manual that came with your speakers for details on how to connect the other end of the speaker cables to your speakers.
- *Other connections* on page 41 provides greater detail on alternate speaker setups, such as using speaker system B (page 44), bi-amping (page 44) and bi-wiring (page 45).
- If you are using a THX certified subwoofer use the **THX INPUT** jack on the subwoofer (if your subwoofer has one) or switch the filter position to **THX** on your subwoofer.

### Placing the speakers

Where you put your speakers in the room has a big effect on the quality of the sound. The following guidelines should help you to get the best sound from your system.

- The subwoofer can be placed on the floor. Ideally, the other speakers should be at about ear-level when you're listening to them. Putting the speakers on the floor (except the subwoofer), or mounting them very high on a wall is not recommended.
- For the best stereo effect, place the front speakers 6 ft. to 9 ft. apart, at equal distance from the TV.

- When placing speakers near the TV, we recommend using magnetically shielded speakers to prevent possible interference, such as discoloration of the picture when the TV is switched on. If you do not have magnetically shielded speakers and notice discoloration of the TV picture, move the speakers farther away from the TV.
- If you're using a center speaker, place the front speakers at a wider angle. If not, place them at a narrower angle.
- Place the center speaker above or below the TV so that the sound of the center channel is localized at the TV screen. Also, make sure the center speaker does not cross the line formed by the leading edge of the front left and right speakers.
- It is best to angle the speakers towards the listening position. The angle depends on the size of the room. Use less of an angle for bigger rooms.
- Surround and surround back speakers should be positioned a foot-and-a-half to three feet higher than your ears and titled slight downward. Make sure the speakers don't face each other. For DVD-Audio, the speakers should be more directly behind the listener than for home theater playback.
- Try not to place the surround speakers farther away from the listening position than the front and center speakers. Doing so can weaken the surround sound effect.
- To achieve the best possible surround sound, install your speakers as shown below. Be sure all speakers are installed securely to prevent accidents and improve sound quality.

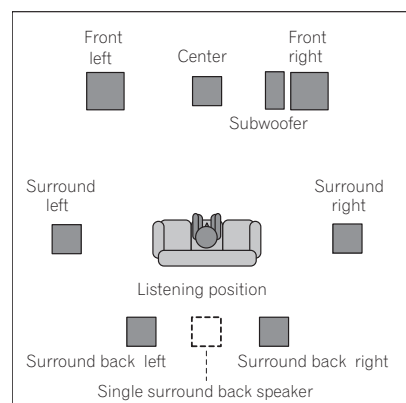

### Caution

- Make sure that all speakers are securely installed. This not only improves sound quality, but also reduces the risk of damage or injury resulting from speakers being knocked over or falling in the event of external shocks such as earthquakes.

The diagrams below show suggested surround and surround back speaker orientation. The first diagram (*fig. A*) shows orientation with one surround back speaker (or none) connected. The second (*fig. B*) shows orientation with two surround back speakers connected.

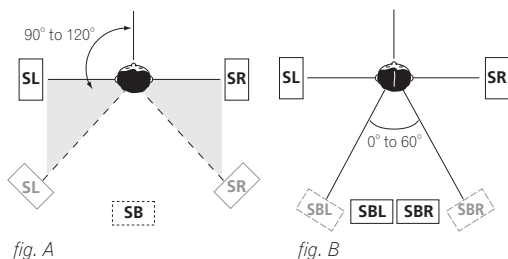

- If you have two surround back speakers THX recommends placing them together and the same distance from your listening position (see below).

### THX speaker system setup

If you have a complete THX speaker system, follow the diagram below to place your speakers. Note that the surround speakers (⊞ indicates bi-polar radiating speakers) should output at an angle parallel to the listener.

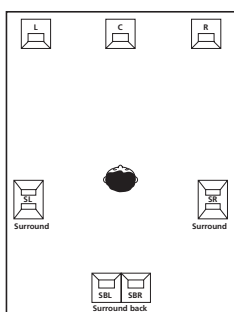

- If you have two surround back speakers THX recommends placing them together and the same distance from your listening position for the following THX modes: **THX Select2 CINEMA**, **THX MUSICMODE** and **THX GAMES MODE**.

### Connecting antennas

Connect the AM loop antenna and the FM wire antenna as shown below. To improve reception and sound quality, connect external antennas (see *Connecting external antennas* below).

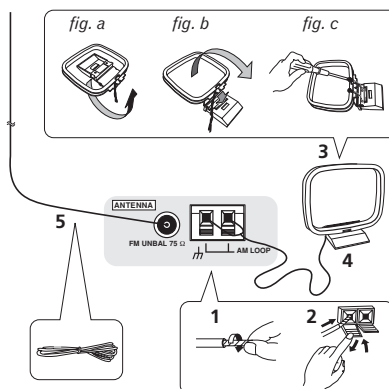

- 1 Pull off the protective shields of both AM antenna wires.**
- 2 Push open the tabs, then insert one wire fully into each terminal, then release the tabs to secure the AM antenna wires.**
- 3 Fix the AM loop antenna to the attached stand.**  
To fix the stand to the antenna, bend in the direction indicated by the arrow (*fig. a*) then clip the loop onto the stand (*fig. b*).
  - If you plan to mount the AM antenna to a wall or other surface, secure the stand with screws (*fig. c*) before clipping the loop to the stand. Make sure the reception is clear.
- 4 Place the AM antenna on a flat surface and in a direction giving the best reception.**
- 5 Connect the FM wire antenna in the same way as the AM loop antenna.**

For best results, extend the FM antenna fully and fix to a wall or door frame. Don't drape loosely or leave coiled up.

### Connecting external antennas

To improve FM reception connect an external FM antenna to the **FM UNBAL 75 Ω** terminal.

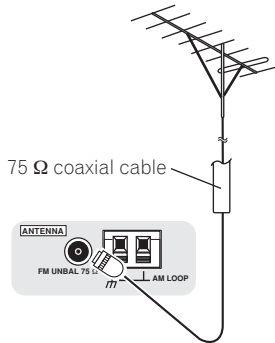

To improve AM reception, connect a 15 ft. to 18 ft. length of vinyl-coated wire to the **AM LOOP** terminals without disconnecting the supplied AM loop antenna.

For the best possible reception, suspend horizontally outdoors.

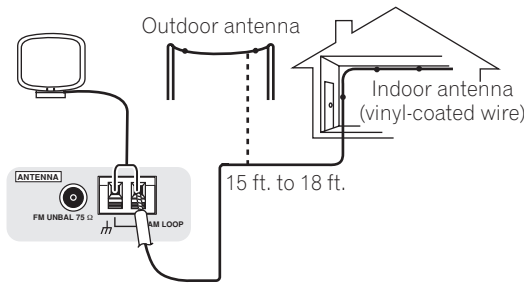

### Plugging in the receiver

Only plug in after you have connected all your components to this receiver, including the speakers.

#### Caution

- Handle the power cord by the plug part. Do not pull out the plug by tugging the cord, and never touch the power cord when your hands are wet, as this could cause a short circuit or electric shock. Do not place the unit, a piece of furniture, or other object on the power cord or pinch the cord in any other way. Never make a knot in the cord or tie it with other cables. The power cords should be routed so that they are not likely to be stepped on. A damaged power cord can cause a fire or give you an electric shock. Check the power cord once in a while. If you find it damaged, ask your nearest Pioneer authorized independent service company for a replacement.
- The receiver should be disconnected by removing the mains plug from the wall socket when not in regular use, e.g., when on vacation.
- Make sure the blue  **STANDBY/ON** light has gone out before unplugging.
- **Plug the power cord into a power outlet.**

### AC outlet

Power supplied through this outlet is turned on and off by the receiver's power switch. Total electrical power consumption of connected equipment should not exceed 100 W (0.8 A).

#### Caution

- Do not connect a TV set, monitor, heater, or similar appliance to this unit's AC outlet.
- Do not connect appliances with high power consumption to the AC outlet in order to avoid overheating and fire risk. This can also cause the receiver to malfunction.
- Since a subwoofer or power amplifier can exceed the 100 W maximum when playing sources at a high volume, this type of equipment should not be connected to the AC outlet.

## Chapter 4: Controls and displays

### Front panel

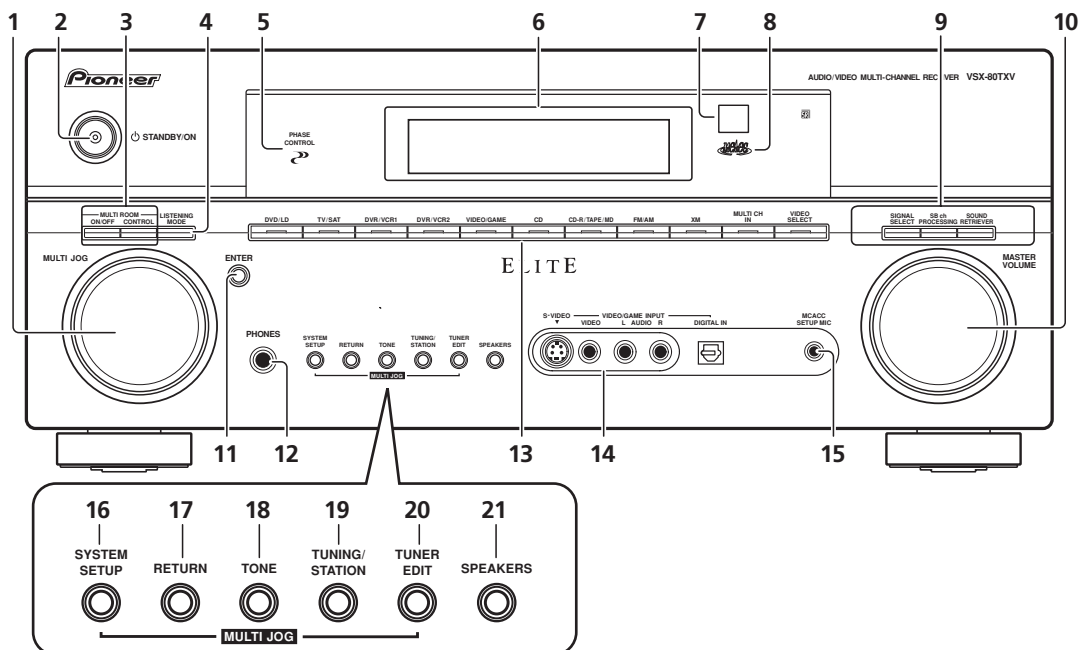

#### 1 MULTI JOG dial

Use the **MULTI JOG** dial to select various settings and menu options.

#### 2 **⏻** STANDBY/ON

Switches the receiver between on and standby. Power indicator lights when the receiver is on.

#### 3 **MULTI ROOM** controls

If you've made multi-room connections (see *Multi-room listening* on page 46) use these controls to control the sub room from the main room (see *Using the multi-room controls* on page 46).

#### 4 **LISTENING MODE**

Use with the **MULTI JOG** dial to select the various listening modes (page 26).

#### 5 **PHASE CONTROL** indicator

Lights when Basic Phase Control is switched on (page 10).

#### 6 **Character display**

See *Display* on page 23.

#### 7 **Remote sensor**

Receives the signals from the remote control (see *Operating range of remote control unit* on page 22).

#### 8 **MCACC** indicator

Lights when Acoustic Calibration EQ (page 35) is on (Acoustic Calibration EQ is automatically set to **ALL CH ADJUST** after the Auto MCACC Setup (page 8) or EQ Auto Setup (page 35)).

#### 9 **SIGNAL SELECT**

Use to select an input signal (page 29).

**SBch PROCESSING** – Selects the surround back channel mode (page 29) or virtual surround back mode (page 29).

**SOUND RETRIEVER** – Press to restore CD quality sound to compressed audio sources (page 30).

#### 10 **MASTER VOLUME** dial

#### 11 **ENTER**

#### 12 **PHONES** jack

Use to connect headphones. When the headphones are connected, there is no sound output from the speakers.

**13 Input source buttons**

Press to select an input source (press **VIDEO SELECT** repeatedly to select the video source (page 54)).

**14 VIDEO/GAME INPUT**

See *Connecting a component to the front panel inputs* on page 16.

**15 MCACC SETUP MIC jack**

Use to connect the supplied microphone.

**16 SYSTEM SETUP**

Press to access the System Setup menu (see page 33).

**17 RETURN**

Press to confirm and exit the current menu screen.

**18 TONE**

Press this button to access the bass and treble controls, which you can then adjust with the **MULTI JOG** dial (page 30).

**19 TUNING/STATION**

Use to find radio frequencies and to select preset stations (page 31).

**20 TUNER EDIT**

Use with the **MULTI JOG** dial to memorize and name stations for recall (page 31).

**21 SPEAKERS**

Use to change the speaker system (page 44).

**Operating range of remote control unit**

The remote control may not work properly if:

- There are obstacles between the remote control and the receiver's remote sensor.
- Direct sunlight or fluorescent light is shining onto the remote sensor.
- The receiver is located near a device that is emitting infrared rays.
- The receiver is operated simultaneously with another infrared remote control unit.

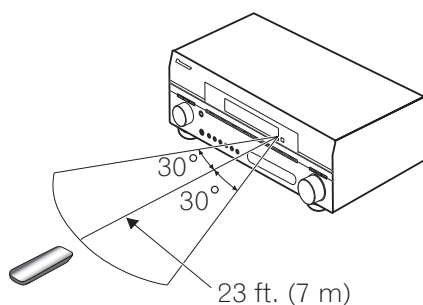

## Display

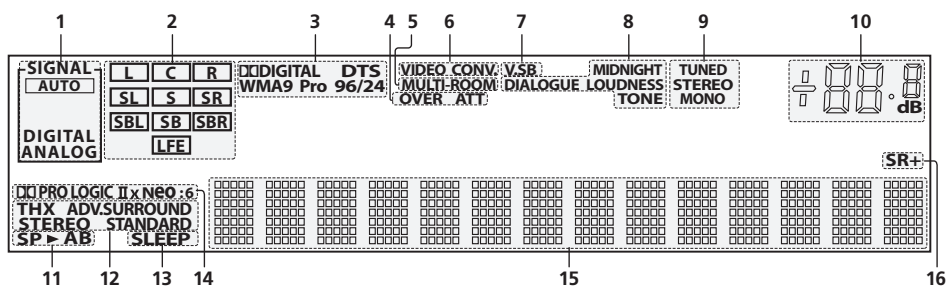

### 1 SIGNAL indicators

Light to indicate the currently selected input signal.

**AUTO** lights when the receiver is set to select the input signal automatically (page 29).

### 2 Program format indicators

These change according to which channels are active in digital sources.

- L** – Left front channel
- C** – Center channel
- R** – Right front channel
- SL** – Left surround channel
- S** – Surround channel (mono)
- SR** – Right surround channel
- SBL** – Left surround back channel
- SB** – Surround back channel (mono)
- SBR** – Right surround back channel
- LFE** – Low frequency effects channel

### 3 Digital format indicators

Light when a signal encoded in the corresponding format is detected.

### 4 OVER / ATT

**OVER** lights to indicate that the level of an analog source is too high. **ATT** lights when you use the attenuator (**ANALOG ATT**) to reduce it.

### 5 MULTI-ROOM

Lights when the multi-room feature is active (page 46).

### 6 VIDEO CONV.

Lights when digital video conversion is enabled (page 52).

### 7 V.SB

Lights during Virtual surround back processing (page 29).

### 8 Sound processing indicators

Light according to the active sound processing feature.

### 9 TUNER indicators

**TUNED** – Lights when a broadcast is being received.

**STEREO** – Lights when a stereo FM broadcast is being received in auto stereo mode.

**MONO** – Lights when the mono mode is set using the **MPX** button.

### 10 Master volume level

### 11 Speaker indicators

Indicate the current speaker system, **A** and/or **B** (page 44).

### 12 Listening mode indicators

**THX** – Lights when a Home THX mode is selected.

**ADV. SURROUND** – Lights when an Advanced Surround mode has been selected.

**STEREO** – Lights when stereo listening is switched on (see *Listening in stereo* on page 28).

**STANDARD** – Lights when a Standard Surround mode is switched on (see *Listening in surround sound* on page 26).

### 13 SLEEP

Lights when the receiver is in sleep mode (page 55).

### 14 Matrix decoding format indicators

**PRO LOGIC IIx** – This lights to indicate **PRO** Logic II / **PRO** Logic IIx decoding (page 26).

**Neo:6** – When one of the Neo:6 modes of the receiver is on, this lights to indicate Neo:6 processing (page 26).

### 15 Character display

Displays various system information.

### 16 SR+

Lights when the SR+ mode is switched on (page 49).

## Remote control

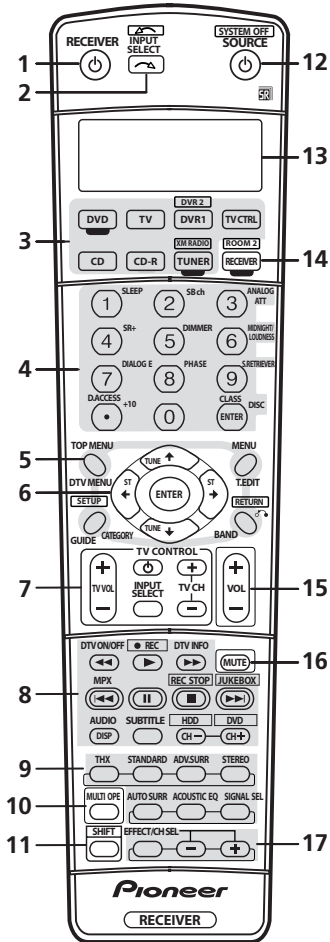

The remote has been conveniently color-coded according to component control using the following system (press the corresponding input source button to access):

- **Green** – Receiver controls (see below)
- **Red** – DVD controls (page 60)
- **Blue** – Tuner/XM Radio controls (page 31)
- **White** – Other controls (page 60)

### 1 RECEIVER

This switches between standby and on for this receiver.

### 2 INPUT SELECT

Use to select the input source (use **SHIFT** for **INPUT SELECT** ).

### 3 Input source buttons

Press to select control of other components (see *Controlling the rest of your system* on page 56).

## 4 Number buttons and other receiver/component controls

Use the number buttons to directly select a radio frequency (page 31) or the tracks on a CD, DVD, etc.

**DISC (ENTER)** can be used to enter commands for TV or DTV, and also to select a disc in a multi-CD player.

Press **RECEIVER** first to access:

**SLEEP** – Use to put the receiver in sleep mode and select the amount of time before sleep (page 55).

**SBch** – Use to select the surround/virtual back channel mode (page 29).

**ANALOG ATT** – Attenuates (lowers) the level of an analog input signal to prevent distortion (page 54).

**SR+** – Switches the SR+ mode on/off (page 49).

**DIMMER** – Dims or brightens the display (page 55).

**MIDNIGHT/LOUDNESS** – Use Midnight when listening to movie soundtracks at low volume. Use Loudness to boost the bass and treble at low volume (page 30).

**DIALOG E** – Use to make dialog stand out when watching TV or a movie (page 30).

**PHASE** – Press to switch on/off Basic Phase Control (page 10).

**S. RETRIEVER** – Press to restore CD quality sound to compressed audio sources (page 30).

Press **TUNER** first to access:

**D.ACCESS** – After pressing, you can access a radio station directly using the number buttons (page 31).

**CLASS** – Switches between the three banks (classes) of radio station presets (page 31).





## 5 Tuner/component control buttons/SETUP

These button controls can be accessed after you have selected the corresponding input source button (**DVD**, **DVR1**, **TV**, etc.). The **BAND** and **T.EDIT** tuner controls are explained from page 31. Press **RECEIVER** first to access the following controls:

**SETUP** – Use to access the System Setup menu (page 33).

**RETURN** – Press to confirm and exit the current menu screen (also use to return to the previous menu with DVDs or to select closed captioning with DTV).

## 6 (TUNE/ST) /ENTER

Use the arrow buttons when setting up your surround sound system (page 33). Also used to control DVD menus/options and for deck 1 of a double cassette deck player. Use the **TUNE** / buttons to find radio frequencies and use **ST** / to find preset stations (page 31).



## 7 TV CONTROL buttons

These buttons are dedicated to control the TV assigned to the **TV CTRL** button. Thus if you only have one TV to hook up to this system assign it to the **TV CTRL** input source button. If you have two TVs, assign the main TV to the **TV CTRL** button (see page 56 for more on this).



**TV**  – Use to turn on/off the power of the TV.

**TV VOL +/-** – Use to adjust the volume on your TV.

**INPUT SELECT** – Use to select the TV input signal.

**TV CH +/-** – Use to select channels.

## 8 Component control buttons

The main buttons (, , etc.) are used to control a component after you have selected it using the input source buttons.

The controls above these buttons can be accessed after you have selected the corresponding input source button (for example **DVD**, **DVR1** or **TV**). The following controls can be accessed when listening to the built-in tuner:

**MPX** – Switches between stereo and mono reception of FM broadcasts. If the signal is weak then switching to mono will improve the sound quality (page 31).

**DISP** – Switches between named station presets and radio frequencies (page 32).

## 9 Receiver controls

**THX** – Press to select a Home THX listening mode (page 27).

**STANDARD** – Press for Standard decoding and to switch between the various  Pro Logic IIx and Neo:6 options (page 26).

**ADV.SURR** – Use to switch between the various surround modes (page 27).

**STEREO** – Switches between direct and stereo playback. Direct playback bypasses the tone controls and any other signal processing for the most accurate reproduction of a source (page 28).

**AUTO SURR** – Selects Auto Surround (*Auto playback* on page 26).

**ACOUSTIC EQ** – Press to select an Acoustic Calibration EQ setting (page 28).

**SIGNAL SEL** – Use to select an input signal (page 29).

## 10 MULTI OPE

Use this button to perform multi operations (page 58).

## 11 SHIFT

Press to access the controls outlined in white boxes (for example, **INPUT SELECT** ) , or to display the currently selected input source in the remote control LCD.

## 12 SOURCE

Press to turn on/off other components connected to the receiver (see page 56 for more on this).

## 13 Character display (LCD)

This display shows information when transmitting control signals.

The following commands are shown when you're setting the remote to control other components (see *Controlling the rest of your system* on page 56):

**SETUP** – Indicates the setup mode, from which you choose the options below.

**PRESET** – See *Selecting preset codes directly* on page 56.

**LEARNING** – See *Programming signals from other remote controls* on page 56.

**MULTI OP** – See *Multi Operation and System Off* on page 58.

**SYS OFF** – See *Multi Operation and System Off* on page 58.

**DIRECT F** – See *Direct function* on page 58.

**RENAME** – See *Renaming input source names* on page 58.

**ERASE** – See *Erasing one of the remote control button settings* on page 57.

**RESET** – See *Resetting the remote control presets* on page 57.

**READ ID** – See *Confirming preset codes* on page 57.

## 14 RECEIVER

Switches the remote to control the receiver (used to select the green commands above the number buttons (**ANALOG ATT**, etc)). Also use this button to set up surround sound (page 8, page 33). With **SHIFT**, this selects the multi-room control (page 46).

## 15 VOL +/-

Use to set the listening volume.

## 16 MUTE

Mutes the sound or restores the sound if it has been muted (adjusting the volume also restores the sound).

## 17 EFFECT/CH SEL

Press repeatedly to select a channel, then use **+/-** to adjust the level (see *Tip* on page 39). Also adjusts the level of the Advanced Surround effects, Dolby Pro Logic IIx Music, and Neo:6 Music parameters (page 27). You can then use the **+/-** buttons to make these adjustments.

## Chapter 5:

## Listening to your system

**Important**

- The listening modes and many features described in this section may not be available depending on the current source (for example, PCM 88.2 kHz / 96 kHz, DTS 96 kHz (24 bit) or WMA9 Pro), settings and status of the receiver. See *Listening modes with different input signal formats* on page 69 for more on this.

**Tip**

- The listening modes described below can also be selected using the front panel controls. Simply press **LISTENING MODE** repeatedly to access the modes you want, then use the **MULTI JOG** to select a particular listening mode (after five seconds the mode is automatically set).

**Auto playback**

There are many ways to listen back to sources using this receiver, but for the simplest, most direct listening option is the Auto Surround feature. The receiver automatically detects what kind of source you're playing and selects multichannel or stereo playback as necessary.<sup>1</sup>

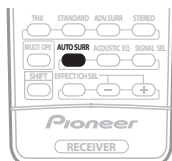

- While listening to a source, press **AUTO SURR** for auto playback of a source.

**AUTO SURROUND** shows briefly in the display before showing the decoding or playback format. Check the digital format indicators in the front panel display to see how the source is being processed.

- When listening to XM Radio, the XM HD Surround feature is selected automatically (see *Using XM HD Surround* on page 42 for more on this).

**Listening in surround sound**

Using this receiver, you can listen to any source in surround sound. However, the options available will depend on your speaker setup and the type of source you're listening to.

If you connected surround back speakers, see also *Using surround back channel processing* on page 29.

**Standard surround sound**

The following modes provide basic surround sound for stereo and multichannel sources.<sup>2</sup>

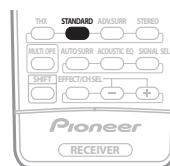

- While listening to a source, press **STANDARD**. If necessary, press repeatedly to select a listening mode.
- If the source is Dolby Digital, DTS, or Dolby Surround encoded, the proper decoding format will automatically be selected and shows in the display.<sup>3</sup>

With two channel sources, you can select from:

- Pro Logic IIx MOVIE** – Up to 7.1 channel sound, especially suited to movie sources
- Pro Logic IIx MUSIC** – Up to 7.1 channel sound, especially suited to music sources<sup>4</sup>
- Pro Logic IIx GAME** – Up to 7.1 channel sound, especially suited to video games
- PRO LOGIC** – 4.1 channel surround sound (sound from the surround speakers is mono)
- Neo:6 CINEMA** – 6.1 channel sound, especially suited to movie sources
- Neo:6 MUSIC** – 6.1 channel sound, especially suited to music sources<sup>5</sup>

With multichannel sources, if you have connected surround back speaker(s) and have selected **SBch ON**, you can select (according to format):

**Note**

<sup>1</sup> Stereo surround (matrix) formats are decoded accordingly using **Neo:6 CINEMA** or **Pro Logic IIx MOVIE** (see *Listening in surround sound* above for more on these decoding formats).

The Auto Surround feature is canceled if you connect headphones or select the multichannel analog inputs.

<sup>2</sup> In modes that give 6.1 channel sound, the same signal is heard from both surround back speakers.

<sup>3</sup> If surround back channel processing (page 29) is switched **OFF**, or the surround back speakers are set to **NO** (this happens automatically if the *Surround back speaker setting* on page 33 is set to anything but **Normal (SB)**), **Pro Logic IIx** becomes **Pro Logic II** (5.1 channel sound).

<sup>4</sup> When listening to 2-channel sources in Dolby Pro Logic IIx Music mode, there are three further parameters you can adjust: Center Width, Dimension, and Panorama. See *Setting the effect options* on page 27 to adjust them.

<sup>5</sup> When listening to 2-channel sources in Neo:6 Music mode, you can also adjust the center image effect (see *Setting the effect options* on page 27).

- **THX Pro Logic IIx MOVIE** – See above (only available when you're using two surround back speakers)
- **THX Pro Logic IIx MUSIC** – See above
- **Dolby Digital EX** – Creates surround back channel sound for 5.1 channel sources and provides pure decoding for 6.1 channel sources (like Dolby Digital Surround EX)
- **DTS-ES** – Allows you to hear 6.1 channel playback with DTS-ES encoded sources
- **DTS Neo:6** – Allows you to hear 6.1 channel playback with DTS encoded sources

### Using the Home THX modes

THX and Home THX are technical standards created by THX Ltd. for cinema and home theater sound. Home THX is designed to make home theater audio sound more like what you hear in a cinema.

Different THX options will be available depending on the source and the setting for surround back channel processing (see *Using surround back channel processing* on page 29 for more on this).

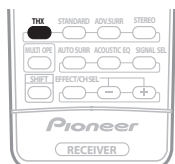

- **Press THX (HOME THX) to select a listening mode.<sup>1</sup>**

With two channel sources, press **THX** repeatedly to select a matrix-decoding process for the **THX CINEMA** mode (see *Listening in surround sound* above for an explanation of each process):

- **THX Pro Logic IIx MOVIE+THX**
- **THX PRO LOGIC+THX**
- **THX Neo:6 CINEMA+THX**
- **THX GAMES MODE**

With multichannel sources, press **THX (HOME THX)** repeatedly to select from:<sup>2</sup>

- **THX CINEMA** – Gives you cinema-quality sound from your home theatre system using all the speakers in your setup
- **THX Pro Logic IIx MOVIE+THX** – Especially suited to movie sources, this allows you to hear 7.1 channel playback with 5.1 channel sources

- **THX Surround EX** – Allows you to hear 6.1 or 7.1 channel playback with 5.1 channel sources
- **THX Select2 CINEMA** – Allows you to hear 7.1 channel playback with 5.1 channel sources
- **THX MUSICMODE** – Allows you to hear 7.1 channel playback with 5.1 channel sources
- **THX GAMES MODE** – Allows you to hear 7.1 channel playback from the output of a video game console

### Using the Advanced surround effects

The Advanced surround effects can be used for a variety of additional surround sound effects. Most Advanced Surround modes are designed to be used with film soundtracks, but some modes are also suited for music sources. Try different settings with various soundtracks to see which you like.

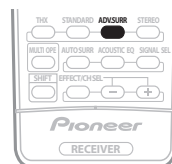

- **Press ADV.SURR repeatedly to select a listening mode.<sup>3</sup>**

- **ADVANCED MOVIE** – Suitable for movie sources.
- **ADVANCED MUSIC** – Suitable for music sources.
- **TV SURROUND** – Provides surround sound for both mono and stereo TV sources.
- **SPORTS** – Suitable for sports programs.
- **ADVANCED GAME** – Suitable for video games.
- **EXPANDED** – Simulates multichannel surround sound for two-channel sources.<sup>4</sup>
- **7ch STEREO** – Gives multichannel sound to a stereo source, using all of your speakers.
- **VIR. SURROUND** – A virtual surround effect using just the subwoofer and front speakers.
- **PhonesSurround** – Creates the effect of overall surround with headphones.

### Setting the effect options

When using surround effects, there are a number of settings you can adjust.

#### Note

<sup>1</sup> You can't use the THX modes when headphones are connected.

<sup>2</sup> If you only have one surround back speaker connected, **THX Pro Logic IIx MOVIE+THX**, **THX Select2 CINEMA**, **THX MUSICMODE** and **THX GAMES MODE** are not available.

<sup>3</sup> Depending on the source and the sound mode you have selected, you may not get sound from the surround back speakers in your setup. For more on this, refer to *Using surround back channel processing* on page 29.

<sup>4</sup> If you press **ADV. SURR** when the headphones are connected, the **PhonesSurround** mode will automatically be selected.

<sup>4</sup> Use with Dolby Pro Logic for a stereo surround effect (stereo field is wider than Standard modes with Dolby Digital sources).

### 1 Press EFFECT/CH SEL repeatedly to select the setting you want to adjust.

Depending on the current status / mode of the receiver, certain options may not appear. Check the table below for notes on this.

### 2 Use the +/- buttons to set it as necessary.

See the table below for the options available for each setting. The defaults, if not stated, are listed in bold.

### 3 Press EFFECT/CH SEL again to adjust other settings.

Setting	What it does	Options
<b>Center Width<sup>a</sup></b> (Applicable only when using a center speaker)	Spreads the center channel between the front right and left speakers, making it sound wider (higher settings) or narrower (lower settings).	0 to 7 Default: <b>3</b>
<b>Dimension<sup>a</sup></b>	Adjusts the surround sound balance from front to back, making the sound more distant (minus settings), or more forward (positive settings).	-3 to +3 Default: <b>0</b>
<b>Panorama<sup>a</sup></b>	Extends the front stereo image to include surround speakers for a 'wraparound' effect.	<b>OFF</b>  <i>ON</i>
<b>Center Image<sup>b</sup></b> (Applicable only when using a center speaker)	Adjusts the center image to create a wider stereo effect with vocals. Adjust the effect from <b>0</b> (all center channel sent to front right and left speakers) to <b>10</b> (center channel sent to the center speaker only).	0 to 10 Default: <b>3</b>
<b>Effect</b>	Sets the effect level for the currently selected Advanced Surround mode (each mode can be set separately).	10 to 90

a. Only available with 2 ch sources in Dolby Pro Logic II Music / Dolby Pro Logic IIx Music mode.

b. Only available with 2 ch sources in Neo:6 Music mode.

## Listening in stereo

When you select **STEREO** or **DIRECT**, you will hear the source through just the front left and right speakers (and possibly your subwoofer depending on your speaker settings). Dolby Digital, DTS and WMA9 Pro multichannel sources are downmixed to stereo.

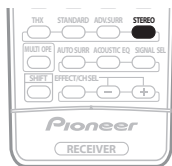

### • While listening to a source, press STEREO for stereo playback.

Press repeatedly to switch between:

- **STEREO** – The audio is heard with your surround settings and you can still use the Midnight, Loudness, and Tone functions.
- **DIRECT** – Bypass all effects and surround settings so that the audio remains as close to the source audio signal as possible.<sup>1</sup>

## Listening with Acoustic Calibration EQ

- Default setting: **OFF / ALL CH ADJUST** (after the Auto MCACC Setup or EQ Auto Setting)

You can listen to sources using the Acoustic Calibration Equalization set in *Automatically setting up for surround sound (MCACC)* on page 8 or *Acoustic Calibration EQ* on page 35. Refer to these pages for more on Acoustic Calibration Equalization.

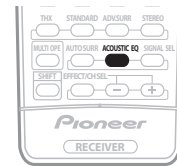

### • While listening to a source, press ACOUSTIC EQ.

Press repeatedly to select between:

- **ALL CH ADJUST** – No special weighting is given to any one channel.
- **FRONT ALIGN** – All speakers are heard in accordance with the front speaker settings.
- **CUSTOM 1/2** – Custom settings
- **EQ OFF** – Switches Acoustic Calibration EQ off.

The MCACC indicator on the front panel lights when Acoustic Calibration EQ is active.<sup>2</sup>

### Note

<sup>1</sup> If you switch on Midnight listening, Loudness, Dialog Enhancement, the Sound Retriever or the Tone controls when **DIRECT** is selected, the receiver automatically switches to **STEREO**.

<sup>2</sup> You can't use Acoustic Calibration EQ with **MULTI CH IN**, XM HD Surround or WMA9 Pro, and it has no effect with headphones.

- If you switch on Acoustic Calibration EQ when **DIRECT** is selected, the receiver automatically switches to **STEREO**.

## Choosing the input signal

You need to hook up a component to both analog and digital inputs on the receiver to select between input signals.<sup>1</sup>

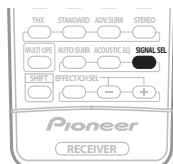

- Press **SIGNAL SEL (SIGNAL SELECT)** to select the input signal corresponding to the source component. Each press cycles through the options as follows:
  - **AUTO** – This is the default setting. The receiver selects the first available signal in the following order: **DIGITAL**; **ANALOG**.
  - **ANALOG** – Selects an analog signal.
  - **DIGITAL** – Selects an optical or coaxial digital signal.

When set to **DIGITAL** or **AUTO**, **DD DIGITAL** lights with Dolby Digital decoding, **DTS** lights with DTS decoding, and **WMA9 Pro** lights to indicate decoding of a WMA9 Pro signal.

## Using surround back channel processing

- Default setting: **SBch ON**

You can have the receiver automatically use 6.1 or 7.1 decoding for 6.1 encoded sources (for example, Dolby Digital EX or DTS-ES), or you can choose to always use 6.1 or 7.1 decoding (for example, with 5.1 encoded material). With 5.1 encoded sources, a surround back channel will be generated, but the material may sound better in the 5.1 format for which it was originally encoded (in which case, you can simply switch surround back channel processing off).

The table below indicates when you will hear the surround back channel when playing various kinds of sources. (●=Sound plays through surround back speaker(s))

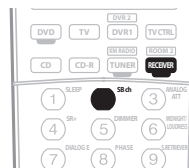

- Press **RECEIVER** then press **SBch (SBch PROCESSING)** repeatedly to cycle the surround back channel options.

Each press cycles through the options as follows:

- **SBch ON** – 6.1 or 7.1 decoding is always used (for example, a surround back channel will be generated for 5.1 encoded material)
- **SBch AUTO** – Automatically switches to 6.1 or 7.1 decoding for 6.1 encoded sources (for example, Dolby Digital EX or DTS-ES)
- **SBch OFF** – Maximum 5.1 playback

## Using the Virtual Surround Back mode

When you're not using surround back speakers, selecting this mode allows you to hear a virtual surround back channel through your surround speakers. You can choose to listen to sources with no surround back channel information, or if the material sounds better in the format (for example, 5.1) for which it was originally encoded, you can have the receiver only apply this effect to 6.1 encoded sources like Dolby Digital EX or DTS-ES.<sup>2</sup> The table indicates when you will hear the virtual surround back channel. (●=Virtual surround back channel is active)

- Press **RECEIVER** then press **SBch (SBch PROCESSING)** repeatedly to cycle the virtual surround back channel options.

Each press cycles through the options as follows:

- **VirtualSB ON** – Virtual Surround Back is always used (for example, on 5.1 encoded material)
- **VirtualSB AUTO** – Virtual Surround Back is automatically applied to 6.1 encoded sources (for example, Dolby Digital EX or DTS-ES)

### Note

- This receiver can only play back Dolby Digital, PCM (32 kHz to 96 kHz), DTS (including DTS 96 kHz/24 bit) and WMA9 Pro digital signal formats. With other digital signal formats, set to **ANALOG** (the **MULTI CH IN** and **TUNER** functions are all fixed to **ANALOG**).
  - You may get digital noise when a LD or CD player compatible with DTS is playing an analog signal. To prevent noise, make the proper digital connections (page 15) and set the signal input to **DIGITAL**.
  - Some DVD players don't output DTS signals. For more details, refer to the instruction manual supplied with your DVD player.
- You can't use the Virtual Surround Back mode with headphones, or with the **THX**, **XM HD Surround**, **STEREO** or **DIRECT** modes.
  - You can only use the Virtual Surround Back mode if the surround speakers are on and the **Surr Back** setting is set to **NO** in the *Speaker Setting* on page 37.
  - Depending on the input signal and the listening mode, the Virtual Surround Back mode may not be effective.

- **VirtualSB OFF** – Virtual Surround Back mode is switched off

Type of source	SBch Processing / Virtual SB mode	Standard / THX				Advanced surround
		Multichannel sources	Stereo sources			
			Pro Logic IIx	Pro Logic	Neo:6	
Dolby Digital EX/DTS-ES/WMA9 Pro encoded multichannel sources with 6.1ch surround	ON	●				● <sup>b</sup>
	AUTO	●				● <sup>b</sup>
Dolby Digital/DTS/WMA9 Pro encoded multichannel sources	ON	●				● <sup>b</sup>
	AUTO	●				● <sup>b</sup>
Dolby Digital/DTS/PCM/WMA9 Pro encoded stereo sources	ON		●	● <sup>a,b</sup>	●	● <sup>b</sup>
	AUTO		● <sup>c</sup>		●	● <sup>b</sup>
Analog 2-channel (stereo) sources	ON		●	● <sup>a</sup>	●	●
	AUTO		● <sup>c</sup>		●	●

a. Only applicable when using the Virtual Surround Back mode.

b. Excluding the WMA9 Pro format.

c. Not applicable when using the Virtual Surround Back mode.

## Using Midnight and Loudness

The Midnight listening feature allows you to hear effective surround sound of movies at low volume levels. The effect automatically adjusts according to the volume at which you're listening. The Loudness listening feature can be used to get good bass and treble from music sources at low volume levels.

- Press **RECEIVER** then press **MIDNIGHT/LOUDNESS** to switch between **MIDNIGHT**, **LOUDNESS**, and **OFF**.

## Using the Sound Retriever

When audio data is removed during the WMA/MP3/MPEG-4 AAC compression process, sound quality often suffers from an uneven sound image. The Sound Retriever feature employs new DSP technology that helps bring CD quality sound back to compressed 2-channel audio by restoring sound pressure and smoothing jagged artifacts left over after compression.

- Press **RECEIVER** then press **S. RETRIEVER (SOUND RETRIEVER)** to switch the sound retriever on or off.

## Enhancing dialog

- Default setting: **OFF**

The Dialog Enhancement feature localizes dialog in the center channel to make it stand out from other background sounds in a TV or movie soundtrack.

- Press **RECEIVER** then press **DIALOG E** to switch dialog enhancement on or off.

## Using the tone controls

Depending on what you are listening to, you may want to adjust the bass or treble using the front panel tone control.<sup>1</sup>

- 1 Press **TONE** to select the frequency you want to adjust.

Press to switch between **BASS** and **TREBLE**.

- 2 Use the **MULTI JOG** dial to change the amount of bass or treble as necessary.

The bass and treble can be adjusted from **-6** to **+6** (dB).

- Wait about five seconds for your changes to be input automatically.

### Note

<sup>1</sup> The tone controls are only available when **STEREO** is selected (except when **STEREO** is selected using **AUTO SURROUND**).

## Chapter 6: Using the tuner

### Listening to the radio

The following steps show you how to tune in to FM and AM radio broadcasts using the automatic (search) and manual (step) tuning functions. If you already know the frequency of the station you want, see *Tuning directly to a station* below. Once you are tuned to a station you can memorize the frequency for recall later—see *Saving station presets* on page 31 for more on how to do this.

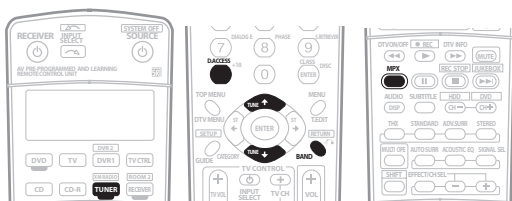

- 1 Press the **TUNER** button to select the tuner.
- 2 Use the **BAND** button to change the band (FM or AM), if necessary.  
Each press switches the band between FM and AM.
- 3 Tune to a station.  
There are three ways to do this:

#### Automatic tuning

To search for stations in the currently selected band, press and hold **TUNE**  $\uparrow/\downarrow$  for about a second. The receiver will start searching for the next station, stopping when it has found one. Repeat to search for other stations.

#### Manual tuning

To change the frequency one step at a time, press **TUNE**  $\uparrow/\downarrow$ .

#### High speed tuning

Press and hold **TUNE**  $\uparrow/\downarrow$  for high speed tuning. Release the button at the frequency you want.

### Improving FM stereo sound

If the **TUNED** or **STEREO** indicators don't light when tuning to an FM station because the signal is weak, press the **MPX** button to switch the receiver into mono reception mode. This should improve the sound quality and allow you to enjoy the broadcast.

### Tuning directly to a station

Sometimes, you'll already know the frequency of the station you want to listen to. In this case, you can simply enter the frequency directly using the number buttons on the remote control.

- 1 Press the **TUNER** button to select the tuner.
- 2 Use the **BAND** button to change the band (FM or AM), if necessary.  
Each press switches the band between FM and AM.
- 3 Press **D.ACCESS** (Direct Access).
- 4 Use the number buttons to enter the frequency of the radio station.  
For example, to tune to **106.00** (FM), press **1, 0, 6, 0, 0**.  
If you make a mistake halfway through, press **D.ACCESS** twice to cancel the frequency and start over.

### Saving station presets

If you often listen to a particular radio station, it's convenient to have the receiver store the frequency for easy recall whenever you want to listen to that station. This saves the effort of manually tuning in each time. This receiver can memorize up to 30 stations, stored in three banks, or classes, (A, B and C) of 10 stations each. When saving an FM frequency, the **MPX** setting (see page 31) is also stored.

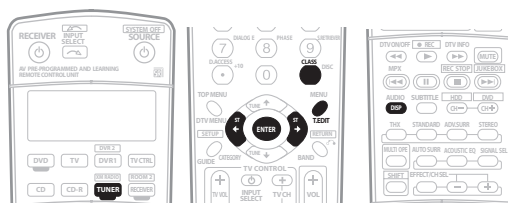

- 1 Tune to a station you want to memorize.  
See *Listening to the radio* on page 31 for more on this.
- 2 Press **T.EDIT** (TUNER EDIT).  
The display shows **STATION MEMORY**, then a blinking memory class.
- 3 Press **CLASS** to select one of the three classes then press **ST**  $\leftarrow/\rightarrow$  to select the station preset you want.  
You can also use the number buttons to select a station preset.
- 4 Press **ENTER**.  
After pressing **ENTER**, the preset class and number stop blinking and the receiver stores the station.

## Naming station presets

For easier identification, you can name your station presets.

### 1 Choose the station preset you want to name.

See *Listening to station presets* below for how to do this.

### 2 Press T.EDIT (TUNER EDIT).

The display shows **STATION NAME**, then a blinking cursor at the first character position.

### 3 Input the name you want.

Choose from the following characters for a name up to four characters long.

**ABCDEFGHIJKLMNOPQRSTUVWXYZ**

**abcdefghijklmnopqrstuvwxyz**

**0123456789**

**!"#\$%&'()\*+,-./:;<=>?@[ \ ]^\_{}~ [space]**

- Use the **ST** **←/→** buttons (remote) to select characters.
- Press **ENTER** to confirm a character. If no character is input, a space is input.
- The name is stored when **ENTER** is pressed after choosing the fourth character.

### Tip

- To erase a station name, simply repeat steps 1 to 3 and input four spaces instead of a name.
- Once you have named a station preset, you can press **DISP** when listening to a station to switch the display between name and frequency.

## Listening to station presets

You will need to have some presets stored to do this. See *Saving station presets* above if you haven't done this already.

### 1 Press TUNER to select the tuner.

### 2 Press CLASS to select the class in which the station is stored.

Press repeatedly to cycle through classes A, B and C.

### 3 Press ST **←/→** to select the station preset you want.

- You can also use the number buttons on the remote control to recall the station preset.



## Chapter 7: The System Setup menu

### Making receiver settings from the System Setup menu

The following section shows you how to make detailed settings to specify how you're using the receiver (for example, if you want to set up two speaker systems in separate rooms), and also explains how to fine-tune individual speaker system settings to your liking.

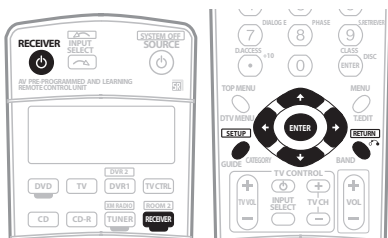

#### 1 Switch on the receiver and your TV.

Use the **RECEPTOR** button to switch on.<sup>1</sup>

- If headphones are connected to the receiver, disconnect them.

#### 2 Press **RECEPTOR** on the remote control, then press the **SETUP** button.<sup>2</sup>

An on-screen display (OSD) appears on your TV. Use **↑/↓/←/→** and **ENTER** to navigate through the screens and select menu items. Press **RETURN** to confirm and exit the current menu.

- Press **SETUP** at any time to exit the System Setup menu.

#### 3 Select the setting you want to adjust.

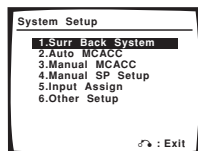

- **Surr Back System** – Specify how you are using your surround back speakers (see *Surround back speaker setting* below).
- **Auto MCACC** – This is a quick and effective automatic surround setup (see *Automatically setting up for surround sound (MCACC)* on page 8).

- **Manual MCACC** – Fine tune your speaker settings and customize the Acoustic Calibration EQ (see *Manual MCACC setup* on page 34).
- **Manual SP Setup** – Specify the size, number, distance and overall balance of the speakers you've connected (see *Manual speaker setup* on page 37).
- **Input Assign** – Specify what you've connected to the digital and component video inputs (see *The Input Assign menu* on page 50).
- **Other Setup** – Make customized settings to reflect how you are using the receiver (see *The Other Setup menu* on page 51).

### Surround back speaker setting

- Default setting: **Normal (SB)**

There are several ways you can use the surround back speaker channels with this system. In addition to a normal home theater setup where they are used for the surround back speakers, they can be used for bi-amping the front speakers or as a separate speaker system in another room.

#### 1 Select 'Surr Back System' from the System Setup menu.

See *Making receiver settings from the System Setup menu* above if you're not already at this screen.

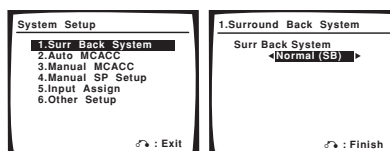

#### 2 Select the surround back speaker setting.

- **Normal (SB)** – Select for normal home theater use with surround back speakers in your main (speaker system A) setup.
- **Second Zone** – Select to use the (surround back) B speaker terminals to listen to stereo playback in another room (see *Second Zone speaker B setup* on page 44).
- **Front Bi-Amp** – Select this setting if you're bi-amping your front speakers (see *Bi-amping your front speakers* on page 44).

#### Note

- Make sure not to switch off the power when using the System Setup menu.
  - The OSD will not appear if you have connected using the HDMI output to your TV. Use component, S-video, or composite connections for system setup.
- 2 You can't use the System Setup menu when the XM Radio input source is selected (in either the main or sub room).

- **MR & S** – Select to use the (surround back) B speaker terminals for an independent system in another room (see *Multi-room listening* on page 46).

### 3 When you're finished, press RETURN.

You return to the System Setup menu.

## Manual MCACC setup

You can use the settings in the Manual MCACC setup menu to make detailed adjustments when you're more familiar with the system. Before making these settings, you should have already completed *Automatically setting up for surround sound (MCACC)* on page 8.

You only need to make these settings once (unless you change the placement of your current speaker system or add new speakers).

### Important

- For some of the settings below, you'll have to connect the setup microphone to the front panel and place it about ear level at your normal listening position. See *Automatically setting up for surround sound (MCACC)* on page 8 if you're unsure how to do this. Also see *Problems when using the Auto MCACC Setup* on page 10 for notes regarding background noise and other possible interference.
- If you're using a subwoofer, switch it on and turn up the volume as necessary.

### Caution

- The test tones used in the MCACC setup are output at high volume.

### 1 Select 'Manual MCACC' from the System Setup menu.

See *Making receiver settings from the System Setup menu* above if you're not already at this screen.

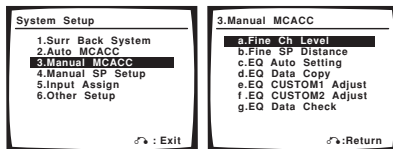

### 2 Select the setting you want to adjust.

If you're doing this for the first time, you might want to make these settings in order.

- **Fine Ch Level** – Make fine adjustments to the overall balance of your speaker system (see *Fine Channel Level* below).
- **Fine SP Distance** – Make precise delay settings for your speaker system (see *Fine Speaker Distance* on page 35).

The last five settings are specifically for customizing the parameters explained in *Acoustic Calibration EQ* below:

- **EQ Auto Setting** – Measure the acoustic characteristics of your room and automatically adjust the frequency balance of your speaker system (see *Setting the Acoustic Calibration EQ automatically* below).
- **EQ Data Copy** – Copy Acoustic Calibration EQ settings for manual adjustment (see *Copying your Acoustic Calibration EQ settings* on page 36).
- **EQ CUSTOM1/2 Adjust** – Make detailed manual adjustments to your custom Acoustic Calibration EQ settings (see *Setting the Acoustic Calibration EQ manually* on page 36).
- **EQ Data Check** – Check the **ALL CH ADJUST**, **FRONT ALIGN** and custom settings using the on-screen display (see *Checking your Acoustic Calibration EQ settings* on page 37).

## Fine Channel Level

- Default setting: **0.0dB** (all channels)

You can achieve better surround sound by properly adjusting the overall balance of your speaker system. The following setting can help you make detailed adjustments that you may not achieve using the *Manual speaker setup* on page 37.

### 1 Select 'Fine Ch Level' from the Manual MCACC setup menu.

After the volume increases to the reference level, test tones will be output.

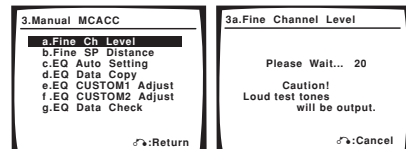

### 2 Select each channel in turn and adjust the levels (+/- 10 dB) as necessary.

Use **←/→** to adjust the volume of the speaker you selected to match the reference speaker.

- The level of the left channel (the primary reference speaker) is fixed at **0.0dB** so that you'll have plenty of room to adjust the other speaker levels.

When it sounds like both tones are the same volume, press **ENTER** to confirm and continue to the next channel.

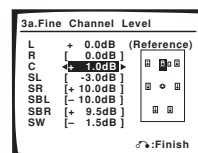

- For comparison purposes, the reference speaker will change depending on which speaker you select.

- If you want to go back and adjust a channel, simply use **↑/↓** to select it.

### 3 When you're finished, press RETURN.

You return to the Manual MCACC setup menu.

## Fine Speaker Distance

- Default setting: **10.0 ft.** (all channels)

For proper sound depth and separation with your system, it is necessary to add a slight bit of delay to some speakers so that all sounds will arrive at the listening position at the same time. The following setting can help you make detailed adjustments that you may not achieve using the *Manual speaker setup* below.

### 1 Select 'Fine SP Distance' from the Manual MCACC setup menu.

The volume increases to the reference level.

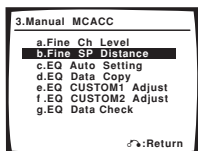

### 2 Adjust the distance of the left channel from the listening position.

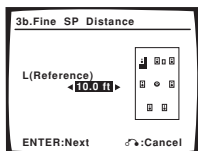

After pressing **ENTER**, test tones will be output.

### 3 Select each channel in turn and adjust the distance as necessary.

Use **←/→** to adjust the delay of the speaker you selected to match the reference speaker. The delay is measured in terms of speaker distance from **0.5** to **45.0** feet.

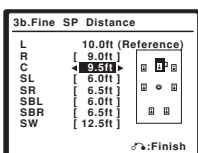

Listen to the reference speaker and use it to measure the target channel. From the listening position, face the two speakers with your arms outstretched pointing at each speaker. Try to make the two tones sound as if they are arriving simultaneously at a position slightly in front of you and between your arm span.<sup>1</sup>

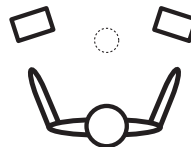

When it sounds like the delay settings are matched up, press **ENTER** to confirm and continue to the next channel.

- For comparison purposes, the reference speaker will change depending on which speaker you select.
- If you want to go back and adjust a channel, simply use **↑/↓** to select it.

### 4 When you're finished, press RETURN.

You return to the Manual MCACC setup menu.

## Acoustic Calibration EQ

Acoustic Calibration Equalization is a kind of room equalizer for your speakers (excluding the subwoofer). It works by measuring the acoustic characteristics of your room and neutralizing the ambient characteristics that can color the original source material. This provides a 'flat' equalization setting. If you're not satisfied with the automatic adjustment, you can also adjust these settings manually to get a frequency balance that suits your tastes.

### Setting the Acoustic Calibration EQ automatically

If you have already completed *Automatically setting up for surround sound (MCACC)* on page 8, **ALL CH ADJUST** and **FRONT ALIGN** (below) should already be set. Therefore, if you want to adjust your settings manually, you can skip to *Setting the Acoustic Calibration EQ manually* below.

### 1 Select 'EQ Auto Setting' from the Manual MCACC setup menu.

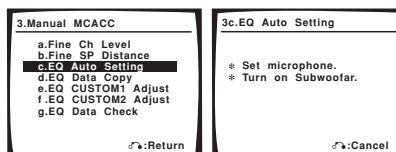

- Make sure the microphone is connected.

#### Note

<sup>1</sup> If you can't seem to achieve this by adjusting the distance setting, you may need to change the angle of your speakers very slightly.

- See *Problems when using the Auto MCACC Setup* on page 10 for notes regarding high background noise levels and other possible interference.

## 2 Wait for the EQ Auto Setting to finish.

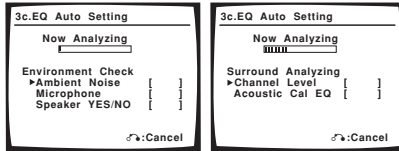

As the receiver outputs test tones, the frequency balance is adjusted automatically for the following settings:

- **ALL CH ADJUST** – A 'flat' setting where all the speakers are set individually so no special weighting is given to any one channel.
- **FRONT ALIGN** – All speakers are set in accordance with the front speaker settings (no equalization is applied to the front left and right channels).

You return to the Acoustic Cal EQ setup menu after the Acoustic Calibration Equalization is set.

### Copying your Acoustic Calibration EQ settings

If you want to manually adjust the Acoustic Calibration EQ (see *Setting the Acoustic Calibration EQ manually* below), we recommend copying the **ALL CH ADJUST** or the **FRONT ALIGN** settings from the **EQ Auto** setup above (or from *Automatically setting up for surround sound (MCACC)* on page 8) to one of the custom settings. Instead of just a flat EQ curve, this will give you a reference point from which to start.

#### 1 Select 'EQ Data Copy' from the Manual MCACC setup menu.

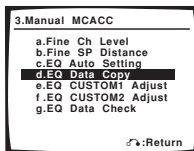

#### 2 Select CUSTOM1 or CUSTOM2 then use ←/→ to select the setting you want to copy.

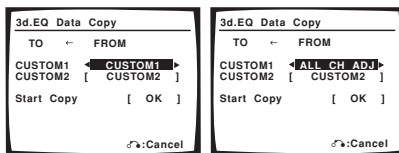

- You can also copy from one custom setting to another. For more on the **ALL CH ADJUST** and **FRONT ALIGN** settings, see *Setting the Acoustic Calibration EQ automatically* above.

#### 3 Select 'OK' to copy and confirm.

### Setting the Acoustic Calibration EQ manually

Before manually adjusting the Acoustic Calibration EQ, we recommend copying the **ALL CH ADJUST** or the **FRONT ALIGN** settings from the auto setup above (or from *Automatically setting up for surround sound (MCACC)* on page 8) to one of the custom settings. Instead of just a flat EQ curve, this will give you a reference point from which to start (see *Copying your Acoustic Calibration EQ settings* above for how to do this).

#### 1 Select 'EQ CUSTOM1 Adjust or EQ CUSTOM2 Adjust' from the Manual MCACC setup menu.

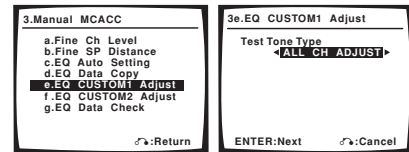

#### 2 Select which method you would like to use to adjust the overall frequency balance.

It is best to choose whichever one you copied to the custom setting in *Copying your Acoustic Calibration EQ settings* above.

- **ALL CH ADJUST** – All the speakers can be set independently so no special weighting is given to any one channel. When adjusting, test tones will sound for each individual channel.
- **FRONT ALIGN** – Speakers are set in accordance with the front speaker settings. The sound of the test tone will alternate between the left front (reference) speaker and the target speaker.

#### 3 Select the channel(s) you want and adjust to your liking.

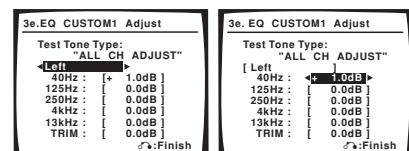

Use ←/→ to select the channel.

Use ↑/↓ to select the frequency and ←/→ to boost or cut the EQ. When you're finished, go back to the top of the screen and use ←/→ to select the next channel.

- The front speakers can't be adjusted if you selected **FRONT ALIGN**.
- The **OVER!** indicator shows in the display if the frequency adjustment is too drastic and might distort. If this happens, bring the level down until **OVER!** disappears from the display.

## Tip

- Changing the frequency curve of one channel too drastically will affect the overall balance. If the speaker balance seems uneven, you can raise or lower channel levels using test tones with the **TRIM** feature. Use  $\uparrow/\downarrow$  to select **TRIM** then use  $\leftarrow/\rightarrow$  to raise or lower the channel level for the current speaker.

### 4 When you're finished, press RETURN.

You return to the Manual MCACC setup menu.

### Checking your Acoustic Calibration EQ settings

After you have completed an automatic or manual Acoustic Calibration EQ adjustment, you can check the **ALL CH ADJUST**, **FRONT ALIGN** and custom settings using the on-screen display.

### 1 Select 'EQ Data Check' from the Manual MCACC setup menu.

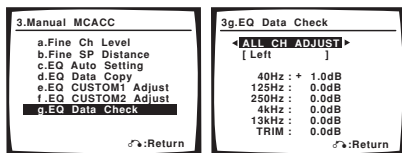

### 2 Select the setting you want to check.

- It is useful to do this while a source is playing so you can compare the different settings.

### 3 Select the channels you want, pressing ENTER when you're finished checking each one.

### 4 When you're finished, press RETURN.

You return to the Manual MCACC setup menu.

## Manual speaker setup

This receiver allows you to make detailed settings to optimize the surround sound performance. You only need to make these settings once (unless you change the placement of your current speaker system or add new speakers.).

These settings are designed to fine-tune your system, but if you're satisfied with the settings made in *Automatically setting up for surround sound (MCACC)* on page 8, it isn't necessary to make all of these settings.

## Caution

- The test tones used in the System Setup are output at high volume.

## Note

1 If you select **SMALL** for the front speakers the subwoofer will automatically be fixed to **YES**. Also, the center, surround, and surround back speakers can't be set to **LARGE** if the front speakers are set to **SMALL**. In this case, all bass frequencies are sent to the subwoofer.

### 1 Select 'Manual SP Setup' then press ENTER.

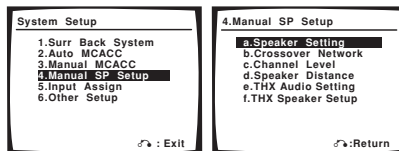

### 2 Select the setting you want to adjust.

If you are doing this for the first time, you may want to adjust these settings in order:

- **Speaker Setting** – Specify the size and number of speakers you've connected (page 37).
- **Crossover Network**– Specify which frequencies will be sent to the subwoofer (page 38).
- **Channel Level** – Adjust the overall balance of your speaker system (page 38).
- **Speaker Distance** – Specify the distance of your speakers from the listening position (page 39).
- **THX Audio Setting** – Specify the distance of your surround back speakers from each other (page 39).
- **THX Speaker Setup** – Specify whether or not you have a THX speaker system (page 40).

### 3 Make the adjustments necessary for each setting, pressing RETURN to confirm after each screen.

## Speaker Setting

Use this setting to specify your speaker configuration (size, number of speakers). It is a good idea to make sure that the settings made in *Automatically setting up for surround sound (MCACC)* on page 8 are correct.

### 1 Select 'Speaker Setting' from the Manual SP Setup menu.

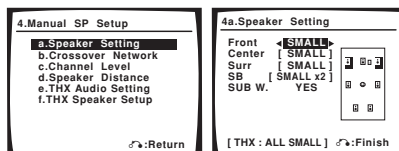

### 2 Choose the set of speakers that you want to set then select a speaker size.

Use  $\leftarrow/\rightarrow$  to select the size (and number) of each of the following speakers:

- **Front** – Select **LARGE** if your front speakers reproduce bass frequencies effectively, or if you didn't connect a subwoofer. Select **SMALL** to send the bass frequencies to the subwoofer.<sup>1</sup>

- **Center** – Select **LARGE** if your center speaker reproduces bass frequencies effectively, or select **SMALL** to send bass frequencies to the other speakers or subwoofer. If you didn't connect a center speaker, choose **NO** (the center channel is sent to the other speakers).
- **Surr** – Select **LARGE** if your surround speakers reproduce bass frequencies effectively. Select **SMALL** to send bass frequencies to the other speakers or subwoofer. If you didn't connect surround speakers choose **NO** (the sound of the surround channels is sent to the other speakers).
- **SB** – Select the number of surround back speakers you have (one, two or none). Select **LARGE** if your surround back speakers reproduce bass frequencies effectively. Select **SMALL** to send bass frequencies to the other speakers or subwoofer. If you didn't connect surround back speakers choose **NO**.<sup>1</sup>
- **SUB W.** – LFE signals and bass frequencies of channels set to **SMALL** are output from the subwoofer when **YES** is selected (see notes below). Choose the **PLUS** setting if you want the subwoofer to output bass sound continuously or you want deeper bass (the bass frequencies that would normally come out the front and center speakers are also routed to the subwoofer). If you did not connect a subwoofer choose **NO** (the bass frequencies are output from other speakers).

### 3 When you're finished, press RETURN.

You return to the Manual SP Setup menu.

#### Tip

- If you have a subwoofer and like lots of bass, it may seem logical to select **LARGE** for your front speakers and **PLUS** for the subwoofer. This may not, however, yield the best bass results. Depending on the speaker placement of your room you may actually experience a decrease in the amount of bass due to low frequency cancellations. In this case, try changing the position or direction of speakers. If you can't get good results, listen to the bass response with it set to **PLUS** and **YES** or the front speakers set to **LARGE** and **SMALL** alternatively and let your ears judge which sounds best. If you're having problems, the easiest option is to route all the bass sounds to the subwoofer by selecting **SMALL** for the front speakers.

## Crossover Network

- Default setting: **80Hz**

This setting decides the cutoff between bass sounds playing back from the speakers selected as **LARGE**, or the subwoofer, and bass sounds playing back from those selected as **SMALL**. It also decides where the cutoff will be for bass sounds in the LFE channel.<sup>2</sup>

### 1 Select 'Crossover Network' from the Manual SP Setup menu.

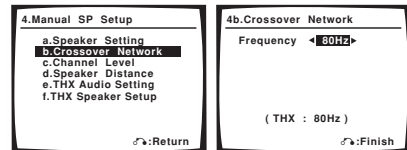

### 2 Choose the frequency cutoff point.

Frequencies below the cutoff point will be sent to the subwoofer (or **LARGE** speakers).

### 3 When you're finished, press RETURN.

You return to the Manual SP Setup menu.

## Channel Level

Using the channel level settings, you can adjust the overall balance of your speaker system, an important factor when setting up a home theater system.

### 1 Select 'Channel Level' from the Manual SP Setup menu.

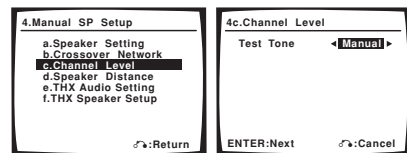

### 2 Select a setup option.

- **Manual** – Move the test tone manually from speaker to speaker and adjust individual channel levels.
- **Auto** – Adjust channel levels as the test tone moves from speaker to speaker automatically.

#### Note

- 1 If the surround speakers are set to **NO**, the surround back speakers will automatically be set to **NO**.
- 1 If you selected **Second Zone** or **Front Bi-Amp** (in *Surround back speaker setting* on page 33) you can't adjust the surround back settings.
- 1 If you select one surround back speaker only, make sure that speaker is hooked up to the left surround back terminal.
- 2 For more on selecting the speaker sizes, see *Speaker Setting* above.
- If you're using a THX speaker setup, confirm that the crossover frequency is set to **80Hz**.

### 3 Confirm your selected setup option.

The test tones will start after you press **ENTER**.

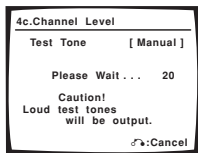

### 4 Adjust the level of each channel using ←/→.

If you selected **Manual**, use ↑/↓ to switch speakers. The **Auto** setup will output test tones in the order shown on-screen:

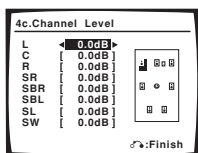

Adjust the level of each speaker as the test tone is emitted.<sup>1</sup>

### 5 When you're finished, press RETURN.

You return to the Manual SP Setup menu.



#### Tip

- You can change the channel levels at any time by using **EFFECT/CH SEL** and **+/-** on the remote control. You can set two channel levels: one for **MULTI CH IN** and one for the listening modes.

## Speaker Distance

For good sound depth and separation from your system, you need to specify the distance of your speakers from the listening position. The receiver can then add the proper delay needed for effective surround sound.

### 1 Select 'Speaker Distance' from the Manual SP Setup menu.

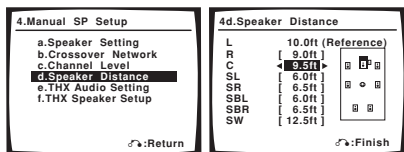

### 2 Adjust the distance of each speaker using ←/→.

You can adjust the distance of each speaker in 0.5 foot increments.

#### Note

- If you are using a Sound Pressure Level (SPL) meter, take the readings from your main listening position and adjust the level of each speaker to 75 dB SPL (C-weighting/slow reading).
  - The subwoofer test tone is output at low volumes. You may need to adjust the level after testing with an actual soundtrack.
- If you don't have surround back speakers, or just have one, you won't be able to select this setting (**Cannot select** shows in the display).

### 3 When you're finished, press RETURN.

You return to the Manual SP Setup menu.



#### Tip

- For best surround sound, make sure the surround back speakers are the same distance from the listening position.

## THX Audio Setting

For the most effective results when using the THX Select2 Cinema and THX MusicMode listening modes (see *Using the Home THX modes* on page 27) with the Advanced Speaker Array (ASA) system (see *About THX* on page 68), it is required that you make the setting. See *THX speaker system setup* on page 19 for more on THX speaker placement.<sup>2</sup>

### 1 Select 'THX Audio Setting' from the Manual SP Setup menu.

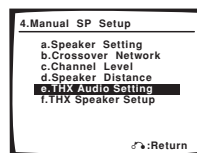

### 2 Specify the distance of your surround back speakers from each other.

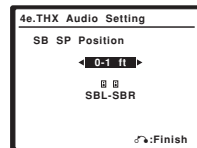

- 0-1 ft** – Surround speakers within 1 foot apart (best for THX surround sound).
- 1- 4 ft** – Surround speakers between 1 and 4 feet apart.
- 4 ft <** – Surround speakers more than 4 feet apart.

### 3 When you're finished, press RETURN.

You will return to the Manual SP Setup menu.

## THX Speaker Setup

If you have a complete THX speaker system, you should make this setting for the most effective results when using surround sound. See *THX speaker system setup* on page 19 for more on using a THX speaker system.

**1 Select 'THX Speaker Setup' from the Manual SP Setup menu.**

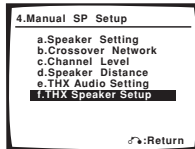

**2 Specify whether or not you are using a THX speaker system.**



- **YES** – All speaker settings are fixed to **SMALL** (see *Speaker Setting* on page 37) during the Auto MCACC setup.
- **NO** – Individual speaker sizes are determined according to the Auto MCACC setup.

**3 When you're finished, press RETURN.**

You will return to the Manual SP Setup menu.



## Chapter 8: Other connections

### ⚠ Caution

- Make sure the power is switched off before making or changing the connections.

### Using XM Radio

XM is the leading provider of satellite radio service in the United States. Through two high-power satellites, *Rock* and *Roll*, XM Radio service offers over 150 channels of music, news, talk, sports and children's programming on a monthly subscription basis. XM Radio offers consumers clear sound quality from digital signal radios, an extensive variety of programming and nationwide coverage. Visit [www.xmradio.com](http://www.xmradio.com) for more details on this service.

### Connecting your XM Radio receiver

After purchasing a Connect-and-Play™ antenna (sold separately), you will also need to activate the XM Radio digital radio service to receive broadcasts.<sup>1</sup>

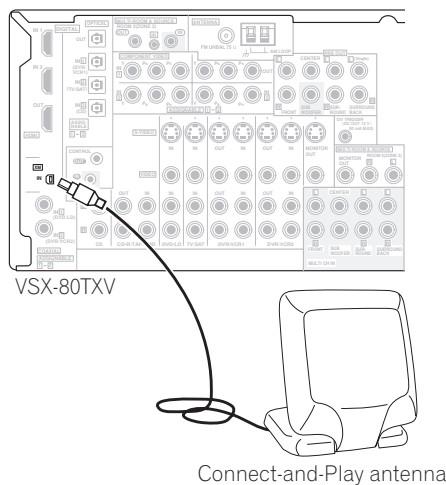

#### 1 Connect an XM Radio Connect-and-Play™ antenna to the XM Radio jack on the rear of this receiver.

You will also need to activate the XM Radio service.

### Note

1 Hardware and required basic monthly subscription sold separately. Premium Channel available at additional monthly cost. Installation costs and other fees and taxes, including a one-time activation fee may apply. Subscription fee is consumer only. All fees and programming subject to change. Channels with frequent explicit language are indicated with an XL. Channel blocking is available for XM radio receivers by calling 1-800-XMRADIO. Subscriptions subject to Customer Agreement available at [xmradio.com](http://xmradio.com). Only available in the 48 contiguous United States.

2 It's easiest if you have your TV switched on to take advantage of the OSDs. You can, however, use just the front panel display to do everything if you prefer.

3 Select **XM000 (RADIO ID)** from the on-screen display to check the Radio ID of the Connect-and-Play antenna.

#### 2 Press **XM RADIO (SHIFT+TUNER)** to switch to the XM RADIO input.

For best reception, you may need to move the Connect-and-Play™ antenna near a window (the southernmost window should produce the best results).

- If after pressing **XM RADIO** the display shows **Check Antenna**, try disconnecting the antenna and reconnecting.

### Listening to XM Radio

After connecting, you will be able to use this receiver to select channels and navigate categories using the on-screen display.<sup>2</sup> The information displayed is as follows:

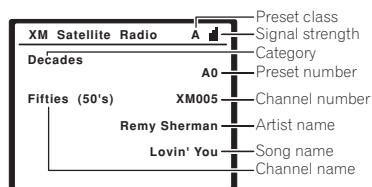

### Selecting channels and browsing by genre

From the XM Channel Guide, you can browse XM Radio channels in the order that they appear, or you can narrow your channel search by genre.

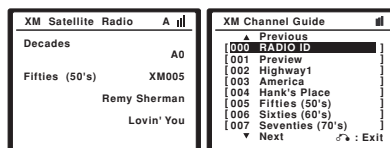

#### • Press **↑/↓** to display the XM Channel Guide then **↑/↓/←/→** and **ENTER** to select the channel of the XM radio broadcast you want to hear.

- To browse by genre, first press **CATEGORY**, use **↑/↓/←/→** to select a genre then press **ENTER**.<sup>3</sup>
- To cancel and exit any time, press **RETURN**.

### ⚙ Tip

- You can select channels directly by pressing **D.ACCESS** then the three-digit channel number.

- You can press **DISP** to change XM Radio information in the front panel display.
- The currently selected channel is automatically chosen (without pressing **ENTER**) after 5 seconds.

### Using XM HD Surround

XM HD Surround uses Neural Surround™ technology to achieve optimal surround sound from XM radio.

- **While listening to XM Radio, press AUTO SURR for XM HD Surround listening.**

See *About Neural Surround™* below for more on this.

### About Neural Surround™

Neural Surround™ represents the latest advancement in surround technology and has been adopted by XM Satellite Radio for digital radio broadcasts of surround recordings and live events.

Neural Surround™ employs psychoacoustic frequency domain processing which allows delivery of a more detailed sound stage with superior localization of surround elements. System playback is scalable from stereo up to state-of-the-art multichannel surround.

*Neural Surround™ is trademark owned by Neural Audio Corporation.*

### Saving channel presets

This receiver can memorize up to 30 channels, stored in three banks, or classes, (A, B and C) of 10 stations each.

#### 1 Select the channel you want to memorize.

See *Selecting channels and browsing by genre* above.

#### 2 Press T.EDIT.

The display shows a blinking memory class.

#### 3 Press CLASS to select one of the three classes then press ←/→ to select the channel preset you want.

You can also use the number buttons to select a preset.

- The default for all presets is **XM001**.

#### 4 Press ENTER.

After pressing **ENTER**, the preset class and number stop blinking and the receiver stores the XM channel.

### Listening to channel presets

You will need to have some presets stored to do this.

#### 1 Press CLASS to select the class in which the channel is stored.

Press repeatedly to cycle through classes A, B and C.

#### 2 Press ←/→ to select the channel preset you want.

- You can also use the number buttons on the remote control to recall the channel preset.

*Connect & Play™, XM-Ready® and The Ultimate Playlist are trademarks of XM Satellite Radio Inc. ©2005 XM Satellite Radio Inc. All rights reserved. All other trademarks are the property of their respective owners.*

## Connecting using HDMI

If you have a HDMI or DVI (with HDCP) equipped component, you can connect it to this receiver using a commercially available HDMI cable.

The HDMI connection transfers uncompressed digital video, as well as almost every kind of digital audio that the connected component is compatible with, including DVD-Video, DVD-Audio (see below for limitations), Video CD/Super VCD, CD and MP3.

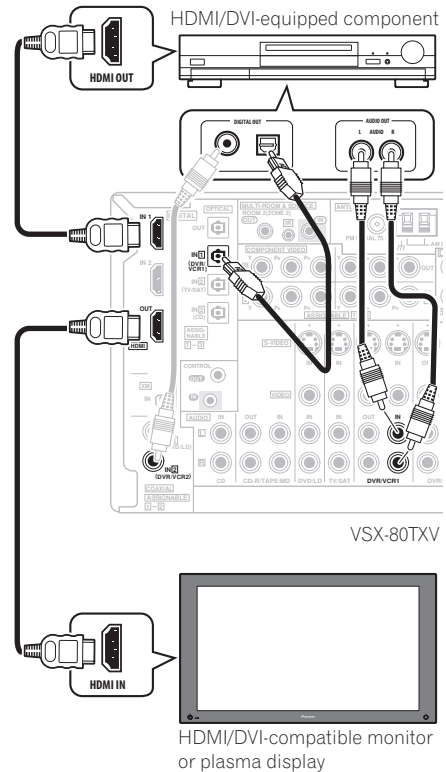

#### 1 Use an HDMI cable to connect the HDMI IN 1/2 interconnect on this receiver to an HDMI output on your HDMI component.

HDMI appears on the front panel when an HDMI-equipped component is connected.

#### 2 Use an HDMI cable to connect the HDMI OUT interconnect on this receiver to an HDMI interconnect on a HDMI-compatible monitor.

- The arrow on the cable connector body should be facing right for correct alignment with the connector on the player.

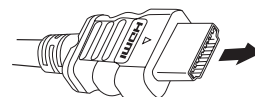

### 3 To hear audio from your HDMI component through this system, make analog and/or digital connections as necessary.

On the rear panel, you must connect to the audio jacks from a set of audio/video inputs (for example, **DVR/VCR1** or **DVR/VCR2** as shown in the illustration).

- Without this connection, HDMI audio will still be output from your TV or plasma display (though no sound will be heard from this receiver).

### 4 Assign the HDMI input(s) you connected to the corresponding input source.

After connecting, you must specify which input(s) you are using for your HDMI component in *Assigning the HDMI inputs* on page 51.

### 5 Use the input source buttons to select the input source you assigned in the previous step, then press **SIGNAL SEL** to select the audio input signal.

You can also use the front panel controls to do this (see *Choosing the input signal* on page 29).

- If the video signal does not appear on your TV or plasma display, try adjusting the resolution settings on your component or display. Note that some components (such as video game units) have resolutions that may not be displayed. In this case, use an (analog) S-video or composite connection.

## About HDMI

HDMI (High Definition Multimedia Interface) supports both video and audio on a single digital connection for use with DVD players, DTV, set-top boxes, and other AV devices. HDMI was developed to provide the technologies of High Bandwidth Digital Content Protection (HDCP) as well as Digital Visual Interface (DVI) in one specification. HDCP is used to protect digital content transmitted and received by DVI-compliant displays.

HDMI has the capability to support standard, enhanced, or high-definition video plus standard to multi-channel surround-sound audio. HDMI features include uncompressed digital video, a bandwidth of up to 2.2 gigabytes per second (with HDTV signals), one connector (instead of several cables and connectors), and communication between the AV source and AV devices such as DTVs.

*HDMI, the **HDMI** logo and High-Definition Multimedia Interface are trademarks or registered trademarks of HDMI licensing LLC.*

## Connecting the multichannel analog inputs

For DVD Audio and SACD playback, your DVD player may have 5.1, 6.1 or 7.1 channel analog outputs (depending on whether your player supports surround back channels).<sup>1</sup> Make sure that the player is set to output multichannel analog audio.

### 1 Connect the front, surround, center and subwoofer outputs on your DVD player to the corresponding **MULTI CH** input jack on this receiver.

- Use standard RCA/phono jack cables for the connections.

### 2 If your DVD player also has outputs for surround back channels, connect these to the corresponding **MULTI CH** input jacks on this receiver.

- Use standard RCA/phono jack cables for the connections.
- If there is a single surround back output, connect it to the **SURROUND BACK L (Single)** jack on this receiver.

## Selecting the multichannel analog inputs

If you have connected a decoder or a DVD player as above, you must select the analog multichannel inputs for surround sound playback.<sup>2</sup>

### 1 Make sure you have set the playback source to the proper output setting.

For example, you might need to set your DVD player to output multichannel analog audio.

### 2 Press **MULTI CH IN** (front panel).

- Depending on the DVD player you're using, the analog output level of the subwoofer channel may be too low. In this case switch the receiver into standby, then press **STANDBY/ON** while holding down **SBCh PROCESSING** on the front panel. This switches between **SW IN +10dB** (increase of 10 decibels) and **SW IN 0dB** (default) in the subwoofer channel.

#### Note

<sup>1</sup> To listen to multichannel analog audio you'll need to select **MULTI CH IN** (see *Selecting the multichannel analog inputs* above for more on this).

<sup>2</sup> • When playback from the multichannel inputs is selected, you can't use the sound processing features, **SIGNAL SELECT**, or any of the listening modes (including **STEREO** and the surround back channel processing).

- When playback from the multichannel inputs is selected, only the volume and channel levels can be set.
- You can't listen to your speaker B (Second Zone) system during playback from the multichannel inputs.

## Second Zone speaker B setup

### Caution

- Before making or changing the connections, switch off the power and disconnect the power cord from the power outlet. Plugging in components should be the last connection you make with your system.
- Be careful not to allow any contact between speaker wires from different terminals.
- You can use speakers with a nominal impedance between 6  $\Omega$  to 16  $\Omega$  (please see *Switching the speaker impedance* on page 55 if you plan to use speakers with an impedance of less than 8  $\Omega$ ).

After selecting **2nd Zone** in *Surround back speaker setting* on page 33, you can use the speakers connected to the (surround back) B speaker terminals on the rear panel to listen to stereo playback in another room. See *Switching the speaker system* below for the listening options with this setup.

### 1 Connect a pair of speakers to the surround back speaker terminals on the rear panel.

Connect them the same way you connected your speakers in *Installing your speaker system* on page 17. Make sure to review *Placing the speakers* on page 18 when placing the speakers in another room.

### 2 Select '2nd Zone' from the 'Surr Back System' menu. See *Surround back speaker setting* on page 33 to do this.

## Switching the speaker system

If you selected **2nd Zone** in *Surround back speaker setting* on page 33, three speaker system settings are possible using the **SPEAKERS** button. If you selected **Normal (SB)** or **Front Bi-Amp**, the button will simply switch your main speaker system on or off. The options below are for the **2nd Zone** setting only.<sup>1</sup>

### • Use the **SPEAKERS** button on the front panel to select a speaker system setting.

As mentioned above, if you have selected **Normal (SB)**, the button will simply switch your main speaker system (A) on or off.

Press repeatedly to choose a speaker system option:

- **SP▶A** – Sound is output from speaker system A and the same signal is output from the pre-out terminals.
- **SP▶B** – Sound is output from the two speakers connected to speaker system B. Multichannel sources will not be heard. The same signal is output from the surround back channel pre-out terminals.

### Note

<sup>1</sup> • The subwoofer output depends on the settings you made in *Manual speaker setup* on page 37. However, if **SP▶B** is selected above, no sound is heard from the subwoofer (the LFE channel is not downmixed).

- Depending on the settings in *Surround back speaker setting* on page 33 output from the surround back pre-out terminals may change.
- All speaker systems (except **2nd Zone** connections) are switched off when headphones are connected.

- **SP▶AB** – Sound is output from speaker system A (up to 5 channels, depending on the source), the two speakers in speaker system B, and the subwoofer. The sound from speaker system B will be the same as the sound from speaker system A (multichannel sources will be downmixed to 2 channels).
- **SP▶** (off) – No sound is output from the speakers. The same sound is output from the pre-out terminals (including from your subwoofer, if connected) as when selecting speaker system A (above).

## Bi-amping your front speakers

Bi-amping is when you connect the high frequency driver and low frequency driver of your speakers to different amplifiers (in this case, to both front and surround back terminals) for better crossover performance. Your speakers must be bi-ampable to do this (having separate terminals for high and low) and the sound improvement will depend on the kind of speakers you're using.

### 1 Connect your speakers as shown below.

This illustration below shows the connections for bi-amping your front left speaker. Hook up your front right speaker in the same way.

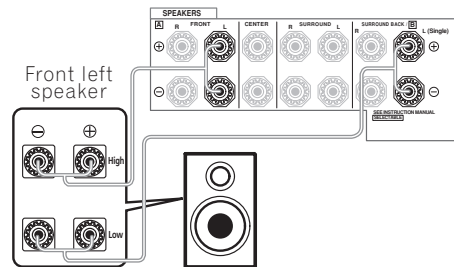

Since both front and surround back speaker terminals output the same audio, it doesn't matter which set (front or surround back) is powering which part (**High** or **Low**) of the speaker.

- Make sure that the + / – connections are properly inserted.

### 2 Select the 'Front Bi-Amp' setting from the 'Surr Back System' menu.

See *Surround back speaker setting* on page 33 to specify how you're using the surround back speaker terminals.

### Caution

- Most speakers with both **High** and **Low** terminals have two metal plates that connect the **High** to the **Low** terminals. These must be removed when you are bi-amping the speakers or you could severely damage the amplifier. See your speaker manual for more information.
- If your speakers have a removable crossover network, make sure you do not remove it for bi-amping. Doing so may damage your speakers.

## Bi-wiring your speakers

The reasons for bi-wiring are basically the same as bi-amping, but additionally, interference effects within the wire could be reduced, producing better sound. Again, to do this your speakers must be bi-wireable (that is they must have separate terminals for the high and low frequencies). When bi-wiring, make sure you've selected **Normal (SB)** or **2nd Zone** in *Surround back speaker setting* on page 33.

- **To bi-wire a speaker, connect two speaker cords to the speaker terminal on the receiver.**

Using a banana plug for the second connection is recommended.

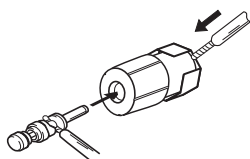

### Caution

- Make sure you use a parallel (not series, which are fairly uncommon) connection when bi-wiring your speakers.
- Don't connect different speakers from the same terminal in this way.

## Connecting additional amplifiers

This receiver has more than enough power for any home use, but it's possible to add additional amplifiers to every channel of your system using the pre-outs. Make the connections shown below to add amplifiers to power your speakers.

- Before making or changing the connections, switch off the power and disconnect the power cord from the AC outlet.

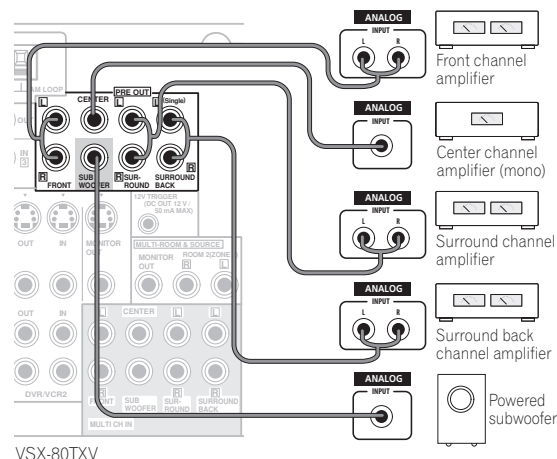

VSX-80TXV

- You can use the additional amplifier on the surround back channel pre-outs for a single speaker as well. In this case plug the amplifier into the left (**L (Single)**) terminal only.
- The sound from the surround back terminals will depend on how you have configured the *Surround back speaker setting* on page 33.
- To hear sound only from the pre-outs, switch the speaker system to **OFF**, or simply disconnect any speakers that are connected directly to the receiver.
- If you're not using a subwoofer, change the front speaker setting (see *Speaker Setting* on page 37) to **LARGE**.

## Multi-room listening

This receiver can power two independent systems in separate rooms after you have made the proper multi-room connections.<sup>1</sup> Different sources can be playing in both rooms at the same time or, depending on your needs, the same source can also be used. The main and sub rooms have independent power (the main room power can be off while the sub room is on) and the sub room can be controlled by the front panel controls. However, you may need to specify the volume setting in *Multi-Room and IR receiver setup* on page 53.

## Making multi-room connections

It is possible to make these connections if you have a separate TV and speakers for your sub room. You will also need a separate amplifier if you are not using the SurrBack System setup (see below). There are two multi-room setups possible with this system:

### Basic multi-room setup

- Connect a separate amplifier to the **MULTI-ROOM & SOURCE ROOM 2** jacks and a TV monitor to the **MULTI-ROOM & SOURCE MONITOR OUT** jacks, both on the rear of this receiver.

You should have a pair of speakers attached to the sub room amplifier as shown in the illustration below.

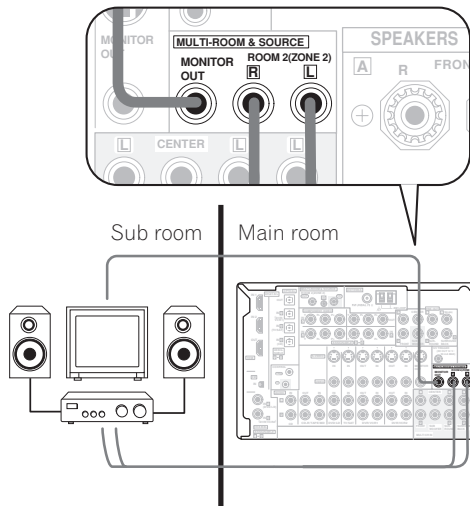

### Surround Back System multi-room setup

You must select **MR&S** in *Surround back speaker setting* on page 33 to use this setup. Note that the sound in the sub room will be temporarily interrupted when controlling the main room (for example, changing the input source or starting playback).

- Connect a TV monitor to the **MULTI-ROOM & SOURCE MONITOR OUT** jacks on the rear of this receiver.

You should have a pair of speakers attached to the surround back speaker terminals as shown below.

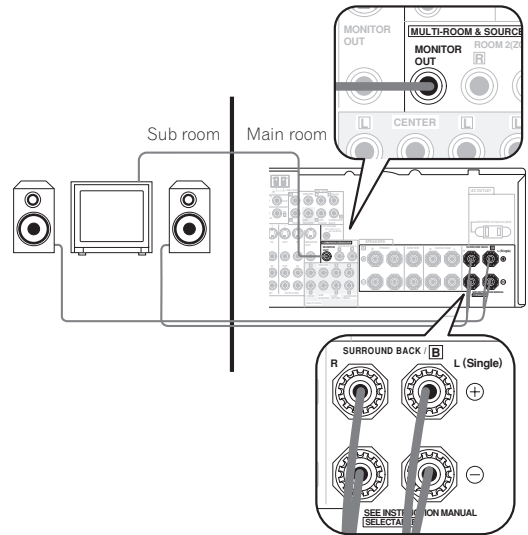

### Using the multi-room controls

The following steps use the front panel controls to adjust the sub room volume and select sources. See *Multi-room remote controls* below when using the remote control.

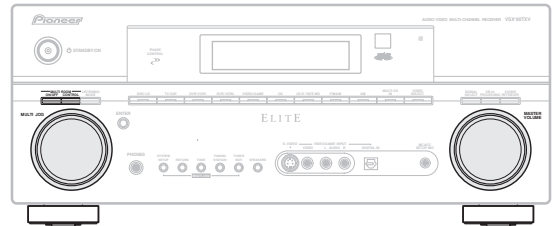

- 1 Press the **MULTI ROOM ON/OFF** button on the front panel.

The **MULTI ROOM** indicator lights and **MR&S ON** appears in the front panel display to indicate the multi-room control has been switched on.

#### Note

<sup>1</sup> Note that you will only be able to play analog sources (such as composite video) in the sub room.

## Other connections

### 2 Press CONTROL.

Make sure that any operations for the sub room are done while **MULTI-ROOM** shows in the display. If **MULTI-ROOM** is not showing, the front panel controls affect the main room only.

### 3 Use the MULTI JOG dial to select the source for the room you have selected.

For example, **CD** sends the source connected to the **CD** inputs to the sub room.

- If you select **TUNER**, you can use the front panel **TUNER** controls to select a preset station (see *Saving station presets* on page 31 if you're unsure how to do this).<sup>1</sup>
- You can't use the XM Radio function when using the multi-room feature.

### 4 Use the MASTER VOLUME dial to adjust the volume.

This is only possible if you selected the **VARIABLE** volume control in *Multi-Room and IR receiver setup* on page 53.<sup>2</sup>

### 5 When you're finished, press CONTROL again to return to the main room controls.

You can also press the **MULTI ROOM ON/OFF** button on the front panel to switch off all output to the sub room.<sup>3</sup>

## Multi-room remote controls

The following table shows the possible multi-room remote controls:

Button	What it does
<b>SHIFT + RECEIVER</b>	Selects the sub room.
	Switches power on/off in the sub room.
<b>INPUT SELECT</b>	Use to select the input source in the sub room.
<b>Input source buttons</b>	Use to select the input source directly (this may not work for some functions) in the sub room.
<b>VOL +/-</b>	Use to set the listening volume in the sub room.

### Note

<sup>1</sup> The tuner cannot be tuned to more than one station at a time. Therefore, changing the station in one room also changes the station in the other room. Please be careful not to change stations when recording a radio broadcast.

<sup>2</sup> The volume levels of the main and sub room are independent.

<sup>3</sup> You won't be able to switch the main room off completely unless you've switched off the multi-room control first.

- If you don't plan to use the multi-room feature for awhile, turn off the power in both the main and sub room so that this receiver is in standby.
- Remote operation may not be possible if direct light from a strong fluorescent lamp is shining on the IR receiver remote sensor window.
- Note that other manufacturers may not use the IR terminology. Refer to the manual that came with your component to check for IR compatibility.
- If using two remote controls (at the same time), the IR receiver's remote sensor takes priority over the remote sensor on the front panel.

## Connecting an IR receiver

If you keep your stereo components in a closed cabinet or shelving unit, you can use an optional IR receiver (such as a Niles or Xantech unit) to control your system instead of the remote sensor on the front panel of this receiver.<sup>4</sup> You may need to specify your IR receiver type in *Multi-Room and IR receiver setup* on page 53.

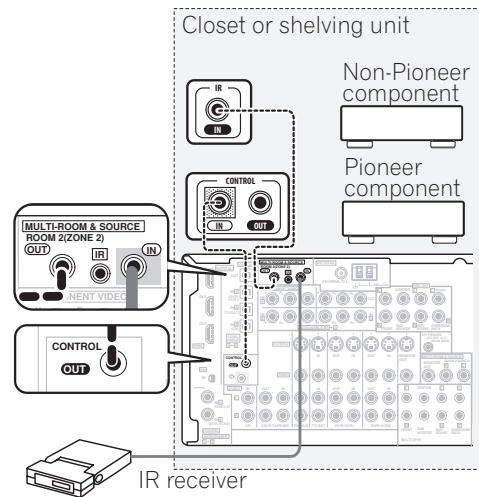

**1** Connect the IR receiver sensor to the **MULTI-ROOM & SOURCE IR IN** jack on the rear of this receiver.

**2** Connect the **IR IN** jack of another component to the **MULTI-ROOM & SOURCE IR OUT** jack on the rear of this receiver to link it to the IR receiver.

Please see the manual supplied with your IR receiver for the type of cable necessary for the connection.

- If you want to link a Pioneer component to the IR receiver, see *Operating other Pioneer components with this unit's sensor* on page 61 to connect to the **CONTROL** jacks instead of the **IR OUT** jack.

## Switching components on and off using the 12 volt trigger

You can connect a component in your system (such as a screen or projector) to this receiver so that it switches on or off using a 12 volt trigger when you select an input function. However, you must specify which input functions switch on the trigger using the *12 Volt Trigger setup* on page 53. Note that this will only work with components that have a standby mode.

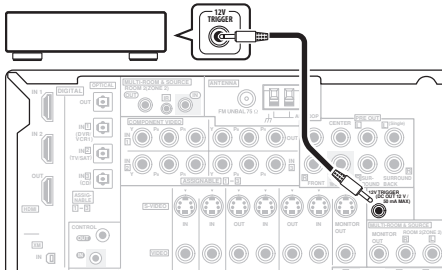

- **Connect the 12V TRIGGER jack of this receiver to the 12V trigger of another component.**

Use a cable with a mono mini-plug on each end for the connection.

- The trigger maximum power is DC OUT 12V/50mA.

After you've specified the input functions that will switch on the trigger, you'll be able to switch the component on or off just by pressing the input function(s) you've set in *12 Volt Trigger setup* on page 53.

## Using this receiver with a Pioneer plasma display

If you have a Pioneer plasma display, you can use an SR+ cable<sup>1</sup> to connect it to this unit and take advantage of various convenient features, such as automatic video input switching of the plasma display when the input is changed.<sup>2</sup>

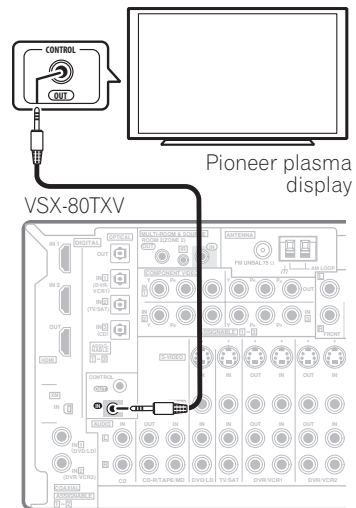

### Important

- If you connect to a Pioneer plasma display using an SR+ cable, you will need to point the remote control at the plasma display remote sensor to control the receiver. In this case, you won't be able to control the receiver using the remote control if you switch the plasma display off.
- Before you can use the extra SR+ features, you need to make a few settings in the receiver. See *The Input Assign menu* on page 50 and *SR+ Setup for Pioneer plasma displays* on page 52 for detailed instructions.

### Note

<sup>1</sup> The 3-ringed SR+ cable from Pioneer is commercially available under the part number ADE7095. Contact the Pioneer Customer Support division for more information on obtaining an SR+ cable (you can also use a commercially available 3-ringed mini phone plug for the connection).

<sup>2</sup> This receiver is compatible with all SR+ equipped Pioneer plasma displays from 2003 onward.



- Use a 3-ringed miniplug SR+ cable to connect the **CONTROL IN** jack of this receiver with the **CONTROL OUT** jack of your plasma display.

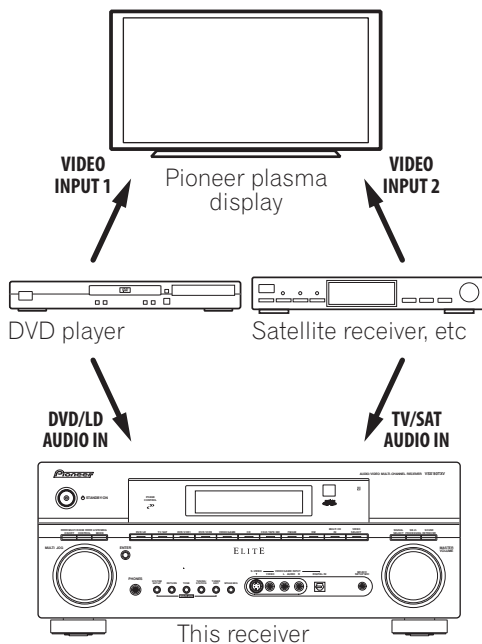

To make the most of the SR+ features, you should connect your source components (DVD player, etc.) in a slightly different way to that described in this chapter. For each component, connect the video output directly to the plasma display, and just connect the audio (analog and/or digital) to this receiver.

## Using the SR+ mode with a Pioneer plasma display

When connected using an SR+ cable, a number of features become available to make using this receiver with your Pioneer plasma display even easier. These features include:

- On-screen displays when making receiver settings, such as speaker setup, MCACC setup, and so on.
- On-screen volume display.
- On-screen display of listening mode.
- Automatic video input switching on the plasma display.
- Automatic volume muting on the plasma display.

See also *SR+ Setup for Pioneer plasma displays* on page 52 for more on setting up the receiver.



### Important

- The additional SR+ features do not work when the XM Radio function is selected.

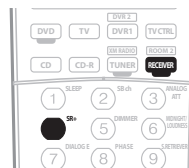

- 1 Make sure that the plasma display and this receiver are switched on and that they are connected with the SR+ cable.**

See *Using this receiver with a Pioneer plasma display* above for more on connecting these components.

- Make sure you have also selected the display input which you've connected the receiver in *The Input Assign menu* on page 50.

- 2 To switch SR+ mode on/off, press RECEIVER, then the SR+ button.**

The front panel display shows **SR+ ON** or **SR+ OFF**.

- The automatic volume muting feature is enabled separately; see *SR+ Setup for Pioneer plasma displays* on page 52.

## Chapter 9: Other Settings

### The Input Assign menu

You only need to make settings in the Input Assign menu if you didn't hook up your digital equipment according to the default settings for the digital inputs, or if you have connected equipment using component video cables.

- 1 Press **RECEIVER** on the remote control, then press the **SETUP** button.

An on-screen display (OSD) appears on your TV. Use **↑/↓/←/→** and **ENTER** to navigate through the screens and select menu items. Press **RETURN** to confirm and exit the current menu.

- 2 Select 'Input Assign' from the System Setup menu.

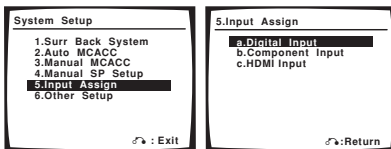

### Assigning the digital inputs

- Default settings:

**Coaxial - 1** – DVD/LD  
**Coaxial - 2** – DVR 2  
**Optical - 1** – DVR 1  
**Optical - 2** – TV/SAT  
**Optical - 3** – CD

You only need to do this if you didn't hook up your digital equipment according to the default settings for the digital inputs (see above). This setting tells the receiver what digital equipment is hooked up to which terminal so the buttons on the remote correspond to what you have hooked up.

- 1 Select 'Digital Input' from the Input Assign menu.

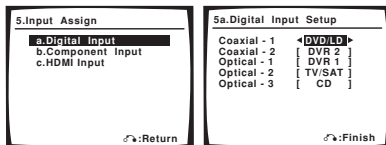

- 2 Select the number of the digital input to which you've connected the digital component.

The numbers correspond with the numbers beside the inputs on the back of the receiver.

- 3 Select the component that corresponds with the one you connected to that input.

Select between **DVD**, **TV**, **CD**, **CD-R**, **DVR 1**, **DVR 2** or **OFF**.

- Use **←/→** and **ENTER** to do this.
- If you assign a digital input to a certain function (for example, **DVD/LD**) then any digital inputs previously assigned to that function will automatically be switched off.

- 4 When you're finished, press **RETURN**.

You return to the Input Assign menu.

### Assigning the component video inputs

- Default settings:

**Component - 1** – OFF  
**Component - 2** – OFF  
**Component - 3** – OFF

If you used component video cords to connect your video equipment you must tell the receiver which device it is, or else you may see the S-video or composite video input instead of the component video signal. For more on this, see *Using the component video jacks* on page 14.

- 1 Select 'Component Input' from the Input Assign menu.

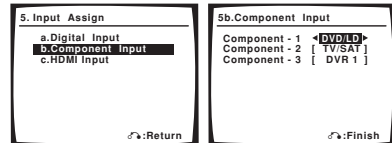

- 2 Select the number of the component video input to which you've connected your video component.

The numbers correspond with the numbers beside the inputs on the back of the receiver.

- 3 Select the component that corresponds with the one you connected to that input.

Select between **DVD**, **TV**, **DVR 1**, **DVR 2** or **OFF**.

- Use **←/→** and **ENTER** to do this.
- Make sure you have connected the audio from the component to the corresponding inputs on the rear of the receiver.
- If you connect any source component to the receiver using a component video input, you should also have your TV connected to this receiver's component video **MONITOR** output (downconverting component video is not possible after assigning an input).

- 4 When you're finished, press **RETURN**.

You return to the Input Assign menu.

### Assigning the HDMI inputs

- Default settings:

**HDMI - 1 – OFF**

**HDMI - 2 – OFF**

If you used HDMI to connect your video equipment, you must tell the receiver which input terminal(s) you have used, so that you see the proper video signal when you select the input source.

#### 1 Select 'HDMI Input' from the Input Assign menu.

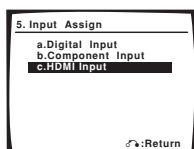

#### 2 Select the number of the HDMI input to which you've connected your video component.

The numbers correspond with the numbers beside the inputs on the back of the receiver.

#### 3 Select the component that corresponds with the one you connected to that input.

Select between **DVD**, **TV**, **DVR 1**, **DVR 2** or **OFF**.

- Use **←/→** and **ENTER** to do this.
- To hear audio from your HDMI component (through this system), you must also make separate audio connections to the corresponding inputs on the rear of the receiver. For more on this, see *Connecting using HDMI* on page 42.
- If you connect any video component to the receiver using HDMI, you should also have your TV connected to this receiver's HDMI output.

#### 4 When you're finished, press RETURN.

You return to the Input Assign menu.

#### 3 Select the setting you want to adjust.

If you are doing this for the first time, you may want to adjust these settings in order:

- **DRC Setup** – Specify the amount of dynamic range adjustment to Dolby Digital soundtracks (see *Dynamic Range Control Setup* below).
- **Dual Mono Setup** – Isolate one channel when listening to discs with dual mono encoding (see *Dual Mono Setup* below).
- **LFE ATT Setup** – Choose the attenuator level for the LFE channel (*LFE Attenuator Setup* on page 52).
- **SR+ Setup** – Specify how you want to control your Pioneer plasma display (*SR+ Setup for Pioneer plasma displays* on page 52).
- **Video Conv. Setup** – Specify if you want analog video signals converted for output to your TV (*Video Converter Setup* on page 52).
- **Multi Room Setup** – Specify your volume setting for a multi-room setup and your IR receiver type (see *Multi-Room and IR receiver setup* on page 53).
- **12V Trigger Setup** – Specify which components you want to switch on or off using the 12 volt trigger (see *12 Volt Trigger setup* on page 53).

#### 4 Make the adjustments necessary for each setting, pressing RETURN to confirm after each screen.

### Dynamic Range Control Setup

- Default setting: **OFF**

This setting specifies the amount of dynamic range adjustment to Dolby Digital and DTS movie soundtracks. You may want to use this when listening to surround sound at low volumes.

#### 1 Select 'DRC Setup' from the Other Setup menu.

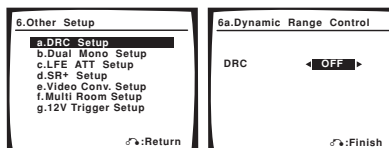

#### 2 Choose the setting that you want.

- **OFF** – No dynamic range adjustment (use when listening at higher volume).
- **MID** – Mid setting.
- **MAX** – Dynamic range is reduced (loud sounds are reduced in volume while quieter sounds are increased).

#### 3 When you're finished, press RETURN.

You return to the Other Setup menu.

## The Other Setup menu

The Other Setup menu is where you can make customized settings to reflect how you are using the receiver.

#### 1 Press RECEIVER on the remote control, then press the SETUP button.

An on-screen display (OSD) appears on your TV. Use **↑/↓/←/→** and **ENTER** to navigate through the screens and select menu items. Press **RETURN** to confirm and exit the current menu.

#### 2 Select 'Other Setup' then press ENTER.

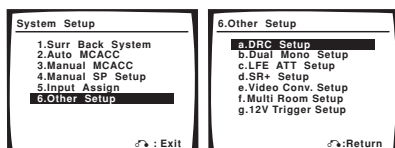

## Dual Mono Setup

- Default setting: **CH1**

You can specify how dual mono encoded Dolby Digital and DTS soundtracks should be played. Dual mono is not widely used, but is sometimes necessary when two languages need to be sent to separate channels.

### 1 Select 'Dual Mono Setup' from the Other Setup menu.

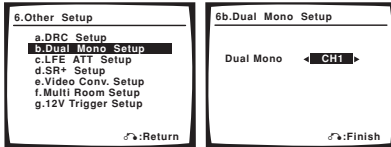

### 2 Choose the setting that you want.

- **CH1** – Only channel 1 is played
- **CH2** – Only channel 2 is played
- **CH1 CH2** – Both channels are played through the front speakers

### 3 When you're finished, press RETURN.

You return to the Other Setup menu.

## LFE Attenuator Setup

- Default setting: **ATT 0dB**

Some Dolby Digital and DTS audio sources include ultra-low bass tones. Set the LFE attenuator as necessary to prevent the ultra-low bass tones from distorting the sound from the speakers.

### 1 Select 'LFE ATT Setup' from the Other Setup menu.

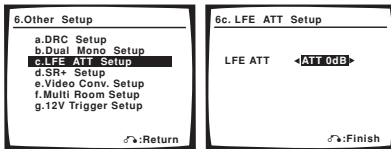

### 2 Choose the setting that you want.

- **ATT 0dB** – No limiting (recommended)
- **ATT 10dB** – 10 dB of limiting
- **LFE OFF** – No sound from LFE channel

### 3 When you're finished, press RETURN.

You return to the Other Setup menu.

## SR+ Setup for Pioneer plasma displays

- Default setting: **OFF** (all settings)

Make the following settings if you have connected a Pioneer plasma display to this receiver using an SR+ cable. Note that the number of settings available will depend on the plasma display you've connected.

See also *Using this receiver with a Pioneer plasma display* on page 48.

### 1 Select 'SR+ Setup' from the Other Setup menu.

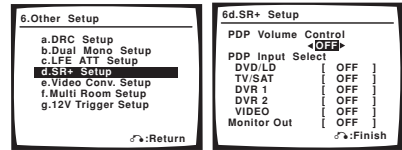

### 2 Select the 'PDP Volume Control' setting you want.

- **OFF** – The receiver does not control the volume of the plasma display
- **ON** – When the receiver is switched to one of the inputs that use the plasma display (DVD/LD, or another function below), the volume on the plasma display is muted so only sound from the receiver is heard.

### 3 Assign any input source connected to the plasma display to the corresponding input number.

This matches the receiver's input source with a numbered video input on the plasma display. For example, assign **DVD/LD** to **input-2** if you have connected your DVD video output to video input 2 on the plasma display.

- The **Monitor Out** should be set to the input that you've used to connect this receiver to your plasma display.

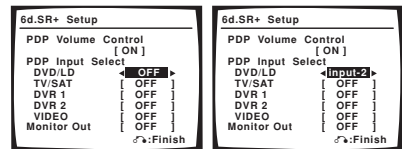

### 4 When you're finished, press RETURN.

You return to the Other Setup menu.

## Video Converter Setup

- Default setting: **ON**

The video converter allows you to see analog video sources through all of this receiver's **MONITOR VIDEO OUT** jacks. Note that the converter gives priority to component, S-video, then composite (in that order). See *About the video converter* on page 12 for more on this.

### 1 Select 'Video Conv. Setup' from the Other Setup menu.

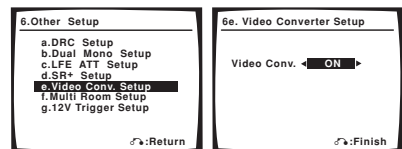

### 2 Choose the setting that you want.

- **ON** – All analog video signals are output from the **MONITOR VIDEO OUT** jacks.

- **OFF** – No conversion between video formats.

### 3 When you're finished, press RETURN.

You return to the Other Setup menu.

## Multi-Room and IR receiver setup

- Default setting: **Variable / Setting 1**

If you've made multi-room connections (see *Multi-room listening* on page 46) you may need to specify your volume setting. Also use this menu to specify your IR receiver type (if necessary).

### 1 Select 'Multi Room Setup' from the Other Setup menu.

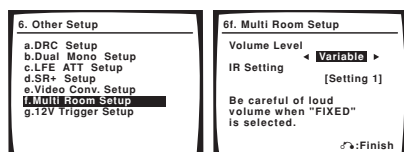

### 2 Select the volume level setting.

- **Variable** – Use this setting if you've connected a power amplifier in the sub room (this receiver is simply being used as a pre-amp) and you will be using this receiver's controls to adjust the volume.<sup>1</sup>
- **Fixed** – Use this setting if you've connected a fully integrated amplifier (such as another Pioneer VSX receiver) in the sub room and want to use that receiver's volume controls.

With the **Fixed** setting, the source is sent from this receiver at maximum volume, so make sure the volume is quite low in the sub room at first and then experiment to find the correct level.

### 3 Select the type of IR receiver you're using.

- **Setting 1** – Use this setting for all (other) IR receivers.<sup>2</sup>
- **Setting 2** – Use this setting if the IR receiver you're using doesn't seem to work after selecting **Setting 1**.

### 4 When you're finished, press RETURN.

You return to the Other Setup menu.

## 12 Volt Trigger setup

- Default setting: **OFF** (all components)

After connecting a component the 12 volt trigger (see *Switching components on and off using the 12 volt trigger* on page 48), it switches on automatically when you select an input function set to switch the trigger on. Specify which input functions switch on the trigger below.

### 1 Select '12V Trigger Setup' from the Other Setup menu.

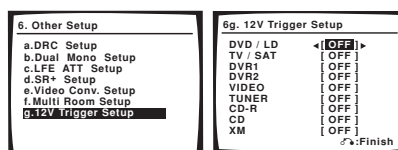

### 2 Select an input function and choose the setting that you want.

This should be the input function, that when selected, switches on the 12 volt trigger.

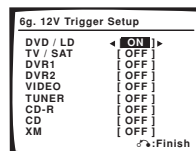

- **OFF** – 12 volt trigger is not activated for the selected component.
- **ON** – 12 volt trigger is activated for the selected component.

### 3 Repeat for as many input functions as you would like to set.

### 4 When you're finished, press RETURN.

You return to the Other Setup menu.

#### Note

- 1 If you selected **MR & S** in the *Surround back speaker setting* on page 33, you won't be able to change the volume level.
- 2 Some IR receivers may not work with this receiver. Check with your audio dealer for more information.

## Chapter 10

# Using other functions

### Making an audio or a video recording

You can make an audio or a video recording from the built-in tuner, or from an audio or video source connected to the receiver (such as a CD player or TV).<sup>1</sup> Keep in mind you can't make a digital recording from an analog source or vice-versa, so make sure the components you are recording to/from are hooked up in the same way (see *Connecting your equipment* on page 11 for more on connections).

Since the video converter is not available when making recordings (from the video **OUT** jacks) make sure to use the same type of video cable for connecting your recorder as you used to connect your video source (the one you want to record) to this receiver. For example, you must connect your recorder using S-video if your source has also been connected using S-video.

For more information about video connections, see *Connecting a DVD/HDD recorder, VCR and other video sources* on page 14.

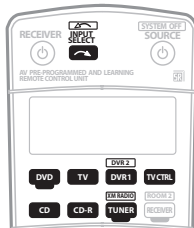

#### 1 Select the source you want to record.

Use the input source buttons (or **INPUT SELECT**).

- If necessary, press **SIGNAL SEL (SIGNAL SELECT)** to select the input signal corresponding to the source component (see *Choosing the input signal* on page 29 for more on this).

#### 2 Prepare the source you want to record.

Tune to the radio station, load the CD, video, DVD etc.

#### 3 Prepare the recorder.

Insert a blank tape, MD, video etc. into the recording device and set the recording levels.

Refer to the instructions that came with the recorder if you are unsure how to do this. Most video recorders set the audio recording level automatically—check the component's instruction manual if you're unsure.

#### 4 Start recording, then start playback of the source component.

### Reducing the level of an analog signal

The input attenuator lowers the input level of an analog signal when it's too strong. You can use this if you find that the **OVER** indicator is lights often, or you can hear distortion in the sound.<sup>2</sup>

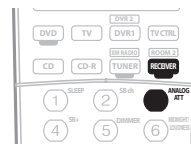

- Press **RECEIVER** then press **ANALOG ATT** to switch the input attenuator on or off.

### Watching video and audio sources independently

You can listen to a sound source and select a different video source on your TV.

- While listening to a source, press **VIDEO SELECT (front panel)** to select the video source you want to watch. Press repeatedly to cycle through the possible video sources. You can select **DVD, TV, DVR1, DVR2, VIDEO** or **OFF** (no video signal).<sup>3</sup>

#### Note

- The receiver's volume, DSP (the tone controls, for example), and surround effects have no effect on the recorded signal.
  - Some digital sources are copy-protected, and can only be recorded in analog.
  - Some video sources are copy-protected. These cannot be recorded.
- The attenuator isn't available with digital sources.
- The video select feature is canceled if you change the source input or switch off the receiver.
  - Note that this feature will not work with video sources assigned to either of the HDMI video inputs.

## Using the sleep timer

The sleep timer switches the receiver into standby after a specified amount of time so you can fall asleep without worrying about the receiver being left on all night. Use the remote control to set the sleep timer.



- Press **RECEIVER** then press **SLEEP** repeatedly to set the sleep time.

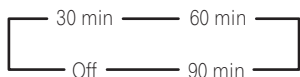

- You can check the remaining sleep time at any time by pressing **SLEEP** once. Pressing repeatedly will cycle through the sleep options again.<sup>1</sup>

## Dimming the display

You can choose between four brightness levels for the front panel display. Note that when selecting sources, the display automatically brightens for a few seconds.



- Press **RECEIVER** then press **DIMMER** repeatedly to change the brightness of the front panel display.

## Switching the speaker impedance

We recommend using speakers of 8  $\Omega$  with this system, but it is possible to switch the impedance setting if you plan to use speakers with a 6  $\Omega$  impedance rating. Use the front panel controls to do this.

- With the receiver in standby, press **STANDBY/ON** while holding down the **SPEAKERS** button.

Each time you do this, you switch between the impedance settings:

- **SP 6 OHM** – Use this setting if your speakers are rated at 6  $\Omega$ .
- **SP 8 OHM** – Use this setting if your speakers are rated at 8  $\Omega$  or more.

## Resetting the system

Use this procedure to reset all the receiver's settings to the factory default. Use the front panel controls to do this.

- 1 Switch the receiver into standby.

- 2 While holding down the front panel **TONE** button, press and hold **STANDBY/ON** for about three seconds.

The display shows **RESET?**.

- 3 Press the front panel **ENTER** button.

The display shows **RESET OK?**.

- 4 Press **SYSTEM SETUP** to confirm.

**OK** appears in the display to indicate that the receiver has been reset to the factory default settings.

- Note that all settings will be saved, even if the receiver is unplugged.

### Note

<sup>1</sup> You can also switch off the sleep timer simply by switching off the receiver.

## Chapter 11:

## Controlling the rest of your system

## Setting the remote to control other components

Most components can be assigned to one of the input source buttons (such as **DVD/LD** or **CD**) using the component's manufacturer preset code stored in the remote.

However, there are cases where only certain functions may be controllable after assigning the proper preset code, or the codes for the manufacturer in the remote control will not work for the model that you are using.

If you can't find a preset code that matches the component you want to control, you can still teach the remote individual commands from another remote control (see *Programming signals from other remote controls* below).

 **Note**

- You can cancel or exit any of the steps by pressing **RECEIVER**. To go back a step, press **RETURN**.
- After one minute of inactivity, the remote automatically exits the operation.

## Selecting preset codes directly



- 1 While pressing the **RECEIVER** button, press **SETUP**. The remote LCD display shows **SETUP**.
- 2 Use **↑/↓** to select **PRESET** then press **ENTER**.
- 3 Press the input source button for the component you want to control then press **ENTER**. The LCD on the remote displays the component you want to control (for example **DVD** or **DVR**).<sup>1</sup>
- 4 Use **↑/↓** to select the first letter of the brand name of your component then press **ENTER**. This should be the manufacturer's name (for example, **P** for Pioneer).

 **Note**

- 1 You can't assign the **RECEIVER**, **XM RADIO** or **TUNER** buttons.
- 2 • When using a Pioneer HDD recorder, please select **PIONEER DVR 487, 488, 489** or **493**.  
• When using a Pioneer plasma display released prior to summer 2005, please select preset codes **637** or **660**.
- 3 The remote can store about 200 preset codes (this has been tested with codes of Pioneer format only).
- 4 You can't assign the **RECEIVER**, **XM RADIO** or **TUNER** buttons.  
• **TV CONTROL** buttons (**TV**, **TV VOL +/-**, **TV CH +/-** and **INPUT SELECT**) can only be learned after selecting **TV CTRL**.

5 Use **↑/↓** to select the manufacturer's name from the list then press **ENTER**.

6 Use **↑/↓** to select the proper code from the list, then try using this remote with your component.

The code should start with the component type (for example, **DVD 020**). If there is more than one, start with the first one.<sup>2</sup>

To try out the remote control, switch the component on or off (into standby) by pressing **SOURCE** . If it doesn't seem to work, select the next code from the list (if there is one).

- If you can't find or properly enter a preset code, you can still teach the remote individual commands from another remote control (see *Programming signals from other remote controls* below).

7 If your component is controlled successfully, press **ENTER** to confirm.

The remote LCD display shows **OK**.

## Programming signals from other remote controls

If the preset code for your component is not available, or the available preset codes do not operate correctly, you can program signals from the remote control of another component. This can also be used to program additional operations (buttons not covered in the presets) after assigning a preset code.<sup>3</sup>

1 While pressing the **RECEIVER** button, press **SETUP**. The remote LCD display shows **SETUP**.

2 Use **↑/↓** to select **LEARNING** then press **ENTER**. The LCD on the remote prompts you for the component you want to control (for example **DVD** or **VIDEO**).

3 Press the input source button for the component you want to control then press **ENTER**. **PRES KEY** shows in the LCD display.<sup>4</sup>

4 Point the two remote controls towards each other then press the button that will be doing the learning on this receiver's remote control.

**PRES KEY** starts flashing to indicate the remote is ready to accept a signal.



- The remote controls should be 1 to 2 inches apart.

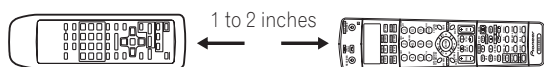

### 5 Press the corresponding button on the other remote control that is sending (teaching) the signal to this receiver's remote control.

For example, if you want to learn the playback control signal, press and hold **▶** briefly. The LCD display will show **OK** if the operation has been learned.<sup>1</sup>

If for some reasons the operation hasn't been learned the LCD will display **ERROR** briefly and then display **PRES KEY** again. If this happens, keep pressing the (teaching) button as you vary the distance between the two remotes, until the LCD display shows **OK**.<sup>2</sup>

Certain buttons represent operations that cannot be learned from other remote controls.<sup>3</sup> The buttons available are shown below (with the exception of the TV controls, a combination of **SHIFT** and these buttons can also be learned):

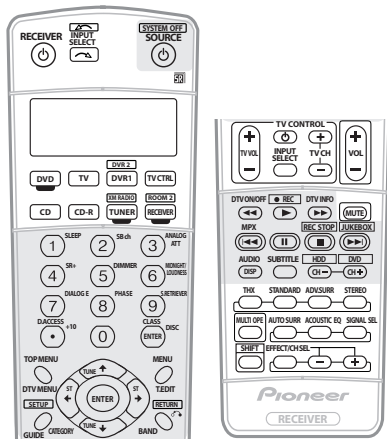

### 6 To program additional signals for the current component repeat steps 4 and 5.

To program signals for another component, exit and repeat steps 1 through 5.

### 7 Press and hold the RECEIVER button for a couple of seconds to exit and store the operation(s).

## Erasing one of the remote control button settings

This erases one of the buttons you have programmed and restores the button to the factory default.

#### 1 While pressing the RECEIVER button, press SETUP.

The remote LCD display shows **SETUP**.

#### 2 Use **↑/↓** to select ERASE then press ENTER.

The LCD on the remote prompts you for the component corresponding to the button setting to be erased.

#### 3 Press the input source button corresponding to the command to be erased then press ENTER.

The LCD display flashes **PRES KEY**.

#### 4 Press and hold the button to be erased for two seconds.

The LCD display shows **OK** or **NO CODE** to confirm the button has been erased.

#### 5 Repeat step 4 to erase other buttons.

#### 6 Press and hold the RECEIVER button for a couple of seconds when you're done.

## Resetting the remote control presets

This will erase all preset remote control preset codes and programmed buttons.

#### 1 While pressing the RECEIVER button, press SETUP.

The remote LCD display shows **SETUP**.

#### 2 Use **↑/↓** to select RESET then press ENTER.

**RESET** flashes in the LCD display.

#### 3 Press and hold ENTER for about two seconds.

The LCD shows **OK** to confirm the remote presets have been erased.

## Confirming preset codes

Use this feature to check which preset code is assigned to an input source button.

#### 1 While pressing the RECEIVER button, press SETUP.

The remote LCD display shows **SETUP**.

#### 2 Use **↑/↓** to select READ ID then press ENTER.

The LCD on the remote prompts you for the input source button you want to check.

### Note

<sup>1</sup> Note that interference from TVs or other devices will sometimes result in the remote control learning the wrong signal.

<sup>2</sup> • Some commands from other remote controls cannot be learned, but in most cases the remotes just need to be moved closer together or farther apart.

• If the remote LCD shows **FULL**, it means the memory is full. See *Erasing one of the remote control button settings* below to erase a programmed button you're not using to free up more memory (note that some signals may take more memory than others).

<sup>3</sup> Note that the number key decimal button (**+10/D.ACCESS**) may not be learned with some components.

### 3 Press the button of the component for which you want to check the preset code, then press ENTER.

The brand name and preset code appears in the display for three seconds.

## Renaming input source names

You can customize the names that appear on the remote LCD when you select an input source (for example, you could change the name of **DVR 1** to **HDD/DVR**).

**1 While pressing the RECEIVER button, press SETUP.**  
The remote LCD display shows **SETUP**.

**2 Use ↑/↓ to select RENAME then press ENTER.**  
The LCD on the remote prompts you for the button of the input source you want to rename.

**3 Press the input source button you want to rename then press ENTER.**

**4 Use ↑/↓ to select NAME EDT then press ENTER.**  
To reset the button to its original (default) name, select **NAME RST** above.

**5 Edit the name of the input source in the remote control LCD, pressing ENTER when you're finished.**  
Use ↑/↓ to change the character and ←/→ to move forward/back a position. The name can be up to eight characters (the possible characters are listed below).

ABCDEFGHIJKLMN**OP**QRSTUVWXYZ

0123456789 \ / \* + - [space]

## Direct function

- Default setting: **ON**

You can use the direct function feature to control one component using the remote control while at the same time, using your receiver to playback a different component. This could let you, for example, use the remote control to set up and listen to a CD on the receiver and then use the remote control to rewind a tape in your VCR while you continue to listen to your CD player.

When direct function is on, any component you select (using the input source buttons) will be selected by both the receiver and the remote control. When you turn direct function off, you can operate the remote control without affecting the receiver.<sup>1</sup>

**1 While pressing the RECEIVER button, press SETUP.**  
The remote LCD display shows **SETUP**.

**2 Use ↑/↓ to select DIRECT F then press ENTER.**  
The LCD on the remote prompts you for the button of the input source you want to control.

**3 Press the input source button for the component you want to control then press ENTER.**

**4 Use ↑/↓ to switch direct function ON or OFF then press ENTER.**

The LCD shows **OK** to confirm the setting.

## Multi Operation and System Off

The Multi Operation feature allows you to program a series of up to 5 commands for the components in your system. For example, you could turn on your TV, turn on your DVD player and start playing the loaded DVD using only two buttons on the remote control.

Similar to multi operations, System Off allows you to use one button to stop and switch off a series of components in your system at the same time.<sup>2</sup>

### Programming a multi-operation or a shutdown sequence

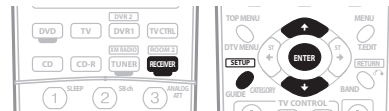

**1 While pressing the RECEIVER button, press SETUP.**  
The remote LCD display shows **SETUP**.

**2 Use ↑/↓ to select MULTI OP or SYS OFF from the menu and press ENTER.**

*If you selected Multi Operation (MULTI OP), the LCD on the remote prompts you for an input source button.*

*If you selected System Off (SYSOFF), go to step 4.*

**3 Press the input source button for the component that will start the multi-operation then press ENTER.**

For example, if you want to start the sequence by switching on your DVD player, press **DVD**.

**4 Use ↑/↓ to select CODE EDT then press ENTER.**

To erase any previously stored multi-operations (or shutdown sequences) select **CODE ERS** above.

**5 Use ↑/↓ to select a command in the sequence then press ENTER.**

If this is the first command in the sequence, select **1ST CODE**. Otherwise, simply choose the next command in the sequence. **PRES KEY** flashes after you press **ENTER**.

### Note

<sup>1</sup> You can't use direct function with the **TV CTRL** function.

<sup>2</sup> Before Multi Operation and System Off will work correctly, you must setup the remote to work with your TV and other components (see *Setting the remote to control other components* on page 56 for more on this).

- Some units may take some time to power up, in which case multiple operations may not be possible.
- Power on and off commands only work with components that have a standby mode.

**6 If necessary, press the input source button for the component whose command you want to input.**

This is only necessary if the command is for a new component (input source).

**7 Select the button for the command you want to input.**

The following remote control commands can be selected:

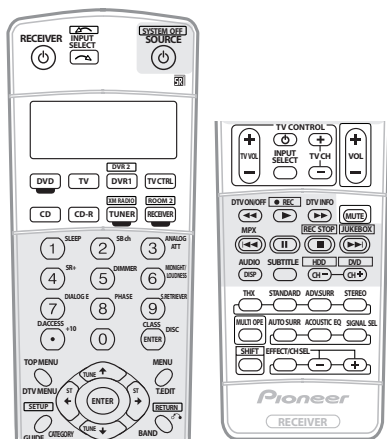

- You don't need to program the receiver to switch on or off. This is done automatically.

With Pioneer components, you don't need to:

- program the power to switch off in a shutdown sequence (except DVD recorders);
- program the power to switch on if it's the source component selected in step 3;
- program a Pioneer TV or monitor to switch on if the input function (selected in step 2) has video input terminals;

These take priority in multi operations (not shutdown).

**8 Repeat steps 5–7 to program a sequence of up to five commands.**

**9 When you're finished, use ↑/↓ to select EDITEXT from the menu and press ENTER.**

You will return to the remote control **SETUP** menu. Select \* **EXIT** \* again to exit.

**Using multi operations**

You can start multi operations with the receiver switched on, or in standby.

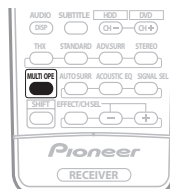

- 1 Press MULTI OPE.**  
MULTI OP flashes in the display.

- 2 Press an input source button that has been set up with a multi operation.**

The receiver switches on (if it was in standby) and the programmed multi operation is performed automatically.

**Using System off**

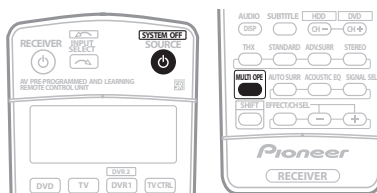

- 1 Press MULTI OPE.**  
MULTI OP flashes in the display.

- 2 Press SOURCE.**  
The command sequence you programmed will run, then all Pioneer components will switch off<sup>1</sup>, followed by this receiver.

**Note**

<sup>1</sup> In order to avoid accidentally switching off a DVD recorder that is currently recording, no DVD recorder power off codes are sent.

## Controls for TVs

This remote control can control components after entering the proper codes or teaching the receiver the commands (see *Setting the remote to control other components* on page 56 for more on this). Use the input source buttons to select the component.

- The **TV CONTROL** buttons on the remote control are dedicated to control the TV assigned to the **TV CTRL** button. If you have two TVs, assign the main TV to the **TV CTRL** button.

Button(s)	Function	Components
<b>TV</b>	Press to switch the component assigned to the <b>TV CONT</b> button on or off.	Cable TV/Satellite TV/TV/DTV
<b>INPUT SELECT</b>	Switches the TV input. (Not possible with all models.)	Cable TV/Satellite TV/TV/DTV
<b>TV CH +/-</b>	Selects channels.	Cable TV/Satellite TV/TV/DTV
<b>TV VOL +/-</b>	Adjust the TV volume.	Cable TV/Satellite TV/TV/DTV
<b>SOURCE</b>	Switches the DTV on or off.	DTV
	Switches the TV or CATV between standby and on.	Cable TV/Satellite TV/TV
	Switches the DTV on or off.	DTV
	Press to get information on DTV programs.	DTV
	Use to choose the BLUE commands on a DTV menu.	DTV
	Use to choose the YELLOW commands on a DTV menu.	DTV
	Use to choose the GREEN commands on a DTV menu.	DTV
	Use to choose the RED commands on a DTV menu.	DTV
<b>AUDIO / DISP</b>	Use to switch DTV audio tracks.	DTV
<b>SUBTITLE</b>	Use to return to the previously selected channel.	Cable TV/Satellite TV/TV/DTV
<b>DTV MENU</b>	Press to display the DTV menu.	DTV
<b>GUIDE</b>	Use as the <b>GUIDE</b> button for navigating.	Cable TV/Satellite TV/TV/DTV
<b>RETURN</b>	Use to select <b>RETURN</b> or <b>EXIT</b> .	DTV
Number buttons	Use to select a specific TV channel.	Cable TV/Satellite TV/TV/DTV
<b>+10</b> button	Use to add a decimal point when selecting a specific TV channel.	DTV
<b>ENTER/ DISC</b>	Use to enter a channel.	Cable TV/Satellite TV/TV/DTV
<b>MENU</b>	Select different menus from the DTV functions.	DTV
	Select the menu screen.	Cable TV/Satellite TV/TV
& <b>ENTER</b>	Press to select or adjust and navigate items on the menu screen.	Cable TV/Satellite TV/TV/DTV

## Controls for other components

This remote control can control these components after entering the proper codes or teaching the receiver the commands (see *Setting the remote to control other components* on page 56 for more on this). Use the input source buttons to select the component.

Button (s)	Function	Components
<b>SOURCE</b>	Press to switch the component between standby and on.	CD/MD/CD-R/VCR/DVD/LD/DVR player/Cassette deck
	Press to return to the start of the current track or chapter. Repeated presses skips to the start of previous tracks or chapters.	CD/MD/CD-R/DVD/LD player
	Press to advance to the start of the next track or chapter. Repeated presses skips to the start of following tracks or chapters.	CD/MD/CD-R/DVD/LD player
	Pause playback or recording.	CD/MD/CD-R/VCR/DVD/LD/DVR player/Cassette deck
	Start playback.	CD/MD/CD-R/VCR/DVD/LD/DVR player/Cassette deck
	Hold down for fast forward playback.	CD/MD/CD-R/VCR/DVD/LD/DVR player/Cassette deck
	Hold down for fast reverse playback.	CD/MD/CD-R/VCR/DVD/LD/DVR player/Cassette deck
	Stops playback.	CD/MD/CD-R/VCR/DVD/LD/DVR player/Cassette deck
<b>REC (SHIFT+▶)</b>	Starts recording.	MD/CD-R/VCR/DVR player/Cassette deck
<b>REC STOP (SHIFT+■)</b>	Stops recording.	DVR player
<b>JUKEBOX (SHIFT+▶▶▶)</b>	Switches to the Jukebox feature.	DVR player
Number buttons	Directly access tracks on a program source.	CD/MD/CD-R/VCR/LD player
	Use the number buttons to navigate the on-screen display.	DVD/DVR player
<b>+10</b> button	Selects tracks higher than 10. (For example, press <b>+10</b> then <b>3</b> to select track 13.)	CD/MD/CD-R/VCR/LD player

Button (s)	Function	Components
<b>ENTER/ DISC</b>	Chooses the disc.	Multiple CD player
	Use as the <b>ENTER</b> button.	VCR/DVD player
	Displays the setup screen for DVR players.	DVR player
	Changes sides of the LD.	LD player
<b>TOP MENU</b>	Displays the disc 'top' menu of a DVD player.	DVD/DVR player
<b>MENU</b>	Displays menus concerning the current DVD or DVR you are using.	DVD/DVR player
<b>↑</b>	Pauses the tape.	Cassette deck
<b>↓</b>	Stops the tape.	Cassette deck
<b>ENTER</b>	Starts playback.	Cassette deck
<b>←/→</b>	Fast rewinds/fast forwards the tape.	Cassette deck
<b>↑/↓/←/→ &amp; ENTER</b>	Navigates DVD menu/options.	DVD/DVR Player
<b>GUIDE</b>	Press to access the DVD player setup screen.	DVD/DVR Player
<b>CH +/-</b>	Selects channels.	VCR/DVD/DVR Player
<b>AUDIO</b>	Changes the audio language or channel.	DVD/DVR Player
<b>SUBTITLE</b>	Displays/changes the subtitles on multilingual DVDs.	DVD/DVR Player
<b>SHIFT +SUBTITLE</b>	Switches to the VCR controls when using a VCR/DVD/HDD recorder.	VCR/DVD/DVR Player
<b>HDD (SHIFT + CH-)</b>	Switches to the hard disk controls when using a DVD/HDD recorder.	DVR Player
<b>DVD (SHIFT + CH+)</b>	Switches to the DVD controls when using a DVD/HDD recorder.	DVR Player

## Operating other Pioneer components with this unit's sensor

Many Pioneer components have SR **CONTROL** jacks which can be used to link components together so that you can use just the remote sensor of one component. When you use a remote control, the control signal is passed along the chain to the appropriate component.<sup>1</sup>

### Important

- Note that if you use this feature, *make sure that you also have at least one set of analog audio or video jacks connected to another component for grounding purposes.*

#### 1 Decide which component you want to use the remote sensor of.

When you want to control any component in the chain, this is the remote sensor at which you'll point the corresponding remote control.

#### 2 Connect the CONTROL OUT jack of that component to the CONTROL IN jack of another Pioneer component.

Use a cable with a mono mini-plug on each end for the connection.

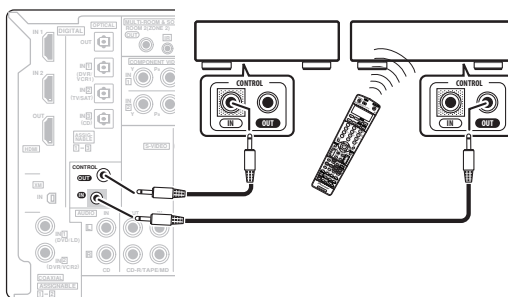

#### 3 Continue the chain in the same way for as many components as you have.

### Note

- If you want to control all your components using this receiver's remote control, refer to *Setting the remote to control other components* on page 56. If you have connected a remote control to the **CONTROL IN** jack (using a mini-plug cable), you won't be able to control this unit using the remote sensor.
  - See *Using this receiver with a Pioneer plasma display* on page 48 if you are connecting a Pioneer plasma display.

## Chapter 12: Additional information

### Troubleshooting

Incorrect operations are often mistaken for trouble and malfunctions. If you think that there is something wrong with this component, check the points below. Sometimes the trouble may lie in another component. Investigate the other components and electrical appliances being used. If the trouble cannot be rectified even after exercising the checks listed below, ask your nearest Pioneer authorized independent service company to carry out repair work.

#### Power

Symptom	Remedy
The power does not turn on.	<ul style="list-style-type: none"> <li>• Make sure that the power cable is plugged in to an active power outlet.</li> <li>• Try disconnecting from the power outlet, then plugging back in.</li> </ul>
The receiver suddenly switches off or the Phase Control indicator blinks.	<ul style="list-style-type: none"> <li>• Check that there are no loose strands of speaker wire touching the rear panel or another set of wires. If so, re-attach the speaker wires, making sure there are no stray strands.</li> <li>• The receiver may have a serious problem. Disconnect from the power and call a Pioneer authorized independent service company.</li> </ul>
During loud playback the power suddenly switches off.	<ul style="list-style-type: none"> <li>• Turn down the volume.</li> <li>• Lower the 40 Hz and 125 Hz equalizer levels in the <i>Manual MCACC setup</i> on page 34.</li> <li>• Try switching on the digital safety feature (put the receiver into standby, hold down the <b>SYSTEM SETUP</b> button on the front panel and press <b>STANDBY/ON</b> to switch between <b>SAFETY ON</b> and <b>SAFETY OFF</b>. If the power switches off even with <b>SAFETY ON</b> selected, turn down the volume.</li> </ul>
The unit does not respond when the buttons are pressed.	<ul style="list-style-type: none"> <li>• Try switching the receiver off then back on again.</li> <li>• Try disconnecting the power cable, then connect again.</li> </ul>
<b>AMP ERR</b> blinks in the display, then the power automatically switches off. The <b>MCACC</b> blinks and the power does not turn on.	<ul style="list-style-type: none"> <li>• The receiver may have a serious problem. Do not try switching the receiver on. Contact a Pioneer authorized independent service company for help.</li> </ul>
<b>OVERHEAT</b> blinks in the display then the power automatically switches off.	<ul style="list-style-type: none"> <li>• Allow the unit to cool down in a well-ventilated place before switching back on. Check the safety precautions on pages 2–3 for information on improving heat dispersal.</li> </ul>

#### No sound

Symptom	Remedy
No sound is output when an input source is selected. No sound output from the front speakers.	<ul style="list-style-type: none"> <li>• Check the volume, mute setting (press <b>MUTE</b>) and speaker setting (press <b>SPEAKERS</b>).</li> <li>• Make sure the correct input source is selected.</li> <li>• Check that the MCACC setup microphone is disconnected.</li> <li>• Make sure the correct input signal is selected (press <b>SIGNAL SELECT</b>).</li> <li>• Check that the source component is connected properly (see <i>Connecting your equipment</i> on page 11).</li> <li>• Check that the speakers are connected properly (see <i>Connecting the speakers</i> on page 17).</li> </ul>
No sound from the surround or center speakers.	<ul style="list-style-type: none"> <li>• Check that the Stereo listening mode isn't selected; select one of the surround listening modes (see <i>Listening in surround sound</i> on page 26).</li> <li>• Check that the surround/center speakers are not set to <b>NO</b> (see <i>Speaker Setting</i> on page 37).</li> <li>• Check the channel level settings (see <i>Channel Level</i> on page 38).</li> <li>• Check the speaker connections (see <i>Connecting the speakers</i> on page 17).</li> </ul>

Symptom	Remedy
No sound from surround back speakers.	<ul style="list-style-type: none"> <li>• Check that the surround back speakers are set to <b>LARGE</b> or <b>SMALL</b> (see <i>Speaker Setting</i> on page 37).</li> <li>• Make sure surround back processing is set to <b>SBch ON</b> (see <i>Using surround back channel processing</i> on page 29).</li> <li>• If the source is Dolby Surround EX or DTS ES with no flag to indicate 6.1 compatibility, then with surround back processing set to <b>SBch Auto</b>, there will be no sound from the surround back speakers. In this case, set to <b>SBch ON</b> (see <i>Using surround back channel processing</i> on page 29).</li> <li>• If the source does not have 6.1 playback channels, make sure that surround back processing is set to <b>SBch ON</b> and a surround mode is selected (see <i>Listening in surround sound</i> on page 26).</li> <li>• Check the speaker connections (see <i>Connecting the speakers</i> on page 17). If only one surround back speaker is connected, make sure it's connected to the left channel speaker terminal.</li> </ul>
No sound from subwoofer.	<ul style="list-style-type: none"> <li>• Check that the subwoofer is connected properly, switched on and the volume turned up.</li> <li>• If your subwoofer has a sleep function, make sure it is switched off.</li> <li>• Make sure that the Subwoofer setting is <b>YES</b> or <b>PLUS</b> (see <i>Speaker Setting</i> on page 37).</li> <li>• The crossover frequency may be set too low; try setting it higher to match the characteristics of your other speakers (see <i>Speaker Setting</i> on page 37).</li> <li>• If there is very little low frequency information in the source material, change your speaker settings to Front: <b>SMALL</b> / Subwoofer: <b>YES</b>, or Front: <b>LARGE</b> / Subwoofer: <b>PLUS</b> (see <i>Speaker Setting</i> on page 37).</li> <li>• Check the speaker level settings (see <i>Channel Level</i> on page 38).</li> </ul>
No sound from one speaker.	<ul style="list-style-type: none"> <li>• Check the speaker connection (see <i>Connecting the speakers</i> on page 17).</li> <li>• Check the speaker level settings (see <i>Channel Level</i> on page 38).</li> <li>• Check that the speaker hasn't been set to <b>NO</b> (see <i>Speaker Setting</i> on page 37).</li> <li>• The channel may not be recorded in the source. By using one of the advanced effect listening mode, you may be able to create the missing channel (see <i>Listening in surround sound</i> on page 26).</li> </ul>
Sound is produced from analog components, but not from digital ones (DVD, LD, CD-ROM etc.).	<ul style="list-style-type: none"> <li>• Check that the input signal type is set to <b>DIGITAL</b> (see <i>Choosing the input signal</i> on page 29).</li> <li>• Make sure that the digital input is assigned correctly for the input jack the component is connected to (see <i>The Input Assign menu</i> on page 50).</li> <li>• Check the digital output settings on the source component.</li> <li>• If the source component has a digital volume control, make sure this is not turned down.</li> <li>• Make sure that the multichannel analog inputs are not selected. Select any other input source.</li> </ul>
No sound is output or a noise is output when Dolby Digital/DTS software is played back.	<ul style="list-style-type: none"> <li>• Check that your DVD player is compatible with Dolby Digital/DTS discs.</li> <li>• Check the digital output settings of your DVD player. Make sure that the DTS signal output is set to On.</li> <li>• If the source component has a digital volume control, make sure this is not turned down.</li> </ul>
No sound when using the System Setup or Status menu.	<ul style="list-style-type: none"> <li>• If sound is muted in the sub room (<b>ROOM 2</b>), it will be restored after exiting the System Setup menu.</li> </ul>

## Other audio problems

Symptom	Remedy
Broadcast stations cannot be selected automatically, or there is considerable noise in radio broadcasts.	<p><i>For FM broadcasts</i></p> <ul style="list-style-type: none"> <li>• Fully extend the FM wire antenna, adjust the position for best reception and secure to a wall, etc.</li> <li>• Use an outdoor antenna for better reception (see page 20).</li> </ul> <p><i>For AM broadcasts</i></p> <ul style="list-style-type: none"> <li>• Adjust the position and direction of the AM antenna.</li> <li>• Use an outdoor antenna for better reception (see page 20).</li> <li>• Noise may be caused by interference from other equipment, such as a fluorescent light, motor, etc. Switch off or move the other equipment, or move the AM antenna.</li> </ul>
A multichannel DVD source appears to be downmixed to 2 channels during playback.	<ul style="list-style-type: none"> <li>• Make sure that the multichannel analog inputs are selected (see <i>Selecting the multichannel analog inputs</i> on page 43).</li> </ul>
Noise is output when scanning a DTS CD.	<ul style="list-style-type: none"> <li>• This is not a malfunction of the receiver. The scan function of your player alters the digital information, making it unreadable, resulting in noise being output. Lower the volume when scanning.</li> </ul>
When playing a DTS format LD there is audible noise on the soundtrack.	<ul style="list-style-type: none"> <li>• Make sure that the input signal type is set to <b>DIGITAL</b> (see <i>Choosing the input signal</i> on page 29).</li> </ul>

Symptom	Remedy
Can't record audio.	<ul style="list-style-type: none"> <li>You can only make a digital recording from a digital source, and an analog recording from an analog source.</li> <li>For digital sources, make sure that what you're recording isn't copy protected.</li> <li>Check that the <b>OUT</b> jacks are properly connected to the recorder's input jacks (see <i>Connecting analog audio sources</i> on page 16).</li> </ul>
Subwoofer output is very low.	<ul style="list-style-type: none"> <li>To route more signal to the subwoofer, set it to <b>PLUS</b> or set the front speakers to <b>SMALL</b> (see <i>Speaker Setting</i> on page 37).</li> </ul>
Everything seems to be set up correctly, but the playback sound is odd.	<ul style="list-style-type: none"> <li>The speakers may be out of phase. Check that the positive/negative speaker terminals on the receiver are matched with the corresponding terminals on the speakers (see <i>Connecting the speakers</i> on page 17).</li> </ul>
The <b>PHASE CONTROL</b> feature doesn't seem to have an audible effect.	<ul style="list-style-type: none"> <li>If applicable, check that the lowpass filter switch on your subwoofer is off, or the lowpass cutoff is set to the highest frequency setting. If there is a <b>PHASE</b> setting on your subwoofer, set it to 0° (or depending on the subwoofer, the setting where you think it has the best overall effect on the sound).</li> <li>Make sure the speaker distance setting is correct for all speakers (see <i>Speaker Distance</i> on page 39).</li> </ul>
Noise or hum can be heard even when there is no sound being input.	<ul style="list-style-type: none"> <li>Check that personal computers or other digital components connected to the same power source are not causing interference.</li> </ul>
There seems to be a time lag between the speakers and the output of the subwoofer.	<ul style="list-style-type: none"> <li>See <i>Automatically setting up for surround sound (MCACC)</i> on page 8 to set up your system again using MCACC (this will automatically compensate for a delay in the subwoofer output).</li> </ul>
The maximum volume available (shown in the front panel display) is lower than the <b>+12 dB</b> maximum.	<ul style="list-style-type: none"> <li>This is not a malfunction. If the levels in <i>Channel Level</i> on page 38 have been adjusted, the maximum volume will change accordingly.</li> </ul>

## Video

Symptom	Remedy
No image is output when an input is selected.	<ul style="list-style-type: none"> <li>Check the video connections of the source component (see page 14).</li> <li>Make sure the input assignment is correct for components connected using component cables (see <i>The Input Assign menu</i> on page 50).</li> <li>A separate video source has been selected using <b>VIDEO SELECT</b> (see <i>Watching video and audio sources independently</i> on page 54).</li> <li>Check the video output settings of the source component.</li> <li>Check that the video input you selected on your TV is correct.</li> </ul>
Can't record video.	<ul style="list-style-type: none"> <li>Check that the source is not copy-protected.</li> <li>The video converter is not available when making recordings. Check that the same type of video cable is used for connecting both the recorder and the video source (the one you want to record) to this receiver.</li> </ul>
Noisy, intermittent, or distorted picture.	<ul style="list-style-type: none"> <li>Sometimes a video deck may output a noisy video signal (during scanning, for example), or the video quality may just be poor (with some video game units, for example). The picture quality may also depend on the settings, etc. of your display device. Switch off the video converter and reconnect the source and display device using the same type of connection (component, S-video or composite), then start playback again.</li> </ul>

## Settings

Symptom	Remedy
The Auto MCACC Setup continually shows an error.	<ul style="list-style-type: none"> <li>The ambient noise level may be too high. Keep the noise level in the room as low as possible (see also <i>Problems when using the Auto MCACC Setup</i> on page 10). If the noise level cannot be kept low enough, you will have to set up the surround sound manually (page 34).</li> </ul>
After using the Auto MCACC Setup, the speaker size setting is incorrect.	<ul style="list-style-type: none"> <li>There may have been some low frequency noise in the room from an air-conditioner, motor, etc. Switch off all other appliances in the room and use Auto MCACC Setup again.</li> <li>Depending on a number of factors (room size, speaker placement, etc.) this may occur in some cases. You can change the speaker setting manually in <i>Speaker Setting</i> on page 37 if this is a recurring problem.</li> </ul>



Symptom	Remedy
Can't adjust the Fine Speaker Distance setting (page 35) properly.	<ul style="list-style-type: none"> <li>Check that the speakers are all in phase (make sure the positive (+) and negative (-) terminals are matched up properly).</li> </ul>
The display shows <b>KEY LOCK ON</b> when you try to make settings.	<ul style="list-style-type: none"> <li>With the receiver in standby, press <b>⏻ STANDBY/ON</b> while holding down the <b>MULTI ROOM CONTROL</b> button to disable the key lock.</li> </ul>
Most recent settings have been erased.	<ul style="list-style-type: none"> <li>The power cord was disconnected from the wall while adjusting this setting.</li> </ul>

## Display

Symptom	Remedy
The display is dark or off.	<ul style="list-style-type: none"> <li>Press <b>DIMMER</b> on the remote control repeatedly to select a different brightness.</li> </ul>
After making an adjustment the display goes off.	<ul style="list-style-type: none"> <li>Press <b>DIMMER</b> on the remote control repeatedly to select a different brightness.</li> </ul>
You can't get <b>DIGITAL</b> to display when using the <b>SIGNAL SELECT</b> button.	<ul style="list-style-type: none"> <li>Check the digital connections and make sure that the digital inputs are assigned correctly (see <i>The Input Assign menu</i> on page 50).</li> <li>If the multichannel analog inputs are selected, select a different input source.</li> </ul>
The Dolby/DTS indicator doesn't light when playing Dolby/DTS software.	<ul style="list-style-type: none"> <li>These indicators do not light if playback is paused.</li> <li>Check the playback (especially the digital output) settings of the source component.</li> </ul>
When playing a DVD-Audio disc, the DVD player display shows <b>96 kHz</b> . However, the receiver's display does not.	<ul style="list-style-type: none"> <li>This is not a malfunction. 96 kHz audio from DVD-Audio discs is only output from the analog outputs of the DVD player. This receiver cannot show the playback sample rate when using the analog inputs.</li> </ul>
During playback of a DTS 96/24 source, the display doesn't show <b>96 kHz</b> .	<ul style="list-style-type: none"> <li>Make sure that the receiver is set to <b>AUTO</b> or <b>DIGITAL</b> (see <i>Choosing the input signal</i> on page 29).</li> </ul>
When playing Dolby Digital or DTS sources, the receiver's format indicators do not light.	<ul style="list-style-type: none"> <li>Check that the player is connected using a digital connection.</li> <li>Make sure that the receiver is set to <b>AUTO</b> or <b>DIGITAL</b> (see <i>Choosing the input signal</i> on page 29).</li> <li>Check that the player isn't set up so that Dolby Digital and DTS sources are converted to PCM.</li> <li>Ensure that if there are several audio tracks on the disc, the Dolby Digital or DTS is selected.</li> </ul>
When playing certain discs, none of the receiver's format indicators light.	<ul style="list-style-type: none"> <li>The disc may not contain 5.1/6.1 channel material. Check the disc packaging for more on what audio tracks are recorded on the disc.</li> </ul>
When playing a disc, the <b>PL II</b> or <b>Neo:6</b> indicator lights on the receiver.	<ul style="list-style-type: none"> <li>Make sure that the receiver is set to <b>AUTO</b> or <b>DIGITAL</b> (see <i>Choosing the input signal</i> on page 29).</li> <li>If a two channel soundtrack is currently playing (including Dolby Surround encoded), then this is not a malfunction. Check the disc packaging for details about the audio tracks available.</li> </ul>
During playback of a Surround EX or DTS ES source on the <b>SBch AUTO</b> setting, the <b>EX</b> and <b>ES</b> indicators don't light, or the signal is not properly processed.	<ul style="list-style-type: none"> <li>The source may be Dolby Surround EX / DTS ES software, but it has no flag to indicate it is 6.1 compatible. Set to <b>SBch ON</b> (see <i>Using surround back channel processing</i> on page 29) then switch to the THX Surround EX or Standard EX listening mode (see <i>Listening in surround sound</i> on page 26).</li> </ul>

## Remote control

Symptom	Remedy
Cannot be remote controlled.	<ul style="list-style-type: none"> <li>Try replacing the batteries in the remote control (see <i>Loading the batteries</i> on page 7).</li> <li>Be sure to operate within 23 feet and a 30° angle of the remote sensor on the front panel (see <i>Operating range of remote control unit</i> on page 22).</li> <li>Check that there are no obstacles between the receiver and the remote control.</li> <li>Make sure that there is no fluorescent or other strong light shining on to the remote sensor.</li> <li>Check the connections of the <b>CONTROL IN</b> jack (see <i>Operating other Pioneer components with this unit's sensor</i> on page 61).</li> </ul>

Symptom	Remedy
Other components can't be operated with the system remote.	<ul style="list-style-type: none"> <li>• If the battery ran down, the preset codes may have been cleared. Re-enter the preset codes.</li> <li>• The preset code may be incorrect. Redo the procedure for entering preset codes.</li> </ul>
The SR cable is connected, but the connected components can't be operated with the remote.	<ul style="list-style-type: none"> <li>• Reinsert the SR cable, making sure it's connected to the right jack (see <i>Using this receiver with a Pioneer plasma display</i> on page 48).</li> <li>• Make sure that there is an analog connection between the units. This is necessary for the SR feature to work.</li> <li>• Check that the other component is made by Pioneer. The SR feature only works with Pioneer equipment.</li> <li>• Check that the IR receiver setting in <i>Multi-Room and IR receiver setup</i> on page 53 is correct.</li> </ul>

## HDMI

Symptom	Remedy
No picture or sound.	<ul style="list-style-type: none"> <li>• If the problem still persists when connecting your HDMI component directly to your monitor, please consult the component or monitor manual or contact the manufacturer for support.</li> </ul>
No picture.	<ul style="list-style-type: none"> <li>• Depending in the output settings of the source component, it may be outputting a video format that can't be displayed. Change the output settings of the source, or connect using the component, S-video or composite jacks.</li> </ul>
OSD does not appear.	<ul style="list-style-type: none"> <li>• The OSD will not appear if you have connected using the HDMI output to your TV. Use component, S-video, or composite connections when setting up the system.</li> </ul>
No sound, or sound suddenly ceases.	<ul style="list-style-type: none"> <li>• Since the HDMI audio signal is sent through this receiver to your TV, you need to make separate connections for audio if you want to hear your HDMI component through this system. See <i>Connecting using HDMI</i> on page 42 for more on this.</li> <li>• If you've made separate connections for audio, make sure you have assigned the analog/digital jack(s) to the corresponding HDMI input for the component. See <i>Assigning the HDMI inputs</i> on page 51 to do this.</li> <li>• Check the audio output settings of the source component.</li> </ul>

## XM radio messages

Symptom	Cause	Action
<b>Check Antenna</b>	The XM antenna is not connected.	Check that the XM antenna cable is attached securely.
<b>XM ANT ERR</b>	A short-circuit occurring in the antenna or surrounding antenna cable.	Make sure that there is nothing unusual with the antenna or antenna cable. Switch the power off then back on again.
<b>Updating</b>	The radio is being updated with the latest encryption code.	Wait until the encryption code has been updated. Channels 00 and 01 should function normally.
<b>No Signal</b>	The XM signal is too weak at the current location.	<i>n/a</i>
<b>Loading</b>	The receiver is acquiring audio or program information.	Wait until the information has been received.
<b>Off Air</b>	The channel currently selected has stopped broadcasting.	Select another channel.
<b>CH- - -</b>	You have selected a channel that does not exist, or that you have not subscribed to.	The receiver will automatically switch to channel 001 (or the last selected channel).
<b>- - - - -</b>	There is no artist name/feature, song/program title, or channel category associated with the channel at this time.	No action needed.



### Note

- If the unit does not operate normally due to external effects such as static electricity disconnect the power plug from the outlet and insert again to return to normal operating conditions.

## Surround sound formats

Below is a brief description of the main surround sound formats you'll find on DVDs, satellite, cable and terrestrial broadcasts, and video cassettes.

### Dolby

The Dolby technologies are explained below. See [www.dolby.com](http://www.dolby.com) for more detailed information.



### Dolby Digital

Dolby Digital is a multichannel digital audio coding system widely used in cinemas, and in the home for DVD and digital broadcast soundtracks. It can deliver up to six discrete audio channels, comprising five full range channels and a special LFE (low frequency effects) channel used mainly for deep, rumbling sound effects; hence the term "5.1-channel" Dolby Digital.

In addition to the format features above, Dolby Digital decoders offer downmixing for compatibility with mono, stereo and Dolby Pro Logic audio from a number of bit rates and channels. Another feature, called Dialog Normalization, attenuates programs based on the average level of dialog in a program relative to its peak level (also known as Dialnorm) in order to achieve uniform playback level.

### Dolby Digital Surround EX

Dolby Digital Surround EX (the EX stands for EXtended) is an extension of Dolby Digital encoding whereby a surround back channel is matrixed into the surround left/right channels for 6.1 channel playback. This allows for compatibility with Dolby Digital 5.1 channel decoding, as well as for decoding using Dolby Digital EX.

### Dolby Pro Logic IIx and Dolby Surround

Dolby Pro Logic IIx is an improved version of the Dolby Pro Logic II (and Dolby Pro Logic) *decoding* system. Using the innovative "steering logic" circuit, this system extracts surround sound from sources as follows:

- **Dolby Pro Logic** – 4.1 channel sound (mono surround) from any stereo source
- **Dolby Pro Logic II** – 5.1 channel sound (stereo surround) from any stereo source
- **Dolby Pro Logic IIx** – 6.1 or 7.1 channel sound (stereo surround and surround back) from two channel or 5.1 (and 6.1) channel sources

*With two channel sources, the ".1" subwoofer channel is generated by bass management in the receiver.*

Dolby Surround is an *encoding* system which embeds surround sound information within a stereo soundtrack, which a Dolby Pro Logic decoder can then use for enhanced surround listening with greater sound detail.

*Manufactured under license from Dolby Laboratories. "Dolby", "Pro Logic", "Surround EX", and the double-D symbol are trademarks of Dolby Laboratories.*

### DTS

The DTS technologies are explained below. See [www.dtstech.com](http://www.dtstech.com) for more detailed information.



### DTS Digital Surround

DTS Digital Surround is a 5.1-channel audio coding system from Digital Theater Systems Inc. now widely used for DVD-Video, DVD-Audio, 5.1 music discs, digital broadcasts, and video games. It can deliver up to six discrete audio channels, comprising five full range channels, including an LFE channel. Higher sound quality is achieved through the use of a low compression rate, and high rates of transmittance during playback.

### DTS-ES

DTS-ES (the ES stands for Extended Surround) is a decoder that is capable of decoding both DTS-ES Discrete 6.1 and DTS-ES Matrix 6.1 encoded sources. DTS-ES Discrete 6.1 gives 'true' 6.1 channel sound, with a completely separate (discrete) surround back channel. DTS-ES Matrix 6.1 has a surround back channel matrixed into the surround left/right channels. Both sources are also compatible with a conventional DTS 5.1 channel decoder.

### DTS Neo:6

DTS Neo:6 can generate 6.1 channel surround sound from any matrixed stereo source (such as video or TV) and from 5.1 channel sources. It uses both the channel information already encoded into the source, as well as its own processing to determine channel localization (with two channel sources, the ".1" subwoofer channel is generated by bass management in the receiver). Two modes (Cinema and Music) are available using DTS Neo:6 with two channel sources.

### DTS 96/24

DTS 96/24 is an extension of the original DTS Digital Surround which offers high quality 96 kHz/24-bit audio using a DTS 96/24 decoder. This format is also fully backward compatible with all existing decoders. This means that DVD players can play this software using a conventional DTS 5.1 channel decoder.

*"DTS", "DTS-ES", "Neo:6" and "DTS 96/24" are trademarks of Digital Theater Systems, Inc.*

### Windows Media® Audio 9 Professional

Windows Media® Audio 9 Professional (WMA9 Pro) is a discrete surround format developed by Microsoft Corporation.



WMA9 Pro can support up to 5.1/7.1 channel playback with sampling rates up to 24-bit/96 kHz. Using the unique WMA compression techniques, WMA9 Pro can deliver multichannel music and soundtracks over high-speed internet networks at low bit rates with minimal audio degradation. Playback may be enjoyed with the Windows Media® Player 9 Series (or above) and other third-party media players on a personal computer, or with an AV amplifier with on-board WMA9 Pro decoding.

*Windows Media® and the Windows logo are trademarks or registered trademarks of Microsoft Corporation in the United States and/or other countries.*

## About THX

The THX technologies are explained below. See [www.thx.com](http://www.thx.com) for more detailed information.



- **THX Cinema processing**

THX is an exclusive set of standards and technologies established by the world-renowned film production company, Lucasfilm Ltd. THX grew from George Lucas' personal desire to make your experience of the film soundtrack, in both movie theatres and in your home theatre, as faithful as possible to what the director intended. Movie soundtracks are mixed in special movie theatres called dubbing stages and are designed to be played back in movie theatres with similar equipment and conditions. This same soundtrack is then transferred directly onto Laserdisc, VHS tape, DVD, etc., and is not changed for playback in a small home theatre environment. THX engineers developed patented technologies to accurately translate the sound from the movie theatre environment into the home, correcting the tonal and spatial errors that occur. On this product, when the THX indicator is on, THX features are automatically added in Cinema modes (e.g. THX Cinema, THX Surround EX).

- **Re-Equalization**

The tonal balance of a film soundtrack will be excessively bright and harsh when played back over audio equipment in the home because film soundtracks were designed to be played back in large movie theaters using very different professional equipment. Re-Equalization restores the correct tonal balance for watching a movie soundtrack in a small home environment.

- **Timbre Matching**

The human ear changes our perception of a sound depending on the direction from which the sound is coming. In a movie theatre, there is an array of surround speakers so that the surround information is all around you. In a home theatre, you use only two speakers located to the side of your head. The Timbre Matching feature filters the information going to the surround speakers so that they more closely match the tonal characteristics of the sound coming from the front speakers. This ensures seamless panning between the front and surround speakers.

- **Adaptive Decorrelation**

In a movie theatre, a large number of surround speakers help create an enveloping surround sound experience, but in a home theatre there are usually only two speakers. This can make the surround speakers sound like headphones that lack spaciousness and envelopment. The surround sounds will also collapse into the closest speaker as you move away from the middle seating position. Adaptive

Decorrelation slightly changes one surround channel's time and phase relationship with respect to the other surround channel. This expands the listening position and creates—with only two speakers—the same spacious surround experience as in a movie theatre.

- **THX Select2**

Before any home theatre component can be THX Select2 certified, it must incorporate all the features above and also pass a rigorous series of quality and performance tests. Only then can a product feature the THX Select2 logo, which is your guarantee that the Home Theatre products you purchase will give you superb performance for many years to come. THX Select2 requirements cover every aspect of the product including pre-amplifier and power amplifier performance and operation, and hundreds of other parameters in both the digital and analog domain.

- **THX Surround EX**

THX Surround EX - Dolby Digital Surround EX is a joint development of Dolby Laboratories and the THX Ltd. In a movie theater, film soundtracks that have been encoded with Dolby Digital Surround EX technology are able to reproduce an extra channel which has been added during the mixing of the program. This channel, called Surround Back, places sounds behind the listener in addition to the currently available front left, front center, front right, surround right, surround left and subwoofer channels. This additional channel provides the opportunity for more detailed imaging behind the listener and brings more depth, spacious ambience and sound localization than ever before. Movies that were created using the Dolby Digital Surround EX technology, when released into the home consumer market may exhibit wording to that effect on the packaging. A list of movies created using this technology can be found on the Dolby web site at [www.dolby.com](http://www.dolby.com).

Only receiver and controller products bearing the THX Surround EX logo, when in the THX Surround EX mode, faithfully reproduce this new technology in the home.

This product may also engage the "THX Surround EX" mode during the playback of 5.1 channel material that is not Dolby Digital Surround EX encoded. In such case the information delivered to the Surround Back channel will be program dependent and may or may not be very pleasing depending on the particular soundtrack and the tastes of the individual listener.

- **Advanced Speaker Array (ASA)**

ASA is a proprietary THX technology which processes the sound fed to 2 side and 2 back surround speakers to provide the optimal surround sound experience. When you set up your home theater system using all eight speaker outputs (Left, Center, Right, Surround Right, Surround Back Right, Surround Back Left, Surround Left and Subwoofer) placing the two Surround Back speakers close together facing the front of the room as shown in the diagram will provide the largest sweet spot. If for practical reasons you have to place the Surround Back speakers apart, you will need to go to the THX Audio Set-up screen and choose the setting that most closely corresponds to the speaker spacing, which will re-optimize the surround sound-field.

ASA is used in three new modes; THX Select2 Cinema, THX MusicMode and THX Games Mode.

- **THX Select2 Cinema mode**

THX Select2 Cinema mode plays 5.1 movies using all 8 speakers giving you the best possible movie watching experience. In this mode, ASA processing blends the side surround speakers and back surround speakers providing the optimal mix of ambient and directional surround sounds.

DTS-ES (Matrix and 6.1 Discrete) and Dolby Digital Surround EX encoded soundtracks will be automatically detected in Select2 Cinema mode if the appropriate flag has been encoded.

Some Dolby Digital Surround EX soundtracks are missing the digital flag that allows automatic switching. If you know that the movie that

you are watching is encoded in Surround EX, you can manually select the THX Surround EX playback mode, otherwise THX Select2 Cinema mode will apply ASA processing to provide optimum replay.

• **THX MusicMode**

For the replay of multi-channel music the THX MusicMode should be selected. In this mode THX ASA processing is applied to the surround channels of all 5.1 encoded music sources such as DTS, Dolby Digital and DVD-Audio to provide a wide stable rear soundstage.

• **THX Games Mode**

For the replay of stereo and multi-channel game audio the THX Games Mode should be selected. In this mode THX ASA processing is applied to the surround channels of all 5.1 and 2.0 encoded game sources such as analog, PCM, DTS and Dolby Digital. This accurately places all game audio surround information, providing a full 360 degree playback environment. THX Games Mode is unique as it gives you a smooth transition of audio in all points of the surround field.

*The THX logo is a trademark of THX Ltd. which may be registered in some jurisdictions. All rights reserved.*

## Listening modes with different input signal formats

The following charts outline the listening modes available with different input signal formats, depending on the surround back channel processing and decoding method you have selected.

### Stereo (2 channel) signal formats

SBch Processing	Input signal format	Standard	THX	Auto Surround
<b>SBch Processing ON/AUTO</b> (Automatically selects 6.1/7.1 channel decoding)	Dolby Digital Surround	<input type="checkbox"/> Pro Logic IIx MOVIE <input type="checkbox"/> Pro Logic IIx MUSIC <input type="checkbox"/> Pro Logic IIx GAME <input type="checkbox"/> PRO LOGIC <sup>a</sup> Neo:6 CINEMA Neo:6 MUSIC	<input type="checkbox"/> Pro Logic IIx MOVIE+THX <input type="checkbox"/> PRO LOGIC+THX <sup>a</sup> Neo:6 CINEMA+THX THX GAMES MODE <sup>b</sup>	<input type="checkbox"/> Pro Logic IIx MOVIE
	DTS Surround	<i>As above</i>	<i>As above</i>	<b>Neo:6 CINEMA</b>
	XM Radio	<i>As above</i>	<i>As above</i>	<b>XM HD Surround</b>
	Other stereo sources	<i>As above</i>	<i>As above</i>	Stereo playback
	PCM 88.2 kHz / 96 kHz	<input type="checkbox"/> Pro Logic II MOVIE <input type="checkbox"/> Pro Logic II MUSIC <input type="checkbox"/> Pro Logic II GAME <input type="checkbox"/> PRO LOGIC <sup>a</sup>	–	Stereo playback
<b>SBch Processing OFF<sup>c</sup></b> (Maximum 5.1 channel playback)	Dolby Digital Surround	<input type="checkbox"/> Pro Logic II MOVIE <input type="checkbox"/> Pro Logic II MUSIC <input type="checkbox"/> Pro Logic II GAME <input type="checkbox"/> PRO LOGIC <sup>a</sup> Neo:6 CINEMA Neo:6 MUSIC	<input type="checkbox"/> Pro Logic II MOVIE+THX <input type="checkbox"/> PRO LOGIC+THX <sup>a</sup> Neo:6 CINEMA+THX	<input type="checkbox"/> Pro Logic II MOVIE
	DTS Surround	<i>As above</i>	<i>As above</i>	<b>Neo:6 CINEMA</b>
	Other stereo sources	<i>As above</i>	<i>As above</i>	Stereo playback
	PCM 88.2 kHz / 96 kHz	<input type="checkbox"/> Pro Logic II MOVIE <input type="checkbox"/> Pro Logic II MUSIC <input type="checkbox"/> Pro Logic II GAME <input type="checkbox"/> PRO LOGIC <sup>a</sup>	–	Stereo playback

a.  PRO LOGIC has a maximum of 5.1 channel playback.  
 b. Unavailable with only one surround back speaker connected.  
 c. Automatically selected if no surround back speakers are connected.

## Multichannel signal formats

SBch Processing	Input signal format	Standard	THX	Auto Surround
<b>SBch Processing ON</b> (7.1 channel decoding used for all sources)	WMA9 Pro (6.1/7.1 channel)	Straight decoding	<b>WMA+THX CINEMA</b>	Straight decoding
	Dolby Digital EX (6.1 channel flagged)	<b>Dolby Digital EX</b> □□ Pro Logic IIx MOVIE <sup>a</sup> □□ Pro Logic IIx MUSIC	<b>THX SURROUND EX</b> □□ Pro Logic IIx MOVIE+THX <sup>a</sup> THX Select2 CINEMA <sup>a</sup> THX MUSICMODE <sup>a</sup> THX GAMES MODE <sup>a</sup>	<b>Dolby Digital EX</b> □□ Pro Logic IIx MOVIE <sup>a</sup>
	DTS-ES (6.1 channel sources/6.1 channel flagged)	<b>DTS-ES</b> (Matrix/Discrete) <b>DTS+□□ Pro Logic IIx MOVIE<sup>a</sup></b> <b>DTS+□□ Pro Logic IIx MUSIC</b>	<b>DTS-ES+THX</b> (Matrix/Discrete) <b>DTS+□□ Pro Logic IIx MOVIE+THX<sup>a</sup></b> THX Select2 CINEMA <sup>a</sup> THX MUSICMODE <sup>a</sup> THX GAMES MODE <sup>a</sup>	<b>DTS-ES</b> (Matrix/Discrete)
	DTS (5.1 channel encoding)	<b>DTS+Neo:6</b> <b>DTS+□□ Pro Logic IIx MOVIE<sup>a</sup></b> <b>DTS+□□ Pro Logic IIx MUSIC</b>	<b>DTS+Neo:6+THX</b> <b>DTS+□□ Pro Logic IIx MOVIE+THX<sup>a</sup></b> THX Select2 CINEMA <sup>a</sup> THX MUSICMODE <sup>a</sup> THX GAMES MODE <sup>a</sup>	<b>DTS+Neo:6</b>
	Dolby Digital WMA9 Pro (5.1 channel encoding)	<b>Dolby Digital EX</b> □□ Pro Logic IIx MOVIE <sup>a</sup> □□ Pro Logic IIx MUSIC	<b>THX SURROUND EX</b> □□ Pro Logic IIx MOVIE+THX <sup>a</sup> THX Select2 CINEMA <sup>a</sup> THX MUSICMODE <sup>a</sup> THX GAMES MODE <sup>a</sup>	<b>Dolby Digital EX</b> □□ Pro Logic IIx MOVIE <sup>a</sup>
	DTS 96/24	Straight decoding (Maximum 5.1 channel playback)	–	Straight decoding (Maximum 5.1 channel playback)
<b>SBch Processing AUTO</b> (Automatically selects 6.1/7.1 channel decoding)	WMA9 Pro (6.1/7.1 channel)	Straight decoding	<b>WMA+THX CINEMA</b>	Straight decoding
	Dolby Digital EX (6.1 channel flagged)	<b>Dolby Digital EX</b> □□ Pro Logic IIx MOVIE <sup>a</sup>	<b>THX SURROUND EX</b>	<b>Dolby Digital EX</b> □□ Pro Logic IIx MOVIE <sup>a</sup>
	DTS-ES (6.1 channel sources/6.1 channel flagged)	<b>DTS-ES</b> (Matrix/Discrete)	<b>DTS-ES+THX</b> (Matrix/Discrete)	<b>DTS-ES</b> (Matrix/Discrete)
	Dolby Digital DTS WMA9 Pro (5.1 channel encoding)	Straight decoding (Maximum 5.1 channel playback)	<b>THX Select2 CINEMA</b> (Maximum 5.1 channel <b>THX CINEMA</b> playback with only one surround back speaker)	Straight decoding (Maximum 5.1 channel playback)
	DTS 96/24	Straight decoding (Maximum 5.1 channel playback)	–	Straight decoding (Maximum 5.1 channel playback)
<b>SBch Processing OFF<sup>b</sup></b> (Maximum 5.1 channel playback)	WMA9 Pro (6.1/7.1 channel)	Straight decoding (Maximum 5.1 channel playback)	<b>THX CINEMA</b>	Straight decoding (Maximum 5.1 channel playback)
	Dolby Digital EX (6.1 channel flagged) DTS-ES (6.1 channel sources/6.1 channel flagged)	Straight decoding	<b>THX CINEMA</b>	Straight decoding
	Dolby Digital DTS WMA9 Pro (5.1 channel encoding)			
	DTS 96/24	Straight decoding	–	Straight decoding

a.Unavailable with only one surround back speaker connected.

b.Automatically selected if no surround back speakers are connected.

## Specifications

### Amplifier section

Continuous average power output of 110 watts\* per channel, min., at 8 ohms, from 20 Hz to 20 000 Hz with no more than 0.09 %\*\* total harmonic distortion (front).

Continuous Power Output (20 Hz to 20 kHz, 8 Ω, 0.09 %)  
 Front . . . . . 110 W + 110 W  
 Center . . . . . 110 W  
 Surround . . . . . 110 W + 110 W  
 Surround back . . . . . 110 W + 110 W

Continuous Power Output (1 kHz, 6 Ω, 1.0 %)  
 Front . . . . . 150 W + 150 W  
 Center . . . . . 150 W  
 Surround . . . . . 150 W + 150 W  
 Surround back . . . . . 150 W + 150 W

Total harmonic distortion . . . . . 0.09 %  
 (20 Hz to 20 kHz, 110 W, 8 Ω)

\* Measured pursuant to the Federal Trade Commission's Trade Regulation rule on Power Output Claims for Amplifiers  
 \*\* Measured by Audio Spectrum Analyzer

### Audio Section

Input (Sensitivity/Impedance)  
 LINE . . . . . 335 mV/47 kΩ  
 Frequency Response (LINE) . . . . . 5 Hz to 100 000 Hz ±3 dB  
 Output (Level/Impedance)  
 REC . . . . . 335 mV/2.2 kΩ  
 Tone Control  
 BASS . . . . . ± 6 dB (100 Hz)  
 TREBLE . . . . . ± 6 dB (10 kHz)  
 LOUDNESS . . . . . +4 dB / +2 dB (100 Hz/10 kHz)  
 (at volume position -40 dB)  
 Signal-to-Noise Ratio (IHF, short circuited, A network)  
 LINE . . . . . 103 dB  
 Signal-to-Noise Ratio [EIA, at 1 W (1 kHz)]  
 LINE . . . . . 83 dB

### Composite Video / S-Video Section

Input (Sensitivity/Impedance) . . . . . 1 V<sub>p-p</sub>/75 Ω  
 Output (Level/Impedance) . . . . . 1 V<sub>p-p</sub>/75 Ω  
 Signal-to-Noise Ratio . . . . . 65 dB  
 Frequency Response . . . . . 5 Hz to 10 MHz

### Component Video Section

Input (Sensitivity/Impedance) . . . . . 1 V<sub>p-p</sub>/75 Ω  
 Output (Level/Impedance) . . . . . 1 V<sub>p-p</sub>/75 Ω  
 Signal-to-Noise Ratio . . . . . 65 dB  
 Frequency Response . . . . . 5 Hz to 100 MHz

### FM Tuner Section

Frequency Range . . . . . 87.5 MHz to 108 MHz  
 Usable Sensitivity . . . . . Mono: 13.2 dBf, IHF (1.3 μV/75 Ω)  
 50 dB Quieting Sensitivity . . . . . Mono: 20.2 dBf  
 Stereo: 38.6 dBf  
 Signal-to-Noise Ratio . . . . . Mono: 73 dB (at 85 dBf)  
 Stereo: 70 dB (at 85 dBf)  
 Distortion . . . . . Stereo: 0.5 % (1 kHz)  
 Alternate Channel Selectivity . . . . . 60 dB (400 kHz)  
 Stereo Separation . . . . . 40 dB (1 kHz)  
 Frequency Response . . . . . 30 Hz to 15 kHz ± 1dB  
 Antenna Input . . . . . 75 Ω unbalanced

### AM Tuner Section

Frequency Range . . . . . 530 kHz to 1700 kHz  
 Sensitivity (IHF, Loop antenna) . . . . . 350 μV/m  
 Selectivity . . . . . 25 dB  
 Signal-to-Noise Ratio . . . . . 50 dB  
 Antenna . . . . . Loop antenna

### Miscellaneous

Power Requirements . . . . . AC 120 V, 60 Hz  
 Power Consumption . . . . . 490 W, 650 VA  
 In standby . . . . . 0.5 W  
 AC Outlet . . . . . (switched) 100 W MAX.  
 Dimensions . . . . . 420 (W) mm x 173 (H) mm x 466 (D) mm  
 (16 <sup>9</sup>/<sub>16</sub> (W) in. x 6 <sup>13</sup>/<sub>16</sub> (H) in. x 18 <sup>3</sup>/<sub>8</sub> (D) in.)  
 Weight (without package) . . . . . 15.0 kg (33 lbs 1 oz)

### Furnished Parts

Setup microphone (for Auto MCACC setup) . . . . . 1  
 AA/IEC R6P dry cell batteries . . . . . 2  
 Remote control unit . . . . . 1  
 AM loop antenna . . . . . 1  
 FM wire antenna . . . . . 1  
 Warranty card . . . . . 1  
 These operating instructions

### Note

- Specifications and the design are subject to possible modifications without notice, due to improvements.

## Cleaning the unit

- Use a polishing cloth or dry cloth to wipe off dust and dirt.
- When the surface is dirty, wipe with a soft cloth dipped in some neutral cleanser diluted five or six times with water, and wrung out well, and then wipe again with a dry cloth. Do not use furniture wax or cleansers.
- Never use thinners, benzene, insecticide sprays or other chemicals on or near this unit, since these will corrode the surface.



### Dear Customer:

Selecting fine audio equipment such as the unit you've just purchased is only the start of your musical enjoyment. Now it's time to consider how you can maximize the fun and excitement your equipment offers. This manufacturer and the Electronic Industries Association's Consumer Electronics Group want you to get the most out of your equipment by playing it at a safe level. One that lets the sound come through loud and clear without annoying blaring or distortion-and, most importantly, without affecting your sensitive hearing.

Sound can be deceiving. Over time your hearing "comfort level" adapts to higher volumes of sound. So what sounds "normal" can actually be loud and harmful to your hearing. Guard against this by setting your equipment at a safe level BEFORE your hearing adapts.

#### To establish a safe level:

- Start your volume control at a low setting.
- Slowly increase the sound until you can hear it comfortably and clearly, and without distortion.

#### Once you have established a comfortable sound level:

- Set the dial and leave it there.

Taking a minute to do this now will help to prevent hearing damage or loss in the future. After all, we want you listening for a lifetime.

## We Want You Listening For A Lifetime

Used wisely, your new sound equipment will provide a lifetime of fun and enjoyment. Since hearing damage from loud noise is often undetectable until it is too late, this manufacturer and the Electronic Industries Association's Consumer Electronics Group recommend you avoid prolonged exposure to excessive noise. This list of sound levels is included for your protection.

#### Decibel Level Example

30	Quiet library, soft whispers
40	Living room, refrigerator, bedroom away from traffic
50	Light traffic, normal conversation, quiet office
60	Air conditioner at 20 feet, sewing machine
70	Vacuum cleaner, hair dryer, noisy restaurant
80	Average city traffic, garbage disposals, alarm clock at two feet.

#### THE FOLLOWING NOISES CAN BE DANGEROUS UNDER CONSTANT EXPOSURE

90	Subway, motorcycle, truck traffic, lawn mower
100	Garbage truck, chain saw, pneumatic drill
120	Rock band concert in front of speakers, thunderclap
140	Gunshot blast, jet plane
180	Rocket launching pad

Information courtesy of the Deafness Research Foundation.



S001\_En



Should this product require service in the U.S.A. and you wish to locate the nearest Pioneer Authorized Independent Service Company, or if you wish to purchase replacement parts, operating instructions, service manuals, or accessories, please call the number shown below.

8 0 0 - 4 2 1 - 1 4 0 4

Please do not ship your product to Pioneer without first calling the Customer Support Division at the above listed number for assistance.

Pioneer Electronics (USA) Inc.  
Customer Support Division  
P.O. BOX 1760, Long Beach,  
CA 90801-1760, U.S.A.

For warranty information please see the Limited Warranty sheet included with your product.

Should this product require service in Canada, please contact a Pioneer Canadian Authorized Dealer to locate the nearest Pioneer Authorized Service Company in Canada. Alternatively, please contact the Customer Satisfaction Department at the following address:

Pioneer Electronics of Canada, Inc.  
Customer Satisfaction Department  
300 Allstate Parkway, Markham, Ontario L3R OP2  
1(877)283-5901

For warranty information please see the Limited Warranty sheet included with your product.

Si ce produit doit être réparé au Canada, veuillez vous adresser à un distributeur autorisé Pioneer du Canada pour obtenir le nom du Centre de Service Autorisé Pioneer le plus près de chez-vous. Vous pouvez aussi contacter le Service à la clientèle de Pioneer:

Pioneer Électroniques du Canada, Inc.  
Service à la clientèle  
300, Allstate Parkway, Markham, Ontario L3R OP2  
1(877)283-5901

Pour obtenir des renseignements sur la garantie, veuillez vous reporter au feuillet sur la garantie restreinte qui accompagne le produit.

S018\_A\_EF

Published by Pioneer Corporation.  
Copyright © 2006 Pioneer Corporation.  
All rights reserved.

## **PIONEER CORPORATION**

4-1, Meguro 1-Chome, Meguro-ku, Tokyo 153-8654, Japan

### **PIONEER ELECTRONICS (USA) INC.**

P.O. BOX 1540, Long Beach, California 90810-1540, U.S.A. TEL: (800) 421-1404

### **PIONEER ELECTRONICS OF CANADA, INC.**

300 Allstate Parkway, Markham, Ontario L3R OP2, Canada TEL: 1-877-283-5901

### **PIONEER EUROPE NV**

Haven 1087, Keetberglaan 1, B-9120 Melsele, Belgium TEL: 03/570.05.11

### **PIONEER ELECTRONICS ASIACENTRE PTE. LTD.**

253 Alexandra Road, #04-01, Singapore 159936 TEL: 65-6472-7555

### **PIONEER ELECTRONICS AUSTRALIA PTY. LTD.**

178-184 Boundary Road, Braeside, Victoria 3195, Australia, TEL: (03) 9586-6300

### **PIONEER ELECTRONICS DE MEXICO S.A. DE C.V.**

Blvd.Manuel Avila Camacho 138 10 piso Col.Lomas de Chapultepec, Mexico,D.F. 11000 TEL: 55-9178-4270

K002\_A\_En

## Free Manuals Download Website

<http://myh66.com>

<http://usermanuals.us>

<http://www.somanuals.com>

<http://www.4manuals.cc>

<http://www.manual-lib.com>

<http://www.404manual.com>

<http://www.luxmanual.com>

<http://aubethermostatmanual.com>

Golf course search by state

<http://golfingnear.com>

Email search by domain

<http://emailbydomain.com>

Auto manuals search

<http://auto.somanuals.com>

TV manuals search

<http://tv.somanuals.com>