

Series number:  
25/C/2004 &  
25/D/2004

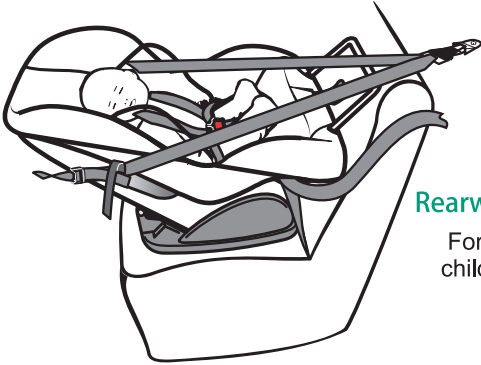

Arrive...Safe-n-Sound.

## Convertible Child restraint for vehicle use.



### Rearward Facing

For use with  
children up to  
12kg.

### Forward Facing.

For use with children  
from  
8kg up to 18kg.



#### INFORMATION FOR BUYERS:

FOR USE WITH CHILDREN FROM BIRTH TO 18 KG.  
CHECK THAT THIS CHILD RESTRAINT WILL FIT IN  
YOUR CAR.

IMPORTANT: KEEP THIS BOOKLET IN THE PLACE  
PROVIDED ON THE CHILD RESTRAINT.

*Instructions for  
Installation & Use*

**COMPAQ™ & COMPAQ™ DELUXE**

## FOR TODDLER AND CHILD USE

WHO TO CONTACT	2.	INTRODUCTION	3.
<b>WARNINGS</b>	3.	HOW TO INSTALL	4.

## FOR BABY USE

SPECIAL FEATURES	7.
SUITABLE FOR USE	8.
<b>WARNINGS</b>	8.
HOW TO SET-UP	9.
HOW TO INSTALL	11.
HOW TO USE	13.
CROTCH STRAP POSITION (13)	



























## FOR CHILD USE

SPECIAL FEATURES	15.
SUITABLE FOR USE	16.
<b>WARNINGS</b>	16.
HOW TO SET-UP	17.
HOW TO INSTALL	18.
HOW TO USE	21.
CROTCH STRAP POSITION (21)	

## FOR BABY AND CHILD USE

HOW TO CLEAN	22.	TRAVELLING TIPS	26.
CARE & MAINTENANCE	23.	IN CASE OF ACCIDENT	27.
ACCESSORIES & FEATURES	24.		

## EASY SELECTOR GUIDE

	Birth	8kg	9kg	12kg	14kg	18kg	26kg	32kg
Infant Restraint								
Convertible Child Car Seat								
Forward-Facing Child Car Seat								
Convertible Booster Seat								
Child Booster Seats and Booster Cushions								
Child Harness								

Refer to Catalogue.

## WHO TO CONTACT

### AUSTRALIA

Britax Childcare Pty. Ltd. A Britax International company.  
(Incorporated in Victoria) A.C.N. 006 773 600 A.B.N 55 006 773 600

Head office: 99 Derby Road Sunshine, Victoria 3020  
Phone: (03) 9288 7288 Fax: (03) 9311 5798

For interstate and country enquiries, Service & Spare Parts (9:30am to 5:00pm E.S.T.) Phone: 1300 303 330

### NEW ZEALAND

Britax Childcare NZ Limited. A Britax International company.  
PO Box 100-247 Auckland 9 Phone: (09) 443 0102  
Fax: (09) 443 0120 Phone toll free: 0800 688 822.

### INTERNATIONAL ENQUIRIES

Contact your Local Distributor.

# INTRODUCTION & IMPORTANT INFO

No child restraint can guarantee absolute protection from injury in every crash. However, to ensure that your child gets all the protection designed into the restraint PLEASE READ AND FOLLOW THESE INSTRUCTIONS EXACTLY. In the event of doubt about the method of installation, consult Britax Childcare or agent or a child restraint fitting station authorised by the relevant transport authority or in New Zealand, the agent for the vehicle. Use only Safe-n-Sound recommended parts and accessories, which are available from most Safe-n-Sound retailers (refer to page 24 for accessories).

## WARNINGS

Use the restraint exactly as shown in the instructions.

Fit the restraint firmly to the car seat.

Fit the harness firmly to the child.

A loose restraint or harness is dangerous.

Supervision of children is needed because they may be able to undo buckles and adjusters.

**DO NOT LEAVE CHILDREN UNATTENDED IN THE CAR.**

Do not alter or modify this restraint.

Repairs must only be done by the manufacturer or agent.

Do not allow the restraint to come into contact with polishes, oils, bleach and other chemicals.

**THIS RESTRAINT MUST BE ATTACHED TO A CHILD RESTRAINT ANCHORAGE POINT IN THE CAR. REFER TO CAR OWNER'S HANDBOOK FOR LOCATION OF ANCHORAGE POINTS. REFER TO A CHILD RESTRAINT FITTING STATION IF NO ANCHORAGE POINTS ARE IN THE MOTOR CAR.**

Destroy the restraint if it has been in a severe crash, even if no damage is visible.

**DO NOT USE THIS RESTRAINT WITHOUT THE COVER.**

Do not use seat belt extenders, even if the car seat belt is not long enough to secure the child restraint.

Regularly check the restraint components, straps and other fitments for correct function & condition. Seek prompt repair.

To ensure baby's back is evenly supported do not put more than one nappy on the baby and make sure the nappy is not thickly folded at the back.

**DO NOT USE CHILD RESTRAINTS IN A SEATING POSITION WHERE AN AIRBAG IS FITTED. FOLLOW THE CAR MANUFACTURER'S RECOMMENDATIONS.**

The restraint is not intended to be a substitute baby cot or bed. It is designed to enable safe transportation of children in motor vehicles.

**THIS RESTRAINT IS NOT SUITABLE FOR USE IN A HATCHBACK OR WAGON WHERE THE ANCHORAGE STRAP MAY FALL INTO A SPLIT IN THE SEAT BACK.**

Protect all webbing from abrasion and cutting by sharp corners and edges.

Straps may be damaged by unsecured cargo in a collision. Secure or remove hazardous cargo before using this restraint.

The restraint should not be purchased or sold as a second hand item. It is recommended not to use child restraints older than 10 years as the protection in an accident may be reduced.

# HOW TO INSTALL

Consult the vehicle owner's handbook for location of anchor fittings or anchorage points and the possible use of spacers. Some vehicles may have an anchor fitting fitted by the vehicle manufacturer. If anchorage points cannot be found refer to car manufacturer or local child restraint fitting station or traffic authority for optimum position of anchorage point and the use of spacers.

## UPPER ANCHORAGE STRAP



**IMPORTANT WARNING: THE ATTACHMENT CLIP COVER MUST ALWAYS BE USED AS IT PREVENTS THE RISK OF INCORRECT FITMENT OF THE ATTACHMENT CLIP TO THE ANCHOR FITTING. ALWAYS ENSURE THAT THE ATTACHMENT CLIP IS CORRECTLY ENGAGED TO THE ANCHOR FITTING AND NOT HOOKED OR FITTED TO ANY OTHER OBJECT BEFORE EACH USE OF THE RESTRAINT. THIS IS ESPECIALLY IMPORTANT IN VEHICLES SUCH AS STATION WAGONS, VANS, HATCH BACKS OR VEHICLES WITHOUT A FIXED PARCEL SHELF, SINCE THE ANCHOR POINT IS USUALLY NOT VISIBLE.**

### IMPORTANT INSTALLATION NOTE:

In some vehicles the anchor fitting in the rear vertical panel can only be installed in one way. Please refer to vehicle owner's handbook or a child restraint fitting station for correct method.

Extension Strap distance to be measured:

Length 300mm -

(Use Safe-n-Sound part 0035 or equivalent).

Length 600mm -

(Use Safe-n-Sound part 0036 or equivalent).

Available from all major child restraint retailers.

Rear facing installation may require a longer extension strap.

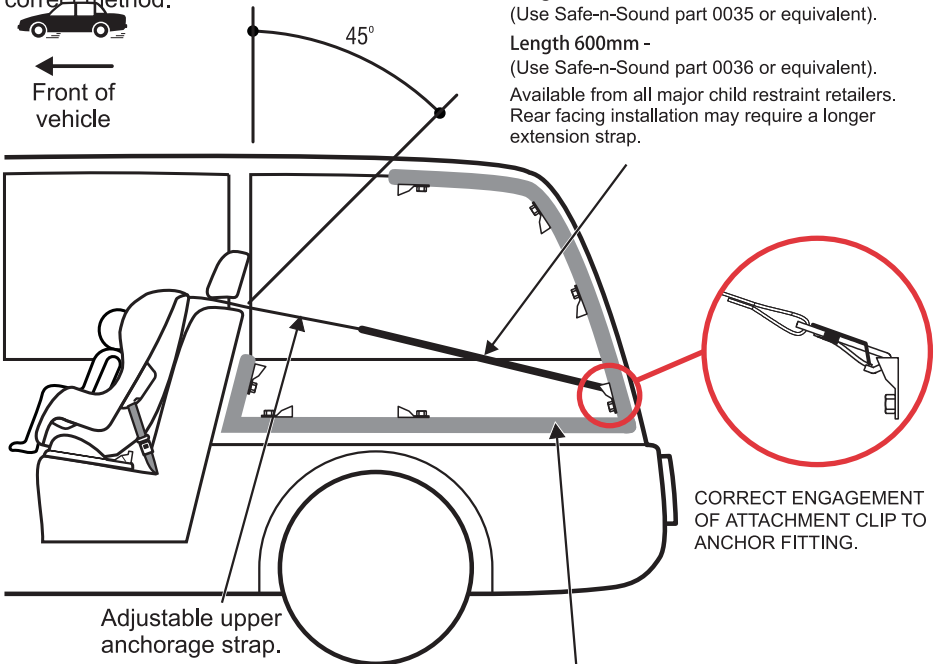

The shaded areas of this diagram illustrate the possible locations of the anchor fitting. Within each shaded area is an anchor fitting showing the correct way to install the fitting. Ensure the anchor fitting is aligned as illustrated unless stated otherwise in the vehicle owner's handbook.

# HOW TO INSTALL

## ANCHOR FITTING:

**⚠ WARNING: CHILD RESTRAINTS MUST NOT BE ATTACHED TO UNSOUND METAL OR TO WOOD, OR SYNTHETIC STRUCTURES. WHEN DRILLING 9 MM HOLE DO NOT DRILL THROUGH FUEL LINES, FUEL TANKS, ELECTRICAL WIRING, OR RADIO SPEAKERS. WEBBING STRAPS MUST BE PROTECTED FROM SHARP CORNERS AND EDGES. THE ANCHOR FITTING MUST BE USED ONLY AS DESCRIBED ABOVE. IT MUST NOT BE HOOKED ONTO ANY OTHER OBJECT.**

If the car is fitted with child restraint anchorage point...

Locate the anchorage point behind the rear seating position to be used. Consult the car owners handbook for the location of the anchorage points. The anchorage point should be directly behind and central to the restraint. Remove thread plug from the parcel shelf, floor/roof, etc. and install anchor bolt and fitting as shown right.

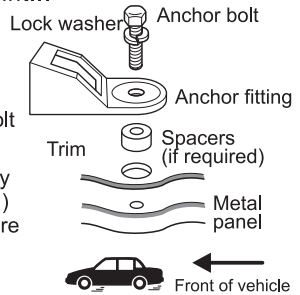

**CAUTION:** Do not overtighten anchor bolt. Overtightening may fracture or break bolt. Maximum torque is 20 N.m. (14.75 ft.lb.)  
Note: Minimum of five full turns of anchor bolt is required before tightening force is applied. Do not overtighten.

If the car is not fitted with child restraint anchorage points...

For Sedans only - Drill 9mm diameter hole in the parcel shelf on the centreline of the seating position as shown right. Before drilling the hole, check the underside for accessibility.

For vehicles other than Sedans - In Australia, consult your nearest child restraint fitting station or traffic authority for vehicle inspection to find the best, correct position for the placement of the anchorage point, and for the correct attachment bolt length and use of spacers. In New Zealand, consult the agent for the vehicle.

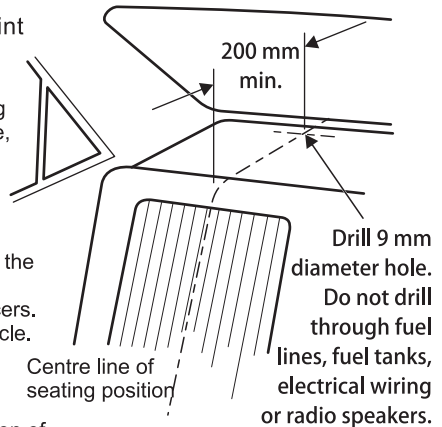

Note to Queensland purchasers: The installation of anchorage points must be approved by authorised officers appointed by Queensland Transport. Authorised officers can be sourced from all Queensland Transport Customer Service and Queensland Ambulance Service Centres.

ONLY USE A 5/16 UNC GRADE 5 BOLT.  
IF THE BOLT IS NOT THE CORRECT LENGTH THE CAR MANUFACTURER'S HAND BOOK CAN PROVIDE ADVICE ON THE CORRECT LENGTH BOLT.

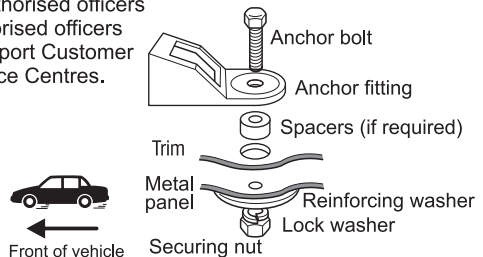

# HOW TO INSTALL

**Important:** If using an Extension Strap, positioning the Attachment Clip above the baby may lead to injury in an accident therefore make sure that the Attachment Clip is not positioned in front of the vehicle seat.



Front of vehicle

Attachment Clip must not be in front of the vehicle seat front.

Attachment Clip must be behind the front of the vehicle seat.

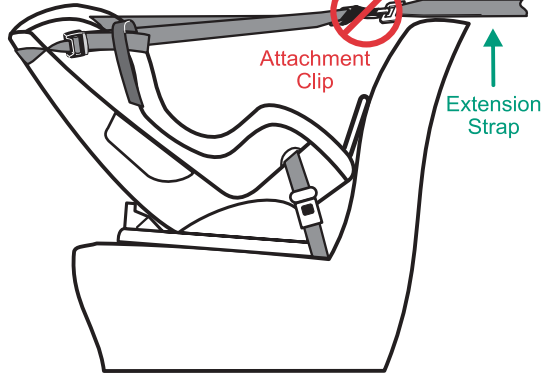

## ANGULAR ADJUSTMENT OF RESTRAINT

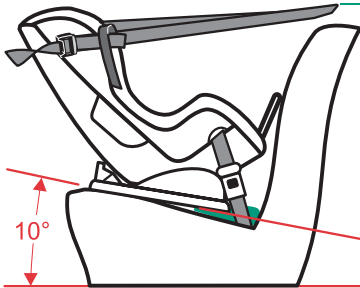

Some vehicle seats have more rearward slope than others. If the angle of the seat causes the baby to be too upright for comfort, the angle may be altered by placing a firm packing between the seat and the underside of the base. Packing can be a firmly rolled up towel or nappy.

Do not remove all of the rearward slope by over packing. Always leave a rearward slope angle of approximately 10 degrees.

## TO REMOVE RESTRAINT FROM VEHICLE

- Disengage seat belt tongue from buckle and remove from restraint.
- Fully press Upper Anchorage Strap Adjuster Button (A) while pulling Upper Anchorage Strap (B) to slacken as shown right. In some vehicles loosening of the Upper Anchorage Strap may be difficult. If so, try pushing the restraint against the vehicle seat back or slightly lifting the restraint to release the tension.
- Disengage Attachment Clip from Anchor Fitting. The child restraint is now disconnected.

Fully press Adjuster Button (A) while pulling Upper Anchorage Strap (B) to lengthen.

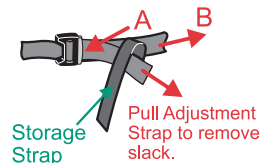

# SPECIAL FEATURES FOR BABY USE

FOR  
BABY  
USE



Front of  
vehicle

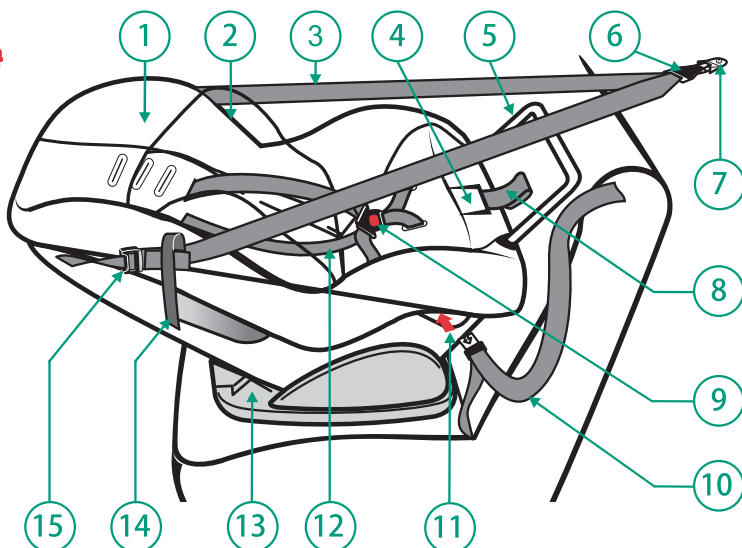

1. Padded cover for baby's comfort.
2. Padded insert for extra comfort. (If supplied)
3. Adjustable Upper Anchorage Strap.
4. Harness Adjuster Lock. (Under flap)
5. Stabilising Bar for baby use.
6. Attachment Clip & Cover.
7. Anchor Fitting.
8. Harness Adjustment Strap.
9. Quick release Harness Buckle. (Red Button)
10. Vehicle seat belt.
11. Easy fitting of lap or lap-sash seat belts.
12. Fully adjustable 6 point harness.
13. Recline Base in baby position.
14. Upper Anchorage Storage Strap.
15. Upper Anchorage Strap Adjuster.
16. Recline foot in baby position.

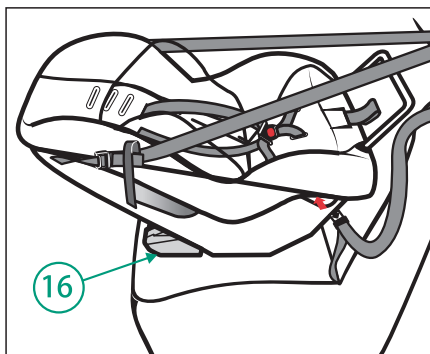



FOR  
BABY  
USE

# SUITABLE FOR USE

TO BE USED WITH A LAP-SASH OR LAP ONLY SEAT BELT IN THE FRONT OR BACK OF MOST CARS WITH FORWARD-FACING SEATS.

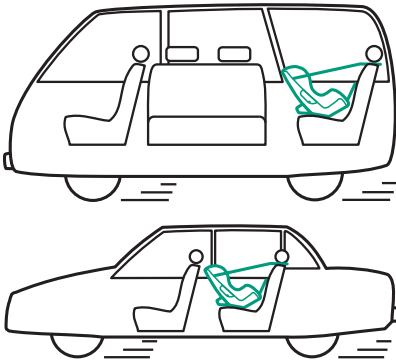

To be used only in a rearward-facing position for a child weighing up to 12kg.

Up to 12 kg Facing Rearward

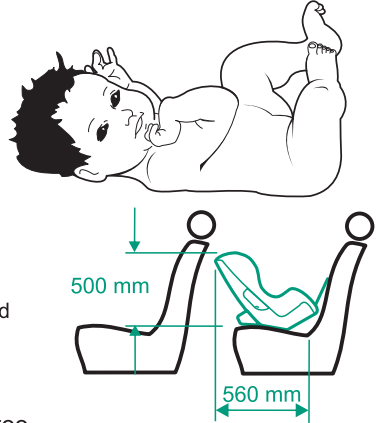

The purchaser should check the measurements between the front of the seat back of the rear seat and all front seats in the car in which the child restraint is intended to be used, to ensure that the space is sufficient.

In certain vehicles, where the rear seat area is too restricted, the only position possible for the restraint is on the front seat and adjusted as rearward as possible (provided no airbag is fitted in this position).

## WARNINGS

**DO NOT USE RESTRAINT IN REARWARD FACING MODE WITHOUT STABILISING BAR FULLY EXTENDED.**

Do not use the restraint without the Upper Anchorage Strap correctly attached.

**DO NOT USE CHILD RESTRAINTS IN A SEATING POSITION WHERE AN AIR BAG IS FITTED. FOLLOW THE CAR MANUFACTURER'S RECOMMENDATIONS.**

If your vehicle is not fitted with an anchor point, please contact a Safety Restraint Fitting Station authorised by the relevant State Government Body for correct fitment of the restraint. In New Zealand contact the agent for the vehicle. The upper anchorage strap must be attached to an anchorage point using an extension strap if necessary.

Do not use on any vehicle seat which faces sideways or rearwards.

When using the restraint in the front seat, do not use the rear seat. The upper anchorage strap will need to pass the rear seating position to attach to an anchorage point.



Do not allow the front seat to alter the installed position of the restraint.





# HOW TO SET-UP

## SETTING UP THE HARNESS

- Sit the restraint on a flat ground and supported from behind so that it will not tip over.
- Get the child to sit comfortably in position.
- Determine the desired shoulder strap position.
- Remove the child and adjust the shoulder straps using the following methods.
- Repeat steps A-C to confirm the correct set-up of the built-in harness.

## ADJUSTING SHOULDER HARNESS STRAPS HEIGHT FOR BABY USE REARWARD FACING

Correct fitment of the harness is very important as it restrains the baby in the restraint. The harness must fit firmly around upper torso of the baby and be positioned so as to leave the baby's arms and legs free.

For baby up to 12 kg the shoulder straps must be in the slots which are nearest to the child's shoulders, but not lower than the child's shoulders. If your baby weighs more than 12 kg then the restraint should be converted for child use. (Refer to Forward Facing, 'Child Use' section.)

### REARWARD FACING - BIRTH TO 12kg

Harness straps over bar

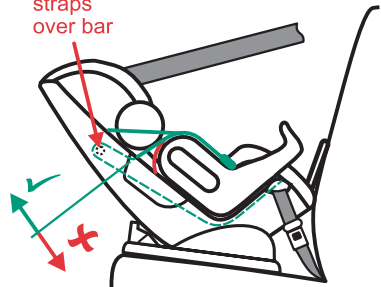

Under 12kg

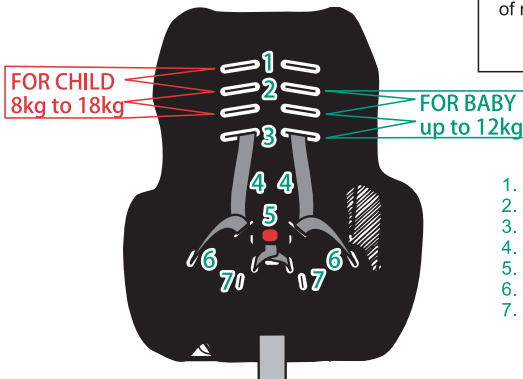
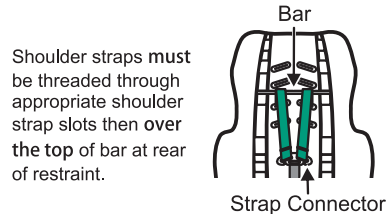



- Upper shoulder strap slots.
- Medium shoulder strap slots.
- Lower shoulder strap slots.
- Shoulder harness strap.
- Harness tongues and buckle.
- Lap strap slot.
- Baby Crotch Strap Slot (inner).

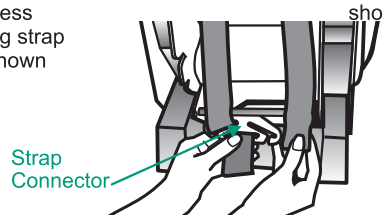

## STEPS IN CHANGING SHOULDER STRAP SLOTS

- A. Remove the restraint from vehicle as instructed on page 6.
- B. At the rear of the restraint, remove one of the harness upper straps from metal Strap Connector by slipping strap through open slot. The metal Strap Connector is shown in diagram right.
- C. Pull the shoulder strap through slot.
- D. Insert shoulder strap through restraint slot which will position shoulder strap level with or above the child's shoulder, then over the metal bar. Ensure that the shoulder strap passes through matching slots in cover and restraint body.
- E. Connect shoulder strap to metal strap connector at rear of restraint, ensuring that there are no twists in the shoulder strap.
- F. Repeat for other shoulder strap. It is better to change one strap at a time so that the other strap will be a guide for re-assembly.



-  **WARNING:** Ensure the shoulder strap is threaded through the slot, then over the top of the bar at the rear of restraint & connected to the metal strap connector.
-  **WARNING:** Do not use the restraint with harness shoulder straps set at different heights or fed through mis-matching slots. Ensure harness straps are not twisted and that all straps are secure by pulling each harness strap.

Remove the Padded Insert while adjusting harness. The Padded Insert should not be used once baby weighs 10kg or over, or if it creates discomfort. If an older baby's legs do not have enough room, convert to child use mode (provided baby's weight is over minimum 8kg).

## HOW TO INSTALL

### INSTALLING INTO VEHICLE (REARWARD FACING)

- A. If Upper Anchorage Strap is folded up for storage undo Storage Strap then lengthen as illustrated right.

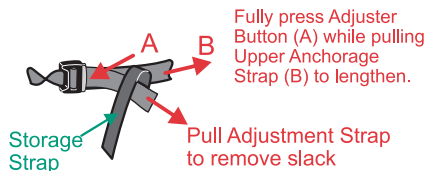



# HOW TO INSTALL

## COMPAQ DELUXE

- B. For baby use, you must first fully recline the restraint, to convert the restraint to baby use mode as shown below.

Lift Blue Recline Latch and pull seat forward to recline

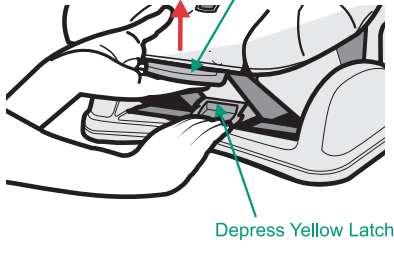

- C. Unhook hook and loop attachments and gently lift the cover, fully extend out stabilising bar and gently push bar forward until a click is heard. Stabilising Bar is now in place. **Note: Do not re-attach cover hook and loop attachments until you have installed seat belt.**
- D. If desired, use a seat protector, messy mat, or towel to protect the car seat fabric. Some car seat fabrics may be damaged by the restraint.
- E. Position restraint rearward facing in the chosen seating position.
- F. Feed the seat belt between the seat cover and the restraint body through seat belt slots in restraint as shown below.

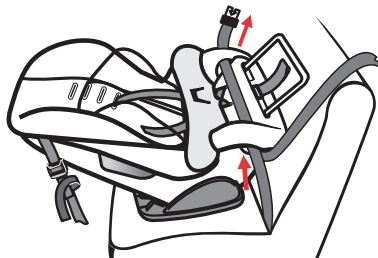

- G. Engage seat belt buckle and tongue.

## COMPAQ

- B. Move Recline Foot by grasping Foot, pressing the Recline Foot Locking Bar while rotating to the baby position (refer to label on the side of the restraint) until the Locking Bar locks into position. Ensure Recline Foot locks into position.

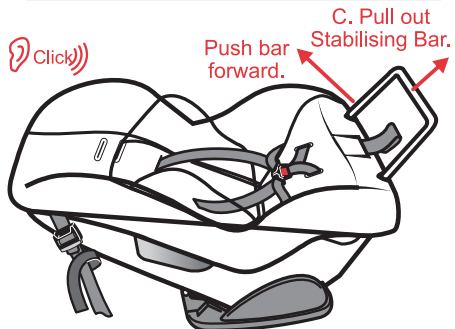
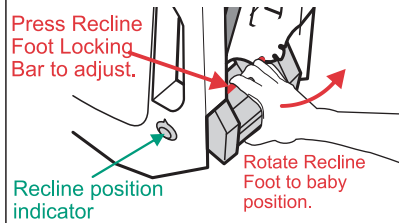

- H. Re-Attach hook and loop attachments and align restraint centrally to the chosen seating position.

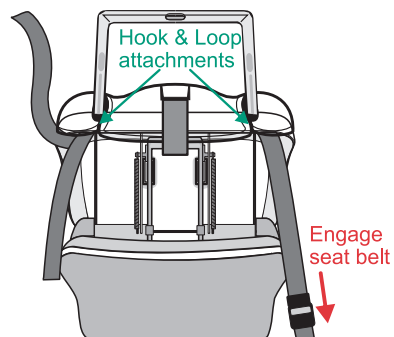



FOR  
BABY  
USE

# HOW TO INSTALL

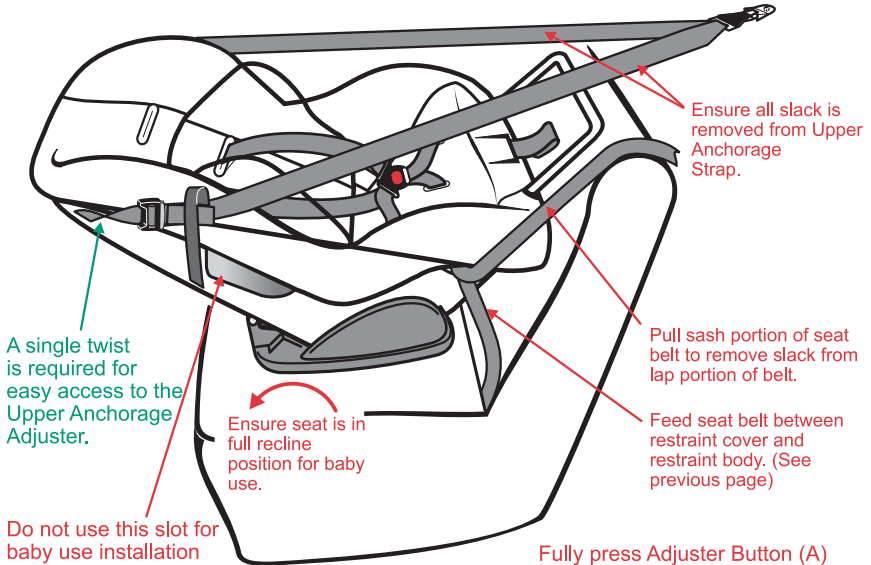

←  
Front of  
vehicle

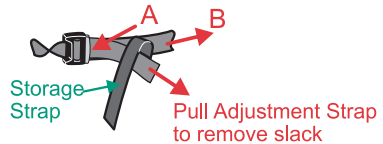

Note: Seat belt buckle and tongue must not rest between restraint cover and restraint. If the seat belt buckle is adjustable, adjust the buckle as low as possible away from the restraint.

- H. Push down on the restraint while pulling the sash portion of seat belt until all slack is removed from Lap portion of seatbelt. Adjust seat belt to hold the restraint firmly against the vehicle seat back. For retractor seat belts, allow excess belt to feed back into retractor.
- I. Fit the attachment clip to the anchor fitting as shown right. Make sure to remove as many twists as possible from the upper anchorage strap.
- J. Tighten adjustable upper anchorage strap by pulling adjustment strap to remove slack, but do not over-tighten causing the restraint base to lift off the vehicle seat.

Attachment  
Clip & Cover

Anchor  
fitting



**WARNING: DO NOT USE RESTRAINT IN REARWARD FACING MODE WITHOUT STABILISING BAR FULLY EXTENDED.**



# HOW TO USE

## PLACING BABY INTO RESTRAINT CROTCH STRAP POSITION - BABY USE

The crotch straps must be in the inner position to accommodate the smaller child. Refer to page 23 (Care & Maintenance) instructions and follow point A. Ensure both crotch straps are in the inner position as shown right.

A. The harness shoulder straps should first be set to the correct height position. Refer to page 9 for adjusting shoulder harness strap height. The restraint can be used with or without the Padded Insert.

B. Ensure Upper Anchorage Strap is attached to Anchor Fitting, then slacken Upper Anchorage Strap and allow to fall to the sides of the restraint for easy access to the baby.

C. Slacken Harness Straps by pushing Harness Adjuster up, grasping both shoulder harness straps and pulling out desired amount of slack. Release Harness Adjuster lock when there is enough slack and place harness to each side of restraint.

D. Lay baby on its back into restraint and fit harness as shown above. Make sure baby is dressed to allow harness buckle to be pulled up between baby's legs e.g. a jump suit. Make sure baby's arms and legs are free. **Never wrap baby in a blanket before placing in restraint.**

E. Fit either harness tongue into the harness buckle followed by the other tongue until a click is heard. Should the second tongue not insert, press the red button and reinsert the tongues. Ensure secure engagement by pulling harness straps.

Inner Crotch  
Strap Position

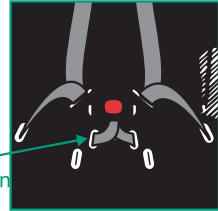

Harness  
shoulder  
straps.

Padded Insert,  
if supplied, snugly  
supports the baby  
for extra comfort.

Slackened Upper  
Anchorage Strap.

Lift up  
Adjuster.  
(under flap)

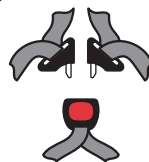
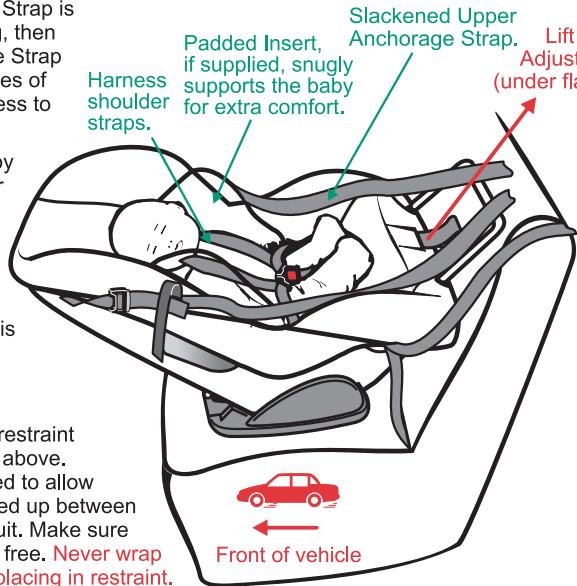

Click



- F. Pull lap and crotch straps firmly. Pull shoulder harness straps to remove slack from harness lap straps.
- G. Pull harness adjustment strap to take up the slack in the harness adjusting to a comfortable but firm fit.
- H. Remove slack from Upper Anchorage Strap by pulling Adjustment Strap to remove slack as shown below.

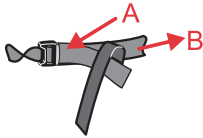

Fully press Adjuster Button (A) while pulling Upper Anchorage Strap (B) to lengthen.

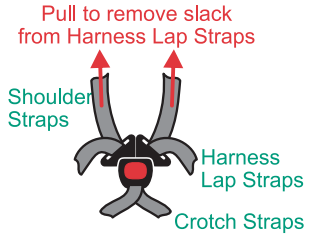

Make sure that nothing is obstructing harness straps and that baby's arms and legs are free. Minimise slack in straps as instructed in item F above. Do not use restraint if straps do not tighten and contact your local authorised service agent for repair.

## REMOVING BABY FROM RESTRAINT

- A. Press Upper Anchorage Strap Adjuster Button (A) while pulling Upper Anchorage Straps (B) to slacken. Allow Upper Anchorage Straps (B) to fall to the sides for easy access into restraint.
- B. Push Harness Strap Lock up (under flap), while pulling each Shoulder Harness Strap to slacken harness to the desired amount.
- C. Press red button on Harness Buckle then both Harness Tongues will be released. Move each shoulder strap to baby's side then pick up baby.

# SPECIAL FEATURES FOR CHILD USE

FOR  
CHILD  
USE



To be used only in a forward-facing position for a child weighing from 8 kg to 18 kg.

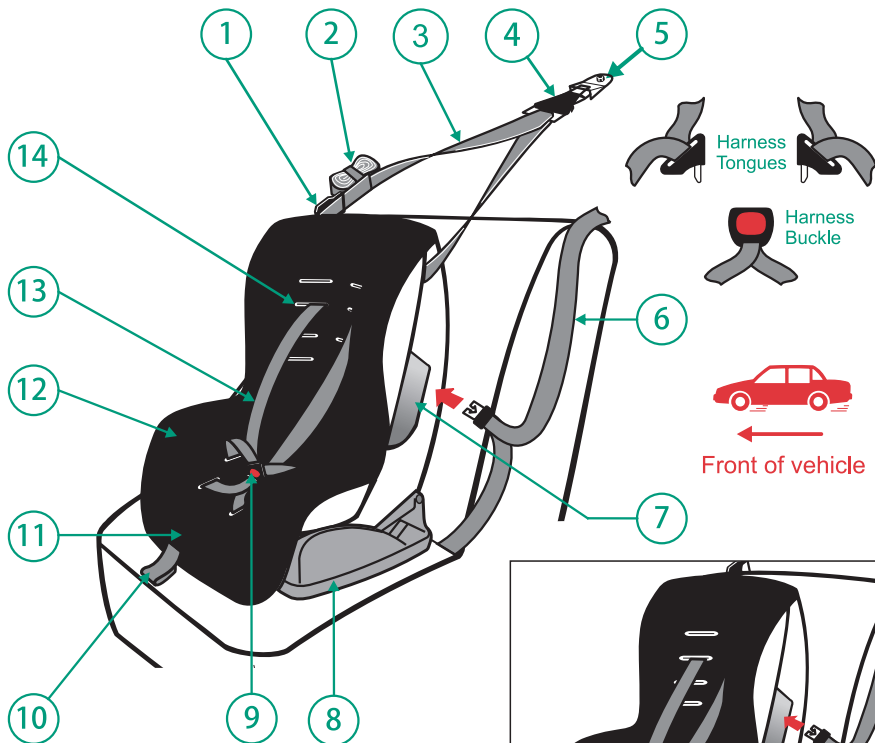

1. Upper Anchorage Strap Adjuster.
2. Upper Anchorage Strap.
3. Adjustable Upper Anchorage Strap.
4. Attachment Clip & Cover.
5. Anchor Fitting.
6. Vehicle seat belt.
7. Easy fitting of lap or lap-sash seat belts.
8. Recline Base in child position.
9. Quick release Harness Buckle. (Red Button)
10. Harness Adjustment Strap.

11. Harness Adjuster Lock. (Under flap)
12. Padded cover for comfort.
13. Fully adjustable 6 point harness.
14. 4 position Adjustable height of shoulder straps.
15. Recline foot in child position.



# SUITABLE FOR USE

TO BE USED WITH A LAP-SASH OR LAP ONLY SEAT BELT IN THE FRONT OR BACK OF MOST CARS WITH FORWARD-FACING SEATS.

To be used only in a forward facing position for a child weighing from 8 kg to 18 kg.

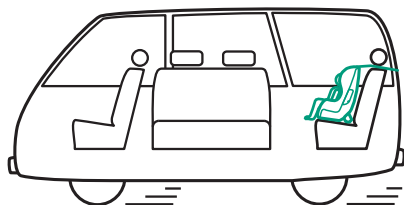

8 kg min.  
18 kg max.

## WARNINGS

**DO NOT USE RESTRAINT IN FORWARD-FACING POSITION WITH THE STABILISING BAR PULLED OUT.**

Do not use the restraint without the Upper Anchorage Strap correctly attached.

If your vehicle is not fitted with an anchor point, please contact a Safety Restraint Fitting Station authorised by the relevant State Government Body for correct fitment of the restraint. In New Zealand contact the agent for the vehicle. The upper anchorage strap must be attached to an anchorage point using an extension strap if necessary.

When using the restraint in the front seat, do not use the rear seat. The upper anchorage strap will need to pass the rear seating position to attach to an anchorage point.

Do not use on any vehicle seat which faces sideways or rearwards.

**DO NOT USE A CHILD RESTRAINT IN A SEATING POSITION WHERE AN AIRBAG IS FITTED. FOLLOW CAR MANUFACTURER'S RECOMMENDATIONS.**





# HOW TO SETUP

## ADJUSTING SHOULDER HARNESS STRAPS HEIGHT FOR CHILD USE FORWARD-FACING

Correct fitment of the harness is very important as it restrains the child in the restraint. The harness must fit firmly around the upper torso of the child and be positioned so as to leave the child's arms and legs free. The shoulder straps must be in the slots which are nearest to the child's shoulders, but not more than 25mm below the child's shoulders. If the harness straps are more than 25 mm below the level of the child's shoulders then the child is too large for the restraint and the restraint should not be used.

The shoulder straps must be in the slots which are nearest to the child's shoulders, but not more than 25mm below the child's shoulders.



Front of  
vehicle

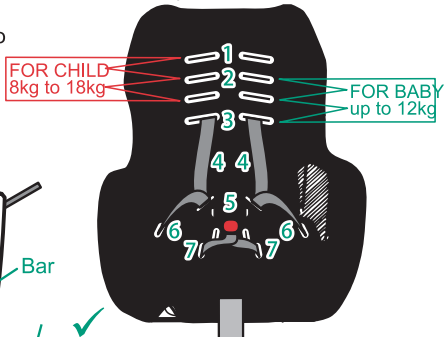
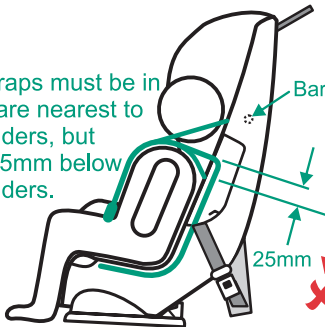

1. Upper shoulder strap slots.
2. Medium shoulder strap slots.
3. Lower shoulder strap slots.
4. Shoulder harness straps.
5. Harness tongues & buckle.
6. Lap strap slots.
7. Child crotch strap slots (outer).

## STEPS IN CHANGING SHOULDER STRAP SLOTS

- A. Remove the restraint from vehicle as instructed on page 6.
- B. At the rear of the restraint, remove one of the harness shoulder straps from metal Strap Connector by slipping strap through open slot. The metal Strap Connector is shown in diagram on right.
- C. Pull the shoulder strap through slot.
- D. Insert shoulder strap through restraint slot which will position shoulder strap level with or above the child's shoulder and then under the metal bar. Ensure that the shoulder strap passes through matching slots in cover and restraint body.
- E. Ensure the shoulder strap is threaded through the slot, then **under the bar** at the rear of the restraint before connecting to the metal strap connector. At rear of restraint, ensuring that there are no twists in the shoulder straps.
- F. Repeat for other shoulder strap. It is better to change one strap at a time so that the other strap will be a guide for re-assembly.

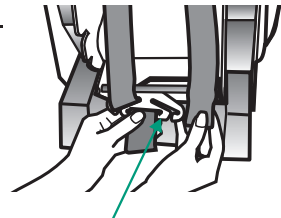

Strap Connector



**WARNING:** Do not use the restraint with harness shoulder straps set at different heights or fed through mis-matching slots. Ensure harness straps are not twisted and that all straps are secure by pulling each harness strap.



## INSTALLING INTO VEHICLE (FORWARD FACING)

### (UPRIGHT OR RECLINED)

DO NOT USE RESTRAINT IN FORWARD-FACING MODE WITH THE STABILISING BAR PULLED OUT.

- A. If the Stabilising Bar is extended unhook Hook and Loop attachments and push trim away from restraint.
- B. Press blue button on left side (facing seat) and gently push stabilising bar all the way into recessed area.

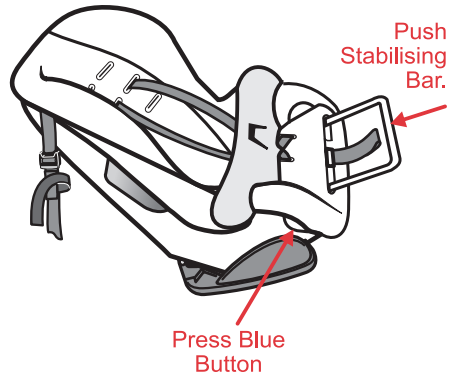
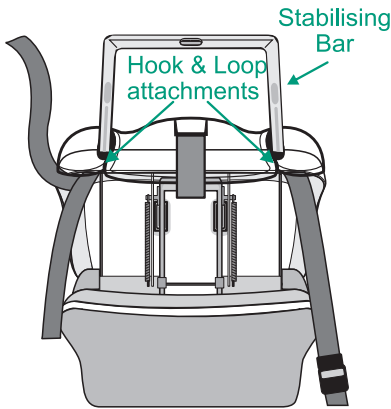

- C. Re-attach Hook and Loop attachments on cover.
- D. Determine whether an upright or reclined installation is preferred as shown below:

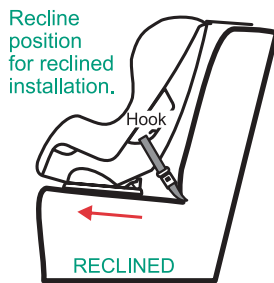
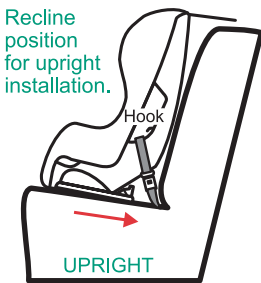



# HOW TO INSTALL

## COMPAQ DELUXE

- E. Place one hand on the front of base firmly, while with the other hand push the blue recline latch up to unlock and push back until the restraint is at the desired position. Ensure the blue recline latch is engaged into position by pushing on the restraint.

**Do not recline into baby position when using restraint in forward facing child use mode.**

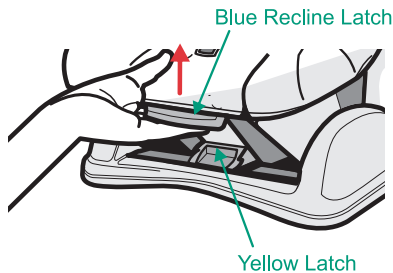

## COMPAQ

- E. Move Recline Foot by grasping the Foot, pressing the Locking Bar while rotating to the required child position until the Locking Bar locks into position.

**CAUTION: Fingers may become trapped between restraint body and locking bar when positioning Recline Foot into upright mode.**

Press Recline Foot Locking Bar to adjust.

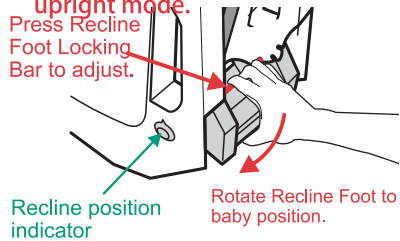

- F. Position restraint in forward facing mode and align restraint centrally to the chosen seating position as shown on page 20. Some vehicle seat fabrics (particularly velours) may be damaged by a child restraint used continuously. We recommend the use of a thick towel, Messy Mat, or other protection to keep the vehicle seat in good condition.

- G. Fully lengthen seat belt. Insert seat belt into child use seat belt path, ensuring that the harness straps are between the vehicle seat belt and the back of the restraint moulding and that the lap part of the seat belt is below the hooks as shown right.

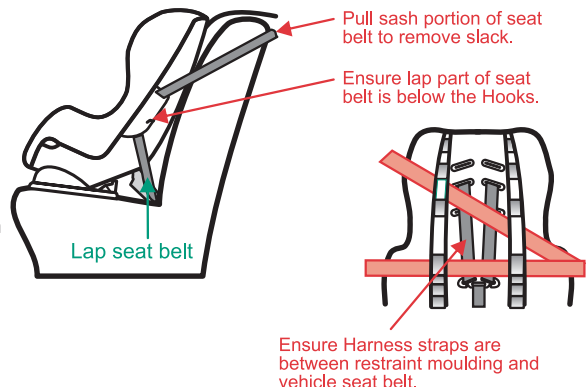



# HOW TO INSTALL

H. Engage seat belt buckle and tongue, ensure to remove all slack from lap part of seat belt by pulling sash belt. Adjust the seat belt to hold the restraint firmly against the vehicle seat. For inertia/retractable seat belts, allow excess belt to feed back into retractor.

I. Fit the attachment clip to the anchor fitting as shown right. Make sure to remove as many twists as possible from the upper anchorage strap.

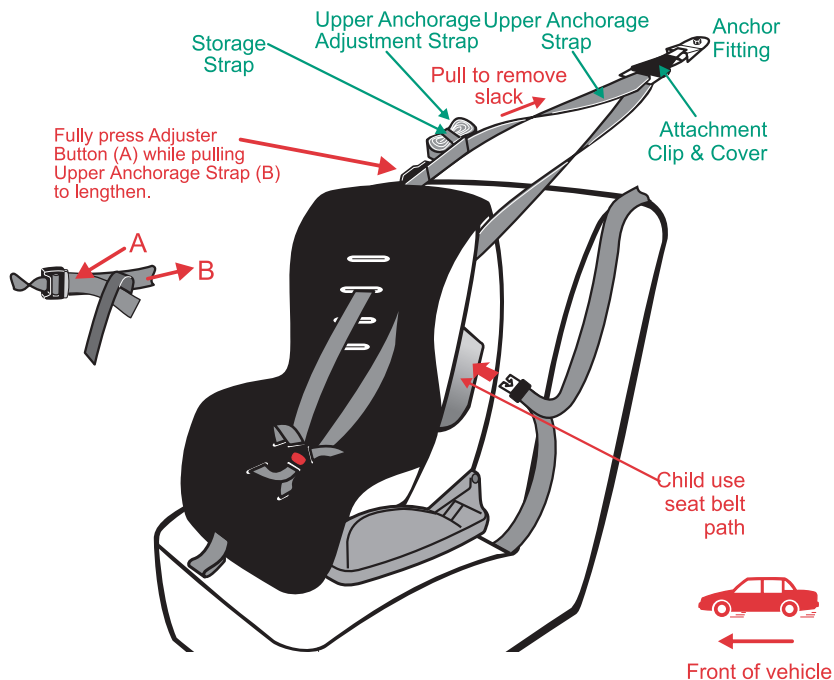
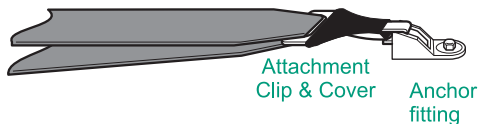

J. Tighten Adjustable Upper Anchorage Strap by pulling adjustment strap to remove slack as shown below, but do not over-tighten causing the restraint base to lift off the vehicle seat. Fold up excess strap and use storage strap to neatly store excess strap away from child's reach.



## PLACING CHILD IN THE RESTRAINT

### CROTCH STRAP POSITION - CHILD USE

The crotch straps must be moved to the outer position to accommodate the larger child. Refer to page 23 (Care & Maintenance) instructions and follow point A. Ensure both crotch straps are changed to the outer position as shown right.

Outer Crotch  
Strap Position

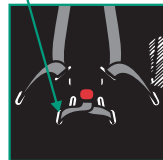

- A. Lengthen harness by lifting up Harness Adjuster Lock (under flap) while pulling on either shoulder strap until the harness will accommodate the child.
- B. Place child in the restraint and feed each arm through shoulder straps. Pull harness buckle up between child's legs.

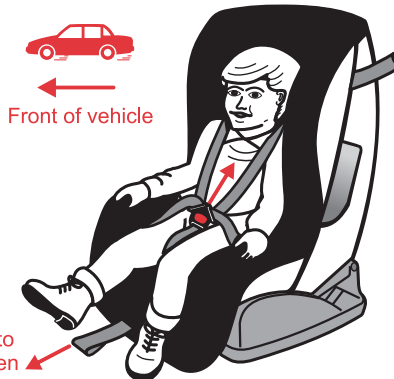
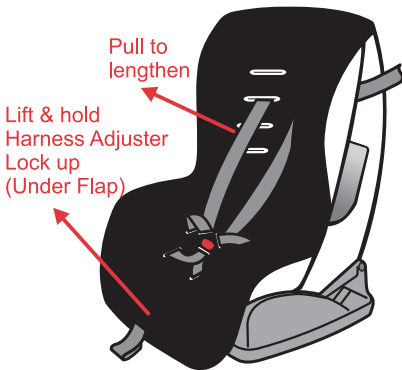

- C. Fit either harness tongue into the harness buckle followed by the other tongue until a click is heard. Should the second tongue not insert, press the red button and reinsert the tongues. Ensure secure engagement by pulling harness straps.



- D. Ensure slack is removed from harness lap strap by pulling shoulder straps then pull harness adjustment strap to adjust harness to a comfortable but firm fit. Check that slack in straps is minimal. Shoulder Harness Straps must fit firmly to the child. A loose harness could result in serious injury in an accident. **Do not use restraint if straps do not tighten and contact your local authorised service agent for repair.**

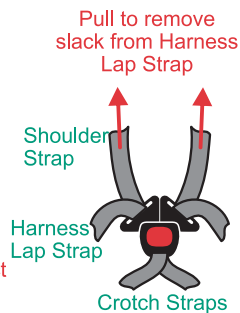

## TO REMOVE CHILD

Press red button on harness buckle then both harness tongues will be released. Lift the shoulder straps from the child's shoulders.

# HOW TO CLEAN

The restraint has a flame retardant cover which is removable for cleaning. Cleaning instructions are on the care label attached to the cover. If fluffy cover is fitted then washing cover prior to use will remove excess fluff. Ensure that the inside of the buckle is free of foreign matter. Cleaning instructions are on page 23. Use only mild soap and water to clean all metal and plastic parts of the restraint.

## TO REMOVE COVER:

- A. Remove the restraint from vehicle as instructed on page 6.
- B. Disengage harness tongues from harness buckle.
- C. Remove any accessories, if fitted as instructed on page 24.
- D. Disengage harness straps from harness Strap Connector as instructed on page 17, item B.
- E. Unhook the cover at the top and bottom of the restraint. Peel cover from outer rim of the body starting from **1** on both sides and then at **2**, at the top.
- F. Remove the cover while feeding the Harness Tongues & Crotch Buckle through the lap and crotch strap slots in the cover.

Do not remove Harness Adjustment Strap from Harness Adjustment Strap Lock.

## TO REPLACE COVER:

- A. Feed the Harness straps and Harness Tongues through Lap Strap Slots and through matching shoulder strap slots in the cover and seat.
- B. Stretch cover over the top of the restraint first at **1** then the sides at, as instructed above and then stretch the **2** cover around the rim of the restraint.
- C. Re-fit the Seat Cover attachments.
- D. Re-engage harness straps to Harness Strap Connector as instructed on page 17, item D to F.
- E. Feed Crotch Buckle through slots in cover.

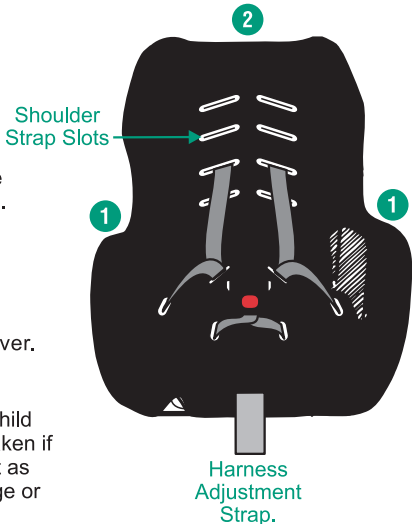

## COVER (STYLE MAY VARY)

The cover has been designed to protect your child when seated in the restraint. Care should be taken if children either eat or drink while in the restraint as some food or drink products may cause damage or marking to the cover.

**IMPORTANT:** Do not pull sticky items from covers as the cover may be damaged - soak in water and gently remove.

# CARE & MAINTENANCE

## REGULAR CARE OF THIS RESTRAINT:

Please check the following items regularly to ensure the safety of your child:

- A. Check the webbing for fraying.
- B. Check that the buckle clicks and is not sluggish or sticky in operation.
- C. Ensure there are no cracks in moulding or the plastic moulding.
- D. Check the Harness Adjuster is operating and is clamping the webbing.
- E. If any part of the restraint is cracked or broken, seek repair immediately or replace the child restraint.

## TO CLEAN HARNESS BUCKLE:

If sticky liquids such as baby formula, fruit juice, etc. get inside your Harness Buckle, it may become sluggish. An indication of a sluggish Harness Buckle is that you cannot hear a click when engaging the Harness Tongues. To restore the Harness Buckle to good working order it needs to be cleaned as follows:

- A. From the underside of the restraint pull each crotch 3-bar slide then turn 3-bar slide and push through each slot to remove the Harness Buckle from the restraint.

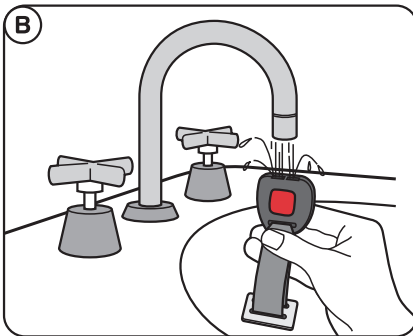
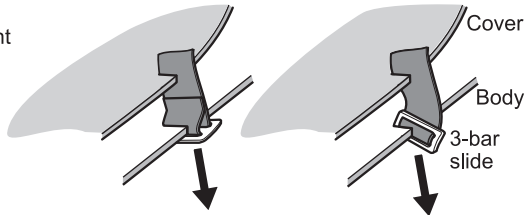

Place the Harness Buckle under warm (approx. 40 degrees Celsius) running water as shown below. Let the water run through the mouth of the buckle for five minutes.

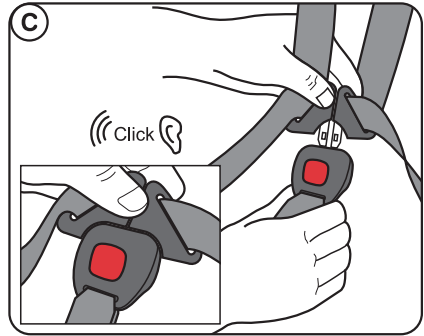

Engage and disengage the Harness Tongues and Buckles several times until a strong audible click is heard.

- D. If you still cannot hear a strong audible click after engaging the Harness Tongues & Buckle, then repeat cleaning several times. If the Harness Buckle cannot be returned to its original working condition then contact Hipod Nursery Products.
- E. Refit the Harness Buckle to the restraint with the red button facing out & feeding each 3-bar slide through appropriate slot.

# ACCESSORIES & FEATURES

The following instructions apply to accessories that may be supplied with this restraint at point of purchase. If not, a variety of accessories are available from various retailers of safe-sound products. In the case of a small baby, accessories are available to improve the installed position of the baby in the restraint.

## HEAD REST (if fitted)

The Head Rest is designed to snugly support the baby or child for extra comfort. Do not use the Head Rest and Padded insert together if they create discomfort.

If fitting Head Rest for baby or child use fit straps through Upper Shoulder Strap Slots and over the top of the restraint as shown right. Slide Head Rest up or down to rest above the shoulder strap slots being used.

Head Rest straps should be over the top of the Restraint and through top slots.

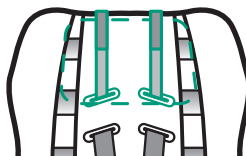

## SHOULDER PADS (if fitted)

Shoulder Pads are designed to provide extra comfort for baby or child and are easily fitted to the shoulder harness straps.

## CROTCH PAD (if fitted)

The Crotch Pad is designed to provide extra comfort for baby or child and is fitted to the restraint as follows:  
Feed Crotch Buckle through the slot in crotch pad as shown.

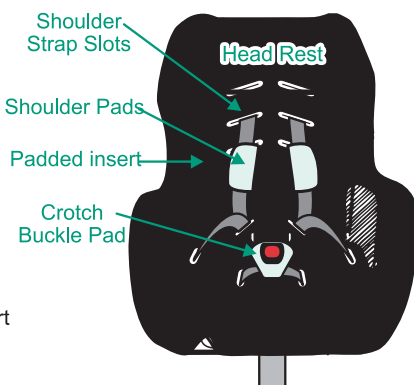

## PADDED INSERT (if fitted)

The Padded Insert is designed to snugly support the baby for extra comfort.

## FITTING PADDED INSERT

- Remove restraint from vehicle as instructed on page 6.
- Disengage harness tongues from harness buckle.
- At the rear of the restraint, remove harness shoulder straps from metal strap connector, by slipping straps through open slot as shown right.
- Pull the shoulder straps through slots.
- Feed the shoulder strap through the slot in Padded Connector Insert & restraint.
- Refit the shoulder strap to the strap connector following the instructions on page 17, points D to F.

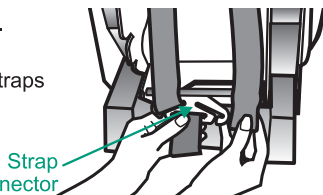

## **!** WARNINGS

NEVER USE ANY SEAT COVERS OR ACCESSORIES THAT CAUSE THE SHOULDER HARNESS STRAPS TO WIDEN SIDEWAYS WHEN FITTED, AS THE HARNESS WILL NOT RESTRAIN THE CHILD CORRECTLY.



# ACCESSORIES & FEATURES

## HOOD

The hood has been designed to protect your child from direct sunlight when fitted in the forward-facing position.

- Attach the elastic straps at the back of the hood to the hooks at the rear of the restraint.
- Attach together the press stud on the ends of the hood & on the sides of the trim.

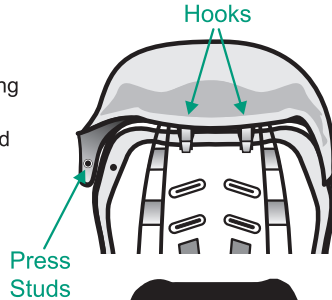

## POCKETS

The pockets sewn on the trim are designed for your convenience. They can hold those necessary items that you need at a moments notice. e.g Bottle, face washer, toy etc.

Caution: If using the pocket to store filled bottles, please ensure contents are not contaminated due to prolonged storage.

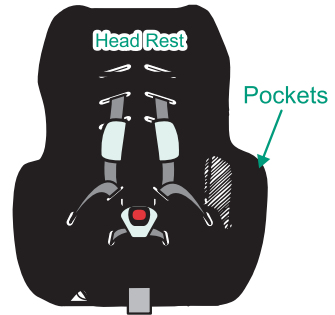

## MESSY MAT

The messy mat has been specifically designed to protect your vehicle seat from children's shoes rubbing against it. If the Messy Mat has been supplied it must be used to protect the car upholstery.

Place pocket on edge of seat, smooth back toward seat join ('A') and fit in any excess messy mat into the join of the car seat ('A').

**CAUTION:** The messy mat pocket is only for small, light items. DO NOT overload the pocket with heavy, bulky items as this may damage the pocket or cause passengers to trip over them.

Long Messy Mat  
(where supplied)

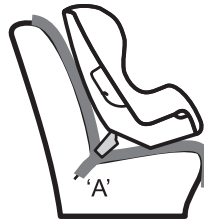

Short Messy Mat  
(where supplied)

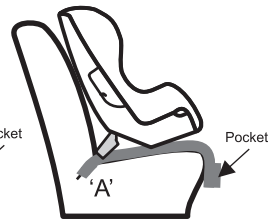

NOTE: Some messy mats may not have pockets

## BABY HEAD SUPPORT

Feed the hook and loop attachments on the Baby Head support through the upper shoulder strap slots. Engage the hook and loop attachments securely.

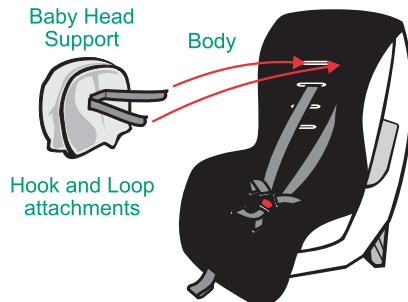

## SAFETY

Never hold a baby or a child in arms when riding in a motor vehicle. In this position the baby or child could be thrown against the dashboard, windscreen or other occupant and suffer serious injury or death.

When riding in a motor vehicle never nurse a baby or a child and use the same seat belt for both of you. In this position the baby or child could be crushed.

Children must be secured in appropriate restraints at all times when the car is in motion. Children travelling unrestrained and standing up in the car are in danger of serious injury or death. Traffic regulations in all states require children to be secured in approved child restraints or adult seat belts where available.

Plan your trip with frequent comfort stops to reduce stress on babies, young children and driver. Keep the car well ventilated to reduce heat stress. Two car windows should be kept open to maintain a good flow of fresh air if air conditioning is not used.

Be on guard against carbon monoxide poisoning which can occur through only a slight leak in the exhaust system while travelling in a closed car.

Never leave babies or toddlers in a stationary car in the sun because of the risk of heat exhaustion.

Ensure babies and toddlers are adequately shaded from direct sunlight through side or rear windows.

Securely stow all heavy objects, feeding bottles, etc. that could become missiles during an accident and cause injury to any occupant.

## CLOTHING/BATHING

Take several changes of clothing and bibs for possible car sickness. Disposable nappies and liners are very handy while travelling. Since it is often warmer in the car, dress the baby in light clothing. When cooler, it is easier to place a blanket over the baby than it is to remove the baby from the restraint and change clothes.

Take a pack containing baby soap, oil, powder, cotton wool, small towel and wet washer in a plastic bag.

## FEEDING

Never breast feed a baby while car is in motion.

Babies will require extra feeding if travelling in the heat. For bottle fed babies, make up the bottles and refrigerate before leaving home for a day trip. Place in a cool bag and reheat as needed with hot water from a thermos.

Alternatively, bring boiled water in a thermos and pre-measured amounts of baby formula in small containers. Use the water from the thermos to mix with the formula when required. Regardless which method is used, it is always a good plan to carry some boiled water in a sterile container or bottle.

Do not attempt to carry warm milk because germs multiply rapidly in warm milk.

# IN CASE OF ACCIDENT

If your restraint has been involved in a severe crash, you should destroy the restraint even if no damage is obvious. Some insurance companies offer vehicle insurance which covers or partially covers the replacement of your child restraint. Contact your insurance company for further details.

Your insurance company may require you to keep the child restraint for assessment, **but do not use the child restraint after a severe crash**. To assist you in making an accident insurance claim cut the following statement and include it with your claim.

## NOTICE TO INSURANCE COMPANY CHILD RESTRAINT INVOLVED IN AN ACCIDENT

All Safe-n-Sound child restraints are manufactured to Australian/New Zealand Standards AS/NZS1754-2004 which require us to advise users of child restraints to "Destroy the entire restraint if it has been in use in a severe crash, even if no damage is obvious". The joint Australian/New Zealand Standards committee CS/85, advise that this statement applies whether a child was in the child restraint or not. A severe crash, we consider as being one where the main body structure of the vehicle is distorted.

There is no method of determining if the restraint has been damaged and we concur with the Australian/New Zealand Standards in recommending destruction of the child restraint.

This notice is to advise you of the requirements of the Australian/New Zealand Standards and our obligation in complying with the standards.

Please assist the owner of this restraint in their claim.

**Britax Childcare Pty. Ltd.**

(Incorporated in Victoria)  
A.B.N 55 006 773 600

**Head office and registered address:**

99 Derby Road Sunshine Victoria 3020  
PO Box 147 Sunshine Victoria 3020  
Telephone: 1300 303 330





*Arrive...Safe-n-Sound.*

**Britax**  
Childcare



*First class travel for children*

**INSTRUCTION BOOK**

The Safe-n-Sound and Compaq trade marks are the property of Britax Childcare Pty. Limited-Australia.

The Britax trade mark is the property of Britax Excelsior Limited-UK.

**Series Number: 25/C/2004 & 25/D/2004**

We reserve the right to alter this product without notice in our constant endeavour for improvement.

© 1997-2006 Britax Childcare Pty. Ltd. This product is covered by Australian and overseas patent applications. Patents Pending.

Visit the Britax Web Site at <http://www.britax.com.au>  
or Email us at: [custserv@britax.com.au](mailto:custserv@britax.com.au)

P/No. 2108672/B

## Free Manuals Download Website

<http://myh66.com>

<http://usermanuals.us>

<http://www.somanuals.com>

<http://www.4manuals.cc>

<http://www.manual-lib.com>

<http://www.404manual.com>

<http://www.luxmanual.com>

<http://aubethermostatmanual.com>

Golf course search by state

<http://golfingnear.com>

Email search by domain

<http://emailbydomain.com>

Auto manuals search

<http://auto.somanuals.com>

TV manuals search

<http://tv.somanuals.com>