

maintenance & service guide

Presario 1200 Series

Models: 1255, 1256, 1260, 1262, 1266, 1267, 1272, 1273, 1274, and 1275

Before You Begin	Specifications	Parts Catalog
Removal Sequence	Troubleshooting	Battery Operations
Product Description	Pin Assignments	Index

Before You Begin

[Notice](#)

[Preface](#)

[Product
Description](#)

[Troubleshooting](#)

[Illustrated Parts
Catalog](#)

[Removal &
Replacement
Procedures](#)

[Specifications](#)

[Connector Pin
Assignments](#)

[Battery Pack
Operations](#)



Presario 1200 Series

This online guide is designed to serve the needs of those whose job it is to repair Compaq products.

This Guide will be periodically maintained and updated online as needed.

For content comments or questions, contact [Compaq](#).

To report a technical problem, contact your Regional Support Center or IM Help Center.

maintenance & service guide

Presario 1200 Series

Models: 1255, 1256, 1260, 1262, 1266, 1267, 1272, 1273, 1274, and 1275

<u>Before You Begin</u>	<u>Specifications</u>	<u>Parts Catalog</u>
<u>Removal Sequence</u>	<u>Troubleshooting</u>	<u>Battery Operations</u>
<u>Product Description</u>	<u>Pin Assignments</u>	<u>Index</u>

Notice

The information in this guide is subject to change without notice.

COMPAQ COMPUTER CORPORATION SHALL NOT BE LIABLE FOR TECHNICAL OR EDITORIAL ERRORS OR OMISSIONS CONTAINED HEREIN, NOR FOR INCIDENTAL OR CONSEQUENTIAL DAMAGES RESULTING FROM THE FURNISHING, PERFORMANCE, OR USE OF THIS MATERIAL.

This guide contains information protected by copyright. No part of this guide may be photocopied or reproduced in any form without prior written consent from Compaq Computer Corporation.

*© 1999 Compaq Computer Corporation.
All rights reserved. Printed in the U.S.A.*

Compaq, Presario Registered U. S. Patent and Trademark Office.

*Microsoft, MS-DOS, and Windows are registered trademarks of Microsoft Corporation.
Windows 98 is a trademark of Microsoft Corporation.*

The software described in this guide is furnished under a license agreement or nondisclosure agreement. The software may be used or copied only in accordance with the terms of the agreement.

Product names mentioned herein may be trademarks and/or registered trademarks of their respective companies.

Maintenance and Service Guide

Compaq Presario 1200 Series Portable Computers

First Edition (June 1999)
Compaq Computer Corporation

maintenance & service guide

Presario 1200 Series

Models: 1255, 1256, 1260, 1262, 1266, 1267, 1272, 1273, 1274, and 1275

Before You Begin	Specifications	Parts Catalog
Removal Sequence	Troubleshooting	Battery Operations
Product Description	Pin Assignments	Index

Preface

This *Maintenance and Service Guide* is a troubleshooting guide that can be used for reference when servicing the Compaq Presario 1200 Series Portable Computers.

Compaq Computer Corporation reserves the right to make changes to the Compaq Presario 1200 Series Portable Computers without notice.

Symbols

The following words and symbols mark special messages throughout this guide.

	WARNING: Text set off in this manner indicates that failure to follow directions in the warning could result in bodily harm or loss of life.
--	---

	CAUTION: Text set off in this manner indicates that failure to follow directions could result in damage to equipment or loss of data.
--	--

IMPORTANT: Text set off in this manner presents clarifying information or specific instructions.

NOTE: Text set off in this manner presents commentary, sidelights, or interesting points of information.

Technician Notes

	WARNING: Only authorized technicians trained by Compaq should repair this equipment. All troubleshooting and repair procedures are detailed to allow only subassembly/module level repair. Because of the complexity of the individual boards and subassemblies, the user should not attempt to make repairs at the component level or to make modifications to any printed circuit board. Improper repairs can create a safety hazard. Any indications of component replacement or printed circuit board modifications may void any warranty.
--	---

Serial Number

When requesting information or ordering spare parts, the computer serial number should be provided to Compaq. The serial number is located on the bottom of the computer.

Locating Additional Information

The following documentation is available to support this product:

- Compaq Presario 1200 Series Portable Computer documentation set
- *Introducing Windows 95 Guide*
- Service Training Guides
- Compaq Service Advisories and Bulletins
- *Compaq QuickFind*
- *Compaq Service Quick Reference Guide*

maintenance & service guide

Presario 1200 Series

Models: 1255, 1256, 1260, 1262, 1266, 1267, 1272, 1273, 1274, and 1275

Before You Begin	Specifications	Parts Catalog
Removal Sequence	Troubleshooting	Battery Operations
Product Description	Pin Assignments	Index

Product Description

[Models and Features](#)

[Controls and Lights](#)

[Left Side
Components](#)

[Right Side
Components](#)

[Bottom of Unit](#)

[Rear Connectors](#)

[Power Management
for Windows 98](#)



**Compaq
Presario
Portable
Computers...**

are a continuation of new generation multimedia portable computers with innovative integrated designs, outstanding audio and video, advanced core features, and attractive styling.

This full-function, AMD-K6 portable computer allows full desktop functionality.

maintenance & service guide

Presario 1200 Series

Models: 1255, 1256, 1260, 1262, 1266, 1267, 1272, 1273, 1274, and 1275

Before You Begin	Specifications	Parts Catalog
Removal Sequence	Troubleshooting	Battery Operations
Product Description	Pin Assignments	Index

Models & Features

Models and Features
Controls and Lights
Left Side Components
Right Side Components
Bottom of Unit
Rear Connectors
Power Management

Compaq Presario 1200 Series Portable Computer Models		
	Model 1255	Model 1256
Display	12.1" HPA	12.1" HPA
Processor	AMD-K6 333-MHz MMX	AMD-K6 333-MHz MMX
Hard Drive	3.2-GB (or) 4.0-GB	4.3-GB
CD Drive	24× MAX	24× MAX
Modem	K-56.0 (or) M++56.0 Kbps Data/Fax with ITU V.90	M++56.0 Kbps Data/Fax with ITU V.90
Battery	ES NiMH (or) sLi ion	ES NiMH
System Memory	32 MB	32 MB
	Model 1260	Model 1262
Display	12.1" TFT	12.1" TFT
Processor	AMD-K6 333-MHz MMX	AMD-K6 333-MHz MMX
Hard Drive	4.0-GB (or) 6.4-GB	4.0-GB
CD Drive	24× MAX	24× MAX
Modem	K-56.0 (or) M++56.0 Kbps Data/Fax with ITU V.90	K-56.0 Kbps Data/Fax with ITU V.90
Battery	sLi ion	ES NiMH
System Memory	32 MB	32 MB
	Model 1266	Model 1267
Display	12.1" TFT	12.1" TFT
Processor	AMD-K6 333-MHz MMX	AMD-K6 333-MHz MMX
Hard Drive	4.0-GB (or) 6.4-GB	4.0-GB
CD Drive	24× MAX	24× MAX
Modem	K-56.0 (or) M++56.0 Kbps Data/Fax with ITU V.90	K-56.0 Kbps Data/Fax with ITU V.90
Battery	sLi ion	ES NiMH
System Memory	32 MB	32 MB
	Model 1272	Model 1273
Display	12.1" HPA	12.1" HPA
Processor	AMD-K6II 333-MHz MMX	AMD-K6II 333-MHz MMX
Hard Drive	4.3-GB	6.4-GB
CD Drive	24× MAX	24× MAX
Modem	K-56.0 Khan	K-56.0 Khan
Battery	ES NiMH	ES NiMH
System Memory	32 MB	32 MB
	Model 1274	Model 1275
Display	12.1" HPA	13.0" HPA
Processor	AMD-K6II 333-MHz MMX	AMD-K6II 333-MHz MMX
Hard Drive	4.3-GB	4.3-GB
CD Drive	24× MAX	24× MAX
Modem	K-56.0 Khan	K-56.0 Khan
Battery	ES NiMH	sLi ion
System Memory	64 MB	32 MB (or) 64 MB

maintenance & service guide

Presario 1200 Series

Models: 1255, 1256, 1260, 1262, 1266, 1267, 1272, 1273, 1274, and 1275

Before You Begin	Specifications	Parts Catalog
Removal Sequence	Troubleshooting	Battery Operations
Product Description	Pin Assignments	Index

Controls and Lights

Models and Features
Controls and Lights
Left Side Components
Right Side Components
Bottom of Unit
Rear Connectors
Power Management for Windows 98

Front Panel Components

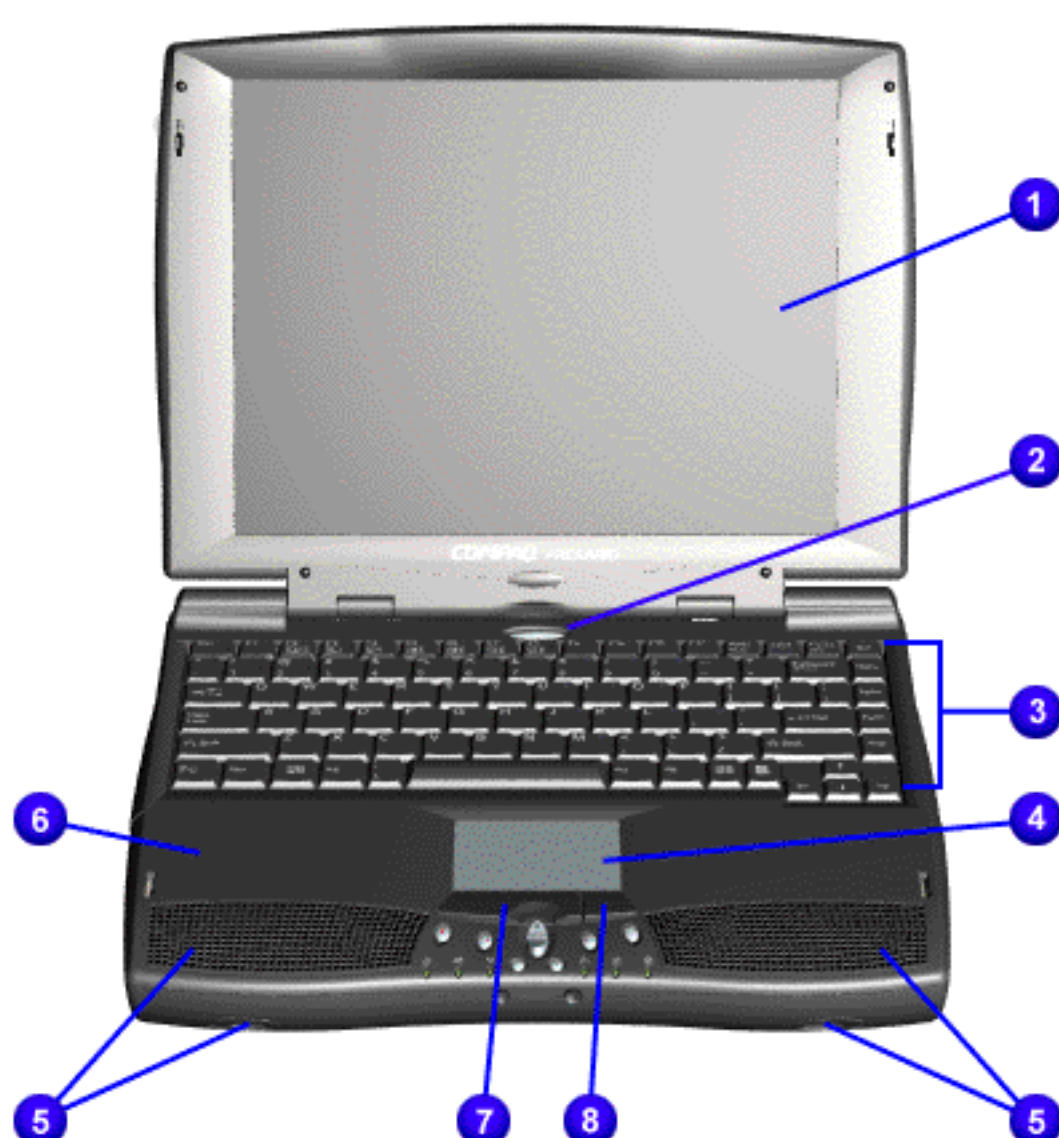

- | |
|--------------------------------|
| 1. Display |
| 2. Power Button |
| 3. Keyboard |
| 4. TouchPad |
| 5. Speakers & Ports |
| 6. Palmrest |
| 7. (L) TouchPad Button |
| 8. (R) TouchPad Button |
| |
| |

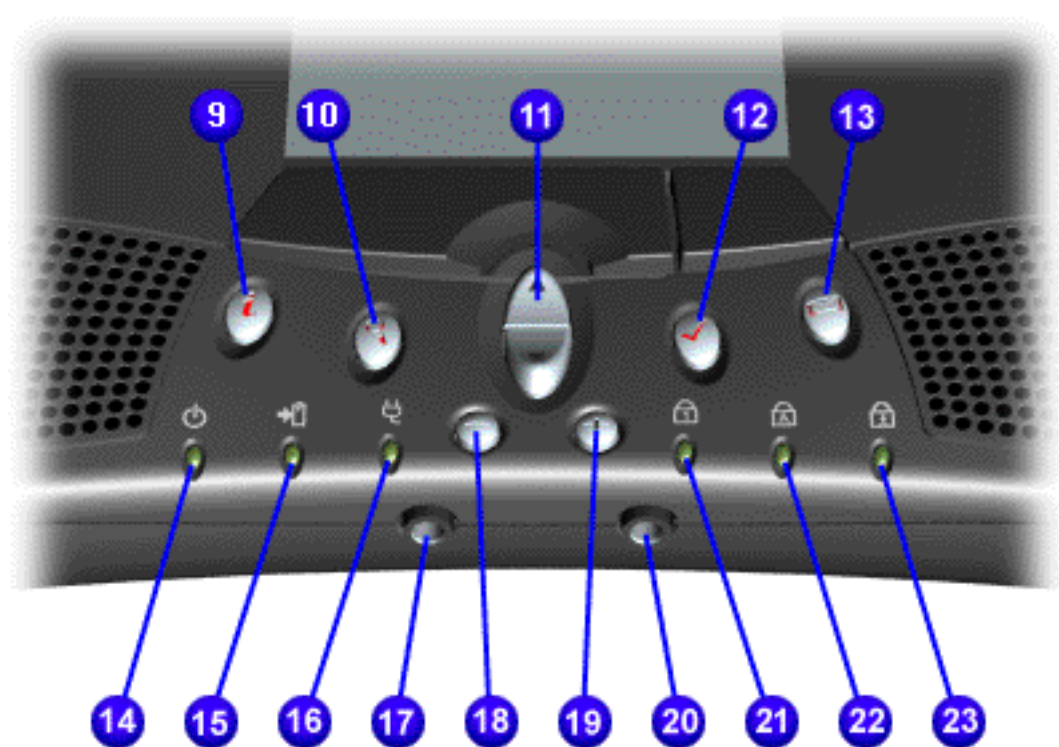

- | |
|--|
| 9. Instant Internet Access Button |
| 10. Instant Search Button |
| 11. Scroll up/down Button |
| 12. Instant E-Commerce Button (or Retail Center) |
| NOTE: Depending on the model, the icon for this button may be either a check mark or a shopping cart. |
| 13. Instant E-mail |
| 14. Power Light |
| 15. Battery Charge Light |
| 16. AC Adapter Light |
| 17. Headphone Jack |
| 18. Volume Down Button |
| 19. Volume Up Button |
| 20. Microphone Jack |
| 21. Number Lock Light |
| 22. Cap Lock Light |
| 23. Scroll Lock Light |

maintenance & service guide

Presario 1200 Series

Models: 1255, 1256, 1260, 1262, 1266, 1267, 1272, 1273, 1274, and 1275

Before You Begin	Specifications	Parts Catalog
Removal Sequence	Troubleshooting	Battery Operations
Product Description	Pin Assignments	Index

Left Side Components

[Models and Features](#)

[Controls and Lights](#)

[Left Side Components](#)

[Right Side Components](#)

[Bottom of Unit](#)

[Rear Connectors](#)

[Power Management for Windows 98](#)

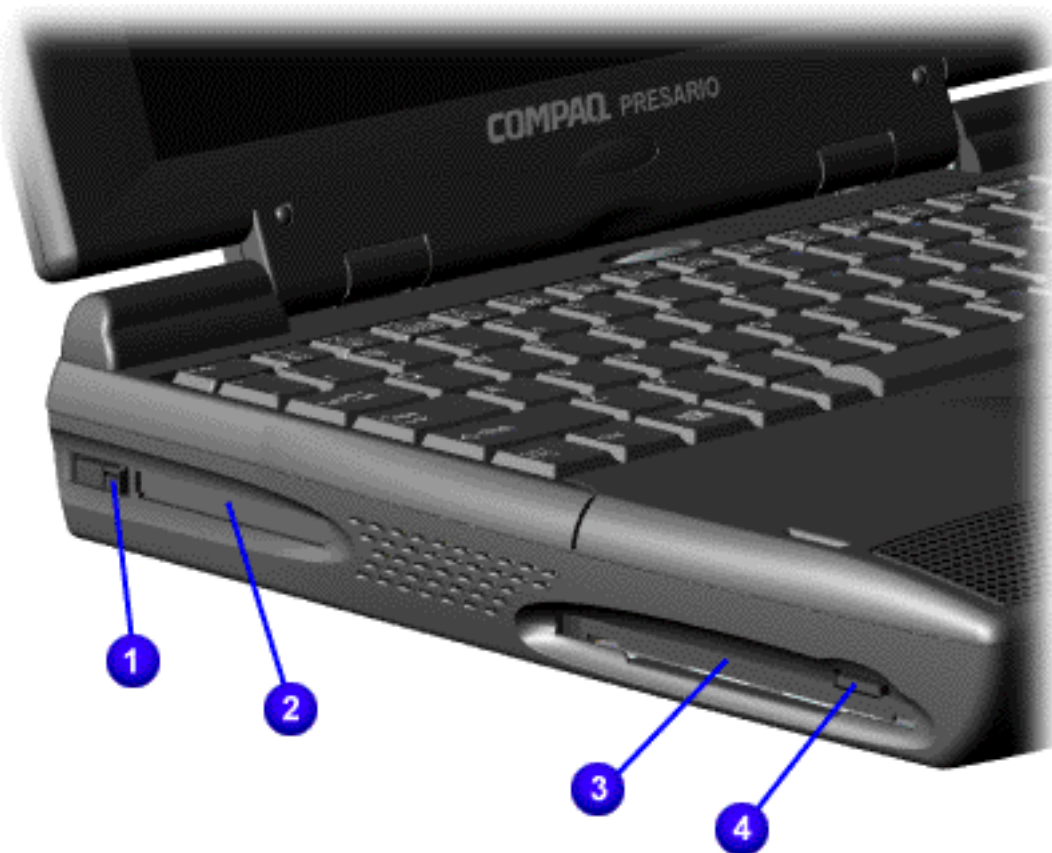

1. PC Card Eject Lever

2. PC Card Slot

3. Diskette Drive Slot

4. Diskette Eject Button

maintenance & service guide

Presario 1200 Series

Models: 1255, 1256, 1260, 1262, 1266, 1267, 1272, 1273, 1274, and 1275

Before You Begin	Specifications	Parts Catalog
Removal Sequence	Troubleshooting	Battery Operations
Product Description	Pin Assignments	Index

Right Side Components

[Models and Features](#)

[Controls and Lights](#)

[Left Side Components](#)

[Right Side Components](#)

[Bottom of Unit](#)

[Rear Connectors](#)

[Power Management for Windows 98](#)



1. Battery Compartment.

2. CD Drive.

3. CD Drive Eject Button.

maintenance & service guide

Presario 1200 Series

Models: 1255, 1256, 1260, 1262, 1266, 1267, 1272, 1273, 1274, and 1275

Before You Begin	Specifications	Parts Catalog
Removal Sequence	Troubleshooting	Battery Operations
Product Description	Pin Assignments	Index

Bottom of Unit

[Models and Features](#)

[Controls and Lights](#)

[Left Side Components](#)

[Right Side Components](#)

[Bottom of Unit](#)

[Rear Connectors](#)

[Power Management for Windows 98](#)

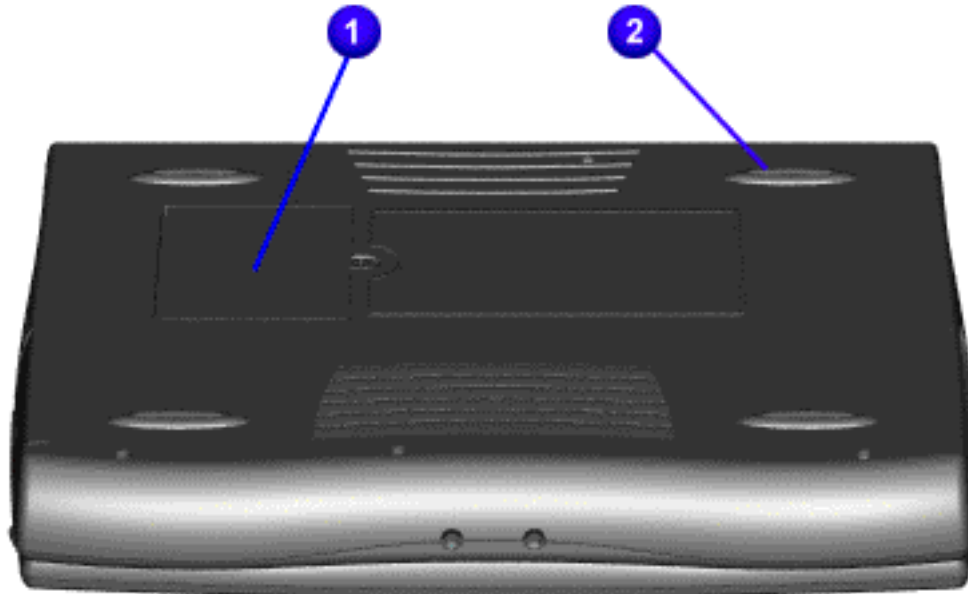

1. Upgradeable memory compartment.

2. Rubber feet.

maintenance & service guide

Presario 1200 Series

Models: 1255, 1256, 1260, 1262, 1266, 1267, 1272, 1273, 1274, and 1275

Before You Begin	Specifications	Parts Catalog
Removal Sequence	Troubleshooting	Battery Operations
Product Description	Pin Assignments	Index

Rear Connectors

[Models and Features](#)

[Controls and Lights](#)

[Left Side Components](#)

[Right Side Components](#)

[Bottom of Unit](#)

[Rear Connectors](#)

[Power Management for Windows 98](#)

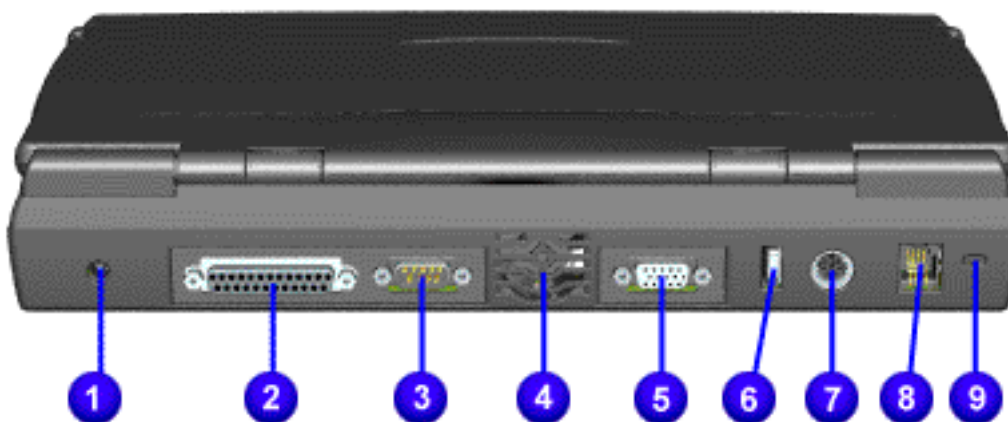

1. AC Adapter.

2. Parallel Printer Port.

3. Serial Port.

4. Fan Exhaust.

5. External Monitor Port.

6. USB.

7. Keyboard/Mouse Port.

8. Modem Jack.

9. Security Slot.

maintenance & service guide

Presario 1200 Series

Models: 1255, 1256, 1260, 1262, 1266, 1267, 1272, 1273, 1274, and 1275

Before You Begin	Specifications	Parts Catalog
Removal Sequence	Troubleshooting	Battery Operations
Product Description	Pin Assignments	Index

Power Management for Windows 98

The following power management features are available for conserving AC power and extending battery operating time:

[Power Management
Settings](#)

[Sleep](#)

[Hibernation](#)

[Battery Operating
Time](#)

[Rebooting After
Lockup](#)

[Servicing Your
Computer](#)

Maintenance & Service Guide

Presario 1200 Series

Models: 1255, 1256, 1260, 1262, 1266, 1267, 1272, 1273, 1274, and 1275

[Home Page](#) | [Notice](#) | [Preface](#) | [Product Description](#) | [Troubleshooting](#)
[Illustrated Parts Catalog](#) | [Removal & Replacement Procedures](#) | [Specifications](#)
[Pin Assignments](#) | [Battery Pack Operations](#)

Power Management for Windows 98

Power Management Settings

Depending on your patterns of computer use, you can set different levels of power management. These different power management levels can be activated based on the amount of time passed since the last system activity. System activity examples include keyboard or mouse movement, CD or DVD playback (while under program control that monitors Sleep), and modem use.

You can select different conditions or power schemes through Power Management. The optional settings are **Home/Office Desk**, **Portable/Laptop**, and **Always On**. From the default settings, you can change the following settings:

- the System goes to Sleep (Standby) mode
- the screen times out and goes blank
- the hard drive spins down

Each of these system components goes to sleep after the selected or default periods of inactivity.

(The setting for hard drive must be less than, or equal to, the setting for System.)

IMPORTANT: If you're on a network, it's recommended that you set **System Standby** to **Never**.

There are five categories of power management settings under the Control Panel.

The default settings for each feature are listed in the following tables:

<i>Power Management Properties</i>		
Tab: Power Schemes:	Plugged in	Running on Batteries
Always on System Standby:	Never	After 15 minutes
Turn OFF Monitor	3 hours	Never
Turn OFF Hard Drive	After 15 minutes	After 10 minutes

<i>Power Management Properties</i>	
Tab: ALARMS::	
Low Battery Alarm:	10%
Critical Battery Alarm	0%
Alarm Actions:	X Display Message Notification: Text Action: No Action

<i>Power Management Properties</i>	
Tab: POWER METER:	Default
Tab: ADVANCED	Default (show power meter on taskbar)

<i>Display Properties</i>
Tab: Monitor: Laptop Display (800 x 600)

Maintenance & Service Guide

Presario 1200 Series

Models: 1255, 1256, 1260, 1262, 1266, 1267, 1272, 1273, 1274, and 1275

[Home Page](#) | [Notice](#) | [Preface](#) | [Product Description](#) | [Troubleshooting](#)
[Illustrated Parts Catalog](#) | [Removal & Replacement Procedures](#) | [Specifications](#)
[Pin Assignments](#) | [Battery Pack Operations](#)

Power Management for Windows 98

Sleep

You can select Sleep mode instead of turning off the computer when you have finished using it. This allows the computer to wake up faster than turning it off and saves power over the active (On) mode. Compaq Presario Notebook computers have two levels of sleep - Hibernation and Sleep.

Hibernation - pushing the power button once causes your computer to perform a save to disk followed by a shut down of the computer into Off mode.

Sleep - is a low-power mode, also referred to as Standby mode. While in Sleep mode, your computer maintains system information and open files. Unsaved information is lost if you turn off your system before system wake-up, or if you lose power while using the AC adapter.



CAUTION: While in Sleep mode, your computer maintains system information and open files. **Unsaved information is lost if you turn off your system before system wake-up, or if you lose power while using the AC adapter.**

Maintenance & Service Guide

Presario 1200 Series

Models: 1255, 1256, 1260, 1262, 1266, 1267, 1272, 1273, 1274, and 1275

[Home Page](#) | [Notice](#) | [Preface](#) | [Product Description](#) | [Troubleshooting](#)
[Illustrated Parts Catalog](#) | [Removal & Replacement Procedures](#) | [Specifications](#)
[Pin Assignments](#) | [Battery Pack Operations](#)

Power Management for Windows 98

Hibernation Mode

Hibernation helps conserve battery life and protect your data. Hibernation can be a routine power saving event, or can be the result of a low battery condition. As it enters Hibernation, your computer displays a progress screen, as it automatically saves the machine state before it shuts down and turns itself off. Your computer automatically goes into Hibernation when the battery has little power left, or when the system (operating on battery power) has been in Sleep mode for more than an hour. You can also manually initiate Hibernation by pressing the power button once while the system is active. To restore the computer's previous state, simply press the power button once again. While waking up, the computer displays a progress screen.

The following table shows the conditions and indicators for getting in and out of the various power management modes - Sleep, Hibernation, and Off.

Mode	To Initiate	To End	Indicators
Sleep	Manual keys combination - <i>Fn+F4</i>	Press any key	Flashing green Power LED
	Time Out Default - 15 minutes if on Battery power (system will not time out to sleep)		
Hibernate	Manual - Press Power Button once	Press Power Button once	No Power LED, blank screen
	Time Out Default - If low battery or after 1 hour of sleep (system will not Hibernate if on AC power)		
Off	Perform normal Windows shutdown via the start button, or press and hold down the power button for 4 seconds	Press Power Button once	No Power LED, blank screen

Maintenance & Service Guide

Presario 1200 Series

Models: 1255, 1256, 1260, 1262, 1266, 1267, 1272, 1273, 1274, and 1275

| [Home Page](#) | [Notice](#) | [Preface](#) | [Product Description](#) | [Troubleshooting](#)
[Illustrated Parts Catalog](#) | [Removal & Replacement Procedures](#) | [Specifications](#)
[Pin Assignments](#) | [Battery Pack Operations](#)

Power Management for Windows 98

Battery Operating Time

Battery operating time is affected by variables, such as the following:

- Power conservation settings
- Hardware configuration
- Software applications
- Installed options
- Display brightness
- Hard drive usage
- Power button
- Changes in operating temperature
- Type and number of installed PC Cards

For more information on increasing battery pack operating time, conditioning the battery pack, and disposing of a used battery pack, refer to [Battery Pack Operating Time](#).

Return to [Power Management for Windows 98](#) list.

Maintenance & Service Guide

Presario 1200 Series

Models: 1255, 1256, 1260, 1262, 1266, 1267, 1272, 1273, 1274, and 1275

| [Home Page](#) | [Notice](#) | [Preface](#) | [Product Description](#) | [Troubleshooting](#)
[Illustrated Parts Catalog](#) | [Removal & Replacement Procedures](#) | [Specifications](#)
[Pin Assignments](#) | [Battery Pack Operations](#)

Power Management for Windows 98

Rebooting After a Lockup

Occasionally you may encounter a frozen keyboard or a locked screen. To reboot your computer (as if from a cold start), press and hold down the Power Button for at least four seconds, which will cause a manual shutdown. Then, restart the computer with a single press of the Power Button. If it still does not recover, press the Power Button and hold it for four seconds to power off the computer. Then, remove the battery or unplug the AC power for at least 30 seconds. Reinsert the battery or reconnect AC power and press the Power Button once to reboot.

Return to [Power Management for Windows 98](#) list.

Maintenance & Service Guide

Presario 1200 Series

Models: 1255, 1256, 1260, 1262, 1266, 1267, 1272, 1273, 1274, and 1275

| [Home Page](#) | [Notice](#) | [Preface](#) | [Product Description](#) | [Troubleshooting](#)
[Illustrated Parts Catalog](#) | [Removal & Replacement Procedures](#) | [Specifications](#)
[Pin Assignments](#) | [Battery Pack Operations](#)

Power Management for Windows 98

Servicing Your Computer - Full Off Mode

If you need to install or replace components in your system, you must turn the computer off *completely*.

Place the computer into [Off mode](#), unplug it from the outlet, and remove the battery ([see battery section for instruction on removing battery](#)).

Return to [Power Management for Windows 98](#) list.

maintenance & service guide

Presario 1200 Series

Models: 1255, 1256, 1260, 1262, 1266, 1267, 1272, 1273, 1274, and 1275

Before You Begin	Specifications	Parts Catalog
Removal Sequence	Troubleshooting	Battery Operations
Product Description	Pin Assignments	Index

Troubleshooting

[Preliminary Steps](#)

[Clearing the Power-On Password](#)

[Power-On Self Test \(POST\)](#)

[Compaq Diagnostics](#)

[Diagnostic Error Codes](#)

[Troubleshooting Without Diagnostics](#)

[Solving Minor Problems](#)

[Contacting Compaq Support](#)

This section covers troubleshooting information for the Compaq Presario 1200 Series Portable Computers. The basic steps in troubleshooting include:

- 1. Follow the [Preliminary Steps](#).**
- 2. Run the [Power-On Self-Test \(POST\)](#).**
- 3. If you are unable to run POST or if POST displays an error message, follow the recommended actions described in the diagnostic tables.**

*When following the recommended actions in the Sections on **POST** and [Diagnostic Error Codes](#), perform them in the order listed. Rerun **POST** after each recommended action until the problem is solved and no error message occurs. Once the problem is solved, do not complete the remaining recommended actions.*

NOTE: If the problem is intermittent, check the computer several times to verify that the problem is solved.

maintenance & service guide

Presario 1200 Series

Models: 1255, 1256, 1260, 1262, 1266, 1267, 1272, 1273, 1274, and 1275

Before You Begin	Specifications	Parts Catalog
Removal Sequence	Troubleshooting	Battery Operations
Product Description	Pin Assignments	Index

Preliminary Steps

Before running [POST](#), complete the following preliminary steps:

1. If a power-on password has been established, type the password and press the **Enter** key. If the password is not known, [clear the password](#).
2. Run [Computer Checkup](#).
3. Turn off the computer and its external devices.
4. Disconnect any external devices that you do not want to test. Do not disconnect the printer if you want to test it or use it to log error messages.

IMPORTANT:

If the problem only occurs when an external device is connected to the computer, the problem may be related to the external device or its cable. Verify this by running POST with and without the external device connected.

5. Install loopback plugs in the serial and parallel connectors if you would like to test these ports.
6. Ensure that the hard drive is installed in the computer.
7. Ensure that the battery pack is inserted in the computer and the computer is connected to an external AC power source.

When these preliminary steps are completed, you are ready to run [POST](#).

Return to [Troubleshooting index page](#).

maintenance & service guide

Presario 1200 Series

Models: 1255, 1256, 1260, 1262, 1266, 1267, 1272, 1273, 1274, and 1275

Before You Begin	Specifications	Parts Catalog
Removal Sequence	Troubleshooting	Battery Operations
Product Description	Pin Assignments	Index

Power-On Self Test (POST)

Running POST

To run POST, complete the following steps:

- Turn off the computer; then, turn on the computer.
- If POST does not detect any errors, the computer will not beep. This indicates successful completion of POST test. POST has run successfully and boots from the hard drive (or from a bootable diskette if one is installed in the diskette drive).
- If POST detects errors, the errors are indicated by screen and/or audible messages. Refer to "Power-On Self-Test (POST) Codes" in the tables for a list of POST codes and their relevant descriptions.

NOTE: If the system is not functioning well enough to run POST, or if the display is not functioning well enough to show POST error messages, refer to the Troubleshooting tables.

Power-On Self-Test Messages

102-System Board Failure

Probable Cause	Recommended Action
DMA, timers, etc.	Replace the system board.

162-System Options Not Set

Probable Cause	Recommended Action
Configuration incorrect	Run Computer Setup.
CMOS reflects that an invalid configuration has been set.	Run Computer Setup.
RAM failure	1. Replace the memory modules. 2. Replace the system board.
Memory test data error	1. Replace the memory modules. 2. Replace the system board.
XX000YZZ RAM failure	Replace the system board.

XX000YZZ 201-Memory Error

Probable Cause	Recommended Action
RAM failure	1. Replace the memory modules. 2. Replace the system board.
Memory test data error	1. Replace the memory modules. 2. Replace the system board.
XX000YZZ Ram failure	Replace the system board.

301-Keyboard Error

Probable Cause	Recommended Action
Keyboard failure	1. Ensure that keys are not depressed during POST. 2. Reconnect the keyboard with the computer off. 3. Replace the keyboard.

304-Keyboard or System Unit Error

Probable Cause	Recommended Action
Keyboard or system board error	1. Replace the keyboard. 2. Replace the TouchPad or mouse. 3. Replace the system board.

601-Diskette Controller Error

Probable Cause	Recommended Action
Mismatch in drive type or failure in the diskette controller	1. Run Computer Checkup (TEST) . 2. Check and/or replace cables. 3. Replace the system board.

605-Diskette Drive Error

Probable Cause	Recommended Action
Mismatch in drive type	Run Computer Setup.

1780-Primary Hard Drive 0 Failure

Probable Cause	Recommended Action
Disk 0 failed to respond	1. Run Computer Checkup (TEST) . 2. Replace the hard drive.
Hard drive format error	1. Run Computer Checkup (TEST) . 2. Replace the hard drive.

1782-Hard Drive Controller

Probable Cause	Recommended Action
Hard drive controller failure	1. Run Computer Setup. 2. Replace the hard drive.

maintenance & service guide

Presario 1200 Series

Models: 1255, 1256, 1260, 1262, 1266, 1267, 1272, 1273, 1274, and 1275

Before You Begin	Specifications	Parts Catalog
Removal Sequence	Troubleshooting	Battery Operations
Product Description	Pin Assignments	Index

Clearing the Power-on Password

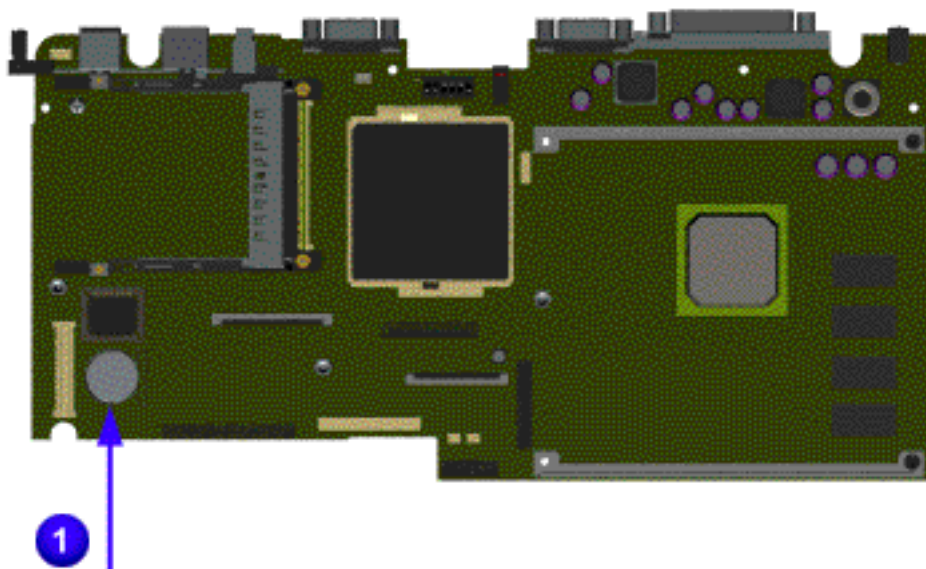

Clearing the power-on password requires removing all Setup attributes that are programmed in the CMOS. The RTC battery **1** is located on the system board.

If the password is not known, clear it by performing the following steps:

1. Turn off the computer.
2. Disconnect the power cord.
3. Remove the [battery pack](#).
4. Remove the [Palmrest Cover with Touch Pad](#).
5. Move the [keyboard](#) to allow access to the heatspreader.
6. Remove the [heatspreader](#).
7. Remove the [modem](#).
8. Remove the RTC battery for 30 seconds and replace it.
9. Reassemble the computer by reversing the previous steps.
10. Turn on the computer to verify that the power-on password has been cleared. If it has not been cleared, repeat Steps 1 through 10.

Return to [preliminary steps](#) page.

or

Return to [Troubleshooting index](#) page.

maintenance & service guide

Presario 1200 Series

Models: 1255, 1256, 1260, 1262, 1266, 1267, 1272, 1273, 1274, and 1275

Before You Begin	Specifications	Parts Catalog
Removal Sequence	Troubleshooting	Battery Operations
Product Description	Pin Assignments	Index

Compaq Diagnostics

Compaq Diagnostics is installed on the hard drive of the computer. Run the Diagnostics utilities when you want to view or test system information and if you have installed or connected devices. If you run Compaq Diagnostics from a diskette, ensure that it is version 10.11 or later.

The Diagnostics menu includes the following utilities:

- [Perform Computer Checkup \(TEST\)](#)
- [View System Information \(INSPECT\)](#)
- [Prepare Computer for a Compaq Service Call \(RemotePaq\)](#)

If you have a problem you cannot solve, run the Diagnostics utilities before you call for support. Run Computer Checkup and save the device list to a file and to print, or save the error log. Run the View System Information (INSPECT) utility and print or save that information. Have the files or the printed information available when you call for support.

Perform Computer Checkup (TEST)

Computer Checkup (TEST) determines whether the various computer components and devices are recognized by the system and are functioning properly. You can display, print, or save the information generated by Computer Checkup.

Follow these steps to run Computer Checkup:

1. Plug the computer into an external power source. (A low battery condition could interrupt the program.)
 2. Turn on the external devices that you want to test. Connect the printer if you want to print a log of error messages.
 3. Insert the Compaq Diagnostics diskette in drive A.
 4. Turn on or restart the computer. The computer starts from drive A, and the **Diagnostics Welcome** screen appears.
 5. Press **Enter** to continue. The **Diagnostics** menu appears.
 6. Select Computer Checkup from the **Diagnostics** menu. A **Test Option** menu appears.
 7. Select **View the Device List** from the **Test Option** menu. A list of the installed Compaq devices appears.
 8. If the list of installed devices is correct, select **OK**. The **Test Option** menu appears.
- NOTE:** If the list is incorrect, ensure that any new devices are installed properly.
9. Select one of the following from the **Test Option** menu:
 - **Quick Check Diagnostics.** Runs a quick, general test on each device with a minimal number of prompts. If errors occur, they display when the testing is complete. You cannot print or save the error messages.
 - **Automatic Diagnostics.** Runs unattended, maximum testing of each device with minimal prompts. You can choose how many times to run the tests, to stop on errors, or to print or save a log of errors.
 - **Prompted Diagnostics.** Allows maximum control over testing the devices. You can choose attended or unattended testing, decide to stop on errors, or choose to print or save a log of errors.
 10. Follow the instructions on the screen as the devices are tested. When testing is complete, the **Test Option** menu appears.
 11. Exit the **Test Option** menu.
 12. Exit the **Diagnostics** menu.

Return to [top of this page](#)

View System Information (INSPECT)

The View System Information (INSPECT) utility provides information about the computer and installed or connected devices. You can display, print, or save the information.

Follow these steps to run View System Information (INSPECT) from the Compaq Diagnostics diskette:

1. Turn on the external devices that you want to test. Connect the printer if you want to print the information.
2. Insert the Compaq Diagnostics diskette in drive A.
3. Turn on or restart the computer. The computer starts from drive A, and the **Diagnostics Welcome** screen appears.
4. Press **Enter** to continue. The Diagnostics menu appears.
5. Select **View System Information (INSPECT)** from the **Diagnostics** menu.
6. Select the item you want to view from the following list:

System	Memory
ROM	Audio
Keyboard	Operating system
System ports	System files
System storage	Windows files
Graphics	
7. Follow the instructions on the screen to cycle through the screens, to return to the list and choose another item, or to print the information.

Return to [top of this page](#)

or to [Preliminary steps](#) page.

or to the [Troubleshooting](#) index page.

maintenance & service guide

Presario 1200 Series

Models: 1255, 1256, 1260, 1262, 1266, 1267, 1272, 1273, 1274, and 1275

Before You Begin	Specifications	Parts Catalog
Removal Sequence	Troubleshooting	Battery Operations
Product Description	Pin Assignments	Index

Diagnostic Error Codes

Diagnostic error codes occur if the system recognizes a problem while running the Compaq Diagnostic program. These error codes help identify possibly defective subassemblies.

The following tables list error codes, a description of the error condition, and the action required to resolve the error condition.

IMPORTANT: Retest the system after completing each step. If the problem has been resolved, do not proceed with the remaining steps.

For the removal and replacement of a particular subassembly, see [Removal and Replacement Procedures](#).

Select error codes by number or type:

[101 through 114](#)

[200 through 215](#)

[300 through 304](#)

[401 through 403](#)

[600 through 699](#)

[1101](#)

[1701 through 1736](#)

[501 through 516](#)

[2402 through 2456](#)

[2458 through 2480](#)

[3206](#)

[8601 through 8602](#)

[3301 through 6623](#)

[Processor Test](#)

[Memory Test](#)

[Keyboard Test](#)

[Parallel Printer Test](#)

[Diskette Drive Test](#)

[Serial Test](#)

[Hard Drive Test](#)

[Video Test](#)

[Audio Test](#)

[Touch Pad Pointing Device Test](#)

[CD Test](#)

Processor Test Error Codes		
Error Code	Description	Recommended Action
101-xx	CPU test failed	Replace the processor and retest.
102-xx	Coprocessor or Weitek Error	1. Run the Configuration and Diagnostics Utilities. 2. Replace the processor board and retest.
103-xx	DMA page registers test failed	Replace the system board and retest.
104-xx	Interrupt controller master test failed	
105-xx	Port 61 error	
106-xx	Keyboard controller self-test failed	
107-xx	CMOS RAM test failed	
108-xx	CMOS interrupt test failed	
109-xx	CMOS clock test failed	
110-xx	Programmable timer load data test failed	
113-xx	Protected mode test failed	
114-01	Speaker test failed	1. Check system configuration. 2. Verify cable connections to speaker. 3. Replace the system board and retest.

Memory Test Error Codes		
Error Code	Description	Recommended Action
200-xx	Memory machine ID test failed	1. Flash the system ROM and retest.
202-xx	Memory system ROM checksum failed	2. Replace the system board and retest.
203-xx	Write/Read test failed	1. Remove the memory module and retest.
204-xx	Address test failed	
211-xx	Random pattern test failed	2. Install a new memory module and retest.
214-xx	Noise test failed	
215-xx	Random address test failed	

[Return to the top](#)

Keyboard Test Error Codes		
Error Code	Description	Recommended Action
300-xx	Failed ID Test	1. Check the keyboard connection. If disconnected, turn off the computer and connect the keyboard.
301-xx	Failed Selftest/Interface Test	
302-xx	Failed Individual Key Test	2. Replace the keyboard and retest.
304-xx	Failed Keyboard Repeat Test	3. Replace the system board and retest.

Parallel Printer Test Error Codes		
Error Code	Description	Recommended Action
401-xx	Printer failed or not connected	1. Connect the printer. 2. Check power to the printer.
402-xx	Failed Port Test	3. Install the loop-back connector and retest.
403-xx	Printer pattern test failed	4. Check port and IRQ configuration. 5. Replace the system board and retest.

[Return to the top](#)

Diskette Drive Test		
Error Code	Description	Recommended Action
600-xx	Diskette ID drive types test failed	1. Replace the diskette media and retest.
601-xx	Diskette format failed	
602-xx	Diskette read test failed	2. Check and/or replace the diskette power and signal cables and retest.
603-xx	Diskette write, read, compare test failed	3. Replace the diskette drive and retest.
604-xx	Diskette random test failed	
605-xx	Diskette ID media failed	4. Replace the system board and retest.
606-xx	Diskette speed test failed	
609-xx	Diskette reset controller test failed	
610-xx	Diskette change line test failed	
697-xx	Diskette type error	
698-xx	Diskette drive speed not within limits	
699-xx	Diskette drive/media ID error	1. Replace media. 2. Run the Configuration and Diagnostics Utilities.

[Return to the top](#)

Serial Test Error Codes		
Error Code	Description	Recommended Action
1101-xx	Serial port test failed	1. Check port configuration. 2. Replace the system board and retest.

Hard Drive Test Error Codes		
Error Code	Description	Recommended Action
1701-xx	Hard drive format test failed	1. Run the Configuration and Diagnostics Utilities and verify drive type.
1702-xx	Hard drive read test failed	
1703-xx	Hard drive write/read/compare test failed	2. Verify that all secondary drives have secondary drive capability.
1704-xx	Hard drive random seek test failed	3. Replace the hard drive and retest.
1705-xx	Hard drive controller test failed	4. Replace the system board and retest.
1706-xx	Hard drive ready test failed	
1707-xx	Hard drive recalibration test failed	
1708-xx	Hard drive format bad track test failed	
1709-xx	Hard drive reset controller test failed	
1710-xx	Hard drive park head test failed	
1715-xx	Hard drive head select test failed	
1716-xx	Hard drive conditional format test failed	
1717-xx	Hard drive ECC* test failed	
1719-xx	Hard drive power mode test failed	
1724-xx	Network preparation test failed	
1736-xx	Drive monitoring test failed	

* ECC = Error Correction Code

[Return to the top](#)

Video Test Error Codes		
Error Code	Description	Recommended Action
501-xx	Video controller test failed	The following apply to error codes 501-xx through 516-xx:
502-xx	Video memory test failed	
503-xx	Video attribute test failed	1. Disconnect external monitor and test with internal LCD display.
504-xx	Video character set test failed	
505-xx	Video 80 × 25 mode 9 × 14 character cell test failed	2. Replace the display assembly and retest.
506-xx	Video 80 × 25 mode 8 × 8 character cell test failed	3. Replace the system board and retest.
507-xx	Video 40 × 25 mode test failed	
508-xx	Video 320 × 200 mode color set 0 test failed	
509-xx	Video 320 × 200 mode color set 1 test failed	
510-xx	Video 640 × 200 mode test failed	
511-xx	Video screen memory page test failed	
512-xx	Video gray scale test failed	
514-xx	Video white screen test failed	
516-xx	Video noise pattern test failed	
2402-xx	Video memory test failed	The following steps apply to error codes 2402-xx through 2456-xx:
2403-xx	Video attribute test failed	1. Run the Configuration and Diagnostics Utilities.
2404-xx	Video character set test failed	2. Replace the display assembly and retest.
2405-xx	Video 80 × 25 mode 9 × 14 character cell test failed	3. Replace the system board and retest.
2406-xx	Video 80 × 25 mode 8 × 8 character cell test failed	
2408-xx	Video 320 × 200 mode color set 0 test failed	
2409-xx	Video 320 × 200 mode color set 1 test failed	
2410-xx	Video 640 × 200 mode test failed	
2411-xx	Video screen memory page test failed	
2412-xx	Video gray scale test failed	
2414-xx	Video white screen test failed	
2416-xx	Video noise pattern test failed	
2418-xx	ECG/VGC memory test failed	
2419-xx	ECG/VGC ROM checksum test failed	1. Run the Configuration and Diagnostics Utilities.
2421-xx	ECG/VGC 640 × 200 graphics mode test failed	
2422-xx	ECG/VGC 640 × 350 16 color set test failed	2. Disconnect external monitor and test with internal LCD display.
2423-xx	ECG/VGC 640 × 350 64 color set test failed	3. Replace the display assembly and retest.
2424-xx	ECG/VGC monochrome text mode test failed	4. Replace the system board and retest.
2425-xx	ECG/VGC monochrome graphics mode test failed	
2431-xx	640 × 480 graphics test failure	
2432-xx	320 × 200 graphics (256 color mode) test failure	
2448-xx	Advanced VGA Controller test failed	
2451-xx	132-column Advanced VGA test failed	
2456-xx	Advanced VGA 256 Color test failed	
2458-xx	Advanced VGA BitBLT test	The following step applies to error codes 2458-xx through 2480-xx:
2468-xx	Advanced VGA DAC test	Replace the system board and retest.
2477-xx	Advanced VGA data path test	
2478-xx	Advanced VGA BitBLT test	
2480-xx	Advanced VGA LineDraw test	

[Return to the top](#)

Audio Test Error Codes		
Error Code	Description	Recommended Action
3206-xx	Audio System Internal Error	Replace the system board and retest.

TouchPad/Pointing Device Interface Test Error Codes		
Error Code	Description	Recommended Action
8601-xx	Mouse test failed	1. Replace the TouchPad and retest.
8602-xx	Interface test failed	2. Replace the system board and retest.

CD Drive Test Error Codes		
Error Code	Description	Recommended Action
3301-xx	CD drive read test failed	1. Replace the CD and retest.
3305-xx	CD drive seek test failed	2. Verify that the speakers are connected.
6600-xx	ID test failed	3. Verify that drivers are loaded and properly installed.
6605-xx	Read test failed	4. Replace the CD drive and retest.
6608-xx	Controller test failed	5. Replace the system board and retest.
6623-xx	Random read test failed	

[Return to the top](#)

or return to the [Troubleshooting index](#) page.

maintenance & service guide

Presario 1200 Series

Models: 1255, 1256, 1260, 1262, 1266, 1267, 1272, 1273, 1274, and 1275

Before You Begin	Specifications	Parts Catalog
Removal Sequence	Troubleshooting	Battery Operations
Product Description	Pin Assignments	Index

Troubleshooting Without Diagnostics

This section provides information about how to identify and correct some common hardware, memory, and software problems. It also explains several types of common messages that may be displayed on the screen. The following pages contain troubleshooting information on:

[Audio](#)

[Battery/Battery gauge](#)

[CD drive](#)

[Diskette/Diskette drive](#)

[Display](#)

[Hard drive](#)

[Hardware Installation](#)

[Memory](#)

[PC Card](#)

[Power](#)

[Printer](#)

[Touch Pad](#)

[Keyboard/Numeric keypad](#)

Since symptoms can be similar, carefully match the symptoms of the computer malfunction against the problem description in the Troubleshooting tables to avoid a misdiagnosis.

 **WARNING:** To avoid a potential shock hazard during troubleshooting procedures, disconnect all power sources before removing the keyboard cover or the display bezel.

Before Replacing Parts

Verify that cables are connected properly to the suspected defective parts.

- Run Computer Setup after connecting external devices.
- Verify that all required device drivers are installed.
- Verify that all required changes have been made to the *CONFIG.SYS* file.
- Verify that all required changes have been made to the *AUTOEXEC.BAT* file.
- Verify that all printer drivers have been installed for each application.

Return to the [Troubleshooting index page](#).

maintenance & service guide

Presario 1200 Series

Models: 1255, 1256, 1260, 1262, 1266, 1267, 1272, 1273, 1274, and 1275

Before You Begin	Specifications	Parts Catalog
Removal Sequence	Troubleshooting	Battery Operations
Product Description	Pin Assignments	Index

Solving Minor Problems

Some minor problems and possible solutions are outlined in the following tables. If the problem appears related to a software application, check the documentation provided with the software.

The following problems and possible solutions are addressed:

- [Audio Problems](#)
- [Battery Pack and Battery Gauge Problems](#)
- [CD Drive Problems](#)
- [Diskette and Diskette Drive Problems](#)
- [Display Problems](#)
- [Hard Drive Problems](#)
- [Hardware Installation Problems](#)
- [Keyboard/Numeric Keypad Problems](#)
- [Memory Problems](#)

Solving Audio Problems

Some common audio problems and solutions are listed in the following table.

Solving Audio Problems		
Problem	Probable Cause	Solution(s)
Computer does not beep after the Power-On Self-Test (POST).	This is typical; it indicates successful completion of the Power-On Self-Test (POST).	No action is required.

Solving Battery Pack and Battery Gauge Problems

Some common causes and solutions for battery pack problems are listed in the following table. The "Solving Power Problems" section in this chapter may also be applicable.

Solving Battery Pack and Battery Gauge Problems		
Problem	Probable Cause	Solution(s)
Computer won't turn on when battery pack is inserted and power cord is unplugged.	Battery pack is discharged.	Connect the computer to an external power source and charge the battery pack. Replace the battery pack with a fully charged battery pack.
Computer is beeping and battery LED icon is blinking.	Battery charge is low.	Immediately save any open file(s). Then do any one of the following: <ul style="list-style-type: none"> • Connect the computer to an external power source to charge the battery pack. • Turn off the computer or initiate Hibernation until you can find another power source or charge the battery pack.
Computer battery LED icon (front on the unit) blinks to indicate low battery condition, but computer does not beep.	Volume is turned down too low.	Adjust the volume.
Battery LED icon doesn't light and battery pack won't fast charge.	Battery pack is already charged.	No action is necessary.
	Battery pack was exposed to temperature extremes.	Allow time for the battery pack to return to room temperature.
	Battery pack is at end of its life.	Replace battery pack.
You have to set the date and time every time you turn on the computer.	RTC battery is dead.	Replace the RTC battery.
Battery charge does not last as long as expected.	Battery is being exposed to high temperatures or extremely cold temperatures.	Keep the battery pack within the recommended operating temperature range 50° F to 104° F (10° C to 40° C) or recommended storage range -4° F to 86° F (-20° C to 30° C). Recharge the battery pack.
	Battery has partially self-discharged.	Recharge the battery. Discharge the battery completely and then recharge it.
	Power management is disabled.	Set a power management level in Computer Setup.
	An external device or PC Card is draining the battery.	Turn off or disconnect external devices when not using them.
Battery pack is warm to the touch after charging.	Normal warming has occurred due to charging.	No action is required.
Battery pack operating time is far less than the documented average operating time.	Power management is turned off or disabled.	Enable power management in Computer Setup and in Windows Power Properties.
	An external device or PC Card is draining the battery.	Turn off or disconnect external devices when not using them.
	Battery pack has partially self-discharged.	Condition the battery pack by fully charging, fully discharging, then fully recharging it. To maintain the charge, leave battery packs in the computer when it is connected to external power. If the computer is disconnected from external power for more than two weeks, remove battery packs from the computer to reduce the discharge rate.
	Battery pack is being exposed to high temperatures or extremely cold temperatures.	Keep the battery pack within the recommended temperature ranges. Operating: 50° F to 104° F (10° C to 40° C) Storage: -4° F to 86° F (-20° C to 30° C) Recharge the battery pack.

Solving CD Drive Problems

Some common causes and solutions for CD drive problems are listed in the following table.

Solving CD Drive Problems		
Problem	Probable Cause	Solution(s)
CD drive cannot read a compact disc.	Compact disc is upside down or is improperly inserted in the CD drive.	Open the CD loading tray, lay the compact disc in it (label side up), then close the tray.
	CD is CD Plus or Pregap/Track 0 type.	Cannot read these type CDs in 24x. Remove the CD.

Solving Diskette and Diskette Drive Problems

Some common causes and solutions for diskette and diskette drive problems are listed in the following table.

Solving Diskette and Diskette Drive Problems		
Problem	Probable Cause	Solution(s)
Diskette drive cannot write to a diskette.	Diskette is write-protected.	Disable the diskette's write-protect feature or use a diskette that is not write-protected.
	Computer is writing to the wrong drive.	Check the drive letter in the path statement.
	Not enough space is left on the diskette.	Use another diskette.
	Drive error has occurred.	Run Computer Checkup from the Compaq Diagnostics diskette.
	Diskette is not formatted.	Format the diskette. At the system prompt, enter FORMAT A:
Diskette drive cannot read a diskette.	The wrong type of diskette is being used.	Use the type of diskette required by the drive.
	Diskette has a bad sector.	Copy files to hard drive or another diskette. Reformat bad floppy.
	Drive error has occurred.	Run Computer Checkup from the Compaq Diagnostics diskette.
	Diskette is not formatted.	Format the diskette. At the system prompt, enter FORMAT A:
Cannot boot from diskette.	Bootable diskette is not in drive A.	Put the bootable diskette in drive A.
	Diskette Boot has incorrect setting in Computer Setup.	Run Computer Setup and set diskette as first to boot.

Solving Display Problems

This section lists some common causes and solutions for computer display and external monitor problems.

You can perform a monitor self-test on an external VGA color or monochrome monitor by disconnecting the monitor from the computer. To do so, complete the following steps:

1. Turn off the monitor.
2. Turn off the computer.
3. Disconnect the monitor signal cable from the computer.
4. Turn on the monitor and allow it to warm up for one minute.

The display should be white. A narrow black border that may also appear on the left and right sides of the display. Either of these displays indicates that the monitor is working properly.

Solving Display Problems		
Problem	Probable Cause	Solution(s)
Screen is dim.	Control for brightness or contrast (if applicable) is not set properly.	Adjust the Brightness of the display by using Fn + F7 or Fn + F8 . Adjust the Contrast of the display by using Fn + F5 or Fn + F6 .
	Computer screen is in direct light.	Tilt display or move computer.
Screen is blank.	Screen save was initiated by Power Management due to lack of user activity.	Press any key or touch the Touch Pad.
	Display has overheated.	If computer is in direct sunlight, move it and allow it to cool off.
Display is blank and the Power icon is flashing, or the Suspend icon is present.	System is in Suspend mode.	Press any key or touch the Touch Pad.
Internal display is blank and the screen on an external monitor displays information.	Display function was switched to the external monitor.	Use Fn + F3 to switch between LCD or CRT .
Internal display flashes or has garbled characters when computer is connected to external monitor.	Using 1024 × 768 or higher resolution on external monitor and have toggled back to internal display, which supports up to 800 × 600.	Restart the computer.
The light tube-s on the edge of the display panel do not light up at all and Power-On Self-Test (POST) completes when the unit is powered up.**	Improper backlight or display cable connections	Replace the display assembly.
	Defective inverter board.	Replace the display assembly.
	Defective display cable.	Replace the display assembly.
	Defective display panel.	Replace the display assembly.
	Defective system board.	Replace the system board.
The light tubes on the edge of the display panel do not light up at all and Power-On Self-Test (POST) does not complete when the unit is powered up.**	Defective system board.	Replace the system board.
Backlight (brightness) cannot be adjusted with Fn + F7 or Fn + F8 .	Improper display cable connections.	1. Reseat the display cable to the system board. 2. Replace the display assembly.
	Defective inverter board.	Replace the display assembly.
	Defective display cable.	Replace the display assembly.
	Defective system board.	Replace the system board.
Contrast cannot be adjusted with Fn + F5 or Fn + F6 .	System may have a TFT display (which is always at maximum contrast)	No adjustment is possible.
	Improper display-cable connections.	1. Reseat the display cable to the system board. 2. Replace the display assembly.
	Defective inverter board.	Replace the display assembly.
	Defective display cable.	Replace the display assembly.
	Defective system board.	Replace the system board.

** This problem indicates that the backlight or its power circuitry has failed. Since you cannot observe the POST result on the display panel when the backlight is not functioning, connect the unit to an external monitor before powering the unit up. If an external monitor is not available, verify that POST completes by opening and closing the display, listening for the single or double beep, and watching for the LEDs to turn on at the front of the computer.

Problem	Probable Cause	Solution(s)
This display panel has a continuous pattern across it (e.g., a "jailbars" pattern), has a single color on it, or has garbled graphics across the entire panel. This failure is for patterns across the entire panel (not just on one section).	Improper display cable connections	Reseat the display cable to the following until the problem is solved: <ol style="list-style-type: none"> 1. System board 2. Display assembly
	Defective display cable.	Replace the display assembly.
	Defective inverter board.	Replace the display assembly.
	Defective system board.	Replace the system board.
Ghost bars extending from graphics on the display.	Common characteristic of STN displays.	1. Change the background colors. 2. Adjust the Contrast of the display by using Fn + F5 or Fn + F6 .
A single line, a small group of lines, or a block appears on the display panel. This failure occurs in only a section of the display panel.	Defective display panel.	Replace the display assembly.

NOTE: To perform a "self-test" on an external VGA color or monochrome monitor, complete the following steps: The screen should be white. A narrow black border may also appear on the left and right sides of the display. Either of these displays indicates that the monitor is working properly.

Solving Hard Drive Problems

Some common causes and solutions for hard drive problems are listed in the following table.

	CAUTION: To prevent loss of information, always maintain an up-to-date backup of your hard drive at all times, in case of errors or failures.
--	--

Solving Hard Drive Problems		
Problem	Probable Cause	Solution(s)
Reading hard drive takes an unusually long time after restarting the computer.	System entered Hibernation due to low battery condition and is now exiting from it.	Give the system time to restore the previously saved data to its exact state before Hibernation.
Hard drive error occurs.	Hard drive has bad sectors or has failed.	Run Computer Checkup .
Hard drive does not work.	Hard drive is not seated properly.	Turn off and unplug the computer, remove the battery pack, and remove and then reinstall the hard drive.

Solving Hardware Installation Problems

Some common causes and solutions for hardware installation problems are listed in the following table.

Solving Hardware Installation Problems		
Problem	Probable Cause	Solution(s)
A new device is not recognized as part of the computer system.	Cable(s) of new external device are loose, or power cables are unplugged.	Ensure that all cables are properly and securely connected.
	Power switch of new external device is not turned on.	Turn off the computer, turn on the external device, then turn on the computer to integrate the device with the computer system.
	Device is not seated properly.	Turn off the computer and reinsert the device.

Solving Keyboard/Numeric Keypad Problems

Some common causes and solutions for keyboard/numeric keypad problems are listed in the following table.

Solving Keyboard/Numeric Keypad Problems		
Problem	Probable Cause	Solution(s)
Embedded numeric keypad on computer keyboard is disabled.	Num Lock function is not enabled.	Press the Shift+NumLk keys to enable the Num Lock function and embedded numeric keypad. The Num Lock icon on the status panel turns on.
Embedded numeric keypad is disabled and Num Lock function is on.	External numeric keypad is connected to the computer.	Disconnect the external numeric keypad from the computer.

Solving Memory Problems

Some common causes and solutions for memory problems are listed in the following table.

Solving Memory Problems		
Problem	Probable Cause	Solution(s)
Memory count during Power-On Self-Test (POST) is incorrect.	Optional memory expansion card is installed incorrectly, is incompatible with the computer, or is defective.	Ensure that the optional memory expansion card is installed correctly.
"Out of Memory" message is displayed on the screen or insufficient memory error occurs during operation.	System ran out of memory for the application.	Check the application documentation for memory requirements. Install additional memory.
	Too many TSR (terminate-and-stay-resident) applications are running.	Remove from memory any TSR applications that you do not need.

[Solving Minor Problems \(continued\)](#)

or return to the [Troubleshooting Index](#) page.

Maintenance & Service Guide

Presario 1200 Series

Models: 1255, 1256, 1260, 1262, 1266, 1267, 1272, 1273, 1274, and 1275

| [Home Page](#) | [Notice](#) | [Preface](#) | [Product Description](#) | [Troubleshooting](#)
[Illustrated Parts Catalog](#) | [Removal & Replacement Procedures](#) | [Specifications](#)
[Pin Assignments](#) | [Battery Pack Operations](#)

Solving PC Card Problems

Some common causes and solutions for PC Card problems are listed in the following table.

Solving PC Card Problems		
Problem	Probable Cause	Solution(s)
When turned on, the computer does not beep when a PC Card is inserted.	Card is not inserted properly.	Ensure that the card is inserted in the correct orientation.
	PC Card beeps are disabled.	Double-click the PC Card icon in the Control Panel; click the Global Settings tab; then, enable PC Card sound effects.
	Speaker is turned off or volume is turned down.	Press volume buttons to turn the speaker on; then, increase the volume.
	PC Card drivers are not installed.	Double click the Add New Hardware icon in the Control Panel for installation instructions. If PC Card or drivers are not compatible with Windows, install drivers and use the PC Card in MS-DOS mode.
	Card or card driver is not supported.	Contact your Compaq-authorized service provider for a list of PC Cards tested successfully in Compaq PC Card platforms.
PC Card modem, fax, or network card does not work.	Card is not fully inserted into the slot or is not inserted properly.	Ensure that the card is inserted in the correct orientation.
	Telephone cord is not plugged in all the way.	Check and secure telephone connection.
	Necessary drivers are not installed (turned on).	Install drivers.
PC Card modem or fax card does not work.	You are trying to access the card using the wrong COM port.	See Specifications to verify COM port.
	The card conflicts with a serial device.	See Specifications to verify address.
	The card is not supported.	Use supported cards only.

Modem network PC Card does not work.	Network driver is not installed or is not set up properly.	Install driver.
	Telephone cord is not properly connected.	Verify telephone connection.
Memory or storage card does not work.	SRAM and flash memory cards require that the memory card driver be loaded (turned on).	Install driver.
	Flash memory cards require the that the Microsoft FlashFile System be loaded.	
	Hard drives on flash mass storage cards require that the PC Card ATA driver be loaded.	
	You are trying to access the hard drive card using the wrong drive letter.	Double-click My Computer to verify the drive letter assigned to the card.
	The card is not supported.	Contact your Compaq authorized service provider for a list of PC Cards tested successfully in Compaq PC Card platforms.

Solving Power Problems

Also see "Solving Battery and Battery Gauge Problems" in this section.

Solving Power Problems		
Problem	Probable Cause	Solution(s)
Computer won't turn on and battery pack is not inserted.	Computer is not connected to a power source.	Insert battery or connect an external power source.
	Power cords to the external power source are unplugged.	Ensure that power cords connecting the computer and the external power source are plugged in properly.
	Power adapter is defective.	Replace AC Adapter and restart.
Computer turned off while it was left unattended and the power icon is off.	System board is defective.	Replace the system board.
	System initiated Hibernation due to a critical low-battery condition.	Replace the battery pack with a fully charged battery pack or connect the computer to an external power source. Then turn on the computer.
	System initiated Hibernation after a preset timeout.	Turn on the computer.

Solving Printer Problems

If you experience problems printing, run a printer self-test. Refer to the documentation provided with your printer for instructions. If the self-test fails, it is a printer-specific problem. Also refer to the printing section of your application documentation.

Solving Printer Problems		
Problem	Probable Cause	Solution(s)
Printer will not turn on.	The signal cable may not be connected properly, or the printer is unplugged.	Ensure that the signal cable is properly connected and that the power cord is connected to the electrical outlet.
Printer will not print.	Printer is not turned on or is off line.	Turn the printer on and set it to on line.
	The device drivers for your application are not installed.	Refer to the printer documentation to install the correct printer driver.
	Printer that is set up for a network is not connected to the network.	Connect the printer to the network.
	Printer cable is too long, unshielded, or defective.	Replace the cable.
	Paper tray is empty.	Fill the paper tray with paper and set the printer to online.
Printer prints garbled information.	Correct printer drivers are not installed.	Refer to the printer documentation to install the correct printer driver.
	Cable is not connected properly.	Ensure that the printer signal cable is properly connected to the computer.
	Cable is defective.	Replace the printer cable and retest.

Solving Touch Pad/Pointing Device Problems

Some common causes and solutions for Touch Pad/pointing device problems are listed in the following table.

Solving Touch Pad/Pointing Device Problems		
Problem	Cause	Solution(s)
Touch Pad or mouse does not work.	Incorrect or no device driver is installed.	Install the device driver and add to the AUTOEXEC.BAT file or CONFIG.SYS file.
	The device driver is not installed in Windows.	Install the Touch Pad/mouse driver in Windows.
External mouse does not work.	Mouse is not securely connected or is connected to an incorrect external connector.	Ensure that the mouse is securely connected to the appropriate external connector.
Touch Pad or mouse does not work even though the device is enabled in Windows.	Mouse is not enabled.	Enter MOUSE at the system prompt to activate the mouse device driver.
		Add a line in the AUTOEXEC.BAT file to automatically activate the mouse device driver each time computer is turned on or restarted.
	Cable not properly seated in Touch Pad board.	Reseat cable.
	Defective Touch Pad board.	Replace Touch Pad board.
	Defective system board.	Replace system board.
	Device driver is not correctly installed in Windows.	Install the appropriate device driver in Windows.
Cursor skips or moves abnormally when using the Touch Pad.	The Touch Pad needs to be cleaned.	Clean the Touch Pad with a cloth dampened with alcohol or an ammonia-based glass cleaner. Wipe up liquid with a dry cloth.

maintenance & service guide

Presario 1200 Series

Models: 1255, 1256, 1260, 1262, 1266, 1267, 1272, 1273, 1274, and 1275

Before You Begin	Specifications	Parts Catalog
Removal Sequence	Troubleshooting	Battery Operations
Product Description	Pin Assignments	Index

Contacting Compaq Support

Obtain the following information before contacting Compaq Reseller Support:

- Product name
- Product serial number
- Purchase date
- Conditions under which the problem occurred
- Any error messages that have occurred
- Hardware configuration
- Type of printer connected
- Hardware/software being used
- Printed result of Computer Checkup (TEST)
- Printed copies of *CONFIG.SYS* and *AUTOEXEC.BAT* files, if possible

Shipping Preparation

To ship the computer, complete the following steps:

1. Back up the critical hard drive files. Ensure that backup tapes/diskette are not exposed to electrical or magnetic fields while stored in transit.
2. Turn off the computer and external devices.
3. Disconnect the external devices from their power sources, then from the computer.

IMPORTANT: Ensure that there is no diskette in the diskette drive, no PC Cards in the PC slots, and no CD in the CD-ROM drive.

4. Close the display and all exterior doors of the computer.
5. Pack the computer with sufficient packing material to protect it. Use the original packing box or similar packaging.

Return to [Compaq Diagnostics](#) page or [Troubleshooting Index](#) page.

maintenance & service guide

Presario 1200 Series

Models: 1255, 1256, 1260, 1262, 1266, 1267, 1272, 1273, 1274, and 1275

Before You Begin	Specifications	Parts Catalog
Removal Sequence	Troubleshooting	Battery Operations
Product Description	Pin Assignments	Index

Illustrated Parts Catalog

This section provides a breakdown and identifies the spare parts ordering number associated with each item for the Compaq Presario 1200 Series Portable Computers.

[System Unit](#)

[Cables](#)

[Boards](#)

[Miscellaneous Hardware &
Plastics Kit](#)

[Display Assembly](#)

[Miscellaneous Parts](#)

[Mass Storage Devices](#)

[Documentation & Software](#)

[Miscellaneous Cable Kit](#)

maintenance & service guide

Presario 1200 Series

Models: 1255, 1256, 1260, 1262, 1266, 1267, 1272, 1273, 1274, and 1275

Before You Begin	Specifications	Parts Catalog
Removal Sequence	Troubleshooting	Battery Operations
Product Description	Pin Assignments	Index

System Unit

Place cursor over each device to obtain its part number.

<i>System Unit</i>
Boards
Display Assembly
Mass Storage Devices
Miscellaneous Cable Kit
Cables
Miscellaneous Hardware and Plastics Kit
Miscellaneous Parts
Documentation and Software

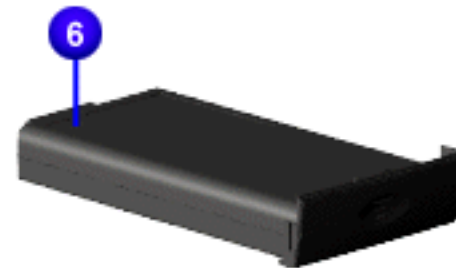
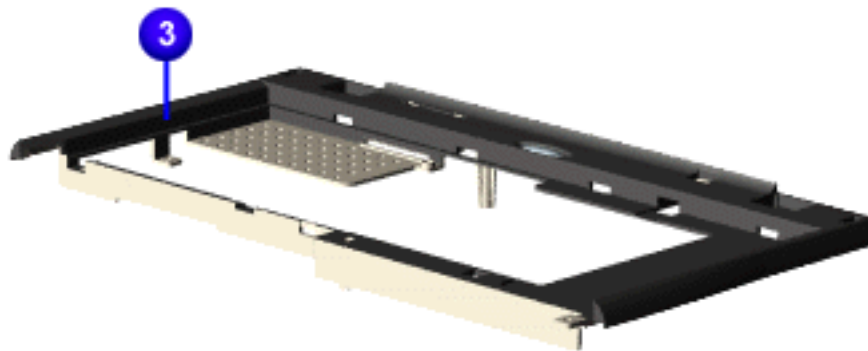
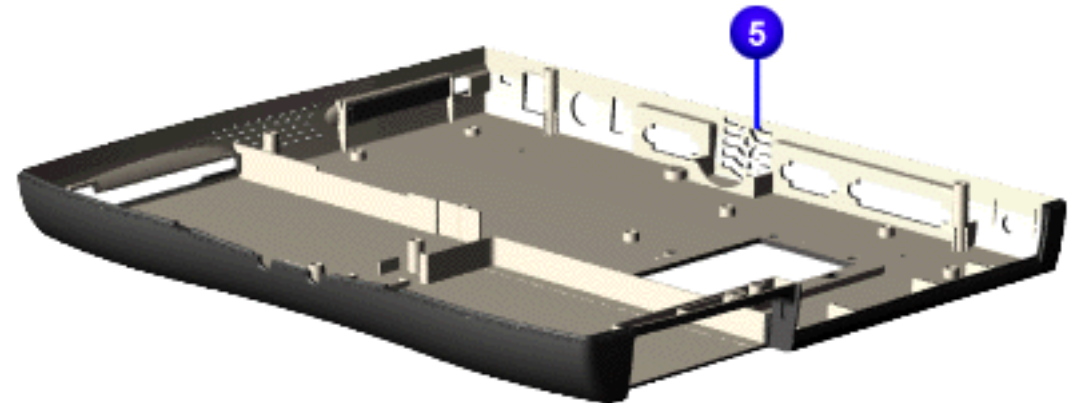
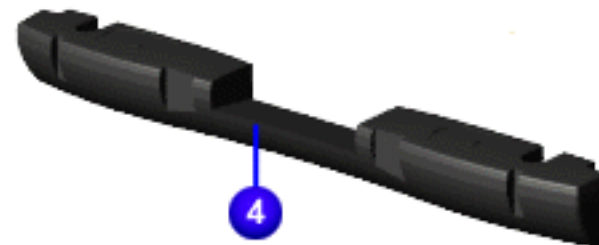

maintenance & service guide

Presario 1200 Series

Models: 1255, 1256, 1260, 1262, 1266, 1267, 1272, 1273, 1274, and 1275

Before You Begin	Specifications	Parts Catalog
Removal Sequence	Troubleshooting	Battery Operations
Product Description	Pin Assignments	Index

Boards

System Unit
Boards
Display Assembly
Mass Storage Devices
Miscellaneous Cable Kit
Cables
Miscellaneous Hardware and Plastics Kit
Miscellaneous Parts
Documentation and Software

Place cursor over each device to obtain its part number.

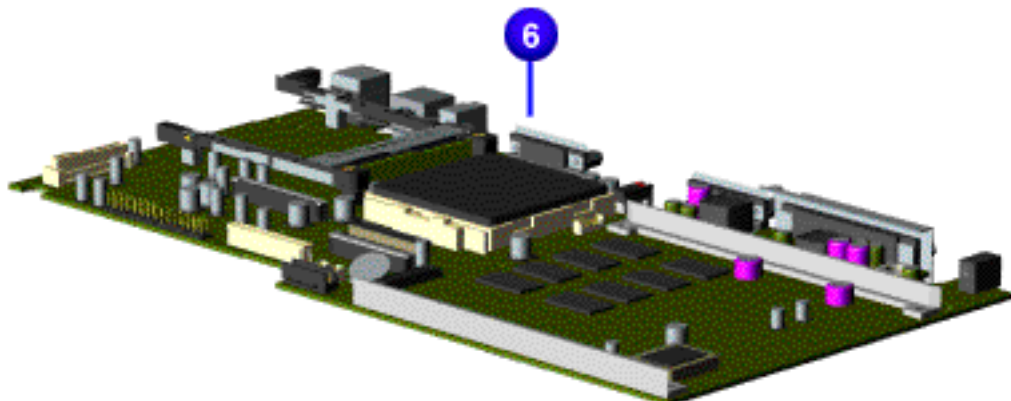
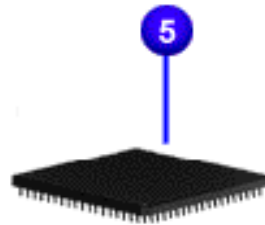
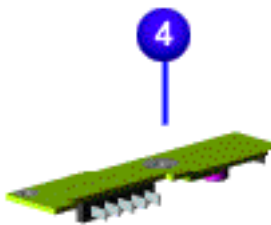
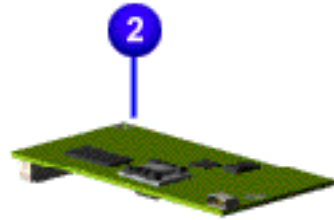
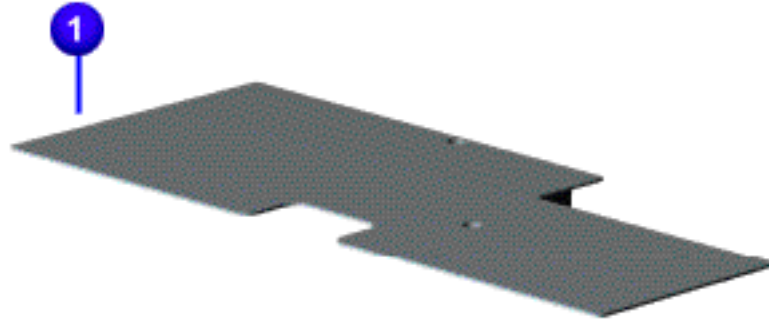

maintenance & service guide

Presario 1200 Series

Models: 1255, 1256, 1260, 1262, 1266, 1267, 1272, 1273, 1274, and 1275

Before You Begin	Specifications	Parts Catalog
Removal Sequence	Troubleshooting	Battery Operations
Product Description	Pin Assignments	Index

Display Assembly

[System Unit](#)

[Boards](#)

[Display
Assembly](#)

[Mass Storage
Devices](#)

[Miscellaneous
Cable Kit](#)

[Cables](#)

[Miscellaneous
Hardware and
Plastics Kit](#)

[Miscellaneous
Parts](#)

[Documentation
and Software](#)



maintenance & service guide

Presario 1200 Series

Models: 1255, 1256, 1260, 1262, 1266, 1267, 1272, 1273, 1274, and 1275

Before You Begin	Specifications	Parts Catalog
Removal Sequence	Troubleshooting	Battery Operations
Product Description	Pin Assignments	Index

Mass Storage Devices

[System Unit](#)

[Boards](#)

[Display Assembly](#)

[Mass Storage Devices](#)

[Miscellaneous Cable Kit](#)

[Cables](#)

[Miscellaneous Hardware and Plastics Kit](#)

[Miscellaneous Parts](#)

[Documentation and Software](#)

Place cursor over each device to obtain its part number.

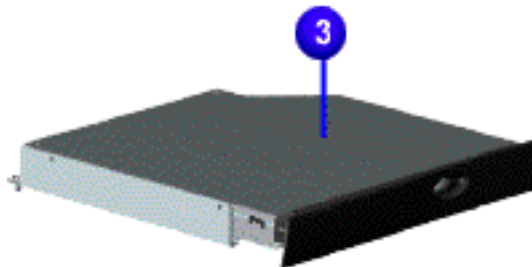
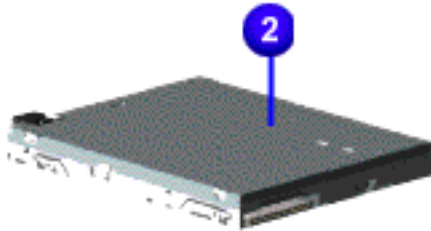
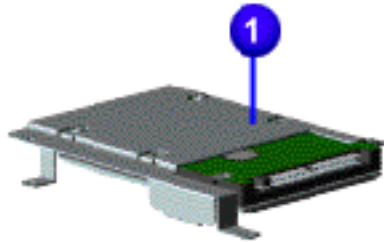

maintenance & service guide

Presario 1200 Series

Models: 1255, 1256, 1260, 1262, 1266, 1267, 1272, 1273, 1274, and 1275

Before You Begin	Specifications	Parts Catalog
Removal Sequence	Troubleshooting	Battery Operations
Product Description	Pin Assignments	Index

Miscellaneous Cables Kit

[System Unit](#)

[Boards](#)

[Display
Assembly](#)

[Mass Storage
Devices](#)

**Miscellaneous
Cable Kit**

[Cables](#)

[Miscellaneous
Hardware and
Plastics Kit](#)

[Miscellaneous
Parts](#)

[Documentation
and Software](#)

Place cursor over each device for a description of that item.

Spare Part Number: 330946-001

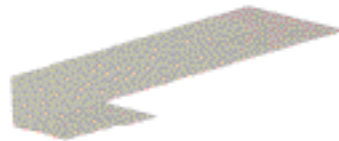
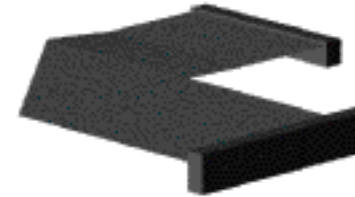

maintenance & service guide

Presario 1200 Series

Models: 1255, 1256, 1260, 1262, 1266, 1267, 1272, 1273, 1274, and 1275

Before You Begin	Specifications	Parts Catalog
Removal Sequence	Troubleshooting	Battery Operations
Product Description	Pin Assignments	Index

Cables

[System Unit](#)

[Boards](#)

[Display Assembly](#)

[Mass Storage Devices](#)

[Miscellaneous Cable Kit](#)

[Cables](#)

[Miscellaneous Hardware and Plastics Kit](#)

[Miscellaneous Parts](#)

[Documentation and Software](#)

Description	Spare Part Number
<i>Power Cord</i>	[FrontPage Save Results Component]

Description	Spare Part Number
<i>Modem Cables</i>	

maintenance & service guide

Presario 1200 Series

Models: 1255, 1256, 1260, 1262, 1266, 1267, 1272, 1273, 1274, and 1275

Before You Begin	Specifications	Parts Catalog
Removal Sequence	Troubleshooting	Battery Operations
Product Description	Pin Assignments	Index

Miscellaneous Hardware and Plastics Kit

[System Unit](#)

[Boards](#)

[Display Assembly](#)

[Mass Storage Devices](#)

[Miscellaneous Cable Kit](#)

[Cables](#)

[Miscellaneous Hardware and Plastics Kit](#)

[Miscellaneous Parts](#)

[Documentation and Software](#)

Miscellaneous Hardware and Plastics Kit

Hardware Spare Part Number:

346853-001

Plastics Kit Spare Part Number

(Models 1255-1267): 330949-001;

(Models 1272-1275): 142657-001

Description	Quantity
1. Door, Battery Pack	1 each
2. Cover, Memory Module	1 each
3. Door, PCMCIA	2 each
4. Hinge (Clutch) Cover, Left	1 each
5. Hinge (Clutch) Cover, Right	1 each
6. Rubber Foot	10 each
7. Hard Drive Mounting Bracket	1 each

maintenance & service guide

Presario 1200 Series

Models: 1255, 1256, 1260, 1262, 1266, 1267, 1272, 1273, 1274, and 1275

Before You Begin	Specifications	Parts Catalog
Removal Sequence	Troubleshooting	Battery Operations
Product Description	Pin Assignments	Index

Miscellaneous Parts

[System Unit](#)

[Boards](#)

[Display
Assembly](#)

[Mass Storage
Devices](#)

[Miscellaneous
Cable Kit](#)

[Cables](#)

[Miscellaneous
Hardware and
Plastics Kit](#)

[Miscellaneous
Parts](#)

[Documentation
and Software](#)



Use the scroll down menu for the description and spare part number of spare parts *Not Shown*.

maintenance & service guide

Presario 1200 Series

Models: 1255, 1256, 1260, 1262, 1266, 1267, 1272, 1273, 1274, and 1275

Before You Begin	Specifications	Parts Catalog
Removal Sequence	Troubleshooting	Battery Operations
Product Description	Pin Assignments	Index

Documentation and Software

[System Unit](#)

[Boards](#)

[Display Assembly](#)

[Mass Storage Devices](#)

[Miscellaneous Cable Kit](#)

[Cables](#)

[Miscellaneous Hardware and Plastics Kit](#)

[Miscellaneous Parts](#)

[Documentation and Software](#)

NOTE: The following information applies only to Models 1255-1267.

Description	Spare Part Number
Quick Restore CD	
Australia	388205-371
China (PRC)	388205-AA1
Quick Reference Guide (single issue)	162212-001
Quick Reference Guide (quarterly subscription)	184960-001
QuickFind for Windows*, Asia Pacific Edition	137906-xxx

* QuickFind is updated monthly. To complete the QuickFind part number, add the suffix from the table below for the desired month. If you do not specify the 3-digit suffix, the default is the current month in which the order is placed.

QuickFind Part Number Suffix			
Suffix	Month	Suffix	Month
-001	January	-007	July
-002	February	-008	August
-003	March	-009	September
-004	April	-010	October
-005	May	-011	November
-006	June	-012	December

NOTE: The following information applies only to Models 1272-1275.

Description	Spare Part Number
Reference Guide (All countries except French Canada, Latin America, and Mexico)	117894-001
French Canada	117894-121
Latin America, Mexico	117894-161
Quick Restore CD (All countries except French Canada, Latin America, Mexico, and the Caribbean)	122315-001
French Canada	122315-121
Latin America, Mexico	122315-161
Caribbean	140472-001
Feature Guide (All countries except French Canada, Latin America, and Mexico)	120231-001
French Canada	120231-121
Latin America, Mexico	120231-161

maintenance & service guide

Presario 1200 Series

Models: 1255, 1256, 1260, 1262, 1266, 1267, 1272, 1273, 1274, and 1275

Before You Begin	Specifications	Parts Catalog
Removal Sequence	Troubleshooting	Battery Operations
Product Description	Pin Assignments	Index

Removal and Replacement Procedures

This section explains the removal and replacement procedures for the computer.

Serial Number Location

Disassembly Sequence

[Electrostatic Discharge](#)

[Service Considerations](#)

[Cables and Connectors](#)

[Preparing the Computer for Disassembly](#)

[Battery Pack](#)

[Palmrest Cover with Touch Pad](#)

[Heatspreader](#)

[Keyboard](#)

[Processor](#)

[Hard Drives](#)

[CD Drive](#)

[Battery Charger Board](#)

[Modem](#)

[Display Panel Assembly](#)

[Upper CPU Cover](#)

[Speaker Assembly](#)

[Diskette Drive](#)

[Fan Assembly](#)

[System Board](#)

[Dip Switch Settings](#)

[Memory Module](#)

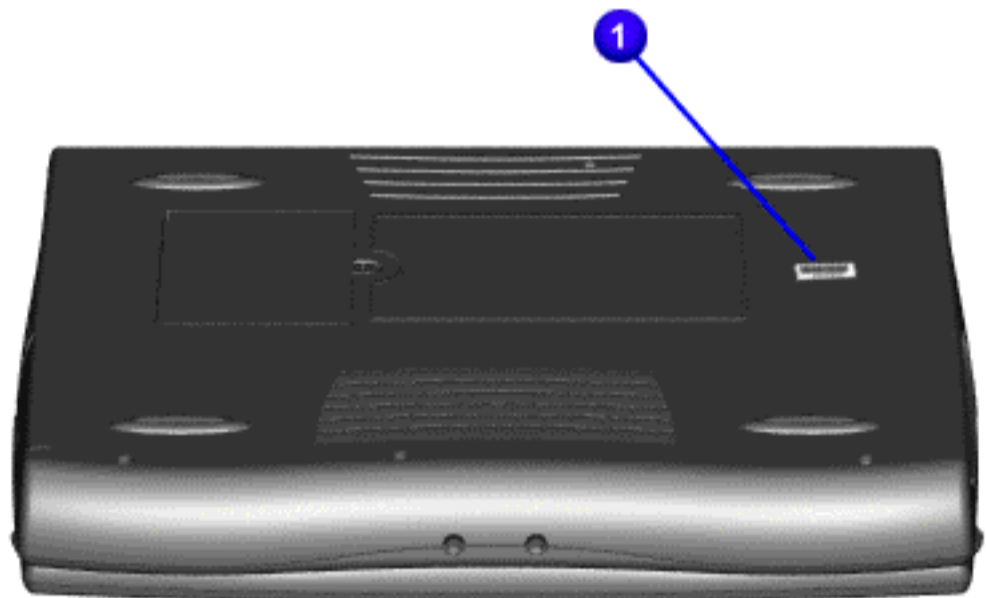

Report the computer [1] serial number to Compaq when requesting information or ordering spare parts.

maintenance & service guide

Presario 1200 Series

Models: 1255, 1256, 1260, 1262, 1266, 1267, 1272, 1273, 1274, and 1275

Before You Begin	Specifications	Parts Catalog
Removal Sequence	Troubleshooting	Battery Operations
Product Description	Pin Assignments	Index

Electrostatic Discharge



A sudden discharge of static electricity from a finger or other conductor can destroy static-sensitive devices or microcircuitry.

- Often the spark is neither felt nor heard, but damage occurs. An electronic device exposed to an electrostatic discharge (ESD) may not be affected at all and will work perfectly throughout a normal cycle. Although it may function normally for a while, it is possible for the exposed device's internal layers to degrade, reducing its life expectancy considerably.
- Networks built into multiple integrated circuits provide some protection, but in many cases, the discharge can contain enough power to alter device parameters and melt silicon junctions.

Generating Static

This table shows the different electrostatic voltage levels generated by various activities.

NOTE: 700 volts can degrade a product.

Typical Electrostatic Voltages

Event	Relative Humidity		
	10%	40%	55%
Walking across carpet	35,000 V	15,000 V	7,500 V
Walking across vinyl floor	12,000 V	5,000 V	3,000 V
Motions of bench worker	6,000 V	800 V	400 V
Removing DIPS from plastic tubes	2,000 V	700 V	400 V
Removing DIPS from vinyl trays	11,500 V	4,000 V	2,000 V
Removing DIPS from Styrofoam	14,500 V	5,000 V	3,500 V
Removing bubble pack from PCBs	26,000 V	20,000 V	7,000 V
Packing PCBs in foam-lined box	21,000 V	11,000 V	5,000 V

Return to [Removal & Replacement Procedures](#)

maintenance & service guide

Presario 1200 Series

Models: 1255, 1256, 1260, 1262, 1266, 1267, 1272, 1273, 1274, and 1275

Before You Begin	Specifications	Parts Catalog
Removal Sequence	Troubleshooting	Battery Operations
Product Description	Pin Assignments	Index

Service Considerations

Listed below are some of the considerations that you should keep in mind during the disassembly and re-assembly of the computer.

Tool and Software Requirements

To service the computer, you need the following:

- Compaq screwdriver kit (Spare Part No. 161946-001)
- Torx T-9 screwdriver
- 3/16-inch and 5mm nut drivers (for screwlocks and standoffs)
- Small, standard screwdriver
- Small, Phillips screwdriver
- Diagnostics software

Screws

The screws used in the computer are not interchangeable. If an incorrect screw is used during the reassembly process it can damage the unit.

Compaq strongly recommends that each screw removed during disassembly be kept with the part from which it was removed, then returned to the original location.

IMPORTANT:

As each subassembly is removed from the computer, it should be placed away from the work area to prevent damage.

[Return to Removal & Replacement Procedures](#)

maintenance & service guide

Presario 1200 Series

Models: 1255, 1256, 1260, 1262, 1266, 1267, 1272, 1273, 1274, and 1275

Before You Begin	Specifications	Parts Catalog
Removal Sequence	Troubleshooting	Battery Operations
Product Description	Pin Assignments	Index

Cables and Connectors

Most cables used throughout the units are ribbon cables; they must be handled with extreme care to avoid damage.

Use the following precautions when handling cables to prevent damage to the cable or computer:

- Apply only the required tension to seat or unseat the cables during insertion and removal from the connector.
- Handle cables by the connector whenever possible.
- In all cases, avoid bending, twisting, or tearing the cables, and ensure that the cables are routed in such a way that they cannot be caught or snagged by parts being removed or replaced. Handle flex cables with extreme care; they can tear easily.



CAUTION: When servicing these computers, ensure that cables are placed in their proper location during the reassembly process. Improper cable placement can cause severe damage to the unit.

Select the desired illustration.

- Removing a Cable from a **ZIF Connector**.
- The ribbon cable position for the **3.2-GB, 4.0-GB, 4.3-GB, and 6.4-GB hard drive**.
- The ribbon cable position for the **CD drive**.
- The ribbon cable position for the **diskette drive**.
- The cable position for the **speaker assembly**.

Plastic Parts

Plastic parts can be damaged if excessive force is used during disassembly and reassembly. When handling the plastic parts, use care. Apply pressure only at the points designated in the maintenance instructions.

Return to [Removal & Replacement Procedures](#)

Maintenance & Service Guide

Presario 1200 Series

Models: 1255, 1256, 1260, 1262, 1266, 1267, 1272, 1273, 1274, and 1275

[Home Page](#) | [Notice](#) | [Preface](#) | [Product Description](#) | [Troubleshooting](#)
[Illustrated Parts Catalog](#) | [Removal & Replacement Procedures](#) | [Specifications](#)
[Pin Assignments](#) | [Battery Pack Operations](#)

ZIF Connectors

The computer uses a zero insertion force (ZIF) connector for the keyboard cable to the system board. To remove a cable from a ZIF connector, lift both corners of the ZIF connector and slide simultaneously with constant light force.

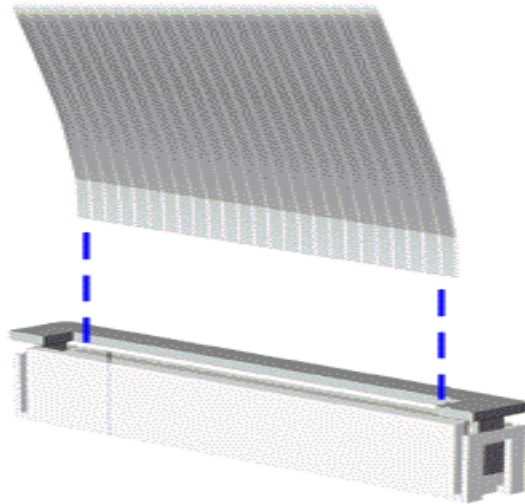

CAUTION: A ZIF connector and its attached cable can be easily damaged. Handle only the connector slide when removing or replacing a cable. Never pull or twist on the cable while it is connected.



CAUTION: When servicing this computer, ensure that cables are placed in their proper location during the reassembly process. Improper cable placement can damage the computer.

Back to [Cables and Connectors](#).

Maintenance & Service Guide

Presario 1200 Series

Models: 1255, 1256, 1260, 1262, 1266, 1267, 1272, 1273, 1274, and 1275

| [Home Page](#) | [Notice](#) | [Preface](#) | [Product Description](#) | [Troubleshooting](#)
[Illustrated Parts Catalog](#) | [Removal & Replacement Procedures](#) | [Specifications](#)
[Pin Assignments](#) | [Battery Pack Operations](#)

The ribbon cable position for the 3.2-GB, 4.0-GB,
4.3-GB,
or 6.4-GB hard drive.

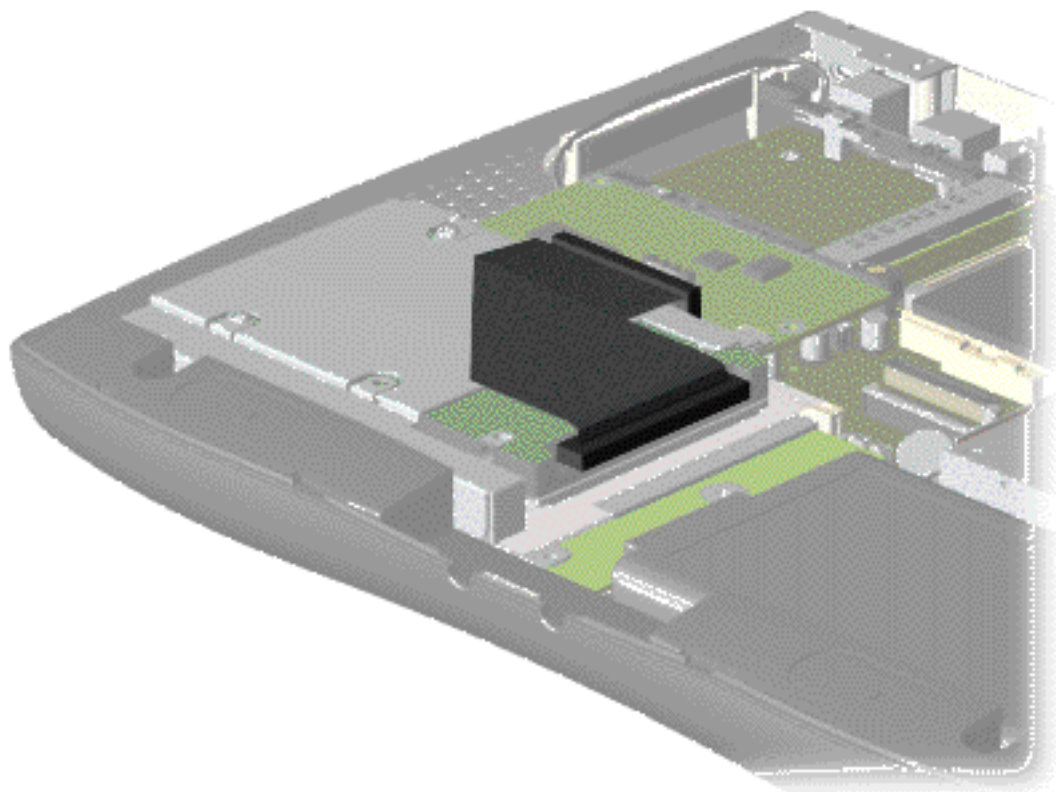

Back to [Cables and Connectors](#).

Maintenance & Service Guide

Presario 1200 Series

Models: 1255, 1256, 1260, 1262, 1266, 1267, 1272, 1273, 1274, and 1275

| [Home Page](#) | [Notice](#) | [Preface](#) | [Product Description](#) | [Troubleshooting](#)
[Illustrated Parts Catalog](#) | [Removal & Replacement Procedures](#) | [Specifications](#)
[Pin Assignments](#) | [Battery Pack Operations](#)

The ribbon cable position for the CD drive.

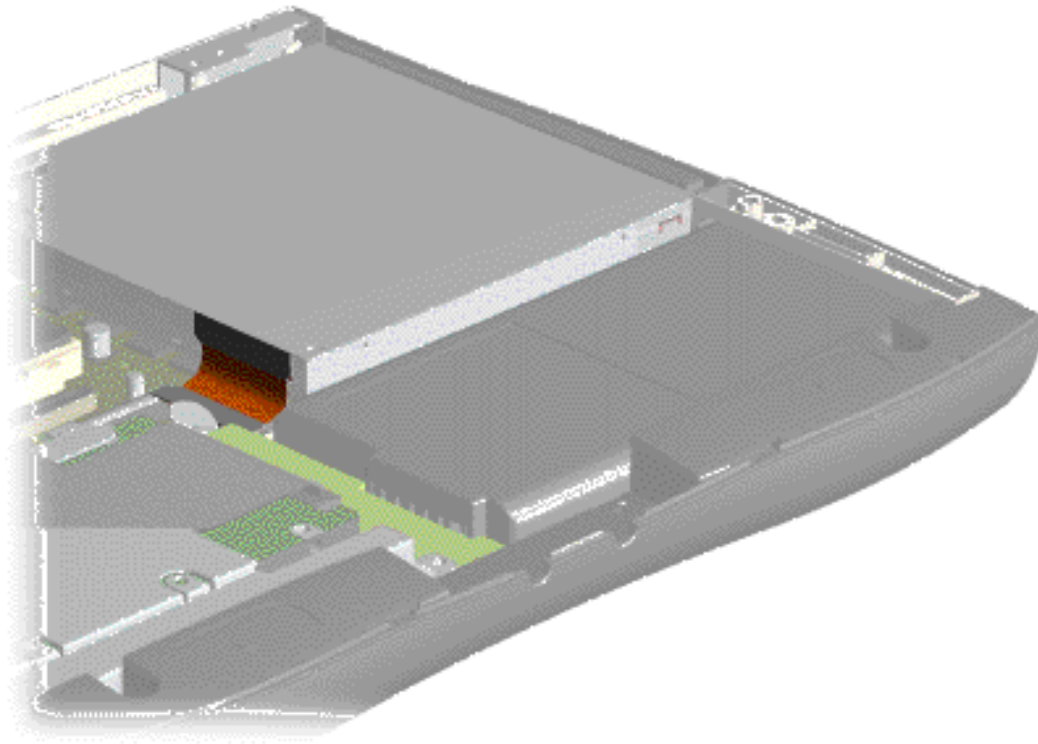

Back to [Cables and Connectors](#).

Maintenance & Service Guide

Presario 1200 Series

Models: 1255, 1256, 1260, 1262, 1266, 1267, 1272, 1273, 1274, and 1275

| [Home Page](#) | [Notice](#) | [Preface](#) | [Product Description](#) | [Troubleshooting](#)
[Illustrated Parts Catalog](#) | [Removal & Replacement Procedures](#) | [Specifications](#)
[Pin Assignments](#) | [Battery Pack Operations](#)

The ribbon cable position for the diskette drive.

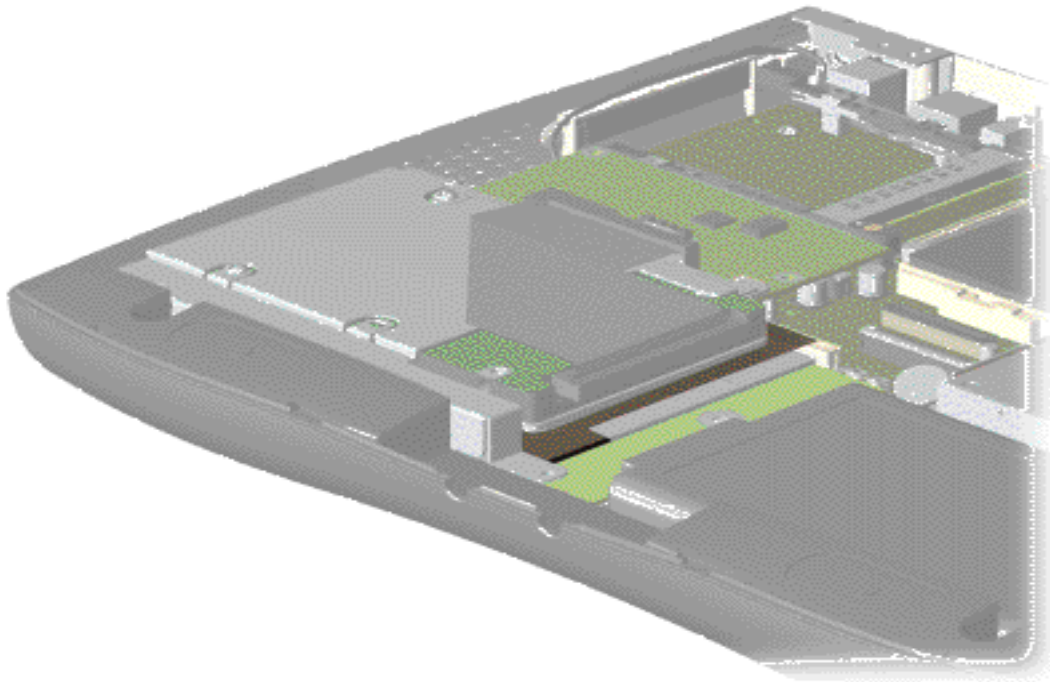

Back to [Cables and Connectors](#).

Maintenance & Service Guide

Presario 1200 Series

Models: 1255, 1256, 1260, 1262, 1266, 1267, 1272, 1273, 1274, and 1275

| [Home Page](#) | [Notice](#) | [Preface](#) | [Product Description](#) | [Troubleshooting](#)
[Illustrated Parts Catalog](#) | [Removal & Replacement Procedures](#) | [Specifications](#)
[Pin Assignments](#) | [Battery Pack Operations](#)

The cable position for the speaker assembly.

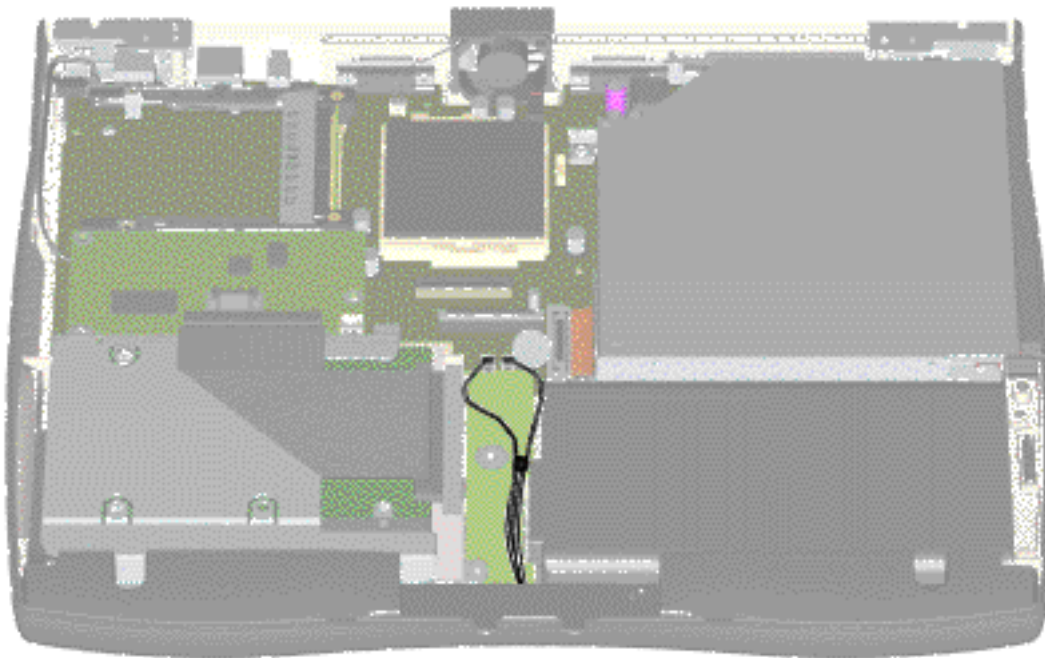

Back to [Cables and Connectors](#).

maintenance & service guide

Presario 1200 Series

Models: 1255, 1256, 1260, 1262, 1266, 1267, 1272, 1273, 1274, and 1275

Before You Begin	Specifications	Parts Catalog
Removal Sequence	Troubleshooting	Battery Operations
Product Description	Pin Assignments	Index

Preparing the Computer for Disassembly

Before beginning removal and replacement procedures, complete the following procedures:

- 1. Disconnect AC power and any external devices.**
- 2. Remove the battery pack.**
- 3. Remove any PC Cards.**

[Electrostatic Discharge](#)

[Service Considerations](#)

[Cables and Connectors](#)

[Preparing the Computer for Disassembly](#)

[Battery Pack](#)

[Palmrest Cover with Touch Pad](#)

[Heatspreader](#)

[Keyboard](#)

[Processor](#)

[Hard Drives](#)

[CD Drive](#)

[Battery Charger Board](#)

[Modem](#)

[Display Panel Assembly](#)

[Upper CPU Cover](#)

[Speaker Assembly](#)

[Diskette Drive](#)

[Fan Assembly](#)

[System Board](#)

[Dip Switch Settings](#)

[Memory Module](#)



WARNING: Metal objects can damage the battery pack as well as the battery contacts in the battery compartment. To prevent damage, do not allow metal objects to touch the battery contacts. Place only the battery pack for the Compaq Presario 1200 Series Portable Computers into the battery compartment. Do not force the battery pack into the bay if insertion does not occur easily.

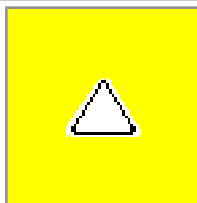

CAUTION: Do not crush, puncture, or incinerate the battery pack. Do not open a battery pack, as this damages the pack, makes it unusable, and exposes potentially harmful battery components. There are no field-serviceable parts located inside the battery pack.



The Compaq Presario 1200 Series Portable Computers have several screws of various sizes which are **not** interchangeable. Care must be taken during reassembly to ensure that the correct screws are used in their correct location. During removal please keep respective screws with their associated sub-assembly.

Return to [Removal & Replacement Procedures](#).

maintenance & service guide

Presario 1200 Series

Models: 1255, 1256, 1260, 1262, 1266, 1267, 1272, 1273, 1274, and 1275

Before You Begin	Specifications	Parts Catalog
Removal Sequence	Troubleshooting	Battery Operations
Product Description	Pin Assignments	Index

Removing the Battery Pack

[Electrostatic Discharge](#)

[Service Considerations](#)

[Cables and Connectors](#)

[Preparing the Computer for Disassembly](#)

[Battery Pack](#)

[Palmrest Cover with Touch Pad](#)

[Heatspreader](#)

[Keyboard](#)

[Processor](#)

[Hard Drives](#)

[CD Drive](#)

[Battery Charger Board](#)

[Modem](#)

[Display Panel Assembly](#)

[Upper CPU Cover](#)

[Speaker Assembly](#)

[Diskette Drive](#)

[Fan Assembly](#)

[System Board](#)

[Dip Switch Settings](#)

[Memory Module](#)

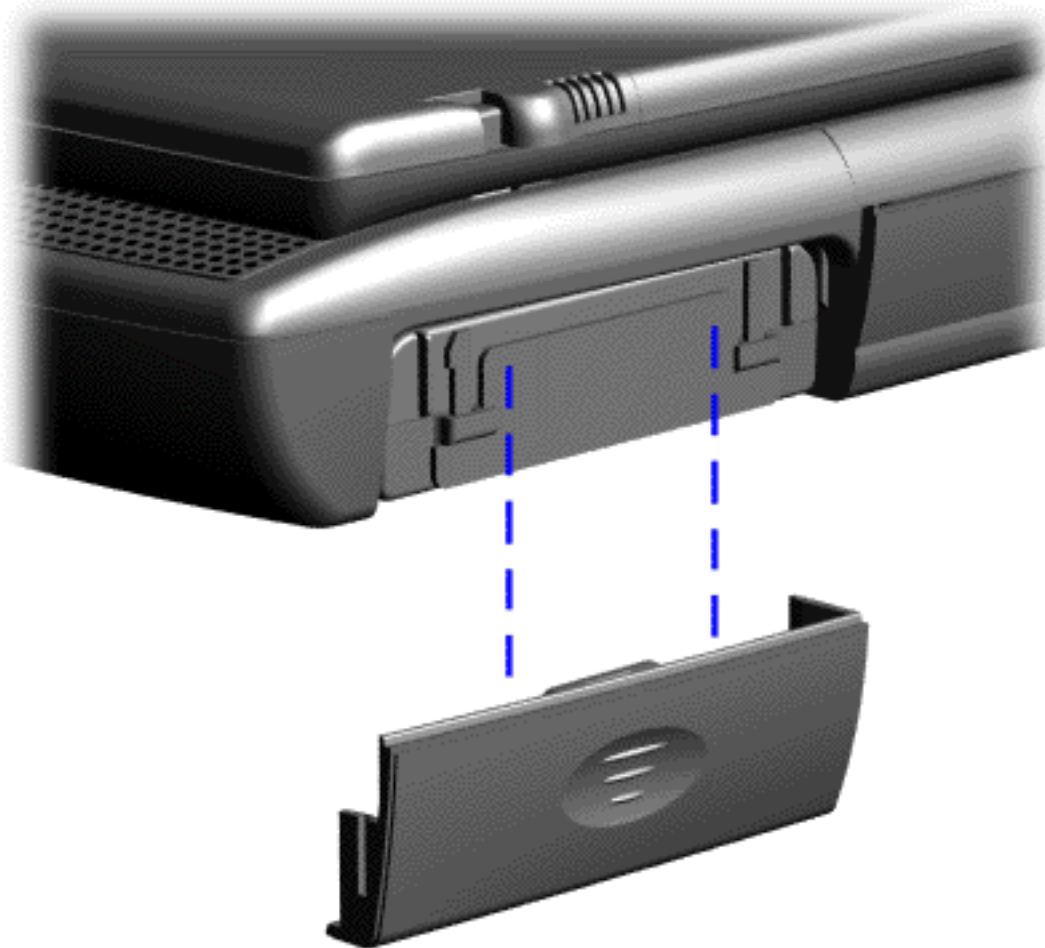

To remove the battery pack, complete the following steps:

1. Slide the battery pack compartment door down and remove it from the battery pack.

[Next Step](#)

maintenance & service guide

Presario 1200 Series

Models: 1255, 1256, 1260, 1262, 1266, 1267, 1272, 1273, 1274, and 1275

Before You Begin	Specifications	Parts Catalog
Removal Sequence	Troubleshooting	Battery Operations
Product Description	Pin Assignments	Index

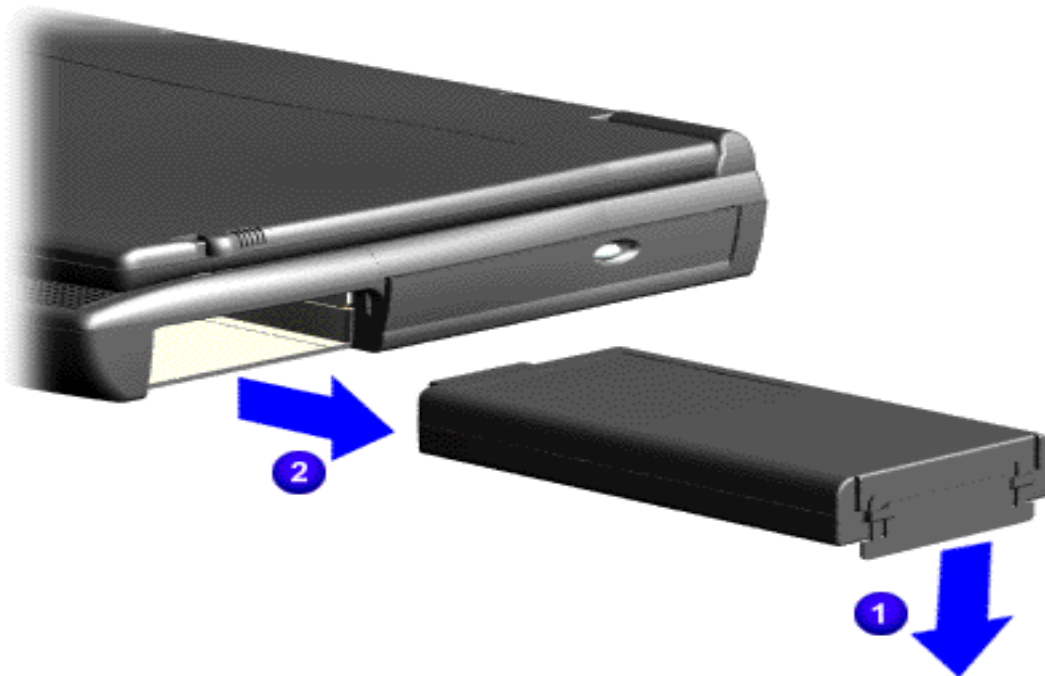

2. Pull forward on the battery pack tab **1** and remove the battery pack **2** from the chassis.

To replace the battery pack, reverse the previous procedures.

Return to **Removal & Replacement Procedures**

maintenance & service guide

Presario 1200 Series

Models: 1255, 1256, 1260, 1262, 1266, 1267, 1272, 1273, 1274, and 1275

Before You Begin	Specifications	Parts Catalog
Removal Sequence	Troubleshooting	Battery Operations
Product Description	Pin Assignments	Index

Removing the Palmrest Cover with Touch Pad

[Electrostatic Discharge](#)

[Service Considerations](#)

[Cables and Connectors](#)

[Preparing the Computer for Disassembly](#)

[Battery Pack](#)

Palmrest Cover with Touch Pad

[Heatspreader](#)

[Keyboard](#)

[Processor](#)

[Hard Drives](#)

[CD Drive](#)

[Battery Charger Board](#)

[Modem](#)

[Display Panel Assembly](#)

[Upper CPU Cover](#)

[Speaker Assembly](#)

[Diskette Drive](#)

[Fan Assembly](#)

[System Board](#)

[Dip Switch Settings](#)

[Memory Module](#)

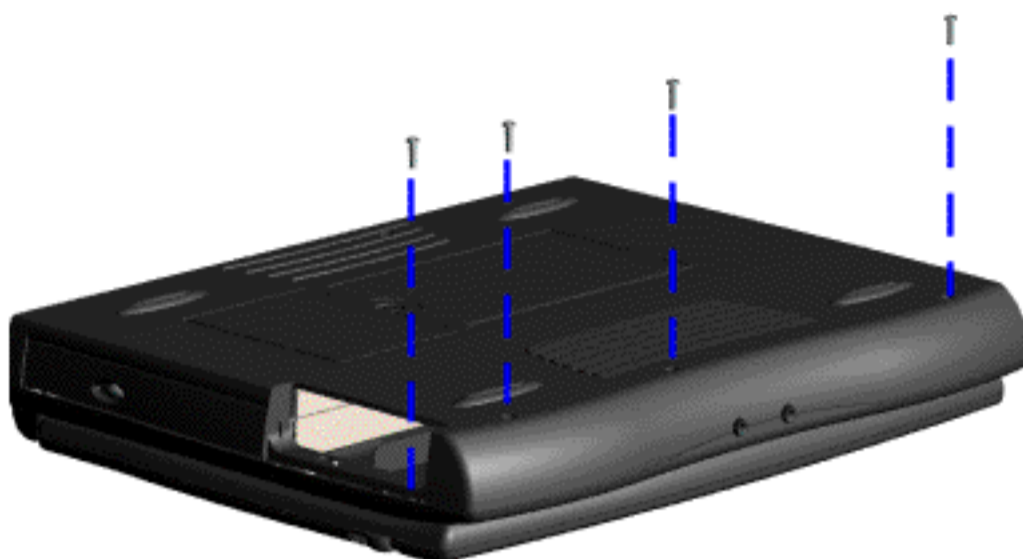

The palmrest cover with touch pad must be removed to gain access to any of the interior components of the computer, and it is the first component that has to be removed to gain access to the interior components.

NOTE: It is not necessary to remove the display panel assembly to access the interior components of the computer.

To remove the palmrest cover with touch pad, complete the following steps:

1. [Prepare the computer for disassembly.](#)
2. Close the computer and turn the computer upside down.
3. Remove four screws from the bottom of the computer.

[Next Step](#)

maintenance & service guide

Presario 1200 Series

Models: 1255, 1256, 1260, 1262, 1266, 1267, 1272, 1273, 1274, and 1275

Before You Begin	Specifications	Parts Catalog
Removal Sequence	Troubleshooting	Battery Operations
Product Description	Pin Assignments	Index

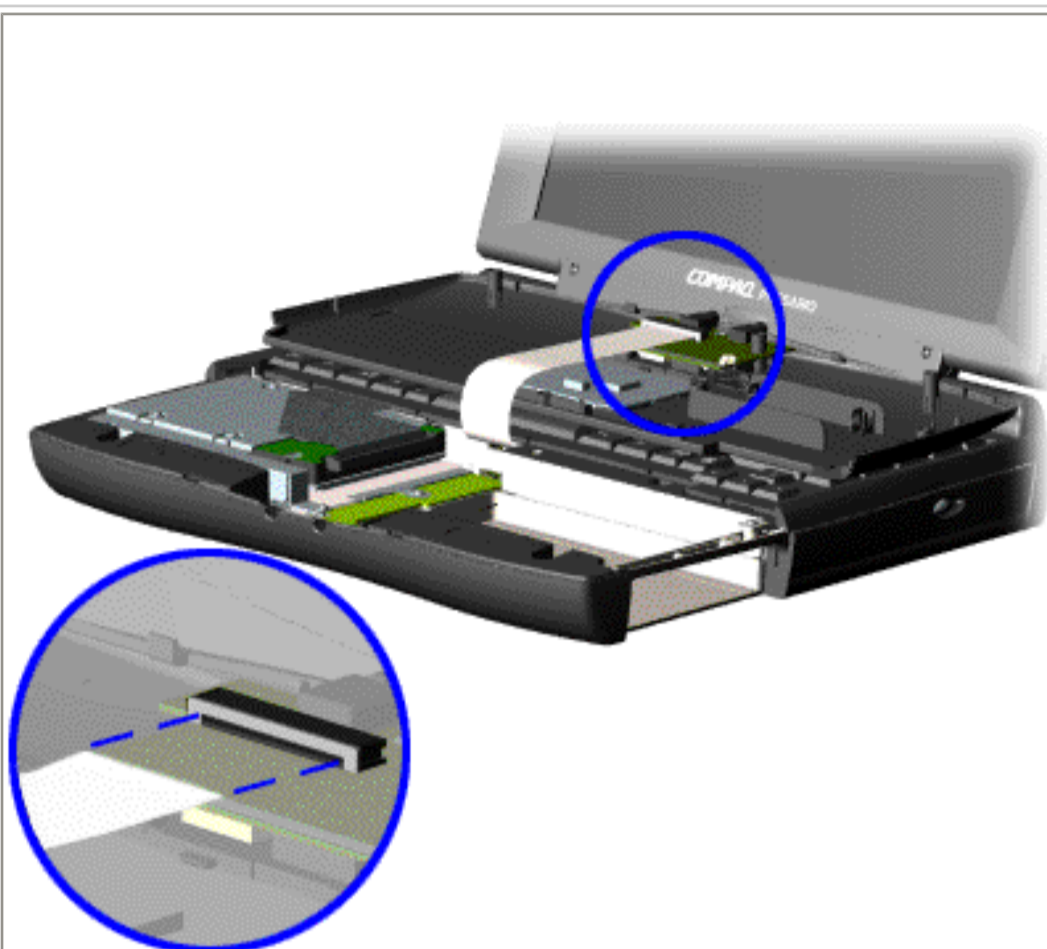

4. Turn the computer over (right side up), pull forward on the display latches to release and open the display assembly.

5. Lift up front end of the palmrest cover with touch pad and remove it from the groove in the chassis.

6. Tilt the palmrest cover with touch pad, allowing it to rest on top of the keyboard, and disconnect the flex cable from the ZIF connector on the palmrest cover.

CAUTION: When replacing the palmrest cover with touch pad, ensure that the cable is fully inserted into the ZIF connector on the system board. If the metal end comes in contact with the keyboard, damage may occur to the computer.

To replace the palmrest cover with touch pad, reverse the previous procedures.

NOTE: When replacing the palmrest cover, ensure that the cable is properly routed through the slot on the Upper CPU cover.

Return to [Removal & Replacement Procedures](#)

maintenance & service guide

Presario 1200 Series

Models: 1255, 1256, 1260, 1262, 1266, 1267, 1272, 1273, 1274, and 1275

Before You Begin	Specifications	Parts Catalog
Removal Sequence	Troubleshooting	Battery Operations
Product Description	Pin Assignments	Index

Removing the Heatspreader

[Electrostatic Discharge](#)

[Service Considerations](#)

[Cables and Connectors](#)

[Preparing the Computer for Disassembly](#)

[Battery Pack](#)

[Palmrest Cover with Touch Pad](#)

[Heatspreader](#)

[Keyboard](#)

[Processor](#)

[Hard Drives](#)

[CD Drive](#)

[Battery Charger Board](#)

[Modem](#)

[Display Panel Assembly](#)

[Upper CPU Cover](#)

[Speaker Assembly](#)

[Diskette Drive](#)

[Fan Assembly](#)

[System Board](#)

[Dip Switch Settings](#)

[Memory Module](#)

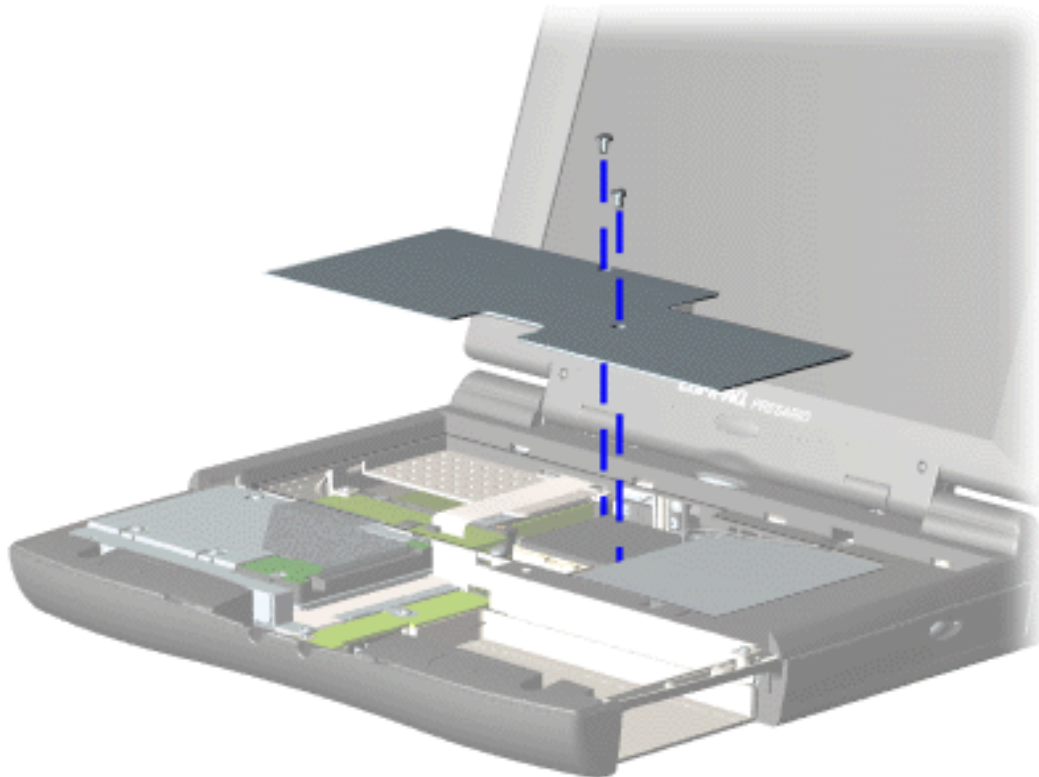

To remove the heatspreader, complete the following steps:

1. [Prepare the computer for disassembly.](#)

2. Remove the [palmrest cover with touch pad.](#)

3. Remove [Keyboard.](#)

4. Remove two screws from the heatspreader and lift out of the chassis.

To replace the heatspreader, reverse the previous procedures.

maintenance & service guide

Presario 1200 Series

Models: 1255, 1256, 1260, 1262, 1266, 1267, 1272, 1273, 1274, and 1275

Before You Begin	Specifications	Parts Catalog
Removal Sequence	Troubleshooting	Battery Operations
Product Description	Pin Assignments	Index

Removing the Keyboard

[Electrostatic Discharge](#)

[Service Considerations](#)

[Cables and Connectors](#)

[Preparing the Computer for Disassembly](#)

[Battery Pack](#)

[Palmrest Cover with Touch Pad](#)

[Heatspreader](#)

[Keyboard](#)

[Processor](#)

[Hard Drives](#)

[CD Drive](#)

[Battery Charger Board](#)

[Modem](#)

[Display Panel Assembly](#)

[Upper CPU Cover](#)

[Speaker Assembly](#)

[Diskette Drive](#)

[Fan Assembly](#)

[System Board](#)

[Dip Switch Settings](#)

[Memory Module](#)

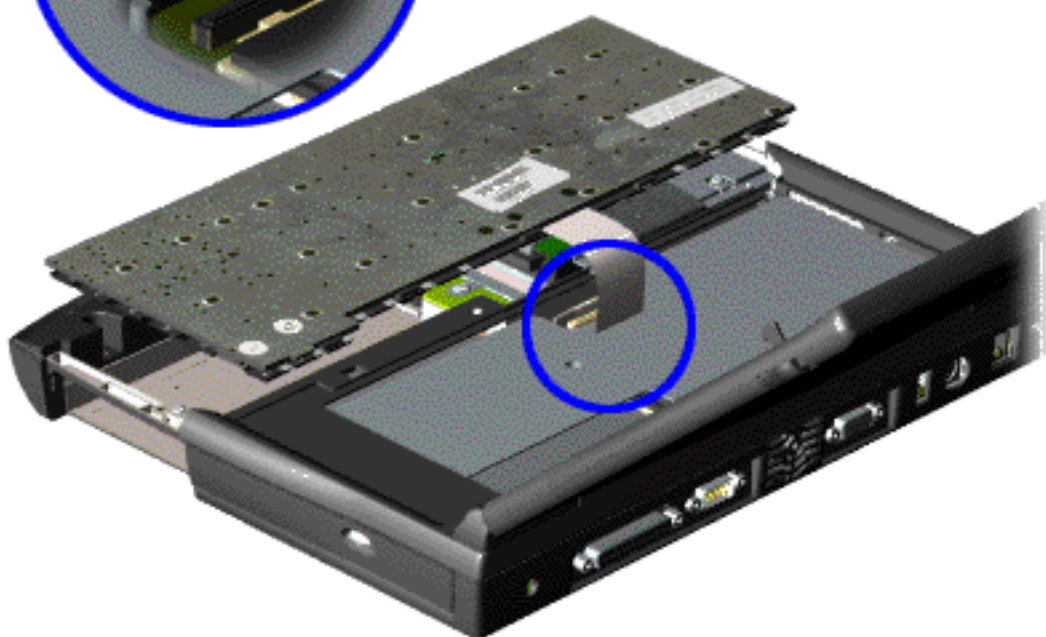
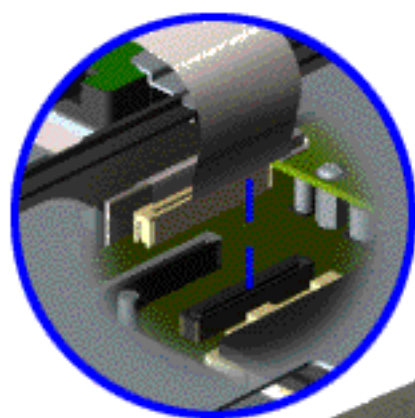

To remove the keyboard, complete the following steps:

1. [Prepare the computer for disassembly.](#)
2. [Remove the palmrest cover with touch pad.](#)
3. Turn the keyboard over, and allow it to rest on top of the palmrest cover with touchpad slot opening.
4. Remove the [heatspreader](#) .
5. Disconnect the flex cable from the ZIF connector on the system board.

To replace the keyboard, reverse the previous procedures.

[Return to Removal & Replacement Procedures](#)

maintenance & service guide

Presario 1200 Series

Models: 1255, 1256, 1260, 1262, 1266, 1267, 1272, 1273, 1274, and 1275

Before You Begin	Specifications	Parts Catalog
Removal Sequence	Troubleshooting	Battery Operations
Product Description	Pin Assignments	Index

Removing the Processor

[Electrostatic Discharge](#)

[Service Consideration](#)

[Cables and Connectors](#)

[Preparing the Computer for Disassembly](#)

[Battery Pack](#)

[Palmrest Cover with Touch Pad](#)

[Heatspreader](#)

[Keyboard](#)

[Processor](#)

[Hard Drives](#)

[CD Drive](#)

[Battery Charger Board](#)

[Modem](#)

[Display Panel Assembly](#)

[Upper CPU Cover](#)

[Speaker Assembly](#)

[Diskette Drive](#)

[Fan Assembly](#)

[System Board](#)

[Dip Switch Settings](#)

[Memory Module](#)

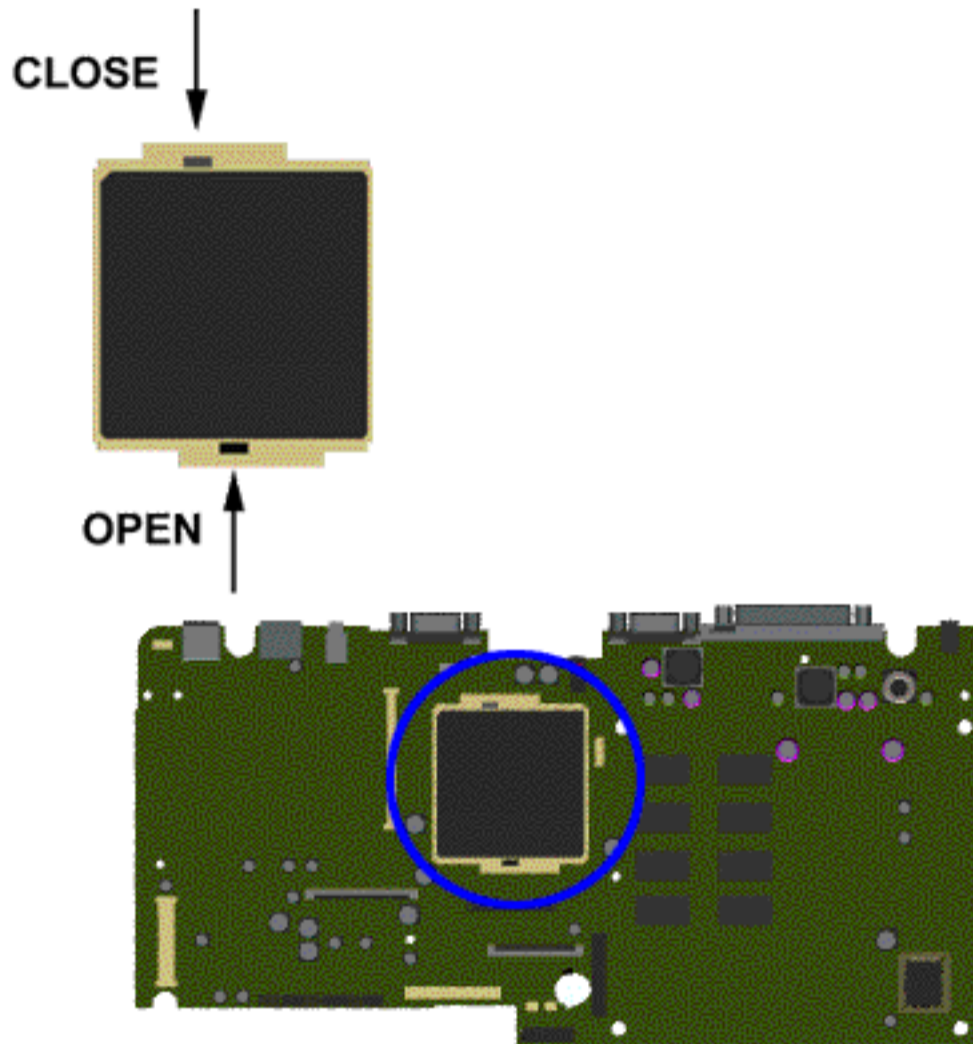

To remove the processor, complete the following steps:

1. [Prepare the computer for disassembly.](#)

2. Remove [palmrest cover with touch pad.](#)

3. Remove the [heatspreader.](#)

4. Remove the [keyboard.](#)

5. Insert a small-blade screwdriver into the bottom slot opening on the processor and push toward the display to release the processor from the chassis slot.

6. Lift the processor out of the processor chassis slot.

[Next Step](#)

maintenance & service guide

Presario 1200 Series

Models: 1255, 1256, 1260, 1262, 1266, 1267, 1272, 1273, 1274, and 1275

Before You Begin	Specifications	Parts Catalog
Removal Sequence	Troubleshooting	Battery Operations
Product Description	Pin Assignments	Index

To replace the processor complete the following steps:

1. Insert the processor into the slot on the system board.

NOTE:

The notch on the left corner of the processor serves as an orientation indicator. Align the notch on the left corner of the processor with the notch on the left corner of the processor chassis slot.

NOTE:

When installing the processor into the chassis slot, be sure that the hole pattern on the chassis slot lines up with the pins on the processor. The processor should drop into the socket without any force.

2. Insert a small blade screw driver into the top slot opening on the processor and push it away from the display to lock the processor.
3. Verify the [switch settings](#).

Return to [Removal & Replacement Procedures](#)

maintenance & service guide

Presario 1200 Series

Models: 1255, 1256, 1260, 1262, 1266, 1267, 1272, 1273, 1274, and 1275

Before You Begin	Specifications	Parts Catalog
Removal Sequence	Troubleshooting	Battery Operations
Product Description	Pin Assignments	Index



CAUTION: When replacing the system board, ensure the dip switch voltage settings on the system board are correct for the computer model and processor voltage marked on the processor chip. If the system board dip switch voltage settings are not correct, damage may occur to the computer and/or system board.

NOTE: The **black area on the dip switch** indicates the position of the switch.

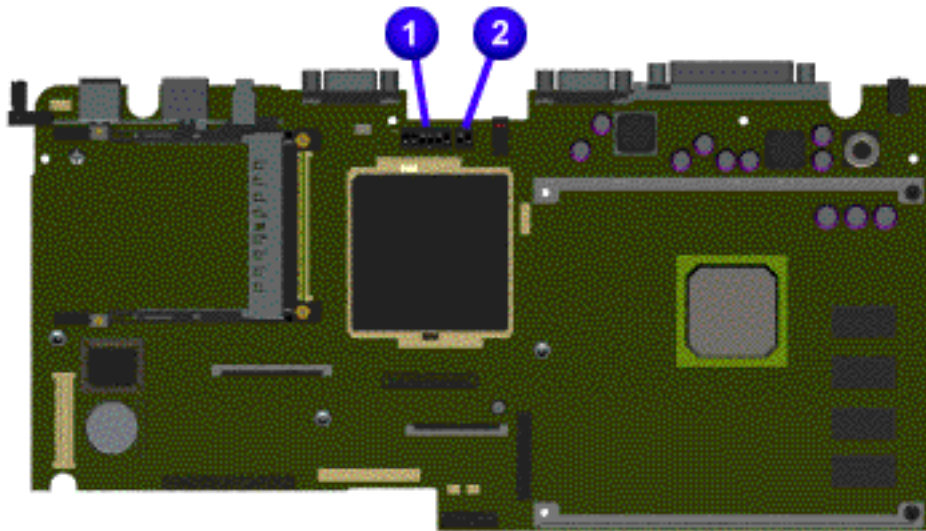

**For Models 1272,
1273, 1274, 1275:**

AMD 366 MHz, 2.2V

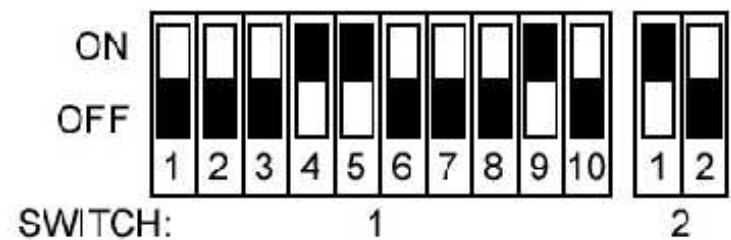

**For Models 1255,
1256, 1260, 1262,
1266, 1267:**

AMD 333 MHz, 2.2V

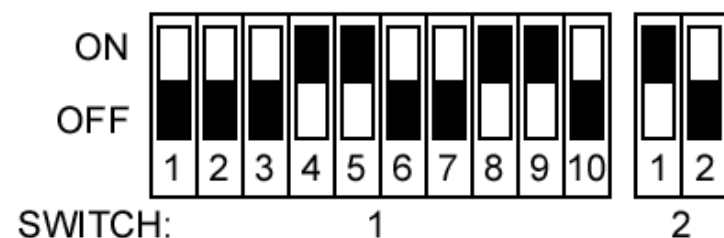

[Return to Removal & Replacement Procedures](#)

maintenance & service guide

Presario 1200 Series

Models: 1255, 1256, 1260, 1262, 1266, 1267, 1272, 1273, 1274, and 1275

Before You Begin	Specifications	Parts Catalog
Removal Sequence	Troubleshooting	Battery Operations
Product Description	Pin Assignments	Index

Removing the Hard Drive

[Electrostatic Discharge](#)

[Service Consideration](#)

[Cables and Connectors](#)

[Preparing the Computer for Disassembly](#)

[Battery Pack](#)

[Palmrest Cover with Touch Pad](#)

[Heatspreader](#)

[Keyboard](#)

[Processor](#)

[Hard Drives](#)

[CD Drive](#)

[Battery Charger Board](#)

[Modem](#)

[Display Panel Assembly](#)

[Upper CPU Cover](#)

[Speaker Assembly](#)

[Diskette Drive](#)

[Fan Assembly](#)

[System Board](#)

[Dip Switch Settings](#)

[Memory Module](#)

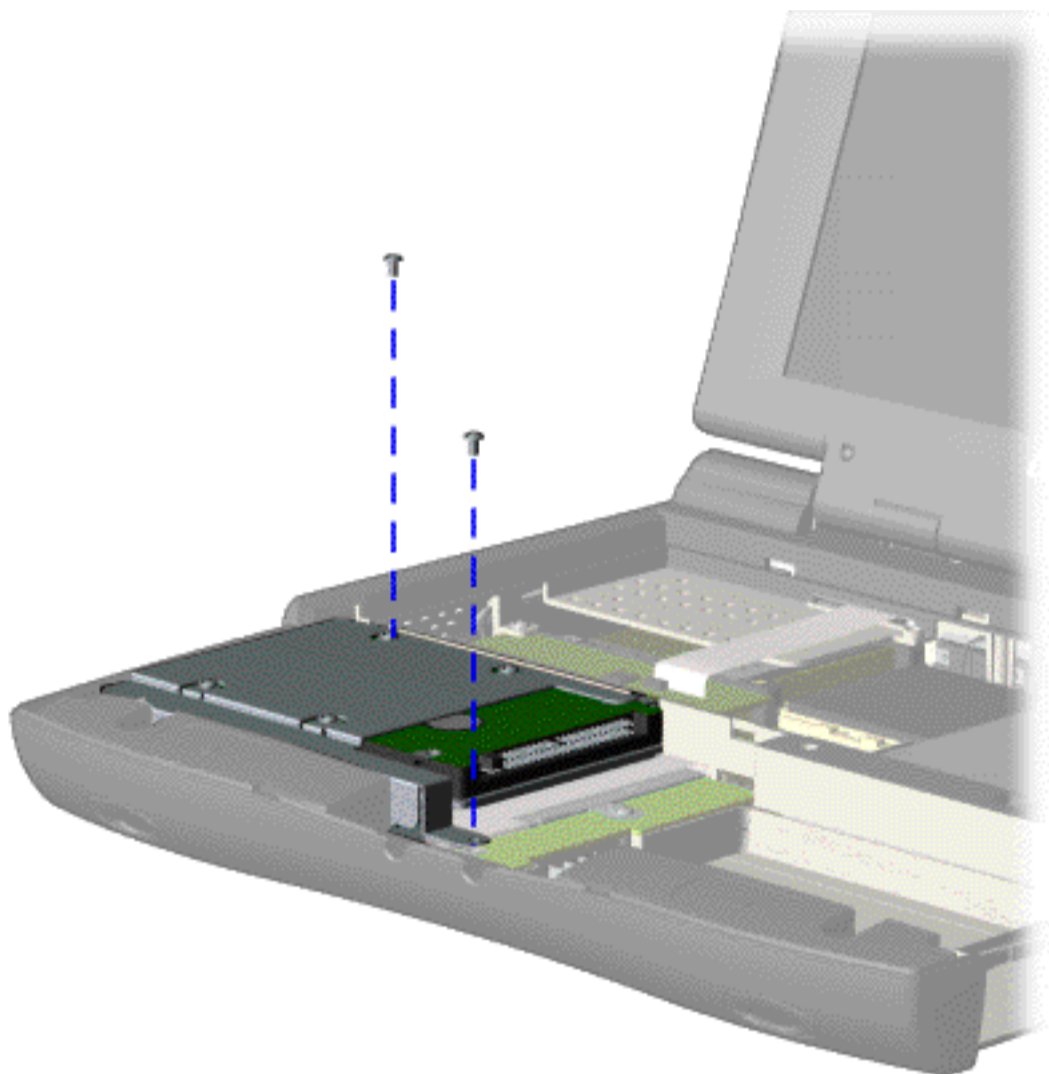

To remove the hard drive, complete the following steps:

1. Prepare the [computer for disassembly](#).
2. Remove the [palmrest cover with touch pad](#).
3. Remove the [keyboard](#).
4. Remove two screws from the hard drive mounting bracket and lift up the hard drive.

[Next Step](#)

maintenance & service guide

Presario 1200 Series

Models: 1255, 1256, 1260, 1262, 1266, 1267, 1272, 1273, 1274, and 1275

[Before You Begin](#)

[Specifications](#)

[Parts Catalog](#)

[Removal Sequence](#)

[Troubleshooting](#)

[Battery Operations](#)

[Product Description](#)

[Pin Assignments](#)

[Index](#)

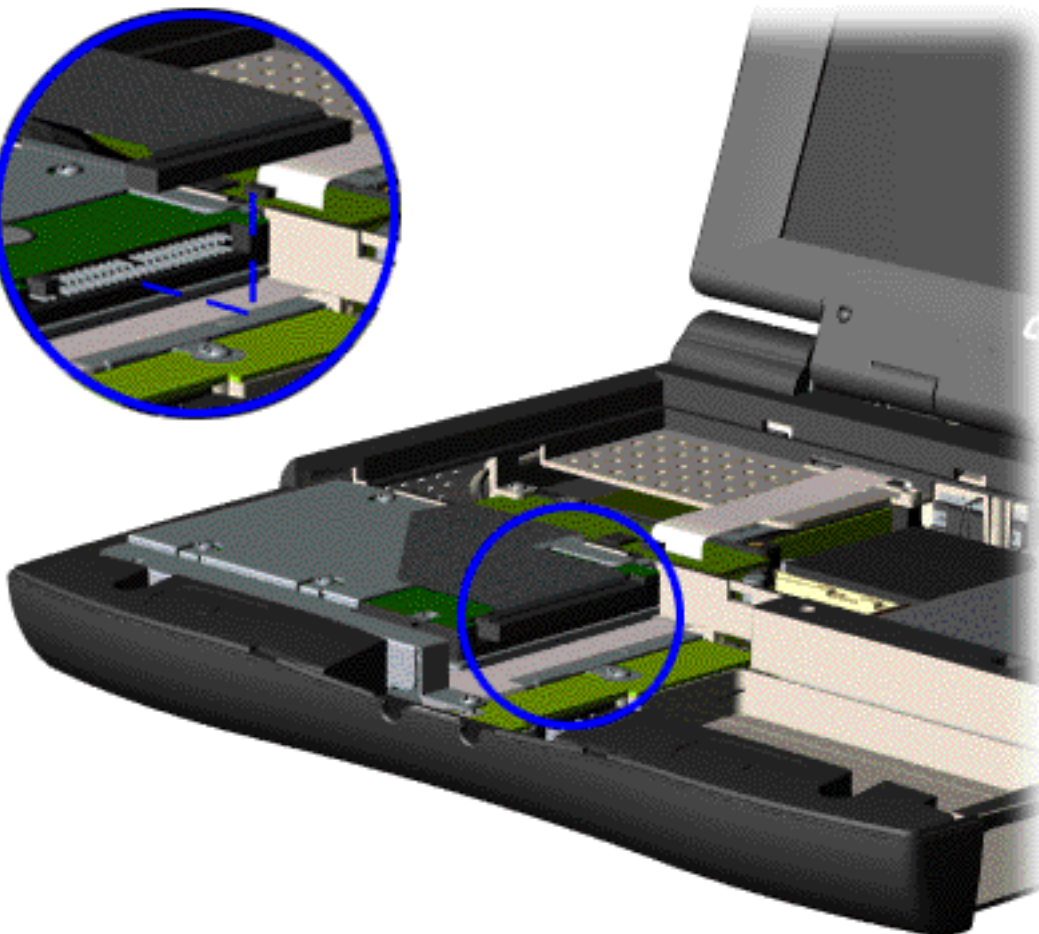
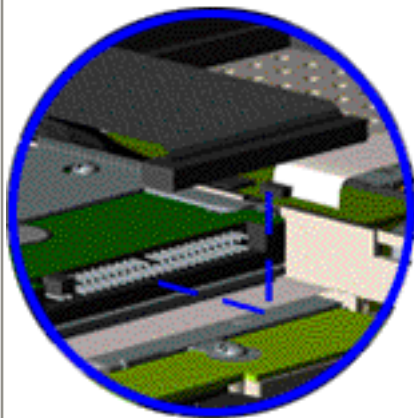

5. Disconnect the hard drive data cable from the hard drive and remove from the chassis.

[Next Step](#)

maintenance & service guide

Presario 1200 Series

Models: 1255, 1256, 1260, 1262, 1266, 1267, 1272, 1273, 1274, and 1275

Before You Begin	Specifications	Parts Catalog
Removal Sequence	Troubleshooting	Battery Operations
Product Description	Pin Assignments	Index

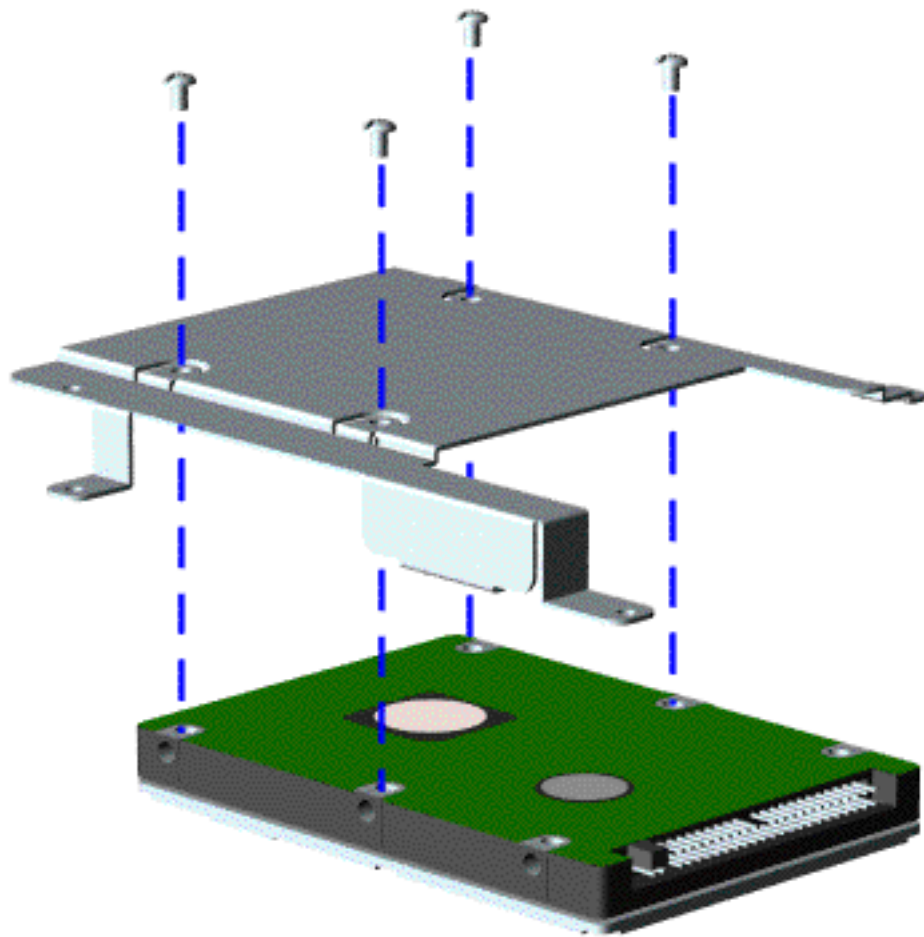

To remove the hard drive mounting bracket, remove four screws from the mounting bracket as shown in the illustration.

To replace the hard drive and hard drive mounting bracket, reverse the previous procedures.

Return to [Removal & Replacement Procedures](#)

maintenance & service guide

Presario 1200 Series

Models: 1255, 1256, 1260, 1262, 1266, 1267, 1272, 1273, 1274, and 1275

Before You Begin	Specifications	Parts Catalog
Removal Sequence	Troubleshooting	Battery Operations
Product Description	Pin Assignments	Index

Removing the CD Drive

[Electrostatic Discharge](#)

[Service Consideration](#)

[Cables and Connectors](#)

[Preparing the Computer for Disassembly](#)

[Battery Pack](#)

[Palmrest Cover with Touch Pad](#)

[Heatsreader](#)

[Keyboard](#)

[Processor](#)

[Hard Drives](#)

[CD Drive](#)

[Battery Charger Board](#)

[Modem](#)

[Display Panel Assembly](#)

[Upper CPU Cover](#)

[Speaker Assembly](#)

[Diskette Drive](#)

[Fan Assembly](#)

[System Board](#)

[Dip Switch Settings](#)

[Memory Module](#)

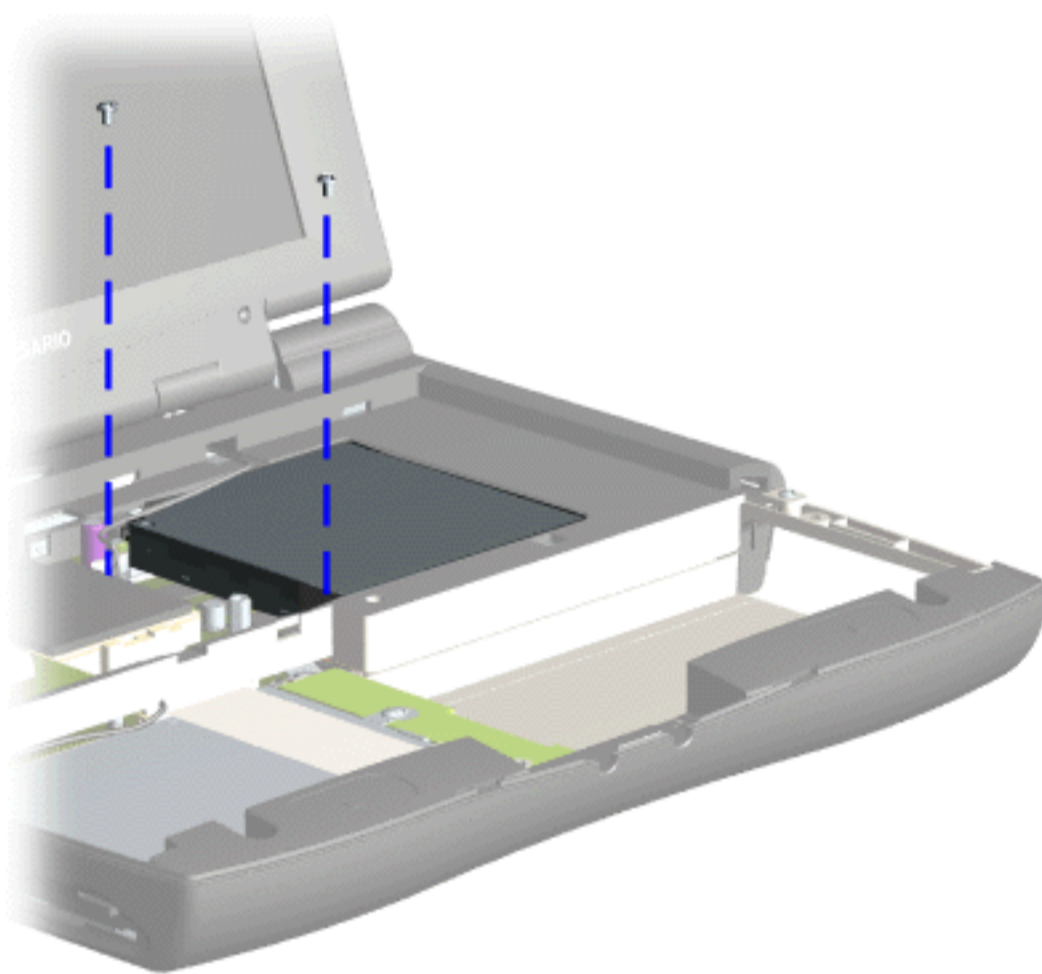

To remove the CD drive, complete the following steps:

1. Prepare the [computer for disassembly](#).

2. Remove the [palmrest cover with touch pad](#).

3. Remove the [heatsreader](#).

4. Remove the [keyboard](#).

5. Remove the two screws located at the back of the CD drive.

[Next Step](#)

maintenance & service guide

Presario 1200 Series

Models: 1255, 1256, 1260, 1262, 1266, 1267, 1272, 1273, 1274, and 1275

[Before You Begin](#)

[Specifications](#)

[Parts Catalog](#)

[Removal Sequence](#)

[Troubleshooting](#)

[Battery Operations](#)

[Product Description](#)

[Pin Assignments](#)

[Index](#)



6. Remove the two screws on the bottom of the unit that secure the CD bracket to the system board.

[Next Step](#)

maintenance & service guide

Presario 1200 Series

Models: 1255, 1256, 1260, 1262, 1266, 1267, 1272, 1273, 1274, and 1275

Before You Begin	Specifications	Parts Catalog
Removal Sequence	Troubleshooting	Battery Operations
Product Description	Pin Assignments	Index

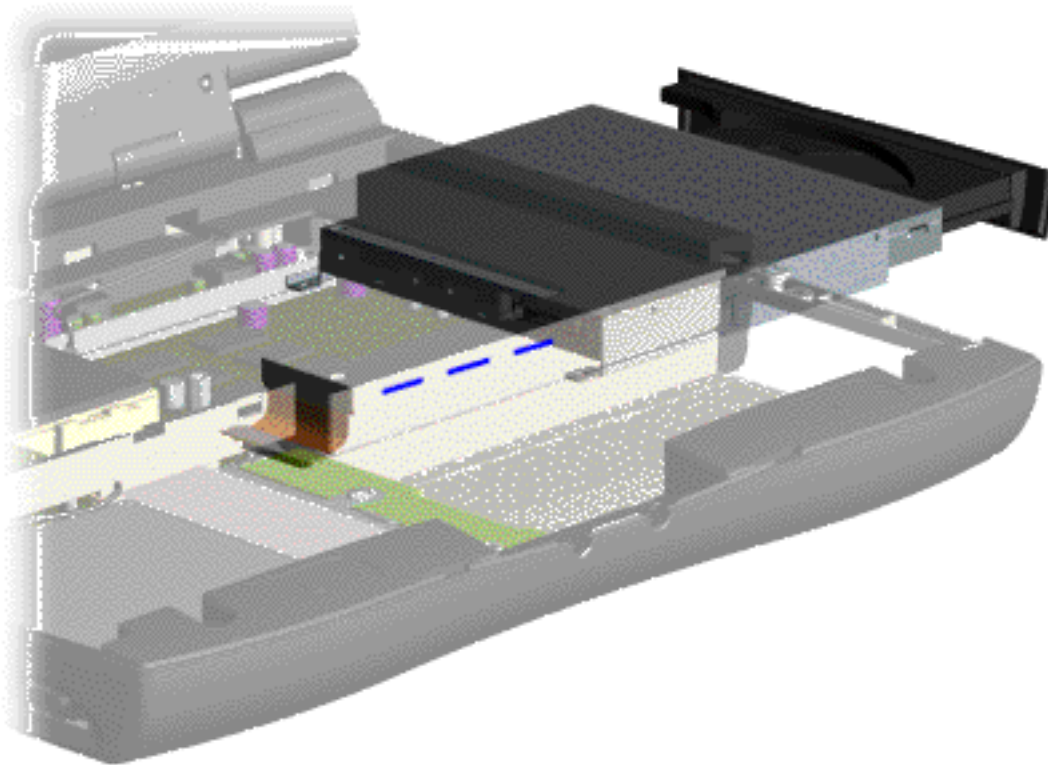

7. Disconnect the CD drive cable from the CD drive and remove the CD drive from the chassis.

To replace the CD drive, reverse the previous procedures.

Return to [**Removal & Replacement Procedures**](#)

maintenance & service guide

Presario 1200 Series

Models: 1255, 1256, 1260, 1262, 1266, 1267, 1272, 1273, 1274, and 1275

Before You Begin	Specifications	Parts Catalog
Removal Sequence	Troubleshooting	Battery Operations
Product Description	Pin Assignments	Index

Removing the Battery Charger Board

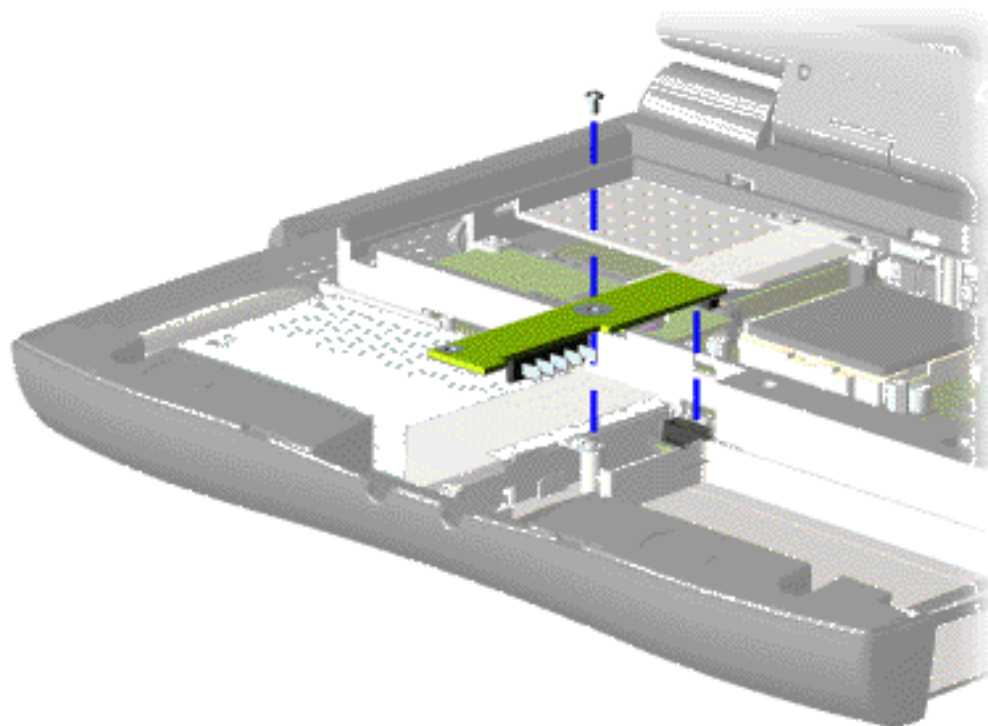

To remove the battery charger board, complete the following steps:

1. Prepare the [computer for disassembly](#).
2. Remove the [palmrest cover with touch pad](#).
3. Remove the [hard drive](#).
4. Remove one screw from the battery charger board, unplug the board from the connector on the system board, and lift the battery charger board out of the chassis.

To replace the battery charger board, reverse the previous procedures.

NOTE:

When replacing the battery charger board, ensure that the pins are aligned with the connector on the system board.

Electrostatic Discharge
Service Considerations
Cables and Connectors
Preparing the Computer for Disassembly
Battery Pack
Palmrest Cover with Touch Pad
Heatsreader
Keyboard
Processor
Hard Drives
CD Drive
Battery Charger Board
Modem
Display Panel Assembly
Upper CPU Cover
Speaker Assembly
Diskette Drive
Fan Assembly
System Board
Dip Switch Settings
Memory Module

maintenance & service guide

Presario 1200 Series

Models: 1255, 1256, 1260, 1262, 1266, 1267, 1272, 1273, 1274, and 1275

Before You Begin	Specifications	Parts Catalog
Removal Sequence	Troubleshooting	Battery Operations
Product Description	Pin Assignments	Index

Removing the Modem

[Electrostatic Discharge](#)

[Service Considerations](#)

[Cables and Connectors](#)

[Preparing the Computer for Disassembly](#)

[Battery Pack](#)

[Palmrest Cover with Touch Pad](#)

[Heatspreader](#)

[Keyboard](#)

[Processor](#)

[Hard Drives](#)

[CD Drive](#)

[Battery Charger Board](#)

Modem

[Display Panel Assembly](#)

[Upper CPU Cover](#)

[Speaker Assembly](#)

[Diskette Drive](#)

[Fan Assembly](#)

[System Board](#)

[Dip Switch Settings](#)

[Memory Module](#)

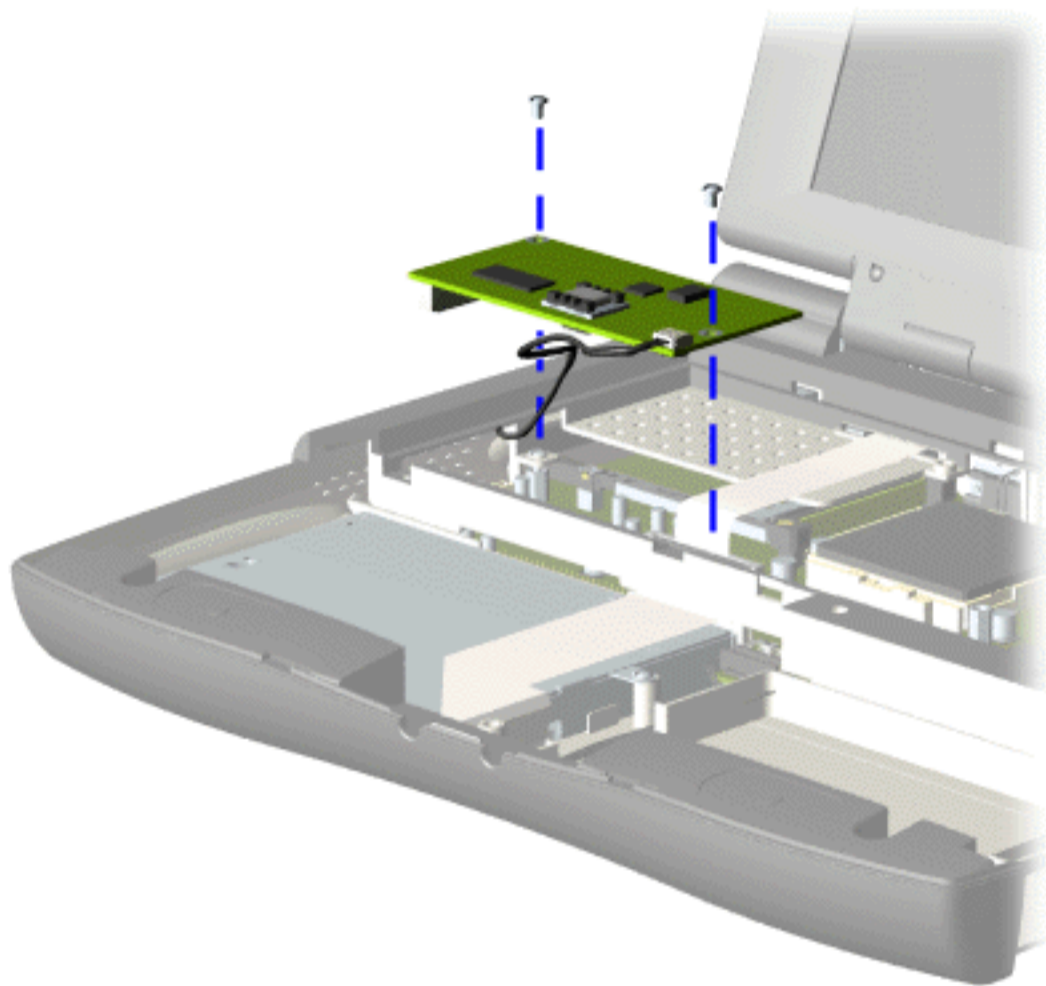

To remove the modem, complete the following steps:

1. Prepare the [computer for disassembly](#).
2. Remove the [palmrest cover with touch pad](#).
3. Remove the [heatspreader](#).
4. Remove the [keyboard](#).
5. Remove two screws securing modem and pull the modem off the connector on the system board.

[Next Step](#)

maintenance & service guide

Presario 1200 Series

Models: 1255, 1256, 1260, 1262, 1266, 1267, 1272, 1273, 1274, and 1275

Before You Begin	Specifications	Parts Catalog
Removal Sequence	Troubleshooting	Battery Operations
Product Description	Pin Assignments	Index

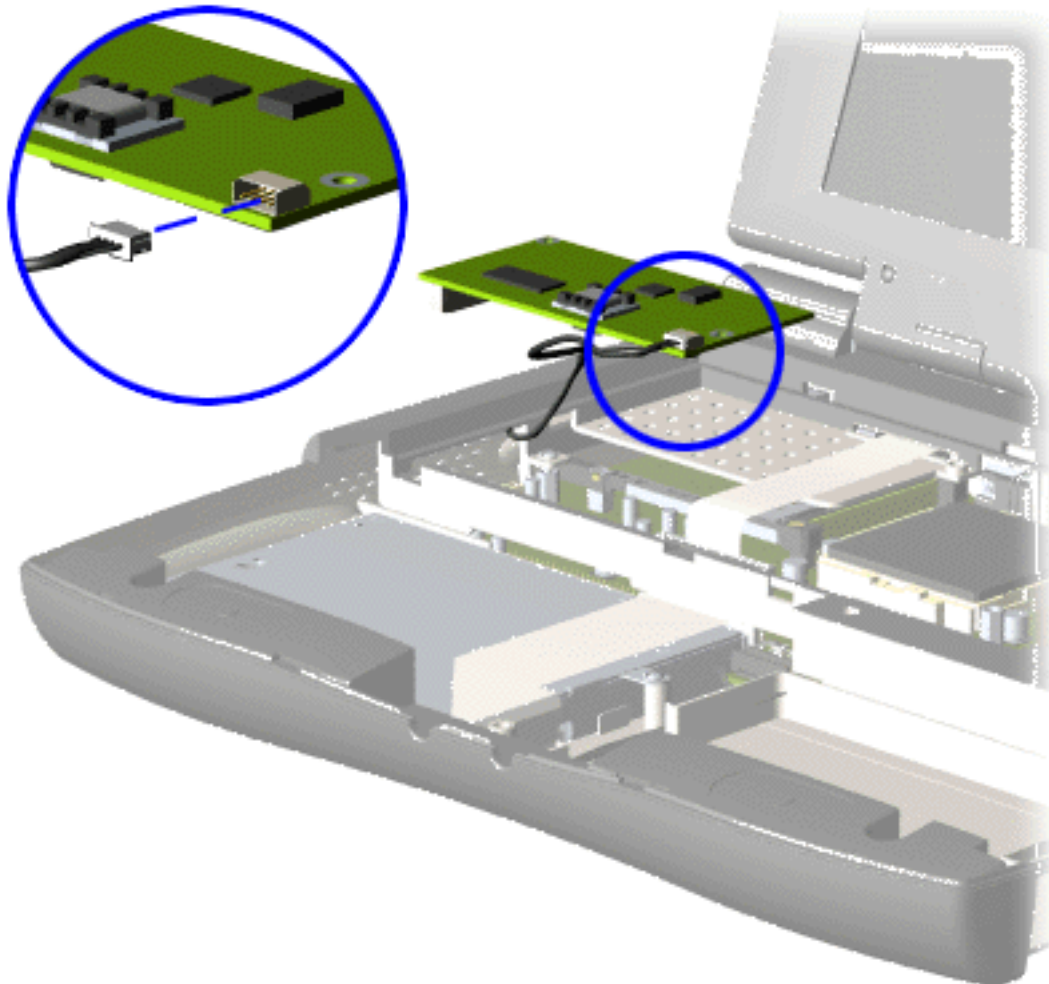

6. Disconnect the modem cable from the modem.

To replace the modem, reverse the previous procedures.

[Return to Removal & Replacement Procedures](#)

maintenance & service guide

Presario 1200 Series

Models: 1255, 1256, 1260, 1262, 1266, 1267, 1272, 1273, 1274, and 1275

Before You Begin	Specifications	Parts Catalog
Removal Sequence	Troubleshooting	Battery Operations
Product Description	Pin Assignments	Index

Removing the Display Panel Assembly

[Electrostatic Discharge](#)

[Service Considerations](#)

[Cables and Connectors](#)

[Preparing the Computer for Disassembly](#)

[Battery Pack](#)

[Palmrest Cover with Touch Pad](#)

[Heatsreader](#)

[Keyboard](#)

[Processor](#)

[Hard Drives](#)

[CD Drive](#)

[Battery Charger Board](#)

[Modem](#)

[Display Panel Assembly](#)

[Upper CPU Cover](#)

[Speaker Assembly](#)

[Diskette Drive](#)

[Fan Assembly](#)

[System Board](#)

[Dip Switch Settings](#)

[Memory Module](#)

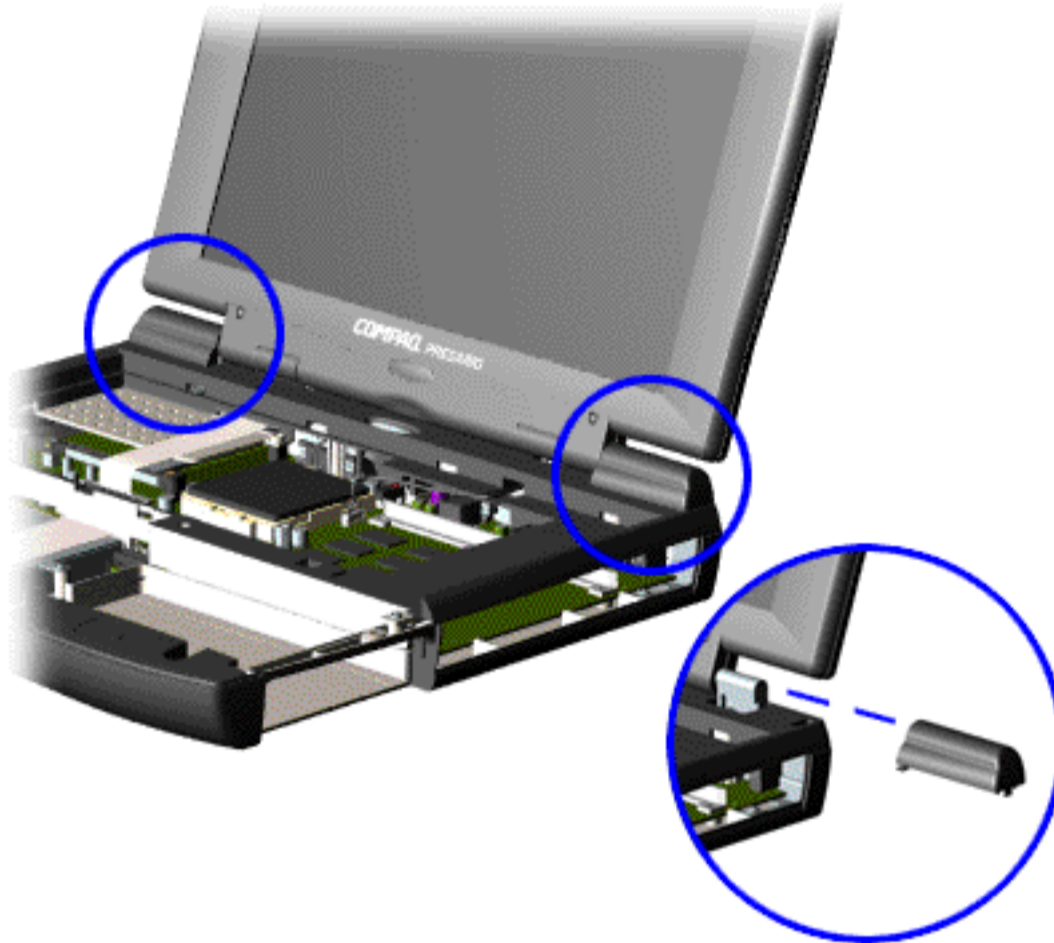

To remove the display panel assembly, complete the following steps:

1. [Prepare the computer for disassembly.](#)

2. Remove the [palmrest cover with touch pad.](#)

3. Remove the [heatsreader.](#)

4. Remove the [keyboard.](#)

5. Remove the [modem.](#)

6. Pull up the hinge covers and lift the covers off the chassis.

IMPORTANT:

Carefully remove the display panel assembly hinge covers.

[Next Step](#)

maintenance & service guide

Presario 1200 Series

Models: 1255, 1256, 1260, 1262, 1266, 1267, 1272, 1273, 1274, and 1275

Before You Begin	Specifications	Parts Catalog
Removal Sequence	Troubleshooting	Battery Operations
Product Description	Pin Assignments	Index

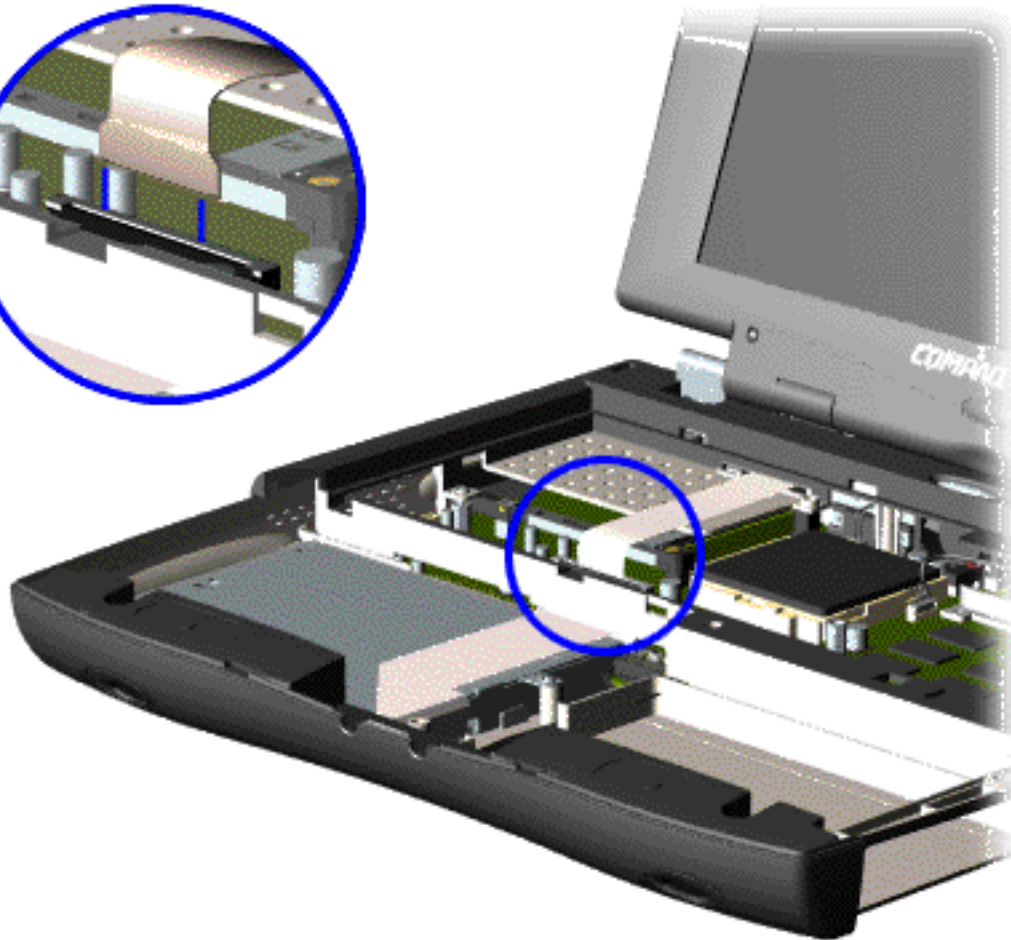
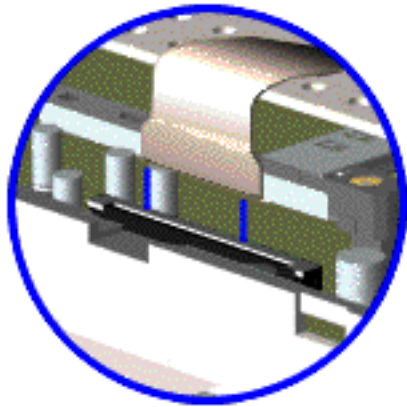

7. Disconnect the flex cable attached to the display panel assembly from the ZIF connector on the system board.

[Next Step](#)

maintenance & service guide

Presario 1200 Series

Models: 1255, 1256, 1260, 1262, 1266, 1267, 1272, 1273, 1274, and 1275

Before You Begin	Specifications	Parts Catalog
Removal Sequence	Troubleshooting	Battery Operations
Product Description	Pin Assignments	Index

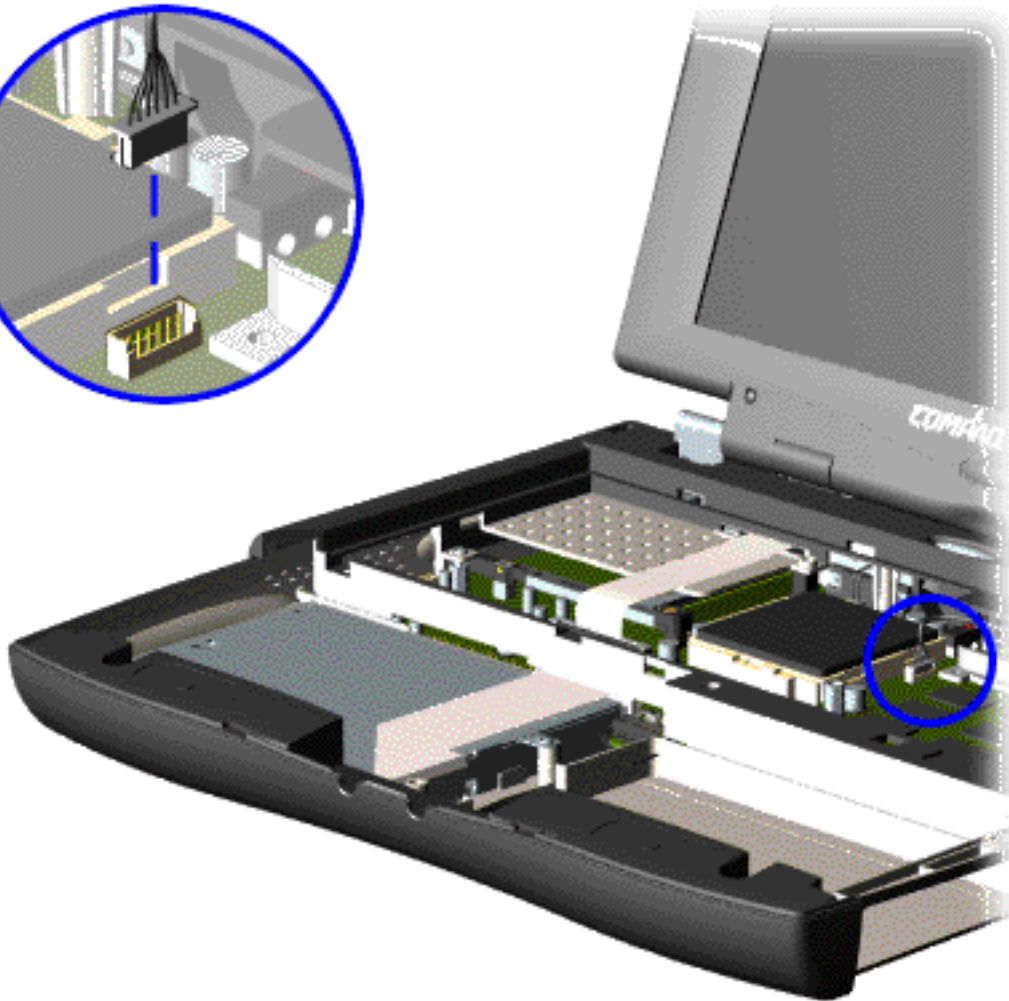
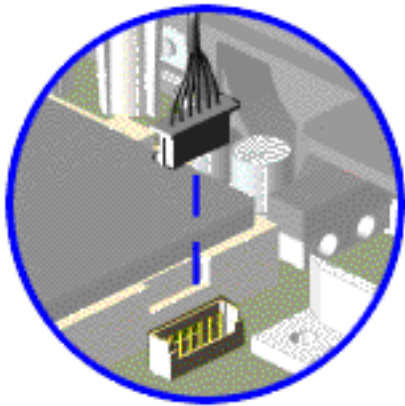

8. Disconnect the backlight cable attached to the display panel assembly from the connector on the system board.

[Next Step](#)

maintenance & service guide

Presario 1200 Series

Models: 1255, 1256, 1260, 1262, 1266, 1267, 1272, 1273, 1274, and 1275

Before You Begin	Specifications	Parts Catalog
Removal Sequence	Troubleshooting	Battery Operations
Product Description	Pin Assignments	Index

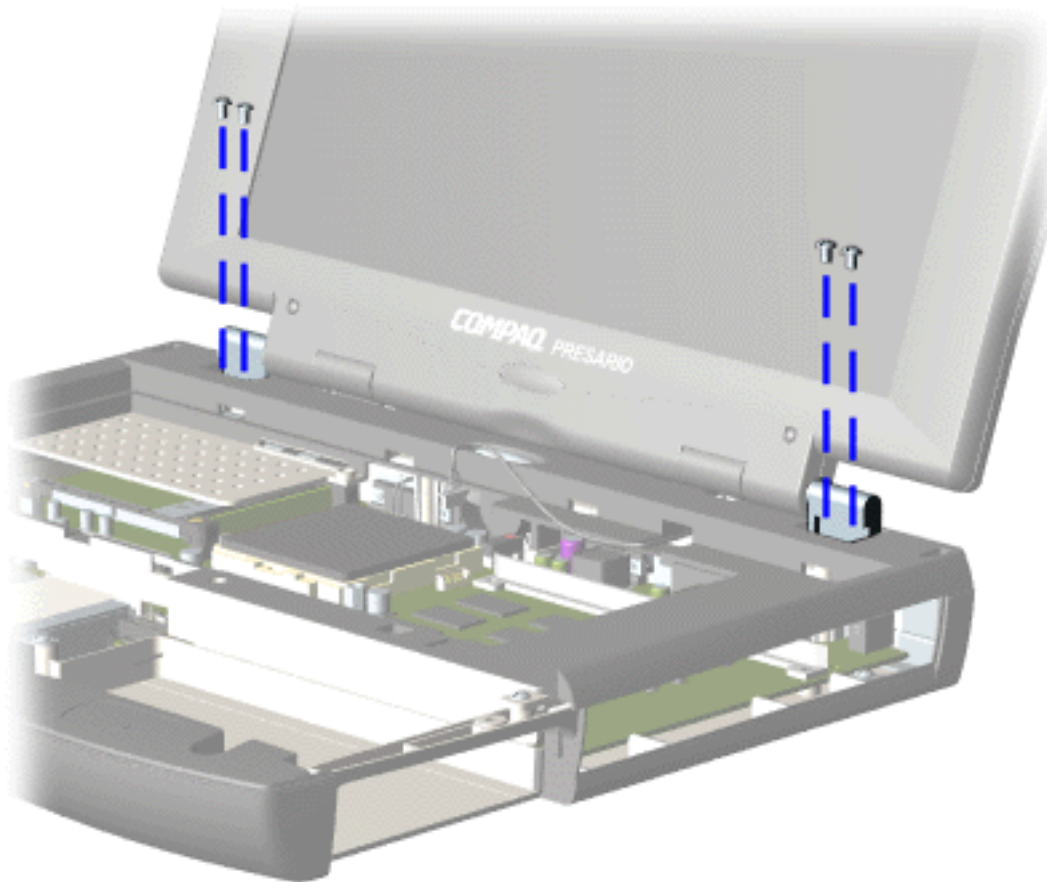

9. Support the back of the display panel assembly and remove two screws from each of the display panel hinges.

[Next Step](#)

maintenance & service guide

Presario 1200 Series

Models: 1255, 1256, 1260, 1262, 1266, 1267, 1272, 1273, 1274, and 1275

Before You Begin	Specifications	Parts Catalog
Removal Sequence	Troubleshooting	Battery Operations
Product Description	Pin Assignments	Index

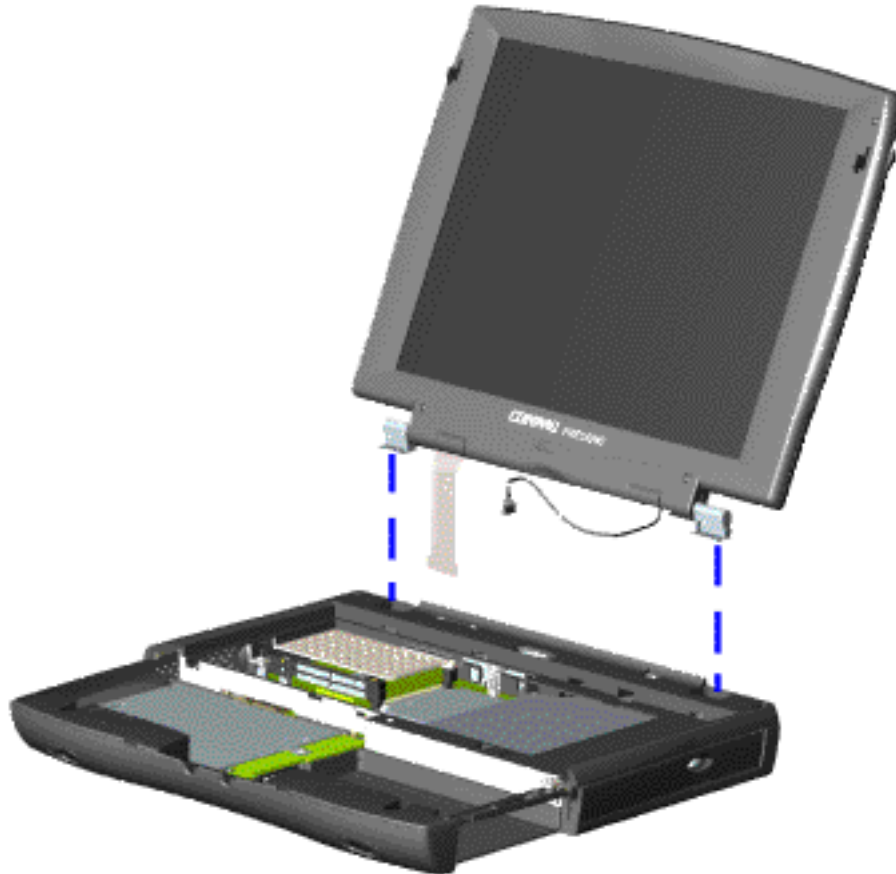

10. Gently pull the flex cable attached to the display panel assembly through the slot on the Upper CPU cover and remove the display panel assembly with flex and backlight cable attached.

To replace the display panel assembly, reverse the previous procedures.

NOTE: When removing the display panel assembly, observe the display panel assembly flex cable routing and position.

Return to [Removal & Replacement Procedures](#)

maintenance & service guide

Presario 1200 Series

Models: 1255, 1256, 1260, 1262, 1266, 1267, 1272, 1273, 1274, and 1275

Before You Begin	Specifications	Parts Catalog
Removal Sequence	Troubleshooting	Battery Operations
Product Description	Pin Assignments	Index

Removing the Upper CPU Cover

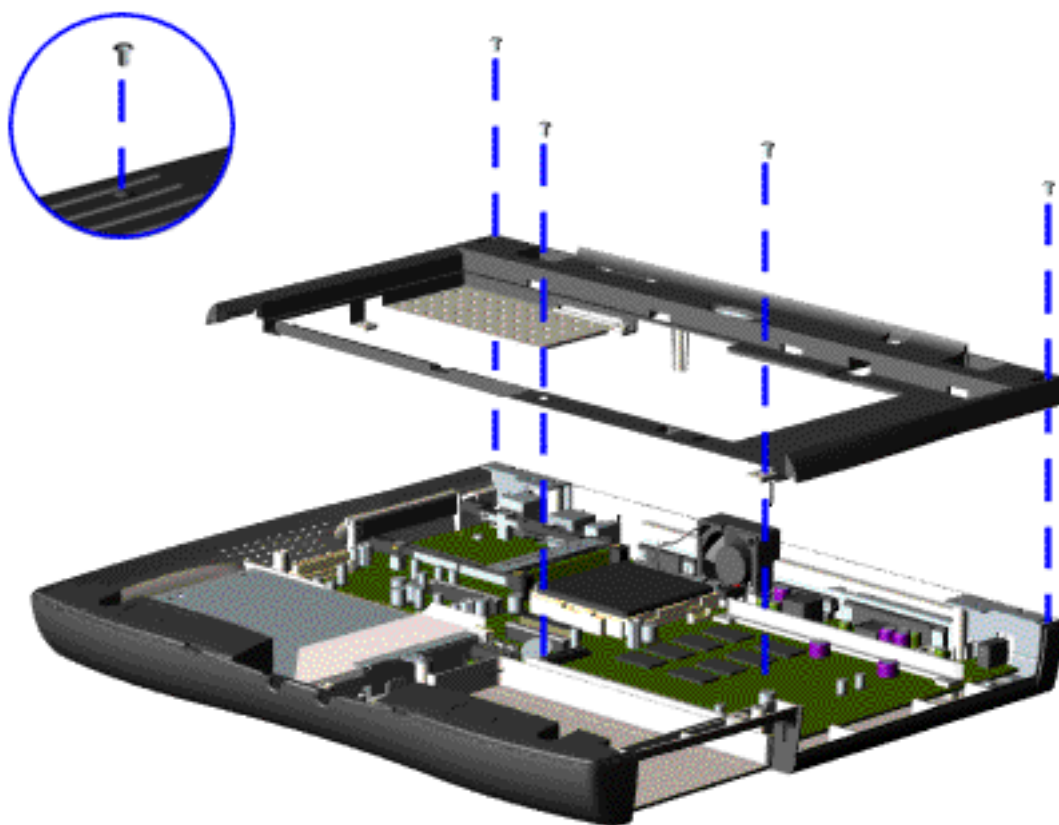

To remove the Upper CPU cover complete the following steps:

1. Prepare the [computer for disassembly](#).
2. Remove the [palmrest cover with touch pad](#).
3. Remove the [heatspreader](#).
4. Remove the [keyboard](#).
5. Remove the [hard drive](#).
6. Remove the [display panel assembly](#).
7. Remove the screw located under the bottom of the unit (rear) which secures the Upper CPU cover to the chassis and remove four screws located on the top.
8. Lift the Upper CPU cover off the snaps on the chassis. This disconnects the power switch from the connector on the system board.

To replace the Upper CPU cover, reverse the previous procedures.

[Electrostatic Discharge](#)

[Service Considerations](#)

[Cables and Connectors](#)

[Preparing the Computer for Disassembly](#)

[Battery Pack](#)

[Palmrest Cover with Touch Pad](#)

[Heatspreader](#)

[Keyboard](#)

[Processor](#)

[Hard Drives](#)

[CD Drive](#)

[Battery Charger Board](#)

[Modem](#)

[Display Panel Assembly](#)

[Upper CPU Cover](#)

[Speaker Assembly](#)

[Diskette Drive](#)

[Fan Assembly](#)

[System Board](#)

[Dip Switch Settings](#)

[Memory Module](#)

maintenance & service guide

Presario 1200 Series

Models: 1255, 1256, 1260, 1262, 1266, 1267, 1272, 1273, 1274, and 1275

Before You Begin	Specifications	Parts Catalog
Removal Sequence	Troubleshooting	Battery Operations
Product Description	Pin Assignments	Index

Removing the Speaker Assembly

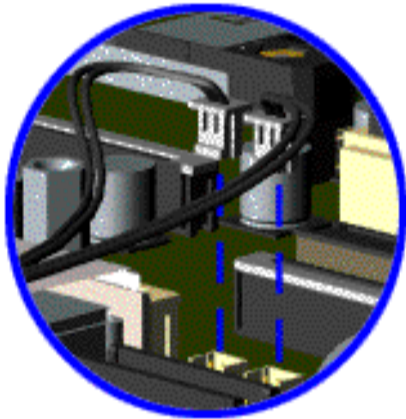
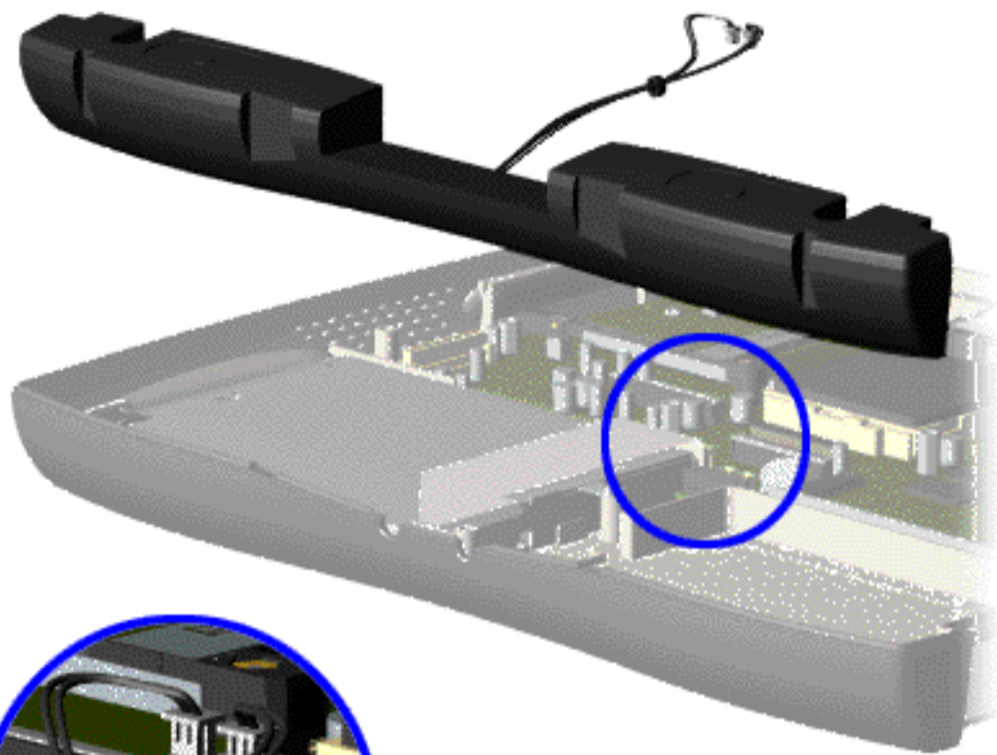

To remove the speaker assembly, complete the following steps:

1. Prepare the [computer for disassembly](#).
2. Remove the [palmrest cover with touch pad](#).
3. Remove the [heatspreader](#).
4. Remove the [keyboard](#).
5. Remove the [hard drive](#).
6. Remove the [display panel assembly](#).
7. Remove the [Upper CPU cover](#).
8. Remove the [battery charger board](#).
9. Disconnect the speaker cables from the system board and remove the speaker assembly from the chassis.

To replace the speaker assembly, reverse the previous procedures.

[Electrostatic Discharge](#)

[Service Considerations](#)

[Cables and Connectors](#)

[Preparing the Computer for Disassembly](#)

[Battery Pack](#)

[Palmrest Cover with Touch Pad](#)

[Heatspreader](#)

[Keyboard](#)

[Processor](#)

[Hard Drives](#)

[CD Drive](#)

[Battery Charger Board](#)

[Modem](#)

[Display Panel Assembly](#)

[Upper CPU Cover](#)

[Speaker Assembly](#)

[Diskette Drive](#)

[Fan Assembly](#)

[System Board](#)

[Dip Switch Settings](#)

[Memory Module](#)

maintenance & service guide

Presario 1200 Series

Models: 1255, 1256, 1260, 1262, 1266, 1267, 1272, 1273, 1274, and 1275

Before You Begin	Specifications	Parts Catalog
Removal Sequence	Troubleshooting	Battery Operations
Product Description	Pin Assignments	Index

Removing the Diskette Drive

[Electrostatic Discharge](#)

[Service Consideration](#)

[Cables and Connectors](#)

[Preparing the Computer for Disassembly](#)

[Battery Pack](#)

[Palmrest Cover with Touch Pad](#)

[Heatspreader](#)

[Keyboard](#)

[Processor](#)

[Hard Drives](#)

[CD Drive](#)

[Battery Charger Board](#)

[Modem](#)

[Display Panel Assembly](#)

[Upper CPU Cover](#)

[Speaker Assembly](#)

Diskette Drive

[Fan Assembly](#)

[System Board](#)

[Dip Switch Settings](#)

[Memory Module](#)

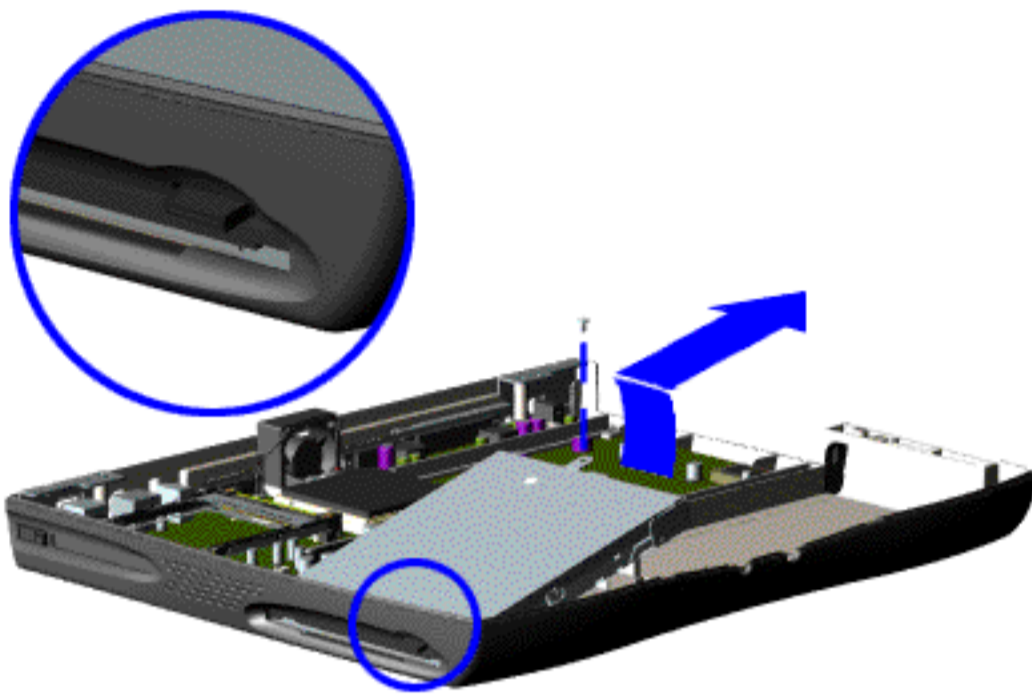

To remove the diskette drive, complete the following steps:

1. [Prepare the computer for disassembly.](#)
2. [Remove the palmrest cover with touch pad.](#)
3. [Remove the heatspreader.](#)
4. [Remove the keyboard.](#)
5. [Remove the hard drive.](#)
6. [Remove the display panel assembly.](#)
7. [Remove the Upper CPU cover.](#)
8. [Remove battery charger board.](#)
9. [Remove the diskette drive.](#)

[Next Step](#)

NOTE:

When replacing the diskette drive, ensure that the diskette drive eject lever is properly inserted in the chassis slot.

maintenance & service guide

Presario 1200 Series

Models: 1255, 1256, 1260, 1262, 1266, 1267, 1272, 1273, 1274, and 1275

Before You Begin	Specifications	Parts Catalog
Removal Sequence	Troubleshooting	Battery Operations
Product Description	Pin Assignments	Index

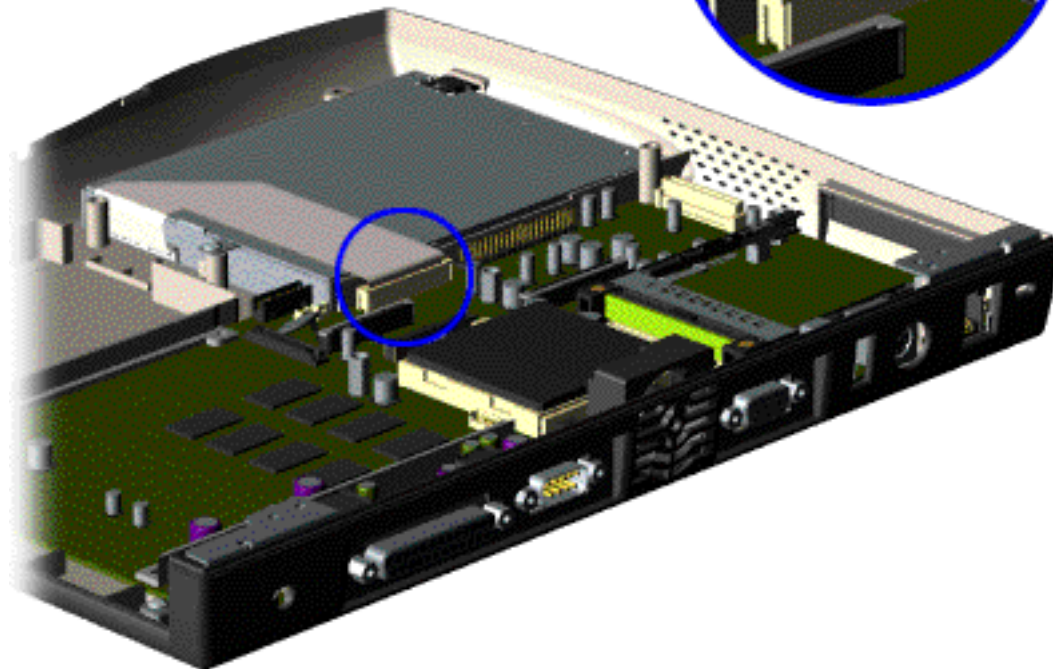

10. Disconnect the diskette drive data cable from the system board.

To replace the diskette drive, reverse the previous procedures.

[Return to Removal & Replacement Procedures](#)

maintenance & service guide

Presario 1200 Series

Models: 1255, 1256, 1260, 1262, 1266, 1267, 1272, 1273, 1274, and 1275

Before You Begin	Specifications	Parts Catalog
Removal Sequence	Troubleshooting	Battery Operations
Product Description	Pin Assignments	Index

Removing the Fan Assembly

[Electrostatic Discharge](#)

[Service Considerations](#)

[Cables and Connectors](#)

[Preparing the Computer for Disassembly](#)

[Battery Pack](#)

[Palmrest Cover with Touch Pad](#)

[Heatspreader](#)

[Keyboard](#)

[Processor](#)

[Hard Drives](#)

[CD Drive](#)

[Battery Charger Board](#)

[Modem](#)

[Display Panel Assembly](#)

[Upper CPU Cover](#)

[Speaker Assembly](#)

[Diskette Drive](#)

[Fan Assembly](#)

[System Board](#)

[Dip Switch Settings](#)

[Memory Module](#)

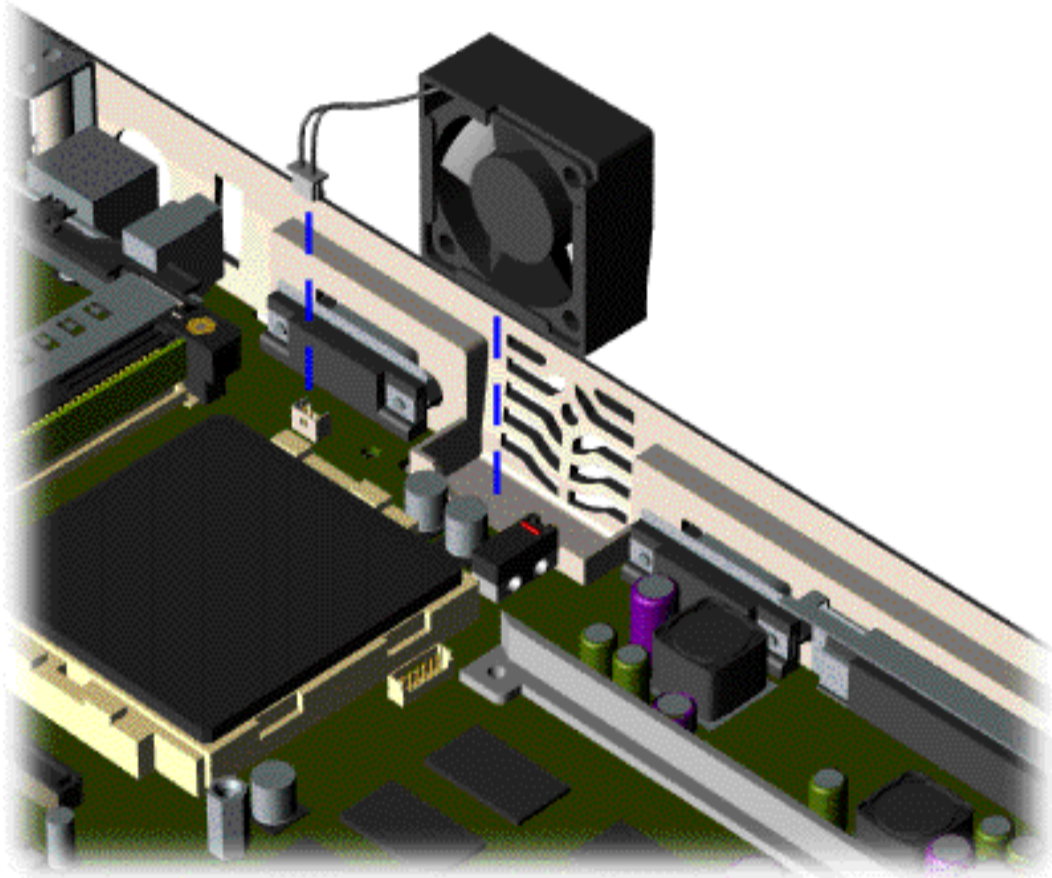

To remove the fan assembly, complete the following steps:

1. Prepare the [computer for disassembly](#).

2. Remove the [palmrest cover with touch pad](#).

3. Remove the [heatspreader](#).

4. Remove the [keyboard](#).

5. Remove the [display panel assembly](#).

6. Remove the [hard drive](#).

7. Remove the [Upper CPU cover](#).

8. Lift the fan assembly from the chassis slot and disconnect the fan cable from the connector on the system board.

[Next Step](#)

maintenance & service guide

Presario 1200 Series

Models: 1255, 1256, 1260, 1262, 1266, 1267, 1272, 1273, 1274, and 1275

Before You Begin	Specifications	Parts Catalog
Removal Sequence	Troubleshooting	Battery Operations
Product Description	Pin Assignments	Index

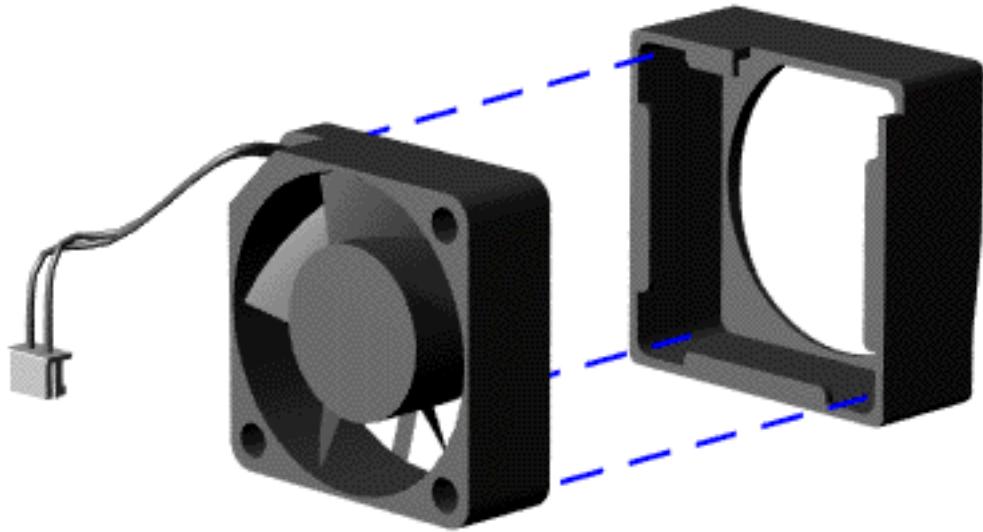

To remove the fan gasket, complete the following step:

Pull the gasket from the fan.

To replace the fan assembly, reverse the previous procedure.

NOTE:

When replacing the fan, ensure that the fan is blowing into the computer. (The vendor label on the fan should be facing in, toward the processor).

NOTE:

To replace the fan with gasket attached, place the fan assembly at a 15° angle and push forward.

[Return to **Removal & Replacement Procedures**](#)

maintenance & service guide

Presario 1200 Series

Models: 1255, 1256, 1260, 1262, 1266, 1267, 1272, 1273, 1274, and 1275

Before You Begin	Specifications	Parts Catalog
Removal Sequence	Troubleshooting	Battery Operations
Product Description	Pin Assignments	Index

Removing the System Board

[Electrostatic Discharge](#)

[Service Considerations](#)

[Cables and Connectors](#)

[Preparing the Computer for Disassembly](#)

[Battery Pack](#)

[Palmrest Cover with Touch Pad](#)

[Heatspreader](#)

[Keyboard](#)

[Processor](#)

[Hard Drives](#)

[CD Drive](#)

[Battery Charger Board](#)

[Modem](#)

[Display Panel Assembly](#)

[Upper CPU Cover](#)

[Speaker Assembly](#)

[Diskette Drive](#)

[Fan Assembly](#)

[System Board](#)

[Dip Switch Settings](#)

[Memory Module](#)

To remove the system board, complete the following steps:

1. Prepare the [computer for disassembly](#).
2. Remove the [palmrest cover with touch pad](#).
3. Remove the [heatspreader](#).
4. Remove the [keyboard](#).
5. Remove the [processor](#).
6. Remove the [modem](#).
7. Remove the [hard drive](#).
8. Remove the [display panel assembly](#).
9. Remove the [Upper CPU Cover](#).
10. Remove the [battery charger board](#).
11. Remove the [diskette drive](#).
12. Remove the [CD drive](#).
13. Remove the [fan](#).
14. Disconnect the [speaker assembly](#) cables.

[Next Step](#)

maintenance & service guide

Presario 1200 Series

Models: 1255, 1256, 1260, 1262, 1266, 1267, 1272, 1273, 1274, and 1275

Before You Begin	Specifications	Parts Catalog
Removal Sequence	Troubleshooting	Battery Operations
Product Description	Pin Assignments	Index

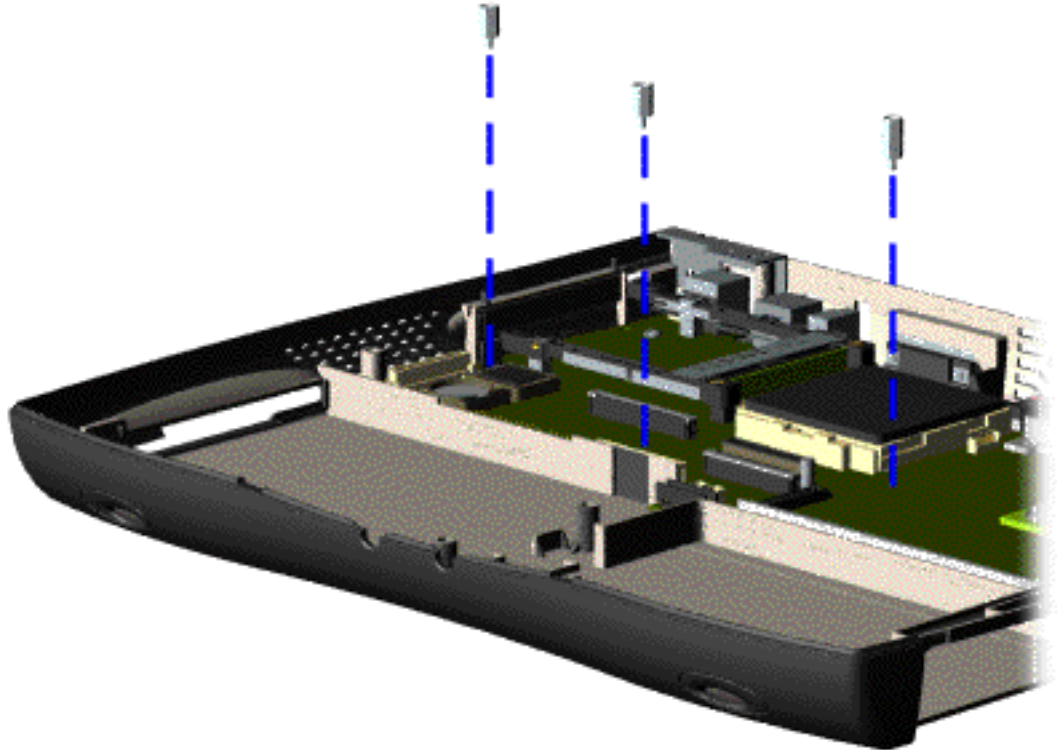

15. Remove three standoffs from the system board.

[Next Step](#)

maintenance & service guide

Presario 1200 Series

Models: 1255, 1256, 1260, 1262, 1266, 1267, 1272, 1273, 1274, and 1275

Before You Begin	Specifications	Parts Catalog
Removal Sequence	Troubleshooting	Battery Operations
Product Description	Pin Assignments	Index

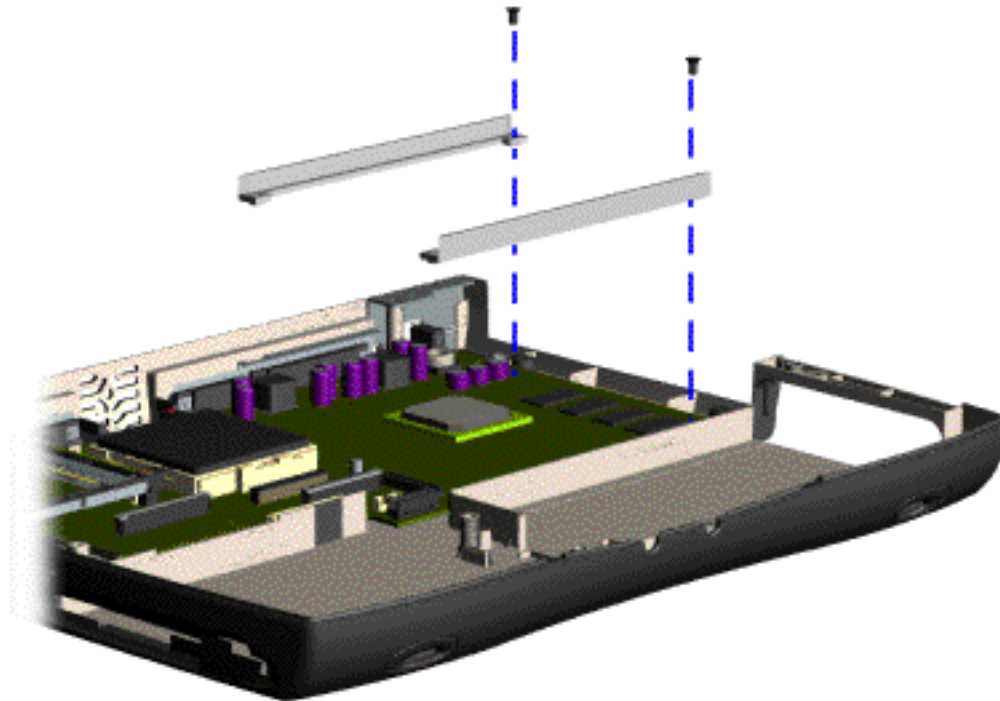

16. Remove two screws from the CD Drive mounting rails and remove the mounting rails from the system board.

[Next Step](#)

maintenance & service guide

Presario 1200 Series

Models: 1255, 1256, 1260, 1262, 1266, 1267, 1272, 1273, 1274, and 1275

<u>Before You Begin</u>	<u>Specifications</u>	<u>Parts Catalog</u>
<u>Removal Sequence</u>	<u>Troubleshooting</u>	<u>Battery Operations</u>
<u>Product Description</u>	<u>Pin Assignments</u>	<u>Index</u>

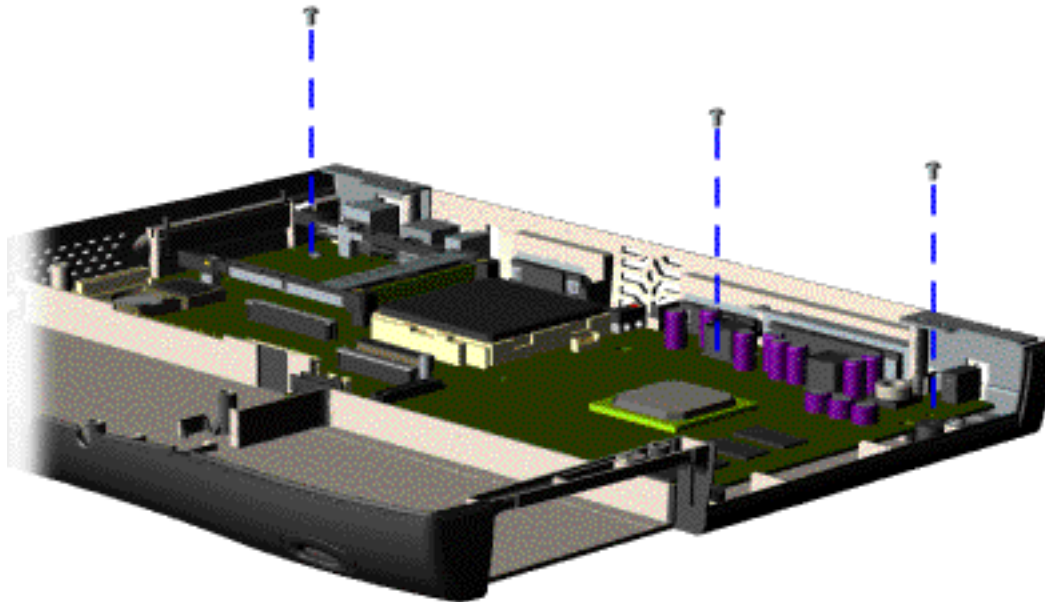

17. Remove three screws from the system board.

[Next Step](#)

maintenance & service guide

Presario 1200 Series

Models: 1255, 1256, 1260, 1262, 1266, 1267, 1272, 1273, 1274, and 1275

Before You Begin	Specifications	Parts Catalog
Removal Sequence	Troubleshooting	Battery Operations
Product Description	Pin Assignments	Index

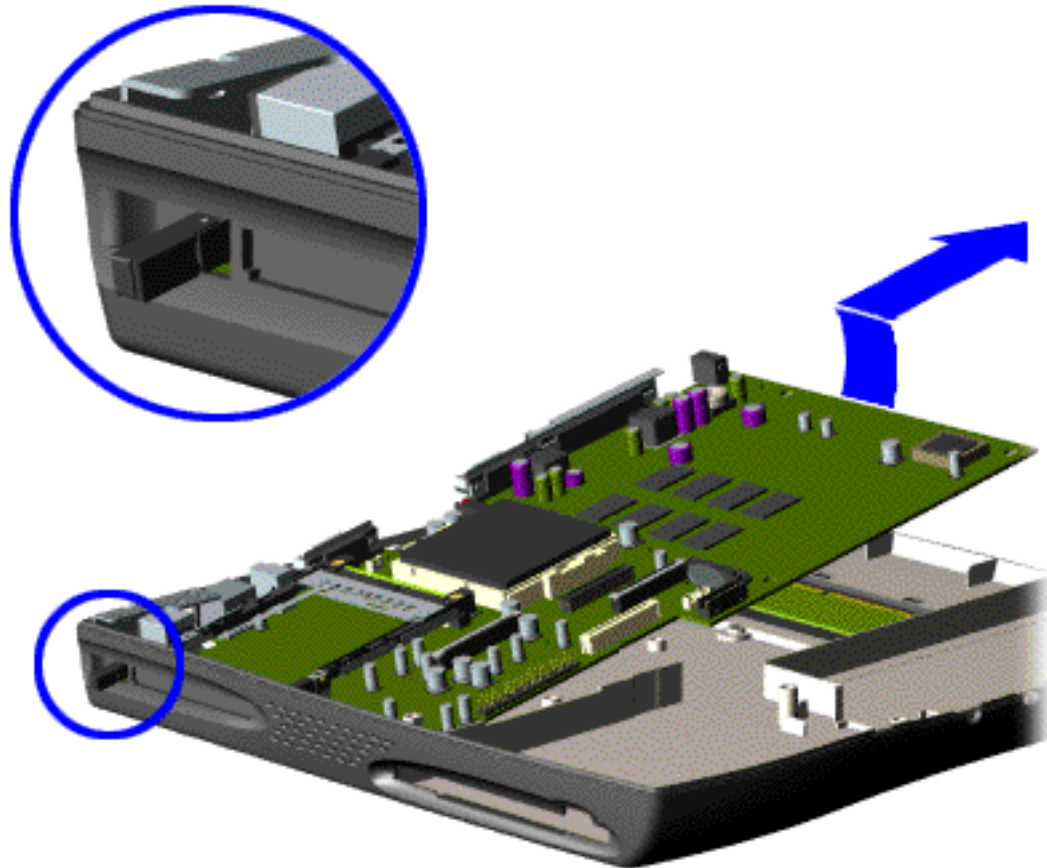

18. Pull the PCMCIA eject lever out (straight), lift up the right side of the system board and pull forward to remove the system board from the chassis.

To replace the system board, reverse the previous procedures.

IMPORTANT: Remove all cables from the system board.

[Dip Switch System Board Settings](#)

[Return to **Removal & Replacement Procedures**](#)

maintenance & service guide

Presario 1200 Series

Models: 1255, 1256, 1260, 1262, 1266, 1267, 1272, 1273, 1274, and 1275

Before You Begin	Specifications	Parts Catalog
Removal Sequence	Troubleshooting	Battery Operations
Product Description	Pin Assignments	Index

Removing the Memory Module

[Electrostatic Discharge](#)

[Service Considerations](#)

[Cables and Connectors](#)

[Preparing the Computer for Disassembly](#)

[Battery Pack](#)

[Palmrest Cover with Touch Pad](#)

[Heatspreader](#)

[Keyboard](#)

[Processor](#)

[Hard Drives](#)

[CD Drive](#)

[Battery Charger Board](#)

[Modem](#)

[Display Panel Assembly](#)

[Upper CPU Cover](#)

[Speaker Assembly](#)

[Diskette Drive](#)

[Fan Assembly](#)

[System Board](#)

[Dip Switch Settings](#)

[Memory Module](#)

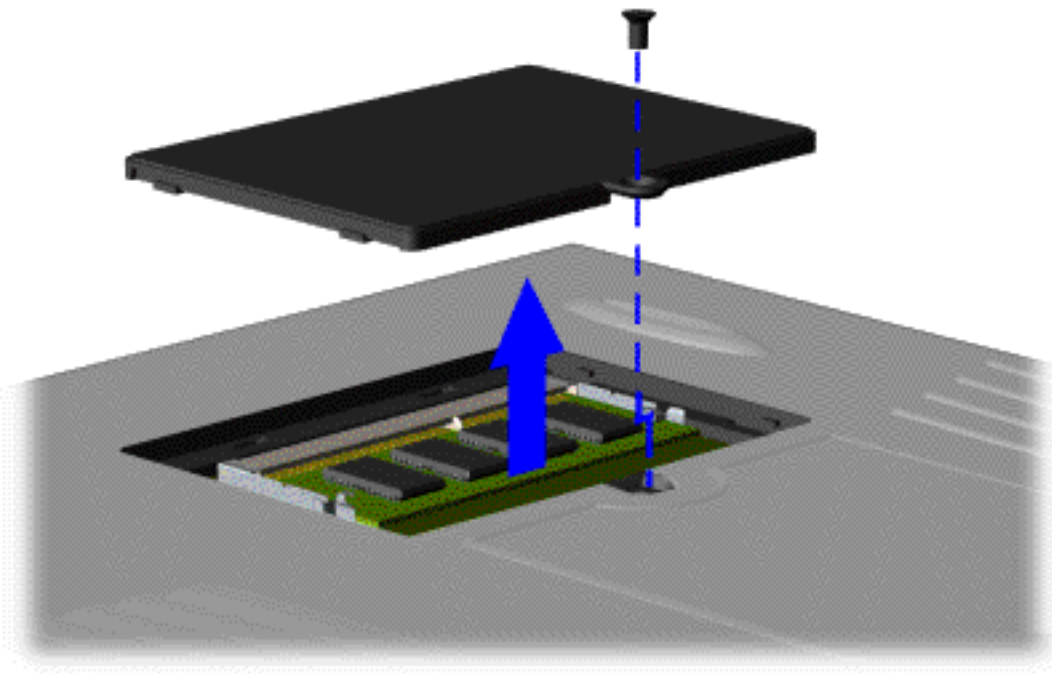

To remove the memory module, complete the following steps:

1. Prepare the [computer for disassembly](#).

2. Close the computer and turn the computer upside down.

3. Remove the screw from the memory module door, and slide the memory module door to the right.

[Next Step](#)

maintenance & service guide

Presario 1200 Series

Models: 1255, 1256, 1260, 1262, 1266, 1267, 1272, 1273, 1274, and 1275

<u>Before You Begin</u>	<u>Specifications</u>	<u>Parts Catalog</u>
<u>Removal Sequence</u>	<u>Troubleshooting</u>	<u>Battery Operations</u>
<u>Product Description</u>	<u>Pin Assignments</u>	<u>Index</u>

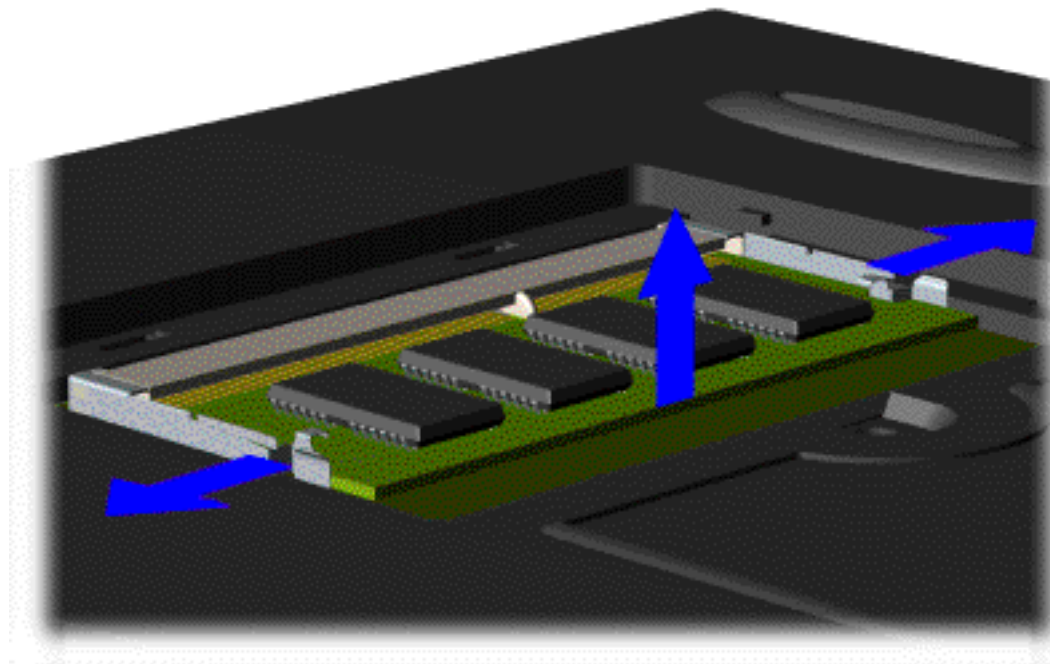

4. Pull side levers to release the memory module and unplug the memory module from the system board.

To replace the memory module, reverse the previous procedures.

[Return to Removal & Replacement Procedures](#)

maintenance & service guide

Presario 1200 Series

Models: 1255, 1256, 1260, 1262, 1266, 1267, 1272, 1273, 1274, and 1275

Before You Begin	Specifications	Parts Catalog
Removal Sequence	Troubleshooting	Battery Operations
Product Description	Pin Assignments	Index

Specifications

This chapter covers the following specifications of Compaq Presario 1200 Series Portable Computers:

[System interrupts](#)

[Memory Expansion](#)

[System DMA](#)

[Battery Pack](#)

[System I/O Address](#)

[Diskette Drive](#)

[System memory Catalog](#)

[Hard Drive](#)

[Physical & environmental](#)

[CD Drive](#)

[Display](#)

Physical and Environmental

Computer Specifications		
	U.S.	Metric
Dimensions (All models with 12.1" display) Height Depth Width	1.97 in 12.20 in 10.08 in	4.95 cm 31.00 cm 25.60 cm
(Model 1275 with 13.0" display) Height Depth Width	1.97 in 12.33 in 10.08 in	5.00 cm 31.30 cm 25.60 cm
Weight Model 1255 Model 1256 Model 1260 Model 1262 Model 1266 Model 1267 Model 1272 Model 1273 Model 1274 Model 1275	6.68 lb 6.68 lb 6.68 lb 6.68 lb 6.68 lb 6.68 lb 6.68 lb 6.68 lb 6.68 lb 6.68 lb	3.34 kg 3.34 kg 3.34 kg 3.34 kg 3.34 kg 3.34 kg 3.34 kg 3.34 kg 3.34 kg 3.34 kg
Stand-Alone (Battery Pack) Power Requirements Nominal Operating Maximum Average Peak Operating	NiMH W @ 9.6 V W @ 9.6 V W @ 9.6 V	Li-ion W @ 14.8 V W @ 14.8 V W @ 14.8 V
AC Power Requirements Operating Voltage Operating Current Operating Frequency Maximum Transient	100-240 V 0.8/0.4 A RMS 47-63 Hz Meets IEC 801-4 and IEC801-5 1kV for 50 ns	
Operating Temperature	50° to 95 °F	10° to 35 °C
Non-operating Temperature	-4° to 140 °F	-20° to 60 °C
Operating Relative Humidity (non-condensing)	10 to 90%	35°C to 90%
Non-operating Relative Humidity (tw = 38.7°C max)	5 to 95%	60°C to 95%
Operating Altitude	0 to 10,000 ft	0 to 3.15 km
Non-operating Altitude	0 to 30,000 ft	0 to 9.14 km
Operating Shock	10 G, 11 ms, half sine	
Non operating Shock	240 G, 2 ms, half sine	
Operating Vibration	0.5 G	
Non-operating Vibration	1.5 G	

NOTE: Applicable product safety standards specify thermal limits for plastic surfaces. Compaq Presario 1200 Series Portable Computers operate well within this range of temperatures.

Return to the [Top](#) of this page.

maintenance & service guide

Presario 1200 Series

Models: 1255, 1256, 1260, 1262, 1266, 1267, 1272, 1273, 1274, and 1275

Before You Begin	Specifications	Parts Catalog
Removal Sequence	Troubleshooting	Battery Operations
Product Description	Pin Assignments	Index

Specifications

System Interrupts

System Interrupts	
Hardware IRQ	System Function
IRQ00	Timer Interrupt
IRQ01	Standard 101/102-Key or Microsoft Natural Keyboard
IRQ02	Programmable interrupt controller
IRQ03	Compaq Presario 56K-DF
IRQ04	Communications Port (COM1)
IRQ05	ES1869 Plug and Play AudioDrive
IRQ06	Standard Floppy Disk Controller
IRQ07	Printer Port (LPT1)
IRQ08	System CMOS/real time clock
IRQ09	(free)
IRQ10	OPTi 82C861 PCI to USB Open Host Controller
IRQ11	IRQ Holder for PCI Steering
IRQ11	NeoMagic MagicGraph 128XD
IRQ12	Synaptics PS/2 TouchPad
IRQ13	Numeric data processor
IRQ14	Primary IDE controller (dual fifo)
IRQ14	Opti Viper Max Dual PCI IDE Controller
IRQ15	Secondary IDE controller (dual fifo)
IRQ15	Opti Viper Max Dual PCI IDE Controller

Return to the index list of [Specifications](#).

maintenance & service guide

Presario 1200 Series

Models: 1255, 1256, 1260, 1262, 1266, 1267, 1272, 1273, 1274, and 1275

Before You Begin	Specifications	Parts Catalog
Removal Sequence	Troubleshooting	Battery Operations
Product Description	Pin Assignments	Index

Specifications

System DMA

System DMA	
Hardware DMA	System Function
0	ES1869 Plug and Play AudioDrive
1	ES1869 Plug and Play AudioDrive
2	Standard Floppy Disk Controller
3	(free)
4	Direct memory access controller
5	(free)
6	(free)
7	(free)

Return to the index list of [Specifications](#).

maintenance & service guide

Presario 1200 Series

Models: 1255, 1256, 1260, 1262, 1266, 1267, 1272, 1273, 1274, and 1275

Before You Begin	Specifications	Parts Catalog
Removal Sequence	Troubleshooting	Battery Operations
Product Description	Pin Assignments	Index

Specifications

System I/O Address

System I/O Address	
I/O Address (Hex)	System Function (Shipping Configuration)
0000H - 000FH	Direct memory access controller
0020H - 0021H	Programmable interrupt controller
0022H - 0024H	Motherboard resources
0040H - 0043H	System timer
0060H - 0060H	Standard 101/102-Key or Microsoft Natural Keyboard
0061H - 0061H	System speaker
0064H - 0064H	Standard 101/102-Key or Microsoft Natural Keyboard
0070H - 0071H	System CMOS/real time clock
0080H - 0080H	Motherboard resources
0081H - 008FH	Direct memory access controller
0092H - 0092H	Motherboard resources
00A0H - 00A1H	Programmable interrupt controller
00C0H - 00DFH	Direct memory access controller
00ECH - 00EFH	Motherboard resources
00F0H - 00FFH	Numeric data processor
0170H - 0177H	Opti Viper Max Dual PCI IDE Controller
0170H - 0177H	Secondary IDE controller (dual fifo)
01F0H - 01F7H	Opti Viper Max Dual PCI IDE Controller
01F0H - 01F7H	Primary IDE controller (dual fifo)
0220H - 022FH	ES1869 Plug and Play AudioDrive
02F8H - 02FFH	Compaq Presario 56K-DF
0330H - 0331H	ES1869 Plug and Play AudioDrive
0370H - 0371H	Motherboard resources
0376H - 0376H	Opti Viper Max Dual PCI IDE Controller
0376H - 0376H	Secondary IDE controller (dual fifo)
0378H - 037FH	Printer Port (LPT1)
0388H - 038BH	ES1869 Plug and Play AudioDrive
03B0H - 03BBH	NeoMagic MagicGraph 128XD
03C0H - 03DFH	NeoMagic MagicGraph 128XD
03F0H - 03F5H	Standard Floppy Disk Controller
03F6H - 03F6H	Opti Viper Max Dual PCI IDE Controller
03F6H - 03F6H	Primary IDE controller (dual fifo)
03F7H - 03F7H	Standard Floppy Disk Controller
03F8H - 03FFH	Communications Port (COM1)
040BH - 040BH	Motherboard resources
0480H - 048FH	Motherboard resources
04D6H - 04D6H	Motherboard resources
0800H - 0807H	ES1869 Control Interface
0CF8H - 0CFFH	PCI bus
FCF0H - FCF7H	Primary IDE Controller (dual fifo)
FCF0H - FCFFH	Opti Viper Max Dual PCI IDE Controller
FCF8H - FCFFH	Secondary IDE Controller (dual fifo)

[Return to the index list of Specifications.](#)

maintenance & service guide

Presario 1200 Series

Models: 1255, 1256, 1260, 1262, 1266, 1267, 1272, 1273, 1274, and 1275

Before You Begin	Specifications	Parts Catalog
Removal Sequence	Troubleshooting	Battery Operations
Product Description	Pin Assignments	Index

Specifications

System Memory Catalog

System Memory Catalog	
Memory Address	System Function
00000000H - 00000000H	Texas Instruments PCI-1131 Card Bus Controller
00000000H - 0009FFFFH	System board extension for PnP BIOS
000A0000H - 000AFFFFH	NeoMagic MagicGraph 128XD
000B0000H - 000BFFFFH	NeoMagic MagicGraph 128XD
000C0000H - 000CBFFFFH	NeoMagic MagicGraph 128XD
000E0000H - 000FFFFFH	System board extension for PnP BIOS
00100000H - 01FFFFFFH	System board extension for PnP BIOS
FD000000H - FFFFFFFFH	NeoMagic MagicGraph 128XD
FEA00000H - FEBFFFFFFH	NeoMagic MagicGraph 128XD
FECFF000H - FECFFFFFFH	OPTi 82C861 PCI to USB Open Host Controller
FED00000H - FEDFFFFFFH	NeoMagic MagicGraph 128XD
FFFC0000H - FFFFFFFFH	Motherboard resources

Return to the index list of [Specifications](#).

maintenance & service guide

Presario 1200 Series

Models: 1255, 1256, 1260, 1262, 1266, 1267, 1272, 1273, 1274, and 1275

Before You Begin	Specifications	Parts Catalog
Removal Sequence	Troubleshooting	Battery Operations
Product Description	Pin Assignments	Index

Specifications

Display

12.1" (Diagonal) TFT Display		
	U.S.	Metric
Active Area Height Width	9.6" 7.2"	246 mm 184.5 mm
Overall Dimensions Width Height Depth	7.35" 10.7" .27"	188.5 mm 275 mm 6.8 mm
Weight	16.24 oz.	464 g
Contrast Ratio	40:1	40:1
Brightness	70 nits. Avg.	70 nits. Avg.
Total Power Consumption	3.5 - 4.0 W (max)	3.5 - 4.0 W (max)

12.1" (Diagonal) HPA Display		
	U.S.	Metric
Active Area Height Width	9.56" 7.17"	245 mm 183.8 mm
Overall Dimensions Width Height Depth	7.9" 10.7" .31"	202.5 mm 275.0 mm 8.0 mm
Weight	18.2 oz.	520 g
Contrast Ratio	40:1	40:1
Brightness	70 nits. Avg.	70 nits. Avg.
Total Power Consumption	4.0 - 4.5 W (max)	4.0 - 4.5 W (max)

13.0" (Diagonal) HPA Display		
	U.S.	Metric
Active Area Height Width	10.39" 7.79"	263.98 mm 197.98 mm
Overall Dimensions Width Height Depth	11.6" 8.58" .31"	295.0 mm 218.0 mm 8.0 mm
Weight	20.3 oz.	580 g
Contrast Ratio	50:1	50:1
Brightness	100 nits. Avg.	100 nits. Avg.
Total Power Consumption	5 W (max)	5 W (max)

Return to the index list of [Specifications](#).

maintenance & service guide

Presario 1200 Series

Models: 1255, 1256, 1260, 1262, 1266, 1267, 1272, 1273, 1274, and 1275

Before You Begin	Specifications	Parts Catalog
Removal Sequence	Troubleshooting	Battery Operations
Product Description	Pin Assignments	Index

Specifications

Memory Expansion

Memory Expansion		
System Memory	Expansion Board Memory	Total Memory
32-MB	16-MB	48-MB
32-MB	32-MB	64-MB
32-MB	64-MB	96-MB
32-MB	128-MB	160-MB

Return to the index list of [Specifications](#).

maintenance & service guide

Presario 1200 Series

Models: 1255, 1256, 1260, 1262, 1266, 1267, 1272, 1273, 1274, and 1275

Before You Begin	Specifications	Parts Catalog
Removal Sequence	Troubleshooting	Battery Operations
Product Description	Pin Assignments	Index

Specifications

Battery Pack

Battery Pack		
	Nickel Metal Hydride (NiMH)	Lithium Ion (Li ion)
Dimensions Height Length Width	0.8 in (20.3 mm) 5.7 in (145 mm) 3.1 in (78.7 mm)	0.8 in (20.3 mm) 5.7 in (145 mm) 3.1 in (78.7 mm)
Weight	1.01 lb (458.1 g)	0.90 lb (408.2 g)
Energy Nominal Open Circuit Voltage Capacity Power	9.6 V 4.5 Ah 43.2 Wh	14.8 V 3.0 Ah 44.4 Wh
Environmental Requirements Operating Temperature Non-operating Temperature Charging Temperature	32° F (0-50° C) -20° C -60° C 5° C-45° C	32° F (0-50° C) -20° C -60° C 5° C-45° C

[Return to the index list of Specifications](#)

maintenance & service guide

Presario 1200 Series

Models: 1255, 1256, 1260, 1262, 1266, 1267, 1272, 1273, 1274, and 1275

Before You Begin	Specifications	Parts Catalog
Removal Sequence	Troubleshooting	Battery Operations
Product Description	Pin Assignments	Index

Specifications

Diskette Drive

Diskette Drive	
Capacity per Diskette (High/Low)	1,474 KB / 738 KB
Diskette Size	2HD / 2DD
Number of LED Indicators (Read/Write)	NONE
Number of Drives Supported	ONE
Drive Rotation (rpm)	300
Transfer Rate (Kbps)	500 / 250
Bytes per Sector	512
Sectors per Track (High/Low)	18 / 9
Tracks per Disk (High/Low)	160
Access Times:	
Track-to-Track (ms)	3
Average (ms)	94
Setting Time (ms)	15 (Max)
Latency Average (ms)	100
Cylinders (High/Low)	80
Number of Read/Write Heads	2

Return to the index list of [Specifications](#).

maintenance & service guide

Presario 1200 Series

Models: 1255, 1256, 1260, 1262, 1266, 1267, 1272, 1273, 1274, and 1275

Before You Begin	Specifications	Parts Catalog
Removal Sequence	Troubleshooting	Battery Operations
Product Description	Pin Assignments	Index

Specifications

Hard Drives

Hard Drives			
	3.2-GB	4.3-GB	4.8-GB
Capacity Per Drive (Formatted)	3.2 GB	4.3 GB	4.8 GB
Drive Type	2.5"	2.5"	2.5"
Logical Configuration			
Cylinders	7470	6568	11648
Heads	4	6	4
Sectors per track	---	---	330 (max.)
Bytes per sector	512	512	512
Seek Times (Typical, Including settling in ms)			
Single track	---	---	5.5 max (read) 6.5 max (write)
Average	12	12	16 max (read) 17 max (write)
Full stroke	---	---	30 max (read) 31 max (write)
Transfer Rate			
At interface	33.3 MB/S	33.3 MB/S	33.3 MB/S

Hard Drives	
	6.4-GB
Capacity Per Drive	6.49 GB
Drive Type	2.5"
Logical Configuration	
Cylinders	8955
Heads	6
Sectors per track	---
Bytes per sector	512
Seek Times (Typical, Including settling in ms)	
Single track	---
Average	12
Full stroke	---
Transfer Rate	
At interface	33.3 MB/S

Return to the index list of [Specifications](#).

maintenance & service guide

Presario 1200 Series

Models: 1255, 1256, 1260, 1262, 1266, 1267, 1272, 1273, 1274, and 1275

Before You Begin	Specifications	Parts Catalog
Removal Sequence	Troubleshooting	Battery Operations
Product Description	Pin Assignments	Index

Specifications

CD Drive

24× CD Drive	
Dimensions	128 x 12.7 x 129 mm
Weight	0.5 lbs
Rotational Speed	5120 rpm
Typical Transfer Rate Sustained Data Transfer Rate	3600 KB/s
Access Time Average Random Access Time	110 ms
Spin Up time	2.7 s
Data Buffer Capacity	128 KB

Return to the index list of [Specifications](#).

maintenance & service guide

Presario 1200 Series

Models: 1255, 1256, 1260, 1262, 1266, 1267, 1272, 1273, 1274, and 1275

Before You Begin	Specifications	Parts Catalog
Removal Sequence	Troubleshooting	Battery Operations
Product Description	Pin Assignments	Index

Connector Pin Assignments

This appendix provides connector pin assignment tables for Compaq Presario 1200 Series Portable Computers. For more information on connectors, refer to the section on [Rear Connectors](#).

NOTE: The signals in all tables of this appendix are considered active high unless otherwise indicated by an asterisk (*).

Click on a link:

- [Parallel Connector](#)
- [Serial Connector](#)
- [Keyboard/Mouse](#)
- [External VGA Monitor](#)
- [Universal Serial Bus](#)
- [Modem](#)

Parallel Connector



Pin	Signal	Pin	Signal
1	Strobe*	10	Acknowledge*
2	Data Bit 0	11	Busy
3	Data Bit 1	12	Paper Out
4	Data Bit 2	13	Select
5	Data Bit 3	14	Auto Linefeed*
6	Data Bit 4	15	Error*
7	Data Bit 5	16	Initialize Printer*
8	Data Bit 6	17	Select In*
9	Data Bit 7	18-25	Signal Ground

* = Active low

[Return to the top.](#)

Serial Connector

Connector	Pin	Signal
	1	Carrier Detect
	2	Receive Data
	3	Transmit Data
	4	Data Terminal Ready
	5	Signal Ground
	6	Data Set Ready
	7	Ready to Send
	8	Clear to Send
	9	Ring Indicator

[Return to the top.](#)

Keyboard/Mouse

Connector	Pin	Signal
	1	Data 1
	2	Data 2
	3	Ground
	4	+5 V
	5	Clock 1
	6	Clock 2

[Return to the top.](#)

External VGA Monitor

Connector	Pin	Signal
	1	Red Analog
	2	Green Analog
	3	Blue Analog
	4	Not connected
	5	Ground
	6	Ground Analog
	7	Ground Analog
	8	Ground Analog
	9	Not connected
	10	Ground
	11	Monitor Detect
	12	DDC2B Data
	13	Horizontal Sync
	14	Vertical Sync
	15	DDC2B Clock

[Return to the top.](#)

Universal Serial Bus

Connector	Pin	Signal
	1	+5V
	2	Data -
	3	Data +
	4	Ground

[Return to the top.](#)

Modem

Connector	Pin	Signal
	1	Unused
	2	Unused
	3	Tip
	4	Ring
	5	Unused
	6	Unused

maintenance & service guide

Presario 1200 Series

Models: 1255, 1256, 1260, 1262, 1266, 1267, 1272, 1273, 1274, and 1275

Before You Begin	Specifications	Parts Catalog
Removal Sequence	Troubleshooting	Battery Operations
Product Description	Pin Assignments	Index

Battery Pack Operating Time

This appendix covers the following information concerning battery pack operating time:

- Increasing battery pack operating time
- [Conditioning a battery pack](#)
- [Disposing of a used battery pack](#)

Increasing Battery Pack Operating Time

Battery pack operating time differs depending on several variables. To avoid unnecessary replacement, consider the following variables when determining how long a charged battery pack should last:

- Power management settings
- Hardware configuration
- Software applications
- Installed options
- Display brightness
- Hard drive usage
- Changes in operating temperature
- Type and number of installed PC Cards

NOTE: The power consumption requirements for PC Cards vary widely. Some cards drain the battery pack very rapidly.

Battery pack operating time can be increased by as much as 50 percent by controlling the energy required by the computer and the energy stored in the battery pack.

Minimizing the Energy Required

To minimize the energy required by the computer, follow these steps:

1. Set the power conservation levels in the Power Management utility to **Maximum**.
2. Customize the timeout value to work more efficiently with the applications. The amount of battery life depends on the values selected.

Maximizing the Energy Stored

To maximize the energy stored in the battery pack, follow these guidelines:

- Condition the battery pack at least every 30 days to improve overall battery performance.
- Keep a battery pack in the computer when using it with AC power to supply the battery pack with a constant trickle charge.
- Store the battery pack in a cool, dry place when not in use.

Return to the [top of this page](#).

Conditioning a Battery Pack

 **CAUTION:** To avoid a loss of data, ensure that all data is saved before discharging a battery pack.

To condition a battery pack, complete the following steps:

1. Plug in the AC adapter and allow the battery to charge until the LED light on the display stops blinking. Your battery gauge may read 100 percent for a period of time before LED light on the display stops blinking. Do not unplug the AC adapter until the arrow disappears.
2. Unplug the AC adapter and allow the battery to drain until the computer reaches hibernation and turns itself off. **Do not plug in the AC adapter during this process or you will need to restart with Step No. 1.** You may use the computer while the battery is draining.
3. Your battery is re-conditioned.
4. Plug in the AC adapter and begin using the computer.

The table below shows the approximate battery pack charge times.

Approximate Battery Charge Time		
Computer	On Line	Off Line
NiMH Battery Pack	4.0 hours	2:00 hrs
Li ion Battery Pack	4.5 hours	2:50 hrs

Disposing of a Used Battery Pack

In the interest of safeguarding our environment, Compaq Computer Corporation recommends that nickel metal hydride (NiMH) and lithium ion (Li ion) battery packs be recycled. Battery packs should be handled in accordance with country, state, province, or local regulations.

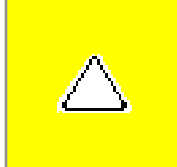
 **CAUTION:** Never attempt to open or service a battery pack. Opening a battery pack not only damages the pack and makes it unusable, but also exposes potentially harmful battery components.

Return to the [top of this page](#).

Free Manuals Download Website

<http://myh66.com>

<http://usermanuals.us>

<http://www.somanuals.com>

<http://www.4manuals.cc>

<http://www.manual-lib.com>

<http://www.404manual.com>

<http://www.luxmanual.com>

<http://aubethermostatmanual.com>

Golf course search by state

<http://golfingnear.com>

Email search by domain

<http://emailbydomain.com>

Auto manuals search

<http://auto.somanuals.com>

TV manuals search

<http://tv.somanuals.com>