

PCI Express® Expansion User's Manual



ExpressBox¹ & ExpressBox¹ Pro

Model: EB1H

Model: EB1F

Copyright © 2007 Mission Technology Group, Inc. - DBA Magma

This publication is protected by Federal Copyright Law, with all rights reserved. No part of this publication may be copied, photocopied, reproduced, stored in a retrieval system, translated, transmitted or transcribed, in any form or by any means manual, electric, electronic, electro-magnetic, mechanical, optical or otherwise, in whole or in part without prior written consent from Magma.

Limitation of Liability

Information presented by Magma in this guide is believed to be accurate and reliable. However, Magma assumes no responsibility for its use. No license is granted by implication or otherwise to any rights of Magma.

Product specifications and prices are subject to change without notice.

Trademark References

Trademarks and registered trademarks are proprietary to their respective manufacturers.

Table of Contents

PREFACE	III
What's in this Guide	iii
Advisories	iii
Safety Instructions	iv
When Working Inside a Computer	v
Protecting Against Electrostatic Discharge	vi
CHAPTER 1 INTRODUCTION	1
General Specifications	1
Pre-Installation Information	2
Package Contents:.....	2
Tools Required for Installation	2
CHAPTER 2 HARDWARE INSTALLATION	3
Open Cover.....	4
Install 3 rd Party PCI Express Card	5
Attach Cables.....	6
Laptop Installation.....	6
Desktop or Server Installation.....	7
Recheck Installation.....	9
Applying Power Correctly.....	10
System Should Be Up and Running	11
Verify Installation.....	11
Windows	11
Mac OS X	13
Expansion Slot Utility	13
System Profiler.....	15
Finished	16
Cleaning up.....	16
CHAPTER 3 TROUBLESHOOTING	17
Locate the Problem.....	17
Support for 3 rd Party Cards	18
The 3 rd Party PCI Express Card is not found	19
Windows XP/Vista:.....	19
MAC	20
My Computer Hangs During Power Up.....	20
CHAPTER 4 SOFTWARE INSTALLATION	22
Windows	22
MacOS X.....	25
Linux RedHat 9	25
CHAPTER 5 HOW TO GET MORE HELP	26
Frequently Asked Questions (FAQ)	26
Contacting Technical Support.....	26
Magma Debug Utility.....	27
PCIScope Software Utility.....	28

M A G M A

Returning Merchandise to Magma 30

APPENDIX A COMPLIANCE 31

FCC 31

Industry Canada 31

CE 31

Preface

What's in this Guide

This manual is divided into the following parts:

[Chapter 1: Provides General Specifications and Parts List.](#)

[Chapter 2: Briefly explains hardware installation.](#)

[Chapter 3: Provides troubleshooting assistance.](#)

[Chapter 4: Explains Magma Software Installation.](#)

[Chapter 5: Explains where to get technical support.](#)

[Appendix A: Provides information about Compliance.](#)

Advisories

Five types of advisories are used throughout this manual to provide helpful information, or to alert you to the potential for hardware damage or personal injury. They are **Note**, **Important**, **Caution**, **Warning**, and **Danger**. The following is an example of each type of advisory.



NOTE

Used to amplify or explain a comment related to procedural steps or text.



IMPORTANT

Used to indicate an important piece of information or special "tip" to help you



CAUTION

Used to indicate and prevent the following procedure or step from causing damage to the equipment.



WARNING

Used to indicate and prevent the following step from causing injury.



DANGER or STOP

Used to indicate and prevent the following step from causing serious injury or significant data loss.

Disclaimer: We have attempted to identify most situations that may pose a danger, warning, or caution condition in this manual. However, Magma does not claim to have covered all situations that might require the use of a Caution, Warning, or Danger indicator.

Safety Instructions

Always use caution when servicing any electrical component. Before handling the Magma product, read the following instructions and safety guidelines to prevent damage to the product and to ensure your own personal safety. Refer to the “Advisories” section for advisory conventions used in this manual, including the distinction between Dangers, Warnings, Cautions, and Notes.

- ◆ Always use caution when handling/operating the computer. Only qualified, experienced, authorized electronics personnel should access the interior of the computer. The power supplies produce high voltages and energy hazards, which can cause bodily harm.

- ◆ Use extreme caution when installing or removing components. Refer to the installation instructions in this manual for precautions and procedures. If you have any questions, please contact Magma Technical Support.



WARNING

High voltages are present inside the expansion unit when the unit's power cord is plugged into an electrical outlet. Disconnect the power cord from its source before removing the system cover.

Never modify or remove the radio frequency interference shielding from your workstation or Magma unit. To do so may cause your installation to produce emissions that could interfere with other electronic equipment in the area of your system.

When Working Inside a Computer

Before taking covers off a computer, perform the following steps:

1. Turn off the computer and any peripherals
2. Disconnect the computer and peripherals from their power sources to prevent electric shock or system board damage.
3. Disconnect any telephone or telecommunications lines from the computer.

In addition, take note of these safety guidelines when appropriate:

- ◆ To help avoid possible damage to systems boards, wait five seconds after turning off the computer before removing a component, removing a system board, or disconnecting a peripheral device from the computer.
- ◆ When you disconnect a cable, pull on its connector or on its strain-relief loop, not on the cable itself. Some cables have a connector with locking tabs. If you are disconnecting this type of cable, press in on the locking tabs before disconnecting the cable. As you pull connectors apart, keep them evenly aligned to avoid bending any connector pins. Also, before connecting a cable, make sure both connectors are correctly oriented and aligned.



CAUTION

Do not attempt to service the system yourself except as explained in this manual. Follow installation instructions closely.

Protecting Against Electrostatic Discharge

Electrostatic Discharge (ESD) Warning



Electrostatic Discharge (ESD) is the enemy of semiconductor devices. You should always take precautions to eliminate any electrostatic charge from your body and clothing before touching any semiconductor device or card by using an electrostatic wrist strap and/or conductive mat.

Static electricity can harm system boards. Perform service at an ESD workstation and follow proper ESD procedure to reduce the risk of damage to components. Magma strongly encourages you to follow proper ESD procedure, which can include wrist straps and smocks, when servicing equipment.

You can also take the following steps to prevent damage from electrostatic discharge (ESD):

- ◆ When unpacking a static-sensitive component from its shipping carton, do not remove the component's anti-static packaging material until you are ready to install the component in a computer. Just before unwrapping the anti-static packaging, be sure you are at an ESD workstation or grounded.
- ◆ When transporting a sensitive component, first place it in an anti-static container or packaging.
- ◆ Handle all sensitive components at an ESD workstation. If possible, use anti-static floor pads and workbench pads.
- ◆ Handle components and boards with care. Don't touch the components or contacts on a board. Hold a board by its edges or by its metal mounting bracket.

Chapter 1 Introduction

General Specifications

Magma ExpressBox¹ is an easy-to-use device for attaching a "desktop-only" PCI Express® card to a laptop or moving a hot or power-hungry PCI Express card outside of the host computer.

Magma ExpressBox¹ offers support for any single-width PCI Express card with a power requirement of 55 watts or less. ExpressBox¹ provides dedicated power and cooling to ensure the PCI Express card runs at maximum efficiency. Each system can accommodate up to a x16 (16 lane) PCI Express card.

ExpressBox¹ (Model EB1H) is designed for half-length (6.604" or shorter) PCI Express cards and weighs only 2.8 pounds. ExpressBox¹ Pro (Model EB1F) is designed for three-quarter and full-length PCI Express cards (12.283" or shorter) and weighs only 4.3 pounds.

Just about any type of PCI Express card can be used in ExpressBox¹ ranging from audio processing, video capture, graphics, test & measurement, data-acquisition, SCSI, FiberChannel, SATA and more.

Magma ExpressBox¹ includes a Magma ExpressCard or PCIe host card, a PCI Express cable, an enclosure containing a PCI Express slot, a power supply and cooling fans.

Item	Description
Backplane:	One PCI Express slot (x16 connector)
Half-length Enclosure:	Silver Aluminum and Plastic 7.71" x 1.73" x 8.04" 2.8 lbs or 1.27 kg Three 3.5 CFM cooling fans Maximum card length: 6.604"
Full-length Enclosure:	Silver Aluminum and Plastic 7.71" x 1.73" x 13.72" 4.3lbs or 1.95kg Three 3.5 CFM cooling fans Maximum card length: 12.283"
Cable Length:	1 meter Optional ½ meter and 3 meter length
Power Supply:	60 Watt, internal, auto-switching Input Voltage: 90 - 264 VAC Input Frequency: 47 - 63 Hz Inrush Current: less than 30A @ 115VAC less than 60A @ 230VAC DC Output: 60W Max 12V/5.0A
PCI Express Specification:	Revision 1.1
PCI Express External Cabling Specification:	Revision 0.5
Raw Interconnect Bandwidth:	2000 Mbps, 250MB/sec (full x1 PCIe speed with no latency)
Operating Environment:	0° to 50° C Operating Temperature -20° to 60° C Storage Temperature

M A G M A

	5% to 85% Relative Humidity, Non-condensing
MTBF:	25,000 hours
Supported Operating Systems:	Windows Vista, Windows XP, Mac OS X
Regulatory Compliance	FCC Class B Verified, CE Certified, TUV NTRL Tested
Warranty:	30 Day Money Guarantee 1 Year Return to Factory

Pre-Installation Information

Before using the Magma product you should perform the following steps:

- Inventory the shipping carton contents for all of the required parts
- Gather all of the necessary tools required for installation
- Read this manual

Package Contents:

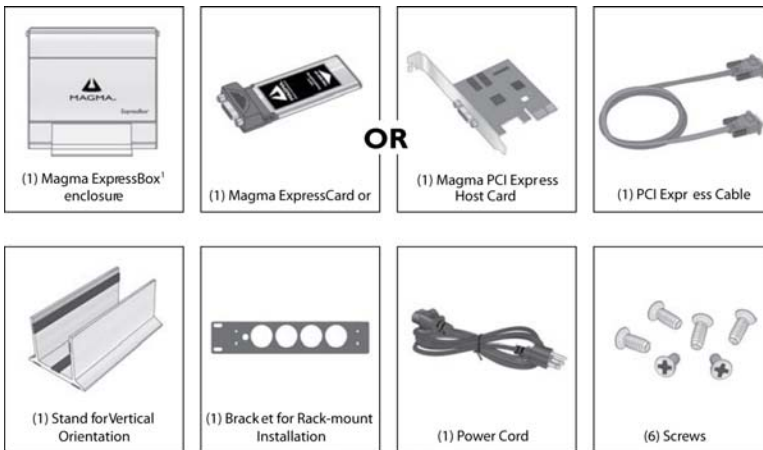

Tools Required for Installation

In order to complete the installation of Magma ExpressBox¹ you will need both a Phillips and a Flathead screwdriver.



Chapter 2 Hardware Installation

The following steps will guide you in completing the hardware installation of your Magma ExpressBox¹.



Warning

Electrostatic Discharge (ESD) Warning

Computer add-in cards are susceptible to electrostatic discharge. When moving cards, it is best to carry the cards in anti-static packaging. If you need to set a card down, be sure to place it inside or on top of an anti-static surface. For more information, see “Protecting Against Electrostatic Discharge” in the Preface.



Warning

WARNING

High voltages are present inside the expansion unit when the unit’s power cord is plugged into an electrical outlet. Disconnect the power cord from its source before opening the enclosure cover. Turning the system power off at the power on/off switch does not remove power to components. High voltage is still present.



Caution

CAUTION

Before touching anything inside the enclosure, move to an ESD station and follow proper ESD procedure. Failure to do so may result in electrostatic discharge damaging the computer or its components. For more information, see “Protecting Against Electrostatic Discharge” in the Preface.



Danger

STOP

DO NOT ATTEMPT TO REMOVE THE PLASTIC COVER CONTAINING THE MARKINGS SHOWN HERE. The cover protects the power supply which could electrocute if touched.



WARNING: Electric Shock Hazard.
No user serviceable parts inside.



Danger

STOP

If your Magma product was not purchased directly from Magma, you must check to ensure that it doesn’t contain any pre-installed PCI Express cards.

Check the rear side of the chassis to see if a PCI Express card is visible in the slot. If you see a PCI Express card, you should continue installation using instructions provided by your dealer. If no separate instructions are available, remove the cover by following instructions included in this manual. Then remove the card as normal. If no PCI Express card is visible, then continue with the installation.

M A G M A

This chapter provides information only on how to install 3rd Party PCI Express cards into your Magma ExpressBox¹. More details on the installation of individual cards are provided by the card's manufacturer.

For the purpose of installation, Magma ExpressBox¹ functions exactly as a standard desktop computer chassis. Always follow the manufacturer's instructions for installing their card on a desktop computer.

IMPORTANT



We will provide reasonable technical support for 3rd Party cards installed in your Magma expansion product. However, if you have verified a successful installation of Magma ExpressBox¹ (as defined in *the Verify Installation section*), but experience difficulty installing your 3rd Party cards, the card manufacturer should be able to provide the best support.

1 Open Cover

Two thumbscrews retain the cover on ExpressBox. The screws are located on the corners of the unit, on the left and right side of the cover's back edge. Loosen these screws by turning them counterclockwise to open the enclosure.

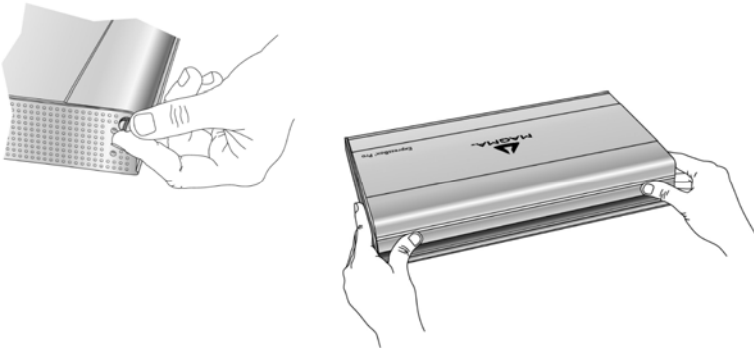

Once the screws are removed, simply lift the lid to gain access to the available x16 PCI Express slot. Although the slot will accommodate x1, x4, x8, and x16 PCI Express cards, the connection to the computer is limited to x1 PCI Express speed.

2 Install 3rd Party PCI Express Card

Install PCI Express cards following PCI Express card manufacturer's recommendations. Some PCI Express card manufacturers recommend that you install their software driver(s), if required, prior to installing the hardware. If this is the case, you should install their driver before you connect and power up your Magma ExpressBox¹.

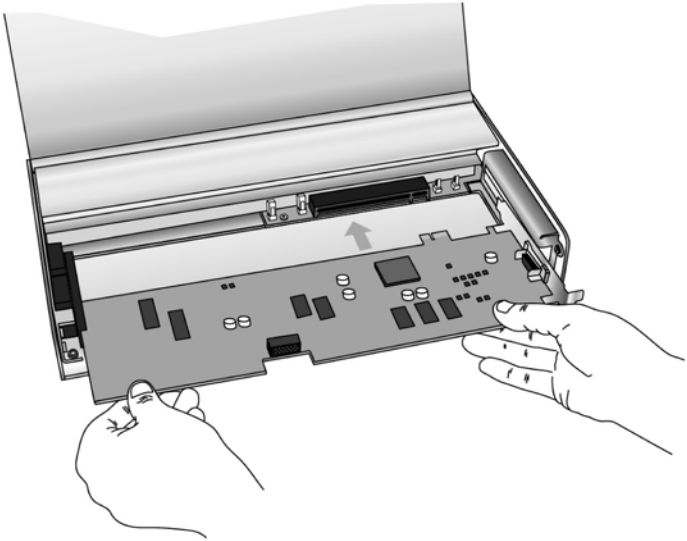

Make sure that the PCI Express card is fully seated in the connectors. When correctly seated in the connector, you will notice a firm resistance when you pull up gently on the card. To keep the card in place, secure it in the enclosure with its retaining screw (supplied with the Magma ExpressBox¹).

WARNING



Magma ExpressBox¹ provides up to 55 watts of power for the 3rd Party card. Installing a card requiring more than 55 watts of power will damage the power supply inside Magma ExpressBox¹. It is common for high-end graphics cards to require more than 55 watts. Contact the PCI Express card manufacturer to determine the power requirements for your card. Magma ExpressBox¹ is not intended to be used with "double-wide" graphics cards.

IMPORTANT



The sheer number of PCI Express cards and device drivers available makes it impossible for Magma to fully test and certify all available PCI Express cards for use in Magma ExpressBox¹. Our best advice to you in this regard is to insist on full PCI Express Specification compliance from your card and system vendors. Cards and systems should be at least PCI Express Specification Revision 1.1 compliant or better. Compliance in your system motherboard, PCI Express cards, and console firmware (or BIOS) is your best assurance that everything will install and operate smoothly.

DANGER



Do not attempt to remove the protective covering over the high-voltage power supply. There are no user-serviceable parts inside.



WARNING: Electric Shock Hazard.
No user serviceable parts inside.



Attach Cables



CAUTION

Before connecting the power cord, check that the On/Off switch is set to the OFF position (o = OFF, | = ON). This switch is located directly above the 18-pin connector.

Laptop Installation

Attach one end of the PCI Express cable to the Magma ExpressCard module and the other end to the connector on the back of the Magma unit. The cable connects to using thumbscrews; therefore no tools are required.



Before inserting the Magma ExpressCard, power down your laptop computer. Use the procedures for shutting down your operating system and shutting off power to your system provided in your owner's manual or system documentation.

Insert the Magma ExpressCard/34 module with the logo side up, into the ExpressCard slot on your computer. Gently push the card until it is firmly seated.

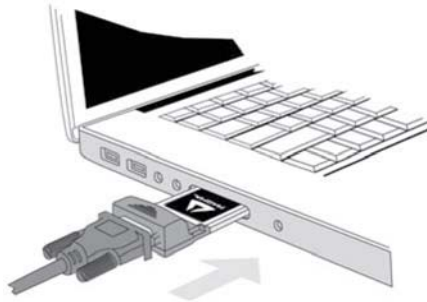
**NOTE**

The Magma ExpressCard module can only be used in a computer system that contains an ExpressCard slot. It will not function in CardBus or PCMCIA slots.

**NOTE**

If your laptop's ExpressCard slot is "spring-loaded", be sure that your ExpressCard is inserted correctly. It is very easy for this style slot to partially release a card if touched slightly.

For more information on using ExpressCard modules, please refer to your computer's user manual or system documentation.

Desktop or Server Installation

Power down your computer. Use the procedures for shutting down your operating system and shutting off power to your system provided in your owner's manual or system documentation.

After the host computer is off and all power cords disconnected, remove the cover and insert the Magma PCIe host card (EEX1) into a vacant PCI Express (PCIe) slot by gently pushing the card until it is firmly seated. Be sure to secure the card with a retaining screw.

STOP

YOU MUST ONLY INSTALL THE MAGMA EEX1 INTO A **PCI EXPRESS SLOT**.



Only use cards WITH brackets. This will ensure that your PCIe host card can only be inserted into a PCIe slot. Although PCI Express cards without brackets may fit into conventional PCI slots, you run the risk of damaging the PCI Express host card if you insert it into a PCI slot. Please ensure that your host computer has PCI Express slots and install the host card **only** into a PCI Express slot.

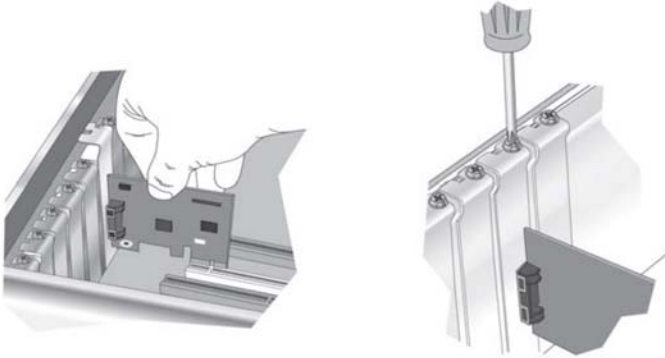

Notice that the PCI Express slots are located at a greater distance from the edge of the computer's motherboard than are the standard PCI slots.

It's important to make sure you are installing the Magma EEX1 into a PCI Express slot.

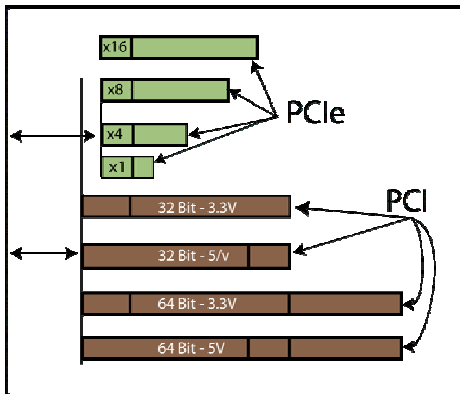

Attach one end of the PCI Express cable to the Magma EEX1 card in the host computer and the other end to the connector on the back of the Magma unit. The cable connects to the using thumbscrews; therefore no tools are required for the cable connection.



Although this x1 Host Card will work correctly in any x1, x4, x8, or x16 slot, using a higher rated slot will not increase the speed beyond the rated x1 speeds.

The Magma EEX1 is a “half-height” x1 PCIe card attached to a “full-height” bracket for convenient mounting in most desktop computers. It is also shipped with a low profile card bracket to allow mounting on low profile computer systems.

For low profile case applications, you may need to change the mounting bracket to the low profile bracket that shipped with your system. This is done by removing the screws that hold the card to the bracket. Be sure you are using proper ESD procedures when completing this action.

For more information on installing PCIe Cards, please refer to your computer’s user manual or system documentation.



NOTE

If at all possible, plug all power cords from Magma ExpressBox¹ and your computer into a shared power strip, preferably one that has surge and noise suppression circuitry built into it.

4

Recheck Installation

Check your installation before powering up Magma ExpressBox¹ for the first time.

**CAUTION**

If you are using a power source other than 110V US Standard, you will need a different power cord to connect your source power to the power adapter, or a power cord adapter so you can plug the 110V US Standard power cord directly into your source power. Fortunately, the power supply is auto-switching, so the only thing you will need is the correct power cord connector.

5 Applying Power Correctly

You must apply power to Magma ExpressBox¹ **BEFORE** you power up your computer. This allows the computer BIOS to identify and assign resources appropriately.

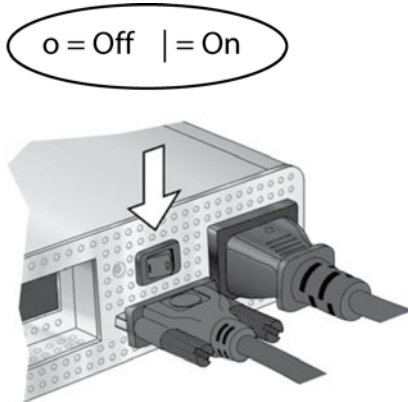

Check the front of the enclosure to be sure there is a glowing red LED in a 'steady state'. If the LED is flickering turn power off and on until a 'steady state' is reached.

IMPORTANT

When powering up, pay close attention to LEDs on that shines through the front panel. The red light must be **solid** red before the system will function properly. If the red LED is flickering, there may be a power problem occurring during start-up. This problem may be resolved by turning ExpressBox off and on again until the LED remains on at a steady state.

**STOP**

DO NOT TURN ON MAGMA EXPRESSBOX¹ UNTIL YOU HAVE SHUT DOWN YOUR LAPTOP COMPLETELY! It can cause a system lockup and loss of any unsaved data.

6**System Should Be Up and Running**

Apply power to Magma ExpressBox¹ first, then power up the computer.

Use the procedures detailed in Step **7** below to confirm the card installation in the Windows Device Manager or Apple System Profiler.

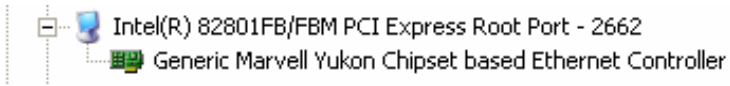
**7****Verify Installation****Windows**

To verify a successful installation, use the **'My Computer'** icon on your desktop or on the Start Menu.

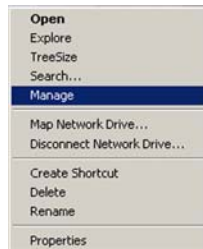

Right-click and select **'Manage.'**

M A G M A

Select 'Device Manager' from the items in the left side of the Computer Management Window. Then click on the **View** Menu and select **View Devices by Connection**.



To see if your installation is completed:

- Click on the '+' sign to the left of the **ACPI** (BIOS) to open it. This is typically found at the top of the Device Manager Window.
- Click the '+' sign to the left of the line containing the words "Express Root" or something similar. You should now see your 3rd Party PCI Express Card immediately below it.

When installed correctly, you will see your 3rd Party PCI Express Card. The example shown below is from an Intel Chipset computer.

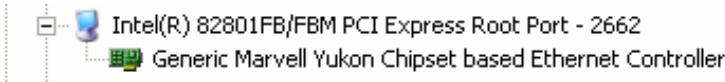

If your 3rd Party PCI Express Card contains a PCI Bridge on the card, the Device Manager will display something similar to the following:

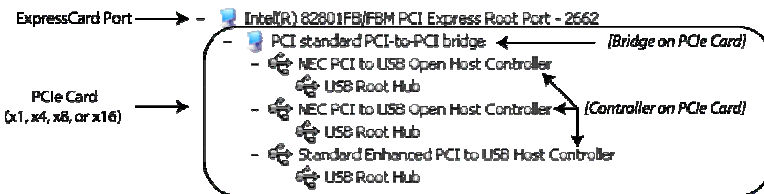

If everything is OK, then the installation is complete.

If the installation was unsuccessful you may see a small yellow  (bang) in front of the PCI Express Root Port, or nothing may be visible at all.

If any of these devices are not displayed as shown above, you should shut down your system (computer first, then ExpressBox) and reconnect the cables and the Magma ExpressCard to ensure that you have a solid connection. Restart Magma ExpressBox¹; then restart the computer.

Next, try to verify the installation again, as shown above. If you are still having problems, review [Chapter 3 Troubleshooting](#) before contacting Magma Technical Support at (858) 530-2511. Additional troubleshooting help is available online at <http://www.magma.com/support>.

Mac OS X

When using Mac OS X no additional software or drivers are needed to verify correct the installation the Magma ExpressBox¹. However; your 3rd Party card may require a driver to work properly. Contact the card's manufacturer to obtain the latest drivers.

Expansion Slot Utility

For desktop installations only, the following screen maybe displayed the first time you turn on your computer with the Magma ExpressBox¹ host card installed.

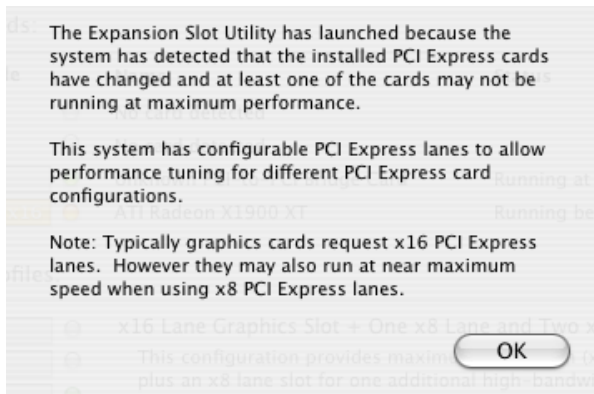

Choose OK.

MacOS X is prompting you to choose a PCI Express profile that maximizes the performance of your attached devices. The Magma ExpressBox¹ functions at x1 PCI Express speed so it will operate at maximum no matter which slot is used.

M A G M A

You should choose a profile that matches the configuration of all the cards installed in your Mac. Since the Magma ExpressBox¹ functions at x1 PCI Express, any of the profiles will work; however, to maximize your performance with other PCI Express cards, Magma recommends that you install your Magma host card into a slot designated as a x1 slot (slot 2 or slot 3).

In this example, we have installed an Apple Fibre Channel Card inside Magma ExpressBox¹. The Magma EEX1 host card is installed in slot 2.

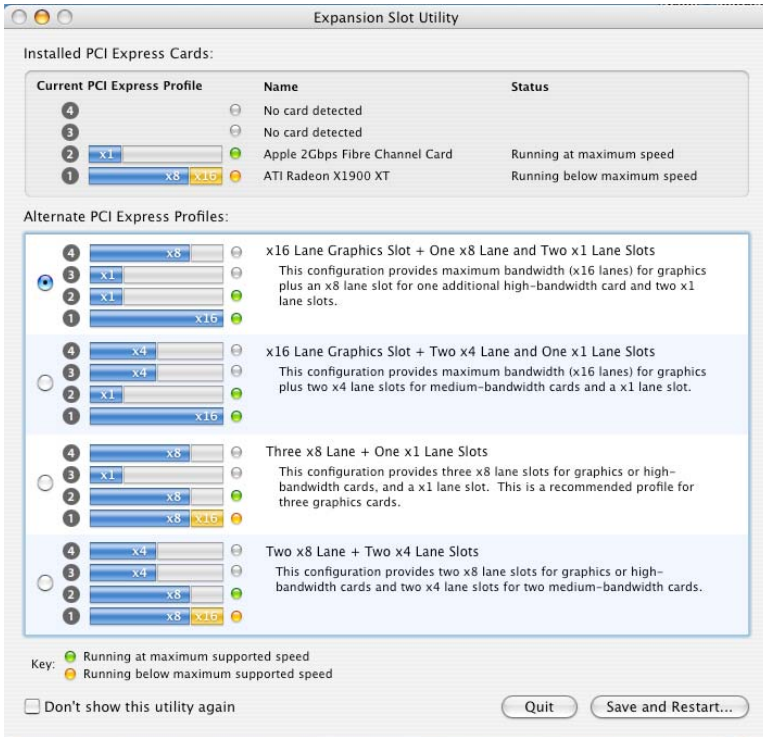

If your computer did not automatically prompt you to choose a PCI Express profile, you can locate this utility under System → Library → CoreServices → Expansion Slot Utility.app. This utility is available for Apple desktop computers only, not Apple laptop computers.

System Profiler

You can verify successful installation by viewing Apple System Profiler.

Select **“About This Mac”** under the Apple Icon

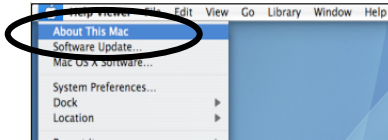

Then click the **“More Info”** button.



Open the **Hardware** tab and choose **PCI Cards** from the drop down list.

When installed correctly, you will see your 3rd Party card under the PCI cards option.

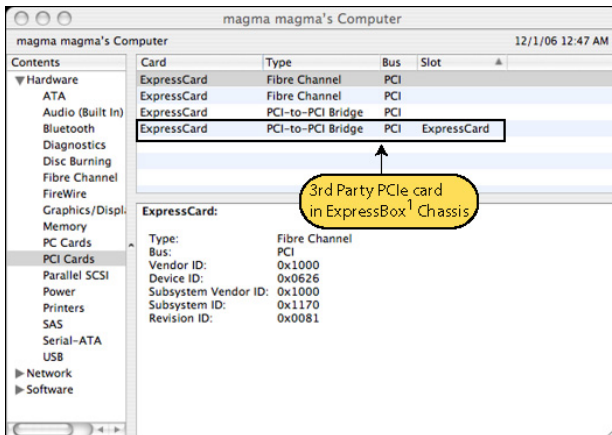

M A G M A

If your device is not displayed as shown above, you should shut down your system (computer first, then ExpressBox) and reconnect the cables to ensure that you have a solid connection. Restart Magma ExpressBox¹, and then restart the computer. Next, try to verify the installation again, as shown above. If you are still having problems contact Magma Technical Support at (858) 530-2511.



Finished

Once you have completed the all the installation steps and successfully verified the installation of the ExpressBox and your 3rd Party Card, you have completed the installation. You are now ready to enjoy using your new Magma product.

Cleaning up

If your installation efforts have left fingerprints or smudges on the ExpressBox case, you can easily clean them using the following simple steps.

1. ExpressBox's aluminum finish should be cleaned with a soft cloth.
2. If required, the cloth may be dampened with water, or for stubborn spots, a mild diluted soap solution such as Dawn.



CAUTION

DO NOT use commercial cleaners such as 409, or Windex, etc, as they are corrosive to the aluminum finish.

Chapter 3 Troubleshooting

Locate the Problem

If you are having trouble with Magma ExpressBox¹, verify that the 3rd party PCI Express card is seated properly and all cables are connected properly. (Remember to power On and Off correctly.) Recheck the Windows Device Manager or the Apple System Profiler.

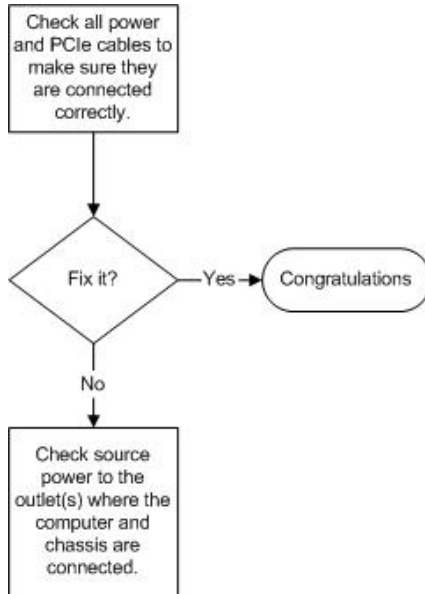



If you continue to have problems, there is a quick-check you can perform to determine if the problem is actually with the 3rd Party card or a defect with the Magma hardware.

1. Shut down the computer followed by Magma ExpressBox¹
2. Remove the PCI Express card displaying a problem
3. Replace the “problem card” with a *simple* PCI Express card, such as an Ethernet card that has drivers built into the operating system. (Using this “type of card” will avoid any future questions about drivers possibly being installed incorrectly.)
4. Turn on Magma ExpressBox¹, and then turn on the computer.

Windows 2000/XP

5. Next, open the Device Manager (View by Connection selection).

If the  is gone, the problem is with the 3rd Party card or the card drivers. You should go to the *Windows Error Codes* section of this chapter to learn how to troubleshoot using error codes.

If the  is still visible, the problem may be with the Magma ExpressBox¹. Please contact Magma Technical Support for further guidance and/or a replacement product.

MAC

5. Next, open the Apple System Profiler and see if the 3rd Party card is now correctly visible.

Support for 3rd Party Cards

Magma will provide reasonable technical support to with 3rd Party cards. However, if you have verified a successful installation of the Magma PCI Express Expansion System (as defined in [Chapter 2](#)), but experience difficulty installing your 3rd Party cards, the PCI Express card manufacturer may be able to provide the best support.

IMPORTANT



Magma ExpressBox¹ is designed to function exactly like your desktop computer. This means that you should follow the card maker's instructions for installation on a Windows or Mac computer as if the Magma unit WAS the desktop computer. When correctly installed, there is no difference to the operating system, removable cards, or most software.

The 3rd Party PCI Express Card is not found

The 3rd Party PCI Express card will be visible in the Device Manager, or Apple Profiler, when everything is installed and connected correctly in the Magma ExpressBox¹. If the 3rd Party PCI Express card is not visible at all, you will need to turn off your computer (first) and then ExpressBox (second) and test all cords and cables to ensure you have everything connected correctly. See Chapter 2, Step 7 for more details. Double-check the ExpressCard to ensure it is inserted correctly. You will also need to ensure the 3rd Party card is correctly installed, and that any required drivers have also been installed as directed by the card manufacturer.

Windows XP/Vista:

If the 3rd Party card is visible, but contains a  in front of it, it has a problem that must be fixed. Right-click on the line to identify this problem. Then select “Properties” from the pop-up menu.

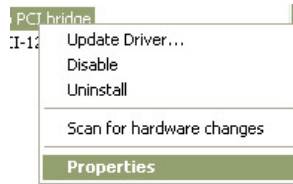

Look for the “Error Code” in the box in the center of the Properties Window and then go to the following *Windows Error Code* section for information on how to resolve this issue.



M A G M A

If you are running Windows XP and have not yet installed the Magma ExpressCard drivers, you should download them from the website at www.magma.com/support/drivers/expressbox and install the driver using the instructions in [Chapter 4](#) Software Installation.

If you are still having problems, call Magma Technical Support.



CAUTION

Do **NOT** click on the Driver tab and attempt to reinstall the driver. This will not help resolve the issue and may even complicate the problem.

MAC

If you have already reinstalled and reseated everything according to instructions in [Chapter 2](#), and your 3rd Party card is still not visible in the Apple System Profiler, call Magma Technical Support.

My Computer Hangs During Power Up

1. Shut off the computer (first) and then Magma unit and verify that all cards and cables are installed correctly.
2. If it still hangs, remove the 3rd Party cards and try booting up without any cards installed.
 - a. If it still hangs, remove the Magma ExpressCard from the computer and try booting up without the Magma unit attached.
 - i. If it boots up OK without the Magma unit attached, call Magma Technical Support.
 - ii. If it still hangs, the problem is in the computer and not with the Magma hardware or the 3rd Party cards. Fix the computer.

- b. If it boots up OK without any 3rd Party cards installed, try adding a simple card and see if it boots up.
 - i. If it boots up OK with a simple card in it, shut it down (in the proper order, of course) and swap cards. If you find a bad card, call Technical Support. If you don't – congratulations, you fixed it!
 - ii. If it still hangs up, try a different card – this one is probably bad (or has driver problems). If the second cards works, troubleshoot the first card. If the second card also fails, call Technical Support.

If you are still having problems, contact Magma Technical Support for more help.

Chapter 4 Software Installation

Windows

A driver is NOT required for Windows Vista, but may be required for a Windows XP installation. You should first install your 3rd Party card and connect Magma ExpressBox¹ following instructions as described in [Chapter 2](#). Only if you are having problems with your Windows XP system should you install the Magma ExpressCard drivers.

Before attempting to install anything on a Windows XP system, you should ensure that you have set a new Restore Point. See your Windows XP manual to learn how to set a new Restore Point. You should ensure that all data files are closed and that you have a current backup.

STOP



Before installing drivers, you should ensure that you have a current system backup of all of your important data.

Failure to follow these instructions exactly could result in a system lock-up and potential loss of data.

Be alert

Be careful

Be protected

You must also disable your anti-virus software before continuing.

For best success when installing the Magma driver:

- Have a current system backup or restore point
- Reboot and Shut down each time you are prompted
- Be logged in as 'System Administrator'
- Follow the installation instructions provided in this guide

You must be logged in as 'System Administrator' while installing Magma ExpressBox¹. You must remain logged in as 'System Administrator' until installation is complete.

Install Driver

- 1 Download driver from Magma website at www.magma.com/support/drivers/expressbox
- 2 Click on the Open button to create a C:\ExpressBox1 folder on your computer.
- 3 Click on the Winzip button to unpack the files into the C:\ExpressBox1 folder.
- 4 Click on the OK button to confirm the files are unpacked.
- 5 Click on the Close button to close WinZip.
- 6 Go to the C:\ExpressBox1 folder and double-click on the Setup.exe file to start the driver installation.
- 7 Follow instructions on the screen during the installation.
- 8 Reboot your computer.

The setup program will prepare the necessary files and present the following window to start the driver installation.

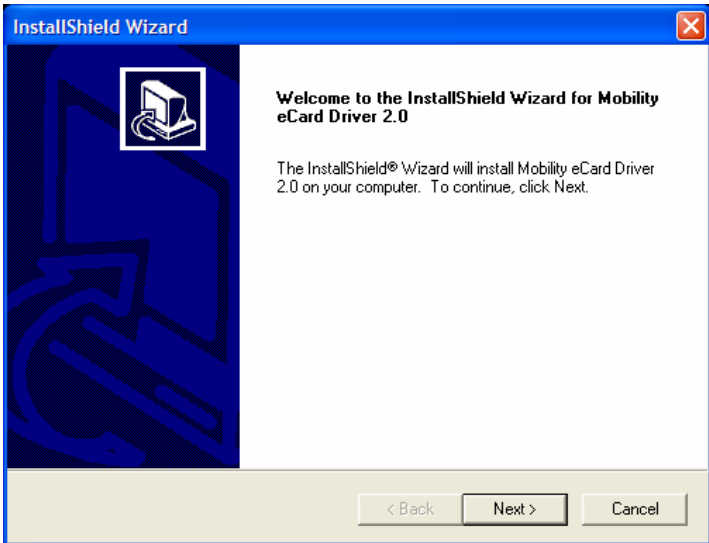

M A G M A

Click **Next** to continue and review the licensing agreement.

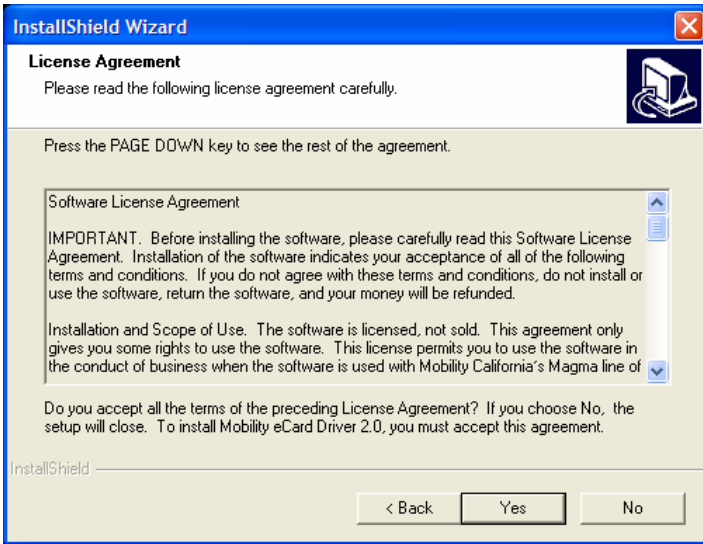

Review the licensing agreement. If you agree, click **Yes** to continue. If you do not agree, click **No** to exit.

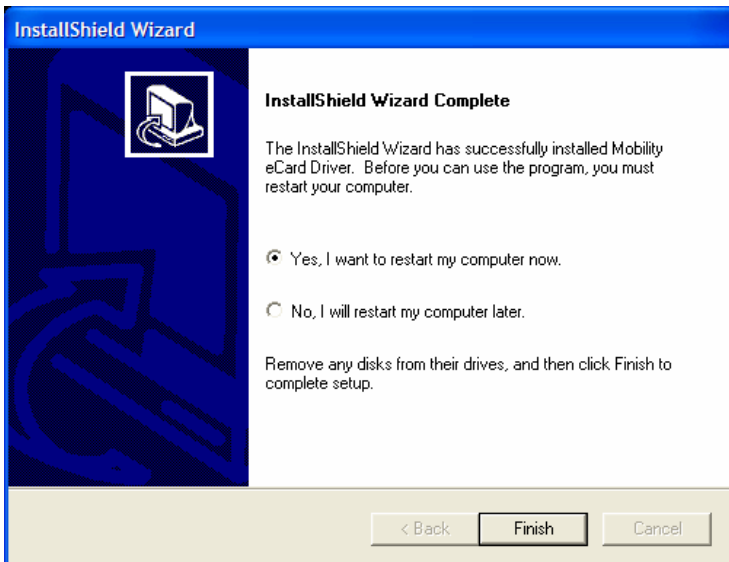

Rather than restarting your computer, it is recommended that you click **“No, I will restart my computer later.”**, and then click **Finish**. You will be instructed to SHUT DOWN your computer in the next step.

MacOS X

A Magma driver is NOT required for MacOS X installation. MacOS X should automatically recognize Magma ExpressBox¹.

Linux RedHat 9

It is presently undetermined if any special configuration is required for proper operation, or if it will work correctly “out of the box.”

Chapter 5 How to Get More Help

Frequently Asked Questions (FAQ)

You can visit the Magma Technical Support FAQ pages on the Internet at:

www.magma.com/support/

Contacting Technical Support

Our support department can be reached by fax at (858) 530-2733 or by phone at (858) 530-2511. Support is available Monday through Friday, 8:00 AM to 5:00 PM PT. When contacting Magma Technical Support, please be sure to include the following information:

- | | |
|------------------|---|
| 1) Name | 7) Serial Number |
| 2) Company Name | 8) Computer Make |
| 3) Phone Number | 9) Computer Model |
| 4) Fax Number | 10) Operating System and Version |
| 5) Email Address | 11) Make/Model of PCI cards installed |
| 6) Model Number | 12) Detailed description of the problem |

You can also visit our web site at:

www.magma.com/support/

For a quick response, use the **Technical Support** and **RMA Request Form** available in the Support Section of the website. Simply complete the form with all required information. Please make sure that your problem description is sufficiently detailed to help us understand your problem.

For example: Don't say "Won't boot up." Do say "Tried all the steps in the Troubleshooting Section and it still won't boot up."

For faster diagnosis of your problem, please run the two utility programs described in the following sections and include the diagnostic files they generate with your email.

Magma Debug Utility

Occasionally, Technical Support may request Windows users to produce and email a Magma debug log file to help them resolve your problem. This file should be included as an attachment when submitting a Technical Support request at www.magma.com/support.

1. Locate a file called **dbgview.exe** on the Magma CDROM.
2. Double-click on the file **dbgview.exe**
3. While the **dbgview** screen is open, locate and double-click on a file called **dump.exe** on the Magma CDROM.
4. Switch back to the **dbgview** screen, which is now filled with data.
5. Save the file and include it as an attachment when submitting a Technical Support request.

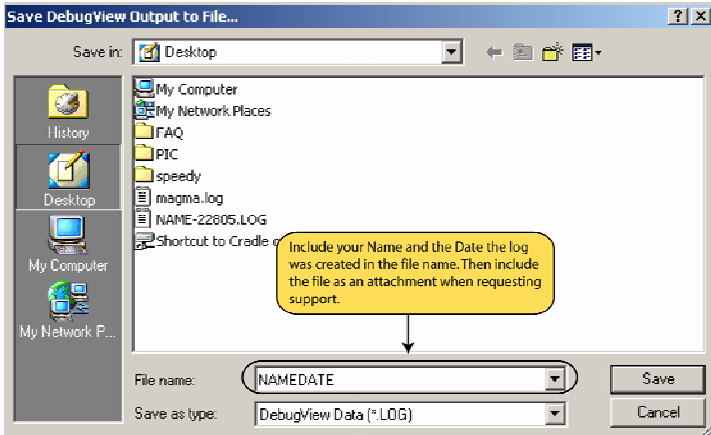

Use the “Save As Type” drop-down arrow to select a file type of (*.LOG).

PCIScope Software Utility

PCIScope is a powerful tool for Windows users. It was designed by a Germany company called APSoft. This software utility is a valuable resource to explore, examine and debug the PCI subsystem of your computer. It was made to fit the requirements of the most demanding users, especially engineers, programmers, and system administrators, and to integrate all advanced functions and tools into one product. Please visit www.tssc.de for more information about the capabilities of **PCIScope** and other utilities offered by APSoft.

An evaluation version of **PCIScope** is available for download at www.tssc.de. (You can purchase an inexpensive license from APSoft for use beyond the evaluation period.)

PCIScope has proven to be extremely useful when verifying and debugging configurations involving the Magma PCI Expansion Systems under any Windows platform.

PCIScope can provide information to you and our Technical Support Group such as PCI Bus Numbering, Resource Allocation, and other information that may prove useful when debugging Magma hardware or PCI problems.

If you are experiencing problems setting up your system, you should run **PCIScope** before contacting the Magma Technical Support Group.

With the Magma product powered up and connected to your computer, load and launch the **PCIScope** application. The **PCIScope** Program will be installed on your computer and a window similar to the one shown below will appear. (The example was taken from a Compaq Armada 7400)

PCIScope - [C:\WINDOWS\DESKTOP\SAMPLE.BPD]

File Edit View Descriptions Tools Window Help

Bus 00h

- Multifunctional device (C...
- 00:00 Compaq - DRA
- 00:01 Compaq - DRA
- Cardbus bridge (Texas In...
- 0C:00 Socket 0
- 0C:01 Socket 1
- Multifunctional device (C...
- 0E:00 Compaq - CET
- 0E:01 Compaq - Trifle
- 0E:02 Compaq - USB

Bus 01h

- 00:00 S3 Inc - 86C260 V...

Bus 04h

- 00:00 Digital Equipment C...

Bus 05h

- 04:00 Digital Equipment C...

Bus 06h

- Multifunctional device (Br...
- 04:00 Brooktree Corp
- 04:01 Brooktree Corp

Bus 03h

Information | PCI Registers | PCI Registers form

PCI1250 PC card CardBus Controller
CardBus Bridge
Bus 00h : Device 0Ch : Function 00h

Vendor ID : 104Ch (Texas Instruments (TI))
Device ID : AC16h (PCI1250 PC card CardBus Contro...
SubVendor ID : 0E11h (Compaq)
SubDevice ID : B048h (Unknown)
Revision ID : 02h

Base class code : 06h (Bridge Device)
Sub-class code : 07h ((CardBus Bridge)
Programming interface : 00h ((CardBus Bridge)

Header Type : 82h (CardBus bridge, Multiple functio...
Built-In Self-Test : No

Bridging Information

PCI bus number : 00h
CardBus bus number : 04h **PCI Bus Numbering**
Subordinate bus number : 06h

Filter Settings

Reg.	Type	Base	Limit	Size	Comment
0	Mem	No window open			
1	Mem	D0000000h	D01FFFFFFh	00200000h	2 MB. Prefetchable.
0	I/O	No window open			
1	I/O	No window open			

Resource Allocation

CardBus socket Registers/ExCA

Base address Register : 7FFFFFF00h (Locate anywhere in 32 bit

Interrupt Line : IRQ 11 (0Bh)
Interrupt Pin : INTA

Device Configuration

Command register : 07h

I/O space access : Enabled **It's a good sign if any of these read "Enabled"**
Memory space access : Enabled
Bus master : Enabled
Special cycles operations : Disabled
Memory write and invalidate : Disabled

You should save this data as a file on your computer. Please include your name and date as part of the file name with an extension of ".bpd." This file should be included as an attachment when submitting a Technical Support request at www.magma.com/support.

Returning Merchandise to Magma

If factory service is required, a Service Representative will give you a Return Merchandise Authorization (RMA) number. Put this number and your return address on the shipping label when you return the item(s) for service. **Magma will return any product that is not accompanied by an RMA number.** Please note that Magma WILL NOT accept COD packages, so be sure to return the product freight and duties-paid.

Ship the well-packaged product to the address below:

MAGMA RETURNS DEPT.
RMA # _____
9918 Via Pasar
San Diego, CA 92126
USA

It is not required, though highly recommended, that you keep the packaging from the original shipment of your Magma product. However, if you return a product to Magma for warranty repair/ replacement or take advantage of the 30-day money back guarantee, you will need to package the product in a manner similar to the manner in which it was received from our plant. Magma cannot be responsible for any physical damage to the product or component pieces of the product that are damaged due to inadequate packing. Physical damage sustained in such a situation will be repaired at the owner's expense in accordance with Out of Warranty Procedures. Please, protect your investment, a bit more padding in a good box will go a long way to insuring the device is returned to use in the same condition you shipped it in. Please call for an RMA number first.

APPENDIX A Compliance

FCC

This equipment has been tested and found to comply with the limits for a Class B digital device, pursuant to Part 15 of the FCC rules. These limits are designed to provide reasonable protection against harmful interference in a residential installation. This equipment generates uses and can radiate radio frequency energy and, if not installed and used in accordance with the instructions, may cause harmful interference to radio communications. However there is no guarantee that interference will not occur in a particular installation. If this equipment does cause harmful interference to radio or television reception, which can be determined by turning the equipment off and on, the user is encouraged to try to correct the interference by one or more of the following measures:

- Reorient or relocate the receiving antenna
- Increase the separation between the equipment and receiver
- Connect the equipment into an outlet on a circuit different from that to which the receiver is connected
- Consult the dealer or an experienced radio/TV technician for help. Magma is not responsible for radio/TV interference caused by using unauthorized cables or by making unauthorized changes to this equipment.

Changes or modifications not expressly approved by the party responsible for compliance could void the user's authority to operate the equipment.

Industry Canada

This Class B digital apparatus complies with Canadian ICES-003.

Cet appareil numérique de la classe B est conforme à la norme NMB-003 du Canada

CE



The product(s) described in this manual complies with all applicable European Union (CE) directives. Magma will not retest or recertify systems or components that have been reconfigured by customers.



M A G M A





WUNTRONIC

Mess, Steuer- und Regelgeräte GmbH

Heppstrasse 30 . D-80995 München

Phone: +49 (89) 313 30 07

Fax: +49 (89) 314 67 06

Internet: <http://www.wuntronic.de>

E-Mail: info@wuntronic.de

Free Manuals Download Website

<http://myh66.com>

<http://usermanuals.us>

<http://www.somanuals.com>

<http://www.4manuals.cc>

<http://www.manual-lib.com>

<http://www.404manual.com>

<http://www.luxmanual.com>

<http://aubethermostatmanual.com>

Golf course search by state

<http://golfingnear.com>

Email search by domain

<http://emailbydomain.com>

Auto manuals search

<http://auto.somanuals.com>

TV manuals search

<http://tv.somanuals.com>