



## **Getting Started**

### **Compaq Presario 4000, 6000, and 8000 Series Computers**

Document Part Number: 274894-001

**March 2002**

This book helps you get acquainted with the features of your computer and provides solutions to problems should they occur.

© 2002 Compaq Information Technologies Group, L.P.

Compaq, the Compaq logo, and Presario are trademarks of Compaq Information Technologies Group, L.P. in the United States and other countries.

Microsoft, MS-DOS, Windows, and Windows NT are trademarks of Microsoft Corporation in the United States and other countries.

Compaq shall not be liable for technical or editorial errors or omissions contained herein. The information in this document is provided "as is" without warranty of any kind and is subject to change without notice. The warranties for Compaq products are set forth in the express limited warranty statements accompanying such products. **Nothing herein should be construed as constituting an additional warranty.**



**WARNING:** Text set off in this manner indicates that failure to follow directions could result in bodily harm or loss of life.

---



**CAUTION:** Text set off in this manner indicates that failure to follow directions could result in damage to equipment or loss of information.

---

Getting Started  
First Edition (March 2002)  
Document Part Number: 274894-001

---

# Contents

<b>1</b>	<b>Getting Information and Updates</b>	
	Limited Warranty .....	1-2
	Replacing Parts .....	1-2
	Upgrading the Computer .....	1-2
	Using the Documentation Library CD .....	1-3
	Locating SoftPaq Information .....	1-4
	Using Compaq Advisor .....	1-4
<b>2</b>	<b>A Look at the Computer</b>	
	Front Panel Components .....	2-1
	4000 Series .....	2-1
	6000 Series .....	2-3
	8000 Series .....	2-4
	Rear Panel Components .....	2-6
	4000 Series .....	2-6
	6000 Series .....	2-8
	8000 Series .....	2-10
	Mouse Components .....	2-12
	Installing the Wireless Wheel Mouse .....	2-13
	Using the Scroll Mouse .....	2-14
	Using the Wireless Wheel Mouse .....	2-14
	Using the USB Optical Mouse .....	2-15
	Keyboard Components .....	2-16
	Easy Access Keyboard Components .....	2-16
	Using the Easy Access Buttons .....	2-17
	Customizing the Easy Access Buttons .....	2-19
	Smart Card Keyboard Components .....	2-20
	Using the Smart Card Feature .....	2-21

### **3 Using the Computer**

Inserting and Removing a Diskette . . . . .	3-1
Inserting and Removing a CD or DVD Disc . . . . .	3-2
Installing Additional Software . . . . .	3-3
Installing Software from a CD, DVD, or Diskette . . . . .	3-3
Installing Software from the Internet . . . . .	3-4
Customizing Your Computer Interface . . . . .	3-5

### **4 Internal Computer Components**

Accessing Internal Computer Components . . . . .	4-1
4000 Series . . . . .	4-1
6000 Series . . . . .	4-3
8000 Series . . . . .	4-4
Upgrading or Replacing Computer Memory . . . . .	4-6

### **5 Help & Support**

Preventative Care and Maintenance . . . . .	5-1
Online Service and Support . . . . .	5-3
How to Access Help . . . . .	5-3
Solving Minor Problems . . . . .	5-4
Audio . . . . .	5-5
CD-ROM, CD-RW, DVD-ROM, or DVD-R/RW Drive . . . . .	5-6
Diskette Drive . . . . .	5-8
Hard Drive . . . . .	5-11
Display (Monitor) . . . . .	5-11
Hardware Installation Problems . . . . .	5-12
Internet Access . . . . .	5-13
Power . . . . .	5-15
Keyboard and Scroll Mouse . . . . .	5-17
Wireless Wheel Mouse . . . . .	5-19
USB Optical Mouse . . . . .	5-20
Memory . . . . .	5-21
Miscellaneous . . . . .	5-22

### **Index**

---

## Getting Information and Updates

Information is available in several forms: printed documents, electronic documents on the CD that came with your computer, and the Compaq Web site. Use this guide as your first point of reference, and then refer to the following documents:

- *Quick Setup* poster
- Limited Warranty
- *Documentation Library* CD
- *Compaq Presario Times* Newsletter (North America only)



---

The Compaq Web site is available worldwide. As you explore the Internet, go to the **compaq.com/athome** Web site for information about products, services, and exciting activities.

---

For the fastest path to the right answers, go to **compaq.com/consumersupport**.

At this site you will find online services to assist with your hardware and software related questions, issues, and product needs.

When escalating a service event online, it is important to include the following information in your inquiry. Please take a moment to write down the following information for your future reference.

- **Product Name:** \_\_\_\_\_
- **Model Name:** \_\_\_\_\_
- **Serial Number:** \_\_\_\_\_
- **Date of Purchase:** \_\_\_\_\_

## Limited Warranty

The warranty details the Compaq commitment to repair or replace parts during the computer's warranty period and lists important Compaq telephone numbers. *In the event of a mechanical problem, contact Compaq, not the retailer who sold you the computer.*

Keep the warranty in a safe place for future reference.

## Replacing Parts

For hardware upgrade and installation instructions, refer to the documentation included with the hardware component or to the *Hardware Reference Guide* on the *Documentation Library* CD that came with your computer. Compaq recommends that you print the instructions on the *Documentation Library* CD to make the installation process easier.

If you experience a problem and are unable to resolve the issue after referring to the *Hardware Reference Guide*, contact Technical Support. If the technician determines a replacement part is necessary, you will be sent the replacement part with illustrated instructions for removing the factory-installed part and replacing it.

## Upgrading the Computer

You can expand your computer performance with hardware upgrades, such as memory and additional peripherals, such as a digital camera and a printer. To view options available from Compaq, visit the online store at (not available in all regions):

**[compaq.com/athome/accessories](http://compaq.com/athome/accessories)**

For more information on upgrading memory, refer to “Upgrading or Replacing Computer Memory” in this guide or refer to the *Hardware Reference Guide* on the *Documentation Library* CD that came with your computer. Compaq recommends that you print the instructions on the *Documentation Library* CD to make the installation process easier.

## Using the Documentation Library CD

The *Documentation Library* CD included with your computer contains several guides:

- *Hardware Reference Guide* – Contains information specific to your computer model. It includes an illustrated quick reference to all exterior components as well as information on upgrading or replacing internal components.
- *Learning More About Your Computer* – Contains basic information on using your computer's hardware and software features.
- *Troubleshooting Guide* – Contains troubleshooting topics for advanced computer users.
- *Internet Communications Guide* – Contains basic information on using the features of the Internet.
- *Safety & Regulatory Information* – Provides governmental and safety guidelines.
- *Safety & Comfort Guide* – Suggests ways to set up a safe and comfortable work area and includes ergonomic and safety information about using your computer.



Compaq recommends that you print the guides on the *Documentation Library* CD when referencing them.

---

To access the documents on the *Documentation Library* CD:

1. Insert the *Documentation Library* CD into the CD drive. The CD will run automatically and the main page will be displayed with a list of the documents on the CD.



If the CD does not run automatically, click the **Start** button, select **Run**, and type **E:\CPQRefLib.exe** (where **E** represents the letter of your CD drive).

---

2. Click on the desired document to access that document.

## Locating SoftPaq Information

You can download original product drivers, the latest updates and software fixes (also known as *SoftPaqs*<sup>™</sup>) by going to the Web site **compaq.com/consumersupport** and choosing “Drivers & Downloads.”

When prompted, be prepared to enter your computer’s product type, model, series, and operating system to access the *SoftPaqs* for your particular computer. Follow the instructions in the Readme.txt file or at the download site to install your software update.

Compaq can also automatically deliver *SoftPaqs* to ensure your computer works at its optimal level. Use Compaq Update to automatically receive the latest *SoftPaqs* directly from Compaq. Press the Easy Access **Help ?** button for further information and direct access to *SoftPaqs* for your computer.

## Using Compaq Advisor

Compaq Advisor (not available in all regions) is an intelligent software application on your computer that makes your computer smarter by providing relevant and timely information to you about:

- Your computer’s functionality
- Proactive notification of potential service issues
- Enhancements for your computer
- Special offers

To begin receiving the benefits of Compaq Advisor, enable Advisor by double-clicking the **Launch Compaq Advisor** icon on your desktop, or click **Start > Programs > Compaq Advisor > Run Advisor**.

After Advisor is enabled, you can change Compaq Advisor settings by clicking **Start > Programs > Compaq Advisor > Advisor Settings**.



---

## A Look at the Computer

### Front Panel Components

The components on the front of your computer will vary depending on the model you purchased. Take a look at the following illustrations to get acquainted with the front panel features of your computer model.

#### 4000 Series

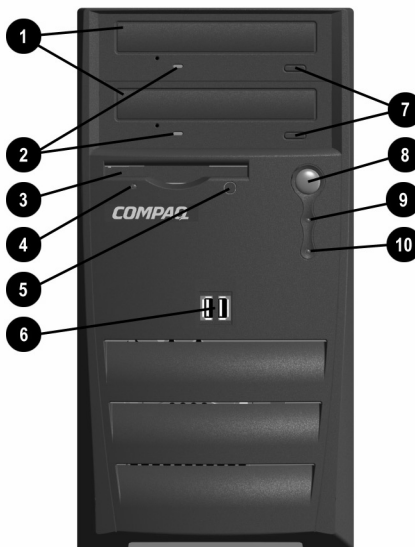

---

## Front Panel Components - 4000 Series

---

❶	Optical Drives	Depending on your computer model, this may be a CD-ROM, CD-RW, or DVD-ROM drive. If a second optical drive is not installed, a removable blank bezel is provided.
❷	Optical Drive Activity Lights	When lit, indicates the optical drive is being accessed.
❸	Diskette Drive	Reads and writes information onto a 3.5-inch diskette.
❹	Diskette Drive Activity Light	When lit, indicates the diskette drive is being accessed. (Do not remove the diskette while the light is on.)
❺	Diskette Eject Button	Ejects the diskette from the diskette drive.
❻	USB (Universal Serial Bus) Ports	Connects USB peripheral devices, such as gamepads, joysticks, and video cameras.
❼	Optical Drive Eject Button	Releases the optical drive disc tray.
❽	Power Button	Turns on the computer. To turn off the computer, use the operating system "Turn Off Computer" command.
❾	Power-On Light	When lit, indicates the power is turned on.
❿	Hard Drive Activity Light	When lit, indicates the hard drive is being accessed.
	Arrangement and number of drives and connectors may vary by model.	

---

## 6000 Series

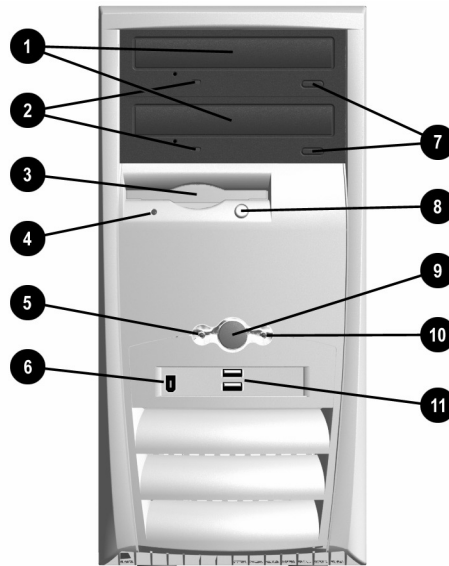

### Front Panel Components - 6000 Series

❶	Optical Drives	Depending on your computer model, this may be a CD-ROM, CD-RW, DVD-ROM, or DVD-R/RW drive.
❷	Optical Drive Activity Lights	When lit, indicates the optical drive is being accessed.
❸	Diskette Drive	Reads and writes information onto a 3.5-inch diskette.
❹	Diskette Drive Activity Light	When lit, indicates the diskette drive is being accessed. (Do not remove the diskette while the light is on.)
❺	Power-On Light	When lit, indicates the power is on.
❻	1394 Port (available on select models)	Connects digital video equipment and allows fast data transfer to your computer.
❼	Optical Drive Eject Buttons	Releases the optical drive disc tray.

---

### Front Panel Components - 6000 Series (*Continued*)

---

⑧	Diskette Eject Button	Ejects the diskette from the diskette drive.
⑨	Power Button	Turns on the computer. To turn off the computer, use the operating system "Turn Off Computer" command.
⑩	Hard Drive Activity Light	When lit, indicates the hard drive is being accessed.
⑪	USB (Universal Serial Bus) Ports	Connects USB peripheral devices, such as gamepads, joysticks, and video cameras.

 Arrangement and number of drives and connectors may vary by model.

---

## 8000 Series

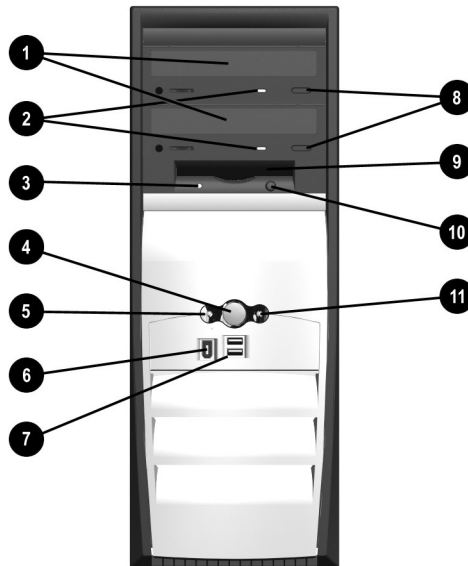

---

## Front Panel Components - 8000 Series

---

❶	Optical Drives	Depending on your computer model, this may be a CD-ROM, CD-RW, DVD-ROM, or DVD-R/RW drive.
❷	Optical Drive Activity Lights	When lit, indicates that the optical drive is being accessed.
❸	Diskette Drive Activity Light	When lit, indicates the diskette drive is being accessed. (Do not remove the diskette while the light is on.)
❹	Power Button	Turns on the computer. To turn off the computer, use the operating system "Turn Off Computer" command.
❺	Power-On Light	When lit, indicates the power is on.
❻	1394 Port (available on select models)	Connects digital video equipment and allows fast data transfer to your computer.
❼	USB (Universal Serial Bus) Ports	Connects USB peripheral devices, such as gamepads, joysticks, and video cameras.
❽	Optical Drive Eject Buttons	Release the optical drive disc trays.
❾	Diskette Drive	Reads and writes information onto a 3.5-inch diskette.
❿	Diskette Eject Button	Ejects the diskette from the diskette drive.
⓫	Hard Drive Activity Light	When lit, indicates the hard drive is being accessed.
	Arrangement and number of drives and connectors may vary by model.	

---

## Rear Panel Components

The components on the rear of your computer will vary depending on the model you purchased. Take a look at the following illustrations to get acquainted with the rear panel features of your computer model.



Some components have color-coded connectors that match the ports on the rear of your computer. Refer to the *Quick Setup* poster that came with your computer for more information on connecting computer components.

---

### 4000 Series

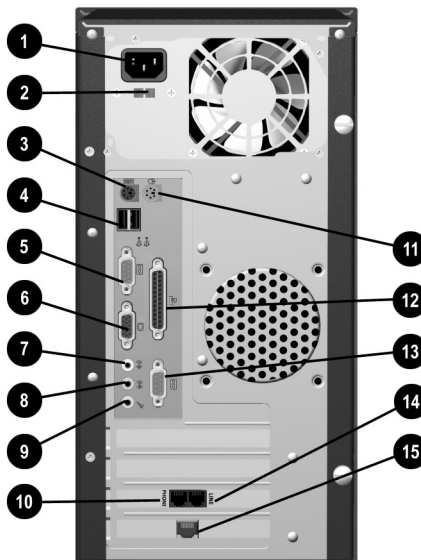

---

## Rear Panel Components - 4000 Series

---

❶	Power Cord Connector	Connects the computer's power cord.
❷	Voltage Select Switch (available on select models)	Selects 230 volts (for some areas of Asia, Africa, Australia, and Europe) or 115 volts (for North America, South America, and Japan). This switch may be factory set to 230 volts. Before plugging the power cord into an electrical outlet be sure the switch is set to your regional requirement.   Failure to set the switch to the correct regional voltage requirement may damage your internal components.
❸	PS/2 Keyboard Connector	Connects a PS/2-compatible keyboard.
❹	USB (Universal Serial Bus) Ports	Connects USB devices, such as a USB keyboard, mouse, or pointing device.
❺	Serial Port	Connects a serial peripheral device, such as a scanner.
❻	VGA Connector	Connects the monitor to the computer.
❼	Audio Line-Out Connector	Connects stereo speakers.
❽	Audio Line-In Connector	Connects audio devices.
❾	Microphone Connector	Connects a microphone.
❿	Modem Port	Connects the modem cable. A modem cable is included with your computer.
⓫	PS/2 Mouse Connector	Connects a PS/2-compatible mouse or other pointing device.
⓬	Parallel Port	Connects a parallel device, such as a printer.
⓭	Second Serial Port	Connects a serial peripheral device.
⓮	Telephone Extension (not available in all countries)	Connects a telephone cable to the computer.
⓯	Network Interface Card (NIC) Connector (available on select models)	Connects to an Ethernet network cable. A network cable is not included with the computer.



Arrangement and number of connectors may vary by model.

---

## 6000 Series

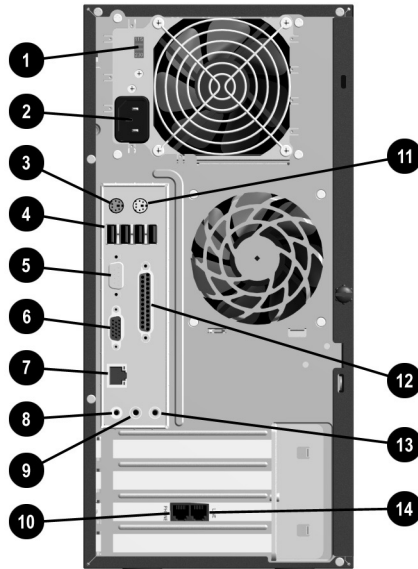

---

### Rear Panel Components - 6000 Series

---

- |          |   |   |
|----------|---|---|
| <b>❶</b> | Voltage Select Switch<br>(available on select models) | Selects 230 volts (for some areas of Asia, Africa, Australia, and Europe) or 115 volts (for North America, South America, and Japan). This switch may be factory set to 230 volts. Before plugging the power cord into an electrical outlet be sure the switch is set to your regional requirement. |
|----------|---|---|

 Failure to set the switch to the correct regional voltage requirement may damage your internal components.



- |          |                         |                                      |
|----------|-------------------------|--------------------------------------|
| <b>❷</b> | Power Cord Connector    | Connects the computer's power cord.  |
| <b>❸</b> | PS/2 Keyboard Connector | Connects a PS/2-compatible keyboard. |
-



---

**Rear Panel Components - 6000 Series (Continued)**

---

④	USB (Universal Serial Bus) Ports	Connects USB devices, such as a USB keyboard, mouse, or pointing device. The number of USB ports on your computer will vary depending on your model.
⑤	Serial Port	Connects a serial peripheral device, such as a scanner.
⑥	VGA Connector	Connects the monitor to the computer.  Depending on your model, the VGA connector may be located on the VGA card in the expansion slot.
⑦	Network Interface Card (NIC) Connector	Connects to an Ethernet network cable. A network cable is not included with the computer.
⑧	Audio Line-Out Connector	Connects stereo speakers.
⑨	Audio Line-In Connector	Connects audio devices.
⑩	Modem Port	Connects the modem cable. A modem cable is included with your computer.
⑪	PS/2 Mouse Connector	Connects a PS/2-compatible mouse or other pointing device.
⑫	Parallel Port	Connects a parallel device, such as a printer.
⑬	Microphone Connector	Connects a microphone.
⑭	Telephone Extension (not available in all countries)	Connects a telephone cable to the computer.
 Arrangement and number of connectors may vary by model.		

---

## 8000 Series

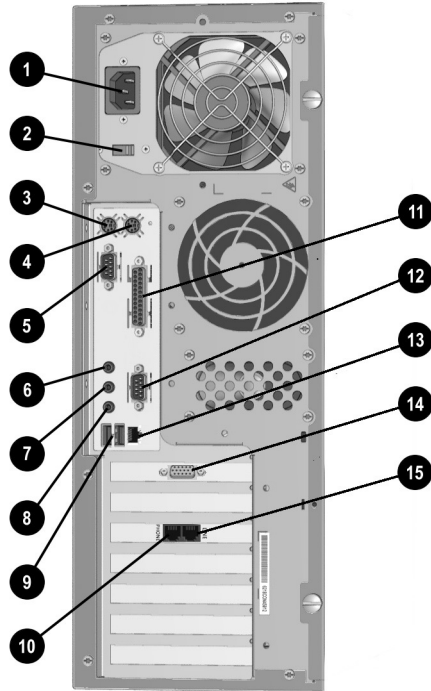

---

## Rear Panel Components - 8000 Series

---

❶	Power Cord Connector	Connects the computer's power cord.
❷	Voltage Select Switch (available on select models)	Selects 230 volts (for some areas of Asia, Africa, Australia, and Europe) or 115 volts (for North America, South America, and Japan). This switch may be factory set to 230 volts. Before plugging the power cord into an electrical outlet be sure the switch is set to your regional requirement.
		 Failure to set the switch to the correct regional voltage requirement may damage your internal components.
❸	PS/2 Keyboard Connector	Connects a PS/2-compatible keyboard.
❹	PS/2 Mouse Connector	Connects a PS/2-compatible mouse or other pointing device.
❺	Serial Port	Connects a serial peripheral device, such as a scanner.
❻	Audio Line-Out Connector	Connects stereo speakers.
❼	Audio Line-In Connector	Connects audio devices.
❽	Microphone Connector	Connects a microphone.
❾	USB (Universal Serial Bus) Ports	Connects USB devices, such as a USB keyboard, mouse, or pointing device.
❿	Modem Port	Connects a modem cable. A modem cable is included with your computer.
⓫	Parallel Port	Connects a parallel device, such as a printer.
⓬	Second Serial Port	Connects a serial peripheral device.
⓭	Network Interface Card (NIC) Connector	Connects to an Ethernet network cable. A network cable is not included with your computer.
⓮	VGA Connector	Connects the monitor to the computer.
⓯	Telephone Extension (not available in all countries)	Connects a telephone cable to the computer.

 Arrangement and number of connectors may vary by model.

---

## Mouse Components

Your computer includes a Scroll Mouse, a Wireless Wheel Mouse, or a USB Optical Mouse. The Wireless Wheel Mouse and USB Optical Mouse are available with select models.



Your mouse can be customized for a left-handed user from the Mouse Properties dialog box. Click on **Start** then click **Control Panel**. Click **Printers and Other Hardware** then click on the **Mouse** icon to open the Mouse Properties dialog box.

---



---

### Mouse Components

---

❶	Left Mouse Button	Click and quickly release to make screen selections. Double-click and quickly release to open applications and files.
❷	Scroll Wheel	Moves the screen backward and forward through a document without having to continuously move the mouse or mouse wheel.
❸	Right Mouse Button	Click and quickly release to display application menu selections.

---

## Installing the Wireless Wheel Mouse

Follow the instructions below to install your wireless wheel mouse (available on select models only).



Before using your wireless wheel mouse, refer to the Comfort Guidelines on the Logitech Web site at: [logitech.com/cf/support/comfortguide.cfm](http://logitech.com/cf/support/comfortguide.cfm)

1. Remove the battery compartment cover by pressing the tab on the bottom of the mouse **1** and sliding off the cover **2**.
2. Insert the two AAA alkaline batteries **3** according to the diagram inside the battery compartment.
3. Turn off your computer.
4. Connect the receiver cable to the PS/2 port **4** on the back of your computer.
5. Turn on your computer.
6. Establish communication between the mouse and the receiver by pressing the Connect button **5** on the receiver, then pressing the Connect button **6** under the mouse.

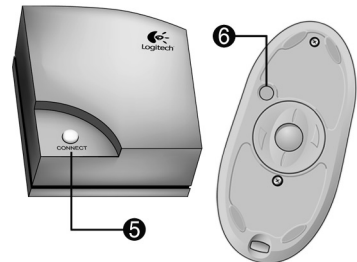
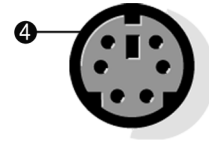
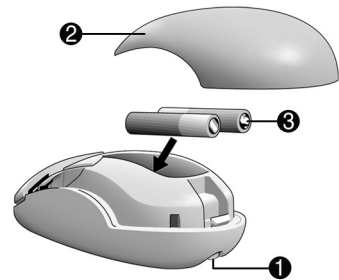

## Using the Scroll Mouse

The mouse directs the cursor on the Windows desktop. Use the mouse to move quickly or easily through a document or Web site.

Moving the scroll wheel on your mouse through a document or Web site is faster than using the scroll bar. You can use the scroll wheel to:

- Scroll forward or backward through a document or Web site by turning the scroll wheel forward or backward.
- Autoscroll by pressing down on the scroll wheel until it clicks (you will see an autoscroll icon on your desktop). Move the mouse vertically, horizontally, or diagonally to scroll in the desired direction. The farther you move the cursor from the starting point icon, the faster the scrolling occurs. To stop autoscrolling, press any mouse button.



Some mouse functions, such as autoscrolling, may not work with all software.

---

## Using the Wireless Wheel Mouse

The wireless wheel mouse is available with select models. It has the same scroll features and functions as the Scroll Mouse with the addition of a receiver box.

When using the wireless wheel mouse:

- Replace the batteries approximately every six months. The wireless wheel mouse does not alert you when the batteries are low.
- For optimal performance, place the receiver at least eight inches (twenty centimeters) away from other electrical devices, such as the computer, the computer monitor, or external storage devices.
- Refer to the “Solving Minor Problems” section in this guide if your wireless wheel mouse does not function properly.

## Using the USB Optical Mouse

The USB optical mouse is available with select models. It provides the same functions as the scroll mouse and wireless wheel mouse except it uses an optical sensor instead of a mechanical ball to determine the position of the cursor on the screen. The surface on which you use the optical mouse plays an important role in tracking the cursor. When using the optical mouse:

- Use a mousepad or a white sheet of paper underneath your mouse. Using it on a glass or see-through surface will inhibit the ability of the sensor to track the cursor.
- Avoid using the mouse on a reflective surface such as a mirror or shiny metal disk. This may cause tracking problems.
- Some wood grains and grooved surfaces may also cause tracking problems.
- Refer to the “Solving Minor Problems” section in this guide if your optical mouse does not function properly.

## Keyboard Components

Your computer includes a Compaq PS/2 Easy Access Keyboard or a Compaq USB Smart Card Keyboard. The Smart Card Keyboard is available with select models and in some regions.

### Easy Access Keyboard Components

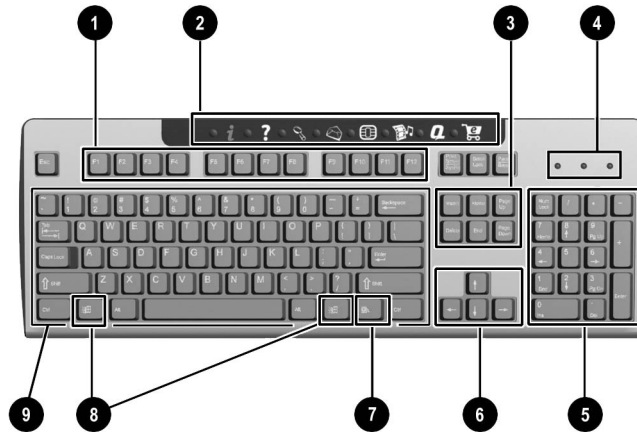

---

### Easy Access Keyboard Components

---

❶	Function Keys	Perform special functions, depending on the software application being used.
❷	Easy Access Buttons	Provide quick access to your favorite Web sites, services, and applications.
❸	Editing Keys	Includes the following: Insert, Home, Page Up, Delete, End, and Page Down.
❹	Status Lights	Indicates a quick status of your computer and keyboard settings (Num Lock, Caps Lock, and Scroll Lock).
❺	Numeric Keys	Works like a calculator keypad.

---



---

## Easy Access Keyboard Components (*Continued*)

---

⑥	Arrow Keys	Used for games or to navigate through a document or Web site. These keys allow you to move left, right, up, and down, using the keyboard instead of the mouse.
⑦	Application Key*	Used (like the right mouse button) to open pop-up menus in a Microsoft Office application. May perform other functions in other software applications.
⑧	Windows Logo Keys*	Used to open the Start menu in Microsoft Windows. Used in combination with other keys to perform other functions.
⑨	Main Keys	Used like standard typewriter-style keys.

---

\*Keys available in select geographic regions.

---

## Using the Easy Access Buttons

The Easy Access Buttons make accessing your favorite Web sites, services, and applications easier and faster.



---

Several Easy Access Buttons are programmed to default to an Internet Web site when pressed. However, until you set up your Internet Service Provider (ISP), the buttons will take you to a window that guides you through the ISP setup process.



---



---

## Easy Access Buttons

---







①	<b>i</b>	Instant Internet	Provides your daily starting point to the Internet. It connects you to a customizable Web page filled with local weather, news, sports, and financial information.
②	<b>?</b>	Help	Takes you to the Compaq Help & Support Center, which provides information about your computer. You can find information about your computer and computer-related peripherals as well as access links to online technical support.
③		Search	Accesses a Web site that helps you to locate news and information on the Internet. Search for topics including news and information, shopping, graphics, music, and video.
④		E-mail	Launches your e-mail application.

---

---

## Easy Access Buttons (*Continued*)

---

6	 	Smart Card or Community	<p>Depending on your region, this button launches the Smart Card or the Compaq online Community.</p> <ul style="list-style-type: none"> <li>• The Smart Card button is available on U.S. English keyboards. When pressed, it provides information on obtaining a Smart Card and/or shopping at participating online merchants. Refer to “Smart Card Keyboard Components” in this chapter for additional information.</li> <li>• Community provides online collaboration between novice and technical experts, who share knowledge and information and provide assistance. Participate in existing product discussions, review commonly asked questions, and answer or post new questions to a community of users.</li> </ul>
6		Entertainment	Your online connection to the world of entertainment, featuring music downloads, streaming video, Web casts, entertainment news, and reviews.
7		My Compaq PC	Takes you to the My Presario Web site.
8		Retail/Affinity Central	Provides an instant connection to your computer store and a variety of leading consumer companies.
 Easy Access Button functions may vary by model and by region.			

## Customizing the Easy Access Buttons

All Easy Access Buttons can be reprogrammed to open any software application or data file on your hard drive, or any Internet address.

To reprogram the Easy Access Buttons, complete the following steps:

1. Double-click the keyboard icon in the notification area (lower right corner) of the Windows taskbar. The Keyboard Properties dialog box is displayed.
2. Click the **Help** button on the Keyboard Properties dialog box for instructions.

## Smart Card Keyboard Components

The Compaq USB Smart Card Keyboard (available with select models in some regions) has the same features as the Easy Access Keyboard with some additional Smart Card features.

The Smart Card features provide you with online shopping convenience and security. If you have a Smart Card or when you receive your Smart Card, you can insert your card into the terminal on the keyboard, enter a PIN number and make purchases from participating online merchants.



---

The Smart Card Keyboard is classified as a low power USB device that should be connected directly to one of the USB ports on the front or back of your computer. If an optional external USB hub is used, it must be a powered external USB hub.

---

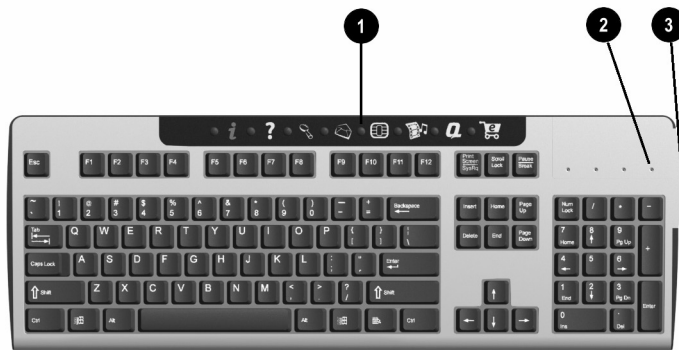

---

### Smart Card Keyboard Components

---

- |   |                           |   |
|---|---------------------------|---|
| ❶ | Smart Card Button         | Press this button to apply for a Smart Card and/or shop online at many of the participating online merchants. |
| ❷ | Smart Card Activity Light | When lit, indicates that you have inserted your Smart Card into the terminal.                                 |
| ❸ | Smart Card Terminal       | Insert your Smart Card into the terminal (face up) to purchase merchandise online.                            |
-

## Using the Smart Card Feature

The Smart Card feature makes it easy for you to purchase merchandise online.

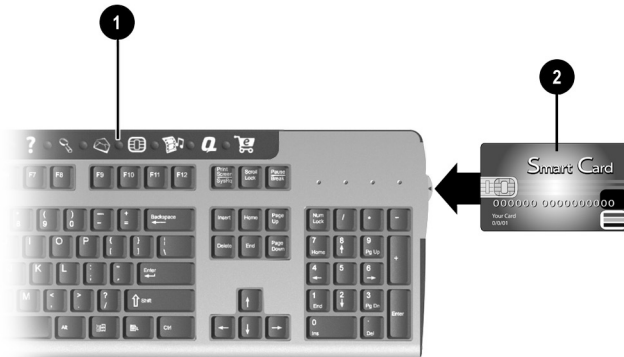

To apply for a Smart Card or use your Smart Card to shop at participating online merchants:

1. Press the **Smart Card** button ❶. This button launches a Web site with instructions on obtaining your Smart Card.
2. When you receive your Smart Card and want to purchase merchandise online, insert your card into the Smart Card terminal, when prompted, with the front of the card facing up ❷.
3. Follow the on-screen instructions to complete the transaction.

The Smart Card Keyboard comes with a non-payment Smart Card, the **Presario Internet Smart Card powered by Netissimo®**, which enables a value added Internet utility. The Internet utility will:

- Intelligently auto-sense and dial the default Internet connection on the Presario desktop computer.
- Securely log you into online accounts with automatic population of Web aliases and passwords.
- Automatically allow you to access and store Web site favorites.
- Provide access to Web site destinations containing specialized content and offers for Smart Card Keyboard users.



---

## Using the Computer

### Inserting and Removing a Diskette

The diskette drive (also known as a floppy drive) uses a 3 1/2" diskette (or floppy disk) to store files. A diskette can hold up to 1.44 MB of data. Once information is copied onto a diskette, it remains there until you delete or overwrite it.

To insert or remove a diskette from the drive, follow the procedure below.

1. Hold the diskette with the label facing up and the arrow on the diskette pointing toward the drive; then gently push the diskette into the drive.

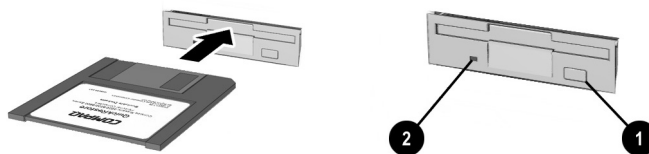

#### *Inserting and Removing a Diskette*

2. To remove a diskette, press the Eject button ❶ on the diskette drive.



**CAUTION:** Wait until the diskette drive activity is complete (the activity light ❷ stops glowing) before removing a diskette. Removing a diskette when the drive is reading from or writing to the diskette can damage the diskette or the information stored on it.



Remove the diskette from the drive prior to shutting down Microsoft Windows. If you do not remove the diskette, your computer will not start until you remove the diskette from the drive.

## Inserting and Removing a CD or DVD Disc

Your computer may have a CD-ROM, CD-RW, DVD-ROM, and/or DVD-R/RW drive, depending on the model you purchased.

- The CD-ROM drive enables you to read data from a CD or listen to a music CD.
- The CD-RW drive enables you to read and write data to a CD, and enables you to listen to music CDs or read data CDs.
- The DVD-ROM drive enables you to view your favorite movies, listen to music, or read information from CDs.
- The DVD-R/RW drive enables you to view your favorite movies, record your own movies, listen to music, or read information from CD or DVD discs.

To insert or remove a CD or DVD disc from the drive, follow the procedure below.



---

Your computer must be turned on before you can insert or remove a CD or DVD disc.

---

1. Press the Load/Eject button to open the drive.

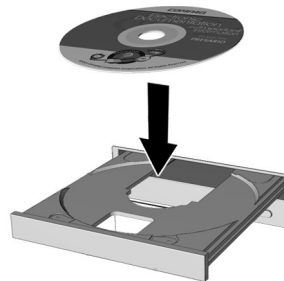
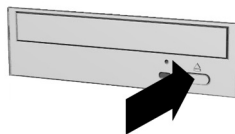

### **Inserting a CD or DVD disc**

2. Carefully lift the disc from the CD case. Hold the disc by the edges and the center hole only to avoid touching the surface.
3. Place the disc, label side facing up, into the round area of the tray.
4. Press the Load/Eject button to close the drive.
5. To remove the disc, press the Load/Eject button to open the drive.





---

Make sure to store CD and DVD discs that are not in use in their protective cases.

---

## Installing Additional Software

You may want to purchase and install additional software. Software can be installed from a CD, DVD, diskette, or downloaded from a Web site.

Follow the installation instructions provided with the software. In the event of difficulties with the installation, contact the software manufacturer.



---

When selecting software for your computer, make sure the packaging states that it is compatible with your version of the Microsoft Windows operating system, your computer memory, processor, and available hard drive space.

---

## Installing Software from a CD, DVD, or Diskette

The installation process begins automatically when you insert the CD or DVD into the disc drive. If the installation process does not begin automatically, refer to the documentation that came with the software. If no documentation exists, follow the procedure listed here to install software from a CD, DVD, or diskette.

1. Close all open programs.
2. On the Windows desktop, click **Start** then click **Control Panel**.
3. Double-click the **Add or Remove Programs** icon. The Add or Remove Programs window is displayed.
4. Click **Add New Programs**.
5. Click the **CD or Floppy** button.
6. Insert the CD or diskette into the proper drive and click **Next**. Microsoft Windows begins the installation process.

## Installing Software from the Internet

If you download software from a Web site, follow the installation instructions that are usually displayed on the Web page. If installation instructions are not available, complete the steps listed here.



---

**CAUTION:** Before downloading files of any kind from the Internet, make sure that call-waiting is disabled and that your anti-virus utility is running. If the download process is interrupted, you must restart the entire download procedure from the beginning.

---

1. Before you start downloading, note the location on the hard drive where the files will be stored. Also, be sure that you have enough hard drive space available.
2. Close all other open programs.
3. On the Windows desktop, click **Start** then click **Control Panel**.
4. Double-click the **Add or Remove Programs** icon. The Add or Remove Programs window is displayed.
5. Click **Add New Programs**.
6. Click the **CD or Floppy** button.
7. Click the **Next** button.
8. Click the **Browse** button.
9. Locate (as noted in Step 1) and select the executable file (.exe) for the downloaded software.
10. Click **Open** to begin the installation process.

## Customizing Your Computer Interface

If you have trouble reading the screen, hearing sounds, using the keyboard, or moving the mouse, you can adjust the settings to make your computer more accessible.

You can use the Accessibility Wizard to automatically adjust your text size, monitor display, sound, and mouse pointer. Just answer a few questions in the Accessibility Wizard and your computer will be reconfigured to fit your needs. To start the Accessibility Wizard:

1. On the Windows desktop, click **Start**.
2. Point the cursor to **All Programs**, then to **Accessories**, then **Accessibility**.
3. Click **Accessibility Wizard**. The Accessibility Wizard begins.
4. Follow the on-screen instructions.

If you would like to customize your keyboard, display, sound, and mouse functions yourself, follow the directions below.

1. On the Windows desktop, click **Start** then click **Control Panel**.
2. Click **Accessibility Options** then click **Accessibility Options** again.
3. Adjust the keyboard, sound, display, and mouse settings to fit your needs.



---

# Internal Computer Components

## Accessing Internal Computer Components

Follow the procedures listed below to access the internal components for your computer model.



---

For detailed instructions on upgrading and replacing internal computer components, see the *Hardware Reference Guide* on the *Documentation Library* CD included with your computer. Compaq recommends that you print these instructions to make the installation process easier.

---

### 4000 Series

Follow the procedure below to access the internal components of your 4000 Series computer.



---

**CAUTION:** Static electricity can damage the electronic components of your computer or optional equipment. Before beginning these procedures, ensure that you are discharged of static electricity by briefly touching a grounded metal object.

---

1. Remove all diskettes, CDs, and DVDs from the computer.
2. To shut down the computer, click the **Start** button, and then click **Turn Off Computer**. The Turn Off Computer dialog box is displayed. Select **Turn Off** to turn the computer off.
3. Disconnect the power cord from the electrical outlet and then from the computer.



**WARNING:** To reduce the risk of personal injury from electrical shock and/or hot surfaces, be sure to disconnect the power cord from the wall outlet, and allow the internal system components to cool before touching.

---

4. Disconnect all peripheral device cables from the computer.
5. Remove the access panels by loosening the screws that secure the access panels to the computer chassis **1**. Slide the access panels back from the unit **2**.

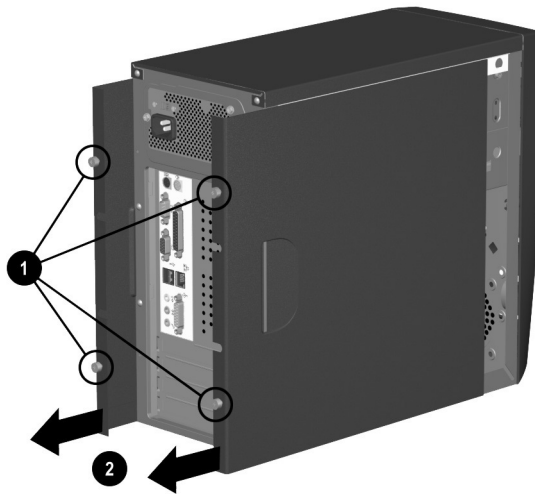

### ***Removing the 4000 Series Access Panels***

6. Turn the computer on its side with the open side facing up to access the internal components.

## 6000 Series

Follow the procedure below to access the internal components of your 6000 Series computer.



---

**CAUTION:** Static electricity can damage the electronic components of your computer or optional equipment. Before beginning these procedures, ensure that you are discharged of static electricity by briefly touching a grounded metal object.

---

1. Remove all diskettes, CDs, and DVDs from the computer.
2. To shut down the computer, click the **Start** button, and then click **Turn Off Computer**. The Turn Off Computer dialog box is displayed. Select **Turn Off** to turn the computer off.
3. Disconnect the power cord from the electrical outlet and then from the computer.



---

**WARNING:** To reduce the risk of personal injury from electrical shock and/or hot surfaces, be sure to disconnect the power cord from the wall outlet, and allow the internal system components to cool before touching.

---

4. Disconnect all peripheral device cables from the computer.
5. Lay the computer on its side with the access panel (the side with the pull grip) facing up.

6. Remove the access panel by loosening the screw that secures the access panel to the computer chassis ❶. Slide the access panel back about 1 inch (2.54 centimeters), then lift it up and off the unit ❷.

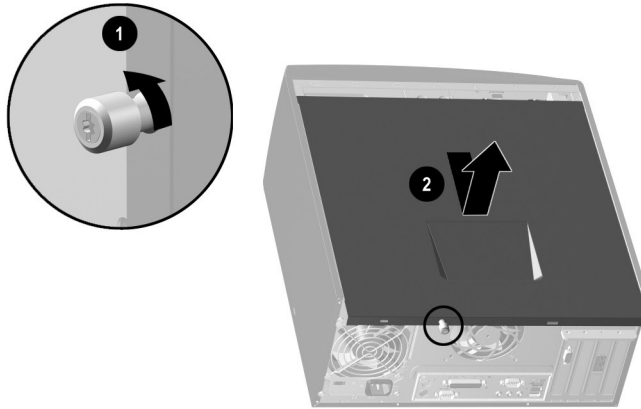

### ***Removing the 6000 Series Access Panel***

## **8000 Series**

Follow the procedure below to access the internal components of your 8000 Series computer.



**CAUTION:** Static electricity can damage the electronic components of your computer or optional equipment. Before beginning these procedures, ensure that you are discharged of static electricity by briefly touching a grounded metal object.

---

1. Remove all diskettes, CDs, and DVDs from the computer.
2. To shut down your computer, click the **Start** button, and then click **Turn Off Computer**. The Turn Off Computer dialog box is displayed. Select **Turn Off** to turn the computer off.
3. Disconnect the power cord from the electrical outlet and then from the computer.





**WARNING:** To reduce the risk of personal injury from electrical shock and/or hot surfaces, be sure to disconnect the power cord from the wall outlet, and allow the internal system components to cool before touching.

4. Disconnect all peripheral device cables from the computer.
5. With the computer lying on its side, loosen the two screws that secure the access panel to the computer chassis **1**. Slide the access panel back about 1 inch (2.54 centimeters), then lift it up and off the unit **2**.

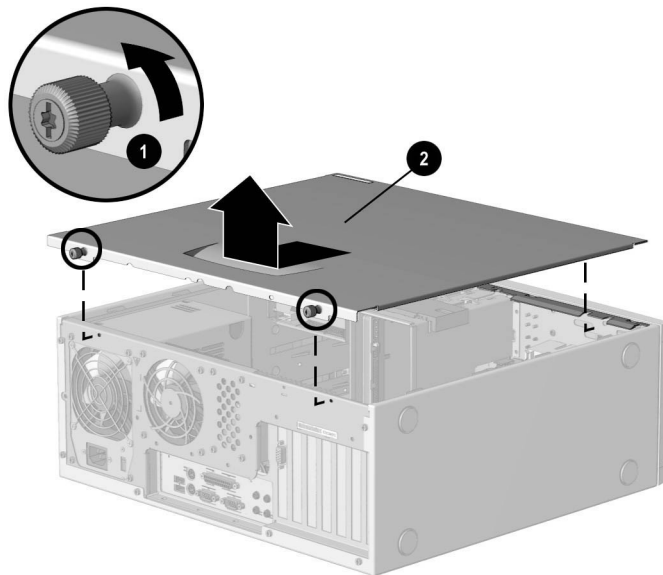

***Removing the 8000 Series Access Panel***

## Upgrading or Replacing Computer Memory

Complete the following procedure to replace or add a memory module.



**CAUTION:** When handling a memory module, be careful not to touch any of the contacts. Doing so may damage the module.

---



Upgrade the memory in your computer with memory of the same type and speed as the memory originally installed in your computer. You can find out exactly what type of memory is in your computer at the following Web site (not available in all languages):

**[compaq.com/athome/memory](http://compaq.com/athome/memory)**

---

1. Complete the “Accessing Internal Computer Components” process for your computer model.
2. Open both ends of the memory module socket ①.

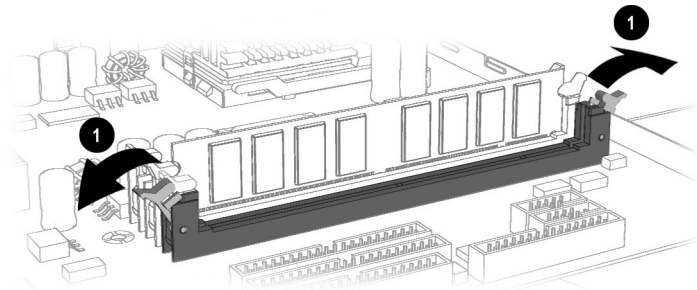

### ***Opening the Latches on the Memory Module Socket***

---



If you are replacing a memory module, remove the old memory and put the new memory module in the same memory slot from which the old memory was removed.

---



If you are adding a memory module, install the new module into the socket nearest the preinstalled module.

3. Align the memory module ❶ with the memory slot. The memory module can be installed in only one way. Match the notch on the module with the tab on the memory socket ❷. Push the module carefully and firmly into the slot ensuring that the latches ❸ on both ends snap into place.

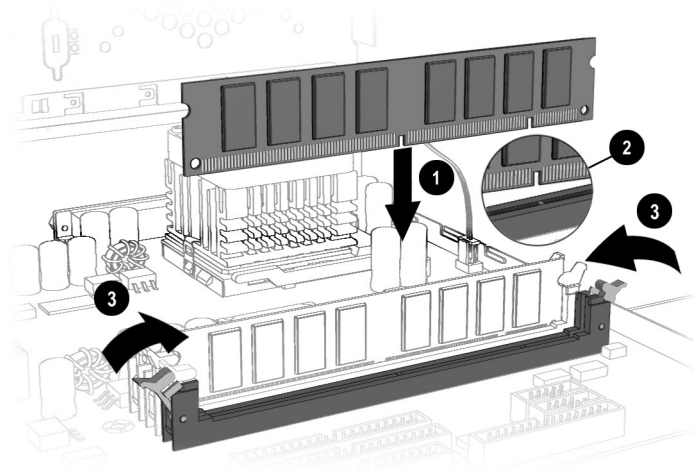

### ***Installing a Memory Module***

4. Reassemble the computer and turn on the power.



If a blank screen is displayed after replacing or adding a memory module, the memory is installed incorrectly or it is the wrong type of memory. Repeat the above procedure to return your computer to its original state.



---

## Help & Support

This chapter provides information for identifying and solving common problems that may occur with your computer. You can easily diagnose and solve many computer problems on your own without contacting a Compaq Support Specialist.

If you have a computer problem or question, check the following resources for answers:

- Review this “Help & Support” chapter for suggestions to solve the problem.
- Press the Easy Access **Help ?** button on the keyboard to access the built-in Compaq Help & Support Center, where you can find information about your computer and computer-related peripherals as well as links to online technical help.
- Visit the Compaq Help & Support Web site at:  
**compaq.com/consumersupport**
- Contact a Compaq Support Specialist at the telephone number listed in your Limited Warranty.



The Web sites listed in this chapter may be specific to certain regions and English only.

---

## Preventative Care and Maintenance

Your computer is equipped with an integrated help and assistance tool from Microsoft and Compaq, providing simple click access to built-in product information, preventative care and maintenance assistance, and Web links to online support and technical information. Press the Easy Access **Help ?** button on your keyboard to access the Compaq Help & Support Center.

- **Prevent unnecessary data loss:** Protect your valuable data and system files from possible damage by utilizing the virus protection software available on your computer along with backing up important data and programs.
- **Undo harmful or unintended changes to your system:** Your computer comes with restore features to help protect your computer from unnecessary downtime. Return your computer to its optimal state using one of the provided restore features.
- **Adjust your startup resources to improve performance:** Compaq has engineered an exclusive utility, called a Virtual Technician, which helps you safely manage your computer's system performance and resources.
- **Troubleshoot modem or Internet connection issues:** Test your modem line connection for slow or poor connection speeds, as well as troubleshoot common modem problems.
- **Improve hard drive performance:** Perform a series of easy tasks to help remove unwanted files, repair simple hard drive errors, increase the amount of free space on your hard drive, and improve the overall speed and performance of your computer.
- **Reprogram your Easy Access buttons:** Launch your favorite programs and Web sites by easily reprogramming the Easy Access buttons (select models only) on your Compaq keyboard.
- **Receive automatic delivery of drivers, software updates, and fixes:** Receive notifications and automatic updates to help improve functionality and ensure your computer runs at peak performance.
- **Learn more about how to replace end-user parts:** The End User Replaceable Parts Program (not available in all regions) is part of the Limited Warranty. Leveraging the easy access design, the End User Replaceable Parts Program enables you to easily service your own computer.

## Online Service and Support

For rapid access to accurate solutions, go to **compaq.com/consumersupport**. Whether you are a novice or technical expert, knowledge, information, and assistance are available when and where you need them.

- **Need access to drivers and product documentation?** Find original product drivers, the latest updates and software fixes, warranty information, and product documentation.

**web14.compaq.com/falco/sp\_list.asp**

- **Join the Compaq Customer Communities:** Where novices to technical experts collaborate to share knowledge, information, and assistance. Participate in existing product discussions, review commonly asked questions, and answer or post new questions to a community of users.

**compaq.com/communities**

- **Open an online service event with a Compaq Support Specialist:** Do you have a product warranty issue or need to contact a technical expert? Contact Compaq online for the fastest time to a solution. To ensure proper handling of your service event, please include your:

- Product model number
- Product serial number
- Date of purchase
- Detailed description of your issue or question

**compaq.com/athome/support/consumeremail.html**

## How to Access Help

The first step when you need help is to press the **Help ?** button on your keyboard, giving you access to an integrated help and assistance tool from Microsoft and Compaq. The Compaq Help & Support Center provides a wealth of help and assistance, especially when you need:

- Answers to questions about your hardware or software

- Help installing new peripherals or software applications
- A resolution to a hardware or software problem or error
- To restore your computer and undo harmful changes
- Access to the latest drivers, updates, and downloads

If you want interactive help or didn't find exactly what you were looking for, go to the Compaq Help & Support Web site at **compaq.com/consumersupport**. The Compaq Help & Support Web site is the fastest way to find accurate solutions by providing:

- Original product drivers and the latest software updates
- Warranty information and product documentation
- Questions, answers, and insights through the Compaq Customer Communities, **compaq.com/communities**
- E-mail responses from a Compaq Support Specialist

If additional methods of getting assistance and resolving a problem are needed, try the following:

- Contact a Compaq Support Specialist at the telephone number listed in your Limited Warranty with the following information available:
  - Product model number
  - Product serial number
  - Date of purchase
- Restore the operating system and software to its original state as when you purchased the computer by using your Compaq Restore Kit. Refer to your Compaq Restore Kit for complete instructions on using this feature.

## Solving Minor Problems

Before contacting a Compaq Support Specialist, keep in mind that the information needed to correct the problem may be at your fingertips. Try pressing the Easy Access **Help ?** button on the keyboard. This button accesses important help and support information and tools.

Information in this section is divided into three areas: Symptom, Problem, and Solution.



The **Symptom** indicates the sign or warning message for the type of problem you are having. The **Problem** identifies one or more reasons why the symptom may have occurred. The **Solution** describes what you should do to try to solve the problem.



Some of the symptoms listed for certain troubleshooting problems will not apply to your computer. For problems relating specifically to the monitor or printer, refer to the documentation that came with the equipment.

## Audio

Symptom	Problem	Solution
No sound	Speaker cables are not properly connected.	Turn off your computer using the normal "Turn Off Computer" procedure. Reconnect the speakers. Refer to the <i>Speaker Options</i> poster for instructions.
	Volume is muted.	<ol style="list-style-type: none"> <li>On the Windows desktop, click <b>Start</b> then click <b>Control Panel</b>. The Control Panel window is displayed.</li> <li>Click <b>Sounds, Speech, and Audio Devices</b> then click <b>Sounds and Audio Devices</b>.</li> <li>Click the <b>Mute</b> check box to remove the check mark from the box.</li> </ol>
	Computer is in Stand By mode.	Press the <b>Power</b> button to resume from Stand By mode.

---

## CD-ROM, CD-RW, DVD-ROM, or DVD-R/RW Drive

---

Symptom	Problem	Solution
CD-ROM, CD-RW, DVD-ROM, or DVD-R/RW drive cannot read a disc or takes too long to start.	CD has been inserted upside down.	Re-insert the CD with the label facing up.
	The DVD-ROM drive takes longer to start because it has to determine the type of media being played, such as audio or video.	Wait at least 30 seconds to let the DVD-ROM drive determine the type of media being played. If the disc still does not start, read the other solutions listed in this topic.
	CD or DVD disc is dirty.	Clean CD or DVD with a CD cleaning kit, available from most computer stores.

---

---

**CD-ROM, CD-RW, DVD-ROM, or DVD-R/RW Drive (Continued)**

---

Symptom	Problem	Solution
	Windows does not detect CD-ROM or DVD-ROM driver.	<ol style="list-style-type: none"> <li>1. On the Windows desktop, click <b>Start</b> then click <b>Control Panel</b>. The Control Panel window is displayed.</li> <li>2. Click <b>Performance and Maintenance</b> then click <b>System</b>.</li> <li>3. Click the <b>Hardware</b> tab then click the <b>Device Manager</b> button.</li> <li>4. Click the plus sign + next to the CD/DVD-ROM drives, and select the drive you are having a problem with.</li> <li>5. Click the <b>Action</b> menu item and select <b>Uninstall</b>.</li> <li>6. Restart your computer, and let Windows detect the CD or DVD driver.</li> </ol>
Recording audio CDs is difficult or impossible.	Wrong or poor quality media type.	Verify that you are using the correct media for the drive. Try a different brand of media. Quality varies widely between manufacturers.

---

---

## Diskette Drive

---

Symptom	Problem	Solution
Unable to read the diskette.	A non-formatted diskette has been inserted.	To format the diskette: <ol style="list-style-type: none"><li>1. On the Windows desktop, click <b>Start</b> then click <b>My Computer</b>. The My Computer window is displayed.</li><li>2. Right-click on the <b>3 1/2 Floppy (A:)</b> icon.</li><li>3. Select <b>Format</b> from the pop-up menu.</li><li>4. Select the desired options and click <b>Start</b> to begin formatting the diskette.</li></ol>
	Diskette is damaged.	Replace the diskette with a new one.
“Invalid system disk” message is displayed.	A diskette has been left in the drive.	When drive activity stops, remove the diskette and press the <b>Spacebar</b> . The computer should start up.
	Diskette error has occurred.	Restart your computer by pressing the <b>Power</b> button.
Diskette drive light stays on.	Diskette has been improperly inserted.	Remove the diskette and reinsert it as follows: Insert the edge with the sliding cover into the drive, face up, and push the diskette all the way in until it stops.

---

---

**Diskette Drive (Continued)**

---

Symptom	Problem	Solution
	Diskette drive is damaged.	Press the <b>Help ?</b> button on the keyboard to access the Compaq Help & Support Center or refer to your Limited Warranty for details.
Diskette drive cannot save information to the diskette.	Diskette is not formatted.	To format the diskette: <ol style="list-style-type: none"> <li>1. On the Windows desktop, click <b>Start</b> then click <b>My Computer</b>. The My Computer window is displayed.</li> <li>2. Right-click on the <b>3 1/2 Floppy (A:)</b> icon.</li> <li>3. Select <b>Format</b> from the pop-up menu.</li> <li>4. Select the desired options and click <b>Start</b> to begin formatting the diskette.</li> </ol>
	Diskette is write-protected.	Slide the write-protection tab to the unlocked position on the diskette.
	Diskette is full or the file is too big.	Use another diskette or compress the file to reduce the size.
	Diskette is damaged.	Replace the damaged diskette.
	File Save command not properly executed.	When saving information to the diskette drive, verify that you are using the correct drive letter.

---

---

### Diskette Drive (*Continued*)

---

Symptom	Problem	Solution
Diskette drive cannot read a diskette.	Diskette drive has failed.	Press the <b>Help ?</b> button on the keyboard to access the Compaq Help & Support Center or refer to your Limited Warranty for details.
	Diskette is not formatted.	To format the diskette: <ol style="list-style-type: none"><li>1. On the Windows desktop, click <b>Start</b> then click <b>My Computer</b>. The My Computer window is displayed.</li><li>2. Right-click on the <b>3 1/2 Floppy (A:)</b> icon.</li><li>3. Select <b>Format</b> from the pop-up menu.</li><li>4. Select the desired options and click <b>Start</b> to begin formatting the diskette.</li></ol>
Drive not found.	Cable is loose.	Press the <b>Help ?</b> button on the keyboard to access the Compaq Help & Support Center or refer to your Limited Warranty for details.

---

---

## Hard Drive

Symptom	Problem	Solution
Computer seems to be locked up.	Program in use has stopped responding to commands.	Attempt the normal Windows "Turn Off Computer" procedure. If this fails, press the <b>Power</b> button for four or more seconds to turn off the power. To restart your computer, press the <b>Power</b> button again.
Hard drive error message is displayed.	Part of hard drive has failed or is about to fail.	Press the <b>Help ?</b> button on the keyboard to access the Compaq Help & Support Center or refer to your Limited Warranty for details.

---

## Display (Monitor)

Symptom	Problem	Solution
 If you encounter display problems, refer to the documentation that came with your monitor and to the common causes and solutions listed in this table.		
Screen is blank, and monitor power light is not lit.	Monitor power cable is not connected to the monitor or to the wall outlet.	Reconnect the power plug on the back of the monitor and on the wall outlet.
	Monitor is not turned on.	Press the <b>Power</b> button on the front of the monitor.
Screen is blank.	Monitor connector cable is not properly connected to the back of the computer.	Inspect the monitor video connector for bent pins. If no pins are bent, reconnect the monitor connector cable on the back of the computer.

---

### Display (Monitor) *(Continued)*

---

Symptom	Problem	Solution
	Screen saver is enabled.	Press any key or move the mouse to make the screen display visible again.
	Computer is in Stand By mode.	Press the <b>Power</b> button to resume from Stand By mode.

---

---

### Hardware Installation Problems

---

Symptom	Problem	Solution
A new device is not recognized as part of the system.	Device is not seated or connected properly.	Ensure that the device is properly and securely connected and that pins in the connector are not bent down.
	Cable(s) of new external device are loose or power cables are unplugged.	Ensure that all cables are properly and securely connected and that pins in the cable or connector are not bent down.
	Power switch of new external device is not turned on.	Turn off the computer, turn on the external device, then turn on the computer to integrate the device with the computer system.

---



---

**Hardware Installation Problems (Continued)**

---

Symptom	Problem	Solution
	When the system advised you of changes to the configuration, you did not accept them.	Reboot the computer and follow the instructions for accepting the changes.
	A plug and play board may not automatically configure when added if the default configuration conflicts with other devices.	Deselect the automatic settings in the Operating System for the board and choose a basic configuration that doesn't cause a resource conflict. You can also use Computer Setup to reconfigure or disable devices to resolve the resource conflict.

---



---

**Internet Access**

---

Symptom	Problem	Solution
Cannot connect to the Internet.	Internet Service Provider (ISP) account is not set up properly.	Verify Internet settings or contact your ISP for assistance.
	Modem is not set up properly.	Reconnect the modem, verifying the following connections: telephone line to telephone (for external phone sets) and telephone line to wall jack (from computer to wall).
	Web browser is not set up properly.	Verify that the Web browser is installed and set up to work with your ISP.

---

---

## Internet Access (*Continued*)

---

Symptom	Problem	Solution
Cannot automatically launch Internet programs.	You must log in to your ISP before some programs will start.	Log in to your ISP and launch the desired program.
Internet takes too long to download Web sites.	Modem is not set up properly.	Verify that the correct modem speed and COM port are selected: <ol style="list-style-type: none"><li>1. Click <b>Start</b> then click <b>Control Panel</b>. The Control Panel window is displayed.</li><li>2. Click <b>Printers and Other Hardware</b>.</li><li>3. Click <b>Phone and Modem Options</b>.</li><li>4. Select the <b>Modems</b> tab then click the <b>Properties</b> button.</li><li>5. Under <b>Device status</b>, verify the modem is working properly.</li><li>6. Under <b>Device usage</b>, verify the modem is enabled.</li><li>7. If there are further problems, click the <b>Troubleshoot</b> button and follow the on-screen instructions.</li></ol>

---

---

**Power**

---

Symptom	Problem	Solution
Computer will not turn on.	Line voltage selection switch is not in the proper position for your region (115V/230V).	Set the line voltage selection switch to the correct setting for your region, or call Compaq Technical Support for assistance. Refer to your Limited Warranty for details.
	Computer is not connected to an external power source.	Connect to an external power source. Ensure that cables connecting the computer to the external power source are plugged in properly.
	Drive power, data, or power supply cables may not be properly connected.	Reseat drive power, data, and power supply cables.
	Wall outlet is defective.	Test the outlet by connecting a different electrical device to the outlet.
“Illegal Operation has Occurred” error message is displayed.	Software being used is not Microsoft-certified for your version of Windows.	Verify that the software is certified by Microsoft for your version of Windows (see program packaging for this information).
	Configuration files are corrupt.	If possible, save all data, close all programs, and restart your computer. If the error message returns, press the <b>Help ?</b> button on the keyboard to access the Compaq Help & Support Center and select <b>Undo harmful or unintended changes to your system.</b>

---

---

**Power (Continued)**

---

<b>Symptom</b>	<b>Problem</b>	<b>Solution</b>
Computer will not start.	System files may have been damaged.	Refer to your Compaq Restore Kit or your Limited Warranty for details.
	Wrong memory modules were used in the upgrade, or memory modules were installed in the wrong location.	Reinstall the old memory to return your computer to its original state. Refer to "Upgrading or Replacing Computer Memory" in this guide for instructions.
	Hard drive is damaged.	Refer to your Limited Warranty for details.
Computer appears locked up and won't turn off when the power button is pressed.	Software control of the power switch is not functional.	Press and hold the power button for at least 4 seconds until the computer turns off.
Computer powered off automatically.	The unit temperature was exceeded. The fan may be blocked.	<ol style="list-style-type: none"><li>1. Unit is in an exceedingly hot environment. Let it cool down.</li><li>2. Ensure computer air vents are not blocked and internal fan is running.</li></ol>
	The unit temperature was exceeded because the computer was functioning with the cover or access panel removed.	Replace cover or access panel, and let the computer cool down before attempting to turn on power to the computer.
	Processor or system fan has failed.	Contact a Compaq Support Specialist.

---

---

## Keyboard and Scroll Mouse

---

Symptom	Problem	Solution
Keyboard commands and typing are not recognized by the computer.	Keyboard connector is not properly connected.	<ol style="list-style-type: none"> <li>1. On the Windows desktop, click the <b>Start</b> button.</li> <li>2. Click <b>Turn Off Computer</b>. The Turn Off Computer dialog box is displayed.</li> <li>3. Select <b>Turn Off</b>.</li> <li>4. After the shutdown is complete, reconnect the keyboard to the back of your computer and restart your computer.</li> </ol>
	Program in use has stopped responding to commands.	Shut down your computer using the mouse. If your mouse cannot activate a shutdown, refer to the problem below: "Mouse connector is not properly plugged into the back of the computer."
	Keyboard is damaged.	Refer to your Limited Warranty for details.
Cursor will not move using the arrow keys on the keypad.	The Num Lock key may be on.	Press the Num Lock key. The Num Lock light should not be on if you want to use the arrow keys.

---

---

## Keyboard and Scroll Mouse (*Continued*)

---

Symptom	Problem	Solution
<p>Mouse does not respond to movement or is too slow.</p>	<p>Mouse connector is not properly plugged into the back of the computer.</p>	<p>Shut down your computer using the keyboard:</p> <ol style="list-style-type: none"> <li>1. Press the <b>Ctrl</b> and <b>Esc</b> keys at the same time (or press the <b>Windows logo</b> key) to display the <b>Start</b> menu.</li> <li>2. Use the up or down arrow key to select <b>Turn Off Computer</b>, and then press the <b>Enter</b> key.</li> <li>3. Use the up or down arrow key to select the <b>Turn Off</b> option, and then press the <b>Enter</b> key.</li> <li>4. After the shutdown is complete, plug the mouse connector into the back of your computer (or the keyboard) and restart your computer.</li> </ol>
	<p>Program in use has stopped responding to commands.</p>	<p>Shut down your computer using the keyboard. Refer to the preceding problem “Mouse connector is not properly plugged into the back of the computer” for details about shutting down using the keyboard.</p>

---

---

**Keyboard and Scroll Mouse (Continued)**

---

Symptom	Problem	Solution
Mouse will only move vertically or horizontally.	Mouse roller ball is dirty.	Remove roller ball cover from bottom of mouse and clean with mouse cleaning kit available from most computer stores.
	Mouse needs repair.	See your Limited Warranty booklet for details.

---

---

**Wireless Wheel Mouse**

---

Symptom	Problem	Solution
Mouse does not work after installation or is not detected.	Receiver is not connected properly.	Try unplugging then reconnecting the receiver cable to your computer. The receiver cable goes into the computer's USB port or, with an adapter, into the PS/2 mouse port.
	Batteries are not installed properly.	Reinstall the batteries according to the diagram inside the battery compartment.
	Communication between receiver and mouse not established.	Press the <b>Connect</b> button on the receiver, then press the <b>Connect</b> button under the mouse.

---

---

### Wireless Wheel Mouse (*Continued*)

---

Symptom	Problem	Solution
Poor reception.	Receiver too close to other electrical devices.	Place the receiver at least 8 inches or 20 centimeters away from other electrical devices, such as the computer, the computer monitor, or external storage devices.  If you are working on a metallic surface, try turning the receiver on its side.
Mouse stops functioning.	Batteries are low.	Replace the batteries.

---

---

### USB Optical Mouse

---

Symptom	Problem	Solution
Mouse does not work after installation or is not detected.	Mouse is not connected properly.	Try unplugging then reconnecting the mouse cable to your computer. The mouse cable goes into the computer's USB port.
	USB port is not working.	Plug the mouse cable into a different USB port on your computer.
Mouse does not track cursor well.	The optical sensor uses the pattern of the surface to track the position of the cursor. Reflective surfaces, grooved surfaced, glass, or other see-through surfaces will inhibit the ability of the sensor to track the cursor.	Place a mousepad or white sheet of paper underneath the mouse while in use.

---



---

## Memory

---

Symptom	Problem	Solution
Insufficient memory message is displayed.	All memory in the computer is being used by open programs, and memory is needed for a desired task.	<ol style="list-style-type: none"><li>1. Press the <b>Help ?</b> button.</li><li>2. Select <b>Adjust your startup resources to improve performance</b> and/or <b>Improve your hard drive performance</b>.</li><li>3. Follow the on-screen instructions.</li></ol>

---

---

## Miscellaneous

---

Symptom	Problem	Solution
Computer date and time display is incorrect.	RTC (real-time clock) battery may need to be replaced. Battery life is approximately 3–5 years.	First, reset the date and time in your operating system. If the problem persists, replace the RTC battery. Contact a Compaq Support Specialist.
Printer problems.	Printer will not print.	If you encounter printer problems, refer to the documentation that came with your printer.

---



1394 port 2-3, 2-5

## A

access panels

4000 Series 4-2

6000 Series 4-4

8000 Series 4-5

accessibility 3-5

accessories 1-2

application key 2-17

arrow keys 2-17

audio

line-in connector 2-7, 2-9, 2-11

line-out connector 2-7, 2-9, 2-11

troubleshooting 5-5

autoscrolling 2-14

## C

CD

inserting a disc 3-2

removing a disc 3-2

CD-ROM drive 3-2

*See also* optical drives

CD-RW drive 3-2

*See also* optical drives

Community button 2-19

Compaq Advisor 1-4

Compaq Restore Kit 5-4

Compaq Support Specialist 5-3, 5-4

Compaq Update 1-4

Compaq Web site 1-1

computer interface changes 3-5

computer upgrades 1-2

connecting components 2-6

## D

diskette

inserting 3-1

removing 3-1

diskette drive

activity light 2-2, 2-3, 2-5

eject button 2-2, 2-4, 2-5

locating 2-2, 2-3, 2-5

troubleshooting 5-8

Documentation Library CD 1-3

drivers and downloads 1-4, 5-1, 5-3

DVD

inserting a disc 3-2

removing a disc 3-2

DVD-R/RW drive 3-2

*See also* optical drives

DVD-ROM drive 3-2

*See also* optical drives

## E

Easy Access Buttons

customizing 2-19

locating 2-16

using 2-17

editing keys 2-16

E-mail button 2-18

End User Replaceable Parts Program 5-2

Entertainment button 2-19

Ethernet 2-7, 2-9, 2-11

## F

floppy disk

*See* diskette

floppy drive

*See* diskette drive

front panel components

- 4000 Series 2-1
- 6000 Series 2-3
- 8000 Series 2-4

function keys 2-16

**H**

hard drive

- activity light 2-2, 2-4, 2-5
- troubleshooting 5-11

hardware installation

- instructions 1-2
- problems 5-12

Hardware Reference Guide 1-3

Help

- accessing 5-3
- keyboard button 2-18, 5-1
- Web site 5-1

Help & Support Center 2-18, 5-1

**I**

Instant Internet button 2-18

internal components

- 4000 Series 4-1
- 6000 Series 4-3
- 8000 Series 4-4

Internet

- access problems 5-13
- Communications Guide 1-3
- downloading software 3-4
- keyboard buttons 2-17
- online service and support 5-3

**K**

keyboard

- components 2-16
- connector 2-7, 2-8, 2-11
- Easy Access Buttons 2-17
- keys 2-16

properties 2-19

Smart Card 2-19, 2-20

status lights 2-16

taskbar icon 2-19

troubleshooting 5-17

**L**

Learning More About Your Computer 1-3

**M**

memory

- replacing 4-6
- troubleshooting 5-21
- upgrading 4-6
- Web site 4-6

microphone connector 2-7, 2-9, 2-11

modem

- port location 2-7, 2-9, 2-11
- troubleshooting 5-2

monitor

- connector 2-7, 2-9, 2-11
- troubleshooting 5-11

mouse

- clicking 2-12
- components 2-12
- customizing 2-12
- double-clicking 2-12
- left button 2-12
- left-handed users 2-12
- optical 2-15
- right button 2-12
- scroll wheel 2-12
- scrolling 2-14
- troubleshooting 5-17, 5-19, 5-20
- using 2-14
- using wireless 2-14
- wireless installation 2-13

My Compaq PC button 2-19

**N**

Network Interface Card (NIC) connector  
2-7, 2-9, 2-11  
numeric keys 2-16

**O**

online  
    community of users 5-3  
    service and support 5-3  
    shopping 2-19, 2-20  
optical drives  
    activity light 2-2, 2-3, 2-5  
    eject button 2-2, 2-3, 2-5  
    locating 2-2, 2-3, 2-5  
    troubleshooting 5-6  
optical mouse  
    troubleshooting 5-20  
    using 2-15

**P**

parallel port 2-7, 2-9, 2-11  
power  
    button 2-2, 2-4, 2-5  
    connector 2-7, 2-8, 2-11  
    indicator light 2-2, 2-3, 2-5  
    troubleshooting 5-15  
Presario  
    documentation 1-1, 1-3  
    Web site 2-19  
preventative care and maintenance 5-1  
PS/2  
    keyboard connector 2-7, 2-8, 2-11  
    mouse connector 2-7, 2-9, 2-11

**R**

rear panel components  
    4000 Series 2-6  
    6000 Series 2-8  
    8000 Series 2-10  
replacing parts 1-2

Retail/Affinity Central button 2-19

**S**

Safety & Comfort Guide 1-3  
Safety & Regulatory Information Guide 1-3  
scrolling 2-14  
Search button 2-18  
serial port 2-7, 2-9, 2-11  
shut down procedure 4-1  
Smart Card  
    activity light location 2-20  
    applying for card 2-21  
    button location 2-19, 2-20  
    keyboard 2-20  
    keyboard components 2-19  
    terminal location 2-20  
    using 2-21  
SoftPaqs 1-4  
software  
    installing from CD, DVD, or diskette 3-3  
    installing from the Internet 3-4  
solving minor problems 5-4  
speaker connector 2-7, 2-9, 2-11  
special offer notification 1-4  
static electricity 4-1

**T**

telephone extension 2-7, 2-9, 2-11  
troubleshooting  
    audio 5-5  
    diskette drive 5-8  
    hard drive 5-11  
    hardware installation 5-12  
    Internet access 5-13  
    keyboard 5-17  
    memory 5-21  
    monitor 5-11  
    mouse 5-17, 5-19, 5-20  
    optical drives 5-6  
    power 5-15

Troubleshooting Guide 1–3

**U**

Universal Serial Bus (USB)

- external hub 2–20
- locating ports 2–2, 2–4, 2–5, 2–7, 2–9, 2–11
- optical mouse 2–15
- Smart Card Keyboard 2–20

**V**

- VGA connector 2–7, 2–9, 2–11
- voltage select switch 2–7, 2–8, 2–11

**W**

- warranty information 1–2, 5–3
- Web sites
  - community 5–3, 5–4

Compaq Support Specialist 5–3

drivers 5–3

Logitech 2–13

memory identification 4–6

My Presario 2–19

products and services 1–1

software fixes 5–3

technical support 1–1, 1–4, 5–1, 5–4

upgrades and accessories 1–2

warranty information 5–3

Windows logo keys 2–17

wireless wheel mouse

installing 2–13

troubleshooting 5–19

using 2–14

## Free Manuals Download Website

<http://myh66.com>

<http://usermanuals.us>

<http://www.somanuals.com>

<http://www.4manuals.cc>

<http://www.manual-lib.com>

<http://www.404manual.com>

<http://www.luxmanual.com>

<http://aubethermostatmanual.com>

Golf course search by state

<http://golfingnear.com>

Email search by domain

<http://emailbydomain.com>

Auto manuals search

<http://auto.somanuals.com>

TV manuals search

<http://tv.somanuals.com>