

ApeosPort-II C7500/C6500/C5400
DocuCentre-II C7500/C6500/C5400

Administrator Guide

Before Using the Machine

Paper and Other Media

Maintenance

Job Status

Machine Status

System Settings

Using CentreWare Internet Services

Printer Environment Settings

E-mail Environment Settings

Scanner Environment Settings

Using the Server Fax Service

Security

Authentication and Auditoron
Administration

Problem Solving

Appendix

Microsoft, Windows, Windows NT, and Windows Server, Windows Vista, and Microsoft Network are trademarks or registered trademarks of Microsoft Corporation in the U.S. and other countries.

NetWare is a registered trademark of Novell, Inc. in the United States and other countries.

Adobe, Acrobat, PostScript, and Adobe PostScript 3 are trademarks of Adobe Systems Incorporated.

EtherTalk, Macintosh, and Mac OS are registered trademarks of Apple Computer, Inc.

PCL, HP-GL, and HP-GL/2 are registered trademarks of Hewlett-Packard Corporation.

RSA, BSAFE are either registered trademarks or trademarks of RSA Security Inc. in the United States and/or other countries.

RSA Security Inc. All right reserved.

All product/brand names are trademarks or registered trademarks of the respective holders.

Permission has been obtained from Microsoft Corporation for use of software screen shots.

For information on license, refer to About License.

The data saved in the hard disk of the machine may be lost if there is any problem in the hard disk. Fuji Xerox is not responsible for any direct and indirect damages arising from or caused by such data loss.

Fuji Xerox is not responsible for any breakdown of machines due to infection of computer virus or computer hacking.

Important

1. This manual is copyrighted with all rights reserved. Under the copyright laws, this manual may not be copied or modified in whole or part, without the written consent of the publisher.
2. Parts of this manual are subject to change without prior notice.
3. We welcome any comments on ambiguities, errors, omissions, or missing pages.
4. Never attempt any procedure on the machine that is not specifically described in this manual. Unauthorized operation can cause faults or accidents. Fuji Xerox is not liable for any problems resulting from unauthorized operation of the equipment.

An export of this product is strictly controlled in accordance with Laws concerning Foreign Exchange and Foreign Trade of Japan and/or the export control regulations of the United States.

XEROX, THE DOCUMENT COMPANY, Ethernet, CentreWare, and the stylized X are registered trademarks of Xerox Corporation. DocuWorks is a trademark of Xerox Corporation and Fuji Xerox Co., Ltd. All Xerox and Fuji Xerox product names are either registered trademarks or trademarks of Xerox Corporation and Fuji Xerox Co., Ltd.

Table of Contents

Table of Contents	1
1 Before Using the Machine	11
Preface	12
Types of Manuals	13
Using This Guide	14
Organization of This Guide	14
Conventions	15
About License	17
RSA BSAFE	17
Heimdal	17
LZMA	17
JPEG Code	18
Libcurl	18
FreeBSD	18
OpenLDAP	19
DES	21
AES	21
2 Paper and Other Media	23
Paper Types	24
Supported Paper Type	24
Loading Paper	27
Loading Paper in the Trays 1 to 2	27
Loading Paper in the Trays 3 to 4	28
Loading Paper in the Tray 5 (Bypass)	29
Loading Tab Paper in the Tray 5 (Bypass)	30
Loading Paper in the Tray 6 (HCF (A4 1 Tray))	30
Loading Paper in the Tray 8 (Interposer)	31
Loading Tab Paper in the Tray 8 (Interposer)	32
Changing the Paper Size	33
Changing the Paper Size for the Trays 1 to 2	33
Changing the Paper Size for the Trays 3 to 4	34
Changing the Paper Size for the Tray 6 (HCF (A4 1 Tray))	35
Changing the Paper Settings	38
3 Maintenance	41
Replacing Consumables	42
Replacing the Toner Cartridge	43
Replacing the Waste Toner Bottle	45
Replacing Drum Cartridge R1 (for customers having a spot maintenance contract)	47

Replacing Drum Cartridge R2/R3/R4 (for customers having a spot maintenance contract).....	51
Replacing the Staple Cartridge for C-Finisher or C-Finisher with Booklet Maker.....	54
Replacing the Booklet Staple Cartridge (C-Finisher with Booklet Maker or Booklet Finisher D2).....	56
Replacing the Staple Cartridge for Booklet Finisher D2	57
Emptying the Punch Scrap Container for C-Finisher or C-Finisher with Booklet Maker.....	59
Emptying the Punch Scrap Container for Booklet Finisher D2	60
Replacing the Staple Scrap Container for Booklet Finisher D2	61
Cleaning the Machine.....	63
Cleaning the Exterior	63
Cleaning the Document Cover and Document Glass	63
Cleaning the Narrow Glass Strip and Document Presser.....	64
Cleaning the Document Feeder Roller	65
Executing Calibration	66
Printing a Report/List.....	70
4 Job Status	71
Job Status Overview	72
Checking Current/Pending Jobs.....	73
Checking Completed Jobs	74
Printing and Deleting Stored Documents	75
Secure Print	75
Sample Print	77
Delayed Print	78
Charge Print.....	79
Private Charge Print	81
Printing Pending Jobs	84
Handling Error Terminations	85
5 Machine Status	87
Overview of Machine Status.....	88
Machine Status.....	89
Machine Information	89
Paper Tray	91
Overwrite Hard Disk.....	91
Print Mode	91
Billing Meter/Print Report	95
Billing Meter	95
User Account Billing Meter	96
Print Report/List.....	97
Automatically Printed Reports/Lists	103
Supplies.....	104

Faults.....	105
6 System Settings.....	107
System Settings Procedure.....	108
Step 1 Entering System Administration Mode	108
Step 2 Entering the System Administrator User ID and Passcode	108
Step 3 Selecting the Operation Mode from the System Administrator Menu.....	109
Step 4 Selecting an Item on the [System Settings] Screen	109
Step 5 Setting a Feature	111
Step 6 Exiting the System Administration Mode	111
System Settings Menu List.....	112
Common Settings	121
Machine Clock/Timers	121
Audio Tones.....	124
Screen/Button Settings	125
Paper Tray Settings	126
Image Quality Adjustment.....	129
Reports	131
Maintenance	132
Watermark	133
Secure Watermark	134
Image Log Control (ApeosPort series models only)	136
Print Universal Unique ID (ApeosPort series models only).....	137
Other Settings	137
Copy Mode Settings	145
General Settings Tab - Features Allocation	145
Preset Buttons	146
Copy Defaults	146
Copy Control	151
Original Size Defaults	153
Reduce/Enlarge Presets.....	153
Custom Colors	153
Annotation - Create Stamps.....	154
Network Settings	155
Port Settings	155
Protocol Settings.....	158
Machine's E-mail Address/Host Name	160
Proxy Server Settings (ApeosPort series models).....	160
Outgoing / Incoming E-mail Settings.....	161
Remote Authentication Server/Directory Service (ApeosPort series models only)	163
PKI Settings (Public Key Infrastructure).....	167
Other Settings	168
Print Mode Settings	169
Allocate Memory	169

Delete Form	171
Other Settings	171
Scan/Fax Mode Settings	174
General Settings Tab	174
Scan Defaults	174
Scan to PC Defaults	176
Original Size Defaults	176
Output Size Defaults	176
Reduce/Enlarge Presets	177
Other Settings	177
E-mail Settings	179
E-mail Control	179
Mailbox Settings	182
Stored Document Settings	183
Job Flow Settings for ApeosPort Series Models Only	185
Web Applications Settings for ApeosPort Series Models Only	186
Server Setup	186
Configuring/Canceling the Auto Link Server	187
Setup Menu	188
Mailbox	188
Job Flow Sheets	190
Job Flow Sheet Keywords	195
Address Book	196
Paper Tray Attributes	199
System Administrator Settings	200
System Administrator Login ID	200
System Administrator's Passcode	200
Maximum Login Attempts	201
Login Setup/Auditron Administration	202
Create/Check User Accounts	202
Account Details	204
Reset User Accounts	205
System Administrator's Meter (Copy Jobs)	205
User Details Setup	205
Charge / Private Print Settings	206
Passcode Entry from Control Panel	208
Login Setup/Auditron Mode	209
7 Using CentreWare Internet Services	211
Installation of CentreWare Internet Services	212
Preparations	212
Configuration on the Machine	212
Starting CentreWare Internet Services	214
Setting Items Using CentreWare Internet Services	215

8 Printer Environment Settings	219
Print Features Overview	220
Installation When Using USB Port.....	223
Preparations.....	223
Installation Overview.....	223
Configuration on the Machine	223
CentreWare Internet Services Setting Items.....	224
Configuration on the Computer	224
Installation When Using TCP/IP (LPD/Port 9100)	225
Preparations.....	225
Installation Overview.....	225
Configuration on the Machine	225
CentreWare Internet Services Setting Items.....	226
Configuration on the Computer	227
Installation When Using NetWare.....	228
Preparations.....	228
Installation Overview.....	228
Configuration on the Machine	228
CentreWare Internet Services Setting Items.....	230
Configuration on the Computer	230
Installation When Using Microsoft Network (SMB).....	231
Preparations.....	231
Installation Overview.....	231
Configuration on the Machine	231
CentreWare Internet Services Setting Items.....	232
Configuration on the Computer	232
Installation When Using Internet Printing Protocol (IPP)	233
Preparations.....	233
Installation Overview.....	233
Configuration on the Machine	233
CentreWare Internet Services Setting Items.....	234
Configuration on the Computer	234
Installation When Using EtherTalk	235
Preparations.....	235
Installation Overview.....	235
Configuration on the Machine	235
CentreWare Internet Services Setting Items.....	236
Configuration on the Computer	236
9 E-mail Environment Settings	237
E-mail Overview	238
Preparations	239
Installation Procedure.....	241
Installation Overview.....	241

Enabling Port and Setting TCP/IP	241
Configuring E-mail Environment	242
CentreWare Internet Services Setting Items	243
10 Scanner Environment Settings	245
Scan Service Overview	246
Configuration of Scan to Mailbox	247
Installation Overview.....	247
Enabling Port and Setting TCP/IP	247
Configuration of Network Scanning (Job Template Scanning).....	249
Preparations	249
Installation Overview.....	249
Enabling Port and Setting TCP/IP	249
Configuring the SNMP Port	250
Configuration of Scan to PC.....	251
Preparations	251
Installation Overview.....	251
Enabling Port and Setting TCP/IP	252
Configuration of the Job Flow.....	253
Installation Overview.....	253
Enabling Port and Setting TCP/IP	253
Configuring the SNMP Port	254
11 Using the Server Fax Service.....	255
Server Fax Overview	256
Preparations	257
System Requirements for the Machine.....	257
Installation Procedure.....	258
Installation Overview.....	258
Setting the Server Fax Feature.....	258
12 Security	261
Security Service Overview	262
Communication Security Service.....	262
Scan File Security Services	263
Configuration of HTTP Communication Encryption.....	264
Installation Overview.....	264
Configuration on the Machine.....	264
Configuration of E-mail Encryption/Digital Signature	266
Installation Overview.....	266
Configuration on the Machine.....	266
Configuration on a Computer.....	267
Configuration of Scan File Signature (PDF/DocuWorks Signature) for Only ApeosPort Series Models.....	269
Installation Overview.....	269

Configuration on the Machine	269
13 Authentication and Auditron Administration.....	271
Overview of Authentication.....	272
Users Controlled by Authentication.....	272
Types of Authentication	272
Features Controlled by Authentication.....	273
Authentication for Job Flow Sheets and Mailboxes.....	275
Job Flow Sheet Types	275
Types of Mailboxes.....	278
Linking Job Flow Sheets to Mailboxes.....	280
Overview of Auditron Administration	282
Authentication and Auditron Administration	282
Manageable Features and Services	283
14 Problem Solving	287
Troubleshooting.....	288
Machine Trouble.....	289
Image Quality Trouble	294
Trouble during Copying	299
Unable to Copy	299
The Copy Result is Not What was Expected	299
Trouble during Printing	303
Unable to Print	303
The Print Result is Not What was Expected	304
Trouble during Scanning	306
Unable to Scan with the Machine	306
Unable to Import Scanned Documents to the Computer	306
Unable to Send a Scanned Document over the Network (FTP/SMB)	307
Unable to Send E-mail.....	309
The Image is not What was Expected	309
Network-related Problems.....	312
When using SMB	312
When using NetWare.....	313
When using TCP/IP	317
When using EtherTalk.....	318
CentreWare Internet Services Problems	319
E-Mail Features Problems	320
Internet/Intranet Connection Problems	321
Error Code	323
Other Errors	365
Paper Jams	366
Paper Jams in the Trays 1 to 2.....	367
Paper Jams in the Tray 3.....	367

Paper Jams in the Tray 4.....	368
Paper Jams in the Tray 5 (Bypass)	368
Paper Jams in the Tray 6 (HCF (A4 1 Tray)).....	369
Paper Jams in the Transfer Module.....	371
Paper Jams in the Bottom Left Cover.....	372
Paper jams in the Bottom Right Cover	373
Paper Jams in the Output Tray.....	374
Paper Jams in the C-Finisher and the C-Finisher with Booklet Maker	374
Paper jams in the Booklet Finisher D2	384
Document Jams	395
Stapler Faults	398
Staple Jams in the Staple Cartridge for C-Finisher or C-Finisher with Booklet Maker.....	399
Staple Jams in the Booklet Staple Cartridge for the C-Finisher with Booklet Maker or Booklet Finisher D2	400
Staple Jams in the Staple Cartridge for the Booklet Finisher D2.....	402
Staple Cartridge Taken Off from Unit for the Booklet Finisher D2	404
Solving Curled Output for the Booklet Finisher D2.....	406
15 Appendix	409
Specifications	410
Printable Area.....	420
Standard Printable Area	420
Extended Printable Area.....	420
Internal Fonts	421
Optional Components.....	423
ESC/P-K Emulation	425
Emulation.....	425
Fonts.....	426
Output Feature.....	426
ESC/P-K Emulation Print Features.....	426
ESC/P-K Emulation Settings	427
Magnification Table.....	433
Paper Size and Number of Printable Characters.....	437
PDF Direct Print	439
PDF Direct Print Settings.....	439
PCL Emulation	441
HP-GL2 Emulation	445
Hard Clip Area	449
Printable Area.....	450
Auto Layout.....	452
Notes and Restrictions	459
Notes and Restrictions on the Use of the Machine.....	459
Notes and Restrictions in the Interrupt Mode	460

Notes and Restrictions when Connecting with Internet Service Provider	461
Notes and Restrictions for Using SMB.....	462
Notes and Restrictions for Using TCP/IP	464
Notes and Restrictions for Using EtherTalk.....	465
Notes and Restrictions for Using Bonjour.....	466
Notes and Restrictions for Using Scanner Features.....	467
Notes and Restrictions when Connecting to Internet or Intranet	468
Index.....	469

1 Before Using the Machine

This chapter describes organization of this guide and conventions.

- Preface 12
- Types of Manuals 13
- Using This Guide 14
- About License 17

Preface

Thank you for selecting the Fuji Xerox ApeosPort-II C7500/C6500/C5400, DocuCentre-II C7500/C6500/C5400 (hereafter referred to as “the machine”).

This guide explains how to operate the machine and the precautions that must be followed during operation. To get the most out of the machine and to use it effectively, be sure to read this guide before use.

This guide aimed toward machine administrators, provides maintenance information like how to replace consumables, instructions on configuring your network environment, and troubleshooting procedures.

This guide assumes that an operator has a basic knowledge of the operating environment of the personal computer in use, networking environments, and how to operate a personal computer. For information on the environment of the personal computer in use, basic knowledge of networking environments, and how to operate a personal computer, refer to the manuals provided with the personal computer, operating system, and network system.

After reading this guide, be sure to keep it handy for quick reference. It will be useful in case you forget how to perform operations or if a problem occurs with the machine.

Refer to the User Guide for copy/print/scan operating procedures. For information about optional accessories for the printer functionality, also refer to the guide provided with each optional accessory.

In this manual, safety instructions are preceded by the symbol . Always read and follow the instructions before performing the required procedures.

The equipment is certified by NEMKO in compliance with [IEC60950-1 (AS/NZS 3260)]. The equipment is manufactured under an ISO 9001 Quality System. The equipment is also certified in compliance with applicable standards by various national bodies.

The equipment was tested and is certified by the New Zealand Ministry of Commerce in conformance with CISPR publ. 22 (AS/NZISS CISPR22:2002) which relates to radio frequency interference regulations, and also complies with the Australian Communication Authority requirements.

NOTE: Machines intended for use in South Korea and Taiwan have been certified separately in compliance with their requirements.

Any unauthorized alteration, which includes the addition of new functions or the connection of external devices, may impact this certification.

Contact your local Xerox representative for a list of approved accessories.

Types of Manuals

We provide the following guides for optimum usage of the machine.

Included Manuals

Several manuals are included with this product. They are referred to as accompanying manuals.

These accompanying manuals include descriptions on configurations and operation of the product.

The following manuals are included with the machine.

■ User Guide

Describes all the necessary steps for copy/print/scan.

■ Administrator Guide (this guide)

Aimed toward machine administrators, as a guide to setting up the network environment and to solving problems that may occur with the machine.

■ Quick Reference Guide

Introduces the basic operations of the machine, as well as daily management and maintenance.

■ Manual (HTML)

A guide for installing print drivers, configuring the printer environment, etc. This manual is included in the CD-ROM of the Driver CD Kit.

Guides for Optional Accessories

Optional accessories are also available for the machine. User Guides are provided with the optional accessories exclusively for ApeosPort-II C7500/C6500/C5400, DocuCentre-II C7500/C6500/C5400. These User Guides are referred to as "guides for optional accessories". Guides for optional accessories are provided in two forms, as printed or as On-line Help.

Guides for optional accessories describe all the necessary steps for operating optional accessories and installing software.

Using This Guide

This guide aimed toward machine administrators, provides maintenance information like how to replace consumables, instructions on configuring your network environment, and troubleshooting procedures.

Organization of This Guide

This guide consists of the following chapters.

■ **1 Before Using the Machine**

Describes organization of this guide and conventions.

■ **2 Paper and Other Media**

Describes the types of paper that can be used on the machine and how to load paper in trays.

■ **3 Maintenance**

Describes how to replace consumables and to clean the machine.

■ **4 Job Status**

Describes how to check job status and to cancel jobs.

■ **5 Machine Status**

Describes how to check the faults that occurred on the machine and to print various reports/lists.

■ **6 System Settings**

Describes how to configure the system settings.

■ **7 Using CentreWare Internet Services**

Describes how to use CentreWare Internet Services.

■ **8 Printer Environment Settings**

Describes how to set up the printer's operating environment.

■ **9 E-mail Environment Settings**

Describes the configuration to use the E-mail features on the machine.

■ **10 Scanner Environment Settings**

Describes the configuration to use the scan services on the machine.

■ **11 Using the Server Fax Service**

Describes how to use the Server Fax service on this machine.

■ **12 Security**

Describes the configuration to utilize the security services on the machine.

■13 Authentication and Auditor Administration

Describes the authorization feature for restricting use of the machine, as well as the administration feature for monitoring usage statuses for each feature using the authorization feature.

■14 Problem Solving

Describes troubles that may occur with the machine and their solutions.

■15 Appendix

Describes the machine specifications, optional accessories, and cautions/restrictions.

Conventions

- The screen images and illustrations that are used in this guide are based on the machine configuration with the various options. Some of the items in the screen images may not be displayed or there may be features that cannot be used depending on the machine configuration.
- In this document, "Computer" refers to a personal computer or workstation.
- The following terms are used in this guide:
 - Important : Indicates important information that you should read.
 - Note : Indicates additional information on operations or features.
- The following symbols are used in this guide:
 - " " : • A cross-reference included in this guide.
 - < > : • Refers to names of CD-ROM, features, and touch screen messages and input text.
 - [] : • Refers to folders, files, applications, button or menu names displayed in the touch screen.
 - The names of menus, commands, windows, or dialog boxes displayed on the computer screen and their buttons and menu names.
 - < > button : Indicates a hardware button on the computer.
 - < > key : Indicates a key on the keyboard of the computer.
 - > : • Indicates a path to a certain item within a procedure on the control panel.
 - Example: When you see the procedure "select [System Settings] > [Setup Menu] > [Mailbox]", this means that you need to select [System Settings], select [Setup Menu], and then select [Mailbox].
 - Indicates a path to a certain item within a procedure on a computer.
 - Example: When you see the procedure "to search for files and folders, click [Start] > [Search] > [For Files or Folders]", this means that you need to click [Start], click [Search], and then click [For Files or Folders] in order to search for files and folders.
 - The reference is indicated in the following manner:
 - "Refer to "6 System Settings" > "Common Settings" > "Audio Tone" in the Administrator Guide."
 - The sentence above means that you need to refer to the

section "Audio Tone", which can be found under "Common Settings" in chapter 6 System Settings of the Administrator Guide.

- Orientation of documents or paper is described in this guide as follows:
☐, ☐, Long Edge Feed (LEF): Loading with one of the long edges of the document or paper.
☐, ☐, Short Edge Feed (SEF): Loading with one of the short edges of the document or paper.

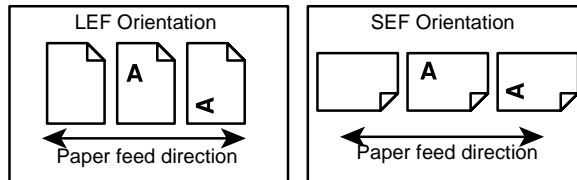

About License

RSA BSAFE



This product includes RSA BSAFE[®] Cryptographic software from RSA Security Inc.

Heimdal

Copyright (c)2000 Kungliga Tekniska Högskolan (Royal Institute of Technology, Stockholm, Sweden). All rights reserved.

Redistribution and use in source and binary forms, with or without modification, are permitted provided that the following conditions are met:

1. Redistributions of source code must retain the above copyright notice, this list of conditions and the following disclaimer.
2. Redistributions in binary form must reproduce the above copyright notice, this list of conditions and the following disclaimer in the documentation and/or other materials provided with the distribution.
3. Neither the name of the Institute nor the names of its contributors may be used to endorse or promote products derived from this software without specific prior written permission.

THIS SOFTWARE IS PROVIDED BY THE INSTITUTE AND CONTRIBUTORS "AS IS" AND ANY EXPRESS OR IMPLIED WARRANTIES, INCLUDING, BUT NOT LIMITED TO, THE IMPLIED WARRANTIES OF MERCHANTABILITY AND FITNESS FOR A PARTICULAR PURPOSE ARE DISCLAIMED. IN NO EVENT SHALL THE INSTITUTE OR CONTRIBUTORS BE LIABLE FOR ANY DIRECT, INDIRECT, INCIDENTAL, SPECIAL, EXEMPLARY, OR CONSEQUENTIAL DAMAGES (INCLUDING, BUT NOT LIMITED TO, PROCUREMENT OF SUBSTITUTE GOODS OR SERVICES; LOSS OF USE, DATA, OR PROFITS; OR BUSINESS INTERRUPTION) HOWEVER CAUSED AND ON ANY THEORY OF LIABILITY, WHETHER IN CONTRACT, STRICT LIABILITY, OR TORT (INCLUDING NEGLIGENCE OR OTHERWISE) ARISING IN ANY WAY OUT OF THE USE OF THIS SOFTWARE, EVEN IF ADVISED OF THE POSSIBILITY OF SUCH DAMAGE.

LZMA

LZMA SDK 4.21 Copyright (c) 1999-2005 Igor Pavlov (2005-06-08)
<http://www.7-zip.org/>

LZMA SDK 4.22 Copyright (c) 1999-2005 Igor Pavlov (2005-06-10)
<http://www.7-zip.org/>

JPEG Code

Our printer software uses some of the codes defined by the Independent JPEG Group.

Libcurl

COPYRIGHT AND PERMISSION NOTICE

Copyright (c) 1996 - 2006, Daniel Stenberg, <daniel@haxx.se>.

All rights reserved.

Permission to use, copy, modify, and distribute this software for any purpose with or without fee is hereby granted, provided that the above copyright notice and this permission notice appear in all copies.

THE SOFTWARE IS PROVIDED "AS IS", WITHOUT WARRANTY OF ANY KIND, EXPRESS OR IMPLIED, INCLUDING BUT NOT LIMITED TO THE WARRANTIES OF MERCHANTABILITY, FITNESS FOR A PARTICULAR PURPOSE AND NONINFRINGEMENT OF THIRD PARTY RIGHTS. IN NO EVENT SHALL THE AUTHORS OR COPYRIGHT HOLDERS BE LIABLE FOR ANY CLAIM, DAMAGES OR OTHER LIABILITY, WHETHER IN AN ACTION OF CONTRACT, TORT OR OTHERWISE, ARISING FROM, OUT OF OR IN CONNECTION WITH THE SOFTWARE OR THE USE OR OTHER DEALINGS IN THE SOFTWARE.

Except as contained in this notice, the name of a copyright holder shall not be used in advertising or otherwise to promote the sale, use or other dealings in this Software without prior written authorization of the copyright holder.

FreeBSD

This product contains the part of FreeBSD codes.

The FreeBSD Copyright

Copyright 1994-2006 The FreeBSD Project. All rights reserved.

Redistribution and use in source and binary forms, with or without modification, are permitted provided that the following conditions are met:

Redistributions of source code must retain the above copyright notice, this list of conditions and the following disclaimer.

Redistributions in binary form must reproduce the above copyright notice, this list of conditions and the following disclaimer in the documentation and/or other materials provided with the distribution.

THIS SOFTWARE IS PROVIDED BY THE FREEBSD PROJECT "AS IS" AND ANY EXPRESS OR IMPLIED WARRANTIES, INCLUDING, BUT NOT LIMITED TO, THE IMPLIED WARRANTIES OF MERCHANTABILITY AND FITNESS FOR A PARTICULAR PURPOSE ARE DISCLAIMED. IN NO EVENT SHALL THE FREEBSD PROJECT OR CONTRIBUTORS BE LIABLE FOR ANY DIRECT, INDIRECT, INCIDENTAL, SPECIAL, EXEMPLARY, OR CONSEQUENTIAL DAMAGES (INCLUDING, BUT NOT LIMITED TO, PROCUREMENT OF SUBSTITUTE GOODS OR SERVICES; LOSS OF USE, DATA, OR PROFITS; OR BUSINESS INTERRUPTION) HOWEVER CAUSED AND ON ANY THEORY OF LIABILITY, WHETHER IN CONTRACT, STRICT LIABILITY, OR TORT (INCLUDING NEGLIGENCE OR OTHERWISE) ARISING IN ANY WAY OUT OF THE USE OF THIS SOFTWARE, EVEN IF ADVISED OF THE POSSIBILITY OF SUCH DAMAGE.

The views and conclusions contained in the software and documentation are those of the authors and should not be interpreted as representing official policies, either expressed or implied, of the FreeBSD Project.

OpenLDAP

Copyright 1998-2006 The OpenLDAP Foundation All rights reserved.

Redistribution and use in source and binary forms, with or without modification, are permitted only as authorized by the OpenLDAP Public License.

A copy of this license is available in the file LICENSE in the top-level directory of the distribution or, alternatively, at <http://www.OpenLDAP.org/license.html>.

OpenLDAP is a registered trademark of the OpenLDAP Foundation.

Individual files and/or contributed packages may be copyright by other parties and/or subject to additional restrictions.

This work is derived from the University of Michigan LDAP v3.3 distribution. Information concerning this software is available at <http://www.umich.edu/~dirsvcs/ldap/ldap.html>.

This work also contains materials derived from public sources.

Additional information about OpenLDAP can be obtained at <http://www.openldap.org/>.

Portions Copyright 1998-2006 Kurt D. Zeilenga.

Portions Copyright 1998-2006 Net Boolean Incorporated.

Portions Copyright 2001-2006 IBM Corporation.

All rights reserved.

Redistribution and use in source and binary forms, with or without modification, are permitted only as authorized by the OpenLDAP Public License.

Portions Copyright 1999-2005 Howard Y.H. Chu.
Portions Copyright 1999-2005 Symas Corporation.
Portions Copyright 1998-2003 Hallvard B. Furuseth.
All rights reserved.

Redistribution and use in source and binary forms, with or without modification, are permitted provided that this notice is preserved.

The names of the copyright holders may not be used to endorse or promote products derived from this software without their specific prior written permission. This software is provided "as is" without express or implied warranty.

Portions Copyright (c) 1992-1996 Regents of the University of Michigan.
All rights reserved.

Redistribution and use in source and binary forms are permitted provided that this notice is preserved and that due credit is given to the University of Michigan at Ann Arbor. The name of the University may not be used to endorse or promote products derived from this software without specific prior written permission. This software is provided "as is" without express or implied warranty.

The OpenLDAP Public License
Version 2.8, 17 August 2003

Redistribution and use of this software and associated documentation ("Software"), with or without modification, are permitted provided that the following conditions are met:

1. Redistributions in source form must retain copyright statements and notices,
2. Redistributions in binary form must reproduce applicable copyright statements and notices, this list of conditions, and the following disclaimer in the documentation and/or other materials provided with the distribution, and
3. Redistributions must contain a verbatim copy of this document..

The OpenLDAP Foundation may revise this license from time to time.

Each revision is distinguished by a version number. You may use this Software under terms of this license revision or under the terms of any subsequent revision of the license.

THIS SOFTWARE IS PROVIDED BY THE OPENLDAP FOUNDATION AND ITS CONTRIBUTORS "AS IS" AND ANY EXPRESSED OR IMPLIED WARRANTIES, INCLUDING, BUT NOT LIMITED TO, THE IMPLIED WARRANTIES OF MERCHANTABILITY AND FITNESS FOR A PARTICULAR PURPOSE ARE DISCLAIMED. IN NO EVENT SHALL THE OPENLDAP FOUNDATION, ITS CONTRIBUTORS, OR THE AUTHOR(S) OR OWNER(S) OF THE SOFTWARE BE LIABLE FOR ANY DIRECT, INDIRECT, INCIDENTAL, SPECIAL, EXEMPLARY, OR CONSEQUENTIAL DAMAGES (INCLUDING, BUT NOT LIMITED TO, PROCUREMENT OF SUBSTITUTE GOODS OR SERVICES; LOSS OF USE, DATA, OR PROFITS; OR BUSINESS INTERRUPTION) HOWEVER CAUSED AND ON ANY THEORY OF LIABILITY,

WHETHER IN CONTRACT, STRICT LIABILITY, OR TORT (INCLUDING NEGLIGENCE OR OTHERWISE) ARISING IN ANY WAY OUT OF THE USE OF THIS SOFTWARE, EVEN IF ADVISED OF THE POSSIBILITY OF SUCH DAMAGE.

The names of the authors and copyright holders must not be used in advertising or otherwise to promote the sale, use or other dealing in this Software without specific, written prior permission. Title to copyright in this Software shall at all times remain with copyright holders.

OpenLDAP is a registered trademark of the OpenLDAP Foundation.

Copyright 1999-2003 The OpenLDAP Foundation, Redwood City, California, USA. All Rights Reserved. Permission to copy and distribute verbatim copies of this document is granted.

DES

This product includes software developed by Eric Young(eay@mincom.oz.au)

AES

Copyright (c) 2003. Dr Brian Gladman. Worcester. UK. All rights reserved.

This product uses published AES software provided by Dr Brian Gladman under BSD licensing terms.

2 Paper and Other Media

This chapter describes the types of paper that can be used on the machine, precautions when handling paper, and how to load paper in trays.

- Paper Types24
- Loading Paper27
- Changing the Paper Size.....33
- Changing the Paper Settings.....38

Paper Types

This section describes the kinds of paper available for this machine.

Use of inappropriate paper may result in paper jams, cause reduced print quality, malfunctions and other trouble. To make full and effective use of the machine's performance, we recommend using only paper recommended by Fuji Xerox.

If you want to use paper not recommended by Fuji Xerox, contact our Customer Support Center.

WARNING

Do not use conductive paper such as carbonic paper or coated paper. When paper jam occurs, it may cause short-circuit and eventually a fire accident.

Important • The printed image may fade due to moisture such as water, rain or vapor. For more information, contact our Customer Support Center.

Supported Paper Type

When using commonly used paper (known as printable paper) for copying or printing, make sure that it complies with the following specifications.

Paper tray	Weight	Loadable quantity
Trays 1 to 2	64 to 176 g/m ² Ream Weight: 55 - 151 kg	500 sheets (80 g/m ²)
Tray 3		870 sheets (80 g/m ²)
Tray 4		1,140 sheets (80 g/m ²)
Tray 5 (bypass)	64 to 280 g/m ² Ream Weight: 55 - 240 kg	Up to 27mm 250 sheets (80 g/m ²)
Tray 6 (HCF (A4 1 Tray)) (optional)	64 to 176 g/m ² Ream Weight: 55 - 151 kg	2,000 sheets (80 g/m ²)
Tray 8 (Interposer) (optional)	64 to 220 g/m ² Ream Weight: 55 - 189 kg	200 sheets (80 g/m ²)

The following table lists the paper types supported for each paper tray.

Paper Type	Weight (g/m ²)	Tray 1-2	Tray 3-4	Tray 5 (Bypass)	Tray 6	Tray 8 (Interposer)
Plain Paper	64 - 105	O	O	O	O	O
Recycled Paper		O	O	O	O	O
Plain Paper (Side 2)*		O	O	O	O	O
Transparency	-	O	O	O	X	X
Tack Film	-	X	X	O	X	X
Coated Paper 1	106 - 176	X	X	O	X	X
Coated Paper 2	177 - 280	X	X	O	X	X
Labels 1	106 - 176	X	X	O	X	X
Labels 2	177 - 280	X	X	O	X	X
Lightweight	52 - 63	X	X	X	X	X
Heavyweight 1	106 - 176	O	O	O	O	O
Heavyweight 2	177 - 280	X	X	O	X	X
Tab Stock 1	106 - 176	X	X	O	X	O
Tab Stock 2	177 - 280	X	X	O	X	X
Hole Punched	64 - 105	O	O	O	O	O

*: Plain Paper (Side 2) means the paper already printed on the one side (i.e., scrap paper).

O: Available

X: Not available

Important • Printing with paper whose type or size differs from the paper specified by the print driver, or printing from a tray not supporting the loaded paper can result in paper jams. To ensure correct printing, select the correct paper size, paper type, and paper tray.

Note

- Weight means a weight of 1 m² of a paper sheet.
- Ream weight means weight of 1,000 sheets of paper in duodecimo size (788 x 1,091 mm).
- When copying with a non-standard size paper from the Tray 5 (bypass), you must manually enter the paper size. If you use non-standard size paper often, you can preset the size on the machine. Then the preset size appears under [Standard Sizes] in the [Tray 5 (Bypass)] screen. For more information, refer to "Tray 5 (Bypass) - Paper Size Defaults" (P.128).

Storing and Handling Paper

■ Please keep the following points in mind when storing paper

- Store paper inside a cabinet or other dry place. Paper that has absorbed moisture can cause paper jams and image quality defects.
- After opening a package of paper, wrap up the remaining paper to store it. It is recommended that you include moisture prevention packets.
- Paper should be stored flat to prevent bends or warping.

■ Please adhere to the following when setting paper into the tray

- Align the stack of paper neatly before setting it in the tray.
- Do not use paper that is folded, creased, or heavily warped.
- Do not use wavy or curled paper.
- Do not load paper of mixed size together into the tray.

- Transparency paper and label paper can cause paper jams, and multiple sheets can be fed to the printer at once. Be sure to carefully fan these types of paper.
- When continuously outputting onto transparencies, transparency sheets may sometimes stick to each other. Remove transparencies from the output tray every 20 or so sheets, and fan them to cool them down.

Loading Paper

This section describes how to load paper.

■Types of paper loaded in trays

The machine automatically detects the size and orientation of loaded paper in trays. You need to set a paper type, however. Normally, each of the trays is set to plain paper. When loading paper other than plain paper in trays, change the paper type settings. Paper can also be named and set as user-defined paper. Up to five paper types can be set as user-defined paper.

For information on changing the paper type in trays, refer to "Changing the Paper Settings" (P.38).

■Automatic Tray Selection

If you set paper source on the [Paper/Output] tab to [Paper Tray] in the PCL print driver's properties screen when making prints, the machine automatically selects the corresponding paper tray according to the size and orientation of the document to print. This is called [Automatic Tray Selection].

When making copies, automatic tray selection is active if [Auto Paper] is selected for [Paper Supply]. If the machine detects two or more corresponding trays in the automatic tray selection, the machine gives higher priority to the tray having the highest [Paper Type Priority] set at [Paper Tray Settings]. During automatic tray selection, trays whose [Paper Type Priority] setting is set to [Auto Paper Off] are not targeted in the automatic tray selection. Also, if the [Paper Type Priority] setting is exactly the same, the tray priority is determined by [Paper Tray Priority].

- Note**
- The Tray 5 (bypass) cannot be selected in the automatic tray selection.
 - When the machine runs out of paper during copying or printing, select the tray containing the paper of the same size and orientation that was being used for copying or printing, and continue copying or printing (Auto Tray Switch feature). During this operation, a tray containing paper of type whose [Paper Type Priority] setting is set to [Auto Paper Off] cannot be switched to.

For information about setting [Paper Type], [Paper Type Priority], [Paper Tray Priority], and setting the paper substitute feature, refer to "Paper Tray Settings" (P.126). The same settings can also be made from CentreWare Internet Services.

■Adding paper

When the machine runs out of paper during copying or printing, a message is displayed on the control panel display. Add paper according to the displayed instructions. Copying or Printing is automatically resumed when paper is added.

- Note**
- Fan the paper well before loading paper in a tray. It prevents paper from sticking to each other and reduces paper jams.

Loading Paper in the Trays 1 to 2

The following describes the procedure for loading paper in the Trays 1 to 2.

When the machine runs out of paper during copying or printing, a message is displayed on the control panel display. Add paper according to the displayed instructions. Copying or printing is automatically resumed when paper is added.

- Note**
- Before loading paper in a tray, fan the paper well. It prevents paper from sticking to each other and reduces paper jams.

For information on changing the paper size and orientation, refer to "Changing the Paper Size for the Trays 1 to 2" (P.33).

- 1 Pull out the tray towards you until it stops.

- Important**
- Make sure to pull out the tray slowly. When the tray is being pulled out with force, the tray may possibly hit your knees or other parts of your body causing injuries.
 - While the machine processes a job, do not pull the tray out that the job uses.
 - Do not add a new stack of paper on top of the remaining paper in the tray, in order to prevent paper jams or any other troubles. First, remove the remaining paper in the tray, then load the new stack of paper.

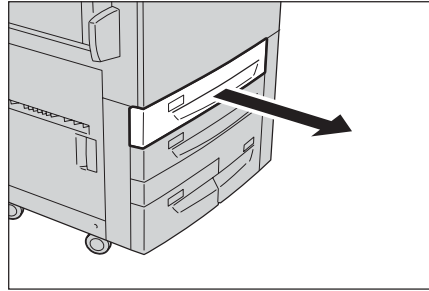

- 2 Load and align the edge of the paper against the left edge of the tray with the side to be copied or printed on facing down.

- Important**
- Do not load paper exceeding the maximum fill line. It might cause paper jams or machine malfunctions.
 - Do not place any paper or things in the empty space on the right side of the Tray 1 or 2. It may cause paper jams or machine malfunctions.

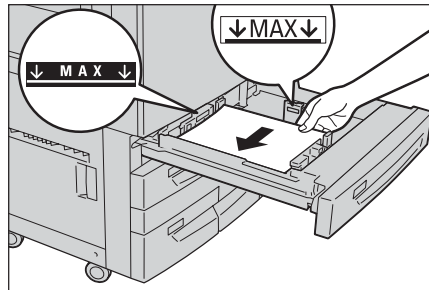

- 3 Push the tray in gently until it comes to a stop.

Loading Paper in the Trays 3 to 4

Following describes the procedure for loading paper in the Trays 3 to 4.

When the machine runs out of paper during copying or printing, a message is displayed on the control panel display. Add paper according to the displayed instructions. Copying or printing is automatically resumed when paper is added.

- Note**
- Before loading paper in a tray, fan the paper well. It prevents paper from sticking to each other and reduces paper jams.

For information on changing the paper size and orientation, refer to "Changing the Paper Size for the Trays 3 to 4" (P.34).

- 1 Pull out the tray towards you until it stops.

- Important**
- Make sure to pull out the tray slowly. When the tray is being pulled out with force, the tray may possibly hit your knees or other parts of your body causing injuries.
 - While the machine processes a job, do not pull the tray out that the job uses.
 - Do not add a new stack of paper on top of the remaining paper in the tray, in order to prevent paper jams or any other troubles. First, remove the remaining paper in the tray, then load the new stack of paper.

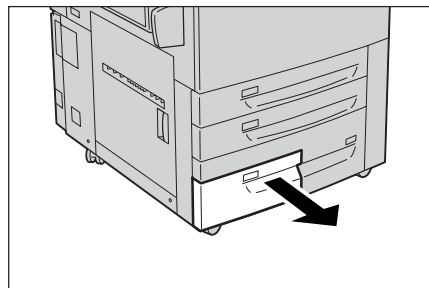

- 2** Load and align the edge of the paper against the left edge of the tray with the side to be copied or printed on facing down.

Important • Do not load paper exceeding the maximum fill line. It might cause paper jams or machine malfunctions.

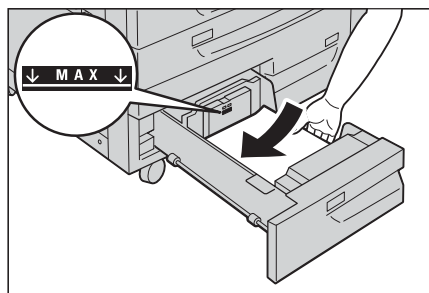

- 3** Push the tray in gently until it comes to a stop.

Loading Paper in the Tray 5 (Bypass)

When printing or copying with paper sizes or types that cannot be set in the Trays 1 to 4 and 6, use the Tray 5 (Bypass).

The following describes how to load paper into the Tray 5 (Bypass).

To make detailed instructions for printings, specify the instructions using the [Tray/Output] tab in the print driver. When doing this, also specify the type of paper to load.

Important • Do not supply new paper until the loaded paper run out in order to prevent paper jams or making mistakes of paper loading.

Note • Before loading paper in a tray, fan the paper well. It prevents paper from sticking to each other and reduces paper jams.

- 1** Open the Tray 5 (bypass) as necessary.

Note • If necessary, extend the extension flap. The extension flap can be extended in two stages. When pulling out the extension flap, do it gently.

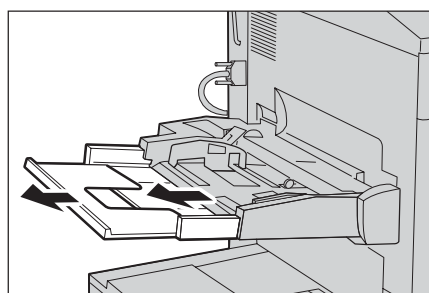

- 2** Hold the center of the paper guides and slide them to the desired paper size.

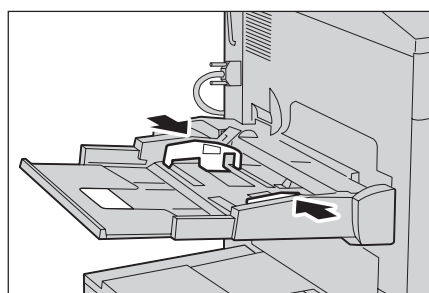

- 3** Load paper with the side to be copied or printed on facing up, and insert the paper lightly along the paper guide until it comes to a stop.

Important • Do not load mixed paper types into the tray.

• Do not load paper exceeding the maximum fill line. It might cause paper jams or machine malfunctions.

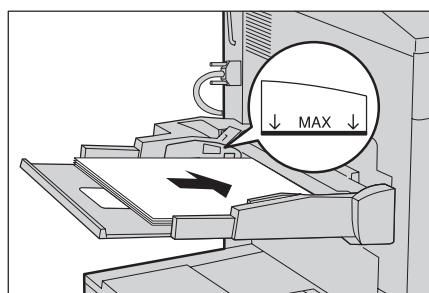

- 4** When loading a non-standard paper size on the Tray 5 (bypass), move the paper guides to accommodate the paper.

Loading Tab Paper in the Tray 5 (Bypass)

Following describes the procedure for loading tab paper in the Tray 5.

Important • Tab paper cannot be loaded on the Trays 1 to 4 and 6.

- Tab paper can be used only for [Tab Margined Shift], Covers, and Separators.

Note • Before loading paper in a tray, fan the paper well. It prevents paper from sticking to each other and reduces paper jams.

1 Open the Tray 5 (bypass).

Note • If necessary, extend the extension flap. The extension flap can be extended in two stages. When pulling out the extension flap, do it gently.

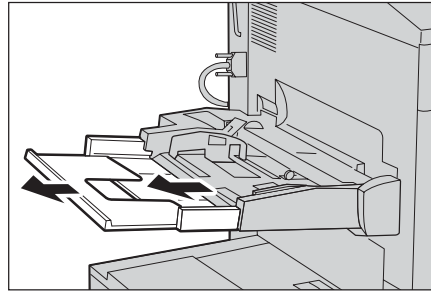

2 Hold the center of the paper guides and slide them to the desired paper size.

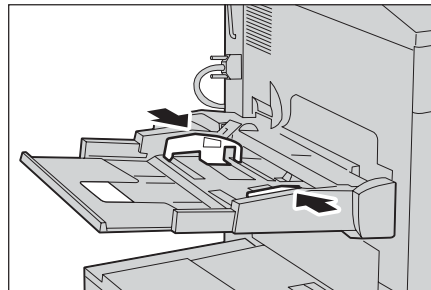

3 Load paper with the side to be copied or printed on facing up and the top edge frontward, and insert the paper lightly along the paper guide until it comes to a stop.

Important • Do not load mixed paper types into the tray.
• Do not load paper exceeding the maximum fill line. It may cause paper jams or machine malfunctions.

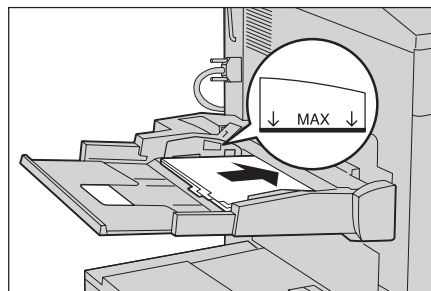

Loading Paper in the Tray 6 (HCF (A4 1 Tray))

Following describes the procedure for loading paper in the Tray 6 (HCF (A4 1 Tray)) (optional).

When the machine runs out of paper during copying or printing, a message is displayed on the control panel display. Add paper according to the displayed instructions. Copying or printing is automatically resumed when paper is added.

Note • Before loading paper in a tray, fan the paper well. It prevents paper from sticking to each other and reduces paper jams.

For information about changing the paper size and orientation, refer to "Changing the Paper Size for the Tray 6 (HCF (A4 1 Tray))" (P.35).

- 1 Pull out the Tray 6 towards you until it stops.

- Important**
- Make sure to pull out the tray slowly. When the tray is being pulled out with force, the tray may possibly hit your knees or other parts of your body causing injuries.
 - While the machine is processing a job, do not pull out the tray.
 - Do not add a new stack of paper on top of the remaining paper in the tray, in order to prevent paper jams or any other troubles. First, remove the remaining paper in the tray, then load the new stack of paper.

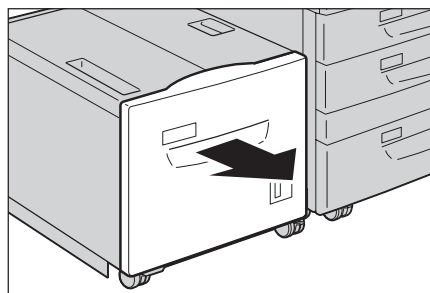

- 2 Load and align the edge of the paper against the right edge of the tray with the side to be copied or printed on facing up.

- Important**
- Do not load paper exceeding the maximum fill line. It might cause paper jams or machine malfunctions.

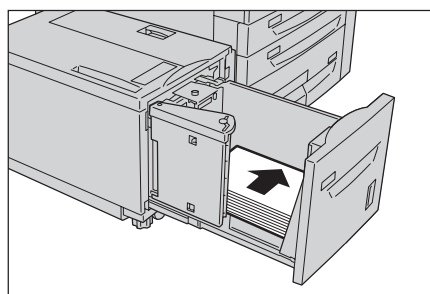

- 3 Push the tray in gently until it comes to a stop.

Loading Paper in the Tray 8 (Interposer)

Following describes the procedure for loading paper in the Tray 8 (Interposer) (optional).

Interposer allows you to load paper (blank, copied paper, etc.), which will only be used as separators and covers, so that the machine does not output on the paper loaded in this tray.

- Note**
- When adding paper to interposer, remove any paper remaining in the tray, add it to the stack of paper to be added, then load all of the paper into the interposer at once.

- 1 Hold the center of the paper guides and slide them to the desired paper size.

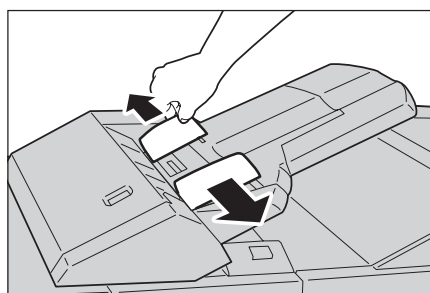

- 2 Load the paper, neatly aligning all edges.

- Important**
- Do not load paper exceeding the maximum fill line. It might cause paper jams or machine malfunctions.

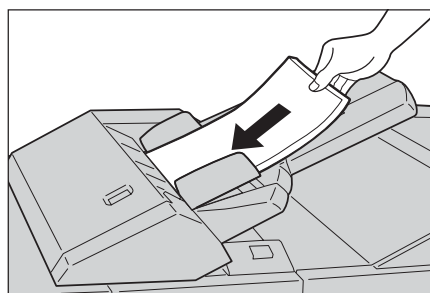

Loading Tab Paper in the Tray 8 (Interposer)

Following describes the procedure for loading tab paper in the Tray 8 (Interposer) (optional).

- 1 Hold the center of the paper guides and slide them to the desired paper size.

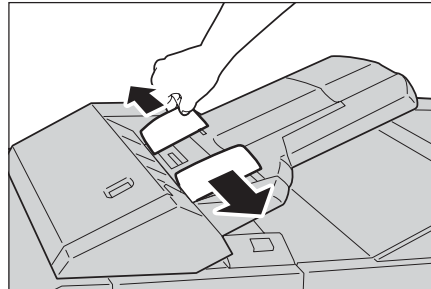

- 2 If the paper is already printed on, load the paper with the printed side facing up and with the tab side to be fed first.

Important • Do not load paper exceeding the maximum fill line. It might cause paper jams or machine malfunctions.

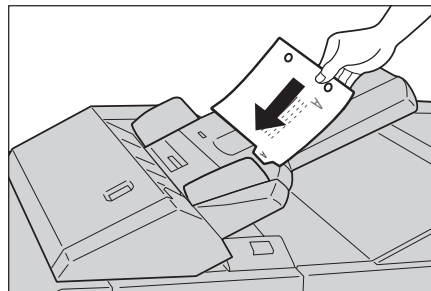

Changing the Paper Size

The following describes how to change the paper size for the Trays 1 to 4 and 6.

- Note**
- The paper types for the Trays 1 to 4 and 7 are preset. Normally, plain paper is set. When replacing the loaded paper with other types of paper, change the paper type settings to match the type of paper to be loaded to maintain print quality.

For information about changing the paper types, refer to "Changing the Paper Settings" (P.38)

Changing the Paper Size for the Trays 1 to 2

Following describes how to change the paper size for the Trays 1 to 2.

- 1** Pull out the tray towards you until it stops.

- Important**
- Make sure to pull out the tray slowly. When the tray is being pulled out with force, the tray may possibly hit your knees or other parts of your body causing injuries.

- While the machine processes a job, do not pull the tray out that the job uses.

- Do not add a new stack of paper on top of the remaining paper in the tray, in order to prevent paper jams or any other troubles. First, remove the remaining paper in the tray, then load the new stack of paper.

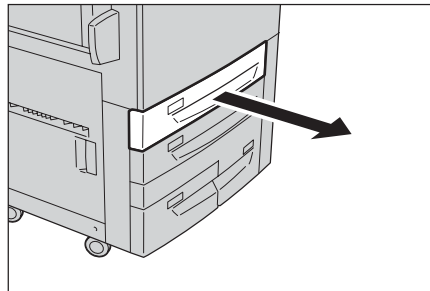

- 2** Remove any paper loaded on the tray.

- 3** Hold the long-side paper guide and slide it to the desired paper size (1). Hold the short-side paper guide on the right side and slide it to the desired paper size (2).

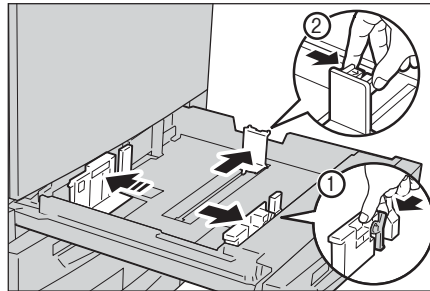

- 4** Load and align the edge of the paper against the left edge of the tray with the side to be copied or printed on facing down.

- Important**
- Do not load paper exceeding the maximum fill line. It might cause paper jams or machine malfunctions.

- Do not place any paper or things in the empty space on the right side of the Tray 1 or 2. It may cause paper jams or machine malfunctions.

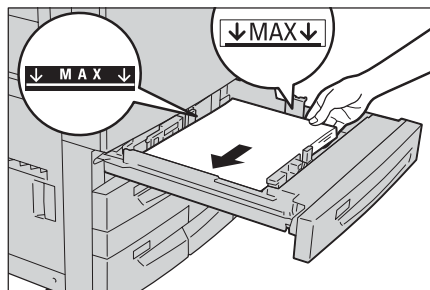

- 5 Move the two paper guides while holding their grips so that they lightly contact the edges of the paper.
- 6 Push the tray in gently until it comes to a stop.

Note • Affix the paper size label to the front of the paper tray.

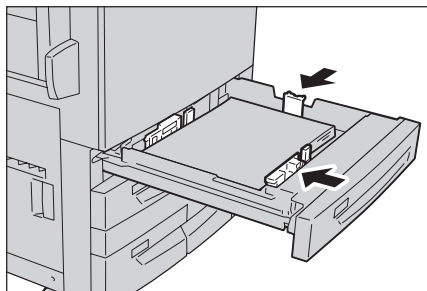

Changing the Paper Size for the Trays 3 to 4

Following describes how to change the paper size for the Trays 3 to 4.

Changing the Size of Paper for the Tray 3

- 1 Pull out the Tray 3 towards you until it stops.

Important • Make sure to pull out the tray slowly. When the tray is being pulled out with force, the tray may possibly hit your knees or other parts of your body causing injuries.

- While the machine processes a job, do not pull the tray out that the job uses.

- Do not add a new stack of paper on top of the remaining paper in the tray, in order to prevent paper jams or any other troubles. First, remove the remaining paper in the tray, then load the new stack of paper.

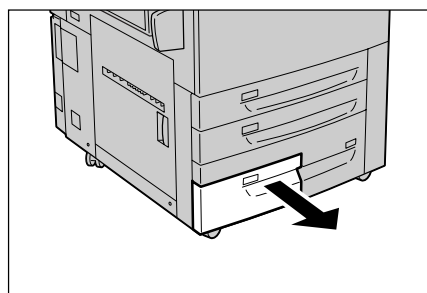

- 2 Remove any paper loaded on the tray.
- 3 Hold the paper guide and slide it to the desired paper size.
- 4 Check the position of the paper guides and then release them.

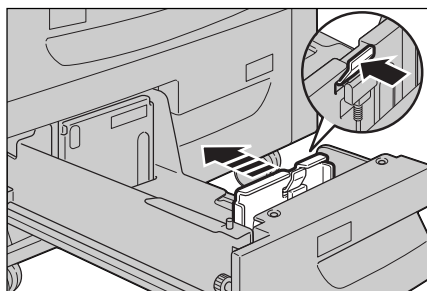

- 5 Load and align the edge of the paper against the left edge of the tray with the side to be copied or printed on facing down.

Important • Do not load paper exceeding the maximum fill line. It might cause paper jams or machine malfunctions.

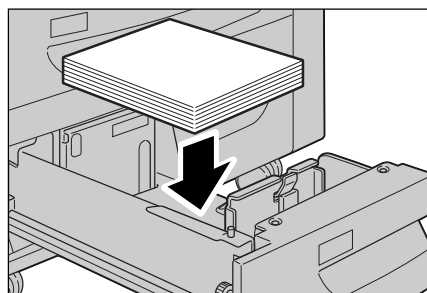

- 6 Hold the paper guide and move it to gently touch the edge of the paper.
- 7 Push the tray in gently until it comes to a stop.

Note • Affix the paper size label to the front of the paper tray.

Changing the Paper Size for the Tray 4

- 1 Pull out the Tray 4 towards you until it stops.

Important • Make sure to pull out the tray slowly. When the tray is being pulled out with force, the tray may possibly hit your knees or other parts of your body causing injuries.

- While the machine processes a job, do not pull the tray out that the job uses.

- Do not add a new stack of paper on top of the remaining paper in the tray, in order to prevent paper jams or any other troubles. First, remove the remaining paper in the tray, then load the new stack of paper.

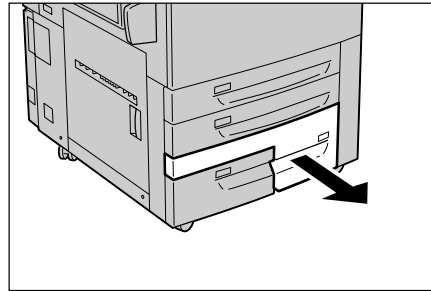

- 2 Remove any paper loaded on the tray.

- 3 Hold the paper guide and slide it to the desired paper size.

- 4 Check the position of the paper guides and then release them.

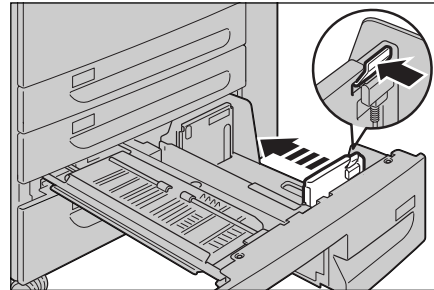

- 5 Load and align the edge of the paper against the left edge of the tray with the side to be copied or printed on facing down.

Important • Do not load paper exceeding the maximum fill line. It might cause paper jams or machine malfunctions.

- 6 Hold the paper guide and move it to gently touch the edge of the paper.

- 7 Push the tray in gently until it comes to a stop.

Note • Affix the paper size label to the front of the paper tray.

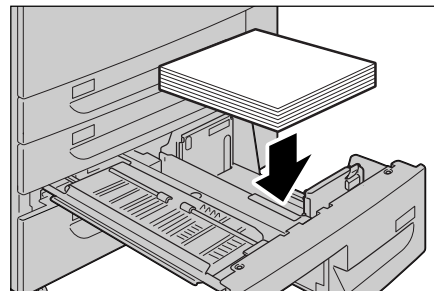

Changing the Paper Size for the Tray 6 (HCF (A4 1 Tray))

Following describes how to change the paper size for the Tray 6 (HCF (A4 1 Tray)).

- 1 Pull out the Tray towards you until it stops.

Important • Make sure to pull out the tray slowly. When the tray is being pulled out with force, the tray may possibly hit your knees or other parts of your body causing injuries.

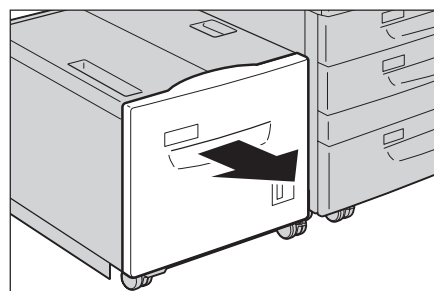

- While the machine processes a job, do not pull the tray out that the job uses.
- Do not add a new stack of paper on top of the remaining paper in the tray, in order to prevent paper jams or any other troubles. First, remove the remaining paper in the tray, then load the new stack of paper.

2 Remove any paper loaded on the tray.

3 Open the end guide (1) and unscrew the screw (2). Then remove the guide from the Tray.

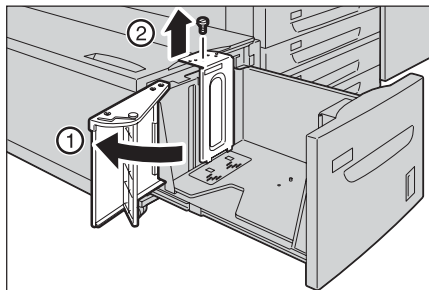

4 Insert the small protrusions at the bottom of the guide into holes corresponding to the paper size (1). Insert the screw into a hole corresponding to the paper size on the top of the guide and screw up (2).

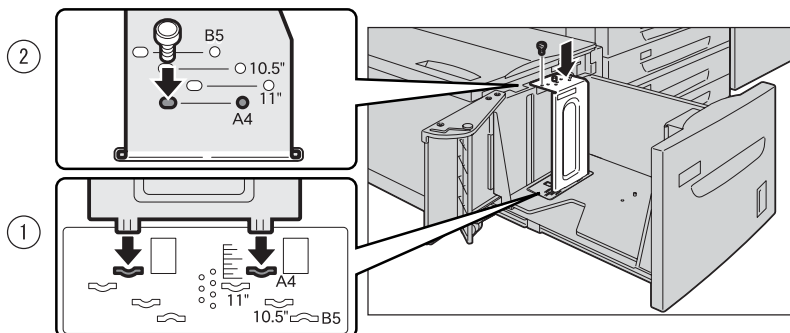

5 Unscrew the screw of the front guide and remove the guide from the Tray.

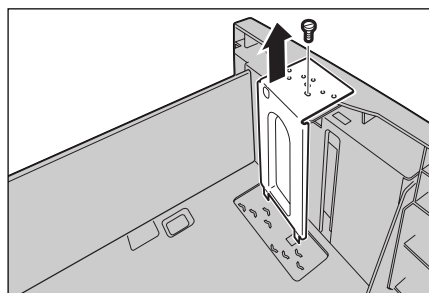

6 Insert the small protrusions at the bottom of the guide into holes corresponding to the paper size (1). Insert the screw into a hole corresponding to the paper size on the top of the guide and screw up (2).

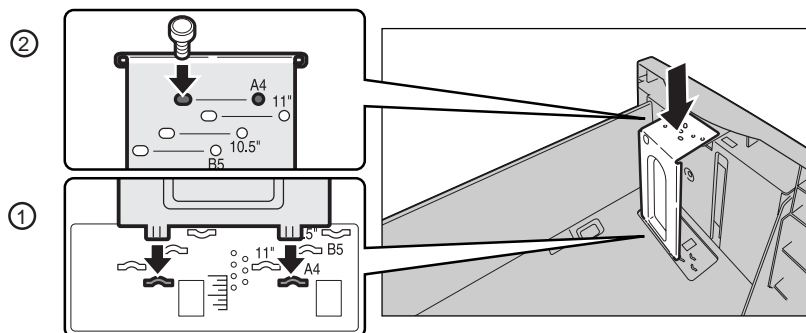

- 7** Pull the lever up of the end guide and move it along the slot (1). Set the lever at the position corresponding to the paper size (2) and press the lever down (3).

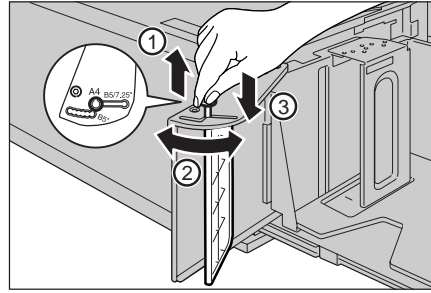

Important • Adjust the end guide accordingly with the size of paper. If the end guide is not adjusted correctly, the machine cannot feed the paper properly, resulting in a paper jam.

Note • The slot on the left of 8.5" is not used.

- 8** Open the end guide (1) and load and align the edge of the paper against the right edge of the tray with the side to be copied or printed on facing up (2).

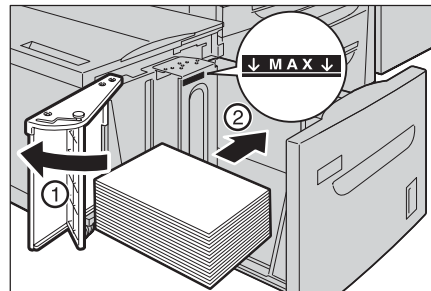

Important • Do not load paper exceeding the maximum fill line. It might cause paper jams or machine malfunctions.

- 9** Close the end guide tightly.

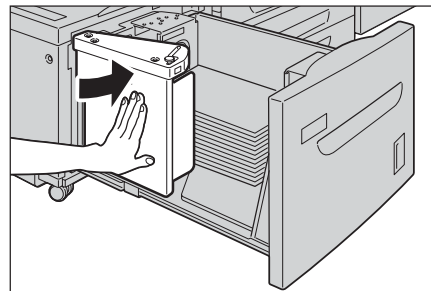

- 10** Push the tray in gently until it comes to a stop.

Changing the Paper Settings

The following describes how to change the paper type for Trays and how to set image quality processing by individual paper type.

Image quality best suited to the paper type can be obtained by setting the desired image processing to particular paper types.

- Note**
- Users can name User1 to User5 displayed in the paper type.
 - The [Setup Menu] screen, which can be displayed by selecting [Setup Menu] in the [All Services] screen, allows you to change the paper type setting without entering the System Administration mode, if you have configured the settings to do so in advance.

For information on how to set names to User1 to User5, refer to "Custom Paper Name" (P.126).

For information on image quality processing for different paper types, refer to "Image Quality" (P.278).

1 Press the <Log In/Out> button.

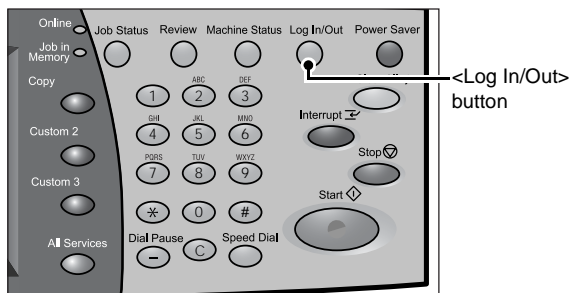

2 Enter the System Administrator Login ID with the numeric keypad or the keyboard displayed by pressing [Keyboard], and select [Confirm].

- Note**
- The default System Administrator Login ID is "11111". When using the Authentication feature, a passcode is required. The default passcode is "x-admin".



3 Select [System Settings].



4 Select [System Settings].

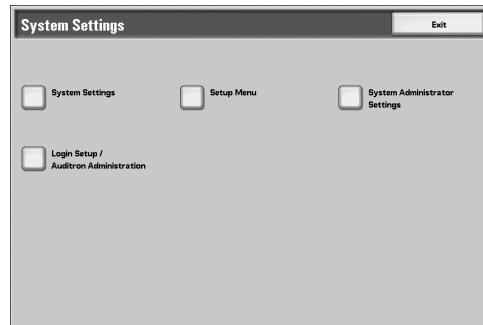

5 Select [Common Settings].

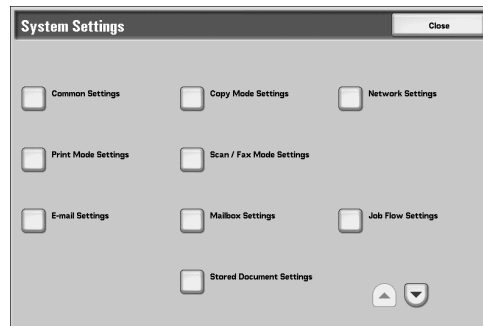

6 Select [Paper Tray Settings].

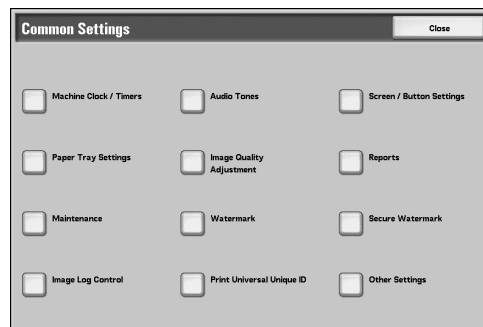

7 Select [Paper Tray Attributes].

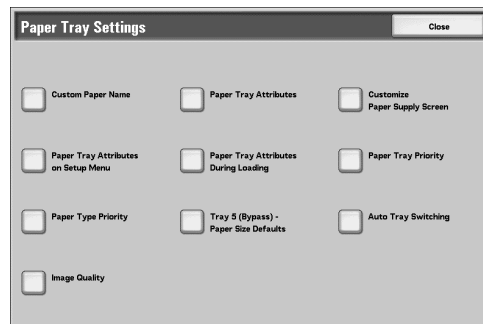

8 Select the paper tray whose paper type setting is to be changed at [Items], and select [Change Settings].

Note • Select [▲] to return to the previous screen or [▼] to move to the next screen.

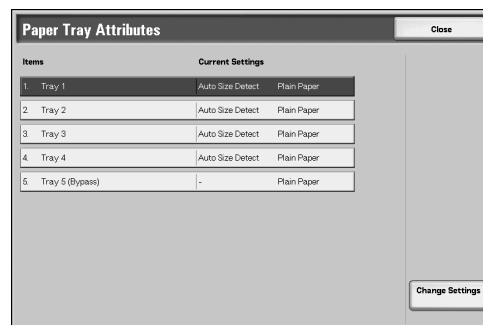

9 Select [Change Settings].

10 Select the paper type to be set and then select [Save] until [Paper Tray Settings] screen is displayed.

Note

- The paper color can be set if you select [Enabled] for [Paper Color] under [Customize Paper Supply Screen]. For more information on [Customize Paper Supply], refer to "Customize Paper Supply Screen" (P.127).

- Select [▲] to return to the previous screen or [▼] to move to the next screen.



11 Select [Image Quality].

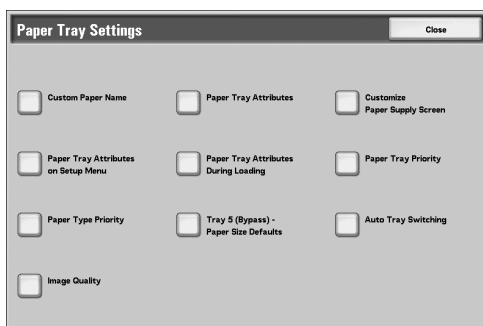

12 Select the paper type whose image processing is to be changed at [Items], and select [Change Settings].

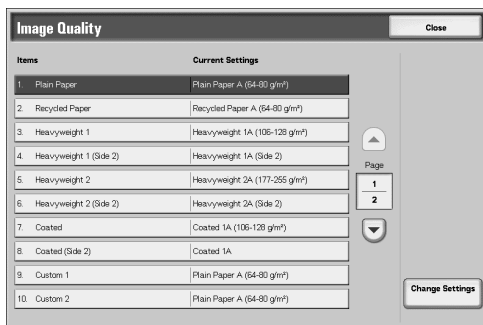

13 Select the image processing value to change, and select [Save].

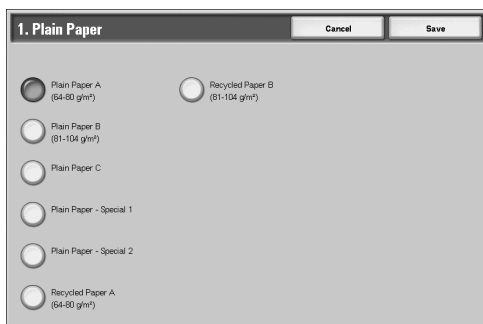

14 Make sure that the [Current Settings] at the [Items] you changed is the newly entered value, and then select [Close].

15 Select [Close] repeatedly until the [System Settings] screen is displayed.

16 Select [Exit] to exit the System Administration mode.

3 Maintenance

This chapter describes how to replace consumables, clean the machine, perform calibration, and print a report/list.

- Replacing Consumables 42
- Cleaning the Machine 63
- Executing Calibration 66
- Printing a Report/List 70

Replacing Consumables

The machine is provided with the following consumables and periodical replacement parts. We recommend the use of the following consumables as they have been manufactured to meet the specifications of the machine.

Type of Consumables/ Periodical Replacement Parts	Product Code	Quantity/Box
Toner cartridge [Y]	CT200571	1 unit/box
Toner cartridge [M]	CT200570	1 unit/box
Toner cartridge [C]	CT200569	1 unit/box
Toner cartridge [K]	CT200568	1 unit/box
Drum Cartridge K [R1] (Black)	CT350361	1 unit/box
Drum Cartridge Y,M,C [R2/R3/R4] (Color)	CT350362	1 unit/box
Waste Toner Bottle	CWAA0663	1 unit/box
Staple cartridge for 50 sheets XE	CWAA0540	5,000 staples × 3 sets/box
Staple cartridge for booklet maker finisher XC	CWAA0501	5,000 staples × 4 sets/box
Staple cartridge for 100 sheets XF	CWAA0677	5,000 staples × 4 sets/box, Staple Scrap Container × 1 unit/box

Note • We recommend that you always have spare consumables/periodical replacement parts available.

WARNING

- Use a broom or a wet cloth to wipe off spilled toner. Never use a vacuum cleaner for the spills. It may catch fire by electric sparks inside the vacuum cleaner and cause explosion. If you spill a large volume of toner, contact your local Fuji Xerox representative.
- Never throw a toner cartridge into an open flame. Remaining toner in the cartridge may catch fire and cause burn injuries or explosion. If you have a used toner cartridge no longer needed, contact your local Fuji Xerox representative for its disposal.

⚠ CAUTION

- Keep the drum and toner cartridges out of the reach of children. If a child accidentally swallows toner, spit it out, rinse mouth with water, drink water and consult a physician immediately.
- When replacing the drum and toner cartridges, be careful not to spill the toner. In case of any toner spills, avoid contact with clothes, skin, eyes and mouth as well as inhalation.
- If toner spills onto your skin or clothing, wash it off with soap and water. If you get toner particles in your eyes, wash it out with plenty of water for at least 15 minutes until irritation is gone. Consult a physician if necessary. If you inhale toner particles, move to a fresh air location and rinse your mouth with water. If you swallow toner, spit it out, rinse your mouth with water, drink plenty of water and consult a physician immediately.

■ Handling consumables/periodical replacement parts

- Do not store boxes for consumables/periodical replacement parts upright.
- Do not unpack consumables/periodical replacement parts before use. Avoid storing consumables/periodical replacement parts in the following locations:
 - In extreme temperature and humidity
 - Near heat-generating devices
 - In direct sunlight
 - In dusty locations
- Use consumables/periodical replacement parts only as directed on their packages.
- We recommend always having spare consumables/periodical replacement parts available.
- When calling our Customer Support Center to order consumables/periodical replacement parts, have the product codes ready.
- Use of consumables/periodical replacement parts not recommended by Fuji Xerox can impair machine quality and performance. Use only consumables/periodical replacement parts recommended by Fuji Xerox.

■ Checking the status of consumables

The status of consumables can be checked on the [Supplies] screen.
For information about consumables, refer to "Supplies" (P.104).

Replacing the Toner Cartridge

The machine comes with a toner cartridge. The machine will display the following messages when the toner cartridge is empty. Follow the messages and replace the toner cartridge as necessary.

Message ^{*1}	Page yield after the message is displayed ^{*2}	Solution
Yellow Toner [Y] Cartridge needs to be replaced soon.	Black: Approx. 1,800 pages Other than black: Approx. 1,200 pages	Replace the toner cartridge with a new one.

Message*1	Page yield after the message is displayed*2	Solution
Yellow Toner [Y] Cartridge needs to be replaced.	-	Replace the toner cartridge with a new one.

*1 The above messages are the indications for yellow toner replacement. The part name "yellow toner [Y]" in the messages varies depending on the colors or number of toner cartridges.

*2 The page yield after each message is displayed is for when A4 paper LEF is used. The value is an estimate and varies depending on the conditions such as the print content, dot coverage (area coverage), paper size, paper type, copy/print density, output image type, and the machine usage environment.

Important • When replacing the toner cartridge, toner may spill and soil the floor. We recommend laying paper on the floor beforehand.

- The use of toner cartridges not recommended by Fuji Xerox may impair quality and performance. Use only toner cartridges recommended by Fuji Xerox.
- When the remaining amount of toner becomes small, the machine may stop during printing and display a message. If this happens, replace the toner cartridge to continue copying or printing.
- Replace toner cartridges while the machine is on.
- If a partially used toner cartridge is used, a message appears and the number of pages that you can copy or print displayed on the screen may differ considerably.

Note • Monochrome copying and printing is available even when color toners are run out. In this case, only plain paper can be used.

1 Open the toner cover.

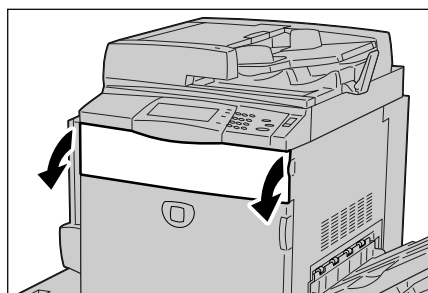

2 Hold the lower part of the toner cartridge of the color indicated in the message and gently pull out it.

Note • "Y" is for yellow, "M" is for magenta, "C" is for cyan, and "K1" and "K2" is for black.

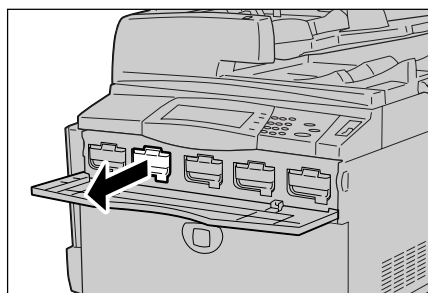

- Remove the toner cartridge by holding the handle on the top of the cartridge while gently pulling out it.

⚠ WARNING

Never throw a toner cartridge into an open flame. Remaining toner in the cartridge may catch fire and cause burn injuries or explosion.
If you have a used toner cartridge no longer needed, contact your local Fuji Xerox representative for its disposal.

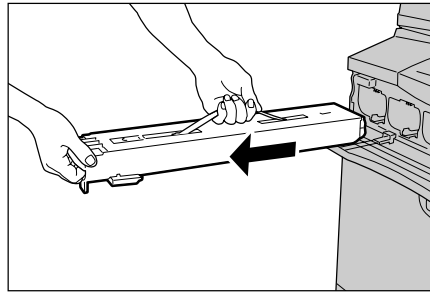

Important • Pull out the toner cartridge gently. Otherwise, toner may fly out of the cartridge.

- Take out the new toner cartridge of the same color as the old one from its box, and gently tilt the cartridge up and down, and then left and right several times.

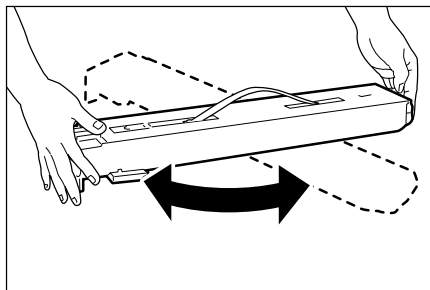

- Insert the toner cartridge in gently until it comes to a stop.

Note • Be sure to insert the toner cartridge until you hear it click into place.

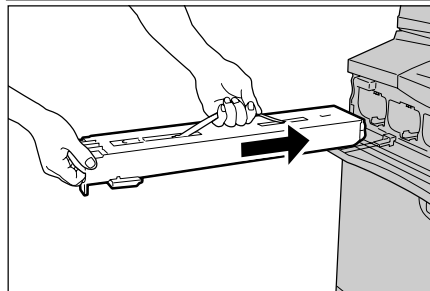

- Close the toner cover.

Replacing the Waste Toner Bottle

The machine comes with a waste toner bottle. The machine will sound an alarm and display the message "Please order a new Waste Toner Bottle" approximately 3,000 pages before the waste toner bottle is full. When this message appears, order a new waste toner bottle. The machine will stop when the waste toner bottle ends its life.

Note • The above value "3,000 pages" is based on when copies are made at 5% area coverage using A4 size paper. The value is for reference only and will vary depending on the conditions such as the print contents, dot coverage (area coverage), paper size, paper type, copy/print density, output image type, and machine usage environment.

Important • When replacing the waste toner bottle, toner may spill and soil the floor. We recommend laying paper on the floor beforehand.

- The use of waste toner bottles not recommended by Fuji Xerox may impair quality and performance. Use only waste toner bottles recommended by Fuji Xerox for the machine.
- Replace the waste toner bottle while the machine is on.

- 1 Make sure that the machine is not in operation, and open the front cover.

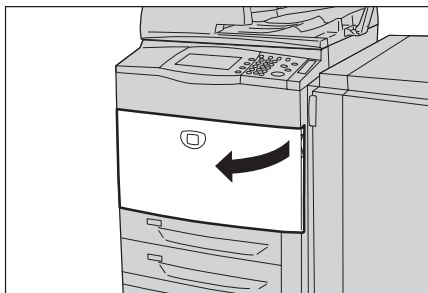

- 2 Open the waste toner bottle cover.

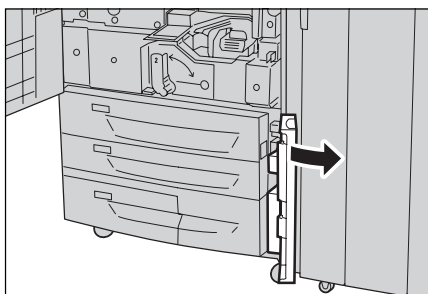

- 3 Grip the handle of the waste toner bottle and pull out about half of it.

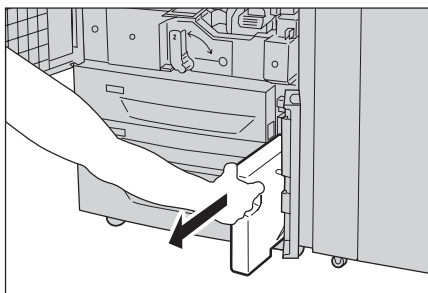

- 4 Hold the center part on the top of the container, and then remove it.

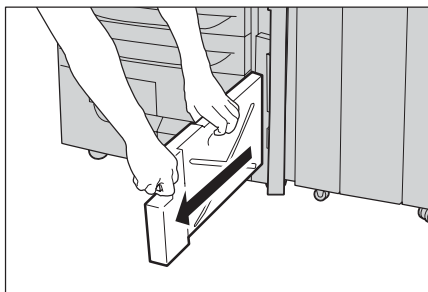

- 5 Hold the used waste toner bottle firmly with both hands and put it into the provided plastic bag.

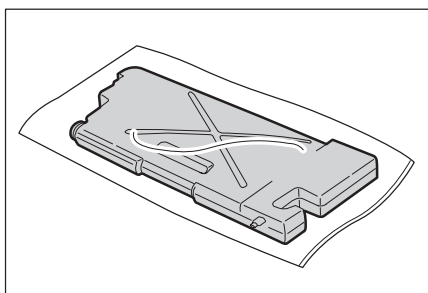

⚠ WARNING
 Never throw a toner waste bottle into an open flame. Remaining toner in the toner waste bottle may catch fire and cause burn injuries or explosion.
 If you have a used toner waste bottle no longer needed, contact your local Fuji Xerox representative for its disposal.

Important • Place the used waste toner bottle into the special bag and then close it firmly using ring rubber provided with the bag. If the zipper is left open, the toner may leak out during disposal.

6 Hold the center part on the top of a new container and insert it until it comes to a stop.

Important • When inserting the waste toner bottle, do not grip the handle of the container.

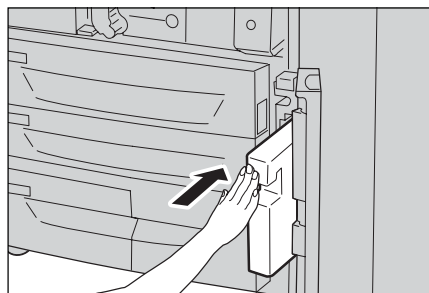

7 Close the waste toner bottle cover.

8 Close the front cover.

Note • A message will be displayed and the machine will not operate if the front cover of the finisher is even slightly open.

Replacing Drum Cartridge R1 (for customers having a spot maintenance contract)

The machine comes with a drum cartridge. The machine will sound an alarm and display the following messages before the drum cartridge reaches the end of life. Follow the messages to order a new drum cartridge. The machine will stop when the drum cartridge ends its life.

Message	Page yield after the message is displayed*1	Solution
Please order a Drum Cartridge R1.	ApeosPort-II C7500, DocuCentre-II C7500 - Approx. 8,400 pages ApeosPort-II C6500, DocuCentre-II C6500 - Approx. 7,300 pages ApeosPort-II C5400, DocuCentre-II C5400 - Approx. 6,200 pages	The drum cartridge does not need to be replaced yet. Get a spare of the displayed drum cartridge.
Drum Cartridge R1 needs to be replaced soon.	ApeosPort-II C7500, DocuCentre-II C7500 - Approx. 2,600 pages ApeosPort-II C6500, DocuCentre-II C6500 - Approx. 2,300 pages ApeosPort-II C5400, DocuCentre-II C5400 - Approx. 1,900 pages	The drum cartridge does not need to be replaced yet. Get a spare of the displayed drum cartridge.
Drum Cartridge R1 needs to be replaced.	-	Replace the drum cartridge with a new one.

*1 Based on the following conditions: (1) 1-sided copying (not printing), (2) average number of pages copied at one time: 12 pages (ApeosPort-II C7500/DocuCentre-II C7500) / 10 pages (ApeosPort-II C6500/DocuCentre-II C6500) / 9 pages (ApeosPort-II C5400/DocuCentre-II C5400), (3) paper size: A4 LEF, paper type: plain paper, (4) paper tray: Tray 1, (5) output tray: Offset Catch Tray. The values are for reference only and will be affected also by other machine-usage conditions, such as how often the machine is turned on and off. Note that the page yield may be half or less of the above-described values under some conditions.

When a message “Please order a Drum Cartridge R1” appears on the touch screen, contact our Customer Support Center.

If you have concluded a spot maintenance contract, refer to this section, then confirm the indicated drum cartridge position (R1) and replace the corresponding drum cartridge.

Important • Place a black sheet supplied with a new drum cartridge onto the whole unit within 2 minutes after pulling out a unit in which drum cartridges are placed. Image quality may deteriorate when the drum cartridges are exposed to light.

- The use of drum cartridges not recommended by Xerox may impair quality and performance. Use only drum cartridges recommended by Xerox for the machine.

Note • Do not expose drum cartridges to direct sunlight or strong light from indoor fluorescent lighting. Do not touch or scratch the surface of the drum. Doing so may result in unsatisfactory printing.

- Replace drum cartridges while the machine is on. When the power is turned off, all information stored to the machine's memory will be erased.

- After the message “Replace the drum cartridge R1” appears, image quality of printed documents or copies may deteriorate.

1 Take out a new drum cartridge and a black sheet from its container.

Important • Put the drum cartridge on a flat place.

- Do not place the new drum cartridge in an upright position.

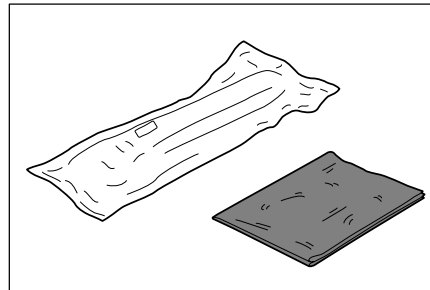

2 Make sure that the machine has stopped before opening the front cover.

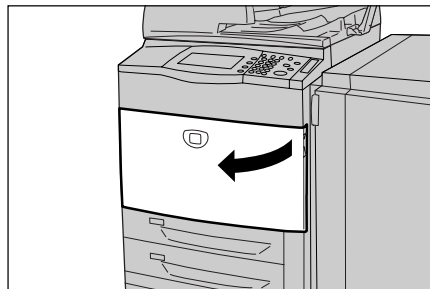

3 Pull down the R1-R4 lever.

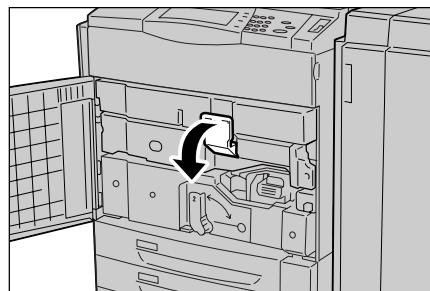

- 4** Grip the handle of the unit and pull out it.

Important • Make sure to pull out the unit slowly. When the unit is being pulled out with force, the unit may possibly hit your knees or other parts of your body causing injuries.

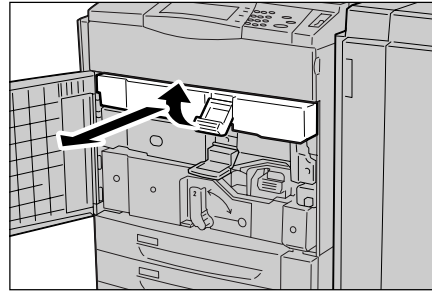

- 5** Place a black sheet supplied with the new drum cartridge onto the unit other than the drum cartridge R1.

Important • Make sure to place the black sheet. It may affect image quality.

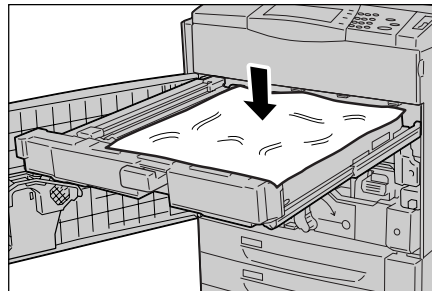

- 6** Remove the drum cartridge upward while holding rings provided at the both ends of the drum cartridge.

CAUTION



Be sure to insert your fingers into the rings when lifting the drum cartridge up.

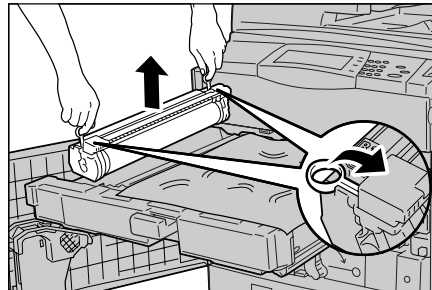

- 7** Place the replaced drum cartridge into the empty container.

- 8** Open a bag including a new drum cartridge and take it out.

Important • Do not touch or scratch the surface of the drum when you take it out from the bag.

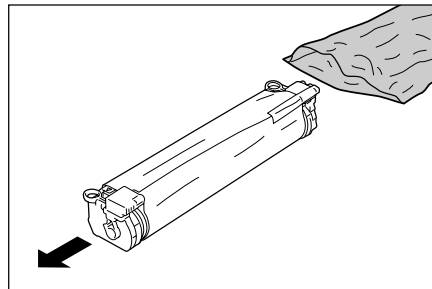

- 9** Unwrap a sheet covering the drum cartridge and place it under the cartridge.

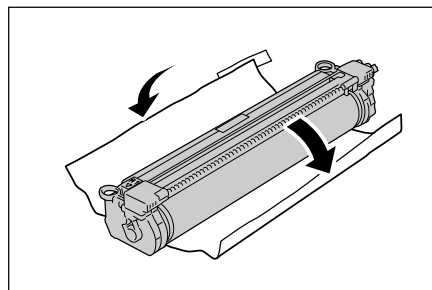

- 10** Grip rings provided at the both ends of the drum cartridge to uplift.

CAUTION



Be sure to insert your fingers into the rings when lifting the drum cartridge up.

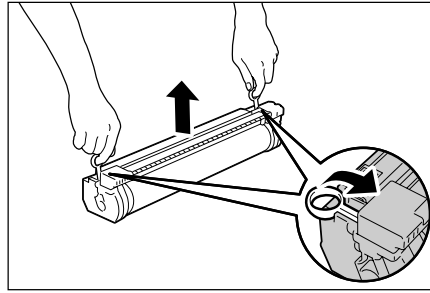

Important • Do not touch the surface of the drum cartridge.

- 11** Place the drum cartridge along with the guide with the side marked with (▼) forward.

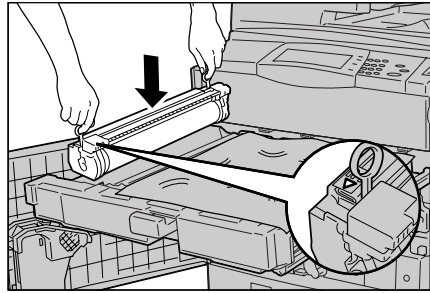

- 12** Press the both ends of the drum cartridge to place it in a horizontal position.

Note • Make sure that the marks (▼) and (▲) face each other.

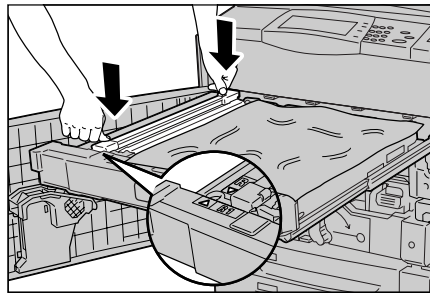

- 13** Remove the black sheet from the unit.

- 14** Insert the unit completely and return the handle to the original position.

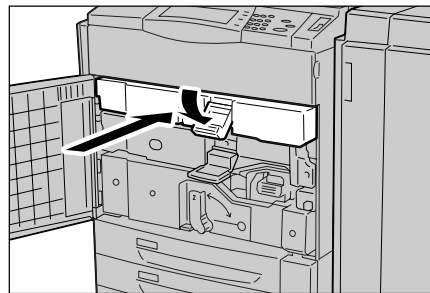

- 15** Return the lever R1-R4 to the original position.

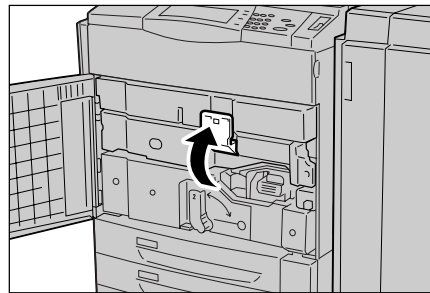

- 16** Close the front cover.

Note • A message will be displayed and the machine will not operate if the front cover is even slightly open.

Replacing Drum Cartridge R2/R3/R4 (for customers having a spot maintenance contract)

The machine comes with a drum cartridge. The machine will sound an alarm and display the following messages before the drum cartridge reaches the end of life. Follow the messages to order a new drum cartridge. The machine will stop when the drum cartridge ends its life.

Message	Page yield after the message is displayed*	Solution
Please order a Drum Cartridge RX.	ApeosPort-II C7500/C6500, DocuCentre-II C7500/C6500 - Approx. 4,600 pages ApeosPort-II C5400, DocuCentre-II C5400 - Approx. 4,000 pages	The drum cartridge does not need to be replaced yet. Get a spare of the displayed drum cartridge.
Drum Cartridge RX needs to be replaced soon.	ApeosPort-II C7500/C6500, DocuCentre-II C7500/C6500 - Approx. 1,400 pages ApeosPort-II C5400, DocuCentre-II C5400 - Approx. 1,200 pages	The drum cartridge does not need to be replaced yet. Get a spare of the displayed drum cartridge.
Drum Cartridge RX needs to be replaced.	-	Replace the drum cartridge with a new one.

*1 Based on the following conditions: (1) 1-sided copying (not printing), (2) average number of pages copied at one time: 9 pages, (3) paper size: A4 LEF, paper type: plain paper, (4) paper tray: Tray 1, (5) output tray: Offset Catch Tray. The values are for reference only and will be affected also by other machine-usage conditions, such as how often the machine is turned on and off. Note that the page yield may be half or less of the above-described values under some conditions.

When a message “Please order a Drum Cartridge RX” appears on the touch screen, contact our Customer Support Center.

If you have concluded a spot maintenance contract, refer to this section, then confirm the indicated drum cartridge position (R2, R3, or R4) and replace the corresponding drum cartridge.

Important • Place a black sheet supplied with a new drum cartridge onto the whole unit within 2 minutes after pulling out a unit in which drum cartridges are placed. Image quality may deteriorate when the drum cartridges are exposed to light.

- The use of drum cartridges not recommended by Xerox may impair quality and performance. Use only drum cartridges recommended by Xerox for the machine.

Note

- Do not expose drum cartridges to direct sunlight or strong light from indoor fluorescent lighting. Do not touch or scratch the surface of the drum. Doing so may result in unsatisfactory printing.
- Replace drum cartridges while the machine is on. When the power is turned off, all information stored to the machine's memory will be erased.
- After the message “Replace the drum cartridge RX” appears, image quality of printed documents or copies may deteriorate.

- 1 Take out a new drum cartridge and a black sheet from its container.

Important

- Put the drum cartridge on a flat place.
- Do not place the new drum cartridge in an upright position.

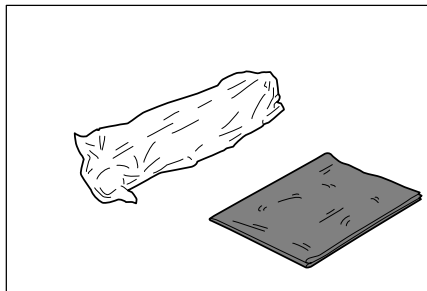

- 2 Make sure that the machine has stopped before opening the front cover.

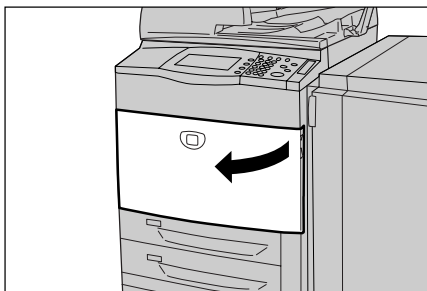

- 3 Pull down the R1-R4 lever.

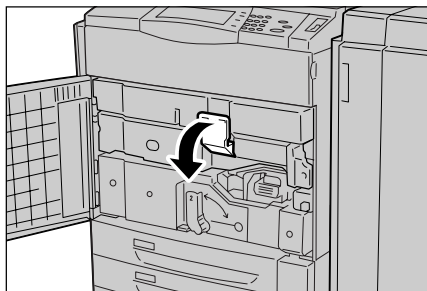

- 4 Grip the handle of the unit and pull out it.

Important

- Make sure to pull out the unit slowly. When the unit is being pulled out with force, the unit may possibly hit your knees or other parts of your body causing injuries.

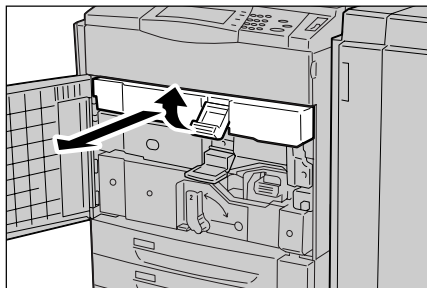

- 5 Remove the drum cartridge upward while holding rings provided at the both ends of the drum cartridge.

Note

- The following example shows how to replace drum R2.

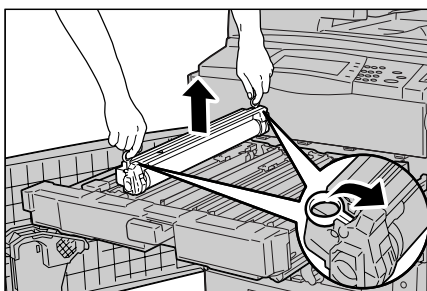

- 6 Place the replaced drum cartridge into the empty container.

- 7** Place a black sheet supplied with the new drum cartridge onto the unit.

Important • Make sure to place the black sheet. It may affect image quality.

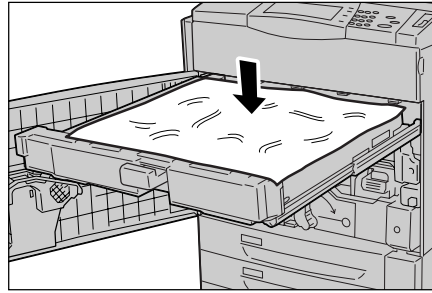

- 8** Open a bag including a new drum cartridge and take it out.

Important • Do not touch or scratch the surface of the drum when you take it out from the bag.

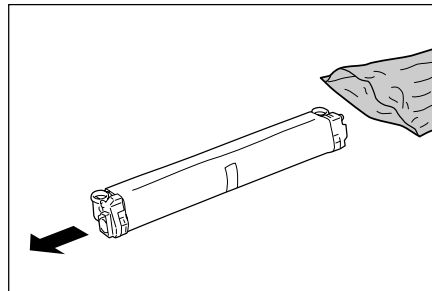

- 9** Unwrap a sheet covering the drum cartridge and place it under the cartridge.

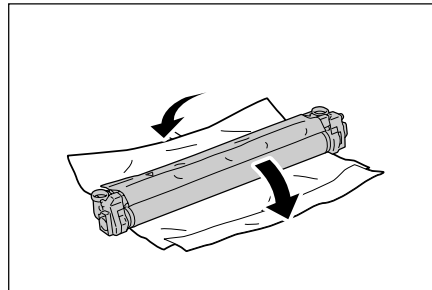

- 10** Remove the black sheet from the unit.

- 11** Grip rings provided at the both ends of the drum cartridge to uplift.

Important • Do not touch the surface of the drum cartridge.

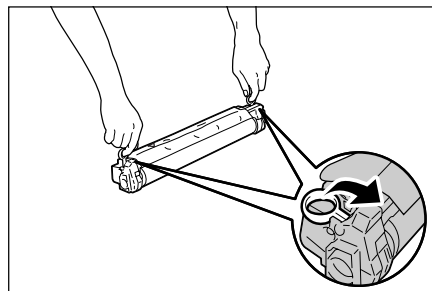

- 12** Place the drum cartridge along with the guide with the side marked with (▶) frontward.

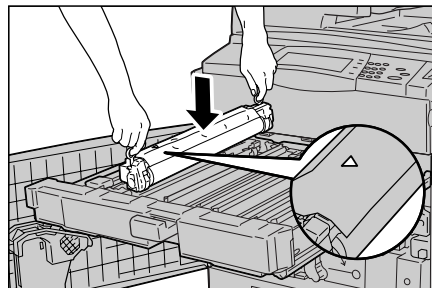

- 13** Press the both ends of the drum cartridge to place it in a horizontal position.

Note • Make sure that the marks (▶) and (◀) face each other.

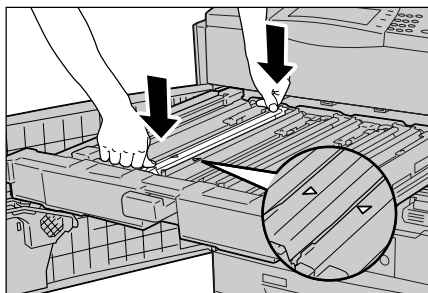

- 14** Remove the film on the drum cartridge.

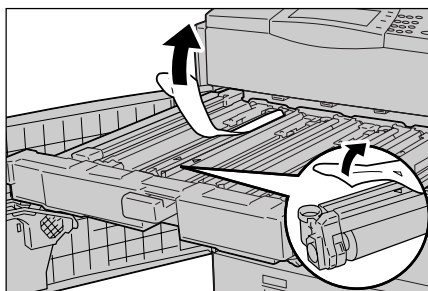

- 15** Insert the unit completely and return the handle to the original position.

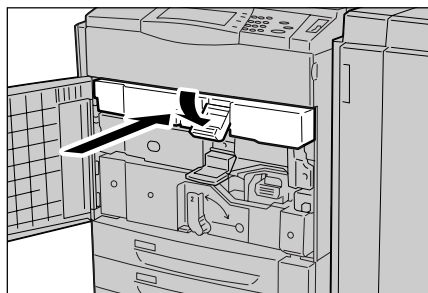

- 16** Return the lever R1-R4 to the original position.

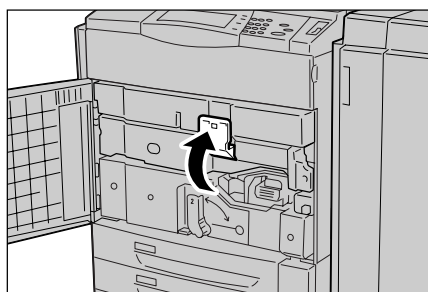

- 17** Close the front cover.

Note • A message will be displayed and the machine will not operate if the front cover is even slightly open.

Replacing the Staple Cartridge for C-Finisher or C-Finisher with Booklet Maker

When the C-Finisher (optional) or the C-Finisher with Booklet Maker (optional) is installed and it is time to replace the staple cartridge, a message appears on the touch screen. When this message appears, replace the staple cartridge with a new one.

This section explains how to replace the staple cartridge in the C-Finisher with Booklet Maker. Use the same procedures for the C-Finisher.

Important • The use of staple cartridges not recommended by Fuji Xerox may impair quality and performance. Use only staple cartridges recommended by Fuji Xerox for the machine.

Note • To order a staple cartridge, contact our Customer Support Center.

- 1 Make sure that the machine has stopped, and open the front cover of the finisher.

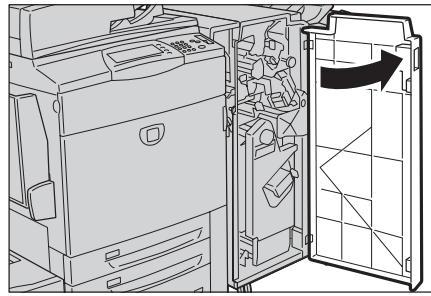

- 2 Grip the lever R1 of the staple cartridge holder, and pull out the holder to the right towards you.

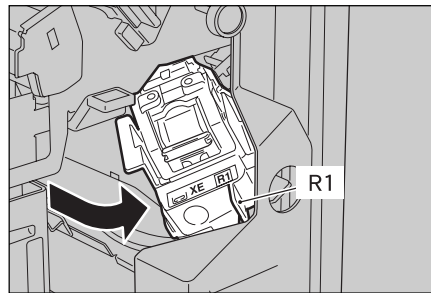

- 3 Remove the staple cartridge holder by gripping the orange lever.

Note

- The staple cartridge is firmly held. When remove the staple cartridge, strongly pull the cartridge.

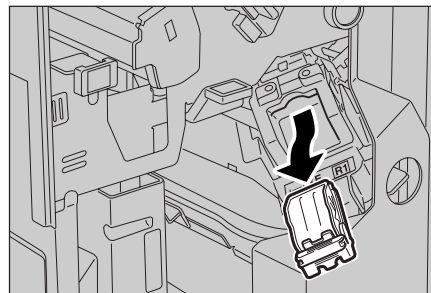

- 4 Pick the empty staple case with your fingers (1), and then remove the case from the cartridge (2) as shown in the figure.

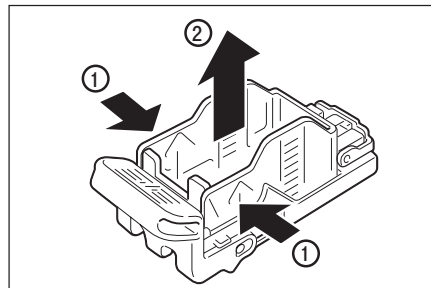

- 5 Prepare a new staple case. Insert the front of the staple case into the staple cartridge (1), and push the rear of the case to set (2).

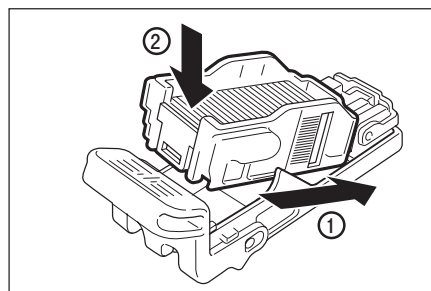

- 6 Hold the orange lever to push the staple cartridge into the machine until it clicks into place.

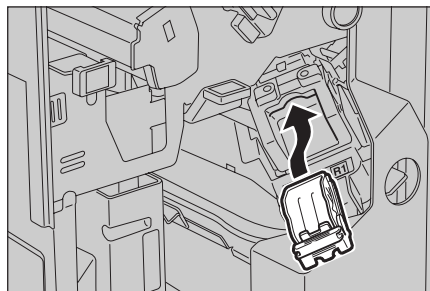

- 7 Close the front cover of the finisher.

Note • A message will be displayed and the machine will not operate if the front cover of the finisher is even slightly open.

Replacing the Booklet Staple Cartridge (C-Finisher with Booklet Maker or Booklet Finisher D2)

When the C-Finisher with Booklet Maker (optional) or the Booklet Finisher D2 (optional) is installed and it is time to replace the booklet staple cartridge, a message appears on the touch screen. When this message appears, replace the staple cartridge with a new one.

This section explains how to replace the staple cartridge in the C-Finisher with Booklet Maker. Use the same procedures for the Booklet Finisher D2.

Important • The use of staple cartridges not recommended by Fuji Xerox may impair quality and performance. Use only staple cartridges recommended by Fuji Xerox for the machine.

Note • To order a staple cartridge, contact our Customer Support Center.

- 1 Make sure that the machine has stopped, and open the front cover of the finisher.

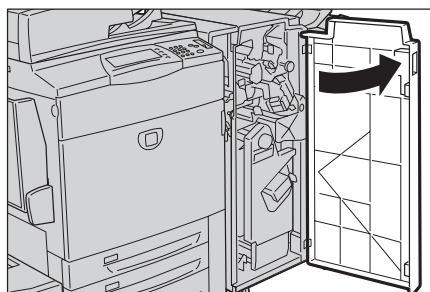

- 2 While pressing the levers R2 and R3 to the right (1), pull out the unit (2).

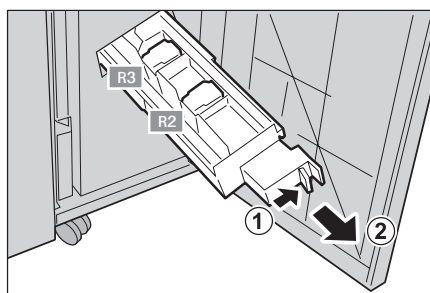

- 3** Hold the left and right tabs on the staple cartridge to pull the cartridge out.

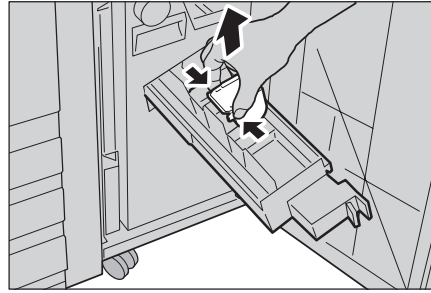

- 4** Hold the left and right tabs on the new staple cartridge to return the cartridge to its original position, and gently push the cartridge until it clicks into place.

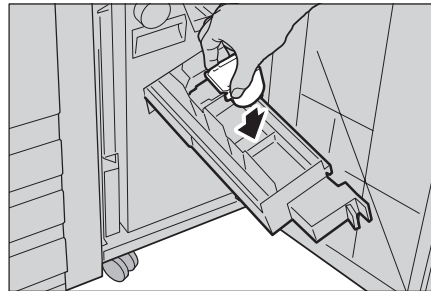

- 5** Return the unit to its original position.

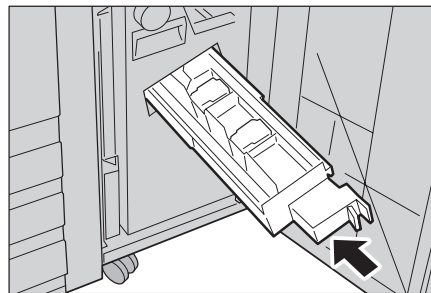

- 6** Close the front cover of the finisher.

Note • A message will be displayed and the machine will not operate if the front cover of the finisher is even slightly open.

Replacing the Staple Cartridge for Booklet Finisher D2

When the Booklet Finisher D2 (optional) is installed and it is time to replace the staple cartridge, a message appears on the touch screen. When this message appears, replace the staple cartridge with a new one.

Important • The use of staple cartridges not recommended by Fuji Xerox may impair quality and performance. Use only staple cartridges recommended by Fuji Xerox for the machine.

Note • To order a staple cartridge, contact our Customer Support Center.

- 1** Make sure that the machine has stopped, and open the right cover of the finisher.

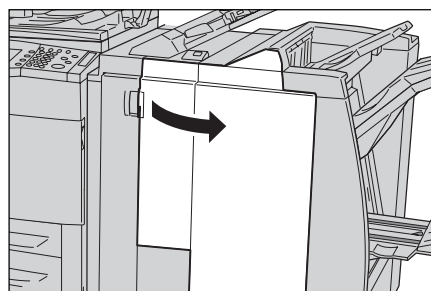

- 2** Hold the R1 at the position shown in the figure.

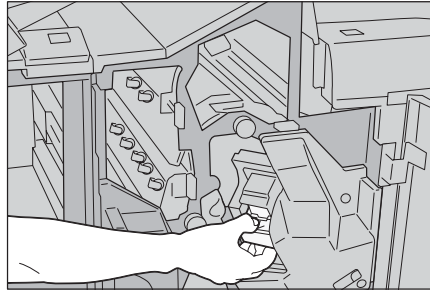

- 3** Pull out the unit.

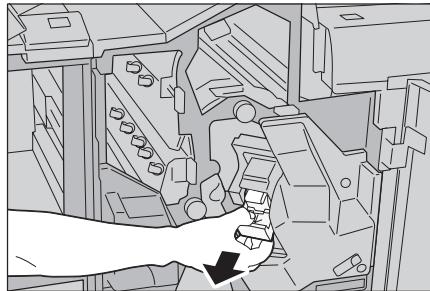

- 4** Hold the positions indicated by an arrow to remove the staple cartridge from the unit.

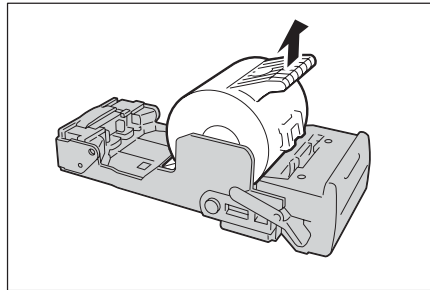

- 5** Push a new staple cartridge into the unit.

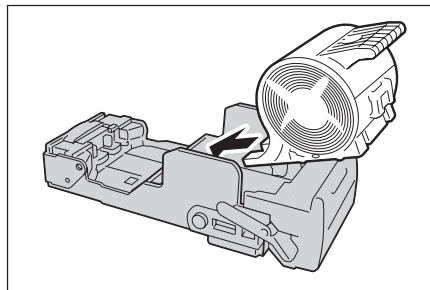

- 6** Push the removed unit back to the original position.

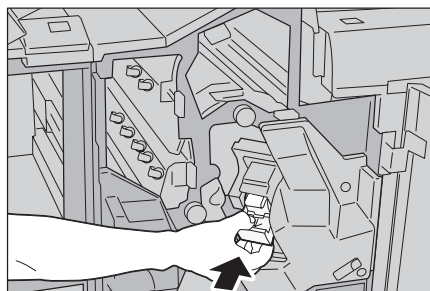

- 7** Close the right cover of the finisher.

Note • A message will be displayed and the machine will not operate if the right cover of the finisher is even slightly open.

Emptying the Punch Scrap Container for C-Finisher or C-Finisher with Booklet Maker

When the C-Finisher (optional) or C-Finisher with Booklet Maker (optional) is installed and the punch scrap container becomes full, a message appears on the touch screen. Discard the scraps according to the message.

If you take the punch scrap container out of the machine, make sure to empty it completely. If it is reinstalled with some scraps remaining, it may become full before the message appears again, and this can cause machine breakdown.

Important • When emptying the punch scrap container, make sure that the machine is switched on. If not switched on, the machine will not recognize that the punch scrap container has been emptied.

- 1 Make sure that the machine has stopped, and open the front cover of the finisher.

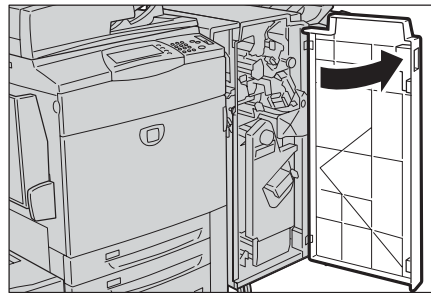

- 2 Pull out the punch scrap container R4 towards you.

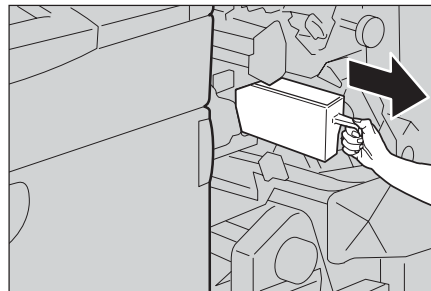

- 3 Discard all the scraps.

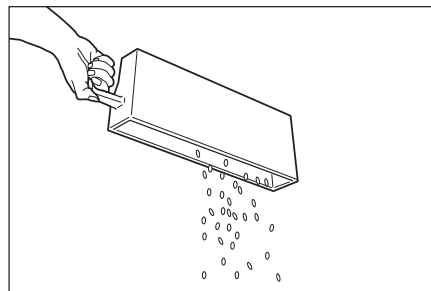

- 4 Insert the empty punch scrap container into its original position until it comes to a stop.

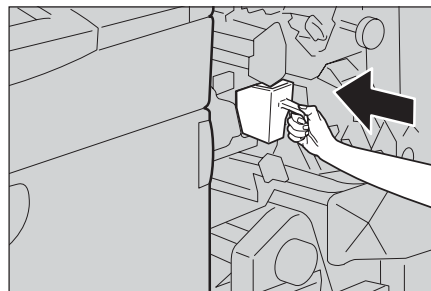

- 5 Close the front cover of the finisher.

Note • A message will be displayed and the machine will not operate if the front cover of the finisher is even slightly open.

Emptying the Punch Scrap Container for Booklet Finisher D2

When the Booklet Finisher D2 (optional) is installed and the punch scrap container becomes full, a message appears on the touch screen. Discard the scraps according to the message.

If you take the punch scrap container out of the machine, make sure to empty it completely. If it is reinstalled with some scraps remaining, it may become full before the message appears again, and this can cause machine breakdown.

⚠ CAUTION

Be careful not to get injured by waste staples when detaching a staple dust box.

Important • When emptying the punch scrap container, make sure that the machine is switched on. If not switched on, the machine will not recognize that the punch scrap container has been emptied.

- 1 Make sure that the machine has stopped, and open the right cover of the finisher.

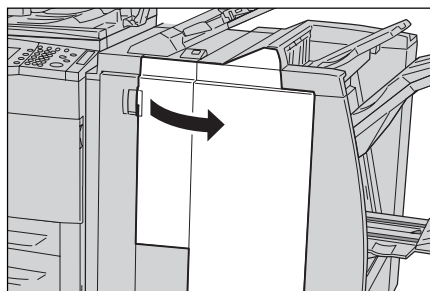

- 2 Pull out the punch scrap container R4 towards you.

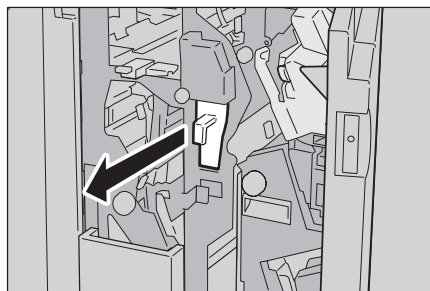

- 3 Discard all the scraps.

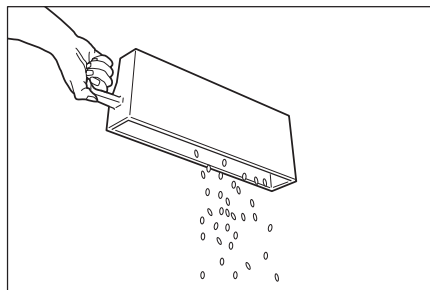

- 4 Insert the empty punch scrap container into its original position until it comes to a stop.

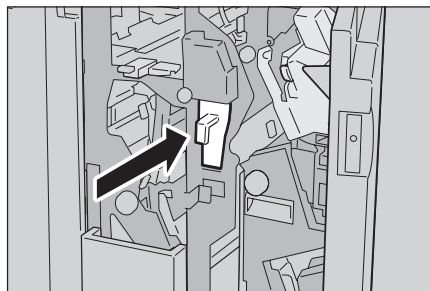

- 5 Close the right cover of the finisher.

Note • A message will be displayed and the machine will not operate if the right cover of the finisher is even slightly open.

Replacing the Staple Scrap Container for Booklet Finisher D2

When the Booklet Finisher D2 is installed and the staple scrap container becomes full, a message appears on the touch screen. Replace the staple scrap container according to the message.

⚠ CAUTION

Be careful not to get injured by waste staples when detaching a staple dust box.

Important • Replace the staple scrap container while the power is on.

- A Staple scrap container is included in a Staple Cartridge for 100 sheets XF.

- 1** Make sure that the machine has stopped, and open the right cover of the finisher.

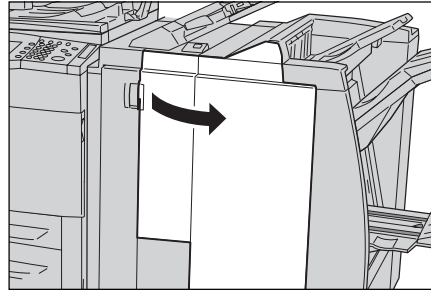

- 2** Move the lock lever, shown in the figure, leftward to the  position.

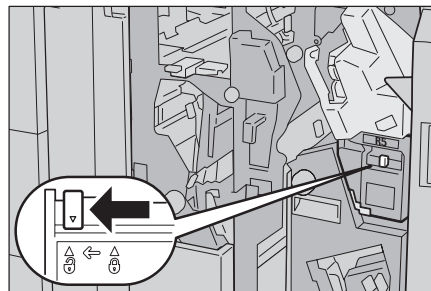

- 3** Securely hold the staple scrap container by its R5 section, and take the container out of the machine.

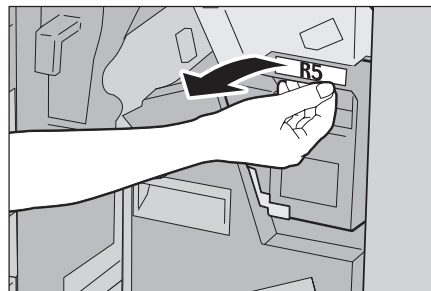

- 4** Put the old container into the plastic bag supplied.

Important • Do not disassemble the container and return it to our Customer Support Center.

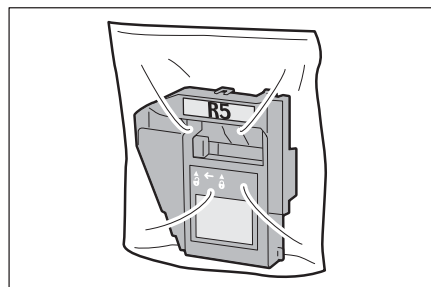

- 5** Hold a new staple scrap container by its R5 section, and insert the container, bottom first, into the machine.

Important • To prevent injury, do not put your fingers on top of the container.

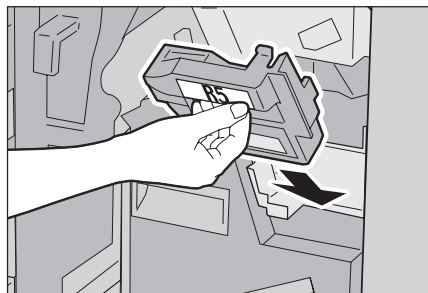

- 6** Push the R5 section of the container until the lock lever moves to the  position.

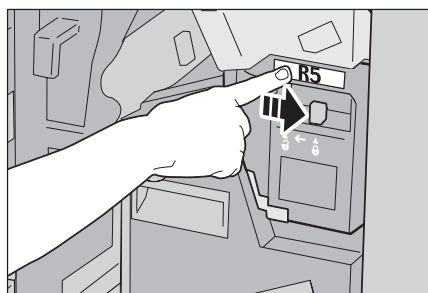

- 7** Close the right cover of the finisher.

Note • A message will be displayed and the machine will not operate if the right cover of the finisher is even slightly open.

Cleaning the Machine

The following describes how to clean the machine.

The cleaning instructions will be explained individually for various parts of the machine: the machine exterior, document cover/document glass, film/constant velocity transport glass, and document feeder roller.

⚠ WARNING

When cleaning this product, use the designated cleaning materials exclusive to it. Other cleaning materials may result in poor performance of the product. Never use aerosol cleaners, or it may catch fire and cause explosion.

⚠ CAUTION

When cleaning this product, always switch off and unplug it. Access to a live machine interior may cause electric shock.

Cleaning the Exterior

The following describes how to clean the exterior of the machine.

- Important**
- Always switch the power off and unplug the power cord before cleaning any part of the machine. Cleaning the machine with the power on may cause an electric shock.
 - Do not use benzene, paint thinner, or other volatile liquids or spray insect repellent on the machine as they might discolor, deform, or crack covers.
 - Cleaning the machine with an excessive amount of water may cause the machine to malfunction or damage documents during copying.

- 1** Wipe the exterior with a firmly wrung soft cloth moistened with water.

Important

- Do not use cleaning agents other than water or neutral detergent.

Note

- If dirt does not come off easily, gently wipe it with a soft cloth moistened with a small amount of neutral detergent.

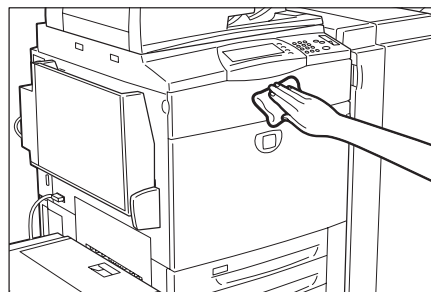

- 2** Wipe off any excess water with a soft cloth.

Cleaning the Document Cover and Document Glass

If the document cover and document glass are dirty, streaks or smears may appear on copies and the machine may not properly detect document sizes.

To ensure clean copies at all times, clean the document cover and the document roller about once a month.

- Important**
- Do not use benzene, paint thinner, or other organic solvents. Doing so might damage paint or coating on plastic parts.
 - Cleaning the machine with an excessive amount of water may cause the machine to malfunction or damage documents during copying.

- 1 Wipe the document cover with a soft cloth moistened with water to remove any dirt and then wipe it with a soft, dry cloth.

Important • Do not use cleaning agents other than water or neutral detergent.

Note • If dirt does not come off easily, gently wipe it with a soft cloth moistened with a small amount of neutral detergent.

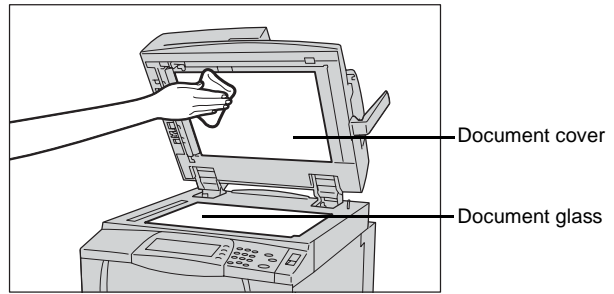

- 2 Wipe the document glass with a soft cloth moistened with water to remove any dirt, and then wipe it with a soft, dry cloth.

Important • Do not use cleaning agents other than water or neutral detergent.

Note • If dirt does not come off easily, gently wipe it with a soft cloth moistened with a small amount of neutral detergent.

Cleaning the Narrow Glass Strip and Document Presser

If the narrow glass strip and document presser are dirty, streaks or smears may appear on copies and the machine may not properly detect document sizes.

To ensure clean copies at all times, clean the narrow glass strip and document presser about once a month.

Important • Do not use benzene, paint thinner, or other organic solvents. Doing so might damage paint or coating on plastic parts.

• Cleaning the machine with an excessive amount of water may cause the machine to malfunction or damage documents during copying.

- 1 Wipe the narrow glass strip, and document presser, and the guide with a soft cloth moistened with water to remove any dirt, and then wipe them with a soft, dry cloth.

Important • Do not use cleaning agents other than water or neutral detergent.

Note • If dirt does not come off easily, gently wipe it with a soft cloth moistened with a small amount of neutral detergent.

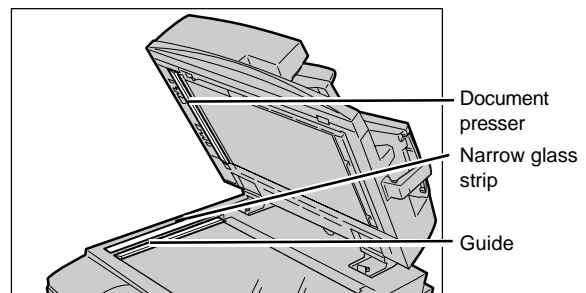

- 2 Holds the lever to open the part of the figure on the right. Wipe the narrow glass strip with a soft cloth moistened with water to remove any dirt on the optical glass, and then wipe it with a soft, dry cloth.

Important • Do not push the narrow glass strip strongly since it is easy to damage the film around the optical glass surface.

• Do not use cleaning agents other than water or neutral detergent.

Note • If dirt does not come off easily, gently wipe it with a soft cloth moistened with a small amount of neutral detergent.

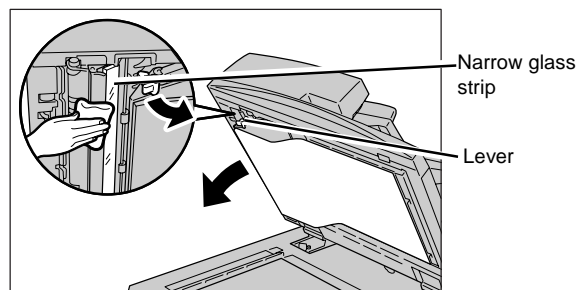

- 3 Push the center-left side of the document cover to close the belt area until it clicks into place.

Cleaning the Document Feeder Roller

If the document feeder roller is dirty, streaks or smears may appear on copies and paper jams may occur.

To ensure clean copies at all times, clean the document feeder roller about once a month.

- Important**
- Do not use benzene, paint thinner, or other organic solvents. Doing so might damage paint or coating on plastic parts.
 - Cleaning the machine with an excessive amount of water may cause the machine to malfunction or damage documents during copying or printing.

- 1 Lift the latch of the Document Feeder top cover, until it is completely open.

- Note**
- When you fully open the cover, it enters a fixed position. Open the cover gently.

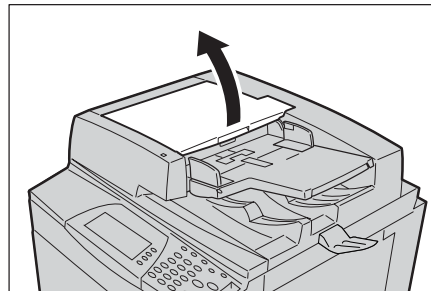

- 2 While turning the roller, gently clean it with a soft cloth moistened with water.

- Important**
- Do not use cleaning agents other than water or neutral detergent.
 - Use a cloth firmly wrung to prevent water drops from falling into the machine. If water gets into the machine, it may cause machine malfunction.

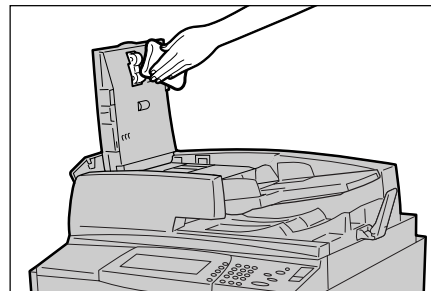

- Note**
- If dirt does not come off easily, gently wipe it with a soft cloth moistened with a small amount of neutral detergent.

- 3 Close the top cover of the document feeder until it clicks into place.
- 4 Close the left cover of the document feeder until it clicks into place.

Executing Calibration

The machine can automatically adjust gradation when the reproducibility of density or color in copies and prints has deteriorated. The machine can adjust the gradation for each screen type.

The following three types of screen is available.

- Copy Job
Adjusts the gradation for copying documents.
- Print Job 1
Basic screen for printing.
For PCL printer drivers
Adjusts the gradation for items other than [CAD] and [Presentation] of [Image Types] in the [Graphics] tab.
For PostScript printers
Adjusts the gradation for [Auto] and [Standard] of [Screen] in the [Image Options] tab.

Note • Displayed Screen may differ corresponding to settings of [Image Type], [RGB Correction] and [CMYK Correction], when [Auto] is selected.

- Print Job 2
For PCL printer drivers
Adjusts the gradation for [Presentation] at [Image Type] in the [Image Options] tab.
For PostScript printers
Adjusts the gradation for [Auto] and [Gradation] of [Screen] in the [Image Options] tab.

Note • Displayed Screen may differ corresponding to settings of [Image Type], [RGB Correction] and [CMYK Correction], when [Auto] is selected.

The following paper sizes is available for the gradation adjustment: A3, A4□, 11 x 17 inches, and 8.5 x 11 inches□.

- Note**
- We recommend executing auto gradation adjustment for all three of the screen types. When the adjustment for one screen type is complete, specify the next screen type and repeat the procedure.
 - If color gradation is not compensated despite the periodic execution of auto gradation adjustment, contact our Customer Support Center.
 - The auto gradation adjustment does not execute when [Text] or [Map] is selected for [Original Type] in the [Image Quality] tab for copying.
 - To make sure that [Copy Defaults] in the System Administration mode is set as following before executing auto gradation adjustment:
Lighten/Darken: Normal, Color Shift: Normal, Color Saturation: Normal, Color Balance: 0.
After finishing the auto gradation adjustment, change the settings of [Copy Defaults] if necessary. For information about the [Copy Default], refer to "Copy Defaults" (P.146).

1 Press the <All Services> button.

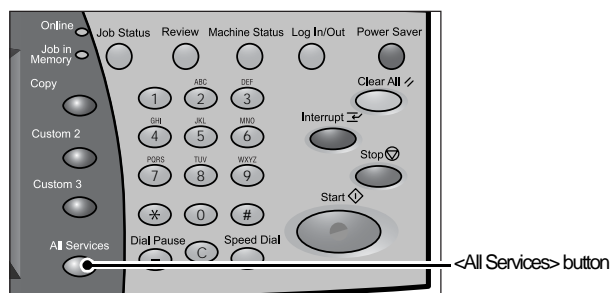

- 2 Select [Calibration], and then go to step 10.
If [Calibration] is not displayed on the [All Services] screen, go to step 3.

Note

- For the method to display [Calibration] on the [All Services] screen, refer to "All Services / All Services - Additional Features" (P.126).

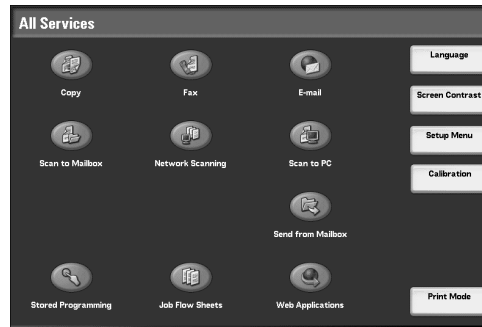

- 3 Press the <Log In/Out> button.

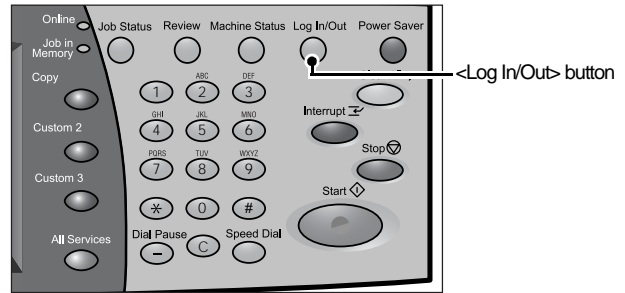

- 4 Enter the UserID with the numeric keypad or a keyboard displayed by selecting [Keyboard], and select [Confirm].

Note

- The default UserID value is "11111". When using the Authentication feature, a password is required. The default password value is "x-admin".

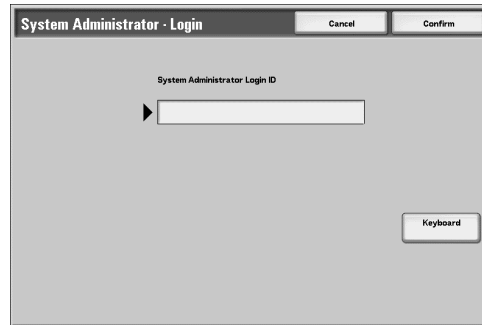

- 5 Select [System Settings].



- 6 Select [System Settings].

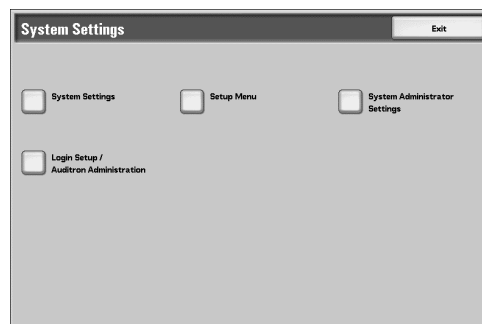

7 Select [Common Settings].

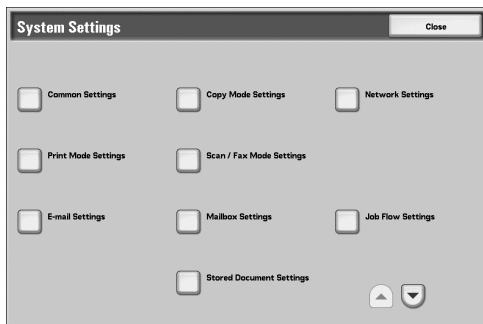

8 Select [Image Quality Adjustment].

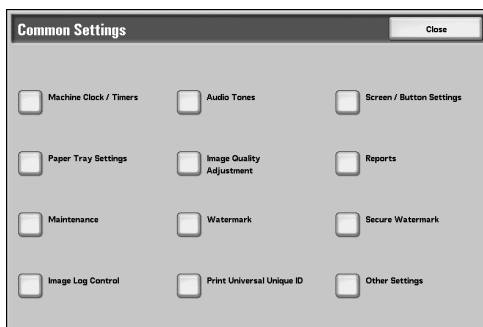

9 Select [Calibration].

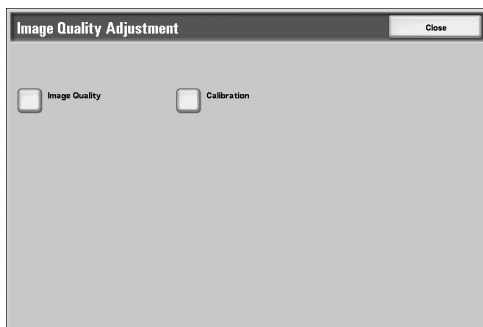

10 Load paper.

11 Select the screen type for gradation adjustment.

Note • The example described here is for the [Copy Job] screen.

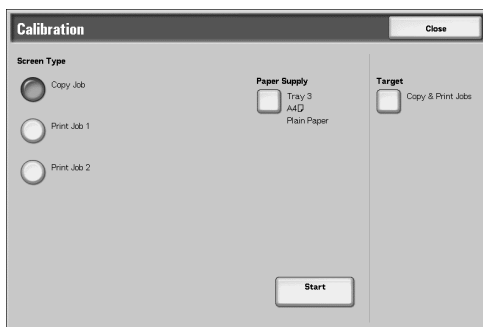

12 Select the tray that you loaded paper in the step 10 for [Paper Supply], and then select [Close].

Note • Only paper types can be set when you select the Tray 5 (bypass).

13 Select [Target] to set an area for applying the gradation adjustment, and then select [Close].

Note • Normally, select [Copy & Print Jobs] for [Applicable Area]. When using external calibration for print output, set [Applicable Area] if necessary.

14 Select [Start].

Note • The message "Outputting the CalibrationChart... - Copy Job" appears and the document for gradation adjustment (Gradation Adjustment Chart) is printed.

- 15** Open the document cover.
- 16** Align the magenta patch of the printed Gradation Adjustment Chart against the left side of the document glass.

Note

- Place the Gradation Adjustment Chart on the document glass.

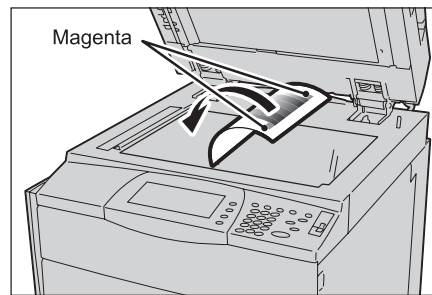

- 17** Place at least five sheets of white paper on the Gradation Adjustment Chart to cover the Chart and close the document cover.

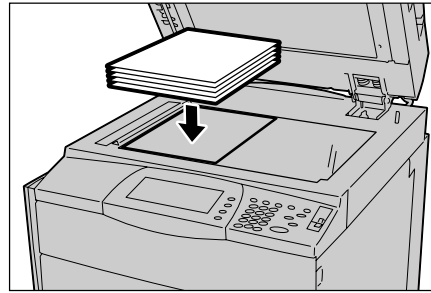

- 18** Select [Start].

The message “Gradation adjustment is in progress. Copy Job” appears and the machine automatically adjusts the gradation. It takes about 30 seconds to complete gradation adjustment.

If the adjustment completes successfully, a completion message appears on the [Auto Gradation Adjustment] screen. If there is a problem, the machine stops adjustment and displays an error message. Solve the problem in accordance with the displayed error message.

- 19** Select [Confirm].
- 20** To continue automatic gradation adjustment for other screen types, repeat steps 11 to 19.
- 21** When you started the auto gradation adjustment from the [All Services] screen, select [Close] and the go to step 2. started the adjustment in the System Administration mode, select [Close] until the [System Settings] screen appears.
- 22** Select [Exit] to exit the System Administration mode.
- 23** Make a copy or print to confirm the image quality.

Printing a Report/List

This section describes how to print a report/ list.

- Note**
- The items displayed vary depending on the optional features installed.
 - When the <Job in Memory> indicator is lit, you can confirm the documents stored to memory in the [Stored Documents List].

For information about report/list types, refer to "Print Report/List" (P.97).

- 1 Press the <Machine Status> button.

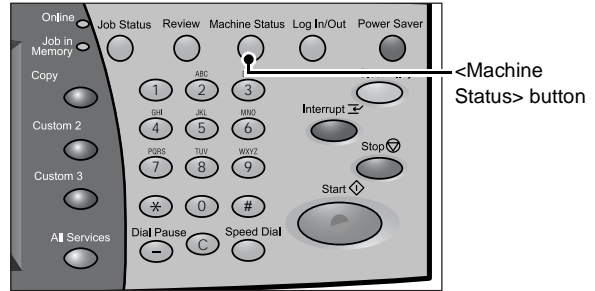

- 2 Select the [Billing Meter/Print Report] tab.

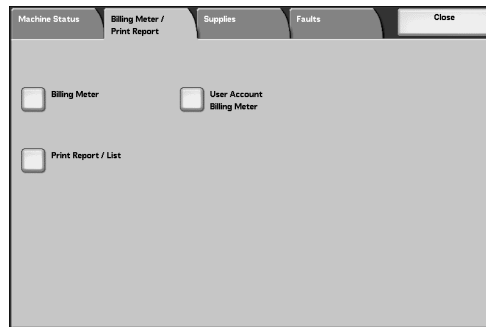

- 3 Select [Print Report/List].

- Note**
- If [Print Report Button] under [Reports] is set to [Disabled], the [Print Report/List] button appears only in [User Mode] of the System Administration mode. For information on [Reports], refer to "Reports" (P.131).

- 4 Select a report or list you want to print and press the <Start> button.

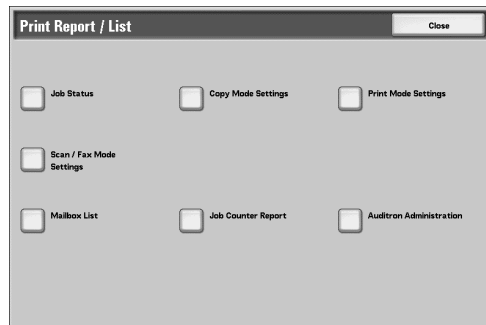

4 Job Status

This chapter describes the job status feature.

- Job Status Overview 72
- Checking Current/Pending Jobs 73
- Checking Completed Jobs 74
- Printing and Deleting Stored Documents 75
- Printing Pending Jobs 84
- Handling Error Terminations 85

Job Status Overview

The job status feature allows you to check current, pending, and completed jobs. You can also cancel printing and print pending jobs.

- 1 Press the <Job Status> button.

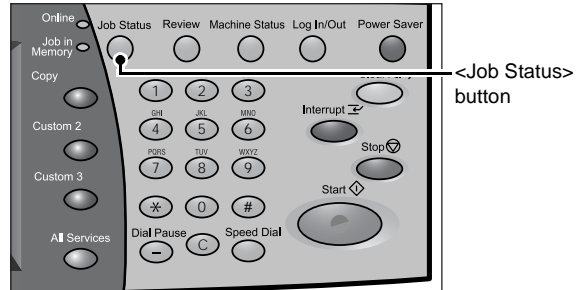

You can do the following on the [Job Status] screen.

■Checking Current/Pending Jobs

Lists current and pending jobs, and displays their details. Also allows you to cancel current or pending jobs.

For more information, refer to "Checking Current/Pending Jobs" (P.73).

■Checking Completed Jobs

Displays the status of completed jobs. Also displays their details.

For more information, refer to "Checking Completed Jobs" (P.74).

■Checking Stored Documents

Prints or deletes documents stored using the Charge Print, Secure Print, Private Charge Print, Sample Print, and Delayed Print features.

For more information, refer to "Printing and Deleting Stored Documents" (P.75).

Checking Current/Pending Jobs

This section describes how to check current or pending jobs. On the status screen, you can cancel or preferentially execute jobs.

- 1 Press the <Job Status> button.
- 2 Check the current/pending jobs.

- Note**
- Select [▲] to return to the previous screen or [▼] to move to the next screen.
 - You can select job type to be displayed from [All Jobs], [All Printing Jobs], [All Non-printing Jobs] and [Mailbox Transfer Jobs].

Document / Job Type	Remote Terminal / Contents	Status	Progress
- - Get Information	ESR_LOG_TRNS		
0001 - E-mail in Mailbox	Ebina		99%
- - Print Report			
- - Print Report	Job History Report (All)		
00133 - Fax Store	Store for Private Polling	Scanning	32%
09999 - Image Log		In Progress	3/10
14111 - Mailbox to PC	Client	Generating Log	50%
14111 - Mailbox to PC	Client	Transfer Wait	55%
77777 - Network Scanning	NAMAE	Generating Log	50%
77777 - Network Scanning	NAMAE	Transfer Wait	

- 3 Select the job to be cancelled or preferentially executed.
- 4 Select [Cancel] or [Promote Job].

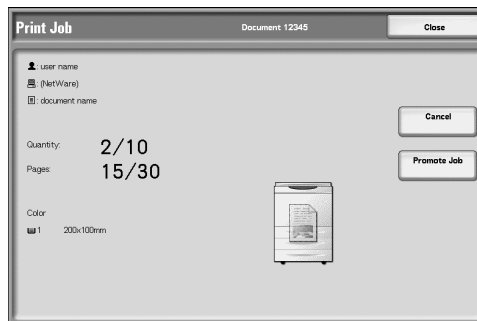

■Print Waiting Jobs

Select this to print the jobs that are waiting to be output.
For more information, refer to "Printing Pending Jobs" (P.84).

■Cancel

Cancels the current or pending job.

■Promote Job

Preferentially executes the selected job.
A [👉] will be marked on the [Status] of the job set to [Promote Job].

■Stop

Stops the job processing.

■Last Original

Select this to end scanning of documents. The job is then executed.

■Next Original

Select this when you have another document to scan.

■Start

Resumes the stopped job.

Checking Completed Jobs

This section describes how to check completed jobs.

You can check whether a job has been completed successfully. Also, you can select a job to see the details.

- 1 Press the <Job Status> button.
- 2 Select the [Completed Jobs] tab.

Note

- Select [▲] to return to the previous screen or [▼] to move to the next screen.
- When using ApeosPort series models, you can select job type to be displayed from [All Jobs], [All Printing Jobs], [All Non-printing Jobs] and [Mailbox Transfer Jobs].

Document / Job Type	Remote Terminal / Contents	Status	Pages
- - Copy	A4	Completed	1/1
00009 - Poll Send		Completed	
- - Mailbox Receive	BARUTANHOST NAME	Completed	
99999 - Mailbox Print		Completed	1/5
- - E-mail Send	10	Completed	10%
00007 - Fax Send	DstCstCst	Completed	
99999 - Fax Broadcast	Fax: 88	Completed	
99999 - Fax Broadcast	Fax: 99	Completed	
- - E-mail in Mailbox	root.tok@osulias.com	Completed	
00001 - Fax / Fax Broadcast	Fax: 33, ifax: 44	Completed	

- 3 Select a job to see the details.
- 4 Select [Close] after the check.

Original Size	: A4
Output Color	: Black
Status	: Completed
Job Ended	: 2007/05 2:37 PM
Quantity	: 1 / 1
Pages	: 1 / 1
Paper	: 3 A4

■ Group Parent Jobs

Allows you to check the list or history of related jobs (such as job flow jobs).

■ Show Children Jobs

Displays a job list.

■ Job History Report

Prints the job results to allow you to check the job history.

■ Job Report

Prints a job status information report.

Printing and Deleting Stored Documents

This section describes how to print or delete documents stored with the Secure Print or Sample Print feature, or stored with the charge print receiving control. The [Job Status] screen allows you to print or delete stored documents.

The following shows the reference section for each item.

Secure Print	75
Sample Print	77
Delayed Print.....	78
Charge Print.....	79
Private Charge Print	81

- 1 Press the <Job Status> button.
- 2 Select the [Stored Documents] tab.

Note • The buttons displayed on the screen vary depending on the settings related to the Private Charge Print feature.

For more information, refer to "Charge / Private Print Settings" (P.206).



Secure Print

This section describes how to print or delete documents stored with the Secure Print feature.

For information on secure print operations, refer to the print driver's help.

Note • This feature is not displayed when the Private Charge Print feature is enabled by using one of the following procedures:
 - Select [Save in Private Charge Print] under [Receive Control].
 - Select [According to Print Auditor] under [Receive Control], and then set [Job Login Success] to [Save in Private Charge Print]. Under [Login Setup / Auditor Mode], select an option other than [Off], and then set [Print Service] under [Auditor Mode] to [On].
 • When you have selected [Save in Private Charge Print] or [Save in Charge Print] for [Receive Control] under [Charge/Private Print Settings], jobs will not be saved in [Secure Print] under [Stored Documents] even if you select [Secure Print] on the print driver.

For more information, refer to "Charge / Private Print Settings" (P.206).

- 1 Select [Secure Print].
- 2 Select the user to be checked, and select [Document List].

Note • Select [Refresh] to display the updated information.
 • Select [▲] to return to the previous screen or [▼] to move to the next screen.
 • Entering a 3-digit billing ID with the numeric keypad specifies the user directly.

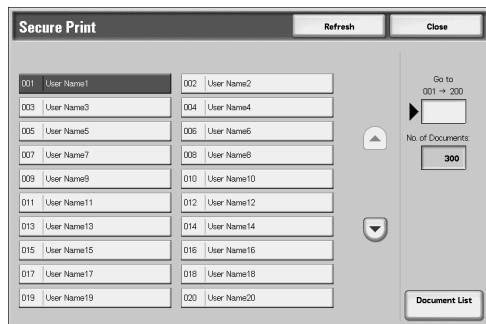

- 3 Enter the passcode, and select [Confirm].

Note • If no passcode is assigned, the passcode entry screen will not appear.

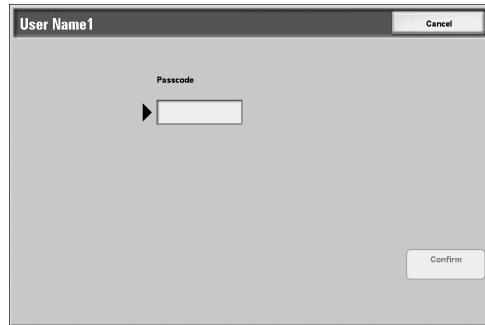

- 4 Select the document to be printed or deleted.
- 5 When printing, specify the number of print using the numeric keypad.
- 6 Select any item.



■Select All

Selects all documents. To deselect all the documents, select this button again.

■Delete

Deletes the selected document.

Note • If documents with the same Billing ID are all deleted, the Billing ID will be deleted. Refer to "When [Delete] is Selected" (P.76).

■Print

Prints the selected document.

Refer to "When [Print] is Selected" (P.77).

When [Delete] is Selected

- 1 Select [Yes].

■Yes

Deletes the document.

Important • Once the document is deleted, it cannot be restored.

■No

Cancels deleting the document.

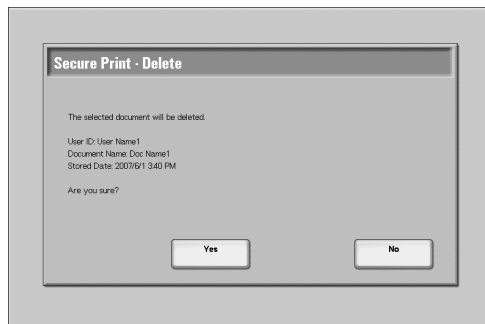

When [Print] is Selected

- 1 Select what to do with the document after printing.

■ **Print and Delete**

Starts printing the document. After printing, deletes the document.

■ **Print and Save**

Starts printing the document. After printing, the document remains undeleted.

■ **Cancel**

Cancels printing the document.

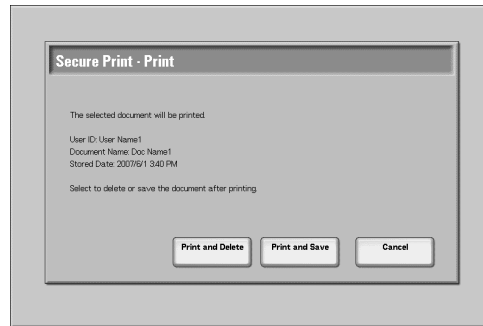

Sample Print

This section describes how to print or delete documents stored with the Sample Print feature.

After a sample copy is output, the remaining copies will automatically be output if the machine is left uninstructed for the period specified under [Auto Job Release]. You can change the value of [Auto Job Release] as necessary.

For information on sample print operations, refer to the print driver's help.

Note • When you have selected [Save in Private Charge Print] or [Save in Charge Print] for [Receive Control] under [Charge/Private Print Settings], jobs will not be saved in [Sample Print] under [Stored Documents] even if you select [Sample Print] on the print driver.

For more information, refer to "Charge / Private Print Settings" (P.206).

- 1 Select [Sample Print].
- 2 Select the user to be checked, and select [Document List].

- Note**
- Select [Refresh] to display the updated information.
 - Select [▲] to return to the previous screen or [▼] to move to the next screen.
 - Entering a 3-digit user ID with the numeric keypad specifies the user directly.

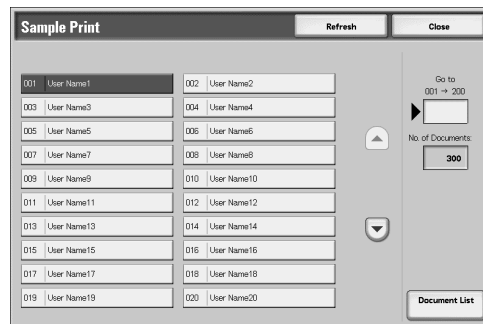

- 3 Select the document to be printed or deleted.
- 4 Select any item.

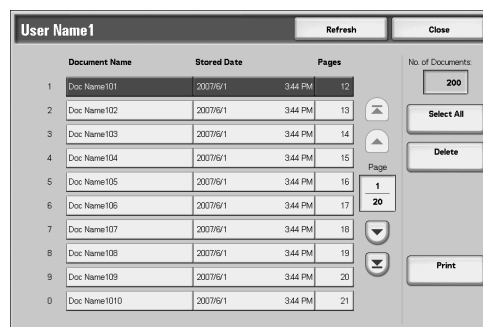

■ Select All

Selects all documents. To deselect all the documents, select this button again.

■ Delete

Deletes the selected document.

Refer to "When [Delete] is Selected" (P.78).

■ Print

Prints a Sample Print document. After printing the remaining sets of the document, the stored Sample Print document is deleted.

Refer to "When [Print] is Selected" (P.78)

When [Delete] is Selected

1 Select [Yes].

■ Yes

Deletes the document.

Important • Once the document is deleted, it cannot be restored.

■ No

Cancels deleting the document.

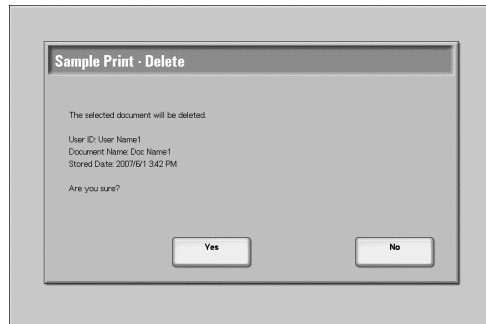
**When [Print] is Selected**

1 Select [Yes].

■ Yes

Starts printing the document. After printing, deletes the document.

■ No

Cancels printing the document.

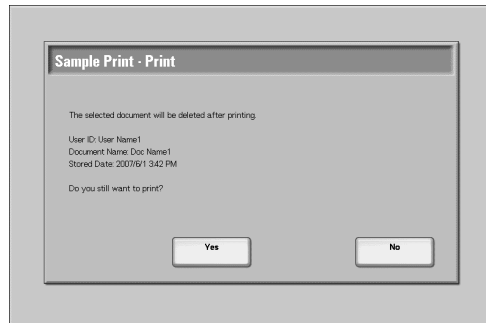
**Delayed Print**

This section describes how to print or delete documents stored with the Delayed Print feature.

For information on Delayed Print operations, refer to the print driver's help.

Note • When you have selected [Save in Private Charge Print] or [Save in Charge Print] for [Receive Control] under [Charge/Private Print Settings], jobs will not be saved in [Delayed Print] under [Stored Documents] even if you select [Delayed Print] on the print driver.

For more information, refer to "Charge / Private Print Settings" (P.206).

1 Select [Delayed Print].

- 2 Select the document to be printed or deleted.

- Note**
- Select [Refresh] to display the updated information.
 - Select [▲] to return to the previous screen or [▼] to move to the next screen.
 - [Print Time] shows the time to start printing.



- 3 Select any item.

■Delete

Deletes the selected document.
Refer to "When [Delete] is Selected" (P.79).

■Print

Prints the selected document. After printing, deletes the document. If printed manually, the document will not be printed at the specified time.
Refer to "When [Print] is Selected" (P.79).

When [Delete] is Selected

- 1 Select [Yes].

■Yes

Deletes the document.
Important • Once the document is deleted, it cannot be restored.

■No

Cancels deleting the document.

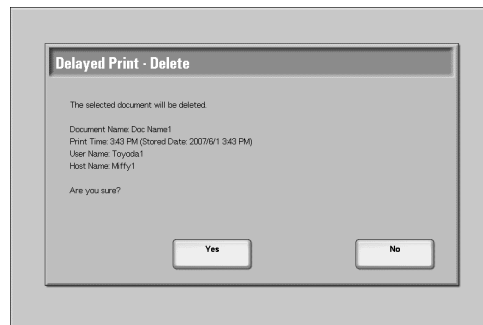

When [Print] is Selected

- 1 Select [Yes].

■Yes

Starts printing the document. After printing, deletes the document.

■No

Cancels printing the document.

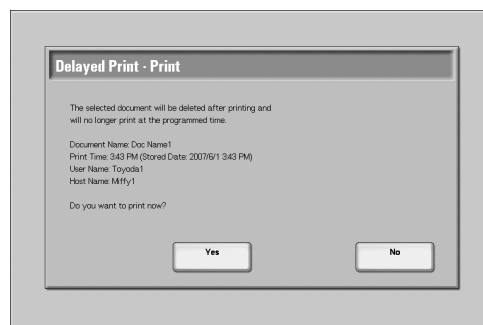

Charge Print

When you set to use the Charge Print feature under [Charge/Private Print Settings] > [Receive Control], received print jobs are saved for each Billing ID. Any jobs that were not given a Billing ID on the print driver are saved in [No User ID].

For more information, refer to "Charge / Private Print Settings" (P.206).

The following describes how to print and delete a document saved in Charge Print.

- 1 When printing the stored jobs, the authentication is required. Press the <Log In/Out> button. Enter the target user ID using the numeric keypad or the keyboard displayed by pressing [Keyboard], and select [Confirm].
When deleting the stored jobs, the authentication is not required.



- 2 Select [Charge Print].
- 3 Select the user to be checked, and select [Document List].

- Note**
- Select [Refresh] to display the updated information.
 - Select [▲] to return to the previous screen or [▼] to move to the next screen.
 - Entering a 3-digit user ID with the numeric keypad specifies the user directly.

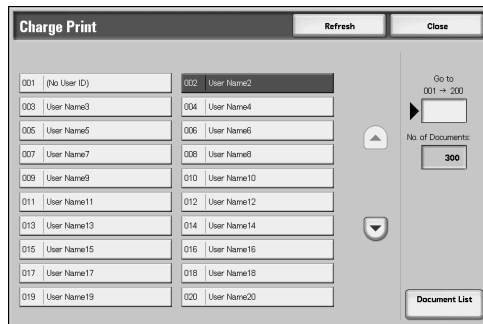

- 4 Enter the passcode, and select [Confirm].
- Note**
- If no passcode is assigned, the passcode entry screen will not appear.

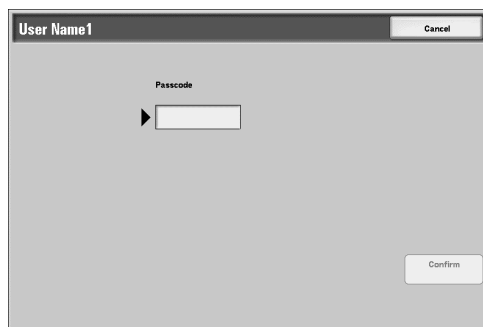

- 5 Select the document to be printed or deleted.
- 6 When printing, specify the number of print using the numeric keypad.
- 7 Select any item.



- **Delete**
Deletes the document stored with Charge Print.
Refer to "When [Delete] is Selected" (P.81).

- **Print**
Prints the document stored with Charge Print.
Refer to "When [Print] is Selected" (P.81).

When [Delete] is Selected

1 Select [Yes].

■ **Yes**

Deletes the document.

Important • Once the document is deleted, it cannot be restored.

■ **No**

Cancels deleting the document.

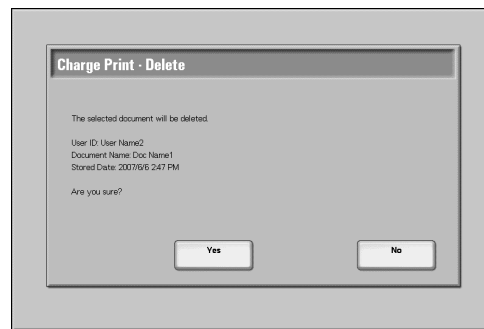

When [Print] is Selected

1 Select what to do with the document after printing.

■ **Print and Delete**

Starts printing the document. After printing, deletes the document.

■ **Print and Save**

Starts printing the document. After printing, the document remains undeleted.

■ **Cancel**

Cancels printing the document.

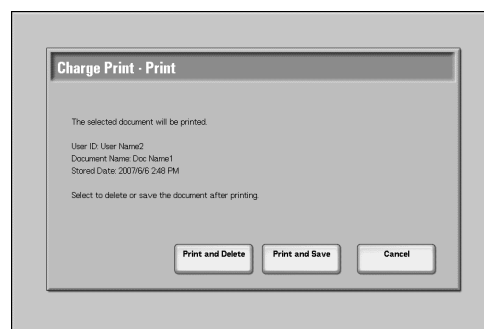

Private Charge Print

When you set to use the Private Charge Print feature, received print jobs are saved for each authentication user ID.

Note

- This item is displayed when the Private Charge Print feature is enabled by using one of the following procedures:
 - Select [Save in Private Charge Print] under [Receive Control].
 - Select [According to Print Auditor] under [Receive Control], and then set [Job Login Success] to [Save in Private Charge Print]. Under [Login Setup / Auditor Mode], select an option other than [Off], and then set [Print Service] under [Auditor Mode] to [On].
- When deleting the print job instructed with an invalid user ID, display the list of print jobs in the authenticated system administrator mode, and then select the job to be deleted. For more information, refer to "Deleting the Print Job with an Invalid User ID" (P.83)

For more information, refer to "Charge / Private Print Settings" (P.206).

The following describes how to print or delete a document stored with the Private Charge Print feature.

1 Press the <Log In/Out> button.

2 Enter the user ID with the numeric keypad or the keyboard displayed by pressing [Keyboard], and select [Confirm].

3 Select [Private Charge Print].

Note • If you are authenticated as a system administrator, selecting [Private Charge Print] will display a list of authentication user IDs. Select a user ID from the list, and then select [Document List] to display a list of documents stored for the selected user.



4 Select the document to be printed or deleted.

5 When printing, specify the number of print using the numeric keypad.

6 Select any item.

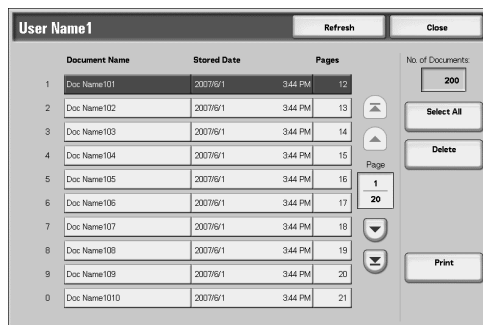

■Select All

Selects all documents. To deselect all the documents, select this button again.

■Delete

Deletes the Private Charge Print document.

Note • If documents with the same user ID are all deleted, the user ID will be deleted. Refer to "When [Delete] is Selected" (P.82).

■Print

Prints the Private Charge Print document.

Refer to "When [Print] is Selected" (P.83).

When [Delete] is Selected

1 Select [Yes].

■Yes

Deletes the document.

Important • Once the document is deleted, it cannot be restored.

■No

Cancels deleting the document.

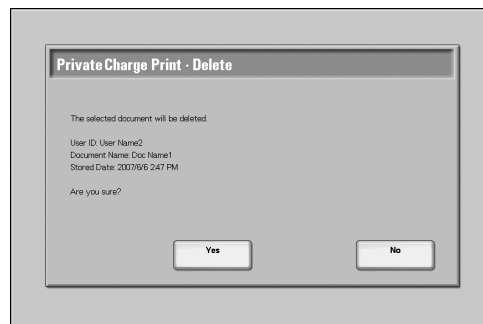

When [Print] is Selected

- 1 Select what to do with the document after printing.

■ Print and Delete

Starts printing the document. After printing, deletes the document.

■ Print and Save

Starts printing the document. After printing, the document remains undeleted.

■ Cancel

Cancels printing the document.

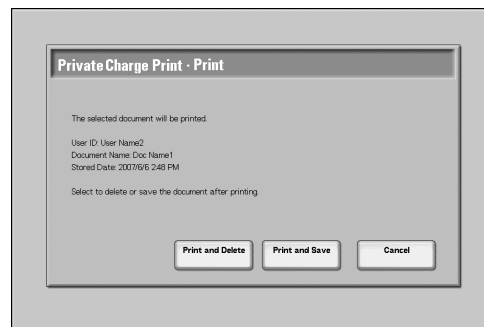

Deleting the Print Job with an Invalid User ID

All the print jobs that have a User ID regardless whether it is valid User ID or not are stored with the Private Charge Print feature. To minimize the unnecessary print jobs, specify how long print jobs can be saved for, so that they can be automatically deleted after a specified period of time. Or the system administrator can manually delete them.

The following describes how to delete documents that have an invalid User ID stored with the Private Charge Print feature.

For details on how to specify a duration of how long the print jobs are kept, refer to "Mailbox/Stored Document Settings" (P. 180).

- 1 Press the <Log In/Out> button.
- 2 Enter the user ID with the numeric keypad or the keyboard displayed by pressing [Keyboard], and select [Confirm].
- 3 Select [User Mode].
- 4 Press the <Job Status> button.
- 5 Select the [Stored Documents] tab.
- 6 Select [Private Charge Print].
- 7 Select the User ID to be deleted.
- 8 Select the document to be deleted, and then select [Delete].



Printing Pending Jobs

This section describes how to print pending jobs.

Note • If there are no pending jobs, the [Print Waiting Jobs] button is disabled.

- 1 Press the <Job Status> button.
- 2 Select [Print Waiting Jobs].



Document / Job Type	Remote Terminal / Contents	Status	Progress
- - Get Information	ESR_LOG_TRNS		
0001 - E-mail in Mailbox	Ebna		99%
- - Print Report			
- - Print Report	Job History Report (All)		
00133 - Fax Store	Store for Private Polling	Scanning	82%
09999 - Image Log		In Progress	3/10
14111 - Mailbox to PC	Client	Generating Log	50%
14111 - Mailbox to PC	Client	Transfer Wait	55%
77777 - Network Scanning	NAMAE	Generating Log	50%
77777 - Network Scanning	NAMAE	Transfer Wait	

Handling Error Terminations

This section describes how to handle error terminations.

■ For a Print Job

Select a job shown as an error termination in the [Completed Jobs] tab to check the error code. Follow the error code instructions.

For information on error codes, refer to "Error Code" (P.323).

■ For a Scan Job

A transmission report (undelivered) is printed.

For more information on transmission reports (undelivered), refer to "Transmission Report - Undelivered" (P.103). For details on how to print transmission reports (undelivered) automatically, refer to "Scan File Transfer Report" (P.131).

■ For Other Jobs

Print a Job History Report, and check the execution results.

For information about job history reports, refer to "Job Status" (P.97).

5 Machine Status

This chapter describes the features for checking the machine status.

- Overview of Machine Status 88
- Machine Status 89
- Billing Meter/Print Report..... 95
- Supplies 104
- Faults 105

Overview of Machine Status

You can check machine status and the number of printed pages on the screen. You can also print various reports/lists to check the job history, settings and registered information.

- 1 Press the <Machine Status> button.

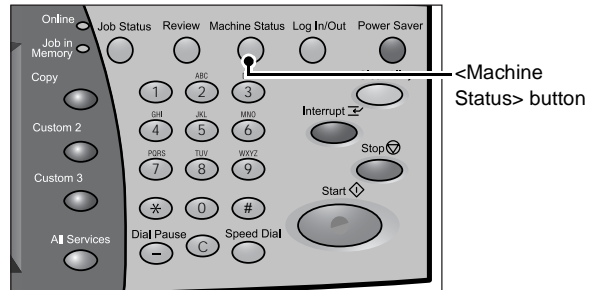

The [Machine Status] screen offers the following features.

■ Machine Status

You can check the machine configuration, paper tray status, and hard disk overwriting status. You can also set print modes.

For more information, refer to "Machine Status" (P.89).

■ Billing Meter/Print Report

You can check the number of pages printed by meter or user. You can also print various reports/lists to check the job history, settings and registered information.

For more information, refer to "Billing Meter/Print Report" (P.95).

■ Supplies

You can check the status of consumables.

For more information, refer to "Supplies" (P.104).

■ Faults

You can check the faults that occurred on the machine.

For more information, refer to "Faults" (P.105).

Machine Status

On the [Machine Status] screen, you can check the machine configuration and paper tray status. You can also change settings for the print mode.

The following shows the reference section for each item.

Machine Information.....	89
Paper Tray	91
Overwrite Hard Disk	91
Print Mode.....	91

- 1 Press the <Machine Status> button.
- 2 On the [Machine Status] screen displayed, you can check the machine status.

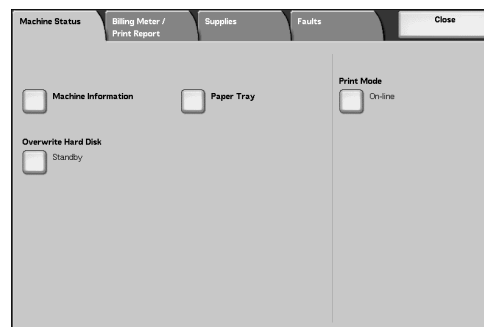

Machine Information

On the [Machine Information] screen, you can check the serial number of the machine, machine configuration, and software version.

- 1 Select [Machine Information].
- 2 Check the machine information in a screen displayed.

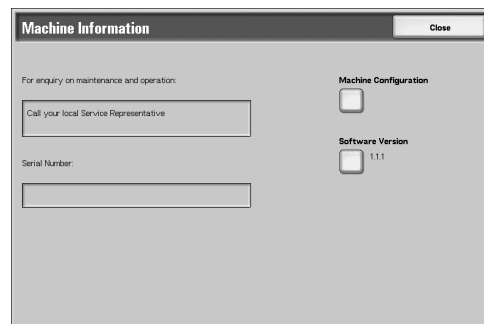

■ For enquiry on maintenance and operation

Indicates how to make maintenance and operating enquiries.

■ Serial Number

Indicates the serial number of the machine.

■ Machine Configuration

Displays the [Machine Configuration] screen.

■ Software Version

Displays the [Software Version] screen.

[Machine Configuration] Screen

You can check the machine configuration.

- 1 Select [Machine Configuration].
- 2 Check the machine configuration in a screen displayed.

Note • Select [▲] to return to the previous screen or [▼] to move to the next screen.



On the [Machine Configuration] screen, you can check the following items.

- Configuration Code
- Auto Document Feeder
- Paper Tray
- High Capacity Feeder
- Separators/Covers Tray
- Offset Stacking Module
- Output Device
- Booklet Maker
- 2 Sided Printing Unit
- Hard Disk
- Page Memory Size
- System Memory Size
- Image Compression Kit
- PostScript
- ESC/P
- HP-GL/2
- PCL
- PDF
- USB

Note • [Output Device] indicates whether or not a finisher (optional) is installed. If Finisher is installed, it is displayed as "Finisher".

[Software Version] Screen

You can check the software version.

- 1 Select [Software Version].
- 2 Check the software version in a screen displayed.

Note • Select [▲] to return to the previous screen or [▼] to move to the next screen.

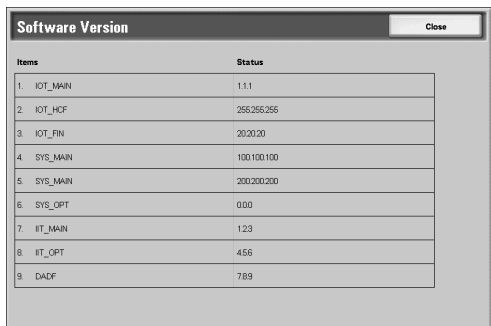

On the [Machine Configuration] screen, you can check the following items.

- Controller ROM
- IOT ROM
- HCF ROM
- Finisher C ROM
- IIT Option ROM
- ADF ROM
- IPS Accelerator ROM
- SJFI

- Finisher D ROM
- IIT ROM
- SSMI

Paper Tray

You can check the paper trays set on the machine. On the screen, you can check the following items.

- Status
- % Full (Amount of paper remaining)
- Paper Size
- Paper Type

- 1 Select [Paper Tray].
- 2 Check the paper trays in a screen displayed.

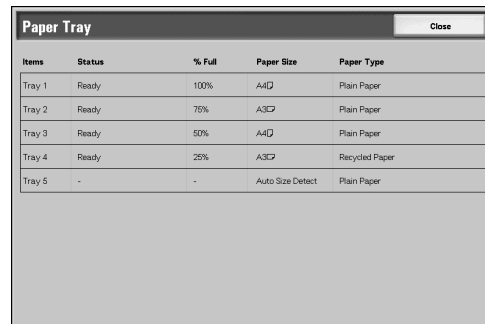

Items	Status	% Full	Paper Size	Paper Type
Tray 1	Ready	100%	A4	Plain Paper
Tray 2	Ready	75%	A3	Plain Paper
Tray 3	Ready	50%	A4	Plain Paper
Tray 4	Ready	25%	A3	Recycled Paper
Tray 5	-	-	Auto Size Detect	Plain Paper

Overwrite Hard Disk

You can check the overwriting status of the hard disk. The indication "Overwriting" shows that the overwriting is in progress. "Standby" shows the completion of the overwriting process.

- Note**
- This feature does not appear for some models. An optional package is necessary. For more information, contact our Customer Support Center.
 - [Overwrite Hard Disk] appears only when [Overwrite Hard Disk] is enabled in [System Settings]. For more information, refer to "Overwrite Hard Disk" (P.141).

- 1 Select [Overwrite Hard Disk].
- 2 Check the overwriting status of the hard disk.

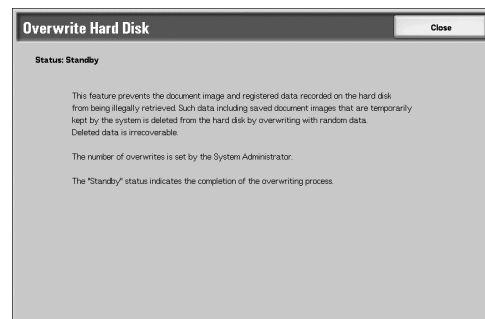

Print Mode

You can change and register each setting in the print mode.

- Note**
- The items displayed vary depending on the options installed.

- 1 Select [Print Mode].
- 2 Select [Off-line] or [On-line].

■ **Off-line**

The printer cannot accept data. Any data being sent is cancelled and not printed.

■ **On-line**

The printer can accept data.

- 3 Select a printer language.
- 4 Select the item to be set.

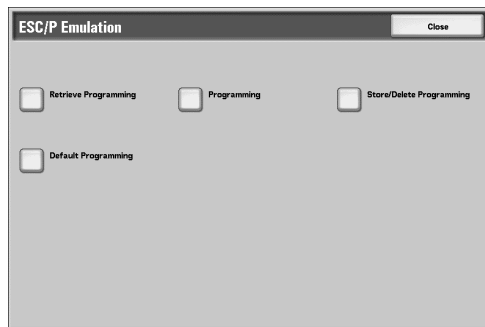
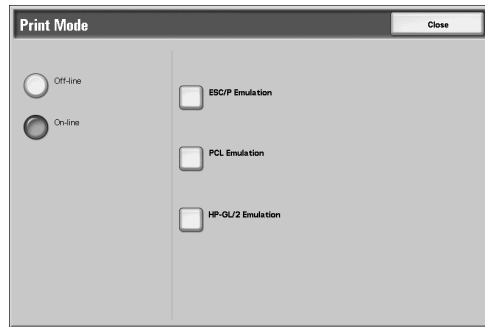

Retrieve Programming

You can retrieve and use settings registered in the memory.

- 1 Select [Retrieve Programming].
- 2 Select the memory number to be used.

■ **Factory Defaults**

You can use the factory default settings.

■ **Custom Settings**

The numbers stored in the memory appear.

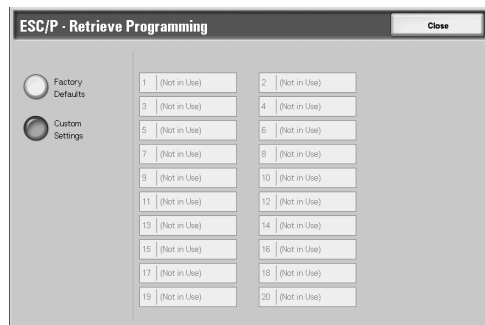

Programming

You can check or change the values set for the print mode item numbers.

For information on item numbers that can be set in the each emulation mode menus, refer to "Appendix" (P.409).

For information on KS/KSSM emulation mode, refer to the User Guide for the Korean model. For information on the ESCPK emulation mode, refer to the User Guide for the Traditional Chinese model or Simplified Chinese model.

- 1 Select [Programming].

- 2 Enter the feature number to be set in [Item Number] using the numeric keypad.
- 3 Select [Confirm] as necessary.
- 4 Select [Change Value].



- 5 Enter [New Value] using the numeric keypad.
- 6 Select [Save].

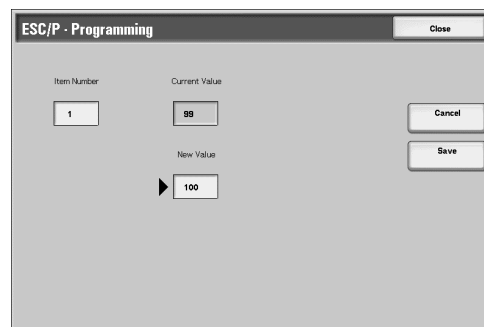

■Item number

Enter the item number of the feature to be set.

■Current Value

When you enter [Item Number], the currently set value appears.

■New Value

Enter a new value.

Store/Delete Programming

For ESC/P-K, HP-GL/2 emulations, you can register settings in the memory. You can register up to 20 print modes for ESC/P-K and HP-GL/2 emulations.

- 1 Select [Store/Delete Programming].
- 2 Select [Store Current Selections] or [Delete].
- 3 Select the memory number to be stored or to be deleted.

■Store Current Selections

Stores the current selections. If you select a number already stored, its settings will be overwritten with the new settings. The overwritten settings cannot be restored.

■Delete

When you select [Delete] and then select the number to be deleted, the number will be deleted.

Important • The deleted numbers cannot be restored.

Default Programming

You can start the printer using the settings stored in the memory as default settings.

- 1 Select [Default Programming].

- 2 Select [Factory Defaults] or [Custom Settings].
- 3 When you select [Custom Settings], select the memory number to be used.

■ Factory Defaults

You can use the factory default settings.

■ Custom Settings

The numbers stored in the memory appear.



Password

For PDF emulation, if a password is set for PDF files, set the password here in advance. PDF files can be printed only when their password matches the password set here.

You can use up to 32 characters for the password.

- 1 Press [Password].
- 2 Select [Keyboard].
- 3 Enter a password of up to 32 characters, and select [Save].
- 4 Repeat Steps 2 and 3 to reenter the same password.
- 5 Select [Save].

Billing Meter/Print Report

On the [Billing Meter/Print Report] screen, you can check the number of printed pages for each meter or user. You can also print various reports/lists to check the job history, settings and registered information.

The following shows the reference section for each item.

Billing Meter	95
User Account Billing Meter	96
Print Report/List	97
Automatically Printed Reports/Lists	103

- 1 Press the <Machine Status> button.
- 2 Select the [Billing Meter/Print Report] tab.

Important • If [Print Report Button] under [Reports] is set to [Disabled], [Print Report/List] appears only in [User Mode] of the System Administration mode. For information on [Reports], refer to "Reports" (P.131).

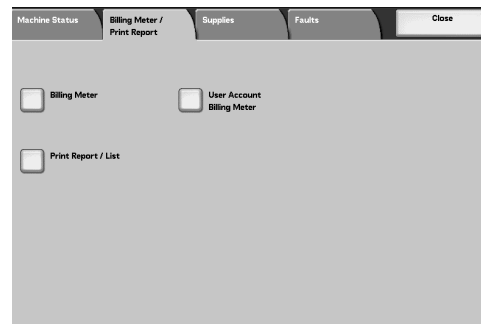

Billing Meter

You can confirm the total number of copies and printed pages by individual meters. The meters are classified by color mode.

- 1 Select [Billing Meter].
- 2 Confirm the total number of copies and printed pages in a screen displayed.

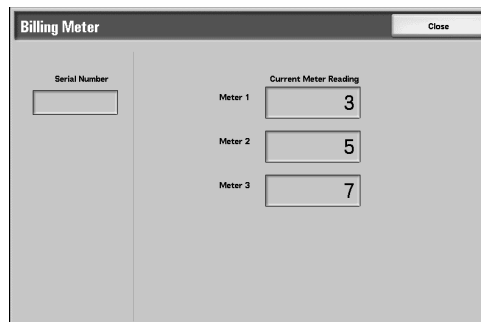

■Serial Number

Displays the serial number of the machine.

■Meter 1

Number of B/W copies + Number of B/W prints.

■Meter 2

(Reserved)

■Meter 3

Number of full color copies + Number of full color prints.

User Account Billing Meter

You can check the number of pages printed in monochrome and colors for each user. When the Login Setup/Auditron Administration feature is enabled, you can check the billing meters for the currently authenticated user IDs.

For information on the Login Setup/Auditron Administration feature, refer to "Login Setup/Auditron Mode" (P.209).

- 1 Press the <Log In/Out> button.

■ To check the billing meter of a currently authenticated user ID

- 1) Using the numeric keypad or the keyboard displayed by pressing [Keyboard], enter the user ID of a user whose billing meter needs to be checked, and select [Confirm].

Note • Enter the passcode if required.



- 2) Press the <Machine Status> button.
- 3) Proceed to Step 2.

■ To check the system administrator meter

- 1) Using the numeric keypad or the keyboard displayed by pressing [Keyboard], enter the user ID to enter the System Administration mode, and select [Confirm].

Note • Enter the passcode if required.

- 2) Select [User Mode].
- 3) Press the <Machine Status> button.
- 4) Proceed to Step 2.



- 2 Select the [Billing Meter/Print Report] tab.
- 3 Select [User Account Billing Meter].

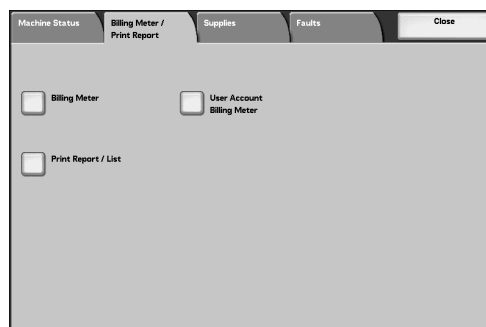

4 Select the meter to be checked.

■ Meter (Copy Jobs)

Displays the number of pages copied.

■ Meter (Scan Jobs)

Displays the number of pages scanned.

■ Meter (Print Jobs)

Displays the number of pages printed.

Print Report/List

This section describes how to print a report/ list.

Note • The items displayed vary depending on the optional features installed.

- 1 Select [Print Report/List].
- 2 Select the report/list to be output.

Note • The image shown right is the screen displayed by selecting [User Mode] in the System Administration mode.

• Select [▲] to return to the previous screen, select [▼] to move to the next screen.

Job Status

- 1 Select [Job Status].

Note • To display the [Job Status] screen, select the <Machine Status> button, and then select [Billing Meter/Print Report] > [Print Report/List] > [Job Status].

- 2 Select the report/list to be output.
- 3 Press the <Start> button.

■ Job History Report

You can check job results. The data for the latest 200 jobs is printed.

If [All Jobs] is selected, the [Include Children Jobs] check box appears. Clearing this check box prints the related jobs (such as job flow jobs) on one line. Selecting this check box prints each related job on each line.

You can also automatically print a [Job History Report] every 50 jobs.

For information about the Auto Print setting, refer to "Reports" (P.131). The Auto Print feature prints the results of all jobs.

■Error History Report

You can print error information about the machine. The latest 50 errors are printed.

Copy Mode Settings

- 1 Select [Copy Mode Settings].

Note • To display the [Copy Mode Settings] screen, select the <Machine Status> button, and then select [Billing Meter/Print Report] > [Print Report/List] > [Copy Mode Settings].

- 2 Select [Settings List - Common Items].

- 3 Press the <Start> button.

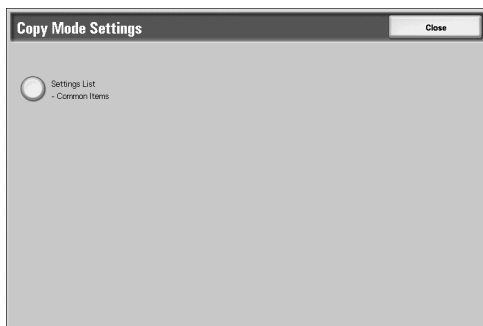

■Settings List - Common Items

You can check the hardware configuration, network information, and print and copy settings of the machine.

Note • The content of [Settings List] is identical whether it is printed from [Copy Mode Settings], [Print Mode Settings], or [Scan/Fax Mode Settings].

Print Mode Settings

- 1 Select [Print Mode Settings].

Note • To display the [Print Mode Settings] screen, select the <Machine Status> button, and then select [Billing Meter/Print Report] > [Print Report/List] > [Print Mode Settings].

- 2 Select the list to be printed.

- 3 Press the <Start> button.

Note • The items displayed vary depending on the options installed.

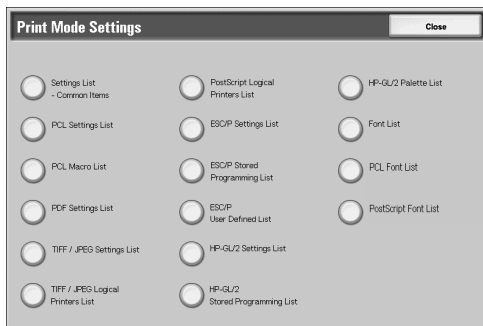

■Settings List - Common Items

Allows you to check the hardware configuration, network information, and print and copy settings of the machine.

Note • The content of [Settings List] is identical whether it is printed from [Copy Mode Settings], [Print Mode Settings], or [Scan/Fax Mode Settings].

■PCL Settings List

Prints the settings for the PCL virtual printer.

■PCL Macro List

Prints the list of forms registered for PCL.

■PDF Settings List

Prints the settings configured in the PDF printer mode.

■TIFF / JPEG Settings List

Prints the settings configured in the TIFF and JPEG printer mode.

■TIFF / JPEG Logical Printers List

Prints the list of logical printers created in the TIFF and JPEG printer mode.

TIFF and JPEG logical printers are configured on CentreWare Internet Services. For more information, refer to the online help of CentreWare Internet Services.

■PS Logical Printers List

Prints the list of logical printers created in PostScript.

PostScript logical printers are configured on CentreWare Internet Services. For more information, refer to the online help of CentreWare Internet Services.

■ESC/P Settings List

Prints the settings configured in the ESC/P-K emulation mode.

■ESC/P Stored Programming List

Prints the stored programming settings configured in the ESC/P-K emulation mode.

■ESC/P User Defined List

Prints the information on forms, logos, and patterns that can be used in the ESC/P-K emulation mode.

■HP-GL/2 Settings List

Prints the settings for the HP-GL, HP-GL/2 and HP-RTL emulation modes.

■HP-GL/2 Stored Programming List

Prints the stored programming settings for the HP-GL, HP-GL/2, and HP-RTL emulation modes.

■HP-GL/2 Palette List

This prints the sample list in 256 colors that can be set with the pen attribute on HP-GL emulation and HP-GL/2 emulation.

■Fonts List

Prints the list of fonts available on the machine.

Note • Printed information depends on the installed options.

■PCL Fonts List

Prints the fonts available in PCL.

■PostScript Fonts List

Prints the fonts available in PostScript.

Scan/Fax Mode Settings

1 Select [Scan/Fax Mode Settings].

Note • To display the [Scan/Fax Mode Settings] screen, select the <Machine Status> button, and then select [Billing Meter/Print Report] > [Print Report/List] > [Scan/Fax Mode Settings].

2 Select the list to be printed.

3 Press the <Start> button.

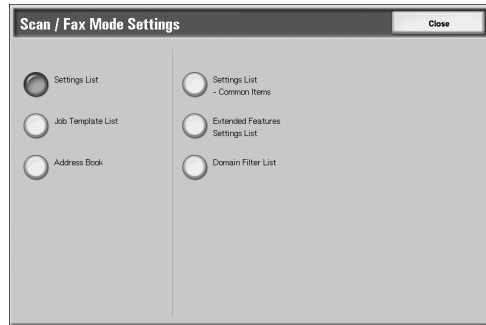

■Settings List

You can print the [Settings List - Common Items], [Extended Features Settings List], and [Domain Filter List]. Select the list to be printed, then press the <Start> button.

- Settings List - Common Items

You can check the hardware configuration, network information, and print and copy settings of the machine.

Note • The content of [Settings List] is identical whether it is printed from [Copy Mode Settings], [Print Mode Settings], or [Scan/Fax Mode Settings].

- Extended Features Settings List

You can check the settings configured for the scan features.

- Domain Filter List

You can check the permitted domains registered for domain filtering.

■Job Template List

You can print the settings for the server where the job templates, which are created using scan service setting tools, are stored.

■Address Book

You can check the settings for the address numbers.

When you specify a range of address numbers, the list of settings for the specified address numbers will be printed. Each page contains the settings information on 50 address numbers.

If you select [Address Book], the screen for specifying a range of address numbers is displayed. Select a range of numbers, and press the <Start> button.

1 Select [Address Book].

2 Specify a range of address numbers to be printed.

3 Press the <Start> button.

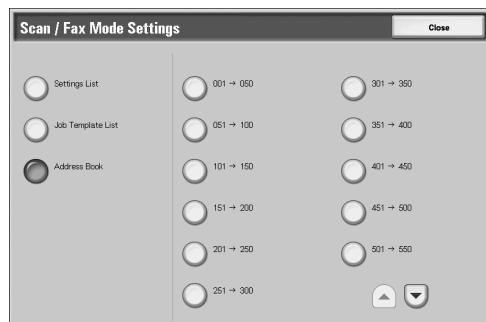

Mailbox List

Prints the list of mailbox settings and the procedure for saving documents to mailboxes.

Note • [Mailbox List] appears when [User Mode] is selected in the System Administration mode.

1 Select [Mailbox List].

Note • To display the [Mailbox List] screen, select the <Machine Status> button, and then select [Billing Meter/Print Report] > [Print Report/List] > [Mailbox List].

2 Select a range of mailbox numbers to be printed.

3 Press the <Start> button.

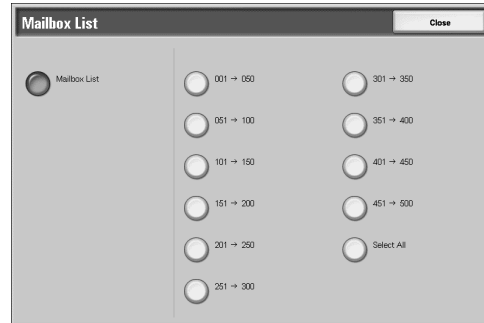

Job Counter Report

Prints the counter report for each feature.

Note • [Job Counter Report] appears when [User Mode] is selected in the System Administration mode.

1 Select [Job Counter Report].

Note • To display the [Job Counter Report] screen, select the <Machine Status> button, and then select [Billing Meter/Print Report] > [Print Report/List] > [Job Counter Report].

2 Select [Job Counter Report].

3 Press the <Start> button.



Auditron Administration

You can print an auditron report by user. Note that the content on the screen differs depending on whether the Auditron Administration feature is enabled.

Note • [Auditron Administration] appears when [User Mode] is selected in the System Administration mode.

When the Auditron Administration feature of each service is set to [Off]

When the Auditron Administration feature of each service is set to [Off], the following screen appears, allowing you to print a printer meter report.

For information on enabling the Auditron Administration feature for each service, refer to "Auditron Mode" (P.210).

1 Select [Auditron Administration].

Note • To display the [Auditron Administration] screen, select the <Machine Status> button, and then select [Billing Meter/Print Report] > [Print Report/List] > [Auditron Administration].

- 2 Select [Meter Report (Print Jobs)].
- 3 Press the <Start> button.



■ Meter Report (Print Jobs)

You can check the total printed pages and the total sheets used for each client (job owner). The number of print pages is counted for each of color and monochrome. [Meter Report (Print Jobs)] counts pages from the time at which the data has been initialized.

When the Auditron Administration feature is set to [On]

When the Auditron Administration feature is set to [On], the following screen appears. The auditron report for each user organized by each service can be printed for the services of which the Auditron Administration feature is set to [On].

For information on enabling the Auditron Administration feature for each service, refer to "Auditron Mode" (P.210).

- 1 Select [Auditron Administration].

Note • To display the [Auditron Administration] screen, select the <Machine Status> button, and then select [Billing Meter/Print Report] > [Print Report/List] > [Auditron Administration].

- 2 Select the auditron report to be printed.
- 3 Select a range of user numbers to be printed.

Note • Selecting [Select All] selects all users.

- 4 Press the <Start> button.

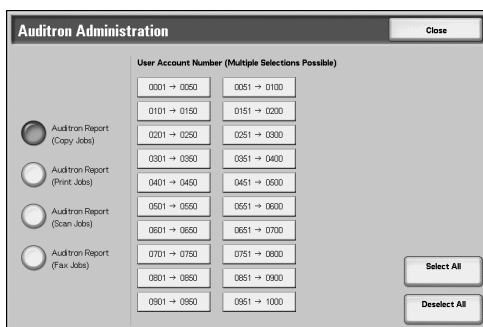

■ Auditron Report (Copy Jobs)

You can check the total number of pages copied on the machine, and the numbers of color and monochrome print pages. If the maximum limit is set for the number of pages or colors that can be scanned, you can also view the limit value. [Auditron Report (Copy Jobs)] counts pages from the time at which the data has been initialized.

Note • [No.] displayed on the report is the No. (User Administration Number) registered for the Login Setup/Auditron Administration feature.

■ Auditron Report (Print Jobs)

You can check the total printed pages and the total sheets used for each client (job owner). The number of print pages is counted for each of color and monochrome. [Auditron Report (Print Jobs)] counts pages from the time at which the data has been initialized.

Note • [No.] displayed on the report is the No. (User Administration Number) registered for the Login Setup/Auditron Administration feature.

■ Auditron Report (Scan Jobs)

You can check the total number of pages, and the numbers of color and monochrome pages scanned on the machine. If the maximum limit is set for the number of pages or colors that can be scanned, you can also view the limit value. [Auditron Report (Scan Jobs)] counts pages from the time at which the data has been initialized.

Note • [No.] displayed on the report is the No. (User Administration Number) registered for the Login Setup/Auditron Administration feature.

■ Auditron Report (Fax Jobs)

You can check the number of fax transmissions and receptions and the number of pages transmitted for each user.

Note • [No.] displayed on the report is the No. (User Administration Number) registered for the Login Setup/Auditron Administration feature.

Automatically Printed Reports/Lists

Some reports/lists relating to the scan service can only be printed automatically. This section describes reports/lists that can be printed automatically.

Transmission Report - Undelivered

Printed when a transmission of transferring the scanned data to the computer on the network, or sending the scanned data by e-mail has failed. You can check a reduced image of the scanned data and its transmission result.

Set whether to print out the Transmission Report - Undelivered automatically from the system administrator mode.

For information on specifying whether or not to have the report printed automatically, refer to "Scan File Transfer Report" (P.131).

Transmission Report

Printed when a transmission of transferring the scanned data to the computer on the network, or sending the scanned data by e-mail has succeeded. You can check a reduced image of the scanned data and its transmission result.

Set whether to print out the Transmission Report - Undelivered automatically from the system administrator mode.

For information on how to automatically print out the transmission report, refer to "Scan File Transfer Report" (P.131).

Job Flow Error Report

You can check the errors caused in the job flow. The date and time when the error occurred and the error codes are recorded.

For information on specifying whether or not to have the report printed automatically, refer to "Job Flow Error Report" (P.132).

Fax Server Report

This report is output after image data scanned by the machine is sent to a Server Fax server via a network. It contains the scanned document image and the transmission result. To have the report printed, enter the System Administration mode.

For information on specifying whether or not to have the report printed automatically, refer to "Fax Server Report" (P.132)

Supplies

You can check the status of consumables on the [Supplies] screen. The status of consumables is shown as "OK", "Replace Soon (Order Now)", or "Replace Now".

The following describes the procedure for checking the status of consumables.

For information on replacing consumables, refer to "Maintenance" (P.41).

- 1 Press the <Machine Status> button.
- 2 Select the [Supplies] tab.

Note • Select [▲] to return to the previous screen or [▼] to move to the next screen.

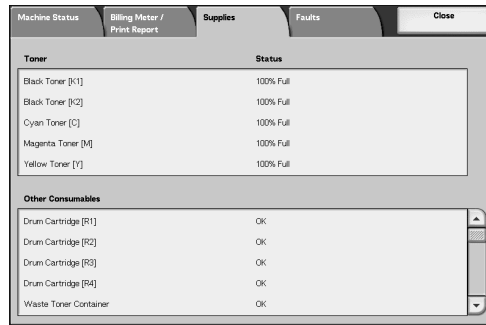

On the [Supplies] screen, you can check the following items.

Note • The items displayed vary depending on the options installed.
 • [Staple Cartridge] and [Hole Punch Container] appears when finisher is installed on the machine.
 • [Booklet Staple Cartridge] appears when the booklet finisher is installed.
 • [Staple Scrap Container] appears when the Booklet Finisher D2 is installed.

- Yellow Toner [K]
- Magenta Toner [M]
- Cyan Toner [C]
- Black Toner [K1]
- Black Toner [K2]
- Drum Cartridge [R4]
- Drum Cartridge [R3]
- Drum Cartridge [R2]
- Drum Cartridge [R1]
- Waste Toner Container [R1]
- Staple Cartridge [R1]
- Booklet Staple Cartridge [R2]
- Booklet Staple Cartridge [R3]
- Hole Punch Container [R4]

Important • If using a partly consumed toner cartridge (such as a toner cartridge removed from another ApeosPort-II C7500/C6500/C5400 unit or DocuCentre-II C7500/C6500/C5400 unit), the status shown may not match the actual remaining amount. When replacing toner cartridges, we recommend you use new ones.

Faults

This section describes how to check the information of errors that occurred on the machine.

The error history report shows the latest 50 errors. The items displayed include the date and time, error code, and error category.

The following describes how to print the error history report.

- 1 Press the <Machine Status> button.
- 2 Select the [Faults] tab.
- 3 Select [Error History Report].
- 4 Press the <Start> button.

Note

- You can also access the [Error History Report] from the [Job Status/Activity Report] on the [Billing Meter/Print Report] screen.
- If [Print Report Button] under [Reports] is set to [Disabled], the [Error History Report] button does not appear on the screen. For information on [Reports], refer to "Reports" (P.131).

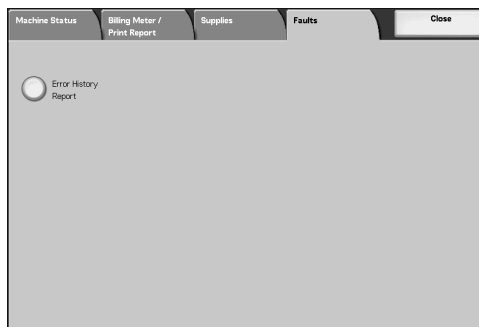

6 System Settings

Each feature of the machine is set to the factory default (initial) settings, but you can customize these settings. To change the settings, enter the System Administration mode, and use the [System Settings] screen.

This chapter explains the features that can be changed, and the procedures to change the settings.

• System Settings Procedure	108
• System Settings Menu List	112
• Common Settings	121
• Copy Mode Settings	145
• Network Settings.....	155
• Print Mode Settings	169
• Scan/Fax Mode Settings.....	174
• E-mail Settings.....	179
• Mailbox Settings	182
• Stored Document Settings.....	183
• Job Flow Settings for ApeosPort Series Models Only	185
• Web Applications Settings for ApeosPort Series Models Only.....	186
• Setup Menu	188
• System Administrator Settings.....	200
• Login Setup/Auditron Administration	202

System Settings Procedure

To make or change the system settings, it is necessary to enter the System Administration mode.

This section describes the basic procedures for system settings. The following shows the reference section for each procedure.

- Step 1 Entering System Administration Mode108
- Step 2 Entering the System Administrator User ID and Passcode108
- Step 3 Selecting the Operation Mode from the System Administrator Menu109
- Step 4 Selecting an Item on the [System Settings] Screen109
- Step 5 Setting a Feature111
- Step 6 Exiting the System Administration Mode.....111

Step 1 Entering System Administration Mode

1 Press the <Log In/Out> button.

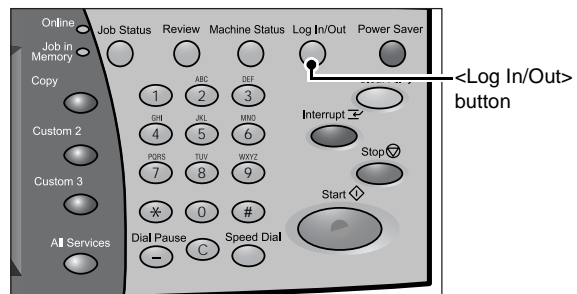

System Settings

Step 2 Entering the System Administrator User ID and Passcode

To enter System Administration mode, enter the system administrator User ID. If [Passcode Entry from Control Panel] in [Login Setup / Auditron Administration] is activated, the passcode needs to be entered.

It is recommended to change the system administrator user ID and passcode immediately after installing the machine. For more information, refer to "System Administrator Settings" (P.200).

1 Enter the System Administrator Login ID with the numeric keypad or a keyboard displayed by pressing [Keyboard], and select [Confirm].

Note

- The default System Administrator Login ID is "11111". When using the Authentication feature, a passcode is required. The default passcode is "x-admin".



- The machine displays the following message if the system administration login failed:
"Login failed. Re-enter User Details and select Confirm."
- The machine displays the following message if the authentication failed more than the specified number of times:
"You have made the maximum number of attempts to access the system. Access denied."

Step 3 Selecting the Operation Mode from the System Administrator Menu

- 1 Select [System Settings].



■ User Mode

While still in the System Administration mode, you can carry out normal operations such as copying and scanning.

- Note**
- To exit a mode entered from [User Mode], use the following procedure.
 - (1) Press the <Log In/Out> button.
 - (2) In the [Login] screen, select [Cancel].

■ System Settings

You can set or register the system settings.

Step 4 Selecting an Item on the [System Settings] Screen

In the [System Settings] screen, select an item to be set.

For the items that can be selected in the system settings, refer to "System Settings Menu List" (P.112).

- Note**
- Names of menus and screens may be worded differently on DocuCentre series models and ApeosPort series models. If different menu names and screen names are used for DocuCentre series models and ApeosPort series models though they both serve the same functionality, both names are listed next to each other delimited by "/" (slash)" in this chapter. For details on menu names, refer to "System Settings Menu List" (P.112).

- 1 Select the item to be set.

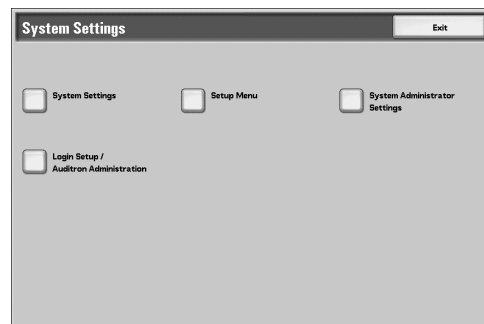

System Settings

You can set or change the default values.

■ Common Settings

Allows you to configure the settings relating to the machine itself.

For more information, refer to "Common Settings" (P.121).

■ Copy Mode Settings

Allows you to configure the copy feature defaults, copy operation control, button indications, and so on.

For more information, refer to "Copy Mode Settings" (P.145).

■ Network Settings

Allows you to configure the ports, protocols, and so on.

For more information, refer to "Network Settings" (P.155).

■ Print Mode Settings

Allows you to configure the memory settings, print operation control, and so on.

For more information, refer to "Print Mode Settings" (P.169).

■ Scan/Fax Mode Settings

Allows you to configure the scanner and server fax feature defaults, button indications, and so on.

For more information, refer to "Scan/Fax Mode Settings" (P.174).

■ E-mail Settings

Allows you to configure the e-mail defaults, address search settings, and so on.

For more information, refer to "E-mail Settings" (P.179).

■ Mailbox Settings

Allows you to set how to delete documents stored in mailboxes.

For more information, refer to "Mailbox Settings" (P.182).

■ Stored Document Settings

Allows you to set how to delete print documents stored in the machine.

For more information, refer to "Stored Document Settings" (P.183).

■ Job Flow Settings

Allows you to configure the settings relating to job flows.

For more information, refer to "Job Flow Settings for ApeosPort Series Models Only" (P.185).

■ Web Applications

Allows you to configure an access destination server.

For more information, refer to "Web Applications Settings for ApeosPort Series Models Only" (P.186).

Setup Menu

You can create mailboxes and job flow sheets, and can create and change an address book (address numbers).

For more information, refer to "Setup Menu" (P.188).

System Administrator Settings

You can set the system administrator ID and system administrator passcode for entering System Administration mode.

For more information, refer to "System Administrator Settings" (P.200).

Login Setup/Auditron Administration

You can set restrictions on users using features of the machine, or administer jobs by user.

For more information, refer to "Login Setup/Auditron Administration" (P.202).

Step 5 Setting a Feature

- 1 Set any feature.
- 2 After setting the feature, select [Save].

Step 6 Exiting the System Administration Mode

- 1 When the settings are completed, select [Close] until the [System Settings] screen appears.
- 2 Select [Exit].

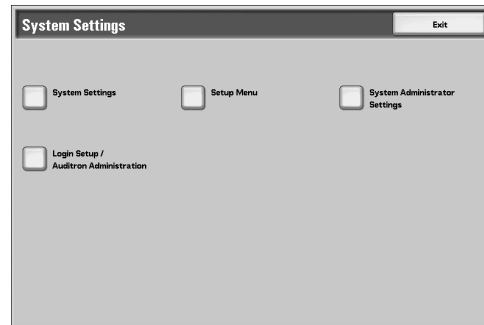

System Settings Menu List

The following table shows a list of the items that can be set. Note that the items appearing depend on the configuration of the machine.

System Settings

■ Common Settings

Machine Clock/Timers (P.121)	<ul style="list-style-type: none"> • Date (P.121) • Time (P.121) • NTP Time Synchronization (P.122) • Connection Interval (P.122) • Auto Clear (P.122) • Auto Job Release (P.122) • Auto Print (P.122) • Printer Lockout Duration (P.122) • Auto Power Saver/Energy Saver (P.123) • Time Zone (P.123) • Daylight Savings (P.123) • On-Demand Print Duration (ApeosPort series models only) (P.124)
Audio Tones (P.124)	<ul style="list-style-type: none"> • Control Panel Select Tone (P.124) • Control Panel Alert Tone (P.124) • Base Tone (P.124) • Machine Ready Tone (P.124) • Copy Job Complete Tone (P.124) • Non-Copy Job Complete Tone (P.124) • Fault Tone (P.124) • Auto Clear Alert Tone (P.125) • Alert Tone (P.125) • Out of Paper Warning Tone (P.125) • Low Toner Alert Tone (P.125) • Stored Programming Tone (P.125)
Screen/Button Settings (P.125)	<ul style="list-style-type: none"> • Screen Default (P.125) • Screen After Auto Clear (P.125) • Auto Display of Login Screen (P.125) • Custom Buttons 1 to 3 (P.125) • All Services / All Services - Additional Features (P.126) • Job Type on Job Status Screen (P.126) • Default Language (P.126) • Screen Contrast (P.126)
Paper Tray Settings (P.126)	<ul style="list-style-type: none"> • Custom Paper Name (P.126) • Paper Tray Attributes (P.127) • Customize Paper Supply Screen (P.127) • Paper Tray Attributes on Setup Menu (P.127) • Paper Tray Attributes During Loading (P.127) • Paper Tray Priority (P.128) • Paper Type Priority (P.128) • Tray 5 (Bypass) - Paper Size Defaults (P.128) • Auto Tray Switching (P.128) • Image Quality (P.129)
Image Quality Adjustment (P.129)	<ul style="list-style-type: none"> • Image Quality (P.129) • Calibration (P.130)

Reports (P.131)	<ul style="list-style-type: none"> • Print Report Button (P.131) • Job History Report (P.131) • Scan File Transfer Report (P.131) • Fax Server Report (P.132) • 2 Sided Report (P.132) • Job Flow Error Report (P.132)
Maintenance (P.132)	<ul style="list-style-type: none"> • Initialize Hard Disk (P.132) • Delete All Data (P.132) • Software Options (P.132) • Adjust Image Position (P.132)
Watermark (P.133)	<ul style="list-style-type: none"> • Date Format (P.133) • Text Effect Default (P.133) • Text Default (P.133) • Text Size (P.133) • Background Pattern (P.133) • Color (P.133) • Density (P.133) • Text/Background Contrast (P.133) • Force Watermark - Copy Job (P.134) • Force Watermark - Client Print (P.134) • Force Watermark - Mailbox Print (P.134) • Custom Text 1 to 3 (P.134) • Sample List (P.134)
Secure Watermark (P.134)	<ul style="list-style-type: none"> • Secure Watermark Control (P.134) • Digital Codes Settings (P.134) • Force Secure Watermark (P.135) • Secure Watermark Defaults (P.135) • Text Effect (P.135)
Image Log Control (ApeosPort series models only) (P.136)	<ul style="list-style-type: none"> • Image Log Control (P.136) • Image Log Target (P.136) • Image Log Generation (P.136) • Image Log Transfer (P.136)
Print Universal Unique ID (ApeosPort series models only) (P.137)	<ul style="list-style-type: none"> • Print Universal Unique ID (P.137) • Print Position (P.137) • Print Position Adjustment (P.137) • Print Position (Side2) (P.137)
Other Settings (P.137)	<ul style="list-style-type: none"> • Fax Service (P.137) • Auto Job Promotion (P.138) • Offset Stacking (Center Output Tray) (P.138) • Offset Stacking (Finisher Tray) (P.138) • Default Print Paper Size (P.138) • Paper Size Settings (P.138) • Millimeters/Inches (P.141) • Keyboard Input Restriction (P.141) • Operation of Up/Down Buttons (P.141) • Display Consumables Screen (P.141) • Overwrite Hard Disk (P.141) • Data Encryption (P.142) • Encryption Key for Confidential Data (P.143) • Service Rep. Restricted Operation (P.144) • Software Download (P.144) • Document Feeder Tray Elevation (P.144) • Gloss Level (P.144) • Estimated Time for Single or All Jobs (P.144) • Recipient Selection Method (P.144)

■ Copy Mode Settings

General Settings Tab - Features Allocation (P.145)

Preset Buttons (P.146)

- Paper Supply - Button 2 - 5 (P.146)
 - Reduce/Enlarge - Button 3 - 5 (P.146)
-

Copy Defaults (P.146)

- Paper Supply (P.146)
 - Reduce/Enlarge (P.146)
 - Output Color (P.147)
 - Single Color (P.147)
 - Dual Color - Source Color (P.147)
 - Dual - Target Area Color (P.147)
 - Dual - Non-target Area Color (P.147)
 - Original Type (P.147)
 - Original Type - Auto (Non-Black) (P.147)
 - Original Type - Auto (Black) (P.147)
 - Lighten/Darken (P.147)
 - Contrast (P.147)
 - Sharpness (P.147)
 - Saturation (P.147)
 - Background Suppression (P.148)
 - Color Balance - Yellow (P.148)
 - Color Balance - Magenta (P.148)
 - Color Balance - Cyan (P.148)
 - Color Balance - Black (P.148)
 - Color Shift (P.148)
 - 2 Sided Copying (P.148)
 - Mixed Sized Originals (P.148)
 - Edge Erase - Top Edge or Edge Erase - Bottom Edge (P.148)
 - Edge Erase - Left Edge or Edge Erase - Right Edge (P.148)
 - Center Erase/Binding Erase (P.148)
 - Edge Erase - Side 2 (P.148)
 - Image Shift - Side 1 (P.149)
 - Image Shift - Side 2 (P.149)
 - Image Rotation (P.149)
 - Image Rotation Direction (P.149)
 - Original Orientation (P.149)
 - Copy Output (P.149)
 - Copy Output - Separators Tray (P.149)
 - Output Destination (P.149)
 - Sample Set (P.149)
 - Stamp Text (P.149)
 - Stamp Position (Side 1) (Side 2) (P.149)
 - Stamp Size (P.149)
 - Stamp Color (P.150)
 - Date Position (Side 1) (Side 2) (P.150)
 - Date Size (P.150)
 - Page Number Style (P.150)
 - Page Number Position (Side 1) (Side 2) (P.150)
 - Page Number Size (P.150)
 - Bates Stamping - Number of Digits (P.150)
 - Bates Stamping - Position (Side 1) (Side 2) (P.150)
 - Bates Stamping - Size (P.150)
 - Tab Margin Shift - Shift Value (P.150)
 - Booklet Creation - Covers Tray (P.150)
-

Copy Defaults (P.146)	<ul style="list-style-type: none"> • Covers - Front Cover Tray / Covers - Back Cover Tray (P.151) • Insert Separators - Separators Tray (P.151)
Copy Control (P.151)	<ul style="list-style-type: none"> • Memory Full Procedure (P.151) • Maximum Stored Pages (P.151) • Auto Paper Off (P.151) • Mixed Sized Originals - 2 Sided Copy (P.151) • Fine-tune 100% (P.152) • Background Suppress (Photo & Text) (P.152) • Background Suppression Level (Text) (P.152) • Photo & Text/Printed Original (P.152) • Original Type - Lightweight Originals (P.152) • Output Orientation - Reverse Order (P.152) • Output Orientation - Auto (Single Sheet) (P.152) • Stamp Density (P.152) • Stamp Position - Top Left, - Top Center, - Top Right, - Left Center, - Center, - Right Center, - Bottom Left, - Bottom Center, and - Bottom Right (P.152) • Date Position - Top Left, - Top Center, - Top Right, - Left Center, - Center, - Right Center, - Bottom Left, - Bottom Center, and - Bottom Right (P.153) • Page Number Position - Top Left, - Top Center, - Top Right, - Left Center, - Center, - Right Center, - Bottom Left, - Bottom Center, and - Bottom Right (P.153) • Bates Stamping - Top Left, - Top Center, - Top Right, - Left Center, - Center, - Right Center, - Bottom Left, - Bottom Center, and - Bottom Right (P.153) • Quantity Display (P.153) • Maximum Number of Sets (P.153)
Original Size Defaults (P.153)	-
Reduce/Enlarge Presets (P.153)	-
Custom Colors (P.153)	-
Annotation - Create Stamps (P.154)	-

■ Network Settings

Port Settings (P.155)	<ul style="list-style-type: none"> • USB (P.155) • LPD (P.156) • NetWare (P.156) • SMB (P.156) • IPP (P.156) • EtherTalk (P.156) • Bonjour (P.156) • Salutation (P.157) • Port9100 (P.157) • SNMP (P.157) • FTP Client (P.157) • Receive E-mail (P.157) • Send E-mail (P.157) • Mail Notice Service (P.157) • UPnP Discovery (P.157) • Internet Service (HTTP) (P.157) • SOAP (P.158) • WebDAV (P.158)
Protocol Settings (P.158)	<ul style="list-style-type: none"> • Ethernet Settings (P.158) • TCP/IP - Get IP Address (P.159) • TCP/IP - IP Address (P.159) • TCP/IP - Subnet Mask (P.159) • TCP/IP - Gateway Address (P.159) • TCP/IP - IP Filter (P.160)
Machine's E-mail Address/Host Name (P.160)	<ul style="list-style-type: none"> • E-mail Address (P.160) • Name (P.160) • Host Name (P.160) • Domain Name (P.160)
Proxy Server Settings (ApeosPort series models) (P.160)	<ul style="list-style-type: none"> • Use Proxy Server (P.161) • Proxy Server Setup (P.161) • Addresses to Bypass Proxy Server (P.161) • HTTP Proxy Server Name (P.161) • HTTP Proxy Server Port Number (P.161) • HTTP Proxy Server Authentication (P.161) • HTTP Proxy Server Login Name (P.161) • HTTP Proxy Server Password (P.161) • HTTPS Proxy Server Name (P.161) • HTTPS Proxy Server Port Number (P.161) • HTTPS Proxy Server Authentication (P.161) • HTTPS Proxy Server Login Name (P.161) • HTTPS Proxy Server Password (P.161)
Outgoing / Incoming E-mail Settings (P.161)	<ul style="list-style-type: none"> • POP3 Server Settings (P.162) • SMTP Server Settings (P.162) • Domain Filter (P.163)
Remote Authentication Server/Directory Service (ApeosPort series models only) (P.163)	<ul style="list-style-type: none"> • Authentication System (P.163) • Kerberos Server Settings (P.163) • LDAP Server/Directory Service (P.164) • SMB Server Settings (P.167)
PKI Settings (Public Key Infrastructure) (P.167)	<ul style="list-style-type: none"> • SSL/TLS Settings (P.167) • S/MIME Settings (ApeosPort series models) (P.168) • PDF/DocuWorks Signature Settings (ApeosPort series models) (P.168)
Other Settings (P.168)	<ul style="list-style-type: none"> • E-mail Receive Protocol (P.168) • Output Destination for E-mail (P.168)

■ Print Mode Settings

Allocate Memory (P.169)	<ul style="list-style-type: none"> • PostScript Memory (P.169) • ESC/P Form Memory (P.169) • Receiving Buffer - USB (P.169) • Receiving Buffer - LPD Spool (P.170) • Receiving Buffer - NetWare (P.170) • Receiving Buffer - SMB Spool (P.170) • Receiving Buffer - IPP Spool (P.170) • Receiving Buffer - EtherTalk (P.170) • Receiving Buffer - Port 9100 (P.171)
Delete Form (P.171)	<ul style="list-style-type: none"> • ESC/P (P.171) • Form Number (P.171) • Form Name (P.171)
Other Settings (P.171)	<ul style="list-style-type: none"> • Print Area (P.171) • Substitute Tray (P.171) • Paper Type Mismatch (P.172) • Unregistered Forms (P.172) • Print User ID (P.172) • Banner Sheet (P.172) • Banner Sheet Tray (P.173) • PostScript Default Color (P.173) • PostScript Paper Supply (P.173) • PostScript Font Absence (P.173) • PostScript Font Substitution (P.173)

■ Scan/Fax Mode Settings

General Settings Tab (P.174)	<ul style="list-style-type: none"> • Feature in 2nd Column (P.174) • Reduce/Enlarge - Buttons 2 to 3 (P.174)
Scan Defaults (P.174)	<ul style="list-style-type: none"> • Scanning Color (P.174) • Original Type (P.174) • File Format (P.175) • Thumbnail - Outgoing E-mail (P.175) • Thumbnail - Scan to PC (P.175) • Lighten/Darken (P.175) • Contrast (P.175) • Sharpness (P.175) • Background Suppression (P.175) • Shadow Suppression (P.175) • Color Space (P.175) • Original Orientation (P.175) • Scan Resolution (P.175) • Mixed Sized Originals (P.175) • Edge Erase (P.175) • Edge Erase - Top & Bottom Edges (P.176) • Edge Erase - Left & Right Edges (P.176) • Center Erase/Binding Erase (P.176) • Image Compression (P.176) • E-mail Subject (P.176)
Scan to PC Defaults (P.176)	-
Original Size Defaults (P.176)	-
Output Size Defaults (P.176)	-
Reduce/Enlarge Presets (P.177)	-

Other Settings (P.177)

- Scan Service (P.177)
 - Memory Full Procedure (P.177)
 - Maximum Stored Pages (P.177)
 - Saturation (P.177)
 - Background Suppression Level (P.177)
 - Shadow Suppression Level (P.178)
 - Color Space (P.178)
 - TIFF Format (P.178)
 - Image Transfer Screen (P.178)
-

■E-mail Settings

E-mail Control (P.179)

- Maximum E-mail Size (P.179)
 - Maximum Address Entries (P.179)
 - Incoming E-mail Print Options (P.179)
 - Auto Print Error Mail (P.179)
 - Response to Read Receipts (P.180)
 - Read Receipts (P.180)
 - Auto Print Delivery Confirmation Mail (P.180)
 - Max Number of Pages for Split Send (P.180)
 - Allow Casual Users to Edit From Field (P.180)
 - Allow Guest Users to Edit Field (P.180)
 - Allow to edit From if Search found (P.180)
 - Allow to edit From if Search failed (P.181)
 - E-mail Sending When Search Failed (P.181)
 - Add Me to To Field (P.181)
 - Add Me to CC Field (P.181)
 - Edit E-mail Recipients (P.181)
-

■Mailbox Settings

-

- Documents Retrieved By Client (P.182)
 - Print & Delete Confirmation Screen (P.182)
-

■Stored Document Settings

-

- Document Expiration Date (P.183)
 - Delete Charge Print Documents (P.183)
 - Delete Secure Print Documents (P.183)
 - Delete Private Charge Print Docs. (P.183)
 - Delete Sample Print Documents (P.183)
 - Print Job Confirmation Screen (P.184)
 - Minimum Passcode Length for Stored Job (P.184)
-

■Web Applications Settings

Server Setup (P.186)

- URL (P.186)
 - Server Name (P.186)
 - Description (P.186)
 - Use User ID (P.186)
 - User ID (P.187)
 - Password (P.187)
 - Machine/Authentication Notification (P.187)
-

Configuring/Canceling the Auto Link Server (P.187)

- Auto Link Server No (P.187)
-

Setup Menu

Mailbox (P.188)	<ul style="list-style-type: none"> • Check Passcode (P.188) • Mailbox Name (P.189) • Delete Documents After Retrieval (P.189) • Delete Expired Documents (P.189) • Link Job Flow Sheet to Mailbox (P.189)
Job Flow Sheets (P.190)	<ul style="list-style-type: none"> • Create (P.191) • Search by Name (P.191) • Search by Keyword (P.191) • Select Keyword (P.191) • Sheet Filtering (P.192) • Name (P.192) • Description (P.192) • Keyword (P.192) • Send as E-mail (ApeosPort series models) (P.192) • Transfer via FTP (1), Transfer via FTP (2) (ApeosPort series models) (P.193) • Transfer via SMB (1), Transfer via SMB (2) (ApeosPort series models) (P.194) • Print (P.195)
Job Flow Sheet Keywords (P.195)	-
Address Book (P.196)	<ul style="list-style-type: none"> • Address Type (P.197) • E-mail Address (P.197) • Fax Number (P.197) • Recipient Name (P.197) • Last Name (P.197) • First Name (P.197) • Custom Item 1 (P.198) • Custom Item 2 (P.198) • Custom Item 3 (P.198) • S/MIME Certificate (ApeosPort series models) (P.198) • Transfer Protocol (P.198) • Server Name/IP address (P.198) • Shared Name (SMB Only) (P.198) • Save In (P.198) • User Name (P.199) • Password (P.199) • Index (P.199) • Port Number (P.199)
Paper Tray Attributes (P.199)	-

System Administrator Settings

System Administrator Login ID (P.200)	-
System Administrator's Passcode (P.200)	-
Maximum Login Attempts (P.201)	-

Login Setup/Auditron Administration

Create/Check User Accounts (P.202)	<ul style="list-style-type: none"> • User ID (P.203) • User Name (P.203) • Passcode (P.203) • E-mail Address (P.203) • Account Limit (P.203) • Reset Account (P.204) • Reset Total Impressions (P.204)
Account Details (P.204)	-
Reset User Accounts (P.205)	<ul style="list-style-type: none"> • All User Accounts (P.205) • All Feature Access Settings (P.205) • All Account Limits (P.205) • Total Impressions (P.205) • Meter (Print Jobs) (P.205) • Print Report (DocuCentre series models) / (P.205)
System Administrator's Meter (Copy Jobs) (P.205)	-
User Details Setup (P.205)	<ul style="list-style-type: none"> • User ID Characters (P.206) • Hide User ID (***) (P.206) • Account ID Characters (P.206) • Hide Account ID (***) (P.206) • Failed Access Log (P.206) • Store User Details (P.206) • Remote Login User ID (ApeosPort series models) (P.206)
Charge / Private Print Settings (P.206)	<ul style="list-style-type: none"> • PjL Receive Command Control (P.207) • PjL Output Command Control (P.207) • Receive Control (P.207)
Passcode Entry from Control Panel (P.208)	-
Login Setup/Auditron Mode (P.209)	<ul style="list-style-type: none"> • Off (P.209) • Local Machine Access (P.209) • Network Access (P.209) <ul style="list-style-type: none"> - Verify User Details (P.209) - Customize User Prompt (P.209) • Remote Access (ApeosPort series models) (P.210) <ul style="list-style-type: none"> - Guest User (P.210) - Guest Password (P.210) • Xerox Standard Accounting (P.210) • Auditron Mode (P.210) • Mailbox Access (P.210)

Common Settings

In [Common Settings], you can make settings relating to the machine's common features. The following shows the reference section for each item.

Machine Clock/Timers	121
Audio Tones	124
Screen/Button Settings	125
Paper Tray Settings	126
Image Quality Adjustment	129
Reports	131
Maintenance	132
Watermark	133
Secure Watermark	134
Image Log Control (ApeosPort series models only)	136
Print Universal Unique ID (ApeosPort series models only)	137
Other Settings	137

- 1 On the [System Settings] screen, select [System Settings].
For the method of displaying the [System Settings] screen, refer to "System Settings Procedure" (P.108).
- 2 Select [Common Settings].
- 3 Select the item to be set or changed.

Machine Clock/Timers

You can set the clock time, or the time intervals until the power saver or reset features take effect.

Date

Set the date in the system clock of the machine. The date set here is printed on lists and reports.

- 1 Select [Date], and select [Change Settings].
- 2 Select the date format.
- 3 Select Year/Month/Day.

Time

Set the time in the system clock of the machine, using 12-hour or 24-hour format. The time set here is printed on lists and reports.

- 1 Select [Time], and select [Change Settings].
- 2 Select the display format.
- 3 When [12-Hour Clock] is selected, select [AM] or [PM].
- 4 Set the hours and minutes.

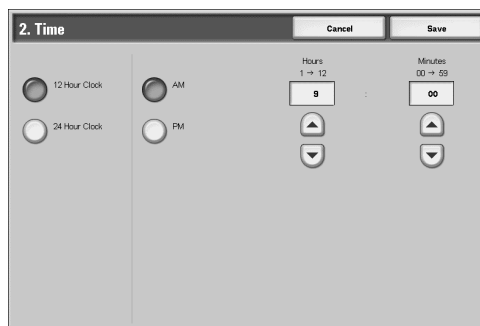

NTP Time Synchronization

You can obtain the time from a time server (NTP: Network Time Protocol), to synchronize the machine time to the server time.

If you connect to a time server, select [On] for [NTP Time Synchronization], and set the IP address of the time server in [Time Server IP Address].

■ Time Server IP Address

Set the IP address of the time server from which the time is obtained, using values 0 to 255.

- Note**
- The range between 224.XXX.XXX.XXX through 255.XXX.XXX.XXX, and 127.XXX.XXX.XXX cannot be set.

Connection Interval

Select the time interval at which a connection is made to the time server. Select an interval from 1 to 500 hours in 1 hour increments.

Auto Clear

If a given time period elapses with no operation, the machine automatically returns to the initial screen.

When [On] is selected, specify a value between 30 and 240 seconds, in 1 second increments. In order not to set this feature, select [Off].

- Note**
- Even if [Off] is selected, when there is no operation for 1 minute on the screen waiting for a job command after scanning, the machine cancels the waiting condition and starts to process the scanned documents.

Auto Job Release

If an error occurs (document or paper jams, running out of paper, etc.) during copying or scanning, the machine cancels the active job and starts the next job after a given period of time. In that case, jobs that can be activated are limited to those that only use parts of the machine not affected by the error.

When [On] is selected, specify a value between 4 and 99 minutes, in 1 minute increments. In order not to set this feature, select [Off].

Auto Print

Set the time period to start the next print job after finishing a copy operation.

When [On] is selected, specify a value between 1 and 240 seconds, in 1 second increments. If you select [Off], printing starts immediately after the machine is ready.

Printer Lockout Duration

The machine disables to print during a given period of time.

If you selected [On], specify a starting time and an ending time to disable printing, in one minute increments.

- Note**
- A job which has already been activated before the starting time will be printed continuously even after the starting time elapses.

- The print-disabled condition is cancelled when you operate using the control panel after the ending time.
- To enable printing during the printer lockout duration, select a job under [Current and Pending Jobs] on the [Job Status] screen, and then select [Promote Job].

Auto Power Saver/Energy Saver

The machine is provided with the Low Power and Sleep modes as the power saving mode. When a specified period of time has elapsed, the machine switches to these modes in the following order to reduce power consumption.

Last selection on the machine → Low Power mode → Sleep mode

For more information, refer to "2 Product Overview" > "Power Saver Mode" in the User Guide.

Note • There is no setting to disable switching to the Low Power mode or the Sleep mode.

■ From Last Selection to Low Power Mode

Specify a time period between the last operation and entering the Low Power mode in the range from 1 to 240 minutes, in 1 minute increments.

Note • Configure the [From Last Selection to Sleep Mode] time to be longer than the [From Last Selection to Low Power Mode] time.

■ From Last Selection to Sleep Mode

Specify a time period between the last selection and entering the Sleep mode from 1 to 240 minutes, in 1 minute increments.

Time Zone

Set the time difference from GMT.

- 1 Select [Time Zone], and select [Change Settings].
- 2 Set the time difference from GMT.

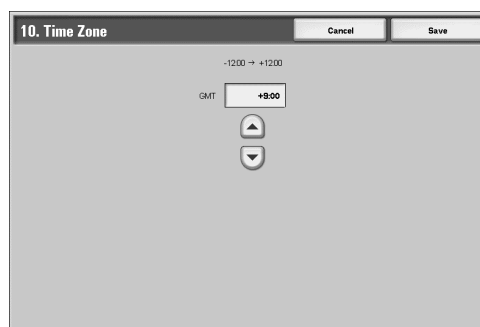

Daylight Savings

With this feature enabled, the machine automatically adjusts the current time when daylight savings time starts and ends. Specify the start and end dates of daylight savings time periods.

- 1 Select [Daylight Savings], and select [Change Settings].
- 2 Select [Adjust On].
- 3 Set the start date for daylight savings time in [Start Date].
Set the end date for daylight savings time in [End Date].

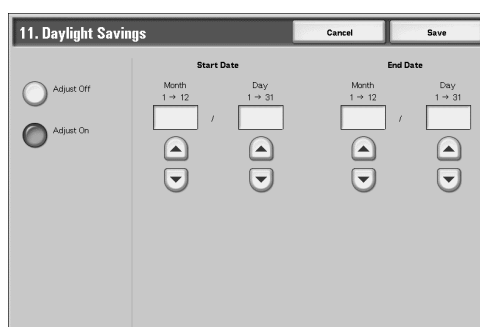

On-Demand Print Duration (ApeosPort series models only)

Specify the duration for the machine to receive a print job from web applications. Unless the machine receives full data of the print job within the specified period of time, the machine does not process the print job.

Specify the duration within the range of 0 to 255 minutes in 1-minute increments. If you specify [0], it means that no time limitation is set on the machine for receiving data.

- Note**
- When instructing a print job that contains a large amount of data, or when instructing a print job which contents take a while to be processed, transmission may be timed out before the machine receives the last page of the print job. If transmission is timed out, the received data of the print job is canceled. Consider the machine usage environment when you specify the duration time.

Audio Tones

Select whether or not to sound an alarm, for example when a job ends or a fault occurs.

Control Panel Select Tone

Select the sound to be made when a button displayed on the screen is correctly selected. You can select the volume from [Soft], [Normal], and [Loud]. To disable the sound, select [Off].

Control Panel Alert Tone

Select the sound to be made when a button that cannot be selected is selected, or an error occurs.

You can select the volume from [Soft], [Normal], and [Loud]. To disable the sound, select [Off].

Base Tone

For a button that toggles (changes setting each time it is pressed), set the sound to be made when in the home position. The machine makes this sound when it exits the Interrupt mode. You can select the volume from [Soft], [Normal], and [Loud]. To disable the sound, select [Off].

Machine Ready Tone

Set the sound for when the machine is ready to copy or print, after powering on, for example. You can select the volume from [Soft], [Normal], and [Loud]. To disable the sound, select [Off].

Copy Job Complete Tone

Select the sound to be made when a copy completes normally. You can select the volume from [Soft], [Normal], and [Loud]. To disable the sound, select [Off].

Non-Copy Job Complete Tone

Select the sound to be made when a job other than copying completes. You can select the volume from [Soft], [Normal], and [Loud]. To disable the sound, select [Off].

Fault Tone

Select the sound to be made when an error termination occurs. You can select the volume from [Soft], [Normal], and [Loud]. To disable the sound, select [Off].

Auto Clear Alert Tone

Select the sound to be made at 5 seconds before automatically returning to the initial screen, when the auto clear feature is enabled.

You can select the volume from [Soft], [Normal], and [Loud]. To disable the sound, select [Off].

Alert Tone

Select the sound to be made when a fault such as a paper jam occurs, and the fault is left unattended to.

You can select the volume from [Soft], [Normal], and [Loud]. To disable the sound, select [Off].

Out of Paper Warning Tone

Select the sound to be made when a job is suspended due to running out of paper in a tray.

You can select the volume from [Soft], [Normal], and [Loud]. To disable the sound, select [Off].

Low Toner Alert Tone

Select the sound to be made when the toner cartridge needs to be replaced.

You can select the volume from [Soft], [Normal], and [Loud]. To disable the sound, select [Off].

Stored Programming Tone

Select the sound to be made while a stored program is registered.

You can select the volume from [Soft], [Normal], and [Loud].

It is not possible to disable this sound.

Screen/Button Settings

Set screens and buttons.

Screen Default

Set the features displayed on the screen that appears after turning the machine on or canceling the Power Saver mode.

For more information, refer to "2 Product Overview" > "Control Panel" > "Customizing the Control Panel" in the User Guide.

Screen After Auto Clear

Set the screen displayed after Auto Clear.

For more information, refer to "2 Product Overview" > "Control Panel" > "Customizing the Control Panel" in the User Guide.

Auto Display of Login Screen

When the authentication feature is used, set whether or not to automatically display the login screen after turning the machine on or canceling the Power Saver mode.

Custom Buttons 1 to 3

You can assign features such as Copy and E-mail to the custom buttons on the control panel: Custom Button 1 to Custom Button 3.

To leave a feature unassigned, select [Not Set].

For more information, refer to "2 Product Overview" > "Control Panel" > "Customizing the Control Panel" in the User Guide.

- Note**
- The operation settings can be registered in the [Stored Programming] screen. For information on Stored Programming, refer to "6 Stored Programming" > "Registering/Deleting/Renaming Stored Programming" in the User Guide.
 - The default setting of [Custom Button 1] is [Copy].

All Services / All Services - Additional Features

Set the layout of buttons that appear on the [All Services] screen when pressing the <All Services> button on the control panel.

The layout of buttons in this screen is corresponding to the layout of those on the [All Services] screen.

For more information on how to set the layout of buttons that appear on the [All Services] screen, refer to "2 Product Overview" > "Control Panel" > "Customizing the Control Panel" in the User Guide.

- Note**
- It is not possible to assign the same feature to more than one button.

Job Type on Job Status Screen

Select the job types to be shown on the [Completed Jobs] screen of the [Job Status] screen that is displayed when the <Job Status> button on the control panel is pressed.

Select from [All Jobs], [All Non-Printing Jobs], [Mailbox Transfer Jobs], and [All Printing Jobs].

Default Language

You can select the language displayed on the machine.

There are two ways of selecting the language: set in the System Administration mode, and set by ordinary users.

- Setting in the System Administration mode
The language set here is the standard language that is retained even when the machine is powered off and on.
- Setting by ordinary users
The language setting in [Language] in the [All Services] screen is lost when the machine is powered off.

Screen Contrast

You can adjust the screen contrast within the range from -16 to +16.

Paper Tray Settings

Set the items relating to the paper and trays, including the types and precedence of paper loaded in the trays.

Custom Paper Name

Assign custom names to User 1 to User 5. The following paper types are available as the custom paper: plain paper, bond paper, and recycled paper. You can use letters, numerals, and symbols of up to 24 characters for each name.

For example, you can use a name showing its usage, such as "Color" for colored paper, and "Covers" for bond paper.

For information about how to enter characters, refer to "2 Product Overview" > "Entering Text" in the User Guide.

Paper Tray Attributes

You can set Paper Type and Size for paper loaded in trays and Auto Paper Select.

For more information, refer to "Changing the Paper Settings" (P.38).

■Change Settings

Press this button, if you change the paper size for the tray.

When you load non-standard size paper in the tray, select [Variable Size], and specify the width and height.

When you load standard size paper in the tray, select [Auto Size Detect].

Important • Adjust the paper guides to the paper size to prevent paper jams or errors. If the machine does not detect trays, use the Tray 5 (Bypass).

• Paper Type

You can select the paper type for trays.

For information about paper types available on the machine, refer to "Supported Paper Type" (P.24).

• Variable Size

When using Trays 1 to 2, you can load both standard size paper and non-standard size paper.

When you load non-standard size paper in the Trays, set the size in the X (width) direction within the range 182 to 432 mm and in the Y (height) direction within the range 140 to 297 mm in 1 mm increments.

When using Trays 3 to 4, and 6 (HCF (A4 1 Tray)), you can load standard size paper only.

• Auto Paper Select

The automatically selected paper tray can be designated according to the output color settings. In any mode other than the specified output color mode, the designated tray will not be selected when the paper tray is set to auto. Choose from [For All Output Colors], [When Color is Selected Only], or [When Black is Selected Only].

Automatic tray selection means that a tray containing the appropriate paper is automatically selected by the machine for copying or printing.

You can select the Trays 1 to 4, and 6. The Tray 5 (Bypass) cannot be selected.

• Paper Color

The paper color can be set if you select [Enabled] for [Paper Color] under [Customize Paper Supply Screen].

Customize Paper Supply Screen

Allows you to customize items displayed on the [Paper Supply] screen.

■Paper Color

Select [Enabled] or [Disabled]. Selecting [Enabled] allows you to set and display paper colors.

- After selecting a paper tray under [Paper Tray Attributes], you can select the paper color.
- You can display paper colors on the [Paper Supply] screen which appears when you select [Copy] > [Paper Supply] > [More...].

■Other Attributes

Select [Disabled], [Size Detection], or [Auto Paper Select]. Selecting [Size Detection] or [Auto Paper Select] allows you to display the [Size Detection] button on the [Paper Supply] screen which appears when you select [Copy] > [Paper Supply] > [More...].

Paper Tray Attributes on Setup Menu

Select whether [Paper Size/Type] is displayed in the [Setup Menu] screen or not.

Paper Tray Attributes During Loading

Select whether the [Change Settings] screen ([Paper Size/Type] screen) for the target tray is displayed or not when pulling out or inserting the tray.

Tray 5 (Bypass) cannot be selected.

Paper Tray Priority

Set the paper tray priority sequence for automatic tray selection.

Automatic tray selection means that a tray containing the appropriate paper is automatically selected by the machine for copying or printing.

You can select the Trays 1 to 4 and 6. The Tray 5 (Bypass) cannot be selected.

Paper Type Priority

Set the paper type priority sequence for automatic tray selection.

Automatic tray selection means that a tray containing the appropriate paper is automatically selected by the machine for copying or printing.

You can set plain paper, recycled paper, side 2 paper, and custom paper 1 to 5.

The paper type priority setting takes precedence over the paper tray priority settings.

If different paper types appear in the same priority sequence, the paper selection is determined by paper tray priority sequence. Selecting [Auto Paper Off] for a paper type prevents its paper tray from being used by automatic tray selection.

For information about the tray priority sequence, refer to "Paper Tray Priority" (P.128).

Tray 5 (Bypass) - Paper Size Defaults

Set the paper sizes shown in the [Tray 5 - (Bypass)] screen for [Paper Supply] when copying with the Tray 5 (Bypass).

You can assign 11 paper sizes to the Tray 5 standard size buttons 1 to 11.

If you frequently use non-standard size paper for copying, assigning the paper size to a button will save your time to specify the size each time. It is also convenient to set the commonly used paper sizes toward the top.

■ A/B Series Size

You can select from sizes of A and B series.

■ Inch Size

You can select from sizes of inch series.

■ Others

You can select from other sizes.

■ Variable Size

You can enter any size. Set the width (X) within the range 148 to 488 mm, and the height (Y) within the range 100 to 330 mm in 1 mm increments.

Auto Tray Switching

Set the method of auto tray switching when running out of paper loaded in the tray selected.

■ Enable during Auto Paper

Only when [Auto Paper] is selected for [Paper Supply], the machine automatically selects a tray containing appropriate paper.

■ Always Enable

Regardless of which paper tray is selected for [Paper Supply], the machine automatically selects a tray containing appropriate paper depending on the conditions.

Note

- The machine does not switch the tray automatically in the following cases:
 - The Tray 5 (Bypass) is selected.
 - The tray containing paper other than plain paper, recycled paper, side 2 paper, or Custom1 to Custom 5 paper is selected.
 - The tray containing paper that is set as [Auto Paper Off] in [Paper Type Priority] is selected.

Image Quality

You can specify the image quality processing method for each of bond paper, plain paper, recycled paper, side 2 paper, heavyweight paper F, heavyweight paper 1, heavyweight paper 1 (side 2), heavyweight paper 2, heavyweight paper 2 (side 2), and custom paper 1 to 5. When copying or printing a document, the machine controls the image quality according to the type of paper set in [Paper Type] and the image quality processing method specified for that type of paper.

Refer to the following table for available setting items.

For information about paper characteristics and notes on use, refer to "Paper Types" (P.24).

Setting values	Meaning
Plain A (64 - 80 g/m ²)	Paper having ream weight of 64 - 80 g/m ² .
Plain B (81 - 104 g/m ²)	Paper having ream weight of 81 - 105 g/m ² .
Plain C	Thin coated paper, intermediate paper, etc.
Recycled A (64 - 80 g/m ²)	Recycled paper with rough surface having ream weight of 64 - 80 g/m ² .
Recycled B (81 - 104 g/m ²)	Recycled paper with rough surface having ream weight of 81 - 105 g/m ² .
Heavyweight 1A (105 - 128 g/m ²)	Paper having ream weight of 106 - 128 g/m ² .
Heavyweight 1B (129 - 176 g/m ²)	Paper having ream weight of 129 - 176 g/m ² .
Heavyweight 2A (177 - 256 g/m ²)	Paper having ream weight of 177 - 256 g/m ² .
Heavyweight 2B (257 - 280 g/m ²)	Paper having ream weight of 256 - 280 g/m ² .
Heavyweight 2C	Postal cards having ream weight of not less than 177 g/m ² .
Heavyweight 2D	Postcards having ream weight of not less than 177 g/m ² .
Heavyweight 2E - Envelopes	Envelopes, etc.
Coated 1A (105 - 128 g/m ²)	Coated paper having ream weight of 106 - 128 g/m ² .
Coated 1B (129 - 176 g/m ²)	Coated paper having ream weight of 128 - 176 g/m ² .

Image Quality Adjustment

You can set the image quality and calibration settings.

Image Quality

You can select the image quality processing method when the machine is scanning an original.

■ Photo & Text Recognition

Select a level which is used for the machine to determine text or photos. This setting is used when you select [Photo & Text] for [Original Type] on the [Image Quality] screen.

Selecting [More Text] makes it easier for very fine print to be recognized as text.

Selecting [More Photo] makes it easier for newspaper and advertisement halftone images to be recognized as photos.

■ Output Color Recognition

Select a level from the five levels which is used for the machine to determine a document as monochrome or color. This setting is used when you select [Auto] for [Output Color] on the [Copy] screen.

Selecting [More Black] makes originals more easily recognized as monochrome.

Selecting [More Color] makes originals more easily recognized as color.

■ Photo Reproduction Level

When copying with [Original Type] in the [Image Quality] screen set to [Photo & Text], you can adjust the color reproduction level in the areas determined by the machine to be photos.

Selecting [More Text] emphasizes the dense parts of the image, yielding a bold copy effect.

Selecting [More Photo] makes the gradation of the photo parts of the image softer.

■ Photo Image Quality

[Photo Image Quality] is valid when [Photo & Text] is selected for [Original Type] on the [Image Quality] screen.

Selecting [High Speed] copies a document without reducing the processing speed.

Selecting [High Quality] copies a document with actual image quality.

- Note**
- This feature does not appear for some models. An optional package is necessary. For more information, contact our Customer Support Center.
 - Selecting [High Quality] may reduce the copy speed.

■ Background Suppression (Color Copy)

Set the method of background suppression to be used when making color copies.

Set how the machine detects the density of and deletes the background color.

Select [High Speed] to sample a section of the original and detect the background color.

Select [High Quality] to conduct a pre-scan, and sample the whole document to detect the background color.

- Important**
- When you select [High Quality], and if [Corner Shift] is selected in [Image Shift] and a ratio not greater than 60% is set in [Reduce/Enlarge], a part of an image may not be printed or blank paper may be output.

■ Background Suppression (B/W Copy)

Set the method of background suppression to be used when making monochrome copies.

Set how the machine detects the density of and deletes the background color.

Select [High Speed] to sample a section of the original and detect the background color.

Select [High Quality] to conduct a pre-scan, and sample the whole document to detect the background color.

- Important**
- When you select [High Quality], and if [Corner Shift] is selected in [Image Shift] and a ratio not greater than 60% in [Reduce/Enlarge] is set, a part of an image may not be printed or blank paper may be output.

■ Background Suppression (Scan Jobs)

Set the method of background suppression to be used for scan operations.

Set how the machine detects the density of and deletes the background color.

Select [High Speed] to sample a section of the original and detect the background color.

Select [High Quality] to conduct a pre-scan, and sample the whole document to detect the background color.

- Important**
- When using the document feeder, the machine detects the background color with [High Speed], even when [High Quality] is selected. However, [High Quality] is available if Scanner Kit (optional) is installed.

■ Image Enhancement

Select whether or not to carry out image enhancement. If you select [On], copy data is smoothed, to give a smoother appearance.

Calibration

When the color gradation of a printed image is shifted, the gradation can be adjusted. By means of this adjustment, the print image quality of the machine can be maintained at a constant level.

For more information, refer to "Executing Calibration" (P.66).

If color gradation is not compensated despite the periodic calibration, contact our Customer Support Center.

■Screen Type

- Copy Job
Adjusts the gradation for copying documents.
- Print Job 1
Basic screen for printing.
For PCL print drivers
Adjusts the gradation for items other than [CAD] and [Presentation] of [Image Types] in the [Image Options] tab.
For PostScript printers
Adjusts the gradation for [Auto] and [Standard] of [Screen] in the [Image Options] tab.

Note • Displayed Screen may differ corresponding to settings of [Image Type], [RGB Correction] and [CMYK Correction], when [Auto] is selected.

- Print Job 2
For PCL print drivers
Adjusts the gradation for [Presentation] at [Image Type] in the [Image Options] tab.
For PostScript printers
Adjusts the gradation for [Auto] and [Gradation] of [Screen] in the [Image Options] tab.

Note • Displayed Screen may differ corresponding to settings of [Image Type], [RGB Correction] and [CMYK Correction], when [Auto] is selected.

■Paper Supply

Select a tray in which one of the following paper sizes is loaded: A3, A4□, 11 x 17 inches, 8.5 x 11 inches□.

■Target

Select from [Copy and Print Jobs], [Copy Jobs Only], [Print Jobs Only], and [None].

Reports

These settings relate to printing reports.

Print Report Button

Select whether or not to permit printing reports only in [User Mode] of the System Administration mode. Selecting [Disabled] displays the [Print Report/List] and [Error History Report] buttons only in the System Administration mode, under [Machine Status] > [Billing Meter/Print Report].

For information on [Print Report/List], refer to "Print Report/List" (P.97).

Job History Report

You can select whether or not to automatically print a [Job History Report] when a total of 50 jobs have been processed. All jobs are automatically listed on the printed report.

Scan File Transfer Report

Select whether or not to print the report for scanned data transmission results, such as when transferring to the computer on the network, or when transferring using e-mail.

■Auto Print Off

Does not print the report regardless of the data transmission result.

■Auto Print On

Automatically prints the transmission report when the data transmission is successful, and automatically prints the transmission report (undelivered) when the data transmission fails.

■Transmission Report - Undelivered

Prints the transmission report (undelivered) when the data transmission fails.

Fax Server Report

Set whether to print a transmission report after scanned data is sent using the Server Fax feature.

Note • This feature does not appear for some models. An optional package is necessary. For more information, contact our Customer Support Center.

■Auto Printer Off

Does not print a report regardless of whether data transmission is successfully completed or not.

■Auto Print On

Automatically prints a transmission report for a successful transmission and a transmission report (undelivered) for a transmission failure.

■Transmission Report - Undelivered

Prints a transmission report (undelivered) for a transmission failure.

2 Sided Report

When printing a report/list, select whether to print 1-sided or 2-sided.

Note • This feature does not appear for some models. An optional package is necessary. For more information, contact our Customer Support Center.

Job Flow Error Report

Select whether or not to automatically print a [Job Flow Error Report].

Maintenance

You can initialize the hard disk or delete data recorded in the machine.

Initialize Hard Disk

Initializes the hard disk.

Data deleted by initialization includes supplementary fonts and HP-GL/2 form.

Note • The secure print documents and logs are not erased.

Delete All Data

This feature is used to prevent the leakage of customer's confidential information when the machine is returned to Fuji Xerox. By executing [Start], all data registered in the machine is deleted.

Do not use this function.

Software Options

This feature is for customer engineer use. For more information, contact our Customer Support Center.

Adjust Image Position

This feature adjusts the position of the images to be printed on paper.

You can set the print position for each tray, each paper type, and each side of paper.

Adjusting the print positions for the front and back sides of paper is helpful when you add crop marks, or when you cut edges of output paper.

X represents the paper width, and Y represents the paper length.

Note • Changing a value may move images out of paper. Check the print position carefully when you change a value.

Watermark

You can make settings relating to Watermark.

- Note**
- Pressing [Sample List] at the upper-right of the screen prints hidden text samples of various densities. Set the optimum contrast for hidden text and background referring to the print samples.

Date Format

Set the format for printing dates in annotations and Watermark. This setting is common to Annotation and Watermark.

Three format types are available: 20yy/mm/dd, dd/mm/20yy, and mm/dd/20yy.

Text Effect Default

Set the type of text effect for Watermark.

■Off

A text effect is not applied.

■Embossed

The text hidden in the background is embossed. The text part is printed with the pattern specified in [Background Pattern].

■Outline

The text hidden in the background is printed as white cutout. In the background other than the text printed as white cutout, the pattern set in [Background Pattern] is printed.

Text Default

Set text to be printed with Watermark.

You can select text from "Copy Prohibited", "Copy", "Duplicate", and the strings registered on Custom Text 1 to 3.

For more information about Custom Text, refer to "Custom Text 1 to 3" (P.134).

Text Size

Set the size of the text printed with Watermark.

You can set the value from 24 to 80 points in 1 point increments.

Background Pattern

Set the background pattern to be used for the Watermark text effect.

You can select from eight patterns: wave, circle, stripe, chain, beam, rhombic, sunflower, and fan.

Color

Set the color used for printing Watermark text.

You can select from 3 colors: black, magenta, and cyan.

Density

Set the density for printing the text in Watermark.

You can select from three levels from lighter to darker.

Text/Background Contrast

Set the text/background contrast for Watermark printing.

You can select from contrast levels 1 to 9. Set the text/background contrast after checking the samples by selecting [Sample List].

Force Watermark - Copy Job

Set whether to force Watermark printing for copying.

Force Watermark - Client Print

Set whether to force Watermark printing for printing from a client computer.

Force Watermark - Mailbox Print

Set whether to force Watermark printing for printing from the mailbox.

Custom Text 1 to 3

Register text to be printed with Watermark. You can enter up to 32 characters. The registered text is displayed at "Text Default" (P.133).

For information about how to enter characters, refer to "2 Product Overview" > "Entering Text" in the User Guide.

Sample List

Prints hidden text samples of various densities. Set the optimum contrast for hidden text and background referring to the print samples.

Secure Watermark

Set the secure watermark.

- Important** • The document copy restriction that is set using the Secure Watermark feature is not warranted to always function. The feature may not function depending on the document or setting conditions. For more information, contact our Customer Support Center.
- Our company will not be liable for any loss or damage arising out of the use of or inability to use the Secure Watermark feature.
- Note** • An optional package is required to use this feature. For more information, contact our Customer Support Center.
- This feature is only available for any Fuji Xerox manufactured machine installed with secure watermark feature.

Secure Watermark Control

- Secure Watermark Detection
Set whether or not to detect a copying restriction code embedded in a document.

Digital Codes Settings

- Decoding Passcode
You can set the decoding passcode for a digital code to be embedded in a document. Setting the decoding passcode allows you to restrict access to a digital code analysis application.
- Note** • To analyze digital codes, the application ApeosWare Secure Watermark Analyzer (optional) is required. For information on how to operate Paper Security Analyzer, refer to the documentation provided with the application.
- Important** • Be sure to place strict controls on the decoding passcode. If you forget the specified decoding passcode or your passcode entry does not match that registered on ApeosWare Secure Watermark Analyzer, you will not be able to analyze the digital code on ApeosWare Secure Watermark Analyzer.

- 1 Select [Decoding Passcode].
- 2 Select [Change Settings].
- 3 Select [Keyboard].
- 4 Enter a new passcode of 4 to 12 characters in [Re-enter Password], and select [Next].
- 5 Select [Keyboard].
- 6 Enter the same password in [Re-enter Password], and select [Save].

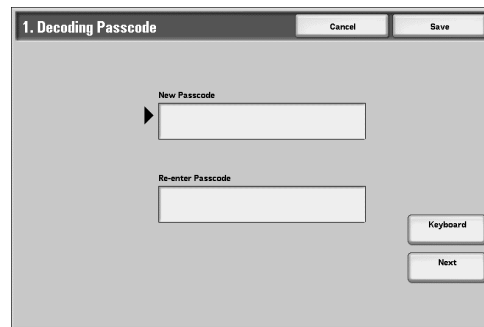

Note • To set no password, leave the password blank, and select [Save].

■ Custom Text

Specify a digital code string to be embedded in a document. You can enter up to 32 characters.

For information about how to enter characters, refer to "2 Product Overview" > "Entering Text" in the User Guide.

Force Secure Watermark

■ Copy Job

Set whether or not to force to use the Secure Watermark feature when copying a document.

■ Client Print

Set whether or not to force to use the Secure Watermark feature when printing from a client computer.

■ Mailbox Print

Set whether or not to force to use the Secure Watermark feature when printing a document in a mailbox.

■ Report/List

Set whether or not to force to use the Secure Watermark feature when printing a report/list.

Secure Watermark Defaults

■ Protection Code

Set whether or not to embed a protection code in a document. Any document from which the protection code was detected cannot be copied or scanned.

Text Effect

The Text Effects allows you to embed hidden text in a copied/printed document. When the document in which the hidden text has been embedded is copied, the hidden text appears as white cutout.

■ Text Default

Specify hidden text for the Secure Watermark feature.

You can select text from "Copy Prohibited", "Copy", "Duplicate", and the strings registered on Custom Text 1 to 3.

■ Background Pattern

Specify a hidden text background pattern used for the Secure Watermark feature.

You can select from eight patterns: wave, circle, stripe, chain, beam, rhombic, sunflower, and fan.

■ Color

Specify a hidden text color used for the Secure Watermark feature.

You can select from black and magenta.

■Text/Background Contrast

Specify a level of hidden text/background contrast used for the Secure Watermark feature. You can select from contrast levels 1 to 9. Set the text/background contrast after checking the samples by selecting [Print Sample List].

Important • The hidden text/background contrast can be adjusted by changing hidden text density. The background density cannot be adjusted.

■Custom Text 1 to 3

Register hidden text for the Secure Watermark feature. You can enter up to 32 characters.

For information about how to enter characters, refer to "2 Product Overview" > "Entering Text" in the User Guide.

■Sample List

Prints hidden text samples of various densities. Set the optimum contrast for hidden text and background referring to the print samples.

Image Log Control (ApeosPort series models only)

Image Log Control is a feature that creates images of documents processed on the machine and attaches logs to those images. By storing document images as image logs, this feature can manage jobs and track down problems such as leakage of confidential documents.

Important • If you set [Assurance Level] of [Image Log Generation] or [Image Log Transfer] to [High], jobs will be printed after generating or transferring image logs, and thus will not be printed immediately.

- When the Image Log Control feature is enabled, it may take considerable time to preview a document stored in a mailbox.

Note • If you set [Service Rep. Restricted Operation] to [On], our service representatives will be restricted from accessing the [Image Log Control] settings. For more information about [Service Rep. Restricted Operation], refer to "Service Rep. Restricted Operation" (P.144).

- Some models do not display this feature, and require an optional kit to use it. For more information, contact our Customer Support Center.

Image Log Control

Sets whether or not to use the Image Log Control feature.

Image Log Target

Allows you to select types of jobs to create image logs.

Image Log Generation

Allows you to set how to create image logs of documents. Image logs will be created one (PDF file) per document.

■Assurance Level

Sets the log generation assurance level to [Low] or [High].

Note • If you select [Low], image logs may not be saved under some circumstances.

■Resolution

Sets the resolution of document images to [25dpi], [50dpi], [72dpi], [100dpi], or [200dpi].

■Page Range

Sets the page range of document images to [First Page Only], [First 2 Pages], [First 3 Pages], [First 4 Pages], [First 5 Pages], or [All Pages].

Image Log Transfer

Image logs created on the machine can be stored and managed by transferring to a log management server. [Image Log Transfer] allows you to set how and when to transfer image logs.

- **Assurance Level**
Sets the log transfer assurance level to [Low] or [High].
- **Auto Transfer**
Sets whether or not to automatically transfer image logs to a log management server. The options available are [Off], [When Job Is Running], and [Select Timing].
- **Transfer Timing**
Sets when to transfer image logs to a log management server. The options available are [At the end of the job], [At the end of selections], [At power On], and [When max is reached].

Print Universal Unique ID (ApeosPort series models only)

You can print UUIDs for each print job. The printed UUIDs can be used as search keys to search for print job logs when using an application, such as ApeosWare Accounting Service (optional).

Print Universal Unique ID

Select whether to print Universal Unique IDs.

Important • If [Print Universal Unique ID] is set to [Yes], the automatic size detection feature will be disabled for Tray 5 (Bypass).

Print Position

Select the print position from 6 positions: [Top Left], [Bottom Left], [Top Center], [Bottom Center], [Top Right], and [Bottom Right].

Print Position Adjustment

Adjusts the print positions in the vertical and horizontal directions from 0 to 100 mm, and from 0 to 200 mm, respectively, in 0.5 mm increments.

Note • The adjustment value is 0 mm at the edge of paper. Increasing the value moves the print position toward the center of the paper. Note, however, that the adjustment value in left and right directions for [Top Center] or [Bottom Center] is 100 mm at the center of paper. When you selected [Top Center] or [Bottom Center], therefore, set the value to 100 mm first and then specify the desired value.

Print Position (Side2)

When making 2-sided copies, set the position where the UUID is printed on Side 2.

■ Same as Side 1

Prints in the same position as the front side.

■ Opposite to Side 1

Prints in a position symmetrically opposite to the front side.

Other Settings

You can make other settings relating to the machine itself.

Fax Service

Switches between the Fax and Server Fax features.

Note • This feature does not appear for some models. An optional package is necessary. For more information, contact our Customer Support Center.

■ Scan to Fax

Allows you to use the Fax feature on the machine.

■ Scan to Fax Server

Allows you to use the Server Fax feature on the machine.

Auto Job Promotion

You can select whether to allow other jobs that can be started to automatically bypass the job, if the machine is unable to start an operation for any reason, (for example, running out of paper in a tray when starting copying or printing).

Note • Stored documents such as Secure Print and Sample Print documents are excluded from Auto Job Promotion.

Offset Stacking (Center Output Tray)

Offsetting means that each set (copies) or each job is delivered at a slightly shifted output position from the output position of the previously output set or job. If the previous copy set is output to a front position on the tray, the next copy set is output to a back position on the tray. Set the operation of this offset feature.

Note • This feature does not appear for some models. An optional package is necessary. For more information, contact our Customer Support Center.

■ None

No offset output.

■ Offset per set

Offsets the output position for each set of copies.

■ Offset per job

Offsets the output position for each job being specified.

Offset Stacking (Finisher Tray)

Set the offset feature for the finisher tray.

For information on the settings, refer to "Offset Stacking (Center Output Tray)" (P.138).

Note • This feature does not appear for some models. An optional package is necessary. For more information, contact our Customer Support Center.

Default Print Paper Size

Set the paper size used when printing reports or lists.

You can select from two sizes: A4 or 8.5 × 11".

Paper Size Settings

Set the paper size series for originals and output paper to use the automatic paper detection feature.

You can select from five types: A/B series (8×13"), A/B series, A/B series (8K/16K), A/B series (8×13"/8×14"), and inch series.

Refer to the following table for the combinations of sizes that can be detected automatically.

Paper size group	A/B series (8 x 13")					A/B series							
	Original position	Document glass	Document feeder	Trays 1 to 2	Trays 3 to 4	Tray 5 (Bypass)	Tray 6	Document glass	Document feeder	Trays 1 to 2	Trays 3 to 4	Tray 5 (Bypass)	Tray 6
Size/Orientation													
A6	O	-	-	-	-	-	-	O	-	-	-	-	-
A5	O	O	O	-	O	-	-	O	O	O	-	O	-
A5	O	-	-	-	-	-	-	O	O	-	-	-	-
A4	O	O	O	-	-	-	-	O	O	O	-	O	-
A4	O	O	O	O	O	O	O	O	O	O	O	O	O
A3	O	O	O	-	O	-	-	O	O	O	-	O	-
B6	O	-	-	-	-	-	-	O	-	-	-	-	-
B6	-	-	-	-	-	-	-	O	-	-	-	-	-
B5	-	-	O	-	O	-	-	O	O	O	-	O	-
B5	-	O	O	O	O	O	O	O	O	O	O	O	O
B4	-	O	O	-	O	-	-	O	O	O	-	O	-
5.5 x 8.5	-	-	-	-	-	-	-	-	-	-	-	-	-
5.5 x 8.5	-	O	-	-	-	-	-	-	-	-	-	-	-
7.25 x 10.5	O	O	-	-	-	-	-	-	-	-	-	-	-
8 x 10	-	-	-	-	-	-	-	-	-	-	-	-	-
8 x 10	-	-	-	-	-	-	-	-	-	-	-	-	-
8.5 x 11	-	O	O	-	-	-	-	-	O	O	-	-	-
8.5 x 11	O	O	O	O	-	O	-	-	O	O	O	-	O
8.5 x 13	O	O	O	-	-	-	-	-	-	O	-	-	-
8.5 x 14	-	-	O	-	-	-	-	-	-	O	-	-	-
11 x 17	O	O	O	-	-	-	-	-	O	O	-	-	-
16K	-	-	-	-	-	-	-	-	-	-	-	-	-
16K	-	-	O	-	-	-	-	-	O	O	-	-	-
8K	-	-	-	-	-	-	-	-	O	-	-	-	-
Postcard	-	-	-	-	-	-	-	-	-	-	-	-	-
Choukei 3	-	-	-	-	-	-	-	-	-	-	-	-	-
Photo 2L	-	-	-	-	-	-	-	-	-	-	-	-	-
4 x 6	-	-	-	-	-	-	-	-	-	-	-	-	-
4 x 6	-	-	-	-	-	-	-	-	-	-	-	-	-

Paper size group	A/B series (8 K/ 16 K)						A/B series (8 x 13 7/8 x 14")						Inch series						
	Original position	Document glass	Document feeder	Trays 1 to 2	Trays 3 to 4	Tray 5 (Bypass)	Tray 6	Document glass	Document feeder	Trays 1 to 2	Trays 3 to 4	Tray 5 (Bypass)	Tray 6	Document glass	Document feeder	Trays 1 to 2	Trays 3 to 4	Tray 5 (Bypass)	Tray 6
Size/Orientation																			
A6	O	-	-	-	-	-	-	O	-	-	-	-	-	-	-	-	-	-	-
A5	O	O	O	-	-	O	-	O	O	O	-	O	-	-	-	-	-	-	-
A5	O	O	-	-	-	-	-	O	-	-	-	-	-	O	-	-	-	-	-
A4	O	O	O	-	-	O	-	O	O	O	-	O	-	-	O	O	-	-	-
A4	O	O	O	O	O	O	O	O	O	O	O	O	O	O	O	O	O	O	O
A3	O	O	O	-	-	O	-	O	O	O	-	O	-	-	O	O	-	-	-
B6	O	-	-	-	-	-	-	-	-	-	-	-	-	-	-	-	-	-	-
B6	O	-	-	-	-	-	-	-	-	-	-	-	-	-	-	-	-	-	-
B5	O	O	O	-	-	O	-	O	-	O	-	O	-	-	O	-	O	-	-
B5	O	O	O	O	O	O	O	O	O	O	O	O	O	-	O	-	-	-	-
B4	O	O	O	-	-	O	-	O	O	O	-	O	-	-	O	O	-	-	-
5.5 x 8.5	-	-	-	-	-	-	-	-	-	-	-	-	-	O	O	O	-	O	-
5.5 x 8.5	-	-	-	-	-	-	-	O	O	-	-	-	-	O	O	-	-	-	-
7.25 x 10.5	-	-	-	-	-	-	-	-	O	-	-	-	-	O	O	O	O	-	O
8 x 10	-	-	-	-	-	-	-	-	-	-	-	-	-	-	-	O	-	-	-
8 x 10	-	-	-	-	-	-	-	-	-	-	-	-	-	-	-	-	-	-	-
8.5 x 11	-	O	O	-	-	-	-	O	O	O	-	-	-	O	O	O	-	O	-
8.5 x 11	O	O	O	O	-	-	O	O	O	O	-	O	-	O	O	O	O	O	O
8.5 x 13	-	-	O	-	-	O	-	O	O	O	-	O	-	-	-	O	-	-	-
8.5 x 14	-	-	O	-	-	O	-	-	-	O	-	O	-	O	O	O	-	O	-
11 x 17	O	O	O	-	-	-	-	O	O	O	-	-	-	O	O	O	-	O	-
16K	O	-	-	-	-	-	-	-	-	-	-	-	-	-	-	-	-	-	-
16K	O	O	O	-	-	-	-	-	-	O	-	-	-	-	-	-	-	-	-
8K	O	O	O	-	-	-	-	-	-	-	-	-	-	-	-	-	-	-	-
Postcard	-	-	-	-	-	-	-	-	-	-	-	-	-	-	-	-	-	-	-
Choukei 3	-	-	-	-	-	-	-	-	-	-	-	-	-	-	-	-	-	-	-
Photo 2L	-	-	-	-	-	-	-	-	-	-	-	-	-	O	-	-	-	-	-
Photo 2L	-	-	-	-	-	-	-	-	-	-	-	-	-	-	-	-	-	-	-
4 x 6	-	-	-	-	-	-	-	-	-	-	-	-	-	O	-	-	-	-	-
4 x 6	-	-	-	-	-	-	-	-	-	-	-	-	-	-	-	-	-	-	-

Millimeters/Inches

Select whether the unit of measure displayed on the screen is millimeters or inches.

Keyboard Input Restriction

Select whether to restrict the display of the virtual keyboard on the machine. To prevent characters being garbled when switched from one character set to another, you can restrict the input to ASCII characters only. If you select [On (Standard ASCII only)], the displayed keyboard shows ASCII characters only.

Operation of Up/Down Buttons

Select whether or not there is a continuous scrolling effect when the scroll buttons are held down.

- Disable Fast Scrolling
Holding down the scroll buttons does not scroll.
- Enable Fast Scrolling
Holding down the scroll buttons causes continuous scrolling.

Display Consumables Screen

Set whether the machine displays the parts status when parts need to be replaced.

- Off
Does not display the consumable status screen.
- When power is switched on
Status is displayed at startup.
- When Auto Clear is activated
Status is displayed when Auto Clear is executed.

Overwrite Hard Disk

Select whether or not to carry out hard disk overwrite erasing. If you overwrite the hard disk, you can select whether to overwrite once or three times.

When copy, fax, scan, or print processing is completed, the data is deleted from the hard disk and the area on which the deleted data was stored is automatically overwritten with blank data. This feature prevents unauthorized retrieval or restoration of the data recorded on the hard disk. It also applies to copy source, and other information stored temporarily by the system.

Important • If the machine is powered off during the overwriting operation, unfinished files may remain on the hard disk. The overwriting operation will resume if you power the machine on again with the unfinished files remaining on the hard disk.

- The data is erased by overwriting once, but overwriting three times makes it even more definite that the data cannot be recovered. It does, however, take longer.
- During the overwriting process, processing of normal operations may be slowed down.

Note • An optional package is required to use this feature. For more information, contact our Customer Support Center.

For information about how to check the status during the overwriting process, refer to "Overwrite Hard Disk" (P.91).

Prerequisite for Using Security Kit

The system administrator must follow the instructions below:

- To protect the data deleted from or stored on the hard disk, the following settings are required:
 - Overwrite Hard Disk: [1 Overwrite] or [3 Overwrite]
 - Data Encryption: [On]: an encryption key of 8 digits or more (maximum 12 digits)
 - Service Rep. Restricted Operation: [On]

- Change the system administrator's factory default passcode (x-admin). Register a new passcode of 7 characters or more (maximum 12 characters). Be careful not to register a passcode that can be easily assumed and not to store the registered passcode in a location that is easily accessible to other persons.

Important • If the system administrator's user ID and passcode are forgotten, the machine configuration will not be able to recover in case of malfunction.

- Set [Passcode Entry from Control Panel] to [On].
- Set [Maximum Login Attempts] to 5 times.
- Note that the hard disk security will not be warranted if you do not correctly follow the above setting instructions.

For information on how to set [Data Encryption], refer to "Data Encryption" (P.142).

For information on how to set [Service Rep. Restricted Operation], refer to "Service Rep. Restricted Operation" (P.144).

For information on how to set [Passcode Entry from Control Panel], refer to "Passcode Entry from Control Panel" (P.208).

For information on how to set the system administrator's user ID, refer to "System Administrator Login ID" (P.200).

The manager (of the organization that this machine is used for) must be follow the instructions below:

- Assign appropriate persons as system and machine administrators, and manage and train them properly.
- Note that Security Kit is used to protect deleted document data from being recovered; it does not protect documents stored in mailboxes on the hard disk.
- Install an anti-bugging device on the internal network that the machine with Security Kit is located on, and perform the network settings properly to protect the machine from interceptions.
- To block unauthorized access, install a firewall device between the external network and the internal network that the machine is located on.

Data Encryption

Select whether to encrypt the data recorded on the hard disk of the machine.

By setting data encryption, copy, fax, scan, or print data is automatically encrypted when written to the hard disk. The encryption prevents unauthorized access to the stored data. In order to activate this feature, set an encryption key.

Note • An optional package is required to use this feature. For more information, contact our Customer Support Center.

- 1 Select [Data Encryption].
- 2 Select [On].
- 3 Select [Keyboard], and enter an encryption key of up to 12 characters.
- 4 Select [Save].
- 5 Repeat Steps 3 and 4 to reenter the same encryption key.

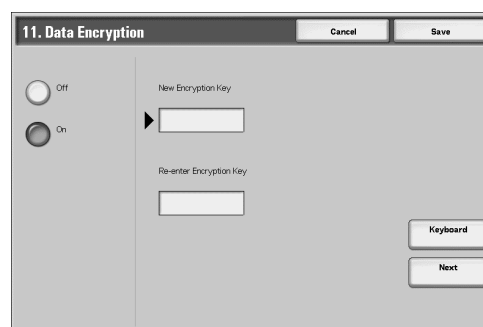

Data Restoration

The encrypted data cannot be restored at the following.

- When a trouble occurs in the hard disk.
- When you have forgotten the encryption key.

- When you have forgotten the System Administrator user ID and a passcode when making the [Service Rep. Restricted Operation] set to [On].

Starting the use of the data encryption feature and changing the settings

When data encryption is started or ended, or when the encryption key is changed, the machine must be restarted. The corresponding recording area (the hard disk) is reformatted when restarting. In this case, the previous data is not guaranteed.

The recording area stores the following data.

- Spooled print data
- Print data including secure print and sample print
- Forms for the form overlay feature
- Mailbox and job flow sheet settings (box name, passcode, etc.)
- Documents in mailboxes
- Address book data

- Important**
- Be sure to save all necessary settings and documents before starting to use the data encryption feature or changing the settings.
 - An error occurs if the connected hard disk does not match the encryption settings. For information on error messages and their remedies, refer to "Other Errors" (P.365).
 - The following procedure is recommended for changing the settings of the encryption while a large amount of data (100 jobs or more) is stored in a mailbox, and [Overwrite Hard Disk] is specified to [1 Overwrite] or [3 Overwrites].
 1. Select [System Settings] > [Setup Menu] > [Mailbox] to display the [Mailbox] screen.
 2. Select the mailbox, then select [Create / Delete] > [Delete Mailbox].
 3. Select [Close] until the [System Settings] screen is displayed. Then select [Exit] to exit the system administration mode.
 4. Press the <Machine Status> button, then make sure that [Standby] in [Overwrite Hard Disk] is displayed.
 5. Enter the System Administration mode, and change the data encryption settings. For information on how to enter the System Administration mode, refer to "System Settings Procedure" (P.108).
 - Our customer engineer cannot restore the encryption key.
 - Replacing the electrical component board by our customer engineer initializes the encryption key. Do not lose the encrypted information.

Encryption Key for Confidential Data

Setting an encryption key allows you to encrypt confidential information such as the passcodes of the system administrator and mailboxes. This prevents interceptions and unauthorized access to the information during transmission across networks. Select [Keyboard], and then enter an encryption key of 4 to 12 digits using the keyboard on the screen.

Important • If you change the existing encryption key, confidential information may not be able to be restored from a backup.

Note • The factory default encryption key is "x-admin".

- 1 Select [Encryption Key for Confidential Data] and then [Change Settings].
- 2 Select [Keyboard], and enter an encryption key of 4 to 12 digits.
- 3 Select [Save].
- 4 Repeat steps 2 and 3 to re-enter the same encryption key.
- 5 Select [Save] to display a confirmation screen. Select [Yes] on the screen to save the setting.

Service Rep. Restricted Operation

This feature protects the Security Kit settings from being altered by an outsider pretending to be our customer engineer. Select whether to permit our customer engineer to perform [Overwrite Hard Disk] and [Data Encryption] operations, and to change the [HTTP - SSL/TLS], [System Administrator Login ID], [System Administrator's Passcode], and [Maximum Login Attempts] settings. Make sure not to lose the system administrator's user ID and passcode. Otherwise, the various settings that are only available in system administrator mode cannot be changed. If the system administrator's user ID and passcode are lost when [Service Rep. Restricted Operation] is set to [On], not only you but also we are no longer able to change any setting in system administrator mode. If you lose the system administrator's user ID and passcode when the Security Kit is installed, the electric component board of the machine must be replaced in order to change any setting in system administrator mode. In that case, you will be charged for the electrical component board and handling cost.

Note • An optional package is required to use this feature. For more information, contact our Customer Support Center.

Software Download

This feature is for customer engineer use. For more information, contact our Customer Support Center.

Document Feeder Tray Elevation

When a document is loaded in the document feeder, set to which timing to raise an elevator tray can be performed. Select from [When loading originals] and [When pressing Start].

Note • This feature does not appear for some models.

Gloss Level

Set whether to display the gloss level feature.

When [Enable] is selected, the [Gloss] button appears in [Image Quality] of the [Copy] screen. Select [Enable] if the following feature is used in the print mode of the printer driver.

- PCL driver : Glossy Printing
- PostScript driver : High Quality

Note • When you use the print mode above from the printer driver, 1024MB system memory is needed in the machine .

Estimated Time for Single or All Jobs

The information to display can be set when displaying prediction time until it completes to the waiting job for a print.

- Cumulative Time Required
Displays the remaining time.
- Time Required
Displays the required time of each job.

Recipient Selection Method

Set whether to place restrictions on e-mail transmissions to addresses unregistered on Address Book.

Selecting [Only From Address Book] disables address entry on the [E-mail] screen using the keyboard or numeric keypad, and permits only transmissions to addresses registered on Address Book.

Copy Mode Settings

In [Copy Mode Settings], you can make settings relating to the copy feature. The following shows the reference section for each item.

General Settings Tab - Features Allocation	145
Preset Buttons.....	146
Copy Defaults.....	146
Copy Control.....	151
Original Size Defaults	153
Reduce/Enlarge Presets	153
Custom Colors.....	153
Annotation - Create Stamps	154

- 1 On the [System Settings] screen, select [System Settings].
For the method of displaying the [System Settings] screen, refer to "System Settings Procedure" (P.108).
- 2 Select [Copy Mode Settings].
- 3 Select the item to be set or changed.

General Settings Tab - Features Allocation

You can set the features that appear in the third and fourth columns from the left of the [General Settings] screen. By setting the most commonly used features, you can avoid extra operations such as selecting tabs.

Note • Do not assign a feature to more than 1 buttons.

- 1 Select [General Settings Tab - Features Allocation].
- 2 Select the number of features displayed on the [General Settings] screen.
- 3 From the buttons appearing on [Frequently Used Features], select the position where you want to allocate a feature.

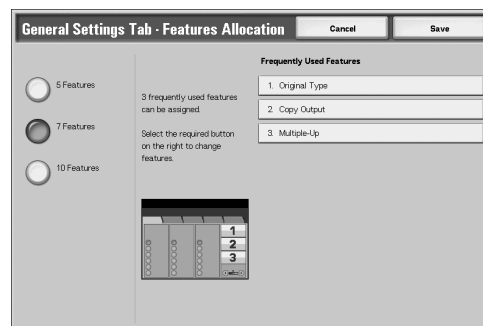

■ **5 Features**

When you select [5 Features], no feature can be allocated.

■ **7 Features**

Allows you to set the features appearing in the fourth column from the left of the [General Settings] screen. Up to 3 features can be allocated.

■ **10 Features**

Allows you to set the features appearing in the third and fourth columns from the left of the [General Settings] screen. Up to 6 features can be allocated.

■ **Frequently Used Features**

The position of the buttons shows the position of the buttons in the [Basic Copy] screen.

- 4 Select [Features] or [Settings].
- 5 Select the feature to be displayed, and select [Save].
- 6 Repeat steps 3 to 5 as required.
- 7 Press [Save].

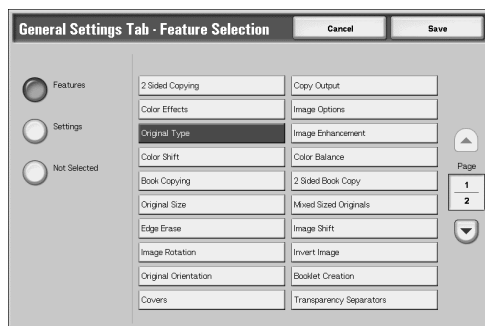

■Features

The feature buttons in tabs other than the [General Settings] screen can be displayed on the [General Settings] screen.

■Settings

The setting value of the feature buttons in tabs other than the [General Settings] screen can be displayed on the [General Settings] screen, and selected directly on the screen.

Preset Buttons

Paper Supply - Button 2 - 5

For the feature buttons appearing in [Paper Supply] on the [General Settings] screen, you can set the paper tray.

Reduce/Enlarge - Button 3 - 5

For the feature buttons appearing in [Reduce/Enlarge] in the [General Settings] screen, you can set the ratio.
You can select the ratio from the registered R/E Preset buttons.

Copy Defaults

This sets the default settings of copy feature settings. When the power is turned on or the machine returns from a Power Save mode, or when the <Clear All> button is pressed, the system returns to the defaults set here. By setting features you often use as defaults, you can avoid extra operations required in use.

Paper Supply

Set the default value for [Paper Supply] in the [General Settings] screen.
When the default value of [Reduce/Enlarge] is set to [Auto %], [Auto Paper] cannot be selected for [Paper Supply].

Reduce/Enlarge

Set the default value for [Reduce/Enlarge] in the [General Settings] screen.
Select the ratio from [100%], [Auto %], and the buttons registered as R/E Preset buttons.
When the default setting for [Paper Supply] is [Auto Paper], [Auto %] cannot be selected for [Reduce/Enlarge].
For information about R/E Preset buttons, refer to "Reduce/Enlarge Presets" (P.153).

Output Color

Set the default value for [Output Color] in the [General Settings] screen.
When [No Default] is selected, select the output color in the [General Settings] screen before making copies.

Single Color

Set the default value for [Output Color] > [More...] > [Single Color] in the [General Settings] screen. You can select from six preset colors and six custom colors.

For information about custom colors, refer to "Annotation - Create Stamps" (P.154).

Dual Color - Source Color

Set the default value for [Source Color] that appears when [Output Color] > [More...] > [Dual Color] is selected in the [General Settings] screen.

After selecting [Color Selection], you can select from six colors.

Dual - Target Area Color

Set the default value for [Target Area Color] that appears when [Output Color] > [More...] > [Dual Color] is selected in the [General Settings] screen. You can select from seven preset colors and six custom colors.

For information about custom colors, refer to "Annotation - Create Stamps" (P.154).

Dual - Non-target Area Color

Set the default value for [Non-target Area Color] that appears when [Output Color] > [More...] > [Dual Color] is selected in the [General Settings] screen. You can select from seven preset colors and six custom colors.

For information about custom colors, refer to "Annotation - Create Stamps" (P.154).

Original Type

Set the default value for [Original Type] in the [Image Quality] screen.

Original Type - Auto (Non-Black)

Set the default value for [Original Type] on the [Image Quality] screen.

This is valid when an item other than [Black] is selected for [Output Color] in the [Copy] screen.

Original Type - Auto (Black)

Set the default value for [Original Type] in the [Image Quality] screen.

This is valid when [Black] is selected for [Output Color] in the [Copy] screen.

Lighten/Darken

Set the default value for [Lighten/Darken] of [Image Options] in the [Image Quality] screen.

Contrast

Set the default value for [Contrast] of [Image Enhancement] in the [Image Quality] screen.

Sharpness

Set the default value for [Sharpness] of [Image Options] in the [Image Quality] screen.

Saturation

Set the default value for [Saturation] of [Image Options] in the [Image Quality] screen.

Background Suppression

Set the default value for [Background Suppression] in the [Image Quality] screen. [Background Suppression] is valid when [Original Type] is set to [Photo & Text], [Text], or [Photo].

Color Balance - Yellow

Set the default density levels for the [Color Balance] in the [Image Quality] screen. You can set density levels of yellow for each of the [Low Density], [Medium Density], and [High Density].

Color Balance - Magenta

Set the default density levels for the [Color Balance] in the [Image Quality] screen. You can set density levels of magenta for each of the [Low Density], [Medium Density], and [High Density].

Color Balance - Cyan

Set the default density levels for the [Color Balance] in the [Image Quality] screen. You can set density levels of cyan for each of the [Low Density], [Medium Density], and [High Density].

Color Balance - Black

Set the default density levels for the [Color Balance] in the [Image Quality] screen. You can set density levels of black for each of the [Low Density], [Medium Density], and [High Density].

Color Shift

Set the default value for [Color Shift] in the [Image Quality] screen.

2 Sided Copying

Set the default value for [2 Sided Copying] in the [Layout Adjustment] screen.

Note • This feature does not appear for some models. An optional package is necessary. For more information, contact our Customer Support Center.

Mixed Sized Originals

Set the default value for [Mixed Sized Originals] in the [Layout Adjustment] screen.

Edge Erase - Top Edge or Edge Erase - Bottom Edge

Set the default value for the amount of edges erased from the original in the top and bottom directions in [Edge Erase] in the [Layout Adjustment] screen. Set the value from 0 to 50 mm in 1 mm increments.

Edge Erase - Left Edge or Edge Erase - Right Edge

Set the default value for the amount of edges erased from the original in the left and right directions in [Edge Erase] in the [Layout Adjustment] screen. Set the value from 0 to 50 mm in 1 mm increments.

Center Erase/Binding Erase

Set the default value for the binding erase amount of the original in [Edge Erase] in the [Layout Adjustment] screen. Set the value from 0 to 50 mm in 1 mm increments.

Edge Erase - Side 2

Set the default value for [Side 2] of [Edge Erase] in the [Layout Adjustment] screen.

Image Shift - Side 1

Set the default value for [Side 1] of [Image Shift] in the [Layout Adjustment] screen.

Image Shift - Side 2

Set the default value for [Side 2] of [Image Shift] in the [Layout Adjustment] screen.

Image Rotation

Set the default value for [Image Rotation] in the [Layout Adjustment] screen.

Image Rotation Direction

Set the default value for [Image Rotation - Rotation Direction], if documents are of mixed orientations.

Original Orientation

Set the default value for [Original Orientation] in the [Layout Adjustment] screen.

Copy Output

Set the default value for [Copy Output] in the [Copy] screen.

Note • If no option is installed in the machine, even when [Collated] is selected, the machine operates as [Uncollated].

Copy Output - Separators Tray

Set the default value for [Separators Tray] under [Uncollated with Separators] on the [Copy Output] screen.

Output Destination

Set the default value of the output destination for printing or copying.

Note • This feature does not appear for some models. An optional package is necessary. For more information, contact our Customer Support Center.

Sample Set

Set the default value for [Sample Set] in the [Job Assembly] screen.

Stamp Text

Set the default value for [Text] displayed when [Stamp] is selected for [Annotation] on the [Output Format] screen.

You can select a stamp type from eight preset types and custom text.

For information about how to set custom text, refer to "Annotation - Create Stamps" (P.154).

Stamp Position (Side 1) (Side 2)

Set the default value for [Position] displayed when [Stamp] is selected for [Annotation] in the [Output Format] screen.

Note • Allows you to specify [Side 1] and [Side 2].
- [Side 1] : Nine positions are available.
- [Side 2] : Select [Same as Side 1] or [Opposite to Side 1].

Stamp Size

Set the default value for [Size] displayed when [Stamp] is selected for [Annotation] in the [Output Format] screen.

Stamp Color

Set the default value for [Color] displayed when [Stamp] is selected for [Annotation] in the [Output Format] screen.

Date Position (Side 1) (Side 2)

Set the default value for [Position] displayed when [Date] is selected for [Annotation] in the [Output Format] screen.

- Note**
- Allows you to specify [Side 1] and [Side 2].
 - [Side 1] : Six positions are available.
 - [Side 2] : Select [Same as Side 1] or [Opposite to Side 1].

Date Size

Set the default value for [Size] displayed when [Date] is selected for [Annotation] in the [Output Format] screen.

Page Number Style

Set the default value for [Style] displayed when [Page Number] is selected for [Annotation] on the [Output Format] screen.

Page Number Position (Side 1) (Side 2)

Set the default value for [Position] displayed when [Page Number] is selected for [Annotation] in the [Output Format] screen.

- Note**
- Allows you to specify [Side 1] and [Side 2].
 - [Side 1] : Six positions are available.
 - [Side 2] : Select [Same as Side 1] or [Opposite to Side 1].

Page Number Size

Set the default value for [Size] displayed when [Page Number] is selected for [Annotation] in the [Output Format] screen.

Bates Stamping - Number of Digits

Set the default value for [Number of Digits] displayed when [Bates Stamping] is selected for [Page Number] under [Annotation] on the [Output Format] tab.

Bates Stamping - Position (Side 1) (Side 2)

Set the default value for [Position] displayed when [Bates Stamping] is selected for [Page Number] under [Annotation] on the [Output Format] tab.

- Note**
- Allows you to specify [Side 1] and [Side 2].
 - [Side 1] : Six positions are available.
 - [Side 2] : Select [Same as Side 1] or [Opposite to Side 1].

Bates Stamping - Size

Set the default value for [Size] displayed when [Bates Stamping] is selected for [Page Number] under [Annotation] on the [Output Format] tab.

Tab Margin Shift - Shift Value

Set the default value for [Shift Value] of [Tab Margin Shift] in the [Output Format] screen.

Booklet Creation - Covers Tray

Set the default value for [Covers Tray] in the [Booklet Creation] screen.

- Note**
- Specify the tray that allows you to load paper in SEF (landscape) orientation. When creating a booklet using Booklet Creation, only the tray that is loaded with paper in SEF (landscape) orientation can be used. If you specify a tray that is loaded with paper in LEF (portrait) orientation instead, you need to change the settings in [Covers Tray] before starting a job.
 - Allows you to set [Front Cover Tray] and [Back Cover Tray], individually.

Covers - Front Cover Tray / Covers - Back Cover Tray

Set the default value for [Covers Tray] in the [Covers] screen.

- Note**
- Allows you to set [Front Cover Tray] and [Back Cover Tray], individually.

Insert Separators - Separators Tray

Set the default value for [Separators] in the [Build Job - Separators Tray] screen.

Copy Control

These settings relate to copy operation control.

Memory Full Procedure

When the space of the hard disk runs out during scanning originals, a screen appears asking how the partly stored data should be handled.

Once a certain time has elapsed with the confirmation screen displayed, the subsequent processing is determined by these settings.

You can set the time until the memory full procedure is carried out. For more information, refer to "Auto Job Release" (P.122).

- **Cancel Job**
The stored data is discarded.
- **Run Job**
The read-in data is treated as valid, and the part of the original read in is copied.

Maximum Stored Pages

Set the maximum number of stored pages of a copy original. You can set a number from 1 to 999 pages.

Auto Paper Off

Select the tray used when [Auto Paper] of [Paper Supply] in the [Copy] screen is cancelled (the tray used when [Auto Paper] of [Paper Supply] is selected in the [Copy] screen, and [Auto %] or [Independent X-Y %] is selected for [Reduce/Enlarge]).

Mixed Sized Originals - 2 Sided Copy

Specify paper to copy side 2 of the original if different size of originals for side 1 and side 2 are selected by automatic paper supply when the size of the side 1 differs from that of the side 2 in 2-sided copy.

Important • When the side 1 and side 2 are different sizes and if the side 2 is copied on the sheet on which the side 1 has already been printed, an image may be missing.

- **Copy to new sheet**
Side 2 is copied on the front of a new sheet.
- **Copy to Side 2**
Side 2 is copied on the opposite side of Side 1 without changing the paper size.

Fine-tune 100%

You can fine-tune the magnification when copying at 100% (actual size). The set value is applied when [Reduce/Enlarge] or [Preset %] on the [Copy] screen is set to 100%. Set the value in the X/Y direction within the range 98 to 102% in 0.1% increments.

Important • This feature is applied only when a copy is made with the document glass. This setting is not reflected in the magnification (100%) under [Variable %], [Independent X-Y%] or [Calculator %].

Note • A magnification displays [100%] even if [Fine-tune 100%] is set.

Background Suppress (Photo & Text)

Set the background suppression level for color copying. This setting is valid when [Photo & Text] is selected for [Original Type] on the [Image Quality] screen. The larger the value, the stronger the effect of removing background noise.

Background Suppression Level (Text)

Set the background suppression level for color copying. This setting is valid when [Text] is selected for [Original Type] on the [Image Quality] screen. The larger the value, the stronger the effect of removing background noise.

Photo & Text/Printed Original

Set the type of original when [Halftone] of [Photo & Text] is selected for [Original Type] in the [Image Quality] screen.

- Normal
Copies with standard image quality.
- Inkjet Originals
Select when copying an original printed with an inkjet printer. This improves the recognition of inkjet colors.
- Highlighted Originals
Select when copying an original marked with a highlight pen. This improves the recognition of the highlight pen colors.

Original Type - Lightweight Originals

When [Text] is selected for [Original Type] in the [Image Quality] screen, set whether to display a special original ([Lightweight Originals]).

Output Orientation - Reverse Order

Specify whether to display [Face Up Reverse Order] under the [Output Orientation] in the [Output Format] screen.

Output Orientation - Auto (Single Sheet)

Set operations when the output is one sheet and selecting [Auto] under the [Output Orientation] in the [Output Format] screen.

Stamp Density

Set the translucency of the stamp printed as annotation. You can select from three translucency values: Darken, Normal, and Lighten. Darken represents no translucency.

Note • If the stamp with [0%] density is printed over text, the text may be unreadable.

Stamp Position - Top Left, - Top Center, - Top Right, - Left Center, - Center, - Right Center, - Bottom Left, - Bottom Center, and - Bottom Right

You can tune the position to print a stamp finely.

Date Position - Top Left, - Top Center, - Top Right, - Left Center, - Center, - Right Center, - Bottom Left, - Bottom Center, and - Bottom Right

You can tune the position to print a date finely.

Page Number Position - Top Left, - Top Center, - Top Right, - Left Center, - Center, - Right Center, - Bottom Left, - Bottom Center, and - Bottom Right

You can tune the position to print a page number finely.

Bates Stamping - Top Left, - Top Center, - Top Right, - Left Center, - Center, - Right Center, - Bottom Left, - Bottom Center, and - Bottom Right

You can tune the position to print a bates stamping finely.

Quantity Display

Set the method of displaying counter.

Select from [Quantity and Memory], [Quantity and Original Count] and [Quantity (Big Font)].

Maximum Number of Sets

Set the maximum number of allowed copy sets between 1 and 999. Users will not be able to specify the number of copy sets larger than the value set here.

Original Size Defaults

Set the original sizes that appear in [Original Size] in the [Layout Adjustment] screen.

Original sizes can be assigned to the buttons other than [Auto Size Detect].

When frequently making copies of non-standard size originals, by presetting the non-standard size, you can save time to enter the original size each time a copy is made.

■ A/B Series Size

You can select from sizes of A and B series.

■ Inch Size

You can select from sizes of inch series.

■ Others

You can select from other sizes.

■ Variable Size

You can enter any size. Set the width (X) from 15 to 432 mm, and the height (Y) from 15 to 297 mm in 1 mm increments.

Reduce/Enlarge Presets

Set the magnifications shown in [Preset %], in [Reduce/Enlarge] in the [Copy] screen.

You can assign any magnification to the R/E Preset buttons.

Custom Colors

Set the custom colors used for [Single Color] and [Dual Color] in [Output Color].

You can assign custom colors with yellow (0 to 100%), magenta (0 to 100%), and cyan (0 to 100%) to each of custom color buttons 1 to 6.

Note • Adjust so that the total of yellow, magenta, and cyan does not exceed 240%.

Annotation - Create Stamps

Register text to be printed with [Stamp] under [Annotation]. You can enter up to 64 characters.

For information about how to enter characters, "2 Product Overview" > "Entering Text" in the User Guide.

Network Settings

In [Network Settings], set the type of interface through which the machine is connected to the client in [Port Settings], and the parameters required for communications in [Protocol Settings].

When using ApeosPort series models, also configure proxy and remote authentication server setting.

For information on network settings, refer to "Printer Environment Settings" (P.219) or "E-mail Environment Settings" (P.237).

When using CentreWare Internet Services, more detailed settings are possible. For more details, refer to "Using CentreWare Internet Services" (P.211).

The following shows the reference section for each item.

Port Settings	155
Protocol Settings	158
Machine's E-mail Address/Host Name.....	160
Proxy Server Settings (ApeosPort series models).....	160
Outgoing / Incoming E-mail Settings.....	161
Remote Authentication Server/Directory Service (ApeosPort series models only)	163
PKI Settings (Public Key Infrastructure)	167
Other Settings.....	168

- 1 On the [System Settings] screen, select [System Settings].

For the method of displaying the [System Settings] screen, refer to "System Settings Procedure" (P.108).

- 2 Select [Network Settings].

- 3 Select the item to be set or changed.

Port Settings

Set the interface by which the machine is connected to a client. In [Port Settings], you can set the following items.

USB

■Port Status

Select [Enabled] to use a USB interface.

■Print Mode

Configure the print language on the machine to match the received data.

Select [Auto] to set the device so that it will automatically determine and use the most suitable language to print data received from the host device.

■PJL

Enable when receiving a job using PJL commands.

■Auto Eject Time

Configure the time that the data so far received by the machine will automatically be printed since data is no longer sent to the printer.

You can enter a time between 5 and 1275 seconds in 5 seconds increments.

■Adobe Communication Protocol

- Normal

Select this when the communication protocol is in the ASCII format.

- Binary
Select this when the communication protocol is in the binary format. Depending on the data, the print job may be completed faster than when Normal is selected.
- TBCP
Select this to switch between the specific control codes when the communication protocols involve both ASCII and binary formats.
- RAW
Select this when the communication protocol is in the RAW format.

LPD

- Port Status
Select [Enabled] to use LPD.
- LPD Port Number
Select [Standard (515)] or [Enter Number].
Enter a port number in the range from 1 to 65535 when selecting [Enter Number].
The default value is 515.
Important • Do not use the numbers assigned to the other ports.
- LPD Maximum Number of Sessions
Enter the maximum number of sessions. You can enter a number between 1 and 10 in 1 session increments.
The default value is 5.

NetWare

- Port Status
Select [Enabled] to use NetWare.

SMB

- Port Status
Select [Enabled] to use SMB.

IPP

- Port Status
Select [Enabled] to use IPP.
Note • You can not select [Add Port Number], if IPP port is disabled.
Enable IPP port first and reboot the machine by selecting [Exit], and then configure [Add Port Number].
- Add Port Number
Enter the port number for IPP except the standard port number in the range from 1 to 65535.
To disable this option, enter "0".
The default value is 80.
Important • Do not use the numbers assigned to the other ports.

EtherTalk

- Port Status
Select [Enabled] to use EtherTalk.

Bonjour

- Port Status
Select [Enabled] to use Bonjour.
Note • Bonjour can be set only when optional Adobe PostScript 3 Kit is installed.

- In order to print from a printer detected by [Bonjour], the LPD port must be activated in advance.

Salutation

- Port Status
Select [Enabled] to use salutation, when you obtain documents stored in a mailbox of the machine.

Port9100

- Port Status
Select [Enabled] to use Port9100.
 - Port Number
Select [Standard (9100)] or [Enter Number].
Enter a port number in the range from 1 to 65535 when selecting [Enter Number].
The default value is 9100.
- Important** • Do not use the numbers assigned to the other ports.

SNMP

- Port Status
Select [Enabled] to use SNMP, when you use any Fuji Xerox manufactured web applications to remote control the machine.

FTP Client

- Port Status
Select [Enabled] when you use Scan to PC feature using with FTP transmission.

Receive E-mail

- Port Status
Select [Enabled] when you use E-mail Printing.

Send E-mail

- Port Status
Select [Enabled] when you use E-mail feature.

Mail Notice Service

- Port Status
Select [Enabled] when you use the mail notice or job completion notice feature.

UPnP Discovery

- Port Status
Select [Enabled] to use UPnP.
 - Port Number
Select [Standard (80)] or [Enter Number].
Enter a port number in the range from 1 to 65535 when selecting [Enter Number].
The default value is 80.
- Important** • Do not use the numbers assigned to the other ports.

Internet Service (HTTP)

- Port Status
Select [Enabled] to use CentreWare Internet Services.

- Note** • You can not configure other Internet Service settings, if Internet Service port is disabled. Enable Internet Service port first and reboot the machine by selecting [Exit], and then configure other Internet Service settings.

■Port Number

Select [Standard (80)] or [Enter Number].

Enter a port number in the range from 1 to 65535 when selecting [Enter Number].

The default value is 80.

Important • Do not use the numbers assigned to the other ports.

SOAP

■Port Status

Select [Enabled] when you are using an application program, such as the EasyOperator.

■Port Number

Select [Standard (80)] or [Enter Number].

Enter a port number in the range from 1 to 65535 when selecting [Enter Number].

The default value is 80.

Important • Do not use the numbers assigned to the other ports.

WebDAV

■Port Status

Select [Enabled] when you are using an application program for accessing the Mailbox in the machine, such as the EasyOperator.

- Note** • You can not configure other WebDAV settings, if WebDAV port is disabled. Enable WebDAV port first and reboot the machine by selecting [Exit], and then configure other WebDAV settings.

■Port Number

Select [Standard (80)] or [Enter Number].

Enter a port number in the range from 1 to 65535 when selecting [Enter Number].

The default value is 80.

Important • Do not use the numbers assigned to the other ports.

■Connection Time-Out

Enter the time from the receiving of data, failed transmission of data until the connection is cut. You can enter a connection time-out period between 0 and 65535 seconds in 1 second increments.

Protocol Settings

Set the parameters required for communications. In [Protocol Settings], you can set the following items.

Ethernet Settings

Set the communication speed for the Ethernet interface.

■Auto

Select this to detect the Ethernet transmission rate automatically.

■10BASE-T (Half Duplex)

Select this to set 10BASE-T (Half Duplex) as the default value.

■10BASE-T (Full Duplex)

Select this to set 10BASE-T (Full Duplex) as the default value.

■100BASE-TX (Half Duplex)

Select this to set 100BASE-TX (Half Duplex) as the default value.

■100BASE-TX (Full Duplex)

Select this to set 100BASE-TX (Full Duplex) as the default value.

TCP/IP - Get IP Address

Allows you to set the method for obtaining the IP address.

■DHCP

The address will automatically be set via DHCP. Data entered for IP address, subnet mask and gateway address will become invalid.

- Note**
- When using a DHCP server, also configure the WINS (Windows Internet Name Service) server. To set a DHCP server, use CentreWare Internet Services. For details, refer to "Using CentreWare Internet Services" (P.211).

■BOOTP

The address will automatically be set via BOOTP. Data entered for IP address, subnet mask and gateway address will become invalid.

■RARP

The address will automatically be set via RARP. Data entered for IP address, subnet mask and gateway address will become invalid.

■DHCP / Autonet

The address will automatically be set via DHCP/Autonet. Data entered for IP address, subnet mask and gateway address will become invalid

■Manual

You will specify all the addresses.

TCP/IP - IP Address

Enter the IP address using the numeric keypad when selecting [Manual] at [TCP/IP - Get IP Address].

- Note**
- Enter the IP address in the format "xxx.xxx.xxx.xxx". The "xxx" must be a numeric value in the range from 0 to 255. However, 224-255.xxx.xxx.xxx, and 127.xxx.xxx.xxx cannot be used.
 - When you make an entry mistake, press the <C> (clear) button and enter again.
 - When you want to move to the next value without entering all 3 digits, select [save/select next].

TCP/IP - Subnet Mask

Enter the subnet mask using the numeric keypad when selecting [Manual] at [TCP/IP - Get IP Address].

- Note**
- Specify the subnet mask by a combination of the numbers 0, 128, 192, 224, 240, 248, 252, 254, and 255. However, you cannot use 0 between non-zero values.
 - When you make an entry mistake, press the <C> (clear) button and enter again.
 - When you want to move to the next value without entering all 3 digits, select [save/select next].

TCP/IP - Gateway Address

Enter the gateway address using the numeric keypad when selecting [Manual] at [TCP/IP - Get IP Address].

- Note**
- Enter gateway address in the format "xxx.xxx.xxx.xxx". The "xxx" must be a numeric value in the range from 0 to 255. However, 224-255.xxx.xxx.xxx, and 127.xxx.xxx.xxx cannot be used.
 - When you make an entry mistake, press the <C> (clear) button and enter again.
 - When you want to move to the next value without entering all 3 digits, select [save/select next].

TCP/IP - IP Filter

Select whether to limit the IP address used for receiving print data.

Important • Remote Access is not available when enabling [TCP/IP - IP Filter].

Note • To set the permitted IP address for receiving print data, use CentreWare Internet Services. For details, refer to "Using CentreWare Internet Services" (P.211).

Machine's E-mail Address/Host Name

Set the e-mail address and host name for the machine. In [Machine's E-mail Address/Host Name], you can set the following items.

E-mail Address

Enter the E-mail address for the machine with the numeric keypad displayed by pressing [Change Settings]. Up to 128 single-byte characters are allowed.

■ When receiving E-mail via SMTP

You can set any name for the account (on the left side of @). Set the address section (on the right side of @), with the combination of the host name and domain name. An alias cannot be set.

Example: mymail@myhost.example.com

- Account name: mymail
- Host name: myhost
- Domain Name: example.com

■ When receiving E-mails via POP3

Enter the POP user name (on the left side of @) and incoming POP3 mail server name in the address section (on the right side of @). You can set an alias, such as mymail@example.com.

Example: mymail@mb1.abc.example.com

- Account name: mymail
- Host Name
- Domain Name

Name

Enter the machine name with the numeric keypad displayed by pressing [Change Settings]. Up to 32 single-byte characters are allowed.

Host Name

Enter the host name with the numeric keypad displayed by pressing [Change Settings]. Up to 32 single-byte characters are allowed.

Domain Name

Enter the domain name with the numeric keypad displayed by pressing [Change Settings]. Up to 64 single-byte characters are allowed.

Proxy Server Settings (ApeosPort series models)

Configure the settings for a proxy server.

Important • Do not set this item unless you use services requiring proxy settings.

Use Proxy Server

Select whether to use a proxy server.

Proxy Server Setup

Select the proxy server specification from [Same Settings for All Protocols] and [Set for Each Protocols].

Addresses to Bypass Proxy Server

Enter addresses not using the proxy server. You can use wildcards "*" for specifying the addresses.

HTTP Proxy Server Name

Enter the HTTP server name. Up to 255 characters are allowed.

HTTP Proxy Server Port Number

Set the HTTP server port number in the range from 1 to 65535.
The default value is 8080.

Important • Do not use the numbers assigned to the other ports.

HTTP Proxy Server Authentication

Select whether to enable the authentication feature of the HTTP server.

HTTP Proxy Server Login Name

Enter a login name of the HTTP server. Up to 31 characters are allowed.

HTTP Proxy Server Password

Enter a password of the HTTP server. Up to 31 characters are allowed.

HTTPS Proxy Server Name

Enter the HTTPS server name. Up to 255 characters are allowed.

HTTPS Proxy Server Port Number

Set the HTTPS server port number in the range from 1 to 65535.
The default value is 8080.

Important • Do not use the numbers assigned to the other ports.

HTTPS Proxy Server Authentication

Select whether to enable the authentication feature of the HTTPS server.

HTTPS Proxy Server Login Name

Enter a login name of the HTTPS server. Up to 31 characters are allowed.

HTTPS Proxy Server Password

Enter a password of the HTTPS server. Up to 31 characters are allowed.

Outgoing / Incoming E-mail Settings

Set e-mail transmission and reception.

POP3 Server Settings

Set the POP3 server. In [POP3 Server Settings], you can set the following items.

■POP3 Server Setup

Select from [By IP Address] or [By Server Name].

■POP3 Server IP Address

Enter an IP address if [By IP Address] has been selected for [POP3 Server Setup].

- Note**
- Enter the address in the format "xxx.xxx.xxx.xxx". The "xxx" must be a numeric value in the range from 0 to 255. However, 224-255.xxx.xxx.xxx, and 127.xxx.xxx.xxx cannot be used.
 - When you make an entry mistake, press the <C> (Clear) button and enter again.
 - When moving to the next value without entering all 3 digits, select [Next].

■POP3 Server Name

Enter a server name if [By Server Name] has been selected for [POP3 Server Setup]. Using the numeric keypad displayed by pressing [Change Settings], up to 64 single-byte characters are allowed.

■POP3 Server Port Number

Select [Standard (110)] or [Enter Number].

Enter a port number in the range from 1 to 65535 when selecting [Enter Number]. The default value is 110.

Important • Do not use the numbers assigned to the other ports.

■POP3 Server Check Interval

Set the interval for checking the e-mail on the POP3 server in the range from 1 to 120 minutes, in 1 minute increments.

■POP3 Server Login Name

Enter the name to login to the POP3 server. Up to 64 single-byte characters are allowed.

■POP3 Server Password

Enter a password of the POP3 server. Up to 64 single-byte characters are allowed. Using the numeric keypad displayed by pressing [Change Settings], enter the same password in [New Password/Passcode] and [Re-enter Password/Passcode]. If you do not set the password, leave it blank and select [Save].

■POP Receiving Password Encryption

Select [On (APOP)] to encrypt the password.

SMTP Server Settings

Set the SMTP server. In [SMTP Server Settings], you can set the following items.

■SMTP Server Setup

Select from [By IP Address] or [By Server Name].

■SMTP Server IP Address

Enter an IP address if [By IP Address] has been selected for [SMTP Server Setup].

- Note**
- Enter the address in the format "xxx.xxx.xxx.xxx". The "xxx" must be a numeric value in the range from 0 to 255. However, 224-255.xxx.xxx.xxx, and 127.xxx.xxx.xxx cannot be used.
 - When you make an entry mistake, press the <C> (Clear) button and enter again.
 - When moving to the next value without entering all 3 digits, select [Next].

■SMTP Server Name

Enter a server name if [By Server Name] is selected for [SMTP Server Setup].

■SMTP Server Port Number

Select [Standard (25)] or [Enter Number].

Enter a port number in the range from 1 to 65535 when selecting [Enter Number]. The default value is 25.

Important • Do not use the numbers assigned to the other ports.

■E-mail Send Authentication

Select one from [Off], [POP before SMTP], or [SMTP AUTH].

Note • If [POP before SMTP] is selected, the POP3 settings must be set.

■SMTP AUTH Login Name

Enter the user name for verification purpose at the SMTP server. Up to 64 single-byte characters are allowed.

An alias cannot be set. You can set any name for the account (on the left side of @). Set the address section (on the right side of @), with the combination of the host name and domain name.

Example:mymail@host.example.com

- Account name: mymail
- Host name: host
- Domain name: example.com

Note • AUTH PLAIN, AUTH-LOGIN, or AUTH CRAM-MD5 can be used as an authentication method.

■[SMTP AUTH Password

Enter the password for verification purpose at the SMTP server. Up to 64 single-byte characters are allowed.

Using the numeric keypad displayed by pressing [Change Settings], enter the same password in [New Password/Passcode] and [Re-enter Password/Passcode]. If you do not set the password, leave it blank and select [Save].

Domain Filter

Set accepted domains. In [Domain Filter], you can set the following items.

■Domain filtering

Select one from [Off], [Enter Permitted Domain Names], or [Enter Rejected Domain Names].

■Domain 1 - Domain 50

Specify up to 50 domains if either [Enter Permitted Domain Name] or [Enter Rejected Domain Name] has been selected for [Domain Filter].

Using the numeric keypad displayed by pressing [Change Settings], up to 64 single-byte characters are allowed.

Remote Authentication Server/Directory Service (ApeosPort series models only)

You can make the settings for the remote authentication server and Directory Service.

Authentication System

Allows you to select the system for authentication from [Kerberos (Windows2000)], [Kerberos (Solaris)], [LDAP] and [SMB].

Important • After the authentication system has been changed, personal mailboxes and personal job flow sheets operated on the previous authentication system are not deleted automatically. If these mailboxes or job flow sheets are no longer needed, delete them from the machine. If the same user IDs are also used on the new authentication system, the personal mailboxes and personal job flow sheets can be used by the same users.

Kerberos Server Settings

Configure the Kerberos server settings.

■Primary Server Setup

Select the primary server specification method from [By IP Address] and [By Server Name].

■ **Primary Server IP Address**

Enter the primary server IP address using values from 0 to 255.
You can set this item when [Primary Server Setup] is [By IP Address].

Note • 224.XXX.XXX.XXX, 255.XXX.XXX.XXX, and 127.XXX.XXX.XXX cannot be set.

■ **Primary Server Name**

Enter the name of the primary server. Up to 255 characters are allowed.
You can set this item when [Primary Server Setup] is [By Server Name].

■ **Primary Server Port Number**

Set the Primary server port number in the range from 1 to 65535.
The default value is 88.

Important • Do not use the numbers assigned to the other ports.

■ **Secondary Server Setup**

Select the secondary server specification method from [By IP Address] and [By Server Name].

■ **Secondary Server IP Address**

Enter the secondary server IP address using values from 0 to 255.
You can set this item when [Secondary Server Setup] is [By IP Address].

Note • 224.XXX.XXX.XXX, 255.XXX.XXX.XXX, and 127.XXX.XXX.XXX cannot be set.

■ **Secondary Server Name**

Enter the name of the secondary server. Up to 255 characters are allowed.

Note • You can set this item when [Secondary Server Setup] is [By Server Name].

■ **Secondary Server Port Number**

Set the secondary server port number in the range from 1 to 65535.
The default value is 88.

Important • Do not use the numbers assigned to the other ports.

■ **Realm Name**

When using Active Directory of Windows 2000 Server or Windows Server 2003, set the domain name of Active Directory in [Realm Name]. Up to 64 characters are allowed.

Important • Enter a realm name with capital letters. Otherwise, an authentication error occurs.

LDAP Server/Directory Service

Configure the directory server, authentication method, and search attributes and ranges for LDAP authentication and address book search by LDAP.

■ **Primary Server Setup**

Select the primary server specification method from [By IP Address] and [By Server Name].

■ **Primary Server IP Address**

Enter the primary server IP address using values from 0 to 255.
You can set this item when [Primary Server Setup] is [By IP Address].

Note • 224.XXX.XXX.XXX, 255.XXX.XXX.XXX, and 127.XXX.XXX.XXX cannot be set.

■ **Primary Server Name**

Enter the name of the primary server. Up to 64 characters are allowed.
You can set this item when [Primary Server Setup] is [By Server Name].

■ **Primary Server Port Number**

Set the Primary server port number in the range from 1 to 65535.
The default value is 389.

Important • Do not use the numbers assigned to the other ports.

■ **Secondary Server Setup**

Select the secondary server specification method from [By IP Address] and [By Server Name].

■Secondary Server IP Address

Enter the secondary server IP address using values from 0 to 255.
You can set this item when [Secondary Server Setup] is [By IP Address].

Note • 224.XXX.XXX.XXX, 255.XXX.XXX.XXX, and 127.XXX.XXX.XXX cannot be set.

■Secondary Server Name

Enter the name of the secondary server. Up to 64 characters are allowed.
You can set this item when [Secondary Server Setup] is [By Server Name].

■Secondary Server Port Number

Set the secondary server port number in the range from 1 to 65535.
The default value is 389.

Important • Do not use the numbers assigned to the other ports.

■Authentication Method

Select the method for LDAP authentication from [Direct Authentication] and [Authentication of User Attributes].

- Direct Authentication

User ID and password entered by user are used for LDAP authentication.

- Authentication of User Attributes

The entered User ID is used as an attribute value specified in [Attribute of Types User Name] for a search on a LDAP server. [Attribute of Login User Name] of a user that is found through the search is used for LDAP authentication.

■Attribute of Typed User Name

When [Authentication of User Attributes] is used for LDAP authentication, set an attribute of a user name input. Up to 32 characters are allowed.

■Attribute of Login User Name

When [Authentication of User Attributes] is used for LDAP authentication, set an attribute of user ID entered by user. Up to 32 characters are allowed.

■Use Added Text String

Select whether to use additional text strings for the user ID.

■Text String Added to User Name

Enter text strings for [Text String Added to User Name]. You can use up to 64 characters.

■Search Login Name

Set a login name for address book search and access to the directory server by [Authentication of User Attributes] of LDAP authentication. However, set this item only when authentication is required for the directory service. Do not make the setting when authentication is not required.

When setting the login name, you can enter up to 255 characters.

■Search Password

Set a password for address book search and access to the directory server by [User Attribute Authentication] of LDAP authentication. However, set this item only when authentication is required for the directory service. Do not make the setting when authentication is not required.

When setting the password, you can enter up to 32 characters.

■Search Root Entry DN

Enter the search root character string with up to 255 characters.

■Scope of Search from Root Entry

Select the search range from the search root.

- Root entry only

- Searches the root level only.

- One level below root entry only

- Searches from the root, as far as one level below.

- All levels below root entry
 - Searches from the root, including all levels below.
- **Object Class of Search Target**
Enter the search target object class with up to 32 characters.
- **Referral**
Specify whether or not to re-establish connection to another LDAP server if a currently connected LDAP server requests to do so.
- **Referral Hop Limit**
When using the referral feature, specify how many times that a user can be referred to servers within the range of 1 to 5 times.
- **Server Application**
Select the software used by the directory server, from [Microsoft Active Directory], [Novell NetWare], [IBM Lotus Domino 6.*], and [Other Applications].
- **Search Entries by Recipient Name**
Set whether to use [Attribute Type of Recipient Name] when names are used as search keys.
- **Search Entries by Last Name**
Set whether to use [Attribute Type of Last Name] when names are used as search keys.
- **Search Entries by First Name**
Set whether to use [Attribute Type of First Name] when names are used as search keys.
- **Attribute Type of Recipient Name**
Set the recipient name attribute type. Up to 32 characters are allowed.
- **Attribute Type of Last Name**
Set the sender's family name attribute type. Up to 32 characters are allowed.
- **Attribute Type of First Name**
Set the sender's first name attribute type. Up to 32 characters are allowed.
- **Attribute Type of E-mail Address**
Set the e-mail address attribute type. Up to 32 characters are allowed.
- **Attribute Type of Custom Item 1, 2, and 3**
Set the LDAP attribute type of custom items 1 to 3. Up to 32 characters are allowed.
- **Attribute Name of Custom Item 1, 2, and 3**
Set the attribute names assigned to custom items 1 to 3. You can enter up to 16 characters.
- **Attribute Type of Certificate**
Set the certificate attribute type. Up to 32 characters are allowed.
- **Maximum Search Results**
Set the upper limit on the number of searched address results from 5 to 100. If there are more search results than the upper limit, the search operation is stopped at that number.
- **Search Time-Out**
Select whether or not to set a search time-out. Set the value from 5 to 120 seconds in 1 second increments.
- **Directory Service for Address Book**
Select whether to use an address book stored on the directory server.
Even when [On] is selected, unless the following conditions are satisfied, the address book of the directory server will not be started.
 - The IP address of the directory server (primary) of the machine must be set
 - The IP address or Internet address of the directory server (primary) must be set
 - The port numbers used for LDAP communication must be set on the directory server and the machine

SMB Server Settings

■SMB Server Setup

Select the server specification method from [By Domain name], [By Domain Name & IP Address], and [By Domain Name & Server Name].

According to the option you selected here, set [Server Domain Name], [Server IP Address], and [Server Name] for each of SMB servers 1 to 5.

■Server Domain Name

Enter the domain name of the server. Up to 15 characters are allowed.

You can set this item when [SMB Server Setup] is [By Domain Name].

Important • Use the NetBIOS domain name for the domain name.

■Server IP Address

Enter the server IP address using values from 0 to 255. You can set this item when [SMB Server Setup] is set to [By Domain Name & IP Address].

Note • 224.XXX.XXX.XXX through 255.XXX.XXX.XXX, and 127.XXX.XXX.XXX cannot be set.

■Server Name

Enter the name of the server. Up to 64 characters are allowed. You can set this item when [SMB Server Setup] is set to [By Domain Name & Server Name].

Important • Use the NetBIOS computer name or full computer name with DNS suffix for the server name.

PKI Settings (Public Key Infrastructure)

Set the SSL/TLS.

For ApesPort series models, also set S/MIME and PDF/DocuWorks signature settings.

Before setting the HTTP-SSL/TLS communications, the device certificate must be set.

For information on the device certificate, refer to "Security" (P.261).

SSL/TLS Settings

Set the SSL/TLS.

■Device Certificate - Server

You can select a certificate to be linked.

■HTTP - SSL/TLS Communication

Enables or disables the HTTP SSL/TLS communications.

■HTTP - SSL/TLS Port Number

Specifies the port number used for HTTP SSL/TLS communication within the range from 1 to 65535.

The default value is 443.

Important • Do not use the numbers assigned to the other ports.

■LDAP - SSL/TLS Communication

Enables or disables the LDAP SSL/TLS communications for LDAP authentication and address book search by LDAP.

The port number of [Primary server port number] and [Secondary Server Port Number] for LDAP server must be changed, if [LDAP - SSL/TLS Communication] is enabled.

The port number for SSL/TLS communications with LDAP directory server is normally 389.

■Device Certificate - Client

Select a certificate to be linked.

■Remote Server Certificate Validation

Select whether to enable or disable a certificate of a remote server.

S/MIME Settings (ApeosPort series models)

Configure the settings of S/MIME.

- **Device Certificate - S/MIME**
Select a certificate to be linked.
- **S/MIME Communication**
Select whether to enable or disable the S/MIME communication.
- **Receive Untrusted E-mail**
If you select [Off], the machine does not receive the following e-mail:
 - E-mail other than e-mail sent by S/MIME when [S/MIME Communication] is activated.
 - E-mail that fails to attach a signature or verification.
 - E-mail that is attached with an expired certificate.
- **Message Digest Algorithm**
Select a message digest algorithm. Two algorithms are available: SHA1 and MD5.
- **Contents Encryption Method**
Set the encryption method for mail contents. Four methods are available: 3DES, RC2-40, RC2-64, and RC2-128.
- **Digital Signature - Outgoing E-mail**
Select whether or not to always add a digital signature to e-mail. You can also select the setting in which the machine asks to add a digital signature to the e-mail whenever you send.
- **Certificate Auto Store**
Select whether or not to automatically store a S/MIME certificate attached with the e-mail when receiving e-mail sent from an address registered in the address book.

PDF/DocuWorks Signature Settings (ApeosPort series models)

Allows you to make the settings for security and signature of PDF/DocuWorks documents.

- **Device Certificate**
Select a certificate to be linked.
For information on the certificate, refer to "Security" (P.261).
- **PDF Signature**
Select the setting for PDF Signature from [Do not add signature], [Always add visible signature], [Always add invisible signature], and [Select during send].
- **DocuWorks Signature**
Select the setting for DocuWorks Signature from [Do not add signature], [Always add signature], and [Select during send].

Other Settings

In [Other Settings], you can set the following items.

- **E-mail Receive Protocol**
Select from [SMTP] and [POP3] depending on the usage environment.
- **Output Destination for E-mail**
Specify an output destination for e-mail printing. Selecting [Auto] sets to the default output destination.

Print Mode Settings

In [Print Mode Settings], you make settings relating to the printer feature.

When using CentreWare Internet Services, more detailed settings are possible. For more details, refer to "Using CentreWare Internet Services" (P.211).

The following shows the reference section for each item.

Allocate Memory.....	169
Delete Form.....	171
Other Settings.....	171

1 On the [System Settings] screen, select [System Settings].

For the method of displaying the [System Settings] screen, refer to "System Settings Procedure" (P.108).

2 Select [Print Mode Settings].

3 Select the item to be set or changed.

Allocate Memory

For each interface, set the memory capacity for the receiving buffer (temporary storage for data sent from the client).

You can change the receiving buffer capacity depending on the pattern of use and purpose. Increasing the receiving buffer capacity may allow a client to be released sooner from an interface.

Important • If you change the memory capacity settings, the memory is reset, and therefore data stored in all memory areas is lost.

- It is not possible to assign more than the total memory. When the power is turned on, if the settings exceed the available memory capacity, they are automatically adjusted by the system.

Note • When a port is set to [Disabled], the corresponding items do not appear.

- Depending on the amount of data sent from the client, increasing the memory capacity may not change the time taken to release the client.

PostScript Memory

Specify a value for the PostScript memory capacity from 16.00 to 96.00 MB in 0.25 MB increments.

- Note**
- This feature does not appear for some models. An optional package is necessary. For more information, contact our Customer Support Center.
 - The maximum value that can be set varies according to the available memory capacity.

ESC/P Form Memory

Displays destination to save forms used in ESC/P-K.

If a hard disk is not installed, data can be stored in the ESC/P-K form memory. You can specify the value within the range from 128 to 2048 KB in 32 KB increments.

- Note**
- This feature does not appear for some models. An optional package is necessary. For more information, contact our Customer Support Center.
 - The maximum value that can be set varies according to the available memory capacity.

Receiving Buffer - USB

Set the receiving buffer for USB.

You can specify the value within the range from 64 to 1024 KB in 32 KB increments.

- Note** • This feature does not appear for some models. An optional package is necessary. For more information, contact our Customer Support Center.

Receiving Buffer - LPD Spool

■ Off

Does not use spooling. While LPD print processing is being carried out for one client, data cannot be received over the same interface from another client.

Specify a value for the dedicated LPD receiving buffer memory capacity from 1,024 to 2,048 KB, in 32 KB increments.

■ Memory

Carries out spooling. The receiving buffer for spooling uses memory. When this setting is selected, specify the memory capacity of a receiving buffer for spooling from 0.50 MB to 32.00 MB, in 0.25 MB increments.

Note that print data exceeding the set memory capacity is not accepted. In such cases, select [Hard Disk] or [Off].

■ Hard Disk

Carries out spooling. The receiving buffer for spooling uses the hard disk.

Receiving Buffer - NetWare

Set the NetWare receiving buffer.

Specify a value from 64 to 1,024 KB in 32 KB increments.

- Note** • This feature does not appear for some models. An optional package is necessary. For more information, contact our Customer Support Center.

Receiving Buffer - SMB Spool

■ Off

Does not use spooling. While SMB print processing is being carried out for one client, data cannot be received over the same interface from another client.

Specify a value for the dedicated SMB receiving buffer memory capacity from 64 to 1,024 KB in 32 KB increments.

Important • If you select [Off], job names are displayed as "unknown document name".

■ Memory

Carries out spooling. The receiving buffer for spooling uses memory. When this setting is selected, specify the memory capacity of a receiving buffer for spooling from 0.50 to 32.00 MB, in 0.25 MB increments.

Note that print data exceeding the set memory capacity is not accepted. In such cases, select [Hard Disk] or [Off].

■ Hard Disk

Carries out spooling. The receiving buffer for spooling uses the hard disk.

Receiving Buffer - IPP Spool

■ Off

Does not use spooling. While IPP print processing is being carried out for one client, data cannot be received over the same interface from another client.

Set a value for the dedicated IPP receiving buffer memory capacity from 64 to 1,024 KB in 32 KB increments.

■ Hard Disk

Carries out spooling. The receiving buffer for spooling uses the hard disk.

Receiving Buffer - EtherTalk

Set the EtherTalk receiving buffer.

Specify a value within the range from 1,024 to 2,048 KB, in 32 KB increments.

- Note** • This feature does not appear for some models. An optional package is necessary. For more information, contact our Customer Support Center.

Receiving Buffer - Port 9100

Set the Port 9100 receiving buffer.
Specify a value within the range from 64 to 1,024 KB in 32 KB increments.

Delete Form

You can delete registered ESC/P-K forms.

Important • Although this screen can be displayed, the ESC/P-K form is not available on the machine.

- 1 Select [Delete Form].
- 2 Select the print mode to delete forms.
- 3 Enter the form number with the numeric keypad, and select [Confirm].
- 4 Check the form name, and select [Delete Data].

■ESC/P

Delete ESC/P-K emulation forms.

■Form Number

When you select an item to be deleted, you can enter the form number. Specify a form number from 1 to 64.

■Form Name

After you enter the form number and select [Confirm], the form name matching the entered number appears.

Other Settings

You can make other settings relating to the paper used in the printer.

Print Area

Set whether to expand the print area.

For information about the printable area, refer to "Printable Area" (P.420).

Substitute Tray

When there is no tray containing the paper size selected by the automatic tray selection, select whether or not to print replaced with paper loaded in another paper tray. In the event of using substitute tray, set the size.

- Note** • When documents are printed using emulation such as ESC/P-K and HP-GL/2, this setting is not valid and a message prompting you to load paper appears on the screen.

■Display Message

Does not use a substitute tray, but displays a paper loading message.

■Use Larger Size

Replaces with the next larger paper size than that selected, and prints at the same size.

■Use Closest Size

Replaces with the closest paper size to that selected, and prints. If necessary, the printing is automatically reduced in size.

- Note** • If there is a client specification, the client specification takes precedence.

- **Select Tray 5 (Bypass)**
Replaces with the paper in the Tray 5 (Bypass).

Paper Type Mismatch

Set the action to be taken when the paper type loaded in the paper tray does not match the paper type specified.

- **Print**
Prints with the paper loaded in the tray.
- **Display Confirmation Screen**
A confirmation screen appears to show procedures.
If a paper type mismatch occurs during print job processing, the machine ignores the paper type specified on the print driver and selects another type of paper loaded on the machine.
- **Display Paper Supply Screen**
The [Paper Supply] screen appears, prompting you to load another type of paper in the selected tray. The print job can be processed if you follow the instructions displayed on the screen.
 - Note**
 - If you load another type of paper in the tray by following the screen instructions, the paper type setting for the tray will also be changed to the setting displayed on the screen automatically.

Unregistered Forms

Set whether to print a job or not if a form specified for printing in a form data file (overlay printing) is not registered on the machine. If you specify [Print], since the specified form is not present, only the data is printed.

This setting is added to the print settings menu when there is a print specification from the host computer.

Print User ID

When printing using a print driver, specify whether to print user identification information on paper. The first 64 letters of the user information is printed.

Select a position to print from [Top Left], [Top Right], [Bottom Left], and [Bottom Right].

- Note**
 - To use the Print User ID feature, the user ID must be set on the print driver beforehand. For more information, refer to the print driver's online help.
 - When user authentication information is not available, "Unknown User" is printed.

Banner Sheet

Select whether to output banner sheets to separate different outputs.

A user name and document name are printed on a banner sheet.

- Note**
 - Even if the stapler feature is enabled, banner sheets are not stapled.
 - On a print job from a Macintosh, the document name does not appear on the banner sheet.
 - When printed, banner sheets are counted by meter.
- **Off**
Does not print banner sheets.
- **Start Sheet**
Prints a banner sheet before a print job.
- **End Sheet**
Prints a banner sheet after a print job.
- **Start Sheet & End Sheet**
Prints a banner sheet before and after a print job.

Banner Sheet Tray

Set the paper tray used for banner sheets.
Select from [Tray 1] to [Tray 4].

PostScript Default Color

Set the default values for AdobePS and PDF color mode.

Note • This feature does not appear for some models. An optional package is necessary. For more information, contact our Customer Support Center.

PostScript Paper Supply

Select whether the PostScript DMS (Deferred Media Selection) feature is enabled or disabled.

Note • This feature does not appear for some models. An optional package is necessary. For more information, contact our Customer Support Center.

PostScript Font Absence

Set the action to be taken when a PostScript font specified in a job is not present.

Note • This feature does not appear for some models. An optional package is necessary. For more information, contact our Customer Support Center.

■Cancel Printing
Cancels printing.

■Substitute Font and Print
Continues printing, using a substitute font. Courier is used as the substitute font.

PostScript Font Substitution

Set whether to use ATCx as a substitute if a PostScript font specified in a job is not present.

Note • This feature does not appear for some models. An optional package is necessary. For more information, contact our Customer Support Center.

Scan/Fax Mode Settings

Make settings relating to the scanner feature.

Note • This feature does not appear for some models. An optional package is necessary. For more information, contact our Customer Support Center.

When using CentreWare Internet Services, more detailed settings are possible. For more details, refer to "Using CentreWare Internet Services" (P.211).

The following shows the reference section for each item.

General Settings Tab.....	174
Scan Defaults	174
Scan to PC Defaults	176
Original Size Defaults	176
Output Size Defaults	176
Reduce/Enlarge Presets.....	177
Other Settings.....	177

- 1** On the [System Settings] screen, select [System Settings].
For the method of displaying the [System Settings] screen, refer to "System Settings Procedure" (P.108).
- 2** Select [Scan/Fax Mode Settings].
- 3** Select the item to be set or changed.

General Settings Tab

You can set items relating to the [General Settings] screen display.

Feature in 2nd Column

You can set the features shown in the second column of the [General Settings] screen. You can select from [2 Sided Originals], [Scan Resolution], [Lighten/Darken], and [Reduce/Enlarge].

Reduce/Enlarge - Buttons 2 to 3

This item can be set when [Reduce/Enlarge] is selected in [Feature in 2nd Column]. Select the magnification from the registered R/E Preset buttons.
For information about R/E Preset buttons, refer to "Reduce/Enlarge Presets" (P.177).

Scan Defaults

Set the default values for the scanner feature. When the power is turned on or the machine returns from a Power Save mode, or when the <Clear All> button is pressed, the system returns to the defaults set here. By setting features you often use as defaults, you can avoid extra operations required in use.
The values set become valid after the power has been turned off and on again.

Scanning Color

Set the default value for [Scanning Color] in the [General Settings] screen.

Original Type

Set the default value for [Original Type] in the [General Settings] screen.

File Format

Set the default value for [File Format] in the [General Settings] screen.

Thumbnail - Outgoing E-mail

Set the default value for [Thumbnail] of [DocuWorks High Compression] in [Output Format] displayed in the [General Settings] screen when using the [E-mail] feature.

Note • This feature does not appear for some models. An optional package is necessary. For more information, contact our Customer Support Center.

Thumbnail - Scan to PC

Set the default value for [Thumbnail] of [DocuWorks High Compression] in [Output Format] displayed in the [General Settings] screen when using the [Scan to PC] feature.

Note • This feature does not appear for some models. An optional package is necessary. For more information, contact our Customer Support Center.

Lighten/Darken

Set the default value for [Lighten/Darken] of [Image Options] in the [Image Quality] screen.

Contrast

Set the default value for [Contrast] of [Lighten/Darken/Contrast] in the [Image Quality] screen. The contrast setting is valid when [Scanning Color] is set to [Color] or [Grayscale].

Sharpness

Set the default value for [Sharpness] of [Image Options] in the [Image Quality] screen.

Background Suppression

Set the default value for [Background Suppression] in the [Image Quality] screen.

Shadow Suppression

Set the default value for [Shadow Suppression] in the [Image Quality] screen.

Color Space

Set the default value for [Color Space] in the [Image Quality] screen.

Important • When [Device Color Space] is selected as default and "Color Space" (P.178) is set to [Off], [Auto] of [Scanning Color] in the [General Settings] screen does not appear. In addition, when a High-compression Image kit (optional) is installed to the machine, [PDF High Compression] and [DocuWorks High Compression] of [Output Format] also do not appear.

Original Orientation

Set the default value for [Original Orientation] when scanning.

Scan Resolution

Set the default value for [Scan Resolution] in the [Layout Adjustment] screen. You can select from 200 dpi, 300 dpi, 400 dpi, and 600 dpi.

Mixed Sized Originals

Set the default value for [Mixed Sized Originals] in the [Layout Adjustment] screen.

Edge Erase

Set the default value for [Edge Erase] in the [Layout Adjustment] screen. You can select from [Normal] or [Edge Erase].

Edge Erase - Top & Bottom Edges

Set the default value for the amount of edges erased from the original in the top and bottom directions in [Edge Erase] in the [Layout Adjustment] screen. Specify a value from 0 to 50 mm in 1 mm increments.

Edge Erase - Left & Right Edges

Set the default value for the amount of edges erased from the original in the left and right directions in [Edge Erase] in the [Layout Adjustment] screen. Specify a value from 0 to 50 mm in 1mm increments.

Center Erase/Binding Erase

Set the default value for the binding erase amount of the original in [Edge Erase] in the [Layout Adjustment] screen. Specify a value from 0 to 50 mm in 1 mm increments.

Image Compression

Set the default value for [Image Compression] in the [Output Format] screen.

E-mail Subject

Set the default value for the e-mail subject. Up to 128 characters can be entered for the subject.

Scan to PC Defaults

You can select the default protocol (transfer protocol) used for transfer from FTP, SMB, and SMB (UNC Format).

Original Size Defaults

Set the original size shown in [Original Size] in the [Layout Adjustment] screen. An original size is assigned to each of the 11 buttons other than [Auto Size Detect].

When frequently scanning non-standard size originals, by presetting the non-standard size, you can save time to enter the original size each time a document is scanned.

- A/B Series Size
Select from the A and B series, such as A4 and B5.
- Inch Size
Select from the Inch series, such as 8.5 x 11" and 11 x 17".
- Others
Select from the sizes other than the above series, such as photo and postcard sizes.
- Variable Size
You can enter any size. Set the width (X) from 15 to 432 mm, and the height (Y) from 15 to 297 mm in 1 mm increments.

Output Size Defaults

Set the sizes to be displayed at [Output Size] when selecting [Auto %] for scanning documents at [Reduce/Enlarge] in the [Layout Adjustment] screen.

Any output sizes can be assigned to output size buttons 1 to 8.

By setting the commonly used sizes, you can reduce the number of selection operations for scanning.

- **A/B Series Size**
Select from 10 sizes of A and B series.
- **Inch Size**
Select from 12 sizes of inch series.
- **Others**
Select from other 13 sizes.

Reduce/Enlarge Presets

Set the magnifications shown in [Preset %] for [Reduce/Enlarge] in the [Layout Adjustment] screen.

- **Preset %**
Select from 20 standard magnification ratios.
- **Variable %**
You can specify a magnification within the range from 25 to 400% in 1% increments.

Other Settings

You can make other settings relating to the scanner feature specification.

Scan Service

Set whether or not to use the scanner feature.

Memory Full Procedure

While scanning an original, if there is insufficient hard disk space for the scanner, a screen appears, asking how the partly stored data should be handled. Once a certain time has elapsed with the confirmation screen displayed, the subsequent processing is determined by these settings.

You can set the time until the memory full procedure is carried out. For more information, refer to "Auto Job Release" (P.122).

- **Cancel Job**
The stored data is discarded.
- **Run Job**
The read-in data is treated as valid, and the part of the original read in is treated as a complete stored file.

Maximum Stored Pages

Set the maximum number of stored pages of a scan original. You can specify a number from 1 to 999 pages.

Saturation

Set the saturation when scanning a full color original. When carrying out a scan, it is automatically adjusted according to this setting value.

Background Suppression Level

For a color scan, set the background suppression level. This is valid when [Background Suppression] is set to [Auto Suppression]. The larger the value, the stronger the effect of removing background noise.

Shadow Suppression Level

Set the show-through prevention level. This is valid when [Shadow Suppression] is set to [On].

Color Space

Set whether to display the color space feature.

When set to [Enabled], [Color Space] buttons appear in the [Image Quality] screen for [E-mail], [Scan to Mailbox], [Scan to PC], and [Job Template].

Important • When [No] is selected as default and "Color Space" (P.175) is set to [Device Color Space], [Auto] of [Scanning Color] in the [General Settings] screen does not appear. In addition, when a High-compression Image kit (optional) is installed to the machine, [PDF High Compression] and [DocuWorks High Compression] of [Output Format] also do not appear.

TIFF Format

Set the TIFF format for scanned data. You can select [TIFF V6] or [TTN2].

Image Transfer Screen

Select whether to display a message when the scan of an original is completed.

- Disabled
Does not show a scan completion message.
- Display Message Only
Shows a scan completion message.
- Display Message and Screen
Shows a screen while original is being scanned, and also a scan completion message.

E-mail Settings

In [E-mail Settings], you can make settings relating to the e-mail features.

Note • This feature does not appear for some models. An optional package is necessary. For information, contact our Customer Support Center.

The following shows the reference section for each item.

E-mail Control..... 179

1 On the [System Settings] screen, select [System Settings].

For the method of displaying the [System Settings] screen, refer to "System Settings Procedure" (P.108).

2 Select [E-mail Settings].

3 Select the item to be set or changed.

E-mail Control

You can set the specifications for e-mail transmissions.

Maximum E-mail Size

Select whether or not to set an upper limit on data size in e-mail transmissions.

■Off

No limit on data size.

■On

Set an upper limit on data size.

You can specify a value within the range from 50 to 65,535 KB in 1 KB increments.

Note • If the set value is exceeded, the e-mail transmission is aborted.

Maximum Address Entries

Set the maximum number of addresses that can be specified when sending an e-mail.

The number of addresses is the total number of To:/Cc:/Bcc:.

You can set the maximum number of addresses in the range from 1 to 100. If the maximum number of addresses is exceeded, the e-mail transmission is aborted.

Incoming E-mail Print Options

When an e-mail sent to the e-mail address of the machine is received, you can select the print operation.

■Attachment

Only prints the attached documents.

■Full Headers and Contents

Prints the e-mail headers and body of e-mails.

When you place a check to [Print S/MIME Information], S/MIME Information is also printed.

■Basic Headers and Contents

Prints the basic headers (From/To/Subject/Date) and the contents of e-mails.

When you place a check to [Auto Print], the machine prints only e-mail that has contents.

Auto Print Error Mail

Select whether the error e-mail resulting from an incorrect address, or transmission error should be automatically printed.

- Note** • The job for printing error e-mail is displayed as error on the [Job Status] screen and a job history report even when the job has been complete successfully.

Response to Read Receipts

Set whether or not to respond when a read receipt (MDN) is requested.

- Off
Does not respond.
- On
Automatically notifies the sender that the e-mail has been processed.

Read Receipts

When an e-mail is sent from the machine, select whether to require the recipient to return the read status.

- Off
The read receipts (MDN) feature is disabled.
- On
All users are permitted to use the read receipts (MDN) feature.

Auto Print Delivery Confirmation Mail

Select whether to automatically print transmission result e-mails (DSN response/MDN response).

- Off
Transmission result e-mails are not printed.
- On
Transmission result e-mails are automatically printed regardless of success or failure of the transmission.
- Print when delivery fails
Prints only when the transmission failed.

Max Number of Pages for Split Send

Select whether to split the attachment data into pages for transmission. When split for transmission, set the number of pages.

Important • It is only possible to split into multiple-page files when the output file format is specified as PDF, DocuWorks or multiple-page TIFF.

- Off
The attachment data is not split for transmission.
- On
Set a value from 1 to 999 pages, in 1 page increments.

Allow Casual Users to Edit From Field

Set whether to protect e-mail addresses from being changed by unauthenticated users under [From] on the [E-mail] tab.

Allow Guest Users to Edit Field

Set whether to protect e-mail addresses from being changed by guest users under [From] on the [E-mail] tab.

Allow to edit From if Search found

Set whether to protect e-mail addresses from being changed under [From] on the [E-mail] tab when an authenticated user retrieves an e-mail address from the LDAP server.

Allow to edit From if Search failed

Set whether to protect e-mail addresses from being changed under [From] on the [E-mail] tab when an authenticated user fails to retrieve an e-mail address from the LDAP server.

E-mail Sending When Search Failed

Set whether to disable [E-mail] when an authenticated user fails to retrieve an e-mail address from the LDAP server.

Add Me to To Field

Set whether to automatically add the sender's address to the To field.

Add Me to CC Field

Set whether to automatically add the sender's address to the CC field.

Edit E-mail Recipients

Set whether to permit to edit e-mail recipients (To, CC, BCC).

Note • If you set [Edit E-mail Recipients] to [No], set [Add Me to To Field] to [Yes].

Mailbox Settings

You can set for handling documents stored in mailboxes.

Note • This feature does not appear for some models. An optional package is necessary. For more information, contact our Customer Support Center.

- 1** On the [System Settings] screen, select [System Settings].
For the method of displaying the [System Settings] screen, refer to "System Settings Procedure" (P.108).
- 2** Select [Mailbox Settings].
- 3** Select the item to be set or changed.

Documents Retrieved By Client

Set whether to delete a document stored in the mailbox when it is retrieved by the client.

- Delete according to Mailbox Settings
Follows the settings for individual mailbox.
For information about setting the mailbox, refer to "Delete Documents After Retrieval" (P.189).
- Force Delete
Ignores the settings for each individual mailbox, and when a document is retrieved by a client, the retrieved document is forcibly deleted.

Print & Delete Confirmation Screen

Set whether to display a confirmation screen for deleting documents before printing documents that are stored in the mailbox.

Stored Document Settings

You can select whether to automatically delete documents stored on the machine. Set the document expiration date and the time of deletion.

You can also set the stored document to be deleted by the types of document.

Note • This feature does not appear for some models. An optional package is necessary. For more information, contact our Customer Support Center.

1 On the [System Settings] screen, select [System Settings].

For the method of displaying the [System Settings] screen, refer to "System Settings Procedure" (P.108).

2 Select [Stored Document Settings].

3 Select the item to be set or changed.

Document Expiration Date

You can set the document expiration date. To delete stored documents automatically, specify a document retention period and deletion time. The settings apply to all stored documents.

■Off

Does not automatically delete the print documents stored in the machine.

■On

Allows you to set the document expiration date. The stored documents will be deleted at the time specified in [Documents deleted at].

■Documents kept for

Set the document retention period in the range 1 to 14 days.

■Documents deleted at

Set the time for the document to be deleted after the expiration date, in the range of 0 to 23 hours, and 00 to 59 minutes.

To automatically delete documents at the time specified here, you need to set [Delete Expired Documents] to [Yes]. For more information, refer to "Delete Expired Documents" (P.189).

Delete Charge Print Documents

Select whether or not to delete charge print documents after the expiration date.

Note • This item does not appear when the Charge Print feature is enabled.

Delete Secure Print Documents

Select whether or not to delete secure print documents after the expiration date.

Note • This item does not appear when the Private Charge Print feature is enabled.

For more information, refer to "Charge / Private Print Settings" (P.206).

Delete Private Charge Print Docs.

Select whether or not to delete private charge print documents after the expiration date.

Note • This item appears when the Private Charge Print feature is enabled.

For more information, refer to "Charge / Private Print Settings" (P.206).

Delete Sample Print Documents

Select whether or not to delete sample print documents after the expiration date.

Note • This item does not appear when the Private Charge Print feature is enabled.

Print Job Confirmation Screen

Set whether to display a print confirmation screen, where you can change the number of print sets if the print settings are permitted to be modified.

Minimum Passcode Length for Stored Job

Set the minimum number of allowed passcode digits between 0 and 12 digits. A passcode is required when Secure Print or Private Charge Print documents are to be stored or printed. A passcode must be a string consisting of the number of digits that is equal to or larger than the value specified here.

Note • Specify "0" if you do not set passcodes or the minimum number of digits.

Job Flow Settings for ApeosPort Series Models Only

[Job Flow Settings] allows you to configure a pool server. Leave the default settings unchanged because a pool server is not available for the machine.

Web Applications Settings for ApeosPort Series Models Only

[Web Applications Settings] allows you to specify the remote access destination.

Remote access allows you to view web application services, which are compatible with the machine, directly on the control panel, to upload a document that has been scanned on the machine to the web applications, and to directly select and print a document which is stored in the remote server. It also allows you to directly upload and print a file without going through another computer.

Note

- To use this feature, Remote Access Kit (optional) and any Fuji Xerox manufactured web applications (can be purchased separately) are required. For details, contact Customer Support Center.

The following shows the reference section for each item.

Server Setup	186
Configuring/Canceling the Auto Link Server.....	187

- 1 On the [System Settings] screen, select [System Settings].
For the method of displaying the [System Settings] screen, refer to "System Settings Procedure" (P.108).
- 2 Select [Web Applications Settings].

Server Setup

This section describes the settings up a server to access web applications.

- 1 Select [Server Setup].
- 2 Select an access destination you want to register, and select [Change Settings].
- 3 Enter the URL of the access destination, if you register an access destination in a new entry.
 - URL
Enter the URL of the access destination with up to 256 characters.
The URL must include the type of the protocol used.
(Example)
http://myhost.example.com
http://192.168.1.1
https://myhost.example.com
https://192.168.1.1
- 4 Configure other settings as necessary.
 - Server Name
Enter the access destination name with up to 32 characters.
 - Description
Enter the description of the access destination with up to 128 characters.
 - Use User ID
 - No
 - When [Login Setup/Auditron Mode] is set to [Remote Access]:
The machine accesses the remote service using the user information authenticated on the machine.
 - When [Login Setup/Auditron Mode] is set to [Off], [Local Machine Access], or [Network Access]:
Users are prompted to enter their user ID and password each time the machine accesses the remote service.

- Yes
Allows you to enter a user ID and password into [User ID] and [Password] respectively, which are used when the machine accesses the remote service.
- User ID
Enter the User ID to access the remote service, with up to 128 characters.
Important • Depending on the settings on the remote service, the entry for [User ID] may be invalid. Check the settings on the remote service.
Note • Along with [User ID], set also [Password]. [User ID] will be invalid unless [Password] is set.
• All the specified settings are ignored if the remote service to be connected requires other than a user ID and its password for authentication.
- Password
Enter the password for the User ID, with up to 128 characters.
- Machine/Authentication Notification
Set whether to notify the remote server of machine information and user authentication information every time the machine is connected to the remote service.
Note • The remote service determines whether to use the information. No need to configure settings on the control panel.
- Reset Account
Deletes all settings registered.

Configuring/Canceling the Auto Link Server

The auto link server is a server to be connected automatically when activating the Web Applications.

To configure or cancel the auto link server, follow the procedure below.

- 1 Select the access destination you want to set as the auto link server.
- 2 To configure the settings, select [Enter].
To cancel the settings, select [Clear].

- Auto Link Server No
The number of the server set as the auto link server appears.

Setup Menu

In [Setup Menu], you can register or update mailboxes, job flows, and Address Book.

Note • This feature does not appear for some models. An optional package is necessary. For more information, contact our Customer Support Center.

The following shows the reference section for each item.

Mailbox	188
Job Flow Sheets	190
Job Flow Sheet Keywords.....	195
Address Book.....	196
Paper Tray Attributes	199

- 1 In the [System Settings] screen, select [Setup Menu].
For the method of displaying the [System Settings] screen, refer to "System Settings Procedure" (P.108).
- 2 Select any item.

Mailbox

Register mailboxes in order to store scanned documents. You can register up to 500 mailboxes.

You can check the current mailboxes in the "Mailbox list". For more information, refer to "Mailbox List" (P.101).

- 1 Select [Mailbox].
- 2 Select the mailbox to be registered, and select [Create/Delete].

Note

- Select [▲] to return to the previous screen or [▼] to move to the next screen.
- You can specify the mailbox directly by entering a three-digit number with the numeric keypad.

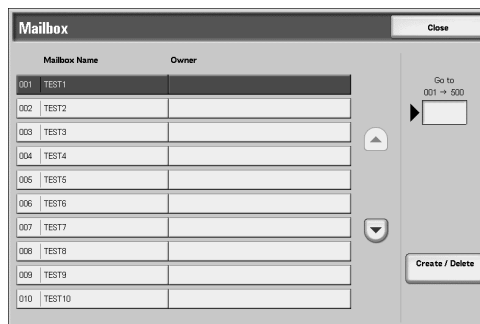

- 3 When creating a new mailbox, a passcode entry screen appears, allowing you to limit access to the mailbox.

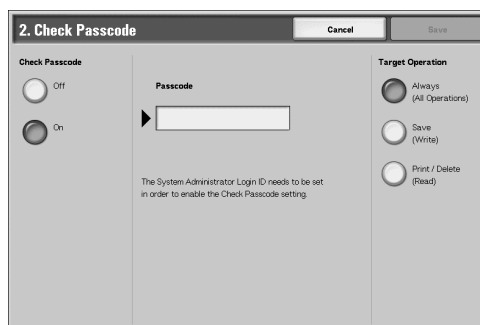

Check Passcode

Set an access restriction to permit operations for specified users only.

- Check Passcode
Set whether to check the passcode.
- Passcode
To use the Access Restriction feature, enter a passcode. You can enter a passcode of up to 20 numeric digits (0 to 9).

■Target Operation

Set the operations to be restricted.

- Always (All Operations)
A passcode entry is required when a mailbox is selected or a document in a mailbox is printed or deleted.
- Save (Write)
A passcode entry is required when a mailbox is selected.
- Print/Delete (Read)
A passcode entry is required when printing or deleting the document in the mailbox.

4 Select [Save] after limiting the access to the mailbox.

5 Select any item, then select [Change Settings].

6 Select [Save] after setting the items.

Mailbox Name

Set a mailbox name.

Using the displayed keyboard and the numeric keypad, you can enter up to 20 characters.

For information about how to enter characters, refer to "2 Product Overview" > "Entering Text" in the User Guide.

Delete Documents After Retrieval

When a document stored in a mailbox is printed, or is retrieved by an external action, set whether the document should be deleted.

■No

The document is left stored.

■Yes

After the document is printed, or is retrieved by an external action, it is automatically deleted.

Delete Expired Documents

Specify whether to enable the feature to delete documents stored in a mailbox at a specified time after a retention period has elapsed.

■No

Even when the set retention period has elapsed, documents are not deleted.

■Yes

Set the document retention period. Documents are deleted at a specified time after the retention period has elapsed. However, if the retention period has not been specified, documents are not deleted even when [Yes] is selected.

For information about setting the document retention period, refer to "Mailbox Settings" (P.182).

Link Job Flow Sheet to Mailbox

Makes a link with a job flow sheet and a mailbox. You can determine how documents stored in a mailbox are processed by linking the mailbox to a job flow sheet in which a series of operations are registered.

For the method of registering a job flow, refer to "Job Flow Sheets" (P.190).

■Cut Link

Cancels the link between a mailbox and its job flow sheet.

■Create/Change Link

A screen for linking a job flow sheet appears. You can select from the existing job flow sheets or create a new job flow sheet.

For information about the operation, refer to "Job Flow Sheets" (P.190).

- Auto Start
If you select the [Auto Start] check box, when a document is stored in the mailbox, the procedure registered in the job flow is automatically started.

When the [Delete Mailbox] Button is Selected

Selecting this button deletes the selected mailbox.
Any documents stored in the mailbox are also deleted.
If [Login Setup/Audition Mode] is set to [Off], all the job flow sheets created on the [Mailbox] screen and then stored in the mailbox are deleted as well.

Important • Once documents or job flow sheets are deleted, they cannot be recovered.

Job Flow Sheets

Job flow is a feature for executing a series of registered actions.
The target of a job flow is documents stored in a mailbox. A job flow can be executed by using one of the following four methods:

- by automatically starting a job flow when a document is stored in a mailbox
- Note**
 - To link a mailbox with a job flow sheet created with [Job Flow Sheets], start from [Send from Mailbox]. For more information, refer to "5 Send from Mailbox" < "Configuring/Starting Job Flow" in the User Guide.
- by selecting a document stored in a mailbox to manually execute the associated job flow
- by selecting a document stored in a mailbox to manually execute a job flow selecting manually
- by selecting a job flow sheet from [Job Flow Sheets] screen to manually execute (using ApeosPort series models)

To start a job flow, you must link the job flow to a mailbox. Documents are automatically processed by the job flow sheet when they stored in the mailbox.

Features that can be registered are listed below.

- Forwarding specification (FTP, SMB, and e-mail)
- Multiple forwarding specifications, multiple processing execution
- Print

Depending on the method of storing in the mailbox, there are restrictions on the combination of features



Output Input	Print	Mail	FTP	SMB	Fax Server
Scanning	○	○	○	○	X
Print Stored	X	X	X	X	X

O: Available
X: Not available

■When using ApeosPort series models

Input \ Output	Print	Mail	FTP	SMB	Fax Server
Scanning	O	△	O	O	X
Print Stored	X	X	X	X	X

O: Available

X: Not available

△: Available depending on System Administration mode settings

Restrictions on Using Job Flow

A job flow can be used by single or multiple users, or can be used by linking to a specific mailbox. The use of job flows is restricted by the authentication feature.

For information about the available job flow features and restrictions on use, refer to "Authentication for Job Flow Sheets and Mailboxes" (P.275).

- 1 Select [Job Flow Sheets].
- 2 Carry out the job flow operation.

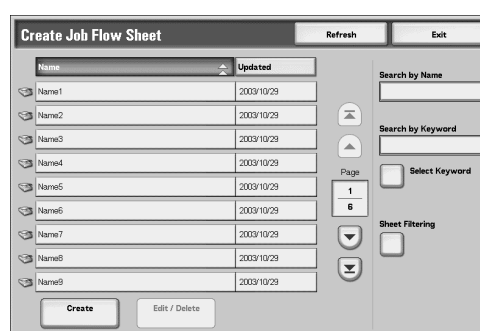

■Create

The [Create Job Flow Sheet] screen appears.

Refer to "Create Job Flow Sheet" (P.192).

■Edit/Delete

The [Details] screen appears.

Refer to "Edit/Delete" (P.195).

■Search by Name

Searches for job flows that partially match the entry. The machine searches through job flow names that were registered upon each job flow creation. The entry can be up to 128 characters long.

For information about how to enter characters, refer to "2 Product Overview" > "Entering Text" in the User Guide.

■Search by Keyword

Searches for job flows that fully match the entry. The machine searches through keywords that were registered upon each job flow creation.

For information about how to enter characters, refer to "2 Product Overview" > "Entering Text" in the User Guide.

■Select Keyword

Displays the [Select Keyword] screen. Select a keyword registered in the system settings to search for job flows. Job flows that fully match the entry are searched. The machine searches through keywords that were registered upon each job flow creation.

For information on the keyword registry, refer to "Job Flow Sheet Keywords" (P.195).

■ Sheet Filtering

Filters the job flow sheets displayed. Select the filtering conditions, then select [Save].

- Note**
- The screen display depends on the user authentication feature settings.

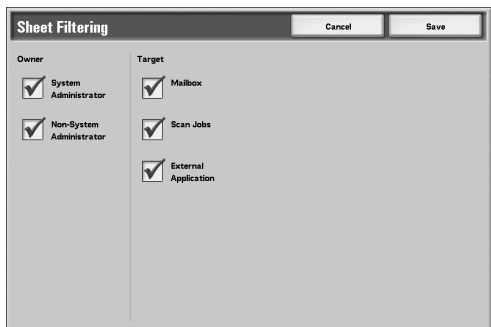

- Owner
Filters job flow sheets by owner type.
- Target (ApeosPort series models)
Filters job flow sheets by target, such as scan jobs and external applications.

Create Job Flow Sheet

Creates a new job flow.

- 1 Select the item to be set.
- 2 Select [Change Settings].

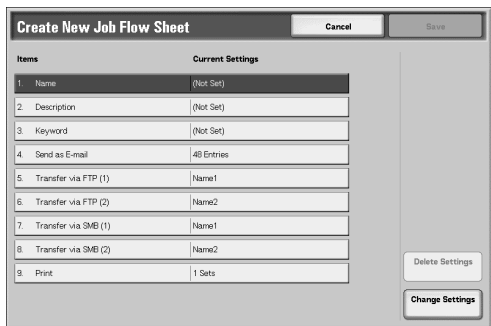

■ Delete Settings

Deletes the setting values of the selected items.

■ Change Settings

Confirm or change the settings of the selected items.

Name

Set the name for the job flow sheet, of up to 128 characters.

Description

Set the description of the job flow sheet. When using DocuCentre series models, up to 256 characters are allowed. When using ApeosPort series models, up to 512 characters are allowed.

Keyword

Enter a keyword of up to 12 characters for job flow search. You can also use the keywords that are registered in the job flow search keyword.

For information on the job flow keyword search, refer to "Job Flow Sheet Keywords" (P.195).

Send as E-mail (ApeosPort series models)

Specify the recipients for e-mail transmission. You can specify a total of up to 100 addresses, either selecting from the address book or by direct input. If [On] has been selected for [Encryption], you cannot specify a recipient by selecting [New Recipient].

■Address Book

The recipients can be specified from address book. The specified address appears in [Recipient Name/E-mail Address] in the [Send as E-mail] screen.

■New Recipient

Specify a new address. Select the item you want to change, and select [Change Settings] to set. The specified address appears in [Recipient Name/E-mail Address] in the [Send as E-mail] screen.

■Subject

Enter a subject using the keyboard displayed.

■File Format

Select an output file format. Clicking [Details...] displays the [File Format] screen.

For information on the [File Format] screen, refer to "4 Scan" > "General Settings" > "File Format(Selecting the Format of Scanned Data)" in the User Guide.

■Encryption

Set whether to enable or disable the encryption feature.

Note • To enable encryption, select [On] before specifying an address. [On] will be disabled after an address is specified.

■Digital Signature

Select whether to enable or disable the digital signature feature.

■Resend Attempts

Set whether to try again if a transmission fails. If you select [On], also set [Resend Attempts] and [Resend Interval (Seconds)].

- Resend Attempts

Set the transmission retry count in the range of 1 to 5.

- Resend Interval (Seconds)

Set the transmission retry interval in the range of 30 to 300 seconds.

■Delete Recipient

Deletes all information for the selected recipient.

■Change Settings

Displays the [Change Recipient Settings] screen, which allows you to check or change the selected recipient.

For information on the [Change Recipient Settings] screen, refer to "4 Scan" > "E-mail" > "Recipient(s)" in the User Guide.

Transfer via FTP (1), Transfer via FTP (2) (ApeosPort series models)

Transfer via FTP (2) will appear when Transfer via FTP (1) is configured. Specify where FTP forwarding is to be stored.

■Address Book

When the server address is registered in Address Book, you can specify the address from Address Book. The specified address appears in the [Transfer via FTP] screen.

For information on Address Book, refer to "Address Book" (P.196).

■File Format

Specify an output file format.

For information on file formats, refer to "4 Scan" > "General Settings" > "File Format(Selecting the Format of Scanned Data)" in the User Guide.

■Resend Attempts

Set whether to try again if a transmission fails. If you select [On], also set [Resend Attempts] and [Resend Interval (Seconds)].

• Resend Attempts

Set the transmission retry count in the range of 1 to 5.

- Resend Interval (Seconds)
Set the transmission retry interval in the range of 30 to 300 seconds.

■ Clear Field
Deletes all information for the selected address.

■ Keyboard
Select one of [Recipient Name], [Server], [Save in], [User Name], and [Password] and press the button, to display an input screen.
The numbers of characters you can input are as follows.

- Recipient Name: Up to 36 characters
- Server: Up to 64 characters
- Save in: Up to 128 characters
- User Name: Up to 32 characters
- Password: Up to 32 characters

For detail information, refer to "Job Flow Sheets" (P.190).

Transfer via SMB (1), Transfer via SMB (2) (ApeosPort series models)

Transfer via SMB (2) will appear when Transfer via SMB (1) is configured.
Specify where SMB forwarding is to be stored.

■ Address Book
When the server address is registered in Address Book, you can specify the address from Address Book. The specified address appears in the [Transfer via SMB] screen.
For information on Address Book, refer to "Address Book" (P.196).

■ File Format
Specify an output file format.
For information on file formats, refer to "4 Scan" > "General Settings" > "File Format(Selecting the Format of Scanned Data)" in the User Guide.

■ Resend Attempts
Set whether to try again if a transmission fails. If you select [On], also set [Resend Attempts] and [Resend Interval (Seconds)].

- Resend Attempts
Set the transmission retry count in the range of 1 to 5.
- Resend Interval (Seconds)
Set the transmission retry interval in the range of 30 to 300 seconds.

■ Clear Field
Deletes all information for the selected addresses.

■ Keyboard
Select one of [Recipient Name], [Server], [Shared Name], [Save in], [User Name], and [Password] and press the button, to display an input screen.
The numbers of characters you can input are as follows.

- Recipient Name: Up to 36 characters
- Server: Up to 64 characters
- Shared Name: Up to 128 characters
- Save in: Up to 128 characters
- User Name:
For domain users: Up to 97 characters with the format of "user name@domain name" or "domain name\user name"
(the user name and domain name must be up to 32 and 64 characters, respectively)
For local users: Up to 32 characters
- Password: Up to 32 characters

For detail information, refer to "Job Flow Sheets" (P.190).

Print

Makes print settings. When [On] is selected, you then configure print settings.

- **Quantity**
Set the number of copies from 1 to 999, in 1 copy increments.
- **Paper Supply**
Select the printing paper tray. When [Auto Paper] is selected, the same paper size as the original size is printed.
 - **Auto Paper**
A suitable paper tray is automatically selected.
 - **Trays 1 to 4, 6, and 7**
Select paper from six trays.
 - **Bypass**
Prints on paper loaded in the Tray 5 (Bypass).
- **2 Sided Printing**
Sets the 2-sided printing option.
- **Output**
Performs the stapling and output destination settings.
 - **Stapling**
Set the position for stapling.
 - **Hole Punching**
Set the position for punching.
 - **Output Destination**
Select the output destination.

Edit/Delete

Check the content of a job flow sheet, and edit, copy, or delete it.

- Note**
- Some operations may be restricted according to types of job flow owners, authentication settings, and user types. For details, refer to "Authentication for Job Flow Sheets and Mailboxes" (P.275).

- **Delete**
Deletes the selected job flow sheet.
- **Copy**
Makes a copy of the selected job flow sheet. From the copy of the job flow sheet, you can create a new job flow sheet.
The method of creation is the same as when creating a new job flow sheet. For more information, refer to "Create Job Flow Sheet" (P.192).
- **Edit**
Edit the selected job flow sheet.
The changing method is the same as when creating a new job flow sheet. For more information, refer to "Create Job Flow Sheet" (P.192).

Job Flow Sheet Keywords

You can register job flow search keywords. The registered keywords are displayed under [Search by Keyword] and allows you to use for job flow sheet search. The keywords are also available from a list under [Select Keyword] that is displayed when you create a new job flow sheet. Up to 12 characters are allowed for a job flow search keyword.

Address Book

You can store frequently used addresses in Address Book. Select an address type from fax, e-mail and server (FTP/SMB).

When an address is registered, you can search for it with [Address Book] screen.

You can store a total of 500 addresses for e-mail and server (FTP/SMB).

Note • If the Speed Dial Extension Kit (optional) is installed, you can register up to 999 locations.

1 Select [Address Book].

Note • To display the [Address Book] screen, press the <Log In/Out> button and enter the user ID, and then select [System Settings] > [Setup Menu] > [Address Book]. If [Setup Menu] is displayed on the [Set Up Menu] screen, select [Set Up Menu] > [Address Book].

2 Press the abbreviated number you want to register, and select [Create/Delete].

Note • Select [▲] to return the previous screen or [▼] to move the next screen.
• By entering a three-digit number with the numeric keypad, you can specify the abbreviated number directly.

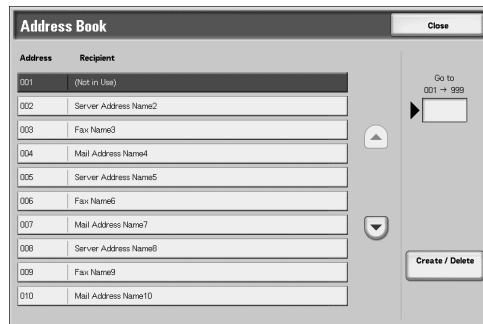

3 Select [Address Type], and select [Change Settings].

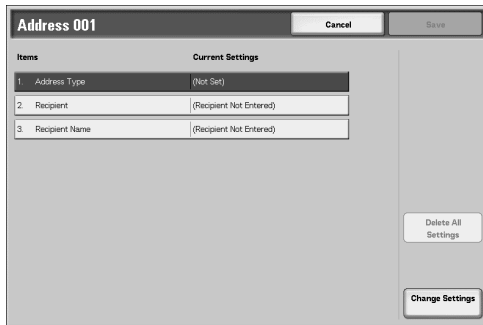

4 Select the address type, and select [Save].

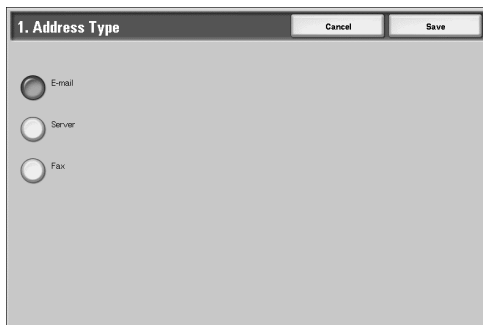

5 Select the item to be set, and select [Change Settings].

6 When the settings are completed, select [Save].

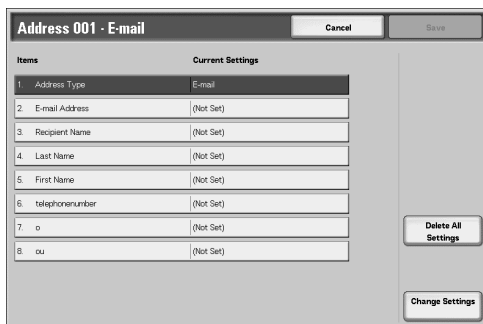

■When selecting [E-mail] as the address type

The following items appear.

- Address Type
- E-mail Address
- Recipient Name
- Last Name
- First Name
- Custom Item 1
- Custom Item 2
- Custom Item 3
- S/MIME Certificate (ApeosPort series models)

■When selecting [Server] as the address type

The following items appear.

- Address Type
- Recipient Name
- Transfer Protocol
- Server Name/IP address
- Shared Name (SMB Only)
- Save In
- User Name
- Password
- Port Number

■When selecting [Fax] as the address type

The following items appear.

- Address Type
- Fax Number
- Recipient Name
- Index

Address Type

Changes an address type.

E-mail Address

Enter an e-mail address with not more than 128 characters.

For information about how to enter characters, refer to "2 Product Overview" > "Entering Text" in the User Guide.

Fax Number

Enter a fax number with not more than 128 digits.

For information about how to enter characters, refer to "2 Product Overview" > "Entering Text" in the User Guide.

Recipient Name

Enter a recipient name with not more than 18 characters.

For information about how to enter characters, refer to "2 Product Overview" > "Entering Text" in the User Guide.

Last Name

Enter a recipient's last name (up to 32 characters).

For information about how to enter characters, refer to "2 Product Overview" > "Entering Text" in the User Guide.

First Name

Enter a recipient's first name (up to 32 characters).

For information about how to enter characters, refer to "2 Product Overview" > "Entering Text" in the User Guide.

Custom Item 1

The attribute name set as [Custom Item 1 attribute name] is shown as the item name. You can input any information as an auxiliary item. Up to 20 characters can be used. This item is appropriate for information represented by a shorter character string, such as telephone number, employee number.

For more information on the attribute name, refer to "Attribute Name of Custom Item 1, 2, and 3" (P.166).

Custom Item 2

The attribute name set as [Custom Item 2 attribute name] is shown as the item name. You can input any information as an auxiliary item. Up to 40 characters can be used. This item is appropriate for information represented by a longer character string, such as company name, department.

For more information on the attribute name, refer to "Attribute Name of Custom Item 1, 2, and 3" (P.166).

Custom Item 3

The attribute name set as [Custom Item 3 attribute name] is shown as the item name. You can input any information as an auxiliary item. Up to 60 characters can be used. This item is appropriate for information represented by a longer character string, such as company division, company address.

For more information on the attribute name, refer to "Attribute Name of Custom Item 1, 2, and 3" (P.166).

S/MIME Certificate (ApeosPort series models)

Allows you to make a link with a S/MIME certificate. The S/MIME certificate needs to be registered in advance.

In order to link a certificate, select a certificate in a screen displayed when selecting [Create/Change Link]. To delete a link, select [Cut Link].

Important • If a linked certificate is deleted due to some reason such as hard disk initialization, the certificate is delinked from the S/MIME certificate on Address Book. When re-registering the S/MIME certificate, you need to manually link it again.

Note • If many certificates are registered in the machine, it may take a long time to link a certificate. For information on the certificate, refer to "Security" (P.261).

Transfer Protocol

Set the forwarding destination protocol. You can select from [FTP] and [SMB].

Server Name/IP address

Enter a name or IP address of a forwarding destination server.

Shared Name (SMB Only)

Enter the shared name set for the SMB folder.

Important • If the "/" mark is used at the top of a shared name, a job flow cannot read the shared name correctly. Do not use the "/" mark at the top of a shared name.

Save In

Enter the directory for storing documents. When SMB is selected, use a UNC format.

- Forwarding via FTP
Example: To save in the bbb directory under the aaa directory in the root directory.
aaa/bbb

- Forwarding via SMB
Example: To save in the bbb directory under the aaa directory in a specified volume.
aaa\bbb

User Name

When a user name is required to be input by the forwarding destination server, set the user name.

When [FTP] is selected under [Transfer Protocol], up to 32 characters are allowed.

When [SMB] is selected under [Transfer Protocol], use one of the following formats.

- For Active Directory:
User name@Domain name (User name: up to 32 characters / Domain name: up to 64 characters)
Example: fuji@example.com (fuji: user name / example.com: domain name)
- For workgroups:
Local user (up to 32 characters)
Example: Fuji-Taro

Password

When a password entry is prompted by the forwarding destination server, specify a password. You can enter up to 32 characters for a password.

Index

You can enter a single alphanumeric index character for use as a keyword to search the address book.

For information about how to enter characters, refer to "2 Product OverView" > "Entering Text" in the User Guide.

Port Number

Set the forwarding destination port number. Specify a number in the range from 1 to 65535.

Important • If a port number has already been set, [Standard Port] is disabled. To change the setting in such a case, delete the existing address, and re-register a new address.

When the [Delete All Settings] Button is Selected

Selecting this button deletes all the information registered for the selected address. To delete all the registered information, select [Yes].

Important • Deleted information cannot be recovered.

Paper Tray Attributes

This is same as [Paper Tray Attributes], displayed under [Paper Tray Settings] in [Common Settings]. For details, refer to "Paper Tray Attributes" (P.127).

[Paper Tray Attributes] under [Setup Menu] is displayed only when you enable [Paper Tray Attributes on Setup Menu]. For details, refer to "Paper Tray Attributes on Setup Menu" (P.127).

System Administrator Settings

In [System Administrator Settings], you can set the system administrator ID and passcode.

You are recommended to set the system administrator ID and passcode to prevent setting changes and ensure security.

The following shows the reference section for each item.

System Administrator Login ID.....	200
System Administrator's Passcode.....	200
Maximum Login Attempts.....	201

- 1 In the [System Settings] screen, select [System Administrator Settings].
For the method of displaying the [System Settings] screen, refer to "System Settings Procedure" (P.108).
- 2 Select any item.

System Administrator Login ID

Set the system administrator user ID. Enter the ID from 1 to 32 characters.

Note • The default of the system administrator user ID is "11111".

- 1 Select [System Administrator Login ID].
- 2 Select [On].
- 3 Select [Keyboard].
- 4 Enter the system administrator ID of up to 32 characters, and select [Save].
- 5 Repeat Steps 3 and 4 to reenter the same system administrator ID.
- 6 Select [Save].
- 7 A confirmation window appears. Select [Yes] to confirm your entry.



System Administrator's Passcode

Set the passcode for System Administration mode. Setting a passcode is strongly recommended for security.

Note • The default of the system administrator's passcode is "x-admin".

The system administrator's passcode becomes valid when [Passcode Entry from Control Panel] in [Login Setup/Auditron Administration] is [On].

Set the passcode after setting the system administrator User ID. You can set the passcode from 4 to 12 numeric digits.

For information about enabling and disabling passcodes, refer to "Passcode Entry from Control Panel" (P.208).

1 Select [System Administrator's Passcode].

2 Select [Keyboard].

3 Enter a new passcode (4 to 12 digits) in [New Password/Passcode], and select [Next].

Note

- To set no passcode, leave the entry fields blank, and select [Save].

4 Repeat Steps 2 and 3 to reenter the same system administrator ID.

5 Select [Save].

6 A confirmation window appears. Select [Yes] to confirm your entry.

Maximum Login Attempts

This feature protects the settings from being changed by an outsider pretending a system administrator. If authentication for a system administrator's ID fails more than specified times continuously, access is denied.

You can specify a login attempt count in the range from 1 to 10.

Note

- The failure count is reset when the machine is restarted.
- To cancel the access rejection state, restart the machine by turning off and on the power.

1 Select [Maximum Login Attempts].

2 Select [On].

3 With [▲] and [▼], set the number of authentication attempts allowed.

4 Select [Save].

Login Setup/Auditron Administration

In [Login Setup/Auditron Administration], you can set different restrictions for each user to prevent unauthorized users from operating or accessing the machine, and can check the number of pages used by each user.

When the Login Setup/Auditron Administration feature is enabled, each machine user must enter a user ID and passcode, thus providing administrative control and accounting for the machine.

The following shows the reference section for each item.

Create/Check User Accounts	202
Account Details	204
Reset User Accounts	205
System Administrator's Meter (Copy Jobs)	205
User Details Setup	205
Charge / Private Print Settings	206
Passcode Entry from Control Panel	208
Login Setup/Auditron Mode	209

- 1 In the [System Settings] screen, select [Login Setup/Auditron Administration].
For the method of displaying the [System Settings] screen, refer to "System Settings Procedure" (P.108).
- 2 Select any item.

Create/Check User Accounts

When the Login Setup/Auditron Administration feature is used, register user IDs and user names to authenticate registered users.

For a user of the machine, you can control the use of output color, or set a limit on the number of pages. For each registered user, you can also check the cumulative number of pages. Up to 1,000 sets of user data can be registered.

Important • Before registering users, refer to "Login Setup/Auditron Mode" (P.209) to set the Login Setup/Auditron Administration mode you use.

Note • This item does not appear when [Network Access] is selected in "Login Setup/Auditron Mode" (P.209).

- 1 Select [Create/Check User Accounts].
- 2 Select [No.] for which you want to register a user, and select [Create/Delete].

Note

- [No.] is a user control number.
- Select [▲] to return the previous screen or [▼] to move the next screen.
- Entering a 4-digit user ID with the numeric keypad specifies the user directly.

UserID	User Name
0001	TST1
0002	TST2
0003	TST3
0004	TST4
0005	TST5
0006	(Not in Use)
0007	TST7
0008	TST8
0009	TST9
0010	TST10

- 3 Select any item, and set it.
- 4 Select [Save].

User ID

You can enter up to 32 characters for a user ID to use the machine.

User Name

Set a user name. You can enter up to 32 characters.

For information about how to enter characters, refer to "2 Product Overview" > "Entering Text" in the User Guide.

Passcode

Set the passcode. Setting a passcode is strongly recommended for security. You can use a 4 to 12-digit passcode.

- Note**
- When [Passcode Entry from Control Panel] is set to [On], a passcode entry is required upon authentication.
 - When the [User Login] screen has the [Edit Passcode] button, you can change your passcode on the screen.

E-mail Address

Enter an e-mail address (up to 128 characters). The address set here will be shown as the sender when sending [E-mail].

For information about how to enter characters, refer to "2 Product Overview" > "Entering Text" in the User Guide.

Account Limit

You can place restrictions on the use and the maximum number of allowed pages for each of the copy, scan, and print features.

- 1 Select [Account Limit].
- 2 Select restriction feature.
- 3 To place restrictions on a color mode or feature, select [Feature Access], and select the item.
- 4 To set account limits, select [Account Limit], then with the numeric keypad enter the maximum number of pages.

- Note**
- Select [Next] to switch to another item.

■ Feature Access

Place access restrictions on color modes and features.

Account 0001 - Account Limit

Close

Copy Service Fax Service Scan Service Print Service

Total Impressions: 1: Color 556, 2: Black 556

Account Limit: 1: Color 1112, 2: Black 1113

Feature Access: Free Access

Change Account Limit

Account 0001 - Copy - Feature Access

Cancel Save

Free Access Black Only Color Only No Access to Copy Service

- Free Access
The feature is not restricted.
- No Access to Copy/Fax/Scan/Print Service
Disables the copy/scan/print feature.
- Black Only
Only monochrome can be used. The item only appears when [Scan Service] is selected.
- Color Only
Only color can be used. The item only appears when [Scan Service] is selected.
- Account Limit
Set the maximum number of pages for copying, scanning, or printing.
 - Color
You can specify a number from 1 to 9999999 (7 digits) sheets.
 - Black
You can specify a number from 1 to 9999999 (7 digits) sheets.

Reset Account

Deletes all registered information for a selected user.

■ Yes

Deletes the registered user data. Once deleted, the data cannot be restored.

Important • All job flow sheets, mailboxes, and documents within mailboxes belonging to the user are deleted. If the user is owner of a large amount of material (when a large quantity of documents is left remaining within a mailbox for example), the deletion will take a considerable time.

■ No

Cancels the deletion of the user data.

Reset Total Impressions

Resets the current cumulative number of pages for a selected user, returning it to zero.

■ Yes

Resets the current cumulative number of pages for users. Once reset, the previous count cannot be restored.

■ No

Cancels resetting the cumulative number of pages.

Account Details

Selecting [Xerox Standard Accounting] on the [Login Setup/Auditron Mode] screen allows you to check the following for each registered user or group: (1) the maximum number of times that the account can be used for each service, and (2) how many times the account has been used for each service.

Note • You can register users and groups on CentreWare Internet Services. For more information, refer to the CentreWare Internet Services Help.

- 1 Click [Account Details].
- 2 Select [User Account] or [Group Account]. If you select [User Account], select also the User ID to be checked.
Click [Details...].

Reset User Accounts

You can delete all registered information for all registered users in a single operation, or reset the auditron. It is also available to print contents for confirmation before resetting.

Note • This item does not appear when [Network Access] or [Xerox Standard Accounting] is selected in "Login Setup/Auditron Mode" (P.209).

■ All User Accounts

Deletes all information registered for each user. It also deletes all data including the maximum number of pages, cumulative number of pages, output color restrictions, and printer auditron data.

Important • All job flow sheets, mailboxes, and documents within mailboxes belonging to the user are deleted. If the user is owner of a large amount of material (when a large quantity of documents is left remaining within a mailbox for example), the deletion will take a considerable time.

■ All Feature Access Settings

Resets the feature access limit for all users.

■ All Account Limits

Resets the maximum number of pages for all users to the default (9,999,999 pages).

■ Total Impressions

Resets all auditron administration data for all users including the system administrator. The number of pages is also reset to 0.

■ Meter (Print Jobs)

Resets all printer auditron, and deletes automatically registered job owner names. The number of pages printed is also reset to 0.

Note • [Meter (Print Jobs)] is displayed when [Off] is selected for [Print Service] in the Login Setup/Auditron Administration.

■ Print Report (DocuCentre series models) /

Print the Auditron Report (ApeosPort series models) and Print the Meter Report (ApeosPort series models)

Prints a report including contents registered information to reset or a report including contents administration data to reset.

The report is available for confirmation before resetting.

■ Reset

Deletes or resets the data for the selected item.

System Administrator's Meter (Copy Jobs)

You can check or reset the total impression copied using the System Administration mode on the screen.

The total impressions are counted up to 9,999,999 pages for both color and monochrome.

Note • This item does not appear when [Network Access] is selected in "Login Setup/Auditron Mode" (P.209).

User Details Setup

Set the information required when carrying out authentication.

User ID Characters

If required, you can change the indication "UserID" on the [System Administrator Login] screen that appears when the <Log In/Out> button on the control panel is pressed to another name such as "User Name" or "Number". The alias can be set to 1 to 15 characters.

Note • The value is also reflected in report/list displays, and when accessing from CentreWare Internet Services.

Hide User ID (***)

You can set how an entered user ID is shown on the screen. Use this feature to strengthen security as required.

■ Show

As you enter the user ID, the characters are echoed on the screen in the normal way.

■ Hide

As you enter the user ID, the character string is hidden as a row of asterisks (*****).

Account ID Characters

If required, you can change the indication "Account ID" on the [System Administrator Login] screen that appears when the <Log In/Out> button on the control panel is pressed to another name such as "Account Name" or "Number". The alias can be set to 1 to 15 characters.

Note • This item appears when [Network Access] is selected in "Login Setup/Auditron Mode" (P.209).
• The value is also reflected in report/list displays, and when accessing from CentreWare Internet Services.

Hide Account ID (***)

You can set how an entered Account ID is shown on the screen. Use this feature to strengthen security as required.

Note • This item appears when [Network Access] is selected in "Login Setup/Auditron Mode" (P.209).

■ Show

As you enter the Account ID, the characters are echoed on the screen in the normal way.

■ Hide

As you enter the Account ID, the character string is hidden as a row of asterisks (*****).

Failed Access Log

In order to detect unauthorized access, an error is logged if authentication fails within a specified period of time. Set the failure count.

Store User Details

You can set the destination to save authentication information. Select NVM or hard disk.

Note • This item appears when [Network Access] is selected in "Login Setup/Auditron Mode" (P.209).

Remote Login User ID (ApeosPort series models)

Set whether user IDs must be case-sensitive when they are verified by a remote authentication server.

Charge / Private Print Settings

You can set how received print jobs should be handled.

PJL Receive Command Control

Print jobs submitted by external equipment can be controlled by PJL commands. The settings for [Receive Control] described later are applied when either [Off] is selected or no PJL command is received.

PJL Output Command Control

Print jobs submitted by an external equipment can be controlled by PJL commands.

Receive Control

You can set how received print jobs should be handled.

For information about printing from a print driver, refer to "7 Computer Operations" > "Printing" in the User Guide (DocuCentre series models) or "9 Computer Operations" > "Printing" in the User Guide (ApeosPort series models).

For information about printing or deleting the print job that are saved after being received, refer to "Private Charge Print" (P.81) and "Charge Print" (P.79).

- 1 Select [Receive Control], and select [Change Settings].
- 2 Select any item.
- 3 According to the selected item, set the processing to be applied to jobs.

- According to Print Auditron
Follows the settings for the [Printer Settings] under "Login Setup/Auditron Mode" (P.209) and "Auditron Mode" (P.210).

- Note**
- To restrict print job operations using the authentication feature, set [Login/Setup Auditron Mode] to [Local Machine Access] or [Network Access], and also set [Printer] under [Auditron Mode] to [On].

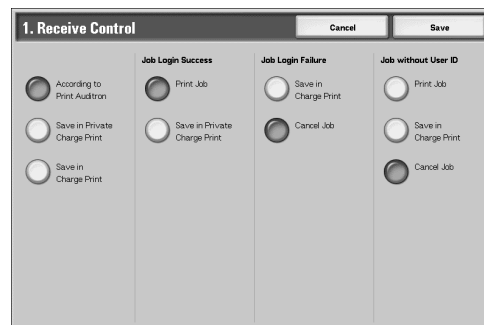

When [According to Print Auditron] is selected, [Job Login Success], [Job Login Failure] and [Job without User ID] appear.

- Job Login Success
Set the processing to be applied to successfully authenticated jobs.
 - To print all received jobs, select [Print Job].
 - To save received jobs using the Private Charge Print feature, select [Save in Private Charge Print].
- Note
 - When [Save in Private Charge Print] is selected, the Security Print, Sample Print, Mailbox Print, and Delayed Print settings specified on the print driver will be ignored.
 - When saving the print jobs in Private Charge Print, use up to 24 characters for the User ID. If the User ID set on the print driver exceeds 24 characters, a print job will be cancelled, and will not be saved in Private Charge Print.
- Job Login Failure
Set the processing to be applied to authentication failure jobs (whose information, such as the user ID and passcode, has been incorrectly registered on the print driver).
 - When [Save in Charge Print] is selected, all jobs received are saved.
 - When [Cancel Job] is selected, jobs received are deleted.
- Job without User ID
Set the processing to be applied to jobs with no user ID attached (such as print or e-mail print jobs sent from CentreWare Internet Services).
 - To print all jobs, select [Print Job].
 - To save jobs using the Charge Print feature, select [Save in Charge Print].
 - To delete jobs, select [Cancel Job].

- Note** • [Job without User ID] is changed to [Print Job] when you select as follows on CentreWare Internet Services: [Properties] > [Auditron Administration] > [Non-Account Print]. When [Job without User ID] is set to [Save in Charge Print] or [Cancel Job], the [Non-Account Print] check box on CentreWare Internet Services is cleared.

■ Save in Private Charge Print

Regardless of whether the authentication feature is being used or not, all jobs that have a user ID are saved using the Private Charge Print feature.

- Important** • When using [Save in Private Charge Print], all the print jobs that have User IDs are saved regardless of whether or not being successfully authenticated. To minimize the unnecessary print jobs, specify how long print jobs can be saved for, so that they can be automatically deleted after a specified period of time. Or the system administrator can manually delete them. For details on how to specify a duration of how long the print jobs are kept, refer to "Stored Document Settings" (P.183). For details on how to delete the print jobs manually, refer to "Private Charge Print" (P.81).

- Note** • When [Save in Private Charge Print] is selected, the Security Print, Sample Print, Mailbox Print, and Delayed Print settings specified on the print driver will be ignored.
- When saving the print jobs in Private Charge Print, up to 24 characters for the User ID. If the User ID set on the print driver exceeds 24 characters, a print job will be cancelled, and will not be saved in Private Charge Print.

When [Save in Private Charge Print] is selected, [Job without User ID] appears.

- Job without User ID
 - Set how to process the e-mail print jobs with no user ID attached.
 - To print all jobs, select [Print Job].
 - To save jobs using the Charge Print feature, select [Save in Charge Print].
 - To delete jobs, select [Cancel Job].

- Note** • [Job without User ID] is changed to [Print Job] when you select as follows on CentreWare Internet Services: [Properties] > [Auditron Administration] > [Non-Account Print]. When [Job without User ID] is set to [Save in Charge Print] or [Cancel Job], the [Non-Account Print] check box on CentreWare Internet Services is cleared.

■ Save in Charge Print

Regardless of whether the authentication feature is being used or not, all received jobs are saved using the Charge Print feature.

- Important** • When using [Save in Charge Print], all the print jobs are saved regardless of whether or not being successfully authenticated. To minimize the unnecessary print jobs, specify how long print jobs can be saved for, so that they can be automatically deleted after a specified period of time. Or the system administrator can manually delete them. For details on how to specify a duration of how long the print jobs are kept, refer to "Stored Document Settings" (P.183). For details on how to delete the print jobs manually, refer to "Private Charge Print" (P.81)

- Note** • When [Save in Charge Print] is selected, the Security Print, Sample Print, Mailbox Print, and Delayed Print settings specified on the print driver will be ignored.

Passcode Entry from Control Panel

You can set whether a passcode is required when the system administrator or a user uses the machine. Select [On] to enable "System Administrator's Passcode" (P.200), and "Passcode" (P.203) for [Create/Check User Accounts].

Select [Off] not to require the passcode, even if a passcode is set in the above procedures.

- Important** • The setting of [Passcode Entry from Control Panel] is used for authentication on the machine. A passcode must always be entered when accessing from remote devices using CentreWare Internet Services or the like, regardless of the use of passcode setting. Depending on authentication procedures, a passcode may be required for other processes as well.

- Note** • The system administrator's passcode is also required when you change settings from CentreWare Internet Services.

Login Setup/Auditron Mode

Set whether the Auditron administration feature is enabled or not, and whether to request an authentication operation.

- 1 Select [Login Setup/Auditron Mode].
- 2 Select any item.

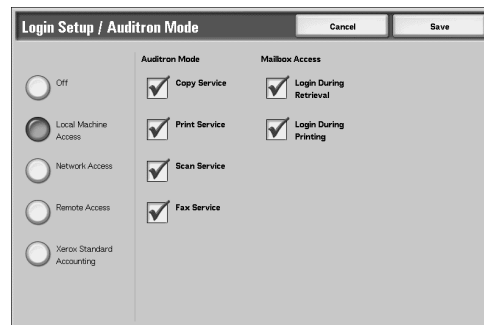

Off

No user login setup/auditron administration is required to operate the machine.

- Note**
- When [Off] is selected, [Auditron Mode] and [Mailbox Access] are disabled even if they are set to [On].

Local Machine Access

The auditron administration is carried out using the authenticated users already registered on the machine.

For information about authentication on the machine, refer to "Authentication and Auditron Administration" (P.271).

Network Access

Auditron administration is carried out using user information managed by the remote service. User information is registered on the remote service.

For information about net authentication, refer to "Authentication and Auditron Administration" (P.271).

- Note**
- When [Network Access] is selected, you will be able to enter your account ID on the [Authentication] screen that appears when the <Log In/Out> button is pressed on the control panel.

■Verify User Details

Set whether to access a remote service to verify user information.

- No
Prompts for your user ID and account ID, but does not verify them. The entered information is recorded in the machine.
- Yes
Verifies user information and permits only authenticated users to use the corresponding feature. To also perform verification for print jobs, select [Yes] for [For Print Jobs].

■Customize User Prompt

Set the type of user information used for verification.

- User ID & Account ID
Prompts for both your user ID and your account ID.
- User ID only
Prompts for your user ID only.
- Account ID only
Prompts for your account ID only.
- None
Does not prompt for a user ID or account ID.

Remote Access (ApeosPort series models)

Verifies a remote accounting server. Can be used to manage user information managed on a remote accounting server. User information cannot be registered on the machine.

For information on the settings, refer to "Login Setup/Auditron Mode" (P.209).

- Important**
- When switching to or from the remote access mode, the following information is lost.
 - All user information
 - Personal mailboxes and personal job flow sheets
 - When a Kerberos server is used as a remote authentication server, if the time of the remote authentication server and that of this machine differs, authentication may fail.
 - Remote Access is not available when enabling [TCP/IP - IP Filter] of [Protocol Settings] in [Network Settings] under [System Settings] on the touch screen.

■ Guest User

Set whether to allow a user not registered with the remote authentication server to use the machine as a guest user.

■ Guest Password

Configure the guest password as necessary. You can set the password from 4 to 12 digits.

Xerox Standard Accounting

Carries out the auditron authentication based on accounting users registered on the machine.

Auditron Mode

Select whether to use the auditron administration feature when using the copy, scan, and print services. Note that Login Setup/Auditron Administration cannot be used unless the system administrator user ID is set.

For information about the items you can manage, refer to "Authentication and Auditron Administration" (P.271).

Note • The items appearing depend on the services provided.

■ Copy Service

Set whether to enable the Login Setup/Auditron Administration feature for copy operations.

■ Fax Service

Set whether to enable the Login Setup/Auditron Administration feature for server fax operations.

■ Scan Service

Set whether to enable the Login Setup/Auditron Administration feature for scan operations.

■ Print Service

Set whether to enable the Login Setup/Auditron Administration feature for print operations.

Note • A job may be cancelled depending on the settings for "Receive Control" (P.207)

Mailbox Access

Set whether to carry out authentication when printing or retrieving documents stored in a mailbox.

Note • This item appears when a mailbox is registered.

■ Login During Printing

Set whether authentication is required when a document within a mailbox is printed.

■ Login During Retrieval

Set whether authentication is required when a document within a mailbox is retrieved through the network.

7 Using CentreWare Internet Services

This chapter describes how to use CentreWare Internet Services.

- Installation of CentreWare Internet Services212
- Starting CentreWare Internet Services214
- Setting Items Using CentreWare Internet Services215

Installation of CentreWare Internet Services

CentreWare Internet Services provides services such as displaying the status of the machine as a printer and jobs, and altering configurations using a web browser in a TCP/IP environment.

Refer to "CentreWare Internet Services Problems" (P.319) when any troubles occur during the configuration.

Preparations

Prepare a computer supporting the TCP/IP protocol to use CentreWare Internet Services.

CentreWare Internet Services supports the following browsers:

■ For Windows OS

- Microsoft Internet Explorer 6.0 Service Pack 1 or later
- Netscape Navigator 7.0 or later

■ For Mac OS 9.2 or later

- Netscape Navigator 7.02 or later

■ For Mac OS X v10.3.9

- Netscape Navigator 7.1 or later
- Safari 1.3 or later

Configuration on the Machine

The following describes the configuration procedure for using CentreWare Internet Services on the machine.

First enable the Internet Service (HTTP) port, then set the IP address.

- 1** Display the [System Settings] screen.
 - 1) Press the <Log In/Out> button.
 - 2) Enter the user ID with the numeric keypad or a keyboard displayed by pressing [Keyboard], and select [Confirm].

Note • The default user ID is "11111". When using the Authentication feature, a passcode is required. The default passcode is "x-admin".
 - 3) Select [System Settings].
 - 4) Select [System Settings].
- 2** Enabling the Internet service (HTTP) port on the machine.
 - 1) Select [Network Settings].
 - 2) Select [Port Settings].
 - 3) Select [Internet Services (HTTP)] and then select [Change Settings].
 - 4) Select [Port Status] and then select [Change Settings].
 - 5) Select [Enabled] then select [Save].
 - 6) Select [Close] repeatedly until the [Network Settings] screen is displayed.

3 Set an IP address.

If an IP address is already set, this step is not necessary. Also, in an environment with DHCP or BOOTP, configure the way to obtain an IP address. Either the address cannot be obtained automatically or manual configuration is preferred, configure an IP address, a subnet mask, and a gateway address.

For information on how to set an IP address, refer to "Starting CentreWare Internet Services" (P.214).

4 Select [Close] repeatedly until the [System Settings] screen is displayed.**5** Select [Exit].**6** After the machine is restarted, print out a settings list to confirm that the port for CentreWare Internet Services is enabled and TCP/IP is configured.

For information on how to print a settings list, refer to "Print Report/List" (P.97).

7 Start CentreWare Internet Services to confirm whether the machine is set to use.

For information on how to start CentreWare Internet Services, refer to "Starting CentreWare Internet Services" (P.214).

Starting CentreWare Internet Services

To use CentreWare Internet Services, perform the following procedure on your computer.

- 1 Start a web browser.
- 2 Enter the machine's IP address or the Internet address to the address box on the web browser, and press the <Enter> key.

- Example of the IP address entry (when the machine's IP address is 192.168.1.1)

http://192.168.1.1/

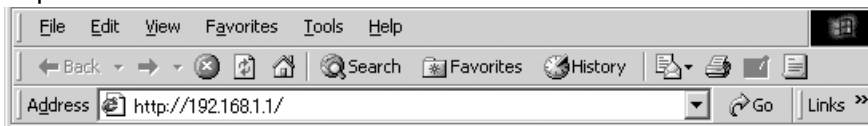

- Example of the Internet address entry (when the machine's Internet address is myhost.example.com)

http://myhost.example.com/

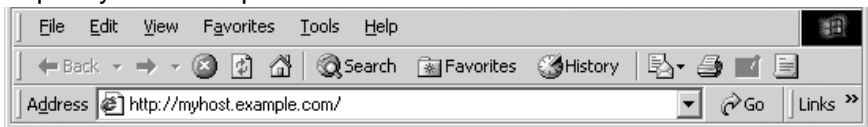

- Note**
- If your network uses DNS (Domain Name System) and the machine's host name is registered in the domain name server, you can access the machine using the Internet address with the combination of the host name and the domain name. For example, if the host name is "myhost", and the domain name is "example.com", then the Internet address is "myhost.example.com".
 - When specifying a port number, add ":" and the port number after the Internet address.
 - If using the authentication feature on the machine, enter a user ID and passcode into the [User Name] and [Password] fields.
 - If communications are encrypted, you must specify an address that starts with "https" instead of "http" to access CentreWare Internet Services.
 Example of the IP address entry
 https://192.168.1.1/
 Example of the Internet address entry
 https://myhost.example.com/
 - If authentication of the system administrator fails, the following message is displayed in the right frame of web browser.
 "Authentication failed"
 - If the number of times that authentication fails exceeds the set number, the following message is displayed in the right frame of web browser.
 "Switch the machine Off and then On for System Administrator login."

Refer to "CentreWare Internet Services Problems" (P.319) if CentreWare Internet Services is not displayed.

Setting Items Using CentreWare Internet Services

CentreWare Internet Services enable you to alter various settings on the machine from a computer.

- Note**
- Confirm that the port in use is enabled in [Port Status] of the [Properties] tab, if an item that you want to set is not displayed.
 - When a setting is changed from CentreWare Internet Services while operating the control panel, the setting items changed on the screen of the control panel are not displayed. Switch the machine off and on in this case.
 - If using the authentication feature on the machine, enter a user ID and passcode into the [User Name] and [Password] fields.
 - If you are prompted for your user name and password when changing settings on CentreWare Internet Services, enter the administrator's user ID and passcode into the [User Name] and [Password] fields. As default, User name is '11111' and Password is 'x-admin'.

The items that can be configured using CentreWare Internet Services are as follows.

- Note**
- Click [Help] at the top right of the CentreWare Internet Services screen for details on the setting items.
- **Mailbox Settings**
Enables you to register a mailbox, as well as import or print documents saved in a mailbox.
 - **Job Flow Sheets**
Allows you to register, edit, or delete job flow sheets.
 - **Paper Tray Attributes**
Allows you to configure the settings priority for the respective paper tray.
 - **Paper Settings**
Allows you to configure the settings priority for the respective paper type.
 - **Power Saver Settings**
Allows you to configure the power saver time-out of the machine.
 - **Stored Document Settings**
Allows you to configure the passcode for secure print and charge print.
 - **Address Book**
Allows you to register address numbers in batches and download the address book in CSV format.
 - **PKI Settings**
Allows you to configure security settings for the transmission. The items that can be configured are as follows.
 - SSL / TLS Settings
 - Certificate Management
 - S/MIME Settings (ApeosPort series models)
 - PDF/DocuWorks Security Settings (ApeosPort series models)
 - **Mail Notice Settings**
Allows you to configure the recipient mail addresses, notice frequency for consumables status notice service.
 - **Auditron Administration**
Allows you to configure auditron administration settings that require login setup.

- **User Details Setup**
Allows you to configure the information for authentication.
- **Remote Authentication Server / Directory Service (ApeosPort series models)**
Allows you to configure the remote authentication server. The items that can be configured are as follows.
 - Authentication System Settings
 - Kerberos Server Settings
 - LDAP Server / Directory Service (ApeosPort series models)
 - SMB Server Settings
- **Internet Services Settings**
Allows you to configure the settings for Internet Services.
- **Proxy Server Settings**
Allows you to configure the Proxy server settings
- **Port Status**
Displays the port settings and allows you to select whether to enable or disable different ports used in the machine.
- **Port Settings**
Allows you to configure the port settings as follows.
 - Ethernet
 - USB
- **Protocol Settings**
Allows you to configure the settings for protocols as follows.

- EtherTalk	- SMB	- NetWare	- TCP/IP
- LPD	- SNMP	- IPP	- Port 9100
- E-mail	- SMTP,	- POP3	- HTTP
- UPnP	- SSDP	- WebDAV	- Bonjour
- **Emulation Settings**
Allows you to configure the settings such as the printer language used for each interface or the printer settings for the respective types of emulation. The items that can be configured are as follows.

- Print Mode	- HP-GL/2	- TIFF / JPEG	- ESC/P-K
- PCL			
- **Memory Settings**
Allows you to configure the settings for the free space available and the print page buffer size.
- **Reports**
Allows you to configure the Scan File Transfer Report
- **System Administrator Settings**
Allows you to configure the User ID and password of the system administrator.

- **Web Application Settings (ApeosPort series models)**
Allows you to configure the server to be connected when using the Web Applications.
- **Audit Log (ApeosPort series models)**
Displays the audit log. The audit log is a record such as what operations were done by whom and when. Using the audit log feature helps with observations of any unauthorized use or access attempt.

8 Printer Environment Settings

This chapter describes how to set up the printer's operating environment.

- Print Features Overview 220
- Installation When Using USB Port 223
- Installation When Using TCP/IP (LPD/Port 9100) 225
- Installation When Using NetWare 228
- Installation When Using Microsoft Network (SMB) 231
- Installation When Using Internet Printing Protocol (IPP) 233
- Installation When Using EtherTalk 235

Print Features Overview

This machine can be set up as a local printer by directly connecting the machine to a computer using a USB interface cable. Similarly, it can be set up as a network printer by connecting the machine to a network.

Enable the necessary port using the control panel or CetreWare Internet Services.

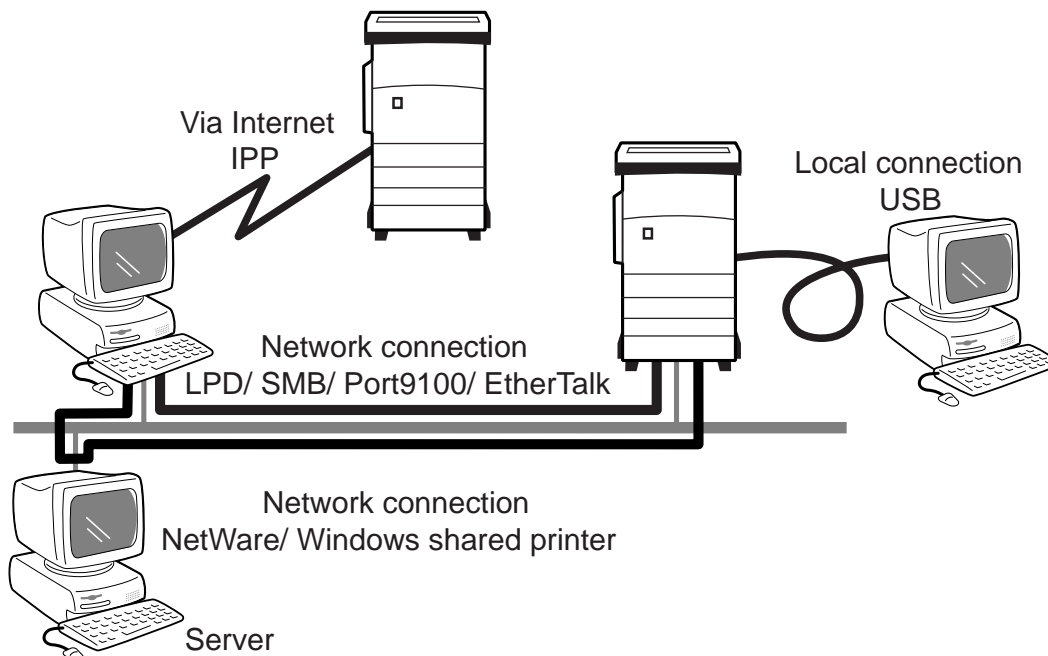

Using the Machine as a Local Printer

■USB

Use a USB interface cable to directly connect the machine to a computer. To do so, USB 2.0 Expansion Kit (optional) is required.

For more information on how to set up the machine using USB connection, refer to "Installation When Using USB Port" (P.223).

Using the Machine as a Network Printer

To set up the machine as a network printer, the following methods are available to connect the machine.

■LPD

Use TCP/IP protocol when direct communication with the machine can be established.

For more information on how to set up the machine using LPD, refer to "Installation When Using TCP/IP (LPD/Port 9100)" (P.225).

■NetWare

The machine supports PServer mode using Netware directory service and bindery service. The PServer mode enables the machine to function as a printer server, and to capture print jobs in the print queue to output. The created printer for the machine consumes one user license of the file server.

Note • The machine does not support RPrinter (Remote Printer) mode.

- You can use the machine as a printer in a NDPS environment by using a Novell NDPS Gateway. When using in a NDPS environment, settings of the machine to be used under a NetWare print environment are required. Or, you need to enable LPD in advance and set it as a gateway destination in a Novell NDPS Gateway setup. However, attribute information that can be set or captured by NDPS is not supported.
 - Supported interfaces
 - 100BASE-TX
 - 10BASE-T
 - Supported frame types
 - Ethernet II specification
 - IEEE802.3 specification
 - IEEE802.3 / IEEE802.2 specification
 - IEEE802.3 / IEEE802.2 / SNAP specification
- Note**
- The machine sends packets of each frame type on the network, and will initialize for the same frame type as the first reply packet received. The frame type can also be fixed. However, if there are multiple protocols running on the same network, use Ethernet II specification.
 - Some network equipment, such as hubs, may not be compatible with the automatic frame type detection. If a data link indicator corresponding to the port of the network equipment connected with the machine does not light up, change the frame type settings of the machine accordingly with the that of the file server. Use CentreWare Internet Services to change these settings.

For more information on how to set up the machine using NetWare, refer to "Installation When Using NetWare" (P.228).

■SMB

Use SMB to print using Microsoft Networks.

For more information on how to set up the machine using SMB, refer to "Installation When Using Microsoft Network (SMB)" (P.231).

■IPP

Use IPP to print through Internet.

For more information on how to set up the machine using IPP, refer to "Installation When Using Internet Printing Protocol (IPP)" (P.233).

■Port 9100

Use Port9100 when using Port9100 port.

For more information on how to set up the machine using IPP, refer to "Installation When Using TCP/IP (LPD/Port 9100)" (P.225).

■EtherTalk

Use EtherTalk when printing from a Macintosh computer. Adobe PostScript 3 Kit (optional) is required.

For more information on how to set up the machine using EtherTalk, refer to "Installation When Using EtherTalk" (P.235).

Supported Operating Systems

Connection method		Local connection	Network connection									
Port		USB 2.0	LPD	NetWare			SMB		IPP	Port 9100	Ether Talk	Bonjour
Protocol		-	TCP/IP	TCP/IP	IPX/SPX	Net BEUI	TCP/IP	TCP/IP	TCP/IP	Apple Talk	Bonjour	
OS	Windows 2000	○ ^{*1}	○	○	○	○	○	○	○			
	Windows XP	○ ^{*1}	○	○	○		○	○	○			
	Windows Server 2003	○ ^{*1}	○	○	○		○	○	○			
	Windows Vista	○ ^{*1}	○				○	○	○			
	UNIX		○ ^{*3}									
	Macintosh	○ ^{*1,2,5}	○ ^{*2,4}							○ ^{*2}	○ ^{*6}	

*1: The computer must be equipped with a USB 2.0 port.

*2: Adobe PostScript 3 Kit (optional) is required.

*3: Adobe PostScript 3 Kit (optional) and a Unix filter are required to print PostScript data.

*4: Supports Mac OS X 10.3.9 to 10.4.9 only.

*5: Supports Mac OS 8.6 to 9.2.2, and Mac OS X 10.3.9 to 10.4.9 only.

*6: Supports Mac OS X 10.3.9 or later.

For information on network environments, refer to the manual in the CD-ROM of the Driver CD Kit.

Installation When Using USB Port

Preparations

Prepare the following items to install the machine when using a USB interface.

- USB cable
- CD-ROM of the Driver CD Kit (provided with the machine)
- USB port
- Adobe PostScript 3 Kit (optional) - this is required only when using a Macintosh computer

Installation Overview

To connect the machine directly with a computer using a USB cable, the following configuration must be done:

- Configuration on the machine
Configuring the USB port on the machine.
- Configuration on a computer
Installing a print driver.

Configuration on the Machine

The following describes the configuration procedure to use a USB interface on the machine.

- Note**
- To print binary data by using a USB interface, set [Adobe Communication Protocol] to [RAW].
 - The configuration can also be performed using CentreWare Internet Services.

For the items that can be configured using CentreWare Internet Services, refer to "CentreWare Internet Services Setting Items" (P.224).

- 1** Display the [System Settings] screen.
 - 1) Press the <Log In/Out> button.
 - 2) Enter the user ID with the numeric keypad or a keyboard displayed by pressing [Keyboard], and select [Confirm].

Note

 - The default user ID is "11111". When using the Authentication feature, a passcode is required. The default passcode is "x-admin".
 - 3) Select [System Settings].
 - 4) Select [System Settings].
- 2** Enabling the USB port on the machine.
 - 1) Select [Network Settings].
 - 2) Select [Port Settings].
 - 3) Select [USB], and select [Change Settings].
 - 4) Select [Port Status], and select [Change Settings].
 - 5) Select [Enabled], then select [Save].

- 3** Configure other USB settings as necessary.
For details, refer to "Using CentreWare Internet Services" (P.211)
- 4** Select [Close] repeatedly until the [System Settings] screen is displayed.
- 5** Select [Exit].
- 6** Restart the machine, and print a settings list to confirm that the USB port is enabled.
For information on how to print a settings list, refer to "Print Report/List" (P.97).

CentreWare Internet Services Setting Items

The items that can be configured using CentreWare Internet Services are as follows.
For details on features provided by CentreWare Internet Services, click [Help] in this frame to see the help.

For information on how to start CentreWare Internet Services, refer to "Starting CentreWare Internet Services" (P.214).

- Port Status
- Auto Eject Time
- Adobe Communication Protocol

Note • The Adobe Communication Protocol is set only when optional Adobe PostScript 3 Kit is installed.

- Print page buffer of the USB interface

Configuration on the Computer

The following describes the configuration procedure for the computer.

In order to print from the machine, the computer needs to have a print driver installed.

For information on the supported operating systems, refer to "Supported Operating Systems" (P.222).

For information on the print driver installation procedure, refer to the manual contained in the CD-ROM of the Driver CD Kit.

You can also print from a Macintosh computer using USB if Adobe PostScript 3 Kit (optional) has been installed.

For information on the print driver installation procedure, refer to the manual contained in the CD-ROM provided with the kit.

Installation When Using TCP/IP (LPD/Port 9100)

Preparations

Prepare the following items to install the machine when using a TCP/IP (LPD/Port 9100) protocol.

- TCP/IP network environment
- CD-ROM of the Driver CD Kit (provided with the machine)
- Adobe PostScript 3 Kit (optional) - this is required only when using a Macintosh computer

Installation Overview

To connect the machine to a computer using TCP/IP(LPD/Port 9100), the following configuration must be done:

- Configuration on the machine
Configuring TCP/IP (LPD/Port 9100) on the machine.
- Configuration on the computer
Installing a print driver.

Configuration on the Machine

The following describes the configuration procedure to use a TCP/IP (LPD/Port 9100) protocol on the machine. Enable a LPD Port/Port 9100 port, then assign an IP address.

Note • The configuration can also be performed using CentreWare Internet Services or IP Address Setting Tool included in the CD-ROM of the Driver CD Kit.

For the items that can be configured using CentreWare Internet Services, refer to "CentreWare Internet Services Setting Items" (P.226).

- 1** Display the [System Settings] screen.
 - 1) Press the <Log In/Out> button.
 - 2) Enter the user ID with the numeric keypad or a keyboard displayed by pressing [Keyboard], and select [Confirm].

Note • The default user ID is "11111". When using the Authentication feature, a passcode is required. The default passcode is "x-admin".

 - 3) Select [System Settings].
 - 4) Select [System Settings].
- 2** Enable either the LPD port or the Port 9100 port as appropriate. In this example, the LPD port is enabled.
 - 1) Select [Network Settings].
 - 2) Select [Port Settings].
 - 3) Select [LPD], and select [Change Settings].
 - 4) Select [Port Status], and select [Change Settings].
 - 5) Select [Enabled], then select [Save].
 - 6) Select [Close] repeatedly until the [Network Settings] screen is displayed.

3 Set an IP address.

If an IP address is already set, this step is not necessary.

Also, in an environment with DHCP or BOOTP, configure the way to obtain an IP address. Either the address cannot be obtained automatically or manual configuration is preferred, configure an IP address, a subnet mask, and a gateway address.

For information on how to set an IP address, refer to "Protocol Settings" (P.158)

4 If the operating system on the client is Mac OS X 10.3.9 or later, the discovery feature that automatically detects printers on the IP network can be enabled.

Note

- [Bonjour] can be set when Adobe PostScript 3 Kit is installed.
- In order to print from a printer detected by [Bonjour], the LPD port must be activated in advance.

- 1) Select [Port Settings].
- 2) Select [Bonjour] and then select [Change Settings].
- 3) Select [Port Status] and select [Change Settings].
- 4) Select [Enabled] then select [Save].
- 5) Select [Close] repeatedly until the [Network Settings] screen is displayed.

5 Select [Close] repeatedly until the [System Settings] screen is displayed.**6** Select [Exit].**7** Restart the machine, and print a settings list to confirm that the LPD port is enabled and TCP/IP is configured.

For information on how to print a settings list, refer to "Print Report/List" (P.97).

Configure other LPD or Port 9100 settings as necessary. Refer to "CentreWare Internet Services Setting Items" (P.226).

CentreWare Internet Services Setting Items

The items that can be configured using CentreWare Internet Services are as follows.

For details on features provided by CentreWare Internet Services, click [Help] in this frame to see the help.

For information on how to start CentreWare Internet Services, refer to "Starting CentreWare Internet Services" (P.214).

- Port Status
- Host Name
- Method for obtaining the IP address
- Machine IP Address
- Subnet Mask
- Gateway Address
- DNS settings
- WINS Server
- IP Address List
- Port Number
- TBCP Filter

Note

- The TBCP filter is set only when optional Adobe PostScript 3 Kit is installed.

- Connection Time-Out

- Maximum Number of Sessions

Note • The Maximum Number of Sessions is set only when the LPD port is enabled.

- Print page buffer of the Port 9100 interface

Configuration on the Computer

The following describes the configuration procedure for the computer.

In order to print from the machine, the computer needs to have a print driver installed.

For information on the supported operating systems, refer to "Supported Operating Systems" (P.222).

For information on the driver installation procedure, refer to the manual contained in the CD-ROM of the Driver CD Kit.

You can also print from a Macintosh using TCP/IP (LPD). You will need optional Adobe PostScript 3 Kit.

Refer to the manual contained in the CD-ROM provided with the kit for the print driver installation procedure.

Installation When Using NetWare

Preparations

Prepare the following items to install the machine when using a NetWare network.

- NetWare server
- TCP/IP or IPX/SPX network environment
- CD-ROM of the Driver CD Kit (provided with the machine)

Installation Overview

To connect the machine to a Netware network, the following configuration must be done:

- Configuration on the Machine
 - To use IPX/SPX, configure the machine using the CD-ROM of the Driver CD Kit after enabling the NetWare port of the machine.
 - To use a LPD port in NDPS, configure the machine using the CD-ROM of the Driver CD Kit after enabling the LPD port of the machine and setting TCP/IP.
- Configuration on the computer
 - Installing a print driver.

Configuration on the Machine

The following describes the configuration procedure to connect the machine to a NetWare network.

Note • The configuration can also be performed using CentreWare Internet Services or IP Address Setting Tool included in the CD-ROM of the Driver CD Kit.

For the items that can be configured using CentreWare Internet Services, refer to "CentreWare Internet Services Setting Items" (P.230).

Using IPX/SPX

- 1** Display the [System Settings] screen.
 - 1) Press the <Log In/Out> button.
 - 2) Enter the user ID with the numeric keypad or a keyboard displayed by pressing [Keyboard], and select [Confirm].

Note • The default user ID is "11111". When using the Authentication feature, a passcode is required. The default passcode is "x-admin".

 - 3) Select [System Settings].
 - 4) Select [System Settings].
- 2** Enable the NetWare port.
 - 1) Select [Network Settings].
 - 2) Select [Port Settings].
 - 3) Select [NetWare], and select [Change Settings].
 - 4) Select [Port Status], and select [Change Settings].

- 5) Select [Enabled], then select [Save].
- 3** Select [Close] repeatedly until the [System Settings] screen is displayed.
- 4** Select [Exit].
- 5** Restart the machine, print a settings list to confirm that the NetWare port is enabled, and check the NetWare device name and the network address.
For information on how to print a settings list, refer to "Print Report/List" (P.97).
- 6** Configure the machine using the CD-ROM of the Driver CD Kit.
Refer to the manual contained in the CD-ROM of the Driver CD Kit for the configuration procedure.

Using a LPD Port in NDPS

- 1** Display the [System Settings] screen.
 - 1) Press the <Log In/Out> button.
 - 2) Enter the user ID with the numeric keypad or a keyboard displayed by pressing [Keyboard], and select [Confirm].

Note • The default user ID is "11111". When using the Authentication feature, a passcode is required. The default passcode is "x-admin".
 - 3) Select [System Settings].
 - 4) Select [System Settings].
- 2** Enable the LPD port.
 - 1) Select [Network Settings].
 - 2) Select [Port Settings].
 - 3) Select [LPD] and then select [Change Settings].
 - 4) Select [Port Status] and select [Change Settings].
 - 5) Select [Enabled] then select [Save].
 - 6) Select [Close] repeatedly until the [Network Settings] screen is displayed.
- 3** Set an IP address.
If an IP address is already set, this step is not necessary. Also, in an environment with DHCP or BOOTP, configure the way to obtain an IP address. Either the address cannot be obtained automatically or manual configuration is preferred, configure an IP address, a subnet mask, and a gateway address.
For information on how to set an IP address, refer to "Protocol Settings" (P.158).
- 4** Select [Close] repeatedly until the [System Settings] screen is displayed.
- 5** Select [Exit].
- 6** Restart the machine, and print a settings list to confirm that the LPD port is enabled and TCP/IP is configured.
For information on how to print a settings list, refer to "Print Report/List" (P.97).
Configure other LPD settings as necessary. Refer to "CentreWare Internet Services Setting Items" (P.230).
- 7** Configure the machine using the CD-ROM of the Driver CD Kit.
Refer to the manual contained in the CD-ROM of the Driver CD Kit for the configuration procedure.

CentreWare Internet Services Setting Items

The items that can be configured using CentreWare Internet Services are as follows. For details on features provided by CentreWare Internet Services, click [Help] in this frame to see the help.

For information on how to start CentreWare Internet Services, refer to "Starting CentreWare Internet Services" (P.214).

- Port Status
- Host Name
- Active Mode
- File Server Name

Note • The File Server Name is set only when the operation mode is in Bindery Service.

- Polling Interval
- Number of Searches
- Password
- TBCP Filter

Note • The TBCP filter is set only when optional Adobe PostScript 3 Kit is installed.

- NDS Tree Name

Note • The tree name is set only when used in the Directory Service.

- NDS Context Name
- Frame Type
- Active Discovery
- Print page buffer of NetWare

Configuration on the Computer

The following describes the configuration procedure for the computer.

In order to print from the machine, the computer needs to have a print driver installed.

For information on the supported operating systems, refer to "Supported Operating Systems" (P.222).

For information on the driver installation procedure, refer to the manual contained in the CD-ROM of the Driver CD Kit.

Installation When Using Microsoft Network (SMB)

Preparations

Prepare the following items to use the machine when using a Microsoft Network (SMB).

- TCP/IP or NetBEUI network environment
- CD-ROM of the Driver CD Kit (provided with the machine)

Installation Overview

The machine can be connected to computers using Microsoft Networks (SMB).

Depending on the network environment, the machine may need to be configured with an IP address, subnet mask and gateway address. Confirm with the network administrator and set up the necessary items.

To connect the machine to Microsoft Network (SMB), the following configuration must be done:

- Configuration on the machine
Enabling the SMB port on the machine and configuring TCP/IP.
- Configuration on the computer
Installing a print driver.

Configuration on the Machine

The following describes the configuration procedure to connect the machine to Microsoft Networks (SMB). First enable the SMB port, then set the TCP/IP settings.

Note • The configuration can also be performed using CentreWare Internet Services or IP Address Setting Tool included in the CD-ROM of the Driver CD Kit.

For the items that can be configured using CentreWare Internet Services, refer to "CentreWare Internet Services Setting Items" (P.232).

- 1 Display the [System Settings] screen.
 - 1) Press the <Log In/Out> button.
 - 2) Enter the user ID with the numeric keypad or a keyboard displayed by pressing [Keyboard], and select [Confirm].

Note • The default user ID is "11111". When using the Authentication feature, a passcode is required. The default passcode is "x-admin".

 - 3) Select [System Settings].
 - 4) Select [System Settings].
- 2 Enable the SMB port.
 - 1) Select [Network Settings].
 - 2) Select [Port Settings].
 - 3) Select [SMB], and select [Change Settings].
 - 4) Select [Port Status], and select [Change Settings].
 - 5) Select [Enabled], then select [Save].
 - 6) Select [Close] repeatedly until the [Network Settings] screen is displayed.

3 Set an IP address.

If an IP address is already set, this step is not necessary. Also, in an environment with DHCP or BOOTP, configure the way to obtain an IP address. Either the address cannot be obtained automatically or manual configuration is preferred, configure an IP address, a subnet mask, and a gateway address.

For information on how to set an IP address, refer to "Protocol Settings" (P.158).

4 Select [Close] repeatedly until the [System Settings] screen is displayed.**5** Select [Exit].**6** Restart the machine, and print a settings list to confirm that the SMB port is enabled and TCP/IP is configured.

For information on how to print a settings list, refer to "Print Report/List" (P.97).

Note • If using the NetBEUI protocol, select [NetBEUI] as the protocol used by SMB for the port configuration using CentreWare Internet Services.

Configure other SMB settings as necessary. Refer to "CentreWare Internet Services Setting Items" (P.232).

CentreWare Internet Services Setting Items

The items that can be configured using CentreWare Internet Services are as follows. For details on features provided by CentreWare Internet Services, click [Help] in this frame to see the help.

For information on how to start CentreWare Internet Services, refer to "Starting CentreWare Internet Services" (P.214).

- Port Status
- Workgroup
- Host Name
- Maximum Number of Sessions
- TBCP Filter

Note • The TBCP filter is set only when optional Adobe PostScript 3 Kit is installed.

- Unicode Support
- Auto Master Mode
- Password Encryption
- Spool Destination for Jobs

Configuration on the Computer

The following describes the configuration procedure for the computer.

In order to print from the machine, the computer needs to have a print driver installed.

For information on the supported operating systems, refer to "Supported Operating Systems" (P.222).

For information on the driver installation procedure, refer to the manual contained in the CD-ROM of the Driver CD Kit.

Installation When Using Internet Printing Protocol (IPP)

Preparations

Prepare the following items to install the machine when using a Internet Printing Protocol (IPP).

- TCP/IP network environment
- CD-ROM of the Driver CD Kit (provided with the machine)

Installation Overview

The machine can be connected to computers using IPP.

To enable Internet Printing (IPP), the following configuration must be done:

- Configuration on the machine
Enabling an IPP port on the machine and configuring TCP/IP.
- Configuration on the computer
Installing a print driver.

Configuration on the Machine

The following describes the configuration procedure to enable Internet Printing (IPP) on the machine. First enable the IPP port, then set the TCP/IP.

Note • The configuration can also be performed using CentreWare Internet Services or IP Address Setting Tool included in the CD-ROM of the Driver CD Kit.

For the items that can be configured using CentreWare Internet Services, refer to "CentreWare Internet Services Setting Items" (P.234).

- 1** Display the [System Settings] screen.
 - 1) Press the <Log In/Out> button.
 - 2) Enter the user ID with the numeric keypad or a keyboard displayed by pressing [Keyboard], and select [Confirm].

Note • The default user ID is "11111". When using the Authentication feature, a passcode is required. The default passcode is "x-admin".

 - 3) Select [System Settings].
 - 4) Select [System Settings].
- 2** Enable the IPP port.
 - 1) Select [Network Settings].
 - 2) Select [Port Settings].
 - 3) Select [IPP], and select [Change Settings].
 - 4) Select [Port Status], and select [Change Settings].
 - 5) Select [Enabled], then select [Save].
 - 6) Select [Close] repeatedly until the [Network Settings] screen is displayed.

- 3** Set an IP address.
If an IP address is already set, this step is not necessary. Also, in an environment with DHCP or BOOTP, configure the way to obtain an IP address. Either the address cannot be obtained automatically or manual configuration is preferred, configure an IP address, a subnet mask, and a gateway address.

For information on how to set an IP address, refer to "Protocol Settings" (P.158).

- 4** Select [Close] repeatedly until the [System Settings] screen is displayed.

- 5** Select [Exit].

- 6** Restart the machine, print a settings list to confirm that the IPP port is enabled, and that TCP/IP is configured.

For information on how to print a settings list, refer to "Print Report/List" (P.97).

Configure other IPP settings as necessary. Refer to "CentreWare Internet Services Setting Items" (P.234).

CentreWare Internet Services Setting Items

The items that can be configured using CentreWare Internet Services are as follows.
For details on features provided by CentreWare Internet Services, click [Help] in this frame to see the help.

For information on how to start CentreWare Internet Services, refer to "Starting CentreWare Internet Services" (P.214).

- Port Status
 - Add Port Number
 - TBCP Filter
- Note** • The TBCP Filter is set only when optional Adobe PostScript 3 Kit is installed.
- Administrator Mode
 - DNS
 - Connection Time-Out
 - Spool Destination for Jobs

Configuration on the Computer

The following describes the configuration procedure for the computer.

In order to print from the machine, the computer needs to have a print driver installed.

For information on the supported operating systems, refer to "Supported Operating Systems" (P.222).

For information on the driver installation procedure, refer to the manual contained in the CD-ROM of the Driver CD Kit.

Installation When Using EtherTalk

Preparations

Prepare the following items to install the machine when using EtherTalk interface.

- EtherTalk network environment
- Adobe PostScript 3 Kit (optional)

Installation Overview

The machine can be connected to computers using an EtherTalk network.

To use EtherTalk, the following configuration must be done:

- Configuration on the machine
Setting EtherTalk on the machine.
- Configuration on the computer
Installing a print driver.

Configuration on the Machine

The following describes the configuration procedure to connect the machine to an EtherTalk network.

Enable the EtherTalk port.

- Note**
- EtherTalk can be configured when Adobe PostScript 3 Kit (optional) is installed.
 - The configuration can also be performed using CentreWare Internet Services.

For the items that can be configured using CentreWare Internet Services, refer to "CentreWare Internet Services Setting Items" (P.236).

- 1** Display the [System Settings] screen.
 - 1) Press the <Log In/Out> button.
 - 2) Enter the user ID with the numeric keypad or a keyboard displayed by pressing [Keyboard], and select [Confirm].

Note

 - The default user ID is "11111". When using the Authentication feature, a passcode is required. The default passcode is "x-admin".
 - 3) Select [System Settings].
 - 4) Select [System Settings].
- 2** Enable the EtherTalk port.
 - 1) Select [Network Settings].
 - 2) Select [Port Settings].
 - 3) Select [EtherTalk], and select [Change Settings].
 - 4) Select [Port Status], and select [Change Settings].
 - 5) Select [Enabled], then select [Save].
- 3** Select [Close] repeatedly until the [System Settings] screen is displayed.
- 4** Select [Exit].

- 5** Restart the machine, and print the settings list to confirm that the EtherTalk port is enabled.

For information on how to print a settings list, refer to "Print Report/List" (P.97).

Configure other EtherTalk settings as necessary. Refer to "CentreWare Internet Services Setting Items" (P.236).

CentreWare Internet Services Setting Items

The items that can be configured using CentreWare Internet Services are as follows.

For details on features provided by CentreWare Internet Services, click [Help] in this frame to see the help.

For information on how to start CentreWare Internet Services, refer to "Starting CentreWare Internet Services" (P.214).

- Port Status
- Printer Name
- Zone Name
- Print Page Buffer of the EtherTalk interface

Configuration on the Computer

The following describes the configuration procedure for the computer.

In order to print from the machine, the computer needs to have a print driver installed.

For information on the supported operating systems, refer to "Supported Operating Systems" (P.222).

For information on how to install a print driver, refer to the manual contained in the CD-ROM included in Adobe PostScript 3 Kit (optional).

9 E-mail Environment Settings

This chapter describes the configuration to use the E-mail features on the machine.

Note • Some models do not support the features described in this chapter. An optional package is necessary. For more information, contact our Customer Support Center.

- E-mail Overview.....238
- Preparations239
- Installation Procedure241

E-mail Overview

The machine is capable of sending and receiving e-mails.

Note • Some models do not support this feature. An optional package is necessary. For more information, contact our Customer Support Center.

The following features are available by sending and receiving e-mails.

- E-mail
- E-mail Printing
- Consumables Status Notice
- Job Completion Notice

E-mail

Scanned documents can be converted into an electronic format, and transmitted via e-mail.

E-mail Printing

E-mail with attachments in either TIFF, JPEG, or PDF format can be sent to the machine from computers. Once the machine receives the e-mail, the machine automatically prints out the attached file.

Contents of e-mail other than its attached file are processed according to the settings specified in [Incoming E-mail Print Options] in CentreWare Internet Services.

Consumables Status Notice

If you configure settings in [Mail Notice Settings] of CentreWare Internet Services, the machine sends out e-mail containing consumable information, such as status of consumables, paper, and replaceable parts to a specified recipient. By receiving the statuses of consumables periodically, you can properly determine when to replace toner and drum cartridges.

As for the recipient of these e-mails, it is recommended that you register the address of a network administrator or a shared address.

Job Completion Notice

When a computer has submitted a print job to the machine, its completion can be notified by e-mail.

Register the address of a network administrator or a shared address as necessary.



Preparations

The following items must be set up to use the e-mail feature.

■ Configuration on the Machine

Item	Description	E-mail		E-mail Printing	Consumables Status Notice	Job Completion Notice
		via SMTP	via POP3			
TCP/IP address	The TCP/IP address for the machine. TCP/IP is used for e-mail.	○	○	○	○	○
Subnet mask	Required when the network is divided into subnets.	△	△	△	△	△
Gateway address	Required when multiple networks are connected by gateways.	△	△	△	△	△
Machine e-mail address	Set the E-mail address for the machine.	○	○	○	○	○
DNS server address	Required when the addresses for a POP3 server and a SMTP server are set with a domain name format instead of their IP addresses. You can also acquire this from DHCP.	△	△	△	△	△
SMTP server address	The machine uses a SMTP server to send e-mails. The SMTP server can also be used for receiving e-mails.	○	○	○	○	○
SMTP AUTH Login Name and password	If an SMTP server requires authentication, specify the authentication user name. Also specify a password as required.	△	△	△	△	△
POP3 server	Set the POP3 server address.	-	○	△	△	△
POP user name and password	Set the POP receiving user address. Also specify a password as required.	-	○	△	△	△
S/MIME settings *	Set the S/MIME information.	△	△	△	×	×

○ : Necessary to set △ : Set as required - : Not required to set × : Not supported

* ApeosPort series models only

■ Configuration on the Server

Information on server settings, contact your System Administrator.

Item	Description	E-mail		E-mail Printing	Consumables Status Notice	Job Completion Notice
		via SMTP	via POP3			
Machine e-mail address	When using the e-mail feature on the machine, an e-mail account of the machine must be registered to a mail server in advance.	○	○	○	○	○
Host Name	You have to set the host name and domain name of the machine along with the TCP/IP address for the machine to the DNS server.	○	○	△	△	△
Domain Name		○	△	△	△	△



Installation Procedure

Installation Overview

This section describes the configuration procedure to use the E-mail feature on the machine.

The following two steps are necessary to use the E-mail feature.

- Enabling port and setting TCP/IP
Set the machine to be able to use TCP/IP.
- Configuring E-mail Environment
Set the items for e-mail on the machine.

Enabling Port and Setting TCP/IP

The following describes the configuration procedure to use TCP/IP on the machine.

First enable the E-mail port, then set the IP address.

Note • The configuration can also be performed using CentreWare Internet Services.

For the items that can be configured using CentreWare Internet Services, refer to "Using CentreWare Internet Services" (P.211).

- 1** Display the [System Settings] screen.
 - 1) Press the <Log In/Out> button.
 - 2) Enter the user ID with the numeric keypad or a keyboard displayed by pressing [Keyboard], and select [Confirm].

Note • The default user ID is "11111". When using the Authentication feature, a passcode is required. The default passcode is "x-admin".
 - 3) Select [System Settings].
 - 4) Select [System Settings].
- 2** Enable a port which is used for the E-mail feature.
 - 1) Select [Network Settings].
 - 2) Select [Port Settings].
 - 3) Select [Send E-mail], and then select [Change Settings].
 - 4) Select [Port Status], and select [Change Settings].
 - 5) Select [Enabled], then select [Save].
 - 6) Select [Close].
 - 7) Enable [Receive E-Mail] in the [Receive E-mail - Port Status] screen as above to use E-mail Printing.
 - 8) Enable [Mail Notice Service] in the [Mail Notice Service - Port Status] screen as above to use mail notice or job completion notice.
 - 9) Select [Close] repeatedly until the [Network Settings] screen is displayed.
- 3** Set an IP address.
If an IP address is already set, this step is not necessary. Also, in an environment with DHCP or BOOTP, configure the way to obtain an IP address. Either the address cannot be obtained automatically or manual configuration is preferred, configure an IP address, a subnet mask, and a gateway address.

For information on how to set an IP address, refer to "Protocol Settings" (P.158).

- 4 Select [Close] repeatedly until the [System Settings] screen is displayed.
- 5 Select [Exit].
- 6 After the machine is restarted, print out a settings list to confirm that the ports are enabled and TCP/IP is configured.

For information on how to print a settings list, refer to "Print Report/List" (P.97).

Configuring E-mail Environment

The following describes the configuration procedure to use the E-mail feature.

Note • The configuration can also be performed using CentreWare Internet Services.

For the items that can be configured using CentreWare Internet Services, refer to "CentreWare Internet Services Setting Items" (P.243).

- 1 Display the [System Settings] screen.
 - 1) Press the <Log In/Out> button.
 - 2) Enter the user ID with the numeric keypad or a keyboard displayed by pressing [Keyboard], and select [Confirm].

Note • The default user ID is "11111". When using the Authentication feature, a passcode is required. The default passcode is "x-admin".

- 3) Select [System Settings].
 - 4) Select [System Settings].
- 2 Set the e-mail address, host name, and domain name.

- 1) Select [Network Settings].
 - 2) Select [Machine's E-mail Address/Host Name].

For information on how to set an e-mail address, refer to "Machine's E-mail Address/Host Name" (P.160).

- 3 Set the protocol for receiving e-mail.
 - 1) Select [Other Settings].
 - 2) Select [E-mail Receive Protocol] and then select [Change Settings].
 - 3) Select either [SMTP] or [POP3] as appropriate for your environment.
 - 4) Select [Save] and then press [Close].
 - 5) Select [Close] repeatedly until the [Network Settings] screen is displayed.

- 4 Set the server address for receiving.
 - 1) Select [E-mail Receive Protocol] and then select [Change Settings].

■If [SMTP] has been selected for [Mail Receive Protocol]

Configure the SMTP server.

For information on how to configure the SMTP server, refer to "SMTP Server Settings" (P.162).

■If [POP3] has been selected for [Mail Receive Protocol]

Configure the POP3 server.

For information on how to configure the POP3 server, refer to "POP3 Server Settings" (P.162).

5 Configure the e-mail transmission.

For information on how to configure the e-mail transmission, refer to "SMTP Server Settings" (P.162).

6 Configure the domain restriction as necessary.

For information on how to configure the domain restriction, refer to "Domain Filter" (P.163).

7 Set the S/MIME information.

- 1) Select [PKI (Public Key) Settings].
- 2) Select [S/MIME Settings] and set the following items.

For information on how to set the S/MIME information, refer to "S/MIME Settings (ApeosPort series models)" (P.168).

8 Select [Close] repeatedly until the [System Settings] screen is displayed.**9** Select [Exit].**10** After the machine is restarted, print a settings list to confirm that each item is configured.

For information on how to print a settings list, refer to "Print Report/List" (P.97).

CentreWare Internet Services Setting Items

The items that can be configured using CentreWare Internet Services are as follows. For details on features provided by CentreWare Internet Services, click [Help] in this frame to see the help.

For information on how to start CentreWare Internet Services, refer to "Starting CentreWare Internet Services" (P.214).

- Port Status
- Machine's E-mail Address
- Mail Notice Settings
- Receiving Protocol
- Domain Filtering
- PKI Settings
- SMTP Server Settings
- POP3 Server Settings

10 Scanner Environment Settings

This chapter describes the configuration to use the scan services on the machine.

Note • Some models do not support the features described in this chapter. An optional package is necessary. For more information, contact our Customer Support Center.

- Scan Service Overview..... 246
- Configuration of Scan to Mailbox..... 247
- Configuration of Network Scanning (Job Template Scanning)..... 249
- Configuration of Scan to PC 251
- Configuration of the Job Flow 253

Scan Service Overview

The machine is equipped with scanning capabilities.

Note • This feature does not appear for some models. An optional package is necessary. For details, contact our Customer Support Center.

Scanning capabilities on the machine allows you to use the following features:

- E-mail
- Scan to Mailbox
- Network Scanning (Job Template Scanning)

Note • This feature is only available for ApeosPort series models.

- Scan to PC
- Job Flow Scanning

Note • This feature is only available for ApeosPort series models.

■E-mail

Scanned documents can be converted into electronic data, and transmitted via e-mail. For information on e-mail environment settings, refer to "E-mail Environment Settings" (P.237).

■Scan to Mailbox

Scan documents that you want to convert into electronic data. Scanned documents are stored into a mailbox, and can be accessed from any computers on the network. For information on configuration to use mailbox, refer to "E-mail Environment Settings" (P.237).

■Network Scanning (Job Template Scanning)

A configuration file defining scanning conditions is called a job template. You can apply a job template to a scanned document on the machine. The scanned document is saved on the machine as a file, and then sent automatically to the computer (server). For information on the configuration to use job template scanning function, refer to "E-mail Environment Settings" (P.237).

■Scan to PC

When the machine is connected to a network, scanned data can be stored on network computers using the FTP or SMB protocol.

Scan documents that you want to convert into electronic data. Scanned documents are stored on network computers.

For information on the configuration to use the Scan to PC feature, refer to "E-mail Environment Settings" (P.237).

■Job Flow Sheets

You can perform scanning using a job flow processing a scanned document from a network computer with CentreWare EasyOperator.

For information on the configuration to use the job flow scanning, refer to "E-mail Environment Settings" (P.237).

Configuration of Scan to Mailbox

Installation Overview

The following is the procedure to use the Scan to Mailbox feature.

■ Enabling port and setting TCP/IP

When using Network Scanner Utility2 (Scan Driver and Mailbox Viewer2) provided by Fuji Xerox, enable a salutation port and configure an IP address.

When using an application supporting a WebDAV protocol provided by Fuji Xerox such as CentreWare EasyOperator, enable a WebDAV port and an Internet Services (HTTP) port, and configure an IP address.

CentreWare EasyOperator enables to obtain documents stored in a mailbox of the machine without a scan driver.

■ Registering a mailbox

Register a mailbox for storing the scanned data.

For information on registering a mailbox, refer to "E-mail Environment Settings" (P.237).

■ Configuring a computer

Install CentreWare EasyOperator or Network Scanner Utility2 on a computer.

CentreWare EasyOperator is stored in the CD-ROM of the Driver CD Kit provided with the machine. For information on the CentreWare EasyOperator installation procedure, refer to the manual contained in the CD-ROM of the Driver CD Kit.

For information on the Network Scanner Utility2 installation procedure, refer to "E-mail Environment Settings" (P.237).

Enabling Port and Setting TCP/IP

First enable ports for Scan to Mailbox (a salutation or WebDAV port and an Internet Services (HTTP) port), and then set the IP address at the control panel of the machine.

Note • The configuration can also be performed using CentreWare Internet Services.

For information on how to use CentreWare Internet Services, refer to "Using CentreWare Internet Services" (P.211).

- 1** Display the [System Settings] screen.
 - 1) Press the <Log In/Out> button.
 - 2) Enter the user ID with the numeric keypad or a keyboard displayed by pressing [Keyboard], and select [Confirm].

Note • The default user ID is "11111". When using the Authentication feature, a passcode is required. The default passcode is "x-admin".
 - 3) Select [System Settings].
 - 4) Select [System Settings].
- 2** Enable the port.
 - When using Network Scanner Utility 2
 - 1) Select [Network Settings].
 - 2) Select [Port Settings].
 - 3) Select [Salutation] and then select [Change Settings].

- 4) Select [Port Status] and select [Change Settings].
- 5) Select [Enabled] then select [Save].
- 6) Select [Close] repeatedly until the [Network Settings] screen is displayed.
 - When using an application supporting a WebDAV protocol provided by Fuji Xerox such as CentreWare EasyOperator
- 1) Select [Network Settings].
- 2) Select [Port Settings].
- 3) Select [WebDAV] and then select [Change Settings].
- 4) Select [Port Status] and select [Change Settings].
- 5) Select [Enabled] then select [Save].
- 6) Select [Close] repeatedly until the [Port Settings] screen is displayed.
- 7) Enable [Internet Services (HTTP)] in the [Internet Services - Port Status] screen as above.
- 8) Select [Close] repeatedly until the [Network Settings] screen is displayed.

3 Set an IP address.

If an IP address is already set, this step is not necessary. Also, in an environment with DHCP or BOOTP, configure the way to obtain an IP address. Either the address cannot be obtained automatically or manual configuration is preferred, configure an IP address, a subnet mask, and a gateway address.

For information on how to set an IP address, refer to "Starting CentreWare Internet Services".

4 Select [Close] repeatedly until the [System Settings] screen is displayed.

5 Select [Exit].

6 After the machine is restarted, print out a settings list to confirm that the salutation or WebDAV port and the Internet Services (HTTP) port are enabled and the IP addresses are configured.

For information on how to print a settings list, refer to "Print Report/List" (P.97).

Configuration of Network Scanning (Job Template Scanning)

Preparations

The following environment is required to use the job template scanning function on the machine.

- Note**
- To use SMB forwarding, your computer must have one of the following operating systems that supports folder sharing.
 - Microsoft Windows 2000
 - Microsoft Windows Server 2003
 - Microsoft Windows XP

Installation Overview

This section describes the configuration procedure to use the job template scanning function on the machine.

The following is the procedure to use the job template scanning.

■ Enabling port and setting TCP/IP

Enable the SNMP port, Internet Services (HTTP) port, and SMB or FTP client port, and then set an IP address on the machine.

■ Configuring the SNMP port

Configure the transport protocol for the SNMP port using CentreWare Internet Services.

■ Configuration on a Computer

For information on how to configure a computer, refer to the online help of CentreWare Internet Services.

Enabling Port and Setting TCP/IP

In order to use Network Scanning feature on the machine, enable the ports and set the IP address. The procedure for setting the machine is as follows.

- Note**
- The configuration can also be performed using CentreWare Internet Services.

For information on how to use CentreWare Internet Services, refer to "Using CentreWare Internet Services" (P.211).

- 1** Display the [System Settings] screen.
 - 1) Press the <Log In/Out> button.
 - 2) Enter the user ID with the numeric keypad or a keyboard displayed by pressing [Keyboard], and select [Confirm].

Note

 - The default user ID is "11111". When using the Authentication feature, a passcode is required. The default passcode is "x-admin".
 - 3) Select [System Settings].
 - 4) Select [System Settings].
- 2** Enable the SNMP port.
 - 1) Select [Network Settings].
 - 2) Select [Port Settings].

- 3) Select [SNMP] and then select [Change Settings].
- 4) Select [Port Status] and select [Change Settings].
- 5) Select [Enabled] then select [Save].
- 6) Select [Close] repeatedly until the [Port Settings] screen is displayed.
- 7) Enable [Port Status] in the [SMB] or [FTP Client] screen, and enable [Internet Services (HTTP)] in the [Internet Services - Port Status] screen as above.
- 8) Select [Close] repeatedly until the [Network Settings] screen is displayed.

3 Set an IP address.

If an IP address is already set, this step is not necessary. Also, in an environment with DHCP or BOOTP, configure the way to obtain an IP address. Either the address cannot be obtained automatically or manual configuration is preferred, configure an IP address, a subnet mask, and a gateway address.

For information on how to set an IP address, refer to "Starting CentreWare Internet Services".

4 Select [Close] repeatedly until the [System Settings] screen is displayed.

5 Select [Exit].

6 After the machine is restarted, print out a settings list to confirm that the ports are enabled and TCP/IP is configured.

For information on how to print a settings list, refer to "Print Report/List" (P.97).

Configuring the SNMP Port

Configure the transport protocol for the SNMP port using CentreWare Internet Services.

1 Start CentreWare Internet Services.

For information on how to start CentreWare Internet Services, refer to "Starting CentreWare Internet Services".

2 Configure the transport protocol for the SNMP port.

- 1) Click the [Properties] tab.
- 2) Click [Port Status].
- 3) Select the [UDP] check box under [SNMP].
- 4) Click [Apply].
- 5) Enter the System Administrator user ID and passcode into [User Name] and [Password], and click [OK].

Note • The default user ID is "11111" and the default passcode is "x-admin".

- 6) The right frame on the web browser will change to the machine reboot display.
- 7) Click [Reboot Machine]. The machine will reboot and the setting value will be reflected.

Configuration of Scan to PC

Preparations

Prepare the following to use the Scan to PC feature.

■Using with FTP

When using with FTP transmission, one of the following FTP servers and an account to FTP servers (login name and password) are required.

- Microsoft Windows Server 2003 or Microsoft Windows Vista
FTP service of Microsoft Internet Information Server 6.0
- Microsoft Windows 2000 Server, Microsoft Windows 2000 Professional, or Microsoft Windows XP
FTP service of Microsoft Internet Information Server 3.0 or later
- Mac OS X
FTP service of Mac OS X 10.3.9/10.4.2/10.4.4
- Novell NetWare
FTP service of NetWare 5.11 or 5.12

Refer to the manual provided with the software for how to configure the FTP service.

■Using with SMB

When using with SMB transmission, a computer running on the following OS which includes a shared folder function is required.

- Microsoft Windows 2000
- Microsoft Windows Server 2003
- Microsoft Windows XP
- Microsoft Windows Vista
- Mac OS X 10.3.9/10.4.x

Installation Overview

The following is the procedure to use the Scan to PC feature.

■Enabling Port and Setting TCP/IP

Enable the FTP port and SMB port, and then set the machine's IP address.

■Configuration on a Computer

Create a folder for transmission destinations on the computer.

- Using with FTP
Create a folder for transmission destinations to the server which log in.
- Using with SMB
Create a folder on the computer and configure it as shared folder.
When using Mac OS X, set [Windows Sharing] to [On] in the [Service] tab of [Sharing] under [System Preferences].

Enabling Port and Setting TCP/IP

In order to use Scan to PC, enable a port (SMB or FTP client) and set the IP address. The procedure for setting the machine is as follows.

Note • The configuration can also be performed using CentreWare Internet Services.

For information on how to use CentreWare Internet Services, refer to "Using CentreWare Internet Services" (P.211).

1 Display the [System Settings] screen.

- 1) Press the <Log In/Out> button.
- 2) Enter the user ID using the numeric keypad or a keyboard displayed by pressing [Keyboard], and select [Confirm].

Note • The default user ID is "11111". When using the Authentication feature, a passcode is required. The default passcode is "x-admin".

- 3) Select [System Settings].

2 Enable the port.

■Using with SMB

- 1) Select [Network Settings].
- 2) Select [Port Settings].
- 3) Select [SMB] and then select [Change Settings].
- 4) Select [Port Status] and then select [Change Settings].
- 5) Select [Enabled] then select [Save].
- 6) Select [Close] repeatedly until the [Port Settings] screen is displayed.

■Using with FTP

- 1) Select [Network Settings].
- 2) Select [Port Settings].
- 3) Select [FTP Client] and then select [Change Settings].
- 4) Select [Port Status] and then select [Change Settings].
- 5) Select [Enabled] then select [Save].
- 6) Select [Close] repeatedly until the [Network Settings] screen is displayed.

3 Set an IP address.

If an IP address is already set, this step is not necessary. Also, in an environment with DHCP or BOOTP, configure the way to obtain an IP address. Either the address cannot be obtained automatically or manual configuration is preferred, configure an IP address, a subnet mask, and a gateway address.

For information on how to set an IP address, refer to "Protocol Settings" (P.158).

4 Select [Close] repeatedly until the [System Settings] screen is displayed.

5 Select [Exit].

6 After the machine is restarted, print out a settings list to confirm that either the SMB port or FTP client port is enabled and the IP addresses are configured.

For information on how to print a settings list, refer to "Print Report/List" (P.97).

Configuration of the Job Flow

Installation Overview

This section describes the configuration procedure to use the job flow scanning on the machine.

The following is the procedure to use the job flow scanning.

■ Enabling Port and Setting TCP/IP

Enable the SOAP, Internet Services (HTTP), and SNMP ports, and then set an IP address on the machine.

■ Configuring the SNMP port

Configure the transport protocol for the SNMP port using CentreWare Internet Services.

■ Configuration on the Computer

Create job flows used for scanned documents.

For details on creating job flows, refer to the manual contained in the CD-ROM of the Driver CD Kit.

Enabling Port and Setting TCP/IP

In order to use the job flow service, enable the SOAP, SNMP, and Internet Services (HTTP) ports, and then set an IP address. The procedure for setting the machine is as follows.

Note • The configuration can also be performed using CentreWare Internet Services.

For information on how to use CentreWare Internet Services, refer to "Using CentreWare Internet Services" (P.211).

- 1** Display the [System Settings] screen.
 - 1) Press the <Log In/Out> button.
 - 2) Enter the user ID with the numeric keypad or a keyboard displayed by pressing [Keyboard], and select [Confirm].

Note • The default user ID is "11111". When using the Authentication feature, a passcode is required. The default passcode is "x-admin".
 - 3) Select [System Settings].
 - 4) Select [System Settings].
- 2** Enable the SOAP port.
 - 1) Select [Network Settings].
 - 2) Select [Port Settings].
 - 3) Select [SOAP] and then select [Change Settings].
 - 4) Select [Port Status] and select [Change Settings].
 - 5) Select [Enabled] and then select [Save].
 - 6) Select [Close] repeatedly until the [Port Settings] screen is displayed.
- 3** Enable the SNMP port.
 - 1) Select [SNMP] and then select [Change Settings].

- 2) Select [Port Status] and select [Change Settings].
 - 3) Select [Enabled] then select [Save].
 - 4) Select [Close] repeatedly until the [Port Settings] screen is displayed.
 - 5) Enable the Internet Services (HTTP) port as above.
 - 6) Select [Close] repeatedly until the [Network Settings] screen is displayed.
- 4** Set an IP address.
If an IP address is already set, this step is not necessary. Also, in an environment with DHCP or BOOTP, configure the way to obtain an IP address. Either the address cannot be obtained automatically or manual configuration is preferred, configure an IP address, a subnet mask, and a gateway address.
For information on how to set an IP address, refer to "Protocol Settings" (P.158).
- 5** Select [Close] repeatedly until the [System Settings] screen is displayed.
- 6** Select [Exit].
- 7** After the machine is restarted, print out a settings list to confirm that the SOAP, SNMP port and the Internet Services (HTTP) port are enabled and the IP addresses are configured.
For information on how to print a settings list, refer to "Print Report/List" (P.97).

Configuring the SNMP Port

Configure the transport protocol for the SNMP port using CentreWare Internet Services.

- 1** Start CentreWare Internet Services.

For information on how to start the CentreWare Internet Services, refer to "Starting CentreWare Internet Services" (P.214).

- 2** Configure the transport protocol for the SNMP.

- 1) Click the [Properties] tab.
- 2) Click [Port Status].
- 3) Select the [UDP] check box under [SNMP].
- 4) Click [Apply].
- 5) Enter the System Administrator user ID and passcode into [User Name] and [Password], and click [OK].

Note • The default user ID is "11111" and the default passcode is "x-admin".

- 6) The right frame on the web browser will change to the machine reboot display.
- 7) Click [Reboot Machine]. The machine will reboot and the setting value will be reflected.

11 Using the Server Fax Service

This chapter describes how to use the Server Fax service on the machine.

- Server Fax Overview256
- Preparations257
- Installation Procedure258

Server Fax Overview

If your machine supports the scan feature, installing the Server Fax Kit (optional) allows you to use the fax feature of a Server Fax server.

With this Server Fax feature, you can transfer image data received by the machine to the Server Fax server, and can transfer image data received by the Server Fax server to the machine via a network based on the settings you made.

Preparations

The following describes the necessary conditions to use Server Fax on the machine.

System Requirements for the Machine

- Scanner Kit needs to be installed on the machine.
- Server Fax Kit needs to be installed on the machine.
- The machine needs to be connected to a network and needs to support TCP/IP communication.
- A Server Fax server needs to be installed on the network.

Installation Procedure

Installation Overview

This section describes the configuration procedure to use the Server Fax feature on the machine.

The following is the procedure to use the Server Fax feature.

- Enabling the port and setting TCP/IP

Enable the port which are to be used for the Server Fax feature, and set an IP address of the machine.
- Setting the protocol

For the SMB and FTP protocols, refer to "Configuration of Scan to PC" (P.251).
For the SMTP protocol, refer to "E-mail Environment Settings" (P.237).
- Setting the Server Fax feature

Enable the Server Fax service and set the repository.

Setting the Server Fax Feature

Enable the Server Fax feature and set the file destination. The following procedure explains how to set them on CentreWare Internet Services.

For information on how to use CentreWare Internet Services, refer to "Using CentreWare Internet Services" (P.211).

- 1** Start a web browser.
 - 2** Enter the machine's IP address or the Internet address to the address box on the browser, and press the <Enter> key.
 - Example of the IP address entry
http://192.168.1.1/
 - Example of the Internet address entry
http://myhost.example.com/
- Note** • When specifying a port number, add ":" and the port number to the end of the Internet address.
- 3** Click the [Properties] tab.
 - 4** Click [+] on the left of [Protocol Settings] to display the items in the folder.
 - 5** Click [+] on the left of [Fax] to display the items in the folder.
 - 6** On the tree in the left frame, click [General].
 - 7** On the [General] screen, set [Scan File Transfer Report] under [Fax].
 - 8** Set [Optional Information] under [Job Log].
 - 9** Click [Apply] to reflect the settings.
 - 10** On the tree in the left frame, click [Fax Repository Setup].
 - 11** On the [Fax Repository Setup] screen, set the items under [Fax Destination].
 - 12** Select a protocol.

- Note**
- When [FTP] or [SMB] is selected, faxes will be sent to the destination specified under [File Destination]. When [SMTP] is selected, faxes will be sent to the destination specified in the E-mail settings.

For details on this setting, refer to CentreWare Internet Services help.

■ When [FTP] or [SMB] is selected

Set the repository server that is to be used for the Server Fax feature.

- IP Address/Host Name and Port (If the port number is blank, FTP:21 or SMB:131 will be used.)
- Share (SMB only)
- Document Pass
- Login Name
- Password
- Retype Password

■ When SMTP is selected

The SMTP server settings are the same as the E-mail settings.

For details on the SMTP server settings, refer to "E-mail Environment Settings" (P.237).

The following settings are additionally required for the SMTP server.

- Domain Name
- E-mail Address Display Format

13 Click [Apply] to reflect the settings.

For information on how to print a settings list, refer to "Print Report/List" (P.97).

12 Security

This chapter describes the configuration to utilize the security services on the machine.

- Security Service Overview 262
- Configuration of HTTP Communication Encryption 264
- Configuration of E-mail Encryption/Digital Signature 266
- Configuration of Scan File Signature (PDF/DocuWorks Signature) for Only ApeosPort Series Models 273

Security Service Overview

Communication Security Service

The communication data between the machine and computers on a network can be encrypted. For information on how to encrypt data, refer to the CentreWare Internet Services online help.

■ Encryption of the HTTP Communication from a Client to the Machine (SSL/TLS Server)

The SOAP port, Internet Services (HTTP) port, IPP port, and WebDAV port use the HTTP server of the machine.

The SSL/TLS protocol is used to encrypt the HTTP communication from a client to the machine.

Registered certificates or certificates created by CentreWare Internet Service can be used as SSL/TLS certificates used on the SSL/TLS server.

- Note**
- When using certificates that have already been created, import them with CentreWare Internet Services.
 - By enciphering HTTP communication, communication data can be enciphered at the time of printing using IPP (SSL encrypted communication).
 - Certificates created by CentreWare Internet Services are valid for three years.

■ Encryption of the HTTP Communication from the Machine to a Remote Server (SSL/TLS Client)

The SSL/TLS protocol is used to encrypt the HTTP communication with a remote server.

No certificates are required in general. However, if a remote server is set to require a SSL client certificate, a SSL/TLS certificate must be registered from CentreWare Internet Services to the machine.

When verification of server certificates is enabled to verify a remote server, the root certificate of the remote server must be registered from CentreWare Internet Services to the machine to verify the SSL/TLS certificate of the remote server.

- Note**
- When using certificates that have already been created, import them with CentreWare Internet Services.
 - Certificates created by CentreWare Internet Services are valid for 3 years.

■ E-mail Encryption/Digital Signature

S/MIME is used for E-mail Encryption/Digital Signature. To use S/MIME on the machine, S/MIME certificates are used.

Registered certificates can be used as S/MIME certificates.

A device certificate or a personal certificate is required on a recipient to encrypt e-mail.

No settings are required on a recipient computer.

- Note**
- When using certificates that have already been created, import them with CentreWare Internet Services.
 - Certificates created by CentreWare Internet Services are valid for 3 years.

Scan File Security Services

■ Encryption/Digital Signature of PDF/DocuWorks Documents (ApeosPort Series Models Only)

PDF and DocuWorks documents can be encrypted and protected by password. Digital signatures are also available for PDF and DocuWorks documents.

For information on how to encrypt PDF and DocuWorks documents, refer to "4 Scan" > "General Settings" > "File Format (Selecting the Format of Scanned Data)" in the User Guide.

To use digital signature, device certificate is required.

Registered certificates can be used as Device Certificates.

- Important**
- When using certificates that have already been created, import them with CentreWare Internet Services.
 - Certificates created by CentreWare Internet Services are valid for 3 years.

Configuration of HTTP Communication Encryption

Installation Overview

The following is the procedure for HTTP Communication Encryption.

■ Configuration on the Machine

Configure a certificate to the machine. No certificate is imported on the machine in the default settings. Import certificates for a SSL server as needed.

The following is the methods to set a certificate.

- Configuring certificates by CentreWare Internet Services

Two methods are available depending on types of certificates.

- Create a self-certificate on the machine, and enable HTTPS.
- Enable HTTPS, and import a created certificate on the machine.

■ Configuration on a Computer

When encrypting communication between a web browser and the machine, enter an address beginning with "https" instead of "http" into the address box in the web browser.

- Example of the IP address entry
https://192.168.1.1/
- Example of the Internet address entry
https://myhost.example.com

When encrypting the IPP communication (Internet printing), enter an address beginning with "https" instead of "http" as the URL of a printer that is selected from [Add Printer] in order to add a printer.

For detail information on the settings, refer to the manual in the CD-ROM of the Driver CD Kit.

No settings are needed to use the SOAP port and WebDAV port.

Configuration on the Machine

Two methods are available to configure certificates by CentreWare Internet Services: creating a self-certificate (for SSL server), and importing a created certificate on the machine.

This section describes how to create a self-certificate (for SSL server).

Important • When performing SSL communication using a self-certificate created on the machine, or a certificate with which the character code is indicated by UTF-8, the following phenomena occur.

- SSL connection will not be made if Internet Explorer is used with Mac OS X 10.3.9 or later. This is because the operating system cannot recognize the character code (UTF-8) of the certificate. Use Netscape 7 in the above-mentioned OS environments.

For information on how to import created certificates, refer to the CentreWare Internet Services online help.

Important • When importing a certificate, if the same certificate has been already registered in [Local Device] or [Others], the certificate cannot be imported. Delete the registered certificate before importing.

For information on how to use CentreWare Internet Services, refer to Using CentreWare Internet Services (P.211).

1 Start CentreWare Internet Services.

For information on how to start CentreWare Internet Services, refer to Starting CentreWare Internet Services (P.214).

2 Generate a certificate.

- 1) Click the [Properties] tab.
- 2) Click [+] on the left of [PKI Settings] to display the items in the folder.
- 3) Click [SSL/TLS Settings].
- 4) Click the [Generate Self-Signed Certificate] button.
- 5) Set [Public Key Size] as necessary.
- 6) Set [Issuer] as necessary.
- 7) Click the [Generate Certificate] button. When a screen to enter the user name and passcode appears, enter the System Administrator user ID and passcode into [User Name] and [Password], and then click [OK].

Note • The default user ID is "11111" and the default passcode is "x-admin".

- 8) Refresh the web browser.

3 Set the SSL/TLS information.

- 1) Click [+] on the left of [PKI Settings] to display the items in the folder.
- 2) Click [SSL/TLS Settings].
- 3) Select the [Enable] check box for [HTTP - SSL/TLS Communication].
- 4) Set [SSL/TLS Port Number].

Note • Do not use the numbers of any other ports.

- 5) Click [Apply].
- 6) When the right frame on the web browser will change to the machine reboot display, click [Reboot Machine]. The machine will reboot and the setting values will be reflected.

Configuration of E-mail Encryption/Digital Signature

Installation Overview

The following is the procedure for E-mail Encryption/Digital Signature.

■ Configuration on the Machine

Configure a certificate to the machine. No certificate is imported on the machine in the default settings.

■ Configuration on a Computer

Prepare a certificate that is suitable for E-mail Encryption/Digital Signature.

Configuration on the Machine

To configure certificates by CentreWare Internet Services, first encrypt HTTP communication, import a created certificate to the machine, and then enable S/MIME. For information on the settings for encrypting HTTP communication, refer to Configuration of HTTP Communication Encryption (P.264)

1 Start CentreWare Internet Services.

For information on how to start CentreWare Internet Services, refer to Starting CentreWare Internet Services (P.214).

2 Import a certificate.

- 1) Click the [Properties] tab.
- 2) Confirm that [Machine's E-mail Address] of [Description] is filled.
- 3) Click [+] on the left of [PKI Settings] to display the items in the folder.
- 4) Click [Certificate Management].

Important • When importing a certificate, if the same certificate has been already registered in [Local Device] or [Others], the certificate cannot be imported. Delete the registered certificate before importing.

- 5) Enter [Password].
- 6) Enter [Re-enter Password].
- 7) Enter a file name you want to import. Or select a file to be imported from a dialog box displayed by clicking the [Browse] button and then click [Save].
- 8) Click the [Import] button. When a screen to enter the user name and passcode appears, enter the System Administrator user ID and passcode into [User Name] and [Password], and then click [OK].

Note • The default user ID is "11111" and the default passcode is "x-admin".

- 9) Refresh the web browser.

3 Configure the certificate.

- 1) Click [+] on the left of [PKI Settings] to display the items in the folder.
- 2) Click [Certificate Management].
- 3) Select [Local Device] for [Category], [S/MIME] for [Certificate Purpose], and then click the [Display the List] button.
- 4) Select the owner of the certificate to be set.

- 5) Click the [Certificate Details] button.
 - 6) Click the [Use this Certificate] button.
 - 7) Click [Reboot Machine]. The machine will reboot and the setting values will be reflected.
 - 8) Refresh the web browser.
- 4** Enable [S/MIME Communication].
- 1) Click [+] on the left of [PKI Settings] to display the items in the folder.
 - 2) Click [SSL/TLS Settings].
 - 3) Select the [Enable] check box for [S/MIME Communication].
 - 4) Click [Apply].
 - 5) When the right frame on the web browser will change to the machine reboot display, click [Reboot Machine]. The machine will reboot and the setting values will be reflected.
 - 6) Refresh the web browser.
- 5** Configure the settings for S/MIME.
- 1) Click [+] on the left of [PKI Settings] to display the items in the folder.
 - 2) Click [S/MIME Settings] and set the following items.
 - Message Digest Algorithm
Select a message digest algorithm from [SHA1] or [MD5].
 - Contents Encryption Method
Select the e-mail content encryption method from [3DES], [RC2-40], [RC2-64], or [RC2-128] when sending an e-mail from the machine.
 - Certificate Auto Store
Select whether to automatically store the certificate when receiving e-mail with a S/MIME certificate sent from an address registered in the address book.
 - Receive untrusted e-mail
Set whether or not to receive untrusted e-mail with no certificate attached.
 - Digital Signature - Outgoing E-mail
Set whether to always attach a digital signature to e-mail or to select a digital signature when sending e-mail from this machine.
 - 3) Click [Apply] button.

Configuration on a Computer

The following describes the configuration for a computer.

■ Sending scanned data by S/MIME encrypted e-mail from the machine to a computer

It is necessary to register a personal certificate of a sender's e-mail address on the machine.

When registering a personal certificate on the machine, a root certificate should be included in the personal certificate.

For information on how to import a certificate, refer to the CentreWare Internet Services online help.

■ Sending e-mail with S/MIME digital signature from the machine to a computer

No settings are required on a recipient computer.

■ Sending S/MIME encrypted e-mail by e-mail printing from a computer to the machine

It is necessary to register a S/MIME certificate of the machine on the computer.

There are two methods to set a S/MIME certificate of the machine to the computer:

- Sending e-mail with S/MIME digital signature from the machine to the computer
To send e-mail with a S/MIME digital signature from the machine, configure to attach digital signature when sending e-mail in the [Digital Signature - Outgoing E-mail] settings.
- Exporting a S/MIME certificate to the computer using CentreWare Internet Services and registering the exported S/MIME certificate in a certificate store of an e-mail application

For information on how to export a certificate, refer to the CentreWare Internet Services online help. For information on how to register a certificate in an e-mail application, refer to manuals provided with the application.

■ Sending e-mail with S/MIME digital signature from a computer to the machine

It is necessary to register a personal certificate of a sender's e-mail address, an intermediate certificate authority certificate of the personal certificate, and a root certificate to the machine.

For information on how to import a certificate, refer to the CentreWare Internet Services online help.

■ Supported e-mail applications

E-mail applications that can send and receive e-mail to and from the machine are as follows:

- Outlook 2000/2002/2003
- Outlook Express 6
- Netscape 7.x

Configuration of Scan File Signature (PDF/DocuWorks Signature) for Only ApeosPort Series Models

Installation Overview

Use the following procedure to affix a signature (PDF signature/DocuWorks signature) to a scanned document to send as a PDF or DocuWorks document.

■ Configuration on the Machine

Register a certificate to the machine. No certificate is imported on the machine in the default settings.

■ Configuration on a Computer

- Sending a DocuWorks security certificate file from the machine to a computer

It is necessary to register a personal certificate of a person to whom the data is disclosed on the machine, and then register the certificate to the address book.

When registering a personal certificate on the machine, the root certificate should be included in the personal certificate.

For information on how to import a certificate, refer to the CentreWare Internet Services online help.

- Sending a PDF or DocuWorks signature file from the machine to a computer
Confirm if the root certificate of the certificate for the scan file signature of the machine is registered on the recipient's computer.

Configuration on the Machine

To configure certificates by CentreWare Internet Services, first encrypt HTTP communication, import a created certificate to the machine, and then set it as scan file certificate.

For information on the settings for encrypting HTTP communication, refer to Configuration of HTTP Communication Encryption (P.264).

1 Start CentreWare Internet Services.

For information on how to start the CentreWare Internet Services, refer to Starting CentreWare Internet Services (P.214).

2 Import a certificate.

Important • When importing a certificate, if the same certificate has been already registered in [Local Device] or [Others], the certificate cannot be imported. Delete the registered certificate before importing.

- 1) Click the [Properties] tab.
- 2) Click [+] on the left of [PKI Settings] to display the items in the folder.
- 3) Click [Certificate Management].
- 4) Enter [Password].
- 5) Enter [Re-enter Password]
- 6) Enter a file name you want to import. Or select a file to be imported from a dialog box displayed by clicking the [Browse] button and then click [Save].

- 7) Click the [Import] button. When a screen to enter the user name and passcode appears, enter the System Administrator user ID and passcode into [User Name] and [Password], and then click [OK].

Note • The default user ID is "11111" and the default passcode is "x-admin".

- 8) Refresh the web browser.

3 Configure the certificate.

- 1) Click [+] on the left of [PKI Settings] to display the items in the folder.
- 2) Click [Certificate Management].
- 3) Select [Local Device] for [Category], [Scan File] for [Certificate Purpose], and then click the [Display the List] button.
- 4) Select the owner of the certificate to be set.
- 5) Click the [Display Certificate] button.
- 6) Click the [Select Certificate] button.
- 7) Click [Reboot Machine]. The machine will reboot and the setting values will be reflected.
- 8) Refresh the web browser.

4 Configure the settings for PDF Signature/DocuWorks Signature.

- 1) Click [+] on the left of [PKI Settings] to display the items in the folder.
- 2) Click [PDF/DocuWorks Security/Settings] and then set the following items.
 - PDF Signature
Select the setting for PDF Signature from [Do not add signature], [Always add visible signature], [Always add invisible signature], or [Select during send].
 - DocuWorks Signature
Select the setting for DocuWorks Signature from [Do not add signature], [Always add signature], or [Select during send].
- 3) Click [Apply].

13 Authentication and Auditron Administration

The machine has the Authentication feature that allows you to restrict the use of features and the Auditron Administration feature that allows you to keep track of how often each feature was used.

- Overview of Authentication272
- Authentication for Job Flow Sheets and Mailboxes275
- Overview of Auditron Administration.....282

Overview of Authentication

This section is an overview of the Authentication feature used with the machine.

Users Controlled by Authentication

The following explains the types of users controlled with the Authentication feature. Users are classified into the following four categories. The machine restricts user operations according to the categories.

- System Administrators
- Authenticated Users
- Unauthenticated Users
- General Users

System Administrators

These are users who can register and change system settings.

A system administrator uses a specific user ID called System Administrator ID.

To enter the System Administration mode, type the System Administrator ID into the user ID entry field on the authentication screen.

Authenticated Users

These are users who are registered on the machine.

When using a restricted service, an authenticated user is prompted to type the user ID and passcode on the authentication screen.

Unauthenticated Users

These are users who are not registered with the machine.

An unauthenticated user cannot use restricted services.

General Users

These are users who are not permitted to use the machine in the authentication mode.

Types of Authentication

Authentication is carried out using a user ID registered on the machine or a user ID registered on a remote accounting server.

The following four different authentication methods are offered according to the registration condition of user information.

■ Local machine authentication

Local machine authentication uses the user information registered on the machine to manage authentication.

The print from a computer can be received on the machine after being authenticated by cross-checking the authentication information pre-configured on a client's driver with that registered on the machine.

For information on configuring driver, refer to the online help provided for the driver.

■ Network authentication

Network authentication uses the user information managed on a remote service to manage authentication.

User information managed on the remote service is sent to be registered on the machine. When the user information on the remote service is updated, the updated information must be sent from the remote service to the machine.

Network Authentication allows an unified management of user information for multiple devices.

Remote services supported by the machine include ApeosWare EasyAdmin.

■ Remote authentication

Remote authentication uses a remote authentication server. User information is not required to be registered on the machine.

Important • When registering user information on a remote authentication server, use up to 32 characters for a user ID and up to 128 characters for a password. Note, however, that up to 32 characters are allowed for an SMB authentication password.

■ Xerox Standard Accounting

Authentication is carried out using the user information and account information pre-registered on the machine. The print data sent directly from a computer can be received on the machine after being authenticated by cross-checking the pre-registered authentication information on the client's driver with the one registered on the machine. For information on the print driver, refer to the online help of the driver. For information on the user information settings or account information settings, refer to the online help of CentreWare Internet Services.

Important • When setting the user information or account information for another ApeosPort-II C7500/C6500/C5400 or DocuCentre-II C7500/C6500/C5400, it is recommended to use the Cloning feature of the CentreWare Internet Services. For more information, refer to the online help of CentreWare Internet Services.

Features Controlled by Authentication

This section describes the features that are controlled by using the Authentication feature.

The controlled features are different depending on how the machine is used.

The machine can be used in the following two conditions.

- Local Access
- Remote Access

For information on the mailbox and job flow sheet restrictions that are applied when the Authentication feature is enabled, refer to "Authentication for Job Flow Sheets and Mailboxes" (P.275).

Local Access

Local access refers to direct operation from the machine's control panel.

The following features are controlled by local access.

■ Copy

Copy operations are restricted.

When a copy operation is registered in a stored program, the use of the stored program is also restricted.

■ Scan

The E-mail, Scan to Mailbox, and Scan to PC features are restricted.

When the E-mail, Scan to Mailbox, or Scan to PC service is registered in a stored program, the use of the stored program is also restricted.

■ Mailbox

Even if the Login Setup/Auditron Administration feature is not used for the copy, scan, or print service, authentication is required for the mailbox operations when the Authentication feature is used on the machine.

■ Job Flow Sheet

Even if the Login Setup/Auditron Administration feature is not used for the copy, scan, or print service, authentication is required for the job flow sheet operations when the Authentication feature is used on the machine.

■ Print

Printing operations for documents stored on the machine are restricted.

The printing operations include Charge Print and Private Charge Print.

Remote Access

Remote access refers to remote operation by accessing the machine using CentreWare Internet Services or EasyOperator/EasyAdmin through a network.

The following features are controlled by remote access.

■ Print

Print instructions from a computer are restricted.

To use the Authentication feature, authentication information such as a user ID and passcode must be set on the print driver.

Print data that was sent to the machine and failed authentication is either stored on the machine or deleted, according to the Charge Print settings.

Note • Print operations are not restricted when [Login/Setup Auditron Mode] under [System Settings] is set to [Remote Access].

For information about [Login/Setup Auditron Mode], refer to "Login/Setup Auditron Mode".

■ CentreWare Internet Services

Even if the Login Setup/Auditron Administration feature is not used for the copy, scan, or print service, authentication is required to access the machine with a web browser when the Authentication feature is used on the machine.

Note • Only the system administrators are authenticated when [Login/Setup Auditron Mode] under [System Settings] is set to [Remote Access]. CentreWare Internet Services is not available for general users.

For information about [Login/Setup Auditron Mode], refer to "Login/Setup Auditron Mode".

■ EasyOperator/EasyAdmin

Even if the Login Setup/Auditron Administration feature is not used for the copy, scan, or print services, authentication is required to access the machine when the Authentication feature is used on the machine.

Note • Only the system administrators are authenticated when [Login/Setup Auditron Mode] under [System Settings] is set to [Remote Access]. EasyOperator/EasyAdmin is not available for general users.

For information about [Login/Setup Auditron Mode], refer to "Login/Setup Auditron Mode".

Authentication for Job Flow Sheets and Mailboxes

This section describes job flow sheet and mailbox restrictions that are applied when the Authentication feature is enabled.

Job Flow Sheet Types

The following four types of job flow sheets are available for the machine.

- Important**
- You can create job flow sheets for mailbox operations on the machine. Job flow sheets for scanner operations can be created on a network-connected computer using software such as EasyOperator.
 - The job flow sheets created on a network-connected computer cannot be edited or copied on the machine.

■ General Shared Job Flow Sheet

This is a job flow sheet created on the [Job Flow Sheets] screen by a general user when the Authentication feature is disabled.

When the Authentication feature is disabled, this type of job flow sheet can be shared and its settings can be changed by any machine user.

When the Authentication feature is enabled, this type of job flow sheet can only be handled by a system administrator.

■ Mailbox Job Flow Sheet

This is a job flow sheet created by a general user or a system administrator on the [Mailbox] or [Send from Mailbox] screen when the Authentication feature is disabled.

The owner of the job flow sheet is the "mailbox" it was created from. For example, the owner of a job flow sheet created in Mailbox 001 will be "Mailbox 001", and the job flow sheet can be used only in Mailbox 001.

Any users who have access to the mailbox upon the job flow sheet creation can use the job flow and change its settings.

This job flow sheet can be used by any machine users when the Authentication feature is disabled. When the Authentication feature is enabled, this job flow sheet can be handled only by the system administrator.

■ Administrator Shared Job Flow Sheet

This is a job flow sheet created by a system administrator.

When the Authentication feature is disabled, any machine users can use this type of job flow sheet.

When the Authentication feature is enabled, any machine's authenticated user can use the job flow sheet.

Only the system administrator, however, can change its settings.

To create a job flow sheet shared by system administrators, you need to select the <Log In/Out> button and operate the machine as a system administrator.

■ Personal Job Flow Sheet

This is a job flow sheet created by an authenticated user when the Authentication feature is enabled.

When the Authentication feature is enabled, this type of job flow sheet is available for the authenticated user who created the job flow sheet and by a system administrator.

When the Authentication feature is disabled, this job flow sheet can be handled only by the system administrator.

The available operations for job flow sheets are different depending on whether the Authentication feature is enabled or disabled.

When the Authentication Feature is not Enabled

When the Authentication feature is not enabled, the relations between users and job flows are as follows.

The available job flow sheet operations are different between the job flow sheets created on the [Mailbox] screen under [Setup Menu] or the [Send from Mailbox] screen and those created on the [Job Flow Sheets] screen under [Setup Menu].

■[Mailbox] under [Setup Menu]/[Send from Mailbox]

The following table describes the operations that can be performed on the [Mailbox] screen under [Setup Menu] or on the [Send from Mailbox] screen.

Job Flow operation	General Users				System Administrators			
	General shared	Mailbox	Admin shared	Personal	General shared	Mailbox	Admin shared	Personal
Create/Register	-	○	-	-	-	-	○	-
Display	○	○	○	-	○	○	○	○
Edit	○	○	-	-	○	○	○	○
Copy *	○	○	○	-	○	○	○	○
Delete	○	○	-	-	○	○	○	○
Select/Run	○	○	○	-	○	○	○	○
Link to mailbox	○	○	○	-	○	○	○	○

*The owner of a copied job flow sheet is the user who made the copy.

Important • A job flow sheet created on the [Mailbox] screen under [Setup Menu] or on the [Send from Mailbox] screen can be edited, copied, deleted, or selected/run only from the mailbox where the job flow sheet was created. The applicable users are all users who can use the mailboxes.

- If job flow sheets, which are no longer available for use due to a change in the authentication status, are linked to mailboxes, they cannot be edited or copied, but still can be used. If you cancel the links, however, the job flow sheets will no longer be displayed and will be unavailable.

■[Job Flow Sheets] under [Setup Menu]

The following table describes the operations that can be performed on the [Job Flow Sheets] screen under [Setup Menu].

Job Flow operation	General Users				System Administrators			
	General shared	Mailbox	Admin shared	Personal	General shared	Mailbox	Admin shared	Personal
Create/Register	○	-	-	-	-	-	○	-
Display	○	-	○	-	○	○	○	○
Edit	○	-	-	-	○	○	○	○
Copy *	○	-	○	-	○	○	○	○
Delete	○	-	-	-	○	○	○	○
Select/Run	○	-	○	-	○	○	○	○

*The owner of a copied job flow sheet is the user who made the copy.

When the Authentication Feature is Enabled

When the Authentication feature is enabled, the relations between users and job flows are as follows.

The same operations can be permitted on the [Mailbox] and [Job Flow Sheets] screens. For information on the Authentication feature, refer to "Login Setup/Auditron Mode" (P.209).

■When [Local Machine Access] or [Xerox Standard Accounting] is selected, when [Check User Details] is set to [On] in [Network Access], or when authenticated as a user other than a guest user in [Remote Access]

Important • If authenticated as a guest user in [Remote Access], you are treated as an unauthenticated user (general user) and cannot handle job flow sheets.

Job flow operation	Unauthenticated Users (General Users)				Authenticated Users					System Administrators			
	General shared	Mailbox	Admin shared	Personal	General shared	Mailbox	Admin shared	Personal (owner)	Personal (Non-owner)	General shared	Mailbox	Admin shared	Personal
Create/ Register	-	-	-	-	-	-	-	○	-	-	-	○	-
Display	-	-	-	-	-	-	○	○	-	○	○	○	○
Edit	-	-	-	-	-	-	-	○	-	○	○	○	○
Copy *	-	-	-	-	-	-	○	○	-	○	○	○	○
Delete	-	-	-	-	-	-	-	○	-	○	○	○	○
Select/ Run	-	-	-	-	-	-	○	○	-	○	○	○	○
Link to Mailbox	-	-	-	-	-	-	○	○	-	○	○	○	○

*The owner of a copied job flow sheet is the user who made the copy.

■When [Check User Details] under [Network Access] is set to [Off (Keep logon records)]

Job flow operation	Unauthenticated Users (General Users)				Authenticated Users					System Administrators			
	General shared	Mailbox	Admin shared	Personal	General shared	Mailbox	Admin shared	Personal (owner)	Personal (Non-owner)	General shared	Mailbox	Admin shared	Personal
Create/ Register	-	-	-	-	○	-	-	-	-	-	-	○	-
Display	-	-	-	-	○	-	○	-	-	○	○	○	○
Edit	-	-	-	-	○	-	-	-	-	○	○	○	○
Copy *	-	-	-	-	○	-	○	-	-	○	○	○	○
Delete	-	-	-	-	○	-	-	-	-	○	○	○	○
Select/ Run	-	-	-	-	○	-	○	-	-	○	○	○	○
Link to Mailbox	-	-	-	-	○	-	○	-	-	○	○	○	○

*The owner of a copied job flow sheet is the user who made the copy.

Types of Mailboxes

The following three types of mailboxes can be used with the machine.

■ General Shared Mailbox

This is a mailbox created by a general user when the Authentication feature is not enabled.

When the Authentication feature is not enabled, this mailbox is shared and its settings can be changed by any user.

When the Authentication feature is enabled, this mailbox can only be handled by a system administrator.

■ Administrator Shared Mailbox

This is a mailbox created by a system administrator.

When the Authentication feature is not enabled, this mailbox can be shared by all users. When the Authentication feature is enabled, this mailbox can be shared by all authenticated users.

Only a system administrator, however, can change the settings.

To create a administrator shared mailbox, you need to press the <Log In/Out> button and operate the machine as a system administrator.

■ Personal Mailbox

This is a mailbox created by an authenticated user when the Authentication feature is enabled.

Only the authenticated user who created it can use it.

When the Authentication feature is not enabled, this mailbox can only be handled by a system administrator.

The ways you can use mailboxes differ depending on whether the Authentication feature is enabled.

When the Authentication Feature is not Enabled

When the Authentication feature is not enabled, the relations between users and mailboxes are as follows.

Mailbox operation	General Users			System Administrators		
	General shared	Admin shared	Personal	General shared	Admin shared	Personal
Create/Register	○	-	-	-	○	-
Display	○	○	-	○	○	○
Delete	○	-	-	○	○	○
Change Settings	○	-	-	○	○	○
Display Document	○	○	-	○	○	○
Delete Document	○	○	-	○	○	○
Register Document *	○	○	-	○	○	○
Output Document *	○	○	-	○	○	○
Job Flow Sheet	Display	○	○	-	○	○
	Link	○	-	-	○	○
	Auto Start	○	○	-	○	○
	Manual Run	○	○	-	○	○

- * The following operations are not authenticated:
 - Document retrieval using a scan driver or Mailbox Viewer2.

Important • If job flow sheets, which are no longer available for use due to a change in the authentication status, are linked to mailboxes, they cannot be edited or copied, but still can be used. If you cancel the links, however, the job flow sheets will no longer be displayed and will be unavailable.

When the Authentication Feature is Enabled

When the Authentication feature is enabled, the relations between users and mailboxes are as follows.

For information on the Authentication feature, refer to "Login Setup/Auditron Mode" (P.209).

■When [Local Machine Access] or [Xerox Standard Accounting] is selected, when [Check User Details] is set to [On] in [Network Access], or when authenticated as a user other than a guest user in [Remote Access]

Important • If authenticated as a guest user in [Remote Access], you are treated as an unauthenticated user (general user) and cannot handle mailboxes.

Mailbox operation	Unauthenticated Users (General Users)			Authenticated Users				System Administrators		
	General shared	Admin shared	Personal	General shared	Admin shared	Personal (owner)	Personal (Non-owner)	General shared	Admin shared	Personal
Create/Register	-	-	-	-	-	○	-	-	○	-
Display	-	○ ^{*2}	-	-	○	○	-	○	○	○
Delete	-	-	-	-	-	○	-	○	○	○
Change Settings	-	-	-	-	-	○	-	○	○	○
Display Document	-	○ ^{*2}	-	-	○	○	-	○	○	○
Delete Document	-	○ ^{*2}	-	-	○	○	-	○	○	○
Register Document ^{*1}	-	○ ^{*2}	-	-	○	○	-	○	○	○
Output Document ^{*1}	-	○ ^{*2}	-	-	○	○	-	○	○	○
Job Flow Sheet	Display	-	- ^{*3}	-	-	○	○	-	○	○
	Link	-	-	-	-	○	-	○	○	○
	Auto Start	-	- ^{*3}	-	-	○	○	-	○	○
	Manual Run	-	- ^{*3}	-	-	○	○	-	○	○

*1 The following operations are not authenticated:

- Document retrieval using a scan driver or Mailbox Viewer2.

*2 Available only when the mailbox operations are permitted in the Authentication feature settings of the System Administration mode.

*3 You can perform display, auto run and manual run operations for job flow sheets linked to mailboxes.

Important • If job flow sheets, which are no longer available for use due to a change in the authentication status, are linked to mailboxes, they cannot be edited or copied, but still can be used. If you cancel the links, however, the job flow sheets will no longer be displayed and will be unavailable.

■When [Check User Details] under [Network Access] is set to [Off (Keep logon records)]

Mailbox operation	Unauthenticated Users (General Users)			Authenticated Users				System Administrators		
	General shared	Admin shared	Personal	General shared	Admin shared	Personal (owner)	Personal (Non-owner)	General shared	Admin shared	Personal
Create/Register	-	-	-	○	-	-	-	-	○	-
Display	-	○ ^{*2}	-	○	○	-	-	○	○	○
Delete	-	-	-	○	-	-	-	○	○	○
Change Settings	-	-	-	○	-	-	-	○	○	○
Display Document	-	○ ^{*2}	-	○	○	-	-	○	○	○
Delete Document	-	○ ^{*2}	-	○	○	-	-	○	○	○
Register Document ^{*1}	-	○ ^{*2}	-	○	○	-	-	○	○	○
Output Document ^{*1}	-	○ ^{*2}	-	○	○	-	-	○	○	○
Job Flow Sheet	Display	-	- ^{*3}	-	○	○	-	-	○	○
	Link	-	-	-	○	-	-	○	○	○
	Auto Start	-	- ^{*3}	-	○	○	-	-	○	○
	Manual Run	-	- ^{*3}	-	○	○	-	-	○	○

- *1 The following operations are not authenticated:
- Document retrieval using a scan driver or Mailbox Viewer2.
- *2 Available only when the mailbox operations are permitted in the Authentication feature settings of the System Administration mode.
- *3 You can perform display, auto run and manual run operations for job flow sheets linked to mailboxes.

Important • If job flow sheets, which are no longer available for use due to a change in the authentication status, are linked to mailboxes, they cannot be edited or copied, but still can be used. If you cancel the links, however, the job flow sheets will no longer be displayed and will be unavailable.

Linking Job Flow Sheets to Mailboxes

The ways to link job flow sheets to mailboxes differ depending on whether the Authentication feature is enabled.

Important • If job flow sheets, which are no longer available for use due to a change in the authentication status, are linked to mailboxes, they cannot be edited or copied, but still can be used. If you cancel the links, however, the job flow sheets will no longer be displayed and will be unavailable.

When the Authentication Feature is not Enabled

When the Authentication feature is not enabled, the relations between users and mailboxes are as follows.

Job Flow \ Mailbox	General Users			System Administrators		
	General shared	Admin shared	Personal	General shared	Admin shared	Personal
Mailbox	○	-	-	○	○	○
General shared	○	-	-	○	○	○

Job Flow \ Mailbox	General Users			System Administrators		
	General shared	Admin shared	Personal	General shared	Admin shared	Personal
Admin shared	○	-	-	○	○	○
Personal	-	-	-	○	○	○

When the Authentication Feature is Enabled

When the Authentication feature is enabled, the relations between users and mailboxes are as follows.

For information on the Authentication feature, refer to "Login Setup/Auditron Mode" (P.209).

■When [Local Machine Access] or [Xerox Standard Accounting] is selected, when [Check User Details] is set to [On] in [Network Access], or when authenticated as a user other than a guest user in [Remote Access]

Important • If authenticated as a guest user in [Remote Access], you are treated as an unauthenticated user (general user) and cannot handle job flow sheets or mailboxes.

Job Flow \ Mailbox	Unauthenticated Users (General Users)			Authenticated Users				System Administrators		
	General shared	Admin shared	Personal	General shared	Admin shared	Personal (owner)	Personal (Non-owner)	General shared	Admin shared	Personal
General shared	-	-	-	-	-	-	-	○	○	○
Admin shared	-	-	-	-	-	○	-	○	○	○
Personal (Owner)	-	-	-	-	-	○	-	○	○	○
Personal (Non-owner)	-	-	-	-	-	-	-	○	○	○

■When [Check User Details] under [Network Access] is set to [Off (Keep logon records)]

Job Flow \ Mailbox	Unauthenticated Users (General Users)			Authenticated Users				System Administrators		
	General shared	Admin shared	Personal	General shared	Admin shared	Personal (owner)	Personal (Non-owner)	General shared	Admin shared	Personal
General shared	-	-	-	○	-	-	-	○	○	○
Admin shared	-	-	-	○	-	-	-	○	○	○
Personal (Owner)	-	-	-	-	-	-	-	○	○	○
Personal (Non-owner)	-	-	-	-	-	-	-	○	○	○

Overview of Auditron Administration

This section describes an overview of the Auditron Administration feature that can be used with the machine.

Authentication and Auditron Administration

The Auditron Administration feature, which works in conjunction with the Authentication feature, is classified into the following four types:

■ Using Machine Authentication

Auditron administration is carried out based on the authenticated user information pre-registered on the machine, using a variety of counters automatically created for each user.

For information on configuring print driver, refer to the online help provided for the driver.

■ Using Network Authentication

Auditron administration is carried out based on user information managed by a remote service.

User information managed by the remote service is sent to be registered on the machine. When the user information on the remote service is updated, the updated information must be sent from the remote service to the machine.

Network Authentication allows an unified management of user information for multiple devices.

Remote services supported by the machine includes ApeosWare EasyAdmin (optional).

■ Using Remote Authentication (ApeosPort series models)

Remote authentication is carried out based on the user information managed on a remote authentication server, such as ApeosWare Accounting Service (optional).

User information is not required to be registered on the machine.

Important • When registering user information on the remote authentication server, use up to 32 characters for a User ID and up to 128 characters for a password. Note, however, that up to 32 characters are allowed for an SMB authentication password.

■ Using Xerox Standard Accounting

Auditron administration is carried out based on the user information and account information pre-registered on the machine. Auditron administration uses each counter created automatically for individual users. Auditron reports are created in CSV format using CentreWare Internet Services. For information on the print driver settings, refer to the online help of the driver. For information on the user information settings, account information settings, and how to create a report, refer to CentreWare Internet Services.

Important • When setting the user information or account information for another ApeosPort-II C7500/C6500/C5400 or DocuCentre-II C7500/C6500/C5400, it is recommended to use the Cloning feature of CentreWare Internet Services.

Manageable Features and Services

This section describes features and services that can be managed with the Auditron Administration feature.

The features and corresponding services that can be managed vary depending on the type of authentication: local machine authentication, network authentication, remote authentication, or Xerox Standard Accounting.

For information on the Authentication feature, refer to "Login Setup/Auditron Mode" (P.209).

- Local Machine Access
- Network Access
- Remote Access
- Xerox Standard Accounting

■ Local Machine Access

The features and services that can be managed in Local Machine Access are as follows.

Corresponding Service	Authenticat-ion ^{*1}	Restrictions on Use		Per-user Usage Count
	User ID	Feature restrictions ^{*2}	Account Limit ^{*3}	
Copy	○	○	○	○
Print	○	○	○	○
Charge Print, Private Charge Print	○	○	○	○
Scan Service	○	○	○	○
Report/List	-	-	-	-

*1 This column shows whether authentication is required for each service. "O" indicates that authentication is required.

*2 You can select features available for each user. For more information, refer to "Account Limit" (P.203).

*3 This feature stops further machine operation if the number of pages has reached the specified maximum number. For more information, refer to "Account Limit" (P.203).

■ Network Access

When the network authentication is used, the Auditron Administration information can be managed with ApeosWare Accounting Service (optional).

For features supported by ApeosWare Accounting Service (optional), refer to the documentation provided with it.

The features and services that can be managed on the machine are as follows.

Corresponding Service	Authenticat-ion ^{*1}	Restrictions on Use		Per-user Usage Count
	User ID	Feature restrictions ^{*2}	Account Limit ^{*3}	
Copy	○	○	-	-
Print	○	○	-	-
Charge Print, Private Charge Print	○	○	-	-

Corresponding Service	Authentica- tion ^{*1}	Restrictions on Use		Per-user Usage Count
	User ID	Feature restrictions ^{*2}	Account Limit ^{*3}	
Scan Service	O	O	-	-
Report/List	-	-	-	-

*1 This column shows whether authentication is required for each service. "O" indicates that authentication is required.

*2 You can select features available for each user. The settings can be made with the remote service.

*3 This feature stops further machine operation if the number of pages has reached the specified maximum number. The settings can be made with the remote service.

Note • Authentication is not performed when [System Settings] > [Login/Setup Auditron Mode] > [Network Access] > [Check User Details] is set to [Off (Keep logon records)].

For information on [Network Access], refer to "Network Access" (P.209).

■ Remote Access (ApeosPort series models)

When the remote authentication is used, the auditron administration information can be managed with ApeosWare Accounting Service (optional).

For features supported by ApeosWare Accounting Service (optional), refer to the documentation provided with it.

The features and services that can be managed on the machine are as follows.

Corresponding Service	Authentica- tion ^{*1}	Restrictions on Use		Per-user Usage Count
	User ID	Feature restrictions ^{*2}	Account Limit	
Copy	O	-	-	-
Print	- ^{*3}	-	-	-
Charge Print, Private Charge Print	O	-	-	-
Scan Service	O	-	-	-
Report/List	-	-	-	-

*1 This column shows whether authentication is required for each service. "O" indicates that authentication is required.

*2 If ApeosWare Authentication Agent (optional) is used as an authentication system, you can select features to restrict. For information on ApeosWare Authentication Agent, refer to the documentation provided with it.

*3 Under Remote Access, the Print feature cannot be restricted. To restrict print operations, use the Charge Print or Private Charge Print feature.

■ Xerox Standard Accounting

The features and services that can be managed in Xerox Standard Accounting are as follows.

Corresponding Service	Authentica- tion ^{*1}	Restrictions on Use		Per-user Usage Count
	User ID	Feature restrictions ^{*2}	Account Limit ^{*3}	
Copy	O	O	O	O
Print	O	O	O	O

Corresponding Service	Authentica-tion ^{*1}	Restrictions on Use		Per-user Usage Count
	User ID	Feature restrictions ^{*2}	Account Limit ^{*3}	
Charge Print, Private Charge Print	O	O	O	O
Scan Service	O	O	O	O
Report/List	-	-	-	-

*1 This column shows whether authentication is required for each service. "O" indicates that authentication is required.

*2 You can select features available for each user. For more information, refer to the CentreWare Internet Services online help.

*3 This feature stops further machine operation if the number of pages has reached the specified maximum number. For more information, refer to the CentreWare Internet Services online help.

Jobs that can be Managed for Each Service

The types of jobs you can manage using the Auditron Administration feature vary for print and scan services.

This section describes the items that can be managed for the jobs of each service.

■Print

The items you can manage for print jobs using the Auditron Administration feature are as follows.

Services (Jobs)		Authent-ication	Users for which Auditron are Collected	Managed Items
Normal Print	Machine's print driver	Required	Authenticated user	Pages/sheets
	Other than machine's print driver	- ^{*2}	Unregistered user	Pages/sheets
Secure Print	Store Documents	Required	-	-
	Print Documents	Not required ^{*1}	Authenticated user	Pages/sheets
Sample Print	Sample Print Store Documents in Mailboxes/Print Documents	Required	Authenticated user	Pages/sheets
	Sample Print Print Mailbox-stored Documents	Not required ^{*1}	Authenticated user	Pages/sheets
Mailbox Print	Store Documents	Required	-	-
	Print Documents	Required/ Not required ^{*4}	Authenticated user	Pages/sheets
Delayed Print	Store Documents	Required	-	-
	Print Documents	Not required ^{*1}	Authenticated user	Pages/sheets

Services (Jobs)		Authent-ication	Users for which Auditron are Collected	Managed Items
Charge Print	Store Documents	Not required	-	-
	Print Documents	Required	Authenticated user	Pages/sheets
Private Charge Print	Store Documents	Required/ Not required* ³	-	-
	Print Documents	Required	Authenticated user	Pages/sheets
E-mail Printing		-* ²	Unauthenticated user	Pages/sheets

*1 Authentication is unnecessary upon printing because each print job has been authenticated when received by the machine.

*2 You can print only when [Non-Account Print] is set to [Enable] on CentreWare Internet Services.

*3 Depends on the "Receive Control" (P.207) settings in the System Administration mode.

*4 Depends on the "Mailbox Access" (P.210) settings in the System Administration mode.

■ Scan Service

The items you can manage for scan jobs using the Auditron Administration feature are as follows.

Corresponding Service	Authent-ication	Users for which Auditron are Collected	Managed Items
E-mail	Required	Authenticated user	Scanned pages, mail transmission pages
Scan to Mailbox	Required	Authenticated user	Scanned pages, stored pages
Scan to PC	Required	Authenticated user	Scanned pages, file transfer pages
Network Scanning	Required	Authenticated user	Scanned pages, file transfer pages

14 Problem Solving

This chapter describes troubles that may occur with the machine and their solutions.

- Troubleshooting 288
- Machine Trouble 289
- Image Quality Trouble 294
- Trouble during Copying 299
- Trouble during Printing 303
- Trouble during Scanning 306
- Network-related Problems 312
- Error Code 323
- Paper Jams 366
- Document Jams 395
- Stapler Faults 398
- Staple Cartridge Taken Off from Unit for the Booklet Finisher D2 404
- Solving Curled Output for the Booklet Finisher D2 406

Troubleshooting

This section describes troubles that may occur with the machine and their solutions. Follow the troubleshooting procedure below to solve the problems.

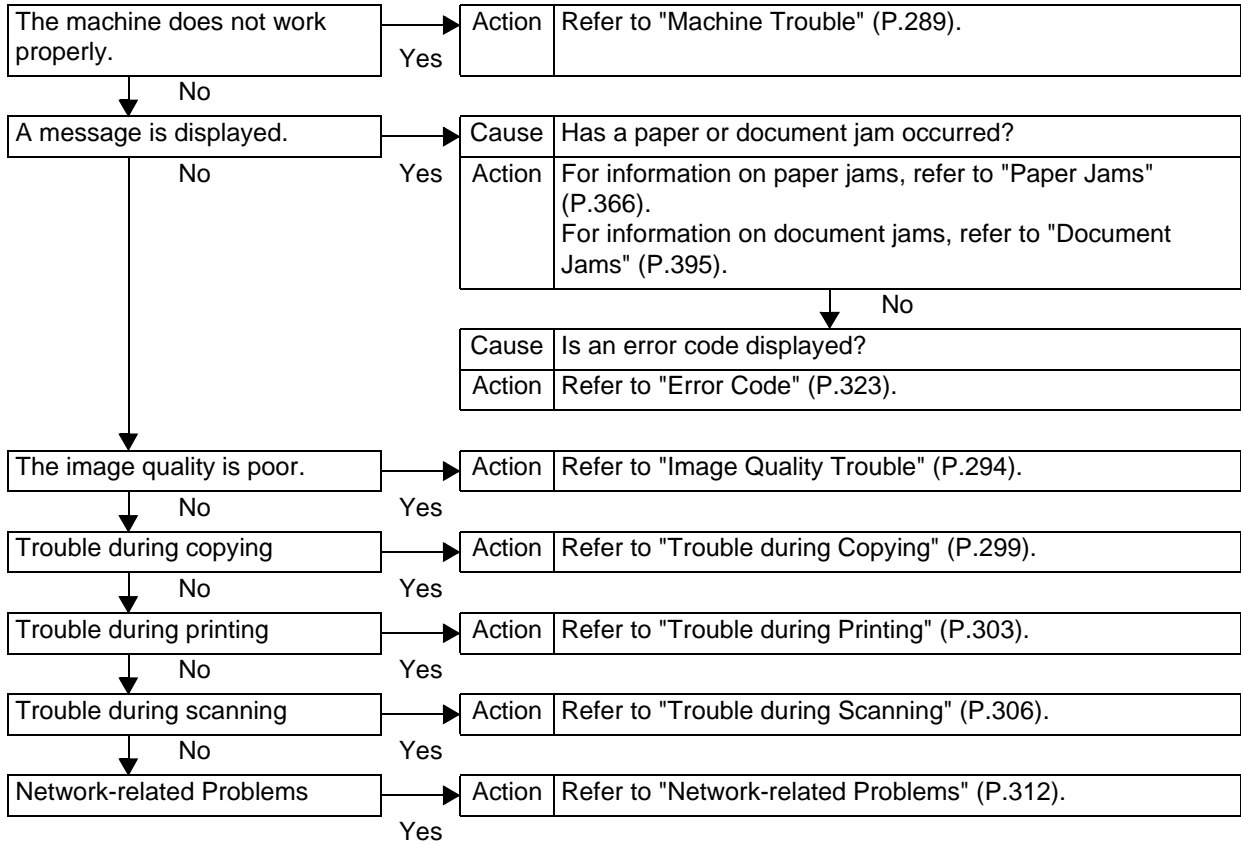

Machine Trouble

Before you determine that the machine is defective, check the machine status again.

Symptom	Cause	Remedy
The machine is not powered on.	Is the power switched on?	Switch the power on. Refer to "2 Product Overview" > "Power On / Off" in the User Guide.
	Is the power cord plugged into the power outlet?	Turn the power switch off, and then firmly plug the power cord into the connector and power outlet. Then turn the power switch on. Refer to "2 Product Overview" > "Power On / Off" in the User Guide.
	Is the power cord disconnected from the machine?	
	Does the AC outlet supply power properly?	Connect another appliance to the outlet to verify the power supply.
The touch screen is too dark.	Is the <Power Saver> button on?	The machine is in the Power Saver mode. Press the <Power Saver> button on the control panel to exit the Power Saver mode. Refer to "2 Product Overview" > "Power Saver Mode" in the User Guide.
	Is the screen contrast low?	Adjust the screen contrast by using the contrast adjustment dial. Refer to "2 Product Overview" > "Control Panel" in the User Guide.
Unable to print, or unable to copy.	Is a message displayed on the touch screen?	Follow the instructions displayed to solve the problem.
	Is the memory capacity insufficient?	Perform one of the following: set [Print Mode] to [Normal], or set [Page Print Mode] to [On], reduce the number of open ports to increase the print page buffer size. Note • When memory capacity is insufficient, the port status is automatically set to [Stop] and the machine restarts.
	Is the print mode [Off-line]?	Press the <Machine Status> button to check the [Print Mode] on the [Machine Status] screen. If [Print Mode] is set to [Off-line], select [On-line].
	Is the power cord disconnected from the machine?	Turn the power switch off, and then firmly plug the power cord into the connector and power outlet. Then turn the power switch on. Refer to "2 Product Overview" > "Power On / Off" in the User Guide.

Symptom	Cause	Remedy
The <Online> indicator does not light even though you instructed the machine to print.	Is the interface cable connected?	Turn the power switch off, unplug the power cord from the power outlet, and check the interface cable connection. Refer to "2 Product Overview" > "Interface Cables" in the User Guide.
	Is the computer's environment correctly set?	Check the computer environment such as print driver settings.
	Is the required interface correctly set?	Check the status of the interface port. Refer to "Printer Environment Settings" (P.219).
A document is not fed from the Tray 5 (Bypass).	Is the specified size paper loaded in the tray?	Follow the instructions displayed to load paper of correct size, and try again. Refer to "Loading Paper in the Tray 5 (Bypass)" (P.29).
Unsatisfactory print quality.	A probable cause is an image defect.	Remedy the problem referring to "Image Quality Trouble". Refer to "Image Quality Trouble" (P.294).
Unable to print text correctly. (Text is garbled.)	Non-standard fonts are used for printing.	Check the application or print driver settings. If PostScript (optional) is being used, attach an optional HDD Extension Kit to download the required fonts.
The <Online> indicator lights or blinks, but printed paper is not output.	Data remains in machine memory.	Cancel printing, or delete the remaining data. Refer to "Checking Current/Pending Jobs" (P.73).
Unable to insert or remove a paper tray.	Did you open a cover or turn the power switch off during printing?	Do not forcibly insert or remove the paper tray. Turn the power switch off. In a few seconds, turn the power switch on. When the machine is ready to receive data, insert or remove the paper tray.

Symptom	Cause	Remedy
Unable to copy with the specified size.	Is the document glass or the document cover dirty?	Clean the document glass and the document cover. Refer to "Cleaning the Document Cover and Document Glass" (P.63).
	Is the document a transparent type such as a transparency film?	Place the document on the document glass, and then place a white sheet over the document.
	Is the document in the correct position?	Load the document correctly. Refer to "3 Copy" > "Copying Procedure" in the User Guide.
	Is the document loaded correctly?	
	Are the document guides on the document feeder in the correct positions?	Adjust the document guide positions. Refer to "3 Copy" > "Copying Procedure" in the User Guide.
	Is the document folded?	Unfold and correctly place the document. Refer to "3 Copy" > "Copying Procedure" in the User Guide.
	Is the document a non-standard size?	Specify the document size. Refer to "3 Copy" > "Layout Adjustment" > "Original Size (Specifying the Scan Size for the Document)" in the User Guide.

Symptom	Cause	Remedy
Paper is often jammed or wrinkled.	Is the paper loaded correctly in the tray?	Load the paper correctly. Refer to "Loading Paper" (P.27).
	Is the paper tray inserted correctly?	Firmly push in the paper tray as far as possible to insert it correctly. Refer to "Loading Paper" (P.27).
	Is the paper damp?	Replace the paper with new one. Refer to "Loading Paper" (P.27).
	Is the paper curled?	Turn over the paper in the tray, or replace the paper with new one. Refer to "Loading Paper" (P.27).
	Are the paper and paper tray settings correct?	Correctly load the paper into the paper tray. Refer to "Changing the Paper Settings" (P.38).
	Are there any torn pieces of paper remaining or is there a foreign object in the machine?	Open the door of the machine or slide out the paper tray to remove the torn pieces or the foreign object. Refer to "Paper Jams" (P.366), or "Loading Paper" (P.27).
	Is non-standard paper loaded in the tray?	Replace with paper that meets machine specifications. Refer to "Paper Types" (P.24), or "Loading Paper" (P.27).
	Is paper exceeding the maximum fill line in the tray?	Load paper in the paper tray so that it does not exceed the maximum fill line. Refer to "Loading Paper" (P.27).
	Are the paper guides set correctly?	Load the paper correctly, and align the paper guides with the paper gently. Refer to "Loading Paper" (P.27), or "Changing the Paper Size" (P.33).
	Is the image nearly the same size as the paper?	Increase the edge erase widths. For more information, refer to "3 Copy" > "Layout Adjustment" > "Edge Erase (Erasing Edges and Margin Shadows of the Document)" in the User Guide when you make copies, or to the print driver's online help when you print data.
	Is the paper finely cut out?	Some types of paper may not be cut out finely. Load the paper after fanning it well.
A document is not fed into the document feeder.	Is the document small?	The minimum size of the document that can be loaded on the document feeder is A5. Refer to "3 Copy" > "Copying Procedure" in the User Guide.

Symptom	Cause	Remedy
An error message appears after paper is loaded in the Tray 5 (Bypass) and the <Start> button is pressed.	Check the positions of the paper guides of the Tray 5 (Bypass).	Adjust the paper guides to the correct positions. Refer to "Loading Paper in the Tray 5 (Bypass)" (P.29).
Documents are often jammed.	Are the suitable types of documents used?	Correctly load documents suitable for the document feeder. Refer to "3 Copy" > "Copying Procedure" in the User Guide.
	Are you trying to copy irregular shaped documents, business cards, transparencies, or thin documents?	
	Are you trying to copy documents with sticky labels, paper clips or adhesive tape?	Remove sticky labels, paper clips or adhesive tape from the document before copying.
	Are the document guides in the correct positions?	Adjust the document guide positions. Refer to "3 Copy" > "Copying Procedure" in the User Guide.
	Is a piece of torn paper remaining in the document feeder?	Open the document feeder cover and check inside. Refer to "Document Jams" (P.395) or "Document Jams" (P.395).
	Is the [Mixed Sized Originals] setting set to [On] when you copy originals of different sizes?	Set [Mixed Sized Originals] to [On]. Refer to "3 Copy" > "Layout Adjustment" > "Mixed Sized Originals (Scanning Different Size Documents Simultaneously)" in the User Guide.
	Is an A5 document loaded in landscape orientation (☐) on the document feeder when the Mixed Sized Originals feature is in use?	Load the A5 document in portrait orientation (☐).
A corner of the document is folded.	Is the document curled?	Flatten out the curl and load the document again.
Color copies cannot be made.	Is [Output Color] set to [Black]?	Select [Color] for [Output Color]. Refer to "3 Copy" > "General Settings" > "Output Color (Selecting the Color to Copy)" in the User Guide.
	Is a message displayed on the touch screen, prompting you to replace the toner cartridge?	Replace with the toner cartridge of the color indicated in the message. Refer to "Replacing Consumables" (P.42).
Stapler Faults	-	Refer to "Stapler Faults" (P.398).



Image Quality Trouble



If the image quality of printed documents is poor, identify the similar symptom in the following table to prescribe the remedy.



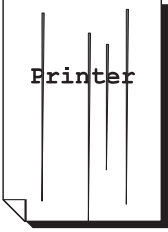
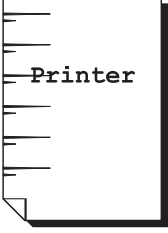
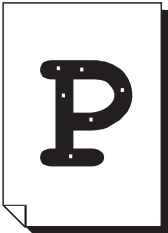

If the image quality is not improved even after prescribed the relevant remedy, contact our Customer Support Center.

Symptom	Cause	Remedy
The copy is dirty.	Is the document glass or the document cover dirty?	Clean the document glass and the document cover. Refer to "Cleaning the Document Cover and Document Glass" (P.63).
	Is the document a transparent type such as a transparency film?	If the document is transparent, dirt on the document cover will be copied. Place a white sheet of paper over the original document when copying.
	Is the document colored, rough, or a blueprint?	Adjust the copy density or image quality. Refer to "3 Copy" > "Image Quality" > "Original Type (Selecting the Document Type)" or "Image Options (Adjusting Copy Density/Sharpness of images)" in the User Guide.
	Is the document glossy printing paper?	Glossy printing paper easily sticks to the document glass, and shadows are sometimes copied and shown as dirt. Place a transparency film under the document when copying.
The copy has black lines.	Is the document glass on the document feeder dirty?	Clean the document glass. Refer to "Cleaning the Narrow Glass Strip and Document Presser" (P.64) or "Executing Calibration" (P.66).
The copy is too dark.	Is the copy density set to [Darken]?	Adjust the copy density. Refer to "3 Copy" > "Image Quality" > "Image Options (Adjusting Copy Density/Sharpness of images)" in the User Guide.
The copy is too light.	Is the document faint?	
	Is the copy density set to [Lighten]?	
Tonal reproduction for color copies is poor, resulting in unsatisfactory image quality.	Is tonal reproduction poor?	Perform calibration. Refer to "Executing Calibration" (P.66).
The copy is slightly misaligned.	Are the paper edges aligned and the leading edge flush with the tray corners?	Align the paper edges, and adjust them with the tray's front corners to reload the paper. Refer to "Loading Paper" (P.27).

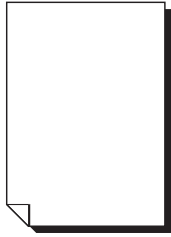
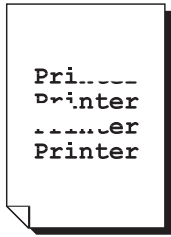
Symptom	Cause	Remedy
The copy is misaligned or skewed.	Is the document loaded correctly?	Load the document correctly. Refer to "3 Copy" > "Copying Procedure" in the User Guide.
	Is the paper loaded correctly in the tray?	Load the paper correctly. Refer to "Loading Paper" (P.27).
	Are the paper guides of the Tray 5 (Bypass) correctly aligned with the paper?	Load the paper correctly. Refer to "Loading Paper in the Tray 5 (Bypass)" (P.29).
	Are the document guides on the document feeder in the correct positions?	Load the document correctly, and align the document guides with the document sides. Refer to "3 Copy" > "Copying Procedure" in the User Guide.
	Is the paper tray inserted correctly?	Firmly push in the tray as far as possible to insert it properly. Refer to "Loading Paper" (P.27).
Part of the image is missing on the copy.	Is the paper damp?	If the paper is damp, the copy image may be partially missing or unclear. Replace the paper with new one. Refer to "Loading Paper" (P.27).
	Is folded or wrinkled paper included in the tray?	Remove the improper paper or replace whole paper with new one. Refer to "Loading Paper" (P.27).
	Is the document pasted or folded?	There may be a gap between the document glass and the pasted or folded section. Place a stack of white sheets on the document to remove the gap between the document and the document glass.
The copy has a stripe pattern.	Is the enlargement ratio large?	Output may have vertical stripes depending on the ratio. Adjust the ratio to remove the stripes. Refer to "3 Copy" > "Copy"(or "General Settings") > "Reduce/Enlarge (Making Enlarged/Reduced Copies)" in the User Guide.

Symptom	Cause	Remedy
Printing is faint. (smudged, unclear) 	The paper is damp.	Replace the paper with new one. Refer to "Loading Paper" (P.27).
	The drum cartridge has deteriorated or is damaged.	Replace the drum cartridge with a new one. Refer to "Replacing Consumables" (P.42).
	There is no toner left in the toner cartridge.	Replace the toner cartridge with a new one. Refer to "Replacing Consumables" (P.42).
Black dots are printed. 	The drum cartridge has deteriorated or is damaged.	Replace the drum cartridge with a new one. Refer to "Replacing Consumables" (P.42).
Black or colored lines are printed. 	The drum cartridge has deteriorated or is damaged.	Replace the drum cartridge with a new one. Refer to "Replacing Consumables" (P.42).
	The document glass on the document feeder is dirty.	Clean the document glass. Refer to "Cleaning the Narrow Glass Strip and Document Presser" (P.64) or "Executing Calibration" (P.66).
Dirt appears at equal intervals. 	The paper feeder is dirty.	Print a few pages to remove the dirt.
	The drum cartridge has deteriorated or is damaged.	Replace the drum cartridge with a new one. Refer to "Replacing Consumables" (P.42).
White dots appear in black filled areas. 	The paper is unsuitable.	Load suitable paper. Refer to "Loading Paper" (P.27).
	The drum cartridge has deteriorated or is damaged.	Replace the drum cartridge with a new one. Refer to "Replacing Consumables" (P.42).

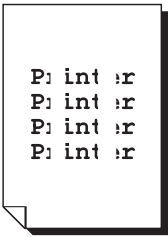
Symptom	Cause	Remedy
Printed toner smudges when rubbed with your finger. Toner is not fused. The paper is dirty with toner. 	The paper is damp.	Replace the paper with new one. Refer to "Loading Paper" (P.27).
	The paper is unsuitable.	Load suitable paper. Refer to "Loading Paper" (P.27).
The entire paper area is printed black. 	The drum cartridge has deteriorated or is damaged.	Replace the drum cartridge with a new one. Refer to "Replacing Consumables" (P.42).
	High-voltage power supply problem may have occurred.	Contact our Customer Support Center.
Nothing is printed. 	Two or more sheets of paper are being fed simultaneously (double-feed).	Fan the paper well and load it again. Refer to "Loading Paper" (P.27).
	There is no toner left in the toner cartridge.	Replace the toner cartridge with a new one. Refer to "Replacing Consumables" (P.42).
	High-voltage power supply problem may have occurred.	Contact our Customer Support Center.
White areas or white or colored stripes appear. 	The paper is damp.	Replace the paper with new one. Refer to "Loading Paper" (P.27).
	The paper is unsuitable.	Load suitable paper. Refer to "Loading Paper" (P.27).

Symptom	Cause	Remedy
<p>The output is entirely faint.</p> 	<p>When the Tray 5 (Bypass) is used, the size and type of the loaded paper are different from the settings on the print driver.</p>	<p>Load correct paper into the Tray 5 (Bypass). Refer to "Loading Paper in the Tray 5 (Bypass)" (P.29).</p>
	<p>Two or more sheets may be fed at once.</p>	<p>Fan the paper well and load it again. Refer to "Loading Paper" (P.27).</p>
<p>Paper becomes wrinkled. Text is blurred.</p> 	<p>The paper is unsuitable.</p>	<p>Replace the paper with new one. Refer to "Loading Paper" (P.27).</p>
	<p>Paper has been added to the loaded paper.</p>	
	<p>The paper is damp.</p>	
<p>White or color patches appear vertically.</p> 	<p>The drum cartridge has deteriorated or is damaged.</p>	<p>Replace the drum cartridge with a new one. Refer to "Replacing Consumables" (P.42).</p>
	<p>There is no toner left in the toner cartridge.</p>	<p>Replace the toner cartridge with a new one. Refer to "Replacing Consumables" (P.42).</p>
<p>Text or images are printed at an angle.</p> 	<p>The paper guides in the paper tray are not set in the correct positions.</p>	<p>Adjust the horizontal and vertical paper guides to the correct positions. Refer to "Loading Paper" (P.27).</p>

Trouble during Copying

This section describes how to solve copy problems.

Unable to Copy

Follow the procedure below if you cannot copy documents.

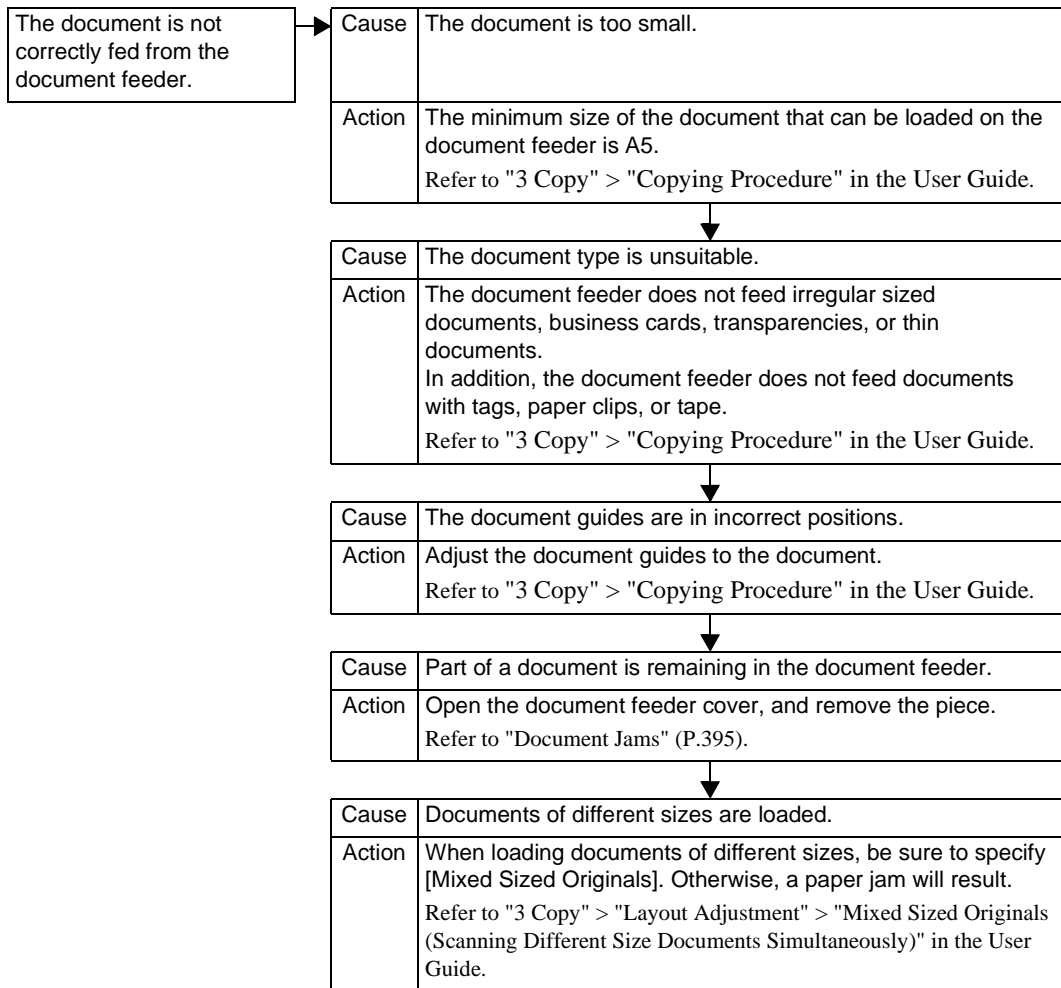

The Copy Result is Not What was Expected

Follow the procedure below if the copy result is not what was expected.

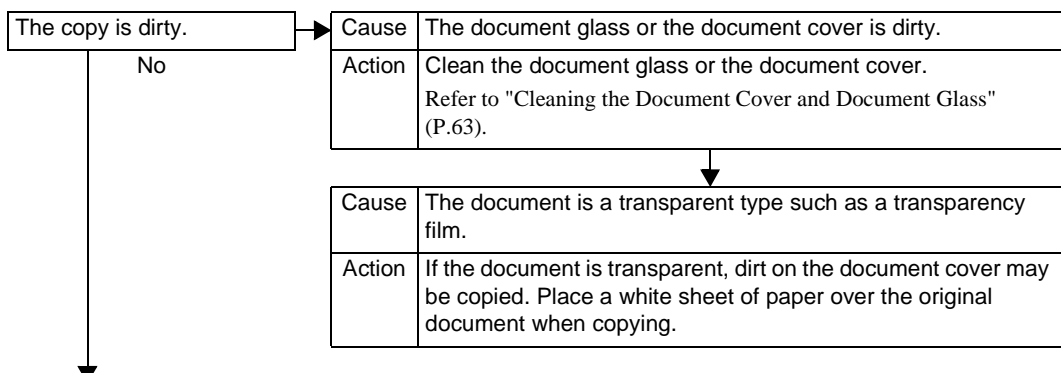

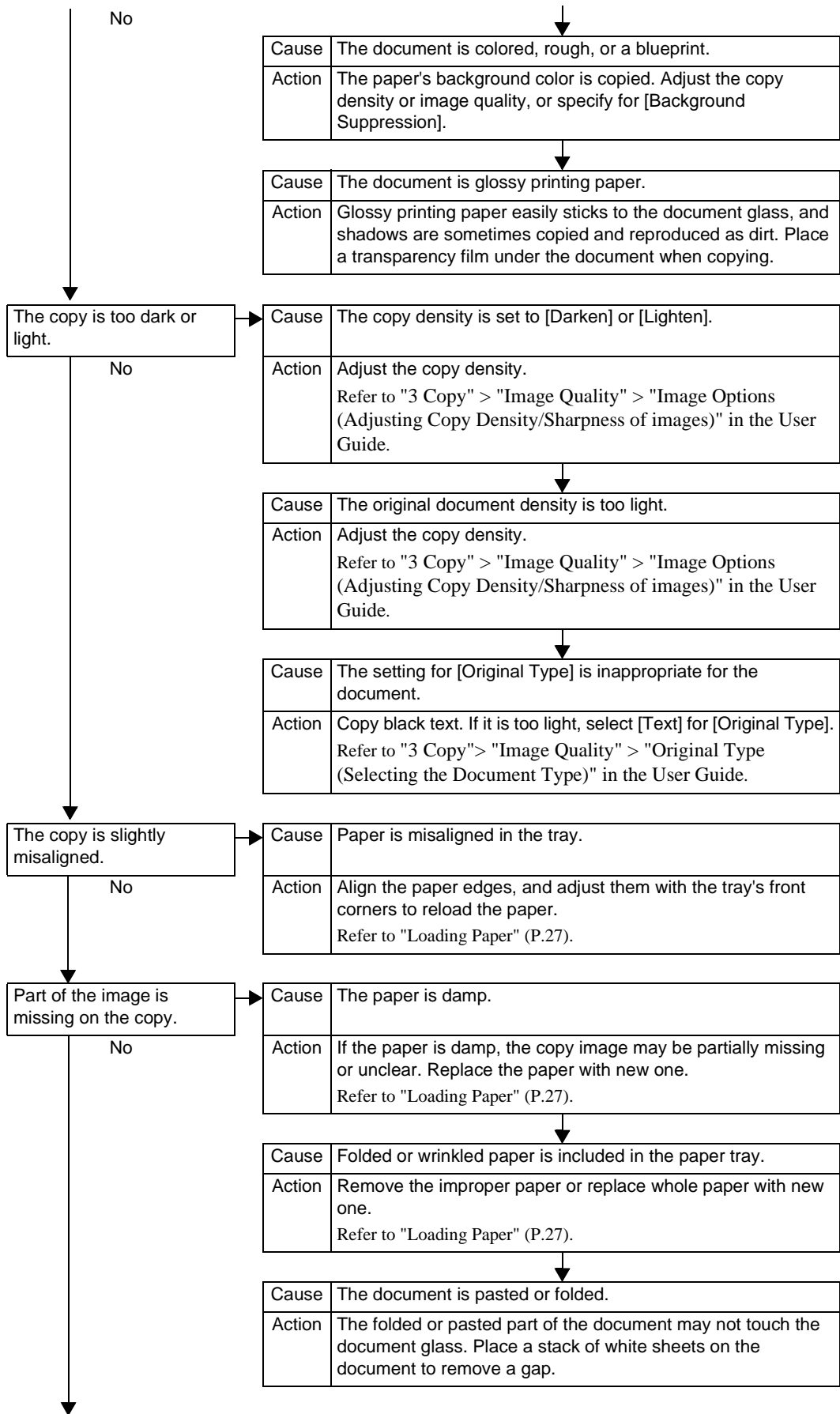

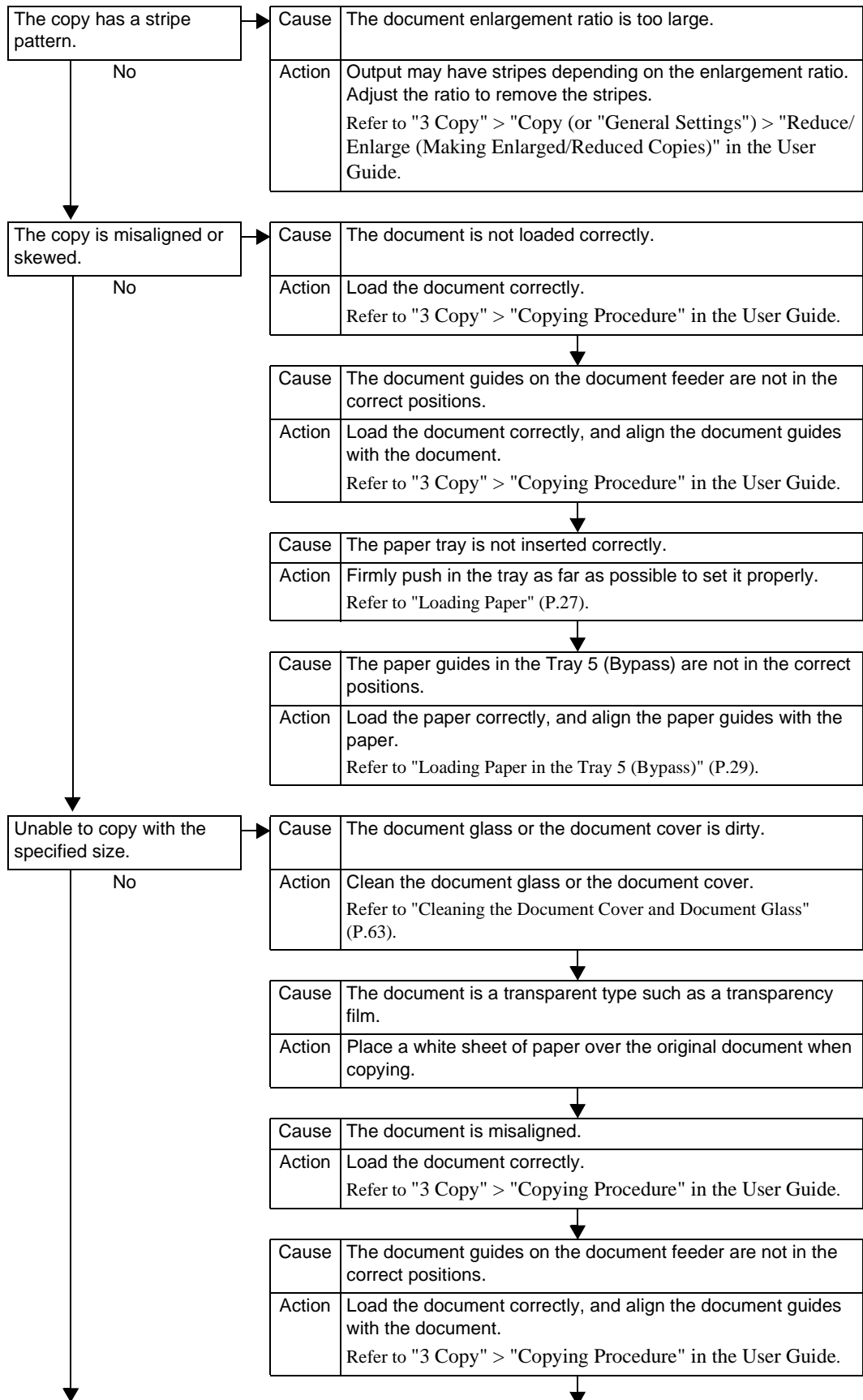

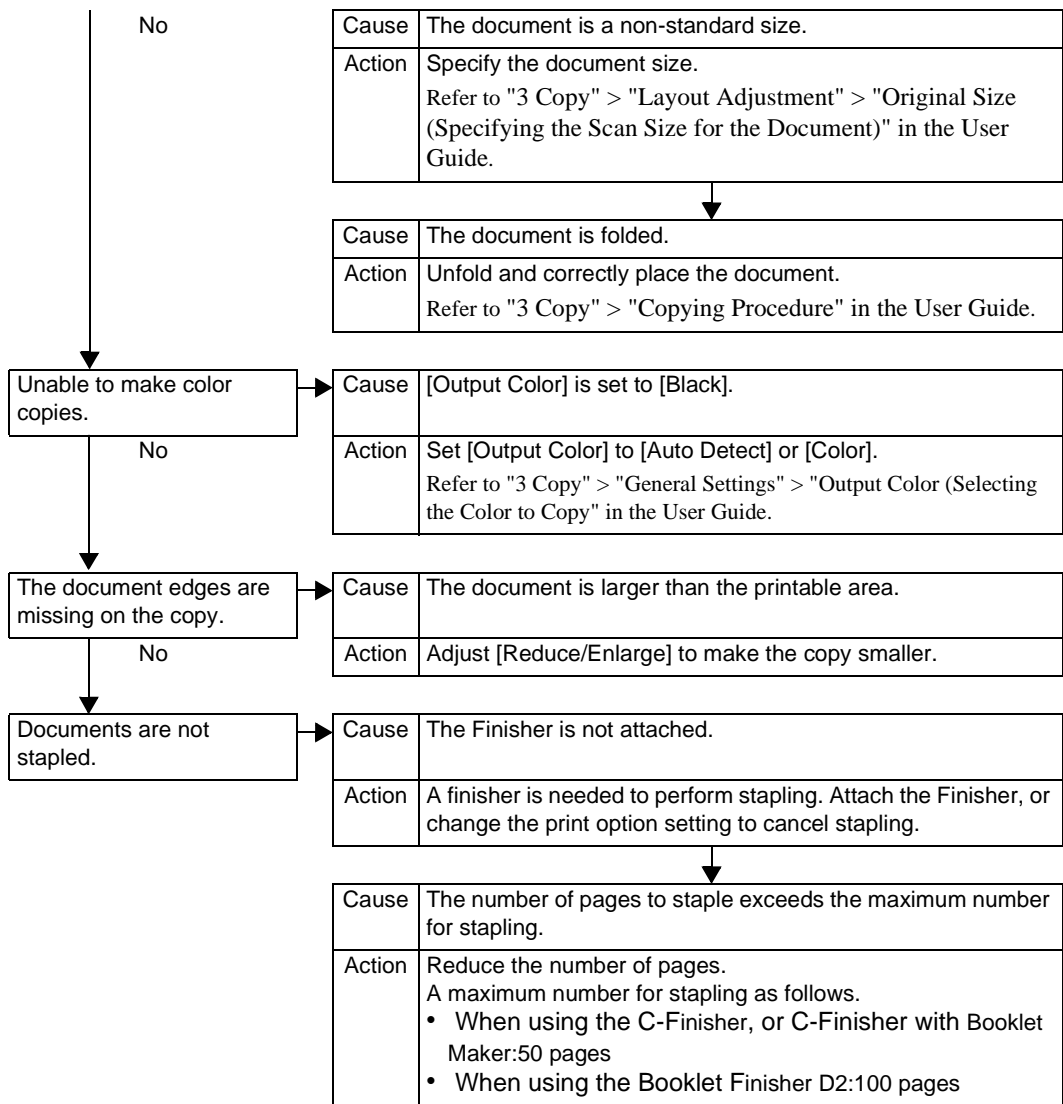

Trouble during Printing

This section describes how to solve print problems.

Unable to Print

Follow the procedure below if you cannot print a document.

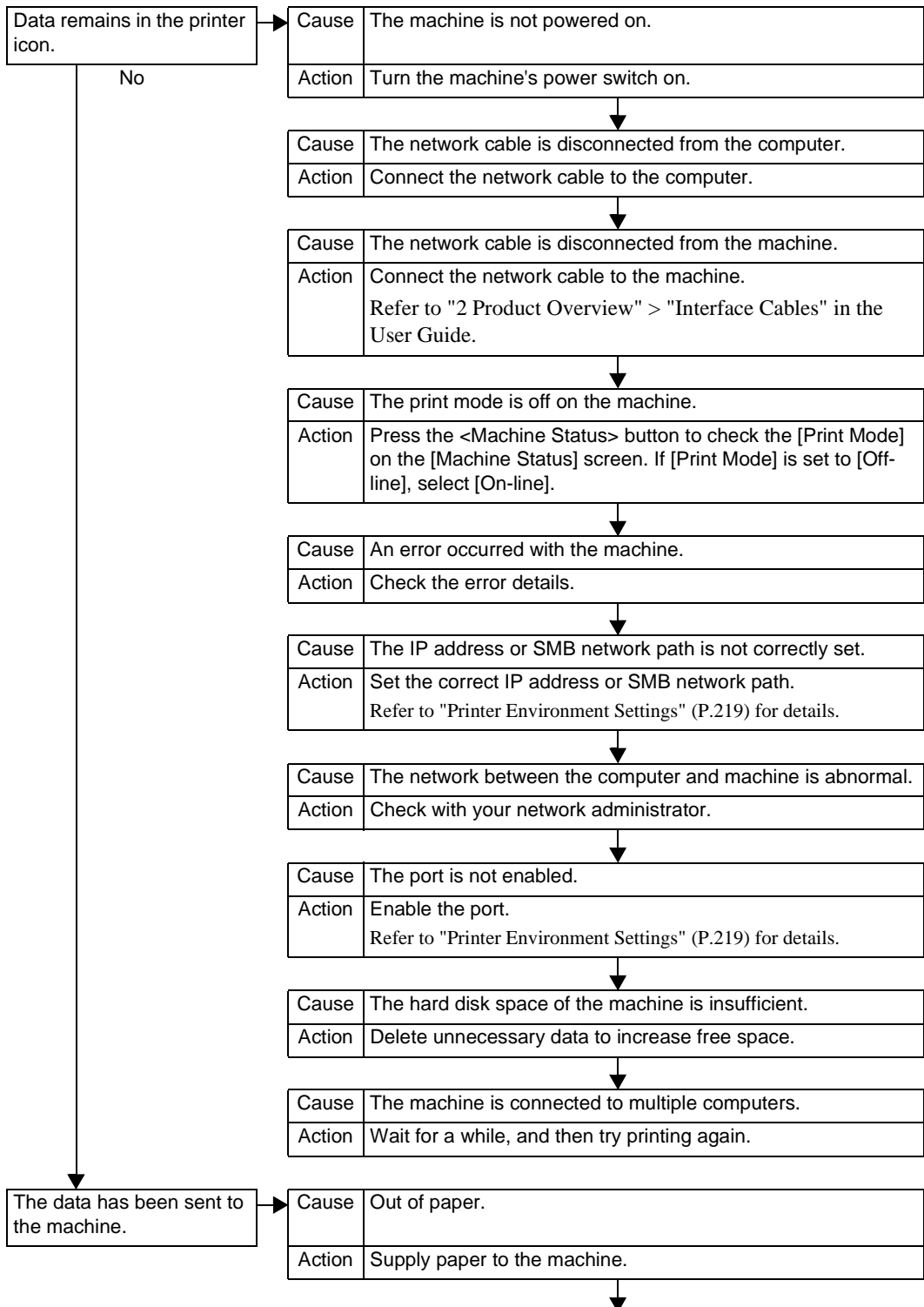

Cause	No paper for the specified paper size.
Action	Set the specified size paper. Refer to "Loading Paper" (P.27).
Cause	Printing is interrupted by a copy operation.
Action	Cancel the interrupting operation.
Cause	An error occurred on the machine.
Action	Check the error details.

The Print Result is Not What was Expected

Follow the procedure below if the print result is not what was expected.

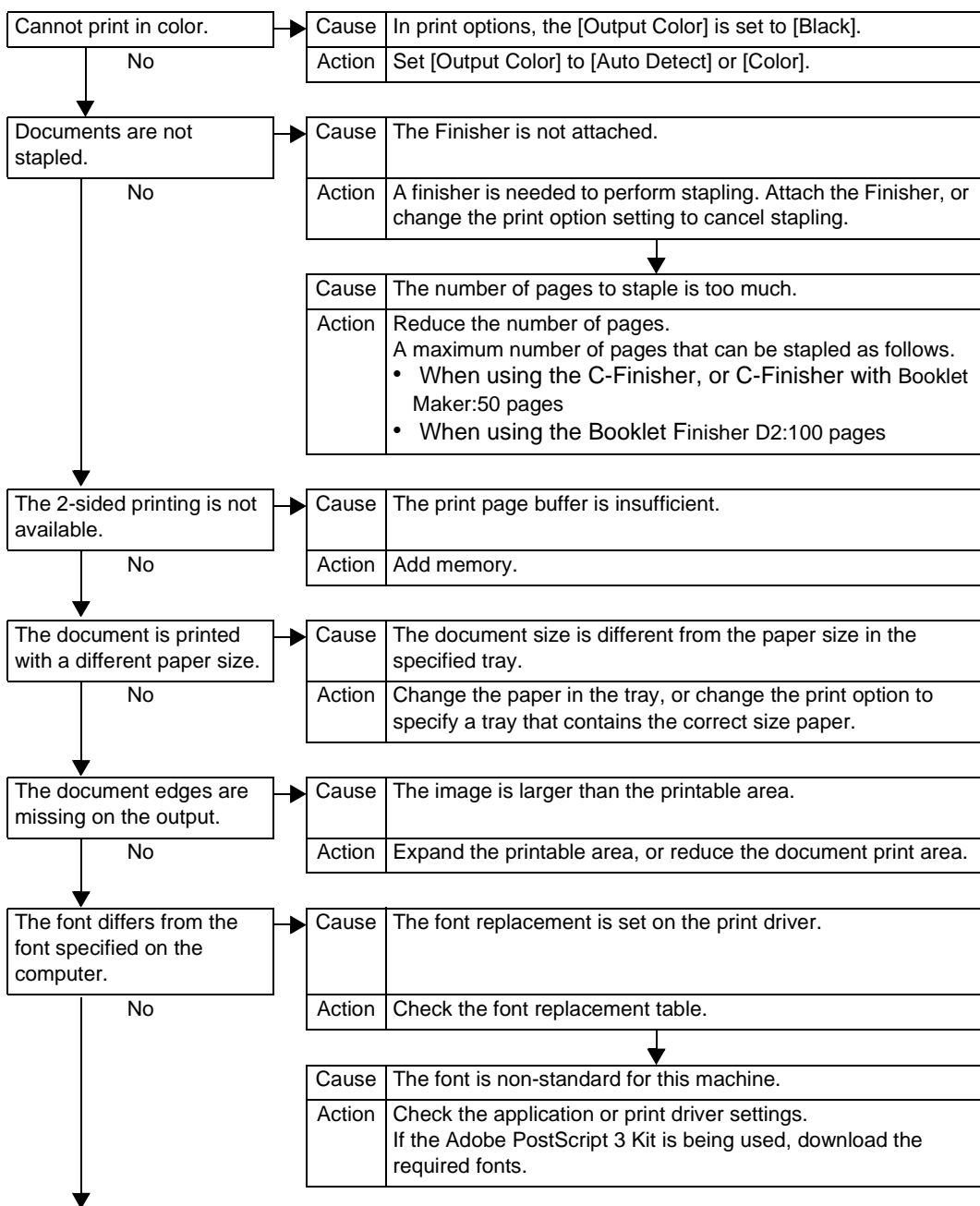

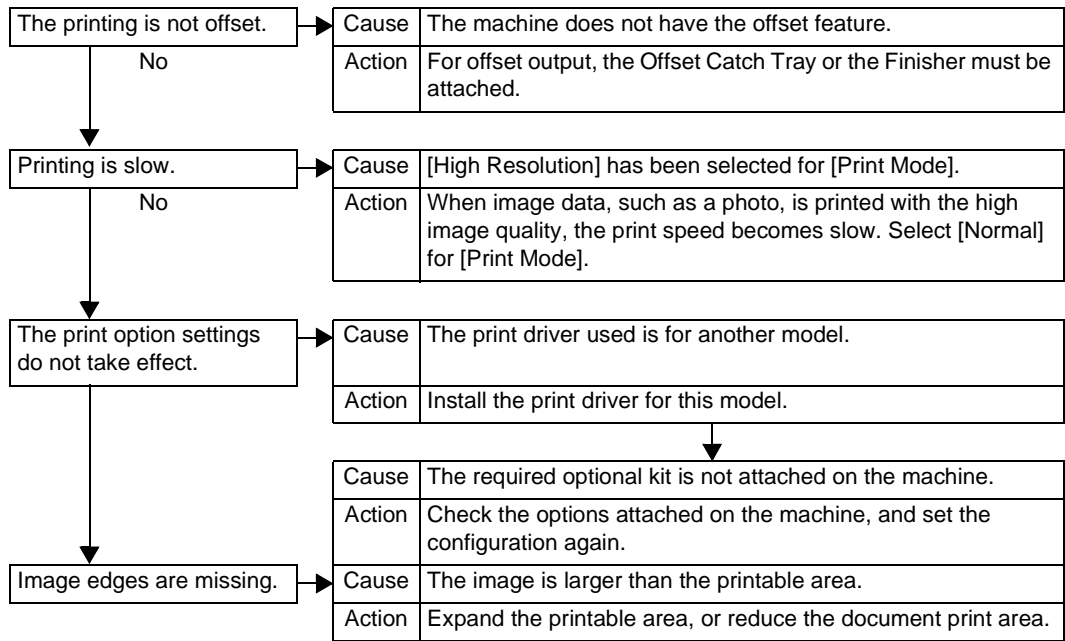

Trouble during Scanning

This section describes how to solve scanning problems.

Note • Scan features are not available for some models. An optional package is necessary. For more information, contact our Customer Support Center.

Unable to Scan with the Machine

Follow the procedure below if you cannot scan with the machine.

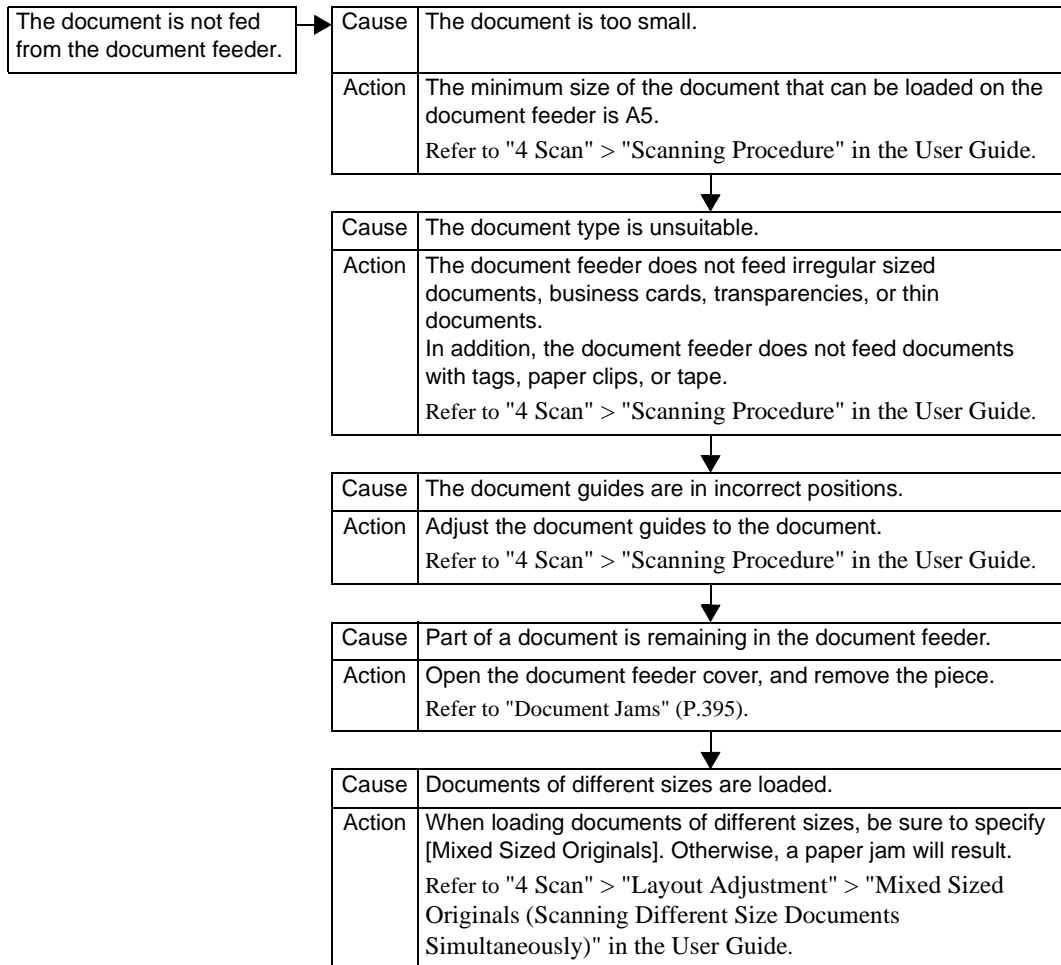

Unable to Import Scanned Documents to the Computer

Follow the procedure below if you cannot import scanned documents to the computer.

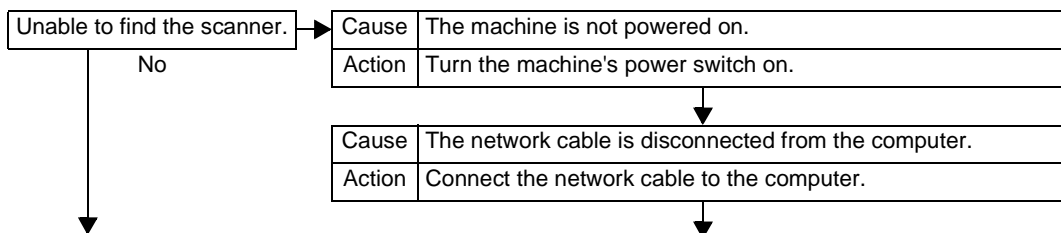

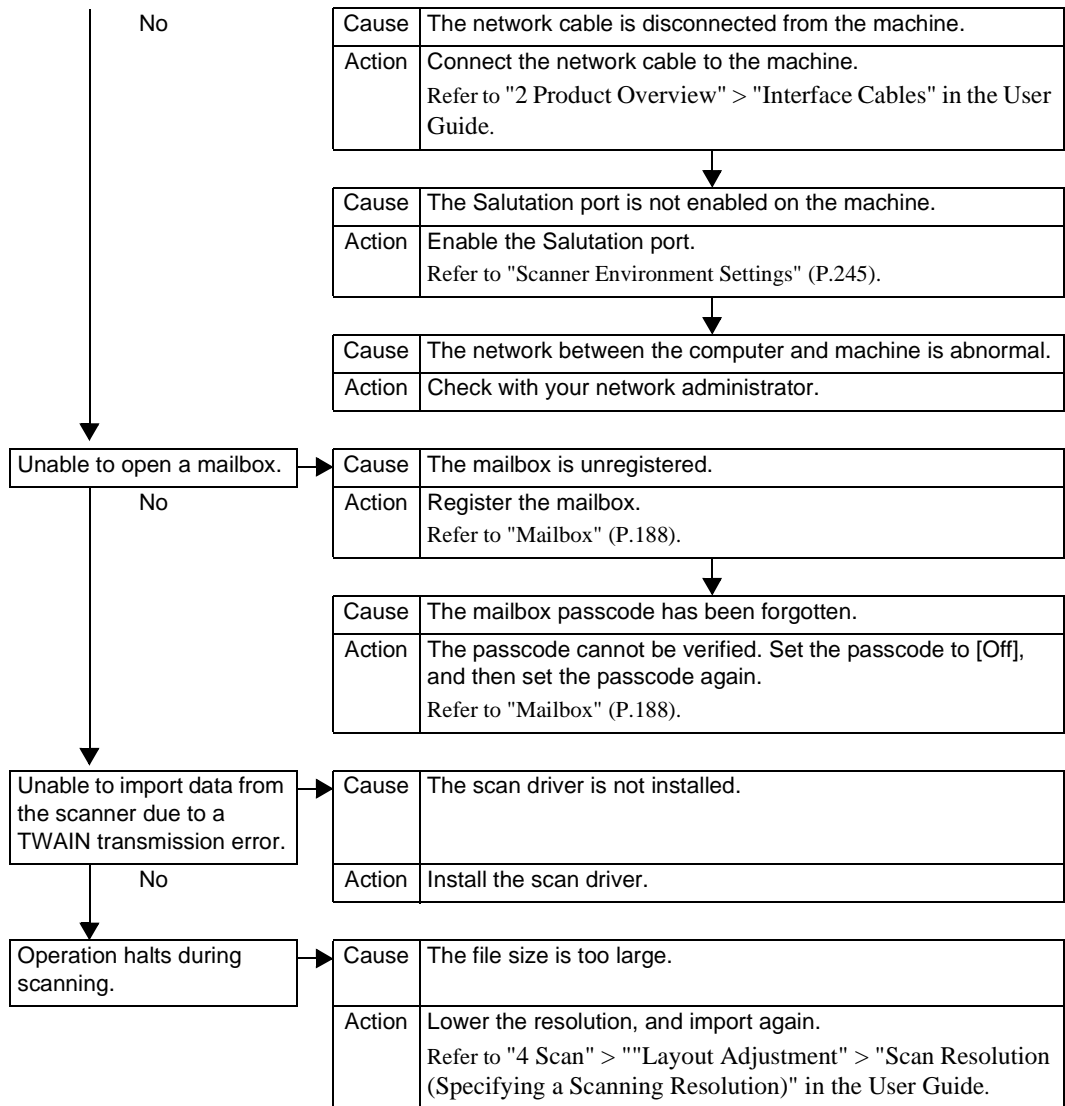

Unable to Send a Scanned Document over the Network (FTP/SMB)

Follow the procedure below if you cannot send a scanned document over the network.

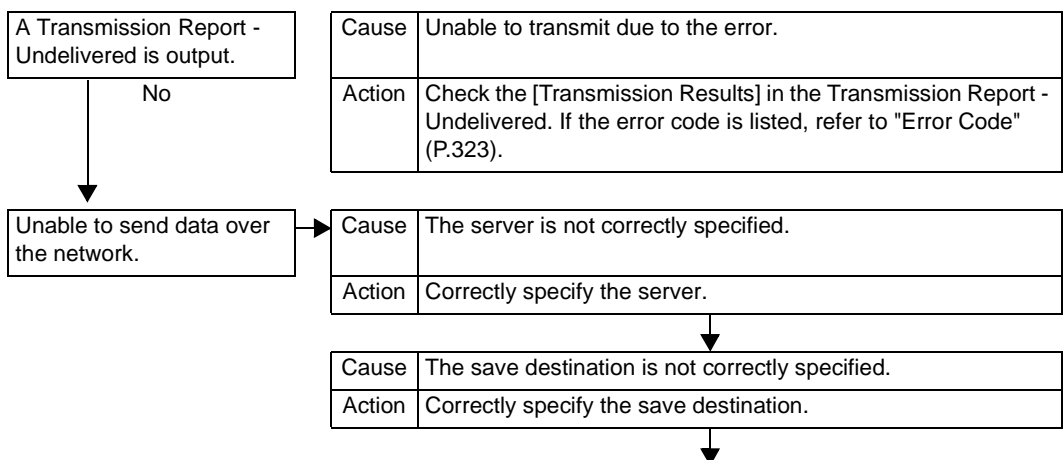

Cause	When using SMB, the shared name is not correctly specified.
Action	Correctly specify the shared name.
Cause	When using SMB (UNC Format), the save destination is not correctly specified.
Action	Correctly specify the save destination.
Cause	The login name is not entered correctly.
Action	Correctly enter the login name.
Cause	The password is not correctly entered.
Action	Correctly enter the password.
Cause	The time setting on the machine does not agree with that of Windows, when SMB transmission to Windows Server 2003.
Action	Synchronize the time settings of the machine and Windows.
Cause	On Windows Server 2003 or Windows XP, users who do not set a password cannot use SMB transmission.
Action	Follow the steps below to change the settings of network access. 1. Start Windows, and select [Control Panel] > [Administrative Tools] > [Local Security Policy]. 2. Select [Security Settings] > [Local Policies] > [Security Options]. 3. Change [Account: Restrict empty password from local account to console login only] to [Disabled].
Cause	On Windows 2000, Windows Server 2003 or Windows XP, SMB transmission using the SMB direct host feature is not available.
Action	The SMB direct host feature (SMB transmission that does not require NetBIOS) is not supported. Change [NetBIOS over TCP/IP] to [Enabled].
Cause	SMB transmission is not available when a DFS access path (\\Domain name\Shared name) is designated.
Action	The DFS access path is not supported. Use the UNC path (\\Host name\Shared name) instead.

Unable to Send E-mail

Follow the procedure below if you cannot send a scanned document using the e-mail feature.

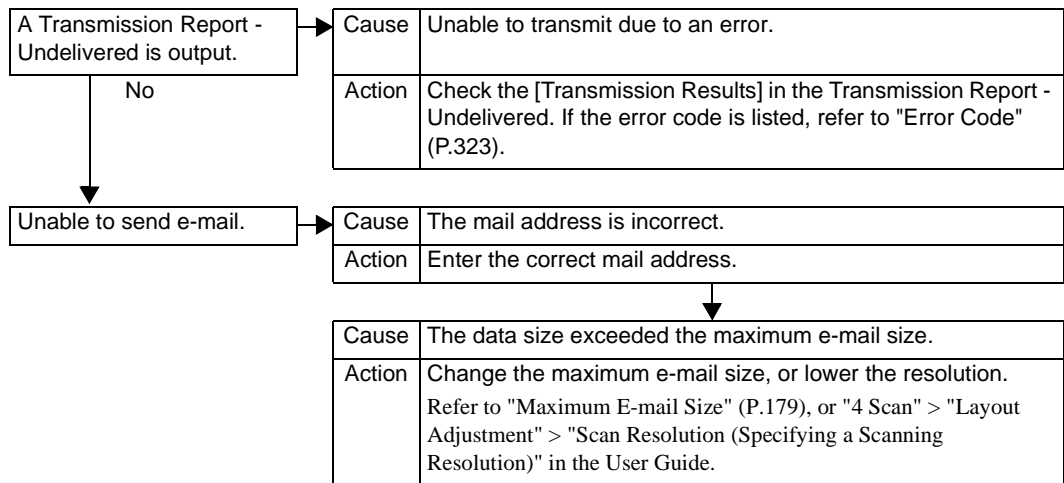

The Image is not What was Expected

Follow the procedure below if the image is not what was expected.

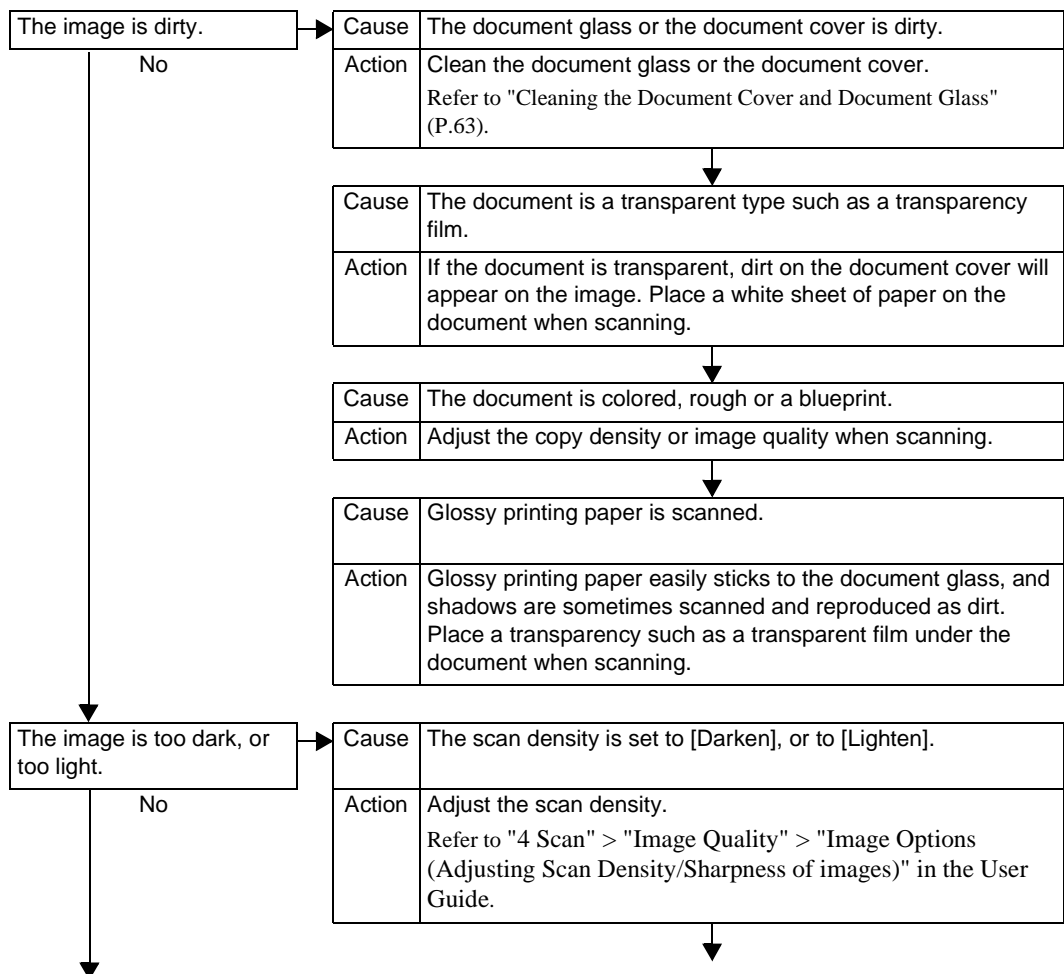

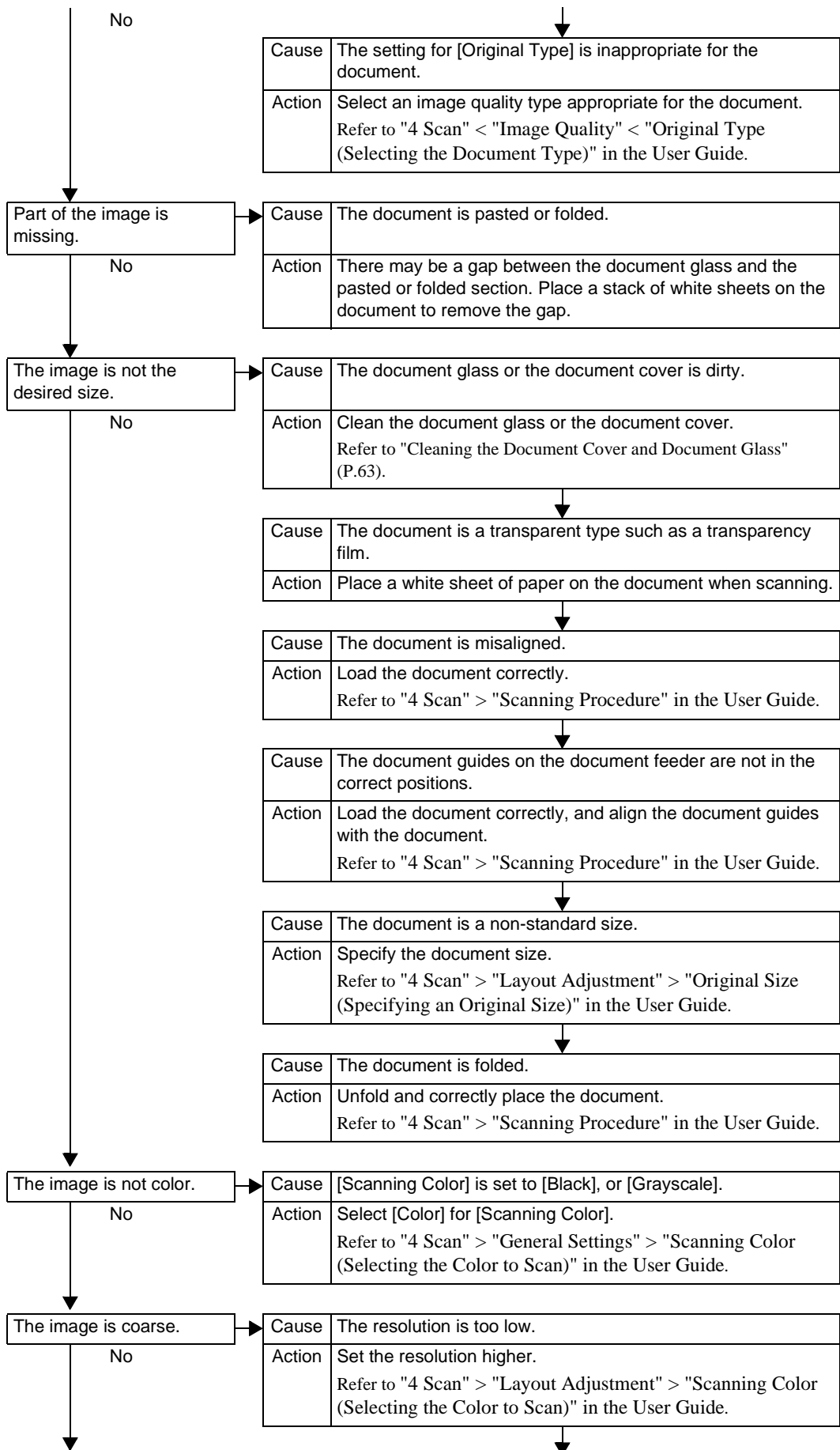

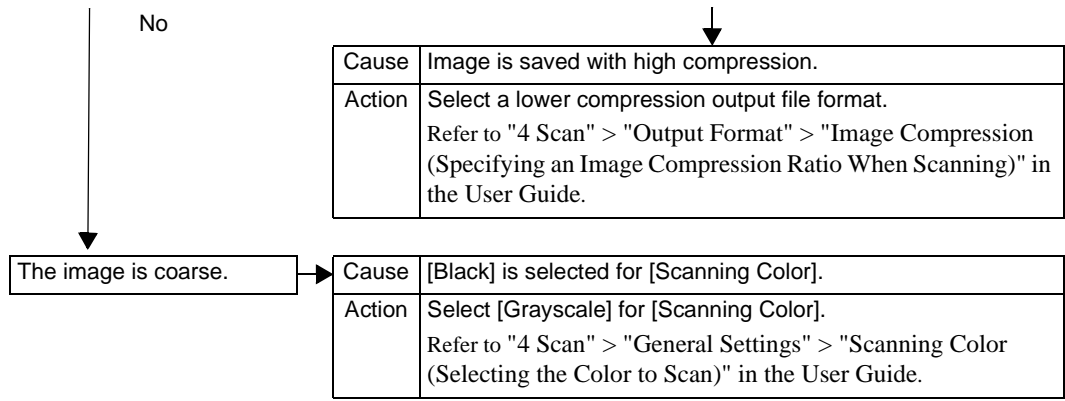

Network-related Problems

This section describes how to solve network related problems.

When using SMB

The possible causes, check points, and remedies for problems when using SMB are as follows.

When you cannot communicate with the printer

Cause	Check point	Remedy
The computer and the machine are using different protocols.	While [Search for Other Computers] ([Start] > [Search] > [Other Computers]) on the computer is showing the printer, [Network Computer] does not show the printer.	Configure the machine and each computer to use the same SMB operational protocol.
The machine belongs to different networks (subnets).	While [Search for Other Computers] ([Start] > [Search] > [Other Computers]) on the computer is showing the printer, [Network Computer] does not show the printer.	When the machine and the computers are on different networks, consult your network administrator.
The host name for the machine is already in use.	Print out [System Settings List] to confirm if "Repetitive Host Name" is printed in the SMB status information.	Use CentreWare Internet Services to change the host name to a unique name, or initialize the machine settings to their default.

When you cannot communicate with the printer or other SMB machines

Cause	Check point	Remedy
If [Auto Master Mode] of SMB is set to [On], the number of machines whose information can be stored is limited. That depends on the network environment.	The machine or other SMB machines cannot be searched from the Network Computers icon.	Confirm the setting of [Auto Master Mode] of SMB. If enabled, change the setting to [Off].

When you cannot print

Cause	Check point	Remedy
The machine is processing a request from a different computer. (When [SMB (Spool)] is set to [Off])	Confirm the machine is processing a print job. (A write error dialog should be displayed to indicate that there is no room for the print job.)	Wait till the machine finishes processing the print job, or change the machine setting to [Spool] mode.

Cause	Check point	Remedy
Number of connections to the machine exceeded the maximum connections allowed.	Confirm if the machine is processing simultaneous requests (print requests, status queries, etc.) from multiple computers. (A write error dialog should be displayed to indicate that no more remote computers can be connected.)	Wait for a while and retry printing.

When you cannot delete documents from the [Printer] window

Cause	Check point	Remedy
You are trying to delete all print data displayed in the [Printer] window. (Only the system administrator is allowed to delete all data.)	Confirm whether you are trying to delete the print data from the [Printer] menu. ([Clear Print Jobs] menu.)	Select the print data to be deleted, and delete from the [Document] menu in the [Printer] window. ([Cancel Printing] menu.)
The print data has a different owner.	Confirm if the name displayed as the owner for the selected print data and the user's login name to Windows are the same.	Login to Windows using the owner's name and then delete the print data.

Others

Symptom	Remedy
The message "Unknown document name" is displayed at the job name in the job history instead of the correct job name.	Change the setting of the SMB receiving buffer to [Hard Disk Spool] or [Memory Spool].

When using NetWare

The possible causes, check points, and remedies for problems when using NetWare are as follows.

When you cannot print

Cause	Check point	Remedy
Network equipment (hubs, etc.) are not supporting automatic frame type detection.	Check the network equipment to see if the data link indicator of the port where the machine is connected is lit. Confirm if the frame types used by the file servers on the network are standardized.	Set the machine's frame type to the same type as the connected file server.

Cause	Check point	Remedy
A problem occurred on the network between the computer and the machine.	Use NWADMIN on the computer to confirm if the machine object can be browsed.*	Replace the faulty network cable installed between the computer and the machine.
Job sender (user or group name) is not specified in [User] for the print queue.	Use NWADMIN from a computer to confirm that the print queue object [User] information lists the job sender (user or group name).*	Re-transmit the print data to the print queue whose [User] information includes the job sender (user or group name).
		Use NWADMIN from a computer to register job sender (user or group name) to [User] of [Print Queue].*
Job transmission to the print queue is prohibited.	Use PCONSOLE to confirm if [User can register to the queue] is set to [Yes] under [Current Queue Status] of [Print Queue].	Use PCONSOLE to set the item to [Yes].
	Use NWADMIN on the computer to confirm if [Recognition] of the print queue has the operator class checked.*	Use NWADMIN on a computer to confirm if [Recognition] of the print queue has each item of the operator class checked.*
Job sender (user or group name) is not specified in the user setting for the print server.	Use NWADMIN from a computer to confirm that the print server's [User] information lists the job sender (user or group name).*	Re-transmit the print data to the print queue whose [User] of [Print Server Information] includes the job sender (user or group name).
		Use NWADMIN from a computer to register job sender (user or group name) to [User] information of the print server.*
The print queue where the user has transmitted the print data, is not assigned to the machine.	Use NWADMIN from a computer to check the print queue [Assignment] to see if the machine is in the printer list serviced by the print queue.*	Re-transmit the print data to the print queue which is assigned to the machine.*
		Use NWADMIN from a computer to add the print queue to the machine.*
Print data format and the print environment settings on the computer do not match.	-	If the computer is running on Windows, set it not to output <Ctrl>-D.
The number of print queues set for the machine exceeds the maximum number of supported queues on the machine.	Use NWADMIN from a computer to check the machine's [Assignment] print queue list to see if the desirable print queue is assigned to the machine.*	Re-transmit the print data to the print queue which is assigned to the machine.*

Cause	Check point	Remedy
The slave file server is not configured. ([Bindery Service] mode)	Use PCONSOLE from a computer to confirm if the slave file server is registered to [Service NetWare Server] on the print server indicated by [Print Server Information].*	Use PCONSOLE from a computer to register the slave file server and propagate the configuration parameters.
Printer types do not match.	Use PCONSOLE from a computer to confirm if the printer type is set to parallel, port is set to LPT1 and location is set to automatic mode (local) under [Print Server Information] > [Printer] > [Printer xxx Environment Configuration].*	Use PCONSOLE from a computer to set the printer type to parallel, port to LPT1, location to automatic mode (local) and propagate the configuration parameters.*
The slave file server configuration is mismatched. ([Bindery Service] mode)	Use PCONSOLE from a computer to confirm if the printer type is set to [Defined Elsewhere] under [Print Server Information] > [Printer] > [Printer xxx Environment Settings].*	If not set to [Defined Elsewhere], change to [Defined Elsewhere] and propagate the configuration parameter.*
The form number on the print data and the form number set to the printer do not match.	Use NWADMIN on a computer to select the machine and confirm that the start number of the form in the environment setting matches the number in the print data.*	Use NWADMIN from a computer to match the [Start Form] number in the machine's environment setting to the number in the print data.*
The level settings for the IPX checksum do not match.	Use the set command from the console screen on the file server and confirm whether the IPX checksum is set to level 2.	Enter the following command from the console screen on the file server to set the IPX checksum to either level 0 or level 1. set Enable IPX Checksum=x (x = 0 or 1)
The level settings for the NCP packet signature do not match.	Use the set command from the console screen on the file server and confirm whether the NCP packet signature is set to level 3.	Enter the following command from the console screen on the file server to set the NCP packet signature to either level 0, 1, or 2, and restart the file server. set NCP Packet Signature Option=x (x = 0, 1, or 2)
The default device name is incorrect.	Print out either [System Settings List] to confirm the last 6 digits (3 bytes) of the Ethernet address.	Set the device name using the correct Ethernet address. Set the device name different from the default name.
The directory tree name is not configured.	Print out [System Settings List] to confirm if the tree name is specified.	Set the tree name.

Cause	Check point	Remedy
The context is not set.	Print out [System Settings List] to confirm if the context is specified.	Set the context.
Connected to a different printer object.	Use NWADMIN from a computer to confirm if the correct object is assigned using the layout information of the print server.*	Use Driver CD Kit CD-ROM from a computer to correctly set the file server name/tree name/context/active mode.
		Use CentreWare Internet Services from a computer to correctly set the file server name/tree name/context/active mode.
The NetWare port on the machine is not set to "Enable".	Print out [System Settings List] to confirm if the NetWare port is enabled.	Enable the NetWare port.
The file server is down.	Search for the file server using [Network Neighborhood].	Start the file server.
There is another device on the network with an identical device name.	Switch off the machine and use NWADMIN from a computer to confirm that the status of the printer object is "Standby".	Use the Driver CD Kit CD-ROM from a computer to set a different device name.
The NetWare port is not functioning.	Print out [System Settings List] to confirm if the network number is left to "0000000" (NetWare server is down) if using IPX/SPX. If using TCP/IP, confirm if the IP address is left to "0.0.0.0" (static address unspecified, or the DHCP server is down).	For the case of IPX/SPX, start the NetWare server. For the case of TCP/IP, either set a static IP address or start the DHCP server.

*:Refer to NetWare Online Documentation for configuration and operations.

When "Switch the machine off" is displayed

Cause	Check point	Remedy
A NetWare problem occurred.	-	Restart the machine. Switch on the machine after the display completely disappears.

When the print output is not as you expected

Cause	Check point	Remedy
The print language of the print data and the print language configured on the machine are different.	Confirm the print language on the machine.	Match the print language of the print data and the print language configured on the machine.

When no notification is received

The possible causes, check points and remedies when no notification is received on the computer which instructed a print job are as follows.

■When the printing problems are not notified

Cause	Check point	Remedy
The user is not listed on the print server notification recipients.	Use PCONSOLE on the computer to check if the job user or user's group has been registered under [Print Server Information] > [Printer] > [Printer xxx Environment Settings] > [Notify].	Add the name of the job user or the name of the user's group to [Notify].

■When the completion of the job is not notified

Cause	Check point	Remedy
The [Notify] option is not specified when the computer transmitted the print data.	Confirm if the [Notify] option is specified when transmitting the print data.	Specify the [Notify] option when transmitting the print data.
Netware command [CASTOFF] has been issued on the computer.	-	Issue the NetWare command [CASTON] on the computer.

When using TCP/IP

The possible causes, check points, and remedies for problems when using TCP/IP (LPD) are as follows.

Windows 2000, Windows XP, or Windows Server 2003

■When you cannot print

Cause	Check point	Remedy
The IP address is incorrect.	Request your network administrator to check the machine's IP address.	Set a correct IP address on the machine.
The volume of the print data of an instruction from a computer exceeded the maximum receivable volume when the LPD spool is set to memory spool.	Confirm the memory amount for the LPD spool and compare against the volume of the print data transmitted by an instruction.	If the print data is one file and still exceeds the memory amount, divide the file to make one instruction smaller than the memory. If the print data is multiple files and exceeds the memory amount, decrease the number of files to print at once.
An unrecoverable error occurred during the printing process.	Confirm if any error messages are displayed on the control panel.	Restart the machine. Switch on the machine after the display completely disappears.

Cause	Check point	Remedy
The machine is not set to the transport protocol which matches the protocol on the computer.	Confirm the transport protocol selected on the machine.	Select the transport protocol which matches the computer's protocol.
The data format the machine is trying to process does not match the data format of the print data transmitted from a computer.	-	Set not to output <Ctrl>-D.

■When the print output is not as you expected

Cause	Check point	Remedy
Selected print language on the machine does not match the print language of the print data.	Confirm the selected print language on the machine and the print language of the print data.	Select the print language on the machine to match the print data.
The computer is not using the print driver supplied with the machine (using another company's print driver).	Confirm if the print driver on the computer is the one supplied with the machine.	Select the print driver supplied with the machine on the computer. If it does not appear on the selection list, install the print driver supplied with the machine and then select it. The operation is not guaranteed if another print driver is used.

When using EtherTalk

The possible causes, check points, and remedies for problems when using EtherTalk are as follows.

Cause	Check point	Remedy
Documents are printed by a printer that is not selected.	If a printer that is assigned the same printer name has already existed on the network, one of the printer names is automatically changed during boot-up. Therefore, depending on the timing of powering on the printer, the name of the printer assigned may be different from the printer name used before. As a result, the printer name is automatically changed, and documents are printed by a printer that is not selected.	A printer that is assigned the same printer name may exist on the network. Confirm the printer name. If duplicated, change the printer name.

Cause	Check point	Remedy
The printer cannot be browsed from clients.	If the printer is turned on before it is connected to a network, clients may not be able to identify the printer name and therefore cannot browse the printer.	Turn the printer on after connecting to the network. If the printer is activated while disconnected from the network, turn the machine off, connect it to the network, and then turn the printer on again.

CentreWare Internet Services Problems

The possible causes, check points, and remedies for problems when using CentreWare Internet Services are as follows.

Symptom	Remedy
Cannot connect to CentreWare Internet Services	Is the machine working properly? Check if the machine is powered on.
	Is Internet service (HTTP) port activated? Print out [System Settings List] to confirm.
	Is the Internet address correctly entered? Confirm the Internet address again. If the problem persists, enter an IP address to make a connection.
	Is a proxy server being used? Depending on the proxy server, connections may not be possible. Set the browser to "Not using proxy server" or set that particular address to "Not using a proxy server".
The "Please wait" message is displayed throughout.	Wait for a while as instructed. If the status does not change, click the [Refresh] button. If this does not have any effect, check if the machine is working properly.
The [Refresh] button does not work.	Are you using a specified browser? Refer to "Setting Items Using CentreWare Internet Services" (P.215) to confirm if your browser is supported.
Selecting the menu on the left frame does not update the right frame contents.	
The screen display is distorted.	Change the window size for the browser.
The latest information is not displayed.	Click the [Refresh] button.
Characters are not correctly displayed.	Use Western European language command. Or, do not use the single byte Kana characters.
The [Apply] button does not reflect the new settings.	Are all entered values correct? If a value outside of the permitted range is entered, the update will automatically be made within the range.
	This may occur when an user operation on the control panel is being performed or has just been completed. When the automatic reset function is configured, any setting by CentreWare Internet Services is not applied until setting time passes. Wait for a while as instructed.

Symptom	Remedy
Clicking the [Apply] button causes the browser to display "The server has returned ineffective or unrecognizable response" or "No data" message.	Has a correct password been supplied? The entries for Password and Confirm Password do not match. Enter the correct password.
	Restart the machine.
Cannot delete jobs.	Wait for a while and click the [Refresh] button.

E-Mail Features Problems

This section describes causes and recommended remedies for errors that may occur while using the mail notice service, the E-mail Printing, and the E-mail feature.

Symptom	Remedy
Cannot receive E-mail (E-mail Printing)	Is the e-mail address for the machine configured?
	Is [E-mail Receive] set to [Enabled]?
	Are IP addresses for the SMTP server and POP3 server (if POP3 is selected for the incoming mail protocol) configured correctly?
	Are the POP3 user name and password entered correctly?
	Is [Domain Filter] imposed? Confirm if your own domain is included in the permitted domain using CentreWare Internet Services.
	Are the SMTP server and/or POP server operating properly? Check with your network administrator.
Cannot transmit e-mail (mail notice service and E-mail)	Is the E-mail address for the machine configured?
	Is [Mail Notice Service] set to [Enable]? (For mail notice)
	Is [Send E-mail] set to [Enabled]?
	Is the IP address for the SMTP server configured correctly?
	Are the notification items for transmission set correctly? (For mail notice) Confirm the settings on the property screen using CentreWare Internet Services.
	Is the destination address entered correctly?
	Is the SMTP server operating properly? Check with your network administrator.

Internet/Intranet Connection Problems

The possible causes, check points, and remedies for problems when connecting to the Internet or intranet.

When connection to the Internet/Intranet fails

Cause	Remedy
The authentication feature used on the remote server is not supported by the machine.	Only Basic Authentication is supported by the machine. The machine does not support NTLM/digest. For security purposes, use the authentication feature using SSL.
The remote linkage services used does not support the model or accessories of the machine.	Purchase product/model/accessories supported by the remote linkage services.
The IP address is incorrect.	Confirm the IP address. If the IP address is not correct, either set the static IP address or resolve the IP address using DHCP or Autonet.
The IP gateway address is incorrect.	Set the correct IP gateway address when connecting to the proxy server, or a Web server through the IP gateway.
The subnet mask is incorrect.	Set the correct subnet mask corresponding to the environment you use.
The DNS server address is incorrect.	Confirm the DNS server address.
The DNS server selected cannot resolve the address.	Select a DNS server that can resolve the address. <ul style="list-style-type: none"> When connecting through the proxy server Set the IP address of a DNS server that can resolve the address of the proxy server. When connecting not through the proxy server Set the IP address of a DNS server that can resolve the destination address.
The address that does not go through a proxy server is incorrect.	Confirm if only addresses not through the proxy server are set. Even if addresses not through the proxy server are set with the FQDN format, if a server is directly accessed using its IP address, the registered server is not excluded. Set an address for the IP address that does not go through the proxy server. Even if the address that does not go through the proxy server is directly designated, if a server is accessed using the FQDN format, the registered server is not excluded. Set an IP address with the FQDN format that does not go through the proxy server.
The desired server, or the proxy server goes down.	Confirm if the desired server or the proxy server runs properly.
The network cable is not connected, or broken.	Check if the network cable is properly connected. We recommend spanning-tree configuration, with which network disconnection rarely occurs.
Communication cannot be established due to overloading of the server application.	Wait for a while and try to access again.

Cause	Remedy
An error occurs that is not displayed on the control panel.	When an error occurs while a background processing is running, no message appears on the control panel. Display the [Job Status] screen, or print the job history report to confirm the result.
Cannot access to the proxy server, firewall, or a Web server due to its access control.	<p>The following types of access control are used. Confirm the configured access control.</p> <ul style="list-style-type: none"> • Address (port) restriction • SSL restriction • User access restriction (including access right levels) • Content block • Scheme restriction (cannot use HTTP etc.) • Transfer data size restriction • Method restriction (cannot use POST etc.) • HTTP header restriction (only accepting a specified browser etc.) • Time restriction (only available during a specific period of time etc.)

When connection to a desired Web server fails

Cause	Remedy
The settings to use the proxy server is not configured.	In the environment using the proxy server, the machine should be configured to use the proxy server. Otherwise, you cannot connect to a desired Web server. Make the settings to use the proxy server.
The settings to use the proxy server is configured even though the environment does not go through the proxy server.	In the environment that does not use the proxy server such as connecting to an intranet, do not make the settings to use the proxy server.
The proxy server address is incorrect.	When the settings to use the proxy server are configured, you cannot connect to a desired Web server unless the IP address of the proxy server is correct. Set the correct IP address of the proxy server.
When the proxy server requires authentication, cannot connect to the server because the user name or password is incorrect.	Set the user name and password to the machine that are allowed to connect to the proxy server.

Error Code

This section explains error codes.

If an error caused printing to end abnormally, or a malfunction occurred in the machine, then an error message code (***-***) is displayed.

Refer to the following table for error codes to rectify problems.

Important • If an error code is displayed, any print data remaining on the machine and information stored in the machine's memory is not warranted.

If an error code appears that is not listed in the table below, or if an error persists after following the listed solution, contact our Customer Support Center. The contact number is printed on the label or card attached on the machine.

Errors are classified into the following categories.

C: Copy

P: Print

S: Scan

M: Mail

O: Others

Error Code	Category					Cause and Remedy
	C	P	S	M	O	
002-770			O		O	[Cause] Unable to process the job template due to insufficient hard disk space. [Remedy] Remove unnecessary data from the hard disk to increase free disk space.
003-701	O		O			[Cause] A digital code is embedded in the document to restrict duplication. [Remedy] Use a document that no digital code is embedded in.
003-702	O		O			[Cause] When making 2-Sided copies using Build Job feature, a ratio does not match of the front side and the back side. [Remedy] Make sure to match the ratio of the front side and the back side.
003-750	O					[Cause] Unable to store any documents using the 2-Sided Book Copy feature. [Remedy] Check the 2-Sided Book Copy settings. Refer to "3 Copy" > "Layout Adjustment" > "2 Sided Book Copy (Making 2 Sided Copies of Facing Pages)" in the User Guide.
003-751	O		O			[Cause] Unable to process, because the specified document area is too small. [Remedy] Increase the resolution or scan area.
003-752			O			[Cause] The mixed sized document was to be scanned at 600dpi with Color/2 Sided. [Remedy] Set [Scan Resolution] to [400dpi] or lower, and try again.
003-753			O			[Cause] The mixed sized document was to be scanned with high resolution using the 2-sided feature. [Remedy] Set [Scan Resolution] to [200dpi], and try again.

* If the error persists after following the listed solution, contact our Customer Support Center. The contact number is printed on the label or card attached on the machine.

Error Code	Category					Cause and Remedy
	C	P	S	M	O	
003-754 003-755			○			[Cause] An error occurred in the document feeder. [Remedy] Execute the job again.
003-757			○			[Cause] The mixed sized document was to be scanned with high resolution using the 2-sided feature. [Remedy] Set [Scan Resolution] to [300dpi] or lower, and try again.
003-760			○			[Cause] An incompatible combination of features are specified as document scan conditions. [Remedy] Check the selected options.
003-761	○	○				[Cause] The paper size of the tray selected for auto tray is different from the paper size of the tray selected for Auto Tray Switching. [Remedy] Change the paper size for the tray, or change the [Paper Type Priority] settings.
003-763					○	[Cause] An error occurred when reading the Calibration Chart. [Remedy] Place the Adjustment Chart properly on the document glass. Refer to "Executing Calibration" (P.66).
003-795	○					[Cause] When enlarging/reducing a scanned document to the specified paper size, the reduction/enlargement ratio value is out of allowed range. [Remedy] Take one of the following actions: • Manually enter a reduction/enlargement ratio. • Change the paper size.
005-274 005-275 005-280 005-281 005-282 005-283 005-284 005-285 005-286 005-287					○	[Cause] An error occurred in the document feeder. [Remedy] Turn the machine off and on. If the error persists, contact our Customer Support Center.

* If the error persists after following the listed solution, contact our Customer Support Center. The contact number is printed on the label or card attached on the machine.

Error Code	Category					Cause and Remedy
	C	P	S	M	O	
012-211 012-212 012-213 012-214 012-215 012-216 012-217 012-218 012-219 012-221 012-223 012-224 012-225 012-226 012-227 012-228 012-229 012-230 012-235 012-236 012-237 012-238 012-239 012-240 012-241 012-243					O	[Cause] Finisher malfunction [Remedy] Turn the machine off and on. If the error persists, contact our Customer Support Center.
012-246					O	[Cause] The Booklet Maker is not fully inserted in the C-Finisher with Booklet Maker. [Remedy] Fully insert the Booklet Maker, and turn the machine off and on.
012-247 012-248 012-250 012-251 012-252 012-253					O	[Cause] Finisher malfunction [Remedy] Turn the machine off and on. If the error persists, contact our Customer Support Center.
012-254					O	[Cause] The sensor was activated because paper output to the finisher was removed before the finisher tray lowered and completely stopped in position. Or, there is a foreign object under the finisher tray. [Remedy] If there is any foreign object under the finisher tray, remove it and then turn the machine off and on. If the error persists, contact our Customer Support Center.

* If the error persists after following the listed solution, contact our Customer Support Center. The contact number is printed on the label or card attached on the machine.

Error Code	Category					Cause and Remedy
	C	P	S	M	O	
012-255 012-260 012-261 012-263 012-264 012-265 012-266 012-270 012-271 012-282 012-283 012-284 012-291 012-295 012-296					O	[Cause] Finisher malfunction [Remedy] Turn the machine off and on. If the error persists, contact our Customer Support Center.
016-210 016-211 016-212 016-213 016-214 016-215 016-216 016-217 016-218 016-219					O	[Cause] Software error [Remedy] Turn the machine off and on. If the error persists, contact our Customer Support Center.
016-220 016-221 016-222 016-223 016-224 016-225 016-226 016-227 016-228					O	[Cause] An error occurred in the document feeder. [Remedy] Turn the machine off and on. If the error persists, contact our Customer Support Center.
016-229 016-230					O	[Cause] Software error [Remedy] Turn the machine off and on. If the error persists, contact our Customer Support Center.
016-231					O	[Cause] Image Expansion Kit may be broken, or may not be installed correctly. [Remedy] Turn the machine off and on. If the error persists, contact our Customer Support Center.
016-240					O	[Cause] An error occurred in the document feeder. [Remedy] Turn the machine off and on. If the error persists, contact our Customer Support Center.

* If the error persists after following the listed solution, contact our Customer Support Center. The contact number is printed on the label or card attached on the machine.

Error Code	Category					Cause and Remedy
	C	P	S	M	O	
016-450					O	[Cause] The host name already exists. [Remedy] Change the host name. Refer to "Machine's E-mail Address/Host Name" (P.160).
016-454					O	[Cause] Unable to retrieve the IP address from DNS. [Remedy] Check the DNS configuration and IP address retrieve setting. For information about the DNS Settings, refer to the CentreWare Internet Services's online help. For information about the IP address, refer to "TCP/IP - Get IP Address" (P.159).
016-455					O	[Cause] Connection to the SNTP server was timed out. [Remedy] Check the network cable connection and the IP address of the SNTP server.
016-456					O	[Cause] Received from the SNTP server a message saying that it was not synchronized with the standard time source. [Remedy] Check the SNTP server settings.
016-461					O	[Cause] If [High] has been selected for [Forwarding Secure Level] under [Forward Image Log] and image log forwarding was interrupted for some reason, a new job cannot be created due to creation restriction. [Remedy] Check the status of the network or image log server to take measures for this image log forwarding problem. Take one of the following actions: <ul style="list-style-type: none"> • Check the forwarding settings, and forward all the unforwarded logs again. • Change the [Forwarding Secure Level] setting for image logs to [Low]. Note that selecting [Low] may delete the unforwarded image logs.
016-503					O	[Cause] Unable to resolve the SMTP server name when sending e-mail. [Remedy] Check on the CentreWare Internet Services if the SMTP server settings are correct. Also, check the DNS server settings.
016-504					O	[Cause] Unable to resolve the POP3 server name when sending e-mail. [Remedy] Check on CentreWare Internet Services if the POP3 server settings are correct. Also, check the DNS server settings.
016-505					O	[Cause] Unable to login to the POP3 server when sending e-mail. [Remedy] Check on CentreWare Internet Services if the user name and password used in the POP3 server are correct.
016-506					O	[Cause] Unable to write the image log because the image log saving space is insufficient on the machine. [Remedy] Execute the job again. If this error persists, take one of the following actions: <ul style="list-style-type: none"> • Delete unnecessary image logs. • Change the [Creation Secure Level] setting for image logs to [Low]. Note that selecting [Off] will not secure the contents of created image logs.

* If the error persists after following the listed solution, contact our Customer Support Center. The contact number is printed on the label or card attached on the machine.

Error Code	Category					Cause and Remedy
	C	P	S	M	O	
016-507					O	[Cause] Failed to forward the image log to the server using the Image Log Control feature. [Remedy] Either set the machine's image log forwarding rule on the server, or set [Auto Transfer] to [Off] under [Forward Image Log].
016-508					O	[Cause] Failed to forward the image log to the server using the Image Log Control feature. [Remedy] Set the machine's image log forwarding rule on the server.
016-509					O	[Cause] Failed to forward the image log to the server using the Image Log Control feature because the machine's image log forwarding rule has not been set on the server. [Remedy] Either set the machine's image log forwarding rule on the server, or set [Auto Transfer] to [Off] under [Forward Image Log].
016-510					O	[Cause] Failed to forward the image log to the server using the Image Log Control feature because the machine's image log forwarding rule has not been set on the server. [Remedy] Set the machine's image log forwarding rule on the server.
016-511 016-512					O	[Cause] Failed to forward the image log to the server using the Image Log Control feature because the machine's image log forwarding rule has not been set on the server correctly. [Remedy] Set the machine's image log forwarding rule on the server.
016-513			O			[Cause] A time-out occurred while the machine was waiting for a response from the SMTP server. [Remedy] The server or network may be overloaded. Wait for a while, and try again.
016-522			O			[Cause] LDAP server SSL authentication error. Unable to get an SSL client certificate. [Remedy] The LDAP server is requesting an SSL client certificate. Set an SSL client certificate on the machine.
016-523			O			[Cause] LDAP server SSL authentication error. The server certificate data is incorrect. [Remedy] The machine cannot trust the SSL certificate of the LDAP server. Register the root certificate for the LDAP server's SSL certificate to the machine.
016-524			O			[Cause] LDAP server SSL authentication error. The server certificate will expire soon. [Remedy] Change the SSL certificate of the LDAP server to a valid one. This error can be cleared if you select [Off] for [LDAP - SSL/TLS Communication] under [SSL/TLS Settings] on the machine; however, note that selecting this option will not ensure the validity of the LDAP server.
016-525			O			[Cause] LDAP server SSL authentication error. The server certificate has expired. [Remedy] Change the SSL certificate of the LDAP server to a valid one. This error can be cleared if you select [Off] for [LDAP - SSL/TLS Communication] under [SSL/TLS Settings] on the machine; however, note that selecting this option will not ensure the validity of the LDAP server.

* If the error persists after following the listed solution, contact our Customer Support Center. The contact number is printed on the label or card attached on the machine.

Error Code	Category					Cause and Remedy
	C	P	S	M	O	
016-526			O			[Cause] LDAP server SSL authentication error. The server name does not match the certificate. [Remedy] Set the same LDAP server address to the machine and to the SSL certificate of the LDAP server. This error can be cleared if you select [Off] for [LDAP - SSL/TLS Communication] under [SSL/TLS Settings] on the machine; however, note that selecting this option will not ensure the validity of the LDAP server.
016-527			O			[Cause] LDAP server SSL authentication error. This is an SSL authentication internal error. [Remedy] Software has a problem. Contact our Customer Support Center.
016-533					O	[Cause] Kerberos server authentication protocol error [Remedy] The time difference between the machine and the Kerberos server exceeded the clock skew limit value set on the Kerberos server. Check if the clocks on the machine and Kerberos server are correctly set. Also Check the settings of the summer time and the time zone as well on the machine and Kerberos server.
016-534					O	[Cause] Kerberos server authentication protocol error [Remedy] The realm set on the machine does not exist on the Kerberos server, or the Kerberos server address set on the machine is invalid for connection. Check if the realm name and the server address have been correctly set on the machine. For connection to Windows 2000 or Windows 2003 Server, specify the realm name in uppercase.
016-539					O	[Cause] Kerberos server authentication protocol error [Remedy] An error occurred on the software. Contact our Customer Support Center.
016-546					O	[Cause] A general user tried to obtain the information of another user. [Remedy] Contact our Customer Support Center.
016-574			O			[Cause] The machine failed to transfer data using [FTP] of the [Scan to PC] feature because the host or server name of the FTP server could not be resolved. [Remedy] Check the connection to the DNS server. Check if the FTP server name is registered correctly on the DNS server.
016-575			O			[Cause] The machine failed to transfer data using [FTP] of the [Scan to PC] feature because the DNS server address was not registered. [Remedy] Specify the correct DNS server address. Or, specify the destination FTP server using its IP address.
016-576			O			[Cause] The machine failed to transfer data using [FTP] of the [Scan to PC] feature because it could not connect to the FTP server. [Remedy] Ensure that both the destination FTP server and the machine are available for network communications, by checking the following: <ul style="list-style-type: none"> • The IP address of the server is set correctly. • The network cables are plugged in securely.

* If the error persists after following the listed solution, contact our Customer Support Center. The contact number is printed on the label or card attached on the machine.

Error Code	Category					Cause and Remedy
	C	P	S	M	O	
016-577			O			[Cause] Unable to connect to the FTP service of the destination server. [Remedy] Take one of the following actions: <ul style="list-style-type: none"> • Check if the FTP service of the server is activated. • Check if the FTP port number of the server is correctly registered on the machine.
016-578			O			[Cause] The machine failed to transfer data using [FTP] of the [Scan to PC] feature due to unsuccessful login to the FTP server. [Remedy] Check if the login name (user name) and password are correct.
016-579			O			[Cause] The machine failed to transfer data using [FTP] of the [Scan to PC] feature because the scanned image could not be saved in the FTP server after connection. [Remedy] Check if the FTP server's save location is correct.
016-580			O			[Cause] The machine failed to transfer data using [FTP] of the [Scan to PC] feature because the file or folder name on the FTP server could not be retrieved after connection. [Remedy] Check the access privilege to the FTP server.
016-581			O			[Cause] The machine failed to transfer data using [FTP] of the [Scan to PC] feature because the suffix of the file or folder name exceeded the limit after connection. [Remedy] Change the file name, or change the destination folder on the FTP server. Or, move or delete files from the destination folder.
016-582			O			[Cause] The machine failed to transfer data using [FTP] of the [Scan to PC] feature because file creation was not successful on the FTP server after connection. [Remedy] Take one of the following actions: <ul style="list-style-type: none"> • Check if the specified file name can be used in the save location. • Check if enough space is available in the save location.
016-583			O			[Cause] The machine failed to transfer data using [FTP] of the [Scan to PC] feature because lock folder creation was not successful on the FTP server after connection. [Remedy] Take one of the following actions: <ul style="list-style-type: none"> • If any lock directory (.LCK) exists in the forwarding destination, delete it manually, then try executing the job again. • Check if the specified folder name can be used in the save location. • Check if the same folder name exists in the save location. • Check if enough space is available in the save location.
016-584			O			[Cause] The machine failed to transfer data using [FTP] of the [Scan to PC] feature because folder creation was not successful on the FTP server after connection. [Remedy] Take one of the following actions: <ul style="list-style-type: none"> • Check if the specified folder name can be used in the save location. • Check if the same folder name exists in the save location. • Check if enough space is available in the save location.

* If the error persists after following the listed solution, contact our Customer Support Center. The contact number is printed on the label or card attached on the machine.

Error Code	Category					Cause and Remedy
	C	P	S	M	O	
016-585			O			[Cause] The machine failed to transfer data using [FTP] of the [Scan to PC] feature because file deletion was not successful on the FTP server after connection. [Remedy] Check the access privilege to the FTP server.
016-586			O			[Cause] The machine failed to transfer data using [FTP] of the [Scan to PC] feature because lock folder deletion was not successful on the FTP server after connection. [Remedy] Take one of the following actions: • Check the access privilege to the FTP server. • If any lock directory (.LCK) exists in the forwarding destination, delete it manually, then retry executing the job.
016-587			O			[Cause] The machine failed to transfer data using [FTP] of the [Scan to PC] feature because folder deletion was not successful on the FTP server after connection. [Remedy] Check the access privilege to the FTP server.
016-588			O			[Cause] The machine failed to transfer data using [FTP] of the [Scan to PC] feature because the data could not be written in the FTP server after connection. [Remedy] Check if enough space is available in the save location.
016-589			O			[Cause] The machine failed to transfer data using [FTP] of the [Scan to PC] feature because the data could not be read from the FTP server after connection. [Remedy] Check the access privilege to the FTP server.
016-590			O			[Cause] The machine failed to transfer data using [FTP] of the [Scan to PC] feature because the file could not be saved in the FTP server; [File Name Conflict] may be set to [Cancel Job]. [Remedy] Set [File Name Conflict] to any item other than [Cancel Job].
016-591			O			[Cause] The machine failed to transfer data using [FTP] of the [Scan to PC] feature because the filing policy was invalid. [Remedy] When [File Name Conflict] is set to [Change Name and Save], make sure the file format is not Multiple-Page.
016-592			O			[Cause] The machine failed to transfer data using [FTP] of the [Scan to PC] feature because access to the NEXTNAME.DAT file was not successful after connection to the FTP server. [Remedy] When [File Name Conflict] is set to [Change Name and Save], check the NEXTNAME.DAT file is correct.
016-593			O			[Cause] The machine failed to transfer data using [FTP] of the [Scan to PC] feature because an internal error occurred after connection to the FTP server. [Remedy] Try again. If the error persists, contact our Customer Support Center.
016-594 016-595 016-596			O			[Cause] The machine failed to transfer data using [FTP] of the [Scan to PC] feature because a network error occurred. [Remedy] Try again. If the error persists, contact our Customer Support Center.

* If the error persists after following the listed solution, contact our Customer Support Center. The contact number is printed on the label or card attached on the machine.

Error Code	Category					Cause and Remedy
	C	P	S	M	O	
016-597			○			<p>[Cause] The transfer processing using [FTP] of the [Scan to PC] feature was cancelled after connection to the FTP server, because the same file or folder name existed.</p> <p>[Remedy] Make sure that the multiple machines are not accessing the same folder on the server, then try again. If the error persists, contact our Customer Support Center.</p>
016-700		○				<p>[Cause] The job was suspended because the number of the digits for the Security Print or Charge Print passcode set on the print driver was less than the value specified in [Min. Passcode Length for Stored Job] on the machine.</p> <p>[Remedy] On the print driver, set the passcode string equal to or longer than the value specified in [Min. Passcode Length for Stored Job].</p>
016-702		○				<p>[Cause] Unable to process print data due to insufficient print page buffer.</p> <p>[Remedy] Take one of the following actions:</p> <ul style="list-style-type: none"> • Set [Print Mode] to [Normal]. • Set [Page Print Mode] to [On]. • Increase the print page buffer size. • Add on memory. <p>For information about the Print Mode and the Page Print Mode, refer to the print driver's online help. For information about memory, refer to "Allocate Memory" (P.169).</p>
016-703		○		○		<p>[Cause] Mail specifying a non-registered or invalid mailbox No. was received.</p> <p>[Remedy] Take one of the following actions.</p> <ul style="list-style-type: none"> • Create a new mailbox with the specified number and request the sender to send it again. • Request the sender to send to a valid mailbox.
016-704					○	<p>[Cause] The mailbox is full, and hard disk capacity is insufficient.</p> <p>[Remedy] Remove unnecessary documents from the mailbox, and save the document.</p> <p>Refer to "5 Send from Mailbox" > "Checking/Operating Documents in a Mailbox" in the User Guide.</p>

* If the error persists after following the listed solution, contact our Customer Support Center. The contact number is printed on the label or card attached on the machine.

Error Code	Category					Cause and Remedy
	C	P	S	M	O	
016-705		○	○			<p>[Cause] One of the following may be the cause:</p> <ol style="list-style-type: none"> 1) You have specified the mailbox registry for the scanned document to the machine. However, optional Scanner Kit is not installed. 2) You have not used the print driver for this machine. 3) The machine received a Secure Print, Mailbox Print, Charge Print, or Private Print job with no HDD Extension Kit installed. <p>[Remedy] For 1), press the <All Services> button, and check if [Scan to PC] is displayed. If [Scan to PC] is displayed, then check if the scanned document can be stored in a mailbox. If unable to store in the mailbox, install optional Scanner Kit.</p> <p>For 2), use the print driver appropriate for this machine.</p> <p>For 3), Check if the HDD Extension Kit is installed on the machine.</p> <ul style="list-style-type: none"> - If the HDD Extension Kit is not installed and you do not need to use the feature, select [off] under [Hard Disk] on the [Printer] tab of the print driver. - If the HDD Extension Kit is not installed and you need to use the feature, install the HDD Extension Kit. - If the HDD Extension Kit is installed and you need to use the feature, select [on] under [Hard Disk] on the [Printer] tab of the print driver. <p>If the error persists even after following the listed solutions, contact our Customer Support Center.</p>
016-706		○				<p>[Cause] The hard disk space is insufficient because Secure Print users exceeded the allowed number.</p> <p>[Remedy] Remove unnecessary documents from the machine, and delete unnecessary Secure Print users.</p> <p>For information about Secure Print, refer to "Secure Print" (P.75). For information about mailboxes, refer to "Printing and Deleting Stored Documents" (P.75).</p>
016-707		○				<p>[Cause] Unable to print with the Sample Print feature because a HDD Extension Kit is unattached or defective.</p> <p>[Remedy] A HDD Extension Kit is required for the Sample Print feature. If the HDD Extension Kit is defective, contact our Customer Support Center.</p>
016-708	○					<p>[Cause] Unable to annotate due to insufficient hard disk space.</p> <p>[Remedy] Remove unnecessary data from the hard disk to increase free disk space.</p>
016-710		○				<p>[Cause] Unable to register the Delayed Print document because HDD Extension Kit is unattached.</p> <p>[Remedy] HDD Extension Kit is required to use the Delayed Print feature.</p>
016-711					○	Refer to 016-985.
016-712			○			Refer to 003-751.

* If the error persists after following the listed solution, contact our Customer Support Center. The contact number is printed on the label or card attached on the machine.

Error Code	Category					Cause and Remedy
	C	P	S	M	O	
016-713					O	[Cause] The input passcode does not agree with the passcode set to the mailbox. [Remedy] Input the correct passcode.
016-714					O	[Cause] The specified mailbox does not exist. [Remedy] Create a new mailbox or specify an existing mailbox.
016-716		O				[Cause] Unable to spool TIFF file due to insufficient hard disk space. [Remedy] Remove unnecessary documents and users from the machine, and then attach the hard disk. For information on attaching the hard disk, contact our Customer Support Center. Refer to "Printing and Deleting Stored Documents" (P.75).
016-718		O				[Cause] Unable to process the PCL print data due to insufficient memory. [Remedy] Reduce the resolution, or cancel 2-sided printing or N up, and then print again.
016-719		O				[Cause] Unable to process the PCL print data due to insufficient print page buffer. [Remedy] Increase the size of the print page buffer.
016-720		O				[Cause] An invalid command is included in PCL print data. [Remedy] Check the print data and try to print again.
016-721		O			O	[Cause] An error occurred during print processing. Probable causes are as follows: 1. Printing was instructed by [automatic tray selection] when [Paper Type Priority] is set to [Automatic Tray switching Off] for all paper in the [Common Settings]. 2. ESC/P-K command error [Remedy] For Cause 1: When printing by automatic tray selection, set one of the paper types to a setting other than [Automatic Tray switching Off] in [Paper Type Priority]. For Cause 2: Check the print data. Refer to "Paper Type Priority" (P.128).
016-722		O				[Cause] The specified staple position or the specified paper size is not supported in the finisher. [Remedy] Check the staple position and the paper size, and try to print again.
016-723		O				[Cause] The specified punch position or the specified paper size is not supported in the finisher. [Remedy] Check the punch position and the paper size, and try to print again.
016-724		O				[Cause] The specified staple and punch position combination is unsupported. [Remedy] Specify the staple and punch positions to be on the same side, and try to print again.

* If the error persists after following the listed solution, contact our Customer Support Center. The contact number is printed on the label or card attached on the machine.

Error Code	Category					Cause and Remedy
	C	P	S	M	O	
016-726		O				<p>[Cause] Unable to automatically select a printer language even though the print mode is set to [Auto]. Probable causes are as follows:</p> <ol style="list-style-type: none"> 1. PostScript data was sent with no Adobe PostScript 3 Kit (optional) installed. 2. The PDF file was sent directly to the machine using LPR with Adobe PostScript 3 Kit installed and no HDD Extension Kit installed. <p>[Remedy] For Cause 1: An Adobe PostScript 3 Kit must be installed. For Cause 2: A HDD Extension Kit must be installed.</p>
016-727		O				<p>[Cause] A job was cancelled without storing a document into a mailbox because the document was determined as 0 page. [Remedy] The document could not be stored into the mailbox because the machine determined the print document as 0 page. Disable [Skip Blank Pages] on the Print Options setting, or add text to the document if the document is blank.</p>
016-728						<p>[Cause] An unsupported tag is included in the TIFF file. [Remedy] Check the print data.</p>
016-729		O				<p>[Cause] Unable to print because the number of colors or the resolution of the TIFF file is out of allowed range. [Remedy] Change the number of colors/resolution for the TIFF file, and try again.</p>
016-731						<p>[Cause] Unable to print TIFF data because it was interrupted. [Remedy] Retry printing.</p>
016-732						<p>[Cause] The form specified by the emulation has not been registered at the host side. [Remedy] Resend the form data.</p>
016-733			O			<p>[Cause] 1. Unable to obtain the IP address (the string after "@" in the destination e-mail address) when sending e-mail. 2. Unable to resolve the Internet address (the string after "@") by the DNS server when sending e-mail. [Remedy] For Cause 1: Check the e-mail address. For Cause 2: Check the DNS server address.</p>
016-735			O		O	<p>[Cause] Attempted to print [Job Template List] while updating the job template. [Remedy] Retry printing after waiting for a while.</p>
016-738		O				<p>[Cause] Booklet printing was specified when using PostScript (optional), but the specified paper size is not supported. [Remedy] Change the paper size setting appropriately to booklet printing, and try to print again.</p>
016-739		O				<p>[Cause] Booklet printing was specified when using PostScript (optional), but the specified document size and paper size combination is unsupported. [Remedy] Specify the document size and paper size combination appropriately to booklet printing, and try to print again.</p>

* If the error persists after following the listed solution, contact our Customer Support Center. The contact number is printed on the label or card attached on the machine.

Error Code	Category					Cause and Remedy
	C	P	S	M	O	
016-740		O				[Cause] Booklet printing was specified when using PostScript (optional), but the specified paper tray is unavailable for booklet printing. [Remedy] Change the paper tray setting appropriately to booklet printing, and try to print again.
016-746		O				[Cause] An unsupported feature is included in the received PDF. [Remedy] Print using a print driver.
016-747	O					[Cause] The memory became insufficient when using both the [Repeat Image] and [Annotation] features simultaneously. [Remedy] Take one of the following actions: <ul style="list-style-type: none"> • Use the bigger annotation image size. • Use less [Repeat Image]. • Increase memory.
016-748	O	O			O	[Cause] Unable to print due to insufficient hard disk space. [Remedy] Reduce the number of print pages by dividing up the print data or printing one copy at a time when making multiple copies.
016-749		O				[Cause] For a print job: <ol style="list-style-type: none"> 1. The print language received from the print driver is unsupported by this machine. 2. A PDF file was to be printed on the PDF-unsupported model using ContentsBridge. For printing of a document received by iFax : <ol style="list-style-type: none"> 3. The print language received from the print driver is unsupported by this machine. [Remedy] For Cause 1: Use the machine's print driver for printing. If the problem persists, contact our Customer Support Center. <p>Note • An optional package is necessary for some print languages such as PostScript. For more information, contact our Customer Support Center.</p> For Cause 2: Do not use ContentsBridge to print a PDF file. For Cause 3: Request the sender to send iFax using a print language supported by this machine.
016-750		O				[Cause] The machine received a PDF and a printing job ticket from an application that allows to directly send PDF (such as "ContentsBridge 5.0"), but the printing job ticket data had a grammar or print instruction unsupported by this machine. [Remedy] Check if you are correctly using the application (such as "ContentsBridge 5.0") and if the print instruction was correct. If your application usage and print instruction are correct, check with the application manufacturer for operations of the application. If the problem persists, have a printer settings list, a job history report, and the print data with the printing job ticket ready, and contact our Customer Support Center.

* If the error persists after following the listed solution, contact our Customer Support Center. The contact number is printed on the label or card attached on the machine.

Error Code	Category					Cause and Remedy
	C	P	S	M	O	
016-751		○				<p>[Cause] 1. During the PDF Bridge processing, one of the following occurred: a syntax or parameter error occurred; an undefined command was used; and a PDF file was damaged.</p> <p>2. When [Print Processing Mode] for the PDF Direct Print feature has been set to [PS]: Cause 1 or insufficient memory.</p> <p>[Remedy] For Cause 1: Use the print driver to print the document. For Cause 2: Take one of the following actions:</p> <ul style="list-style-type: none"> • Use the print driver to print the document. • Expand the PostScript memory. <p>For information on the memory, refer to "Allocate Memory" (P.169).</p>
016-752		○				<p>[Cause] Unable to process for PDF Bridge due to insufficient memory space.</p> <p>[Remedy] Change the [Print Mode] setting from [High Image Quality] to [Normal], or from [Normal] to [High Speed]. Or, add memory.</p>
016-753		○				<p>[Cause] The entered password does not agree with that of the PDF file.</p> <p>[Remedy] Set the correct password on ContentsBridge.</p>
016-755		○				<p>[Cause] Attempted to process a print protected PDF file.</p> <p>[Remedy] Cancel the print protection using Adobe Reader, and try to print again.</p>
016-756					○	<p>[Cause] No permissions to use the service.</p> <p>[Remedy] Check with your System Administrator.</p>
016-757					○	<p>[Cause] The password is incorrect.</p> <p>[Remedy] Enter the correct password.</p>
016-758	○	○	○			<p>[Cause] No permissions to use the service.</p> <p>[Remedy] Check with your Auditor Administrator.</p>
016-759	○	○	○			<p>[Cause] The number of pages reached the maximum number of pages for this service.</p> <p>[Remedy] Check with your Auditor Administrator.</p>
016-760		○				<p>[Cause] An error occurred during processing with Adobe PostScript 3 Kit (optional).</p> <p>[Remedy] Take one of the following actions:</p> <ul style="list-style-type: none"> • Set [Print Mode] to [Normal]. • Expand PostScript memory. <p>For information about [Print Mode], refer to the print driver's online help. For information about memory, refer to "Allocate Memory" (P.169).</p>
016-761		○				<p>[Cause] An error occurred during image processing.</p> <p>[Remedy] Set [Print Mode] to [Normal] and try again. If the problem persists, set [Page Print Mode] to [On].</p>
016-762		○				<p>[Cause] The specified print language is not installed on the machine.</p> <p>[Remedy] In [Specify Print Mode] under [Port Settings], specify another print language.</p>
016-763				○		<p>[Cause] Connection error to the POP server</p> <p>[Remedy] Check if the IP address of the POP server is correctly set on the machine.</p>

* If the error persists after following the listed solution, contact our Customer Support Center. The contact number is printed on the label or card attached on the machine.

Error Code	Category					Cause and Remedy
	C	P	S	M	O	
016-764				O		[Cause] Unable to connect to the SMTP server. [Remedy] Contact the SMTP server administrator.
016-765				O		[Cause] Unable to send the e-mail because the hard disk on the SMTP server is full. [Remedy] Contact the SMTP server administrator.
016-766				O		[Cause] An error occurred on the SMTP server. [Remedy] Contact the SMTP server administrator.
016-767				O		[Cause] Unable to send the e-mail due to an incorrect address. [Remedy] Check the address, and try again.
016-768				O		[Cause] Unable to connect to the SMTP server due to the machine's incorrect mail address. [Remedy] Check the machine's mail address.
016-769				O		[Cause] The SMTP server does not support confirmation of mail distribution (DSN). [Remedy] Send e-mail without setting confirmation of mail distribution (DSN).
016-774			O		O	[Cause] Unable to process compression conversion due to insufficient hard disk space. [Remedy] Remove unnecessary data from the hard disk to increase free disk space.
016-775			O		O	[Cause] Unable to process image conversion due to insufficient hard disk space. [Remedy] Remove unnecessary data from the hard disk to increase free disk space.
016-776			O		O	[Cause] An error occurred during image conversion processing. [Remedy] For error upon forwarding with Scan to Mailbox or iFax: The image conversion processing for the data may be finished partially. Get each converted page from the mailbox using CentreWare Internet Services. Refer to "7 Computer Operations" > "Importing Scanned Data" or "9 Computer Operations" > "Importing Scanned Data" in the User Guide. For error after instructing encryption or signature using certificate: Take one of the following actions: <ul style="list-style-type: none"> • Check if the certificate is valid. • Set the correct date and time on the machine.
016-777					O	[Cause] A hard disk error occurred during image processing. [Remedy] The hard disk may be defective. For replacing the hard disk, contact our Customer Support Center.
016-778			O			[Cause] The scanned image conversion processing was interrupted, due to insufficient disk space. [Remedy] Remove unnecessary data from the hard disk to increase free disk space.

* If the error persists after following the listed solution, contact our Customer Support Center. The contact number is printed on the label or card attached on the machine.

Error Code	Category					Cause and Remedy
	C	P	S	M	O	
016-779			O			[Cause] An error occurred during scanned image conversion processing. [Remedy] Retry scanning. If using large-size paper such as A3 with [Scan Resolution] set to 600dpi, specify [Scan Resolution] to 400dpi or less in [Scan Options]. If the error persists, contact our Customer Support Center.
016-780			O			[Cause] A hard disk error occurred during scanned image conversion processing. [Remedy] The hard disk may be defective. For replacing the hard disk, contact our Customer Support Center.
016-781			O			[Cause] Unable to connect to the SMTP server. <ul style="list-style-type: none"> • Unable to establish a connection between the machine and the server. • The ASCII characters are not used for the host name specified on the machine, though the connection between the machine and the server has been established. [Remedy] Take one of the following actions: <ul style="list-style-type: none"> • Make sure the network cables are plugged in securely. • Enter the host name using ASCII characters in [System Settings] > [Network Settings] > [Machine E-mail Address and Host Name].
016-786			O		O	[Cause] When using the scanning feature, the machine could not write the file to the hard disk. [Remedy] Take one of the following actions: <ul style="list-style-type: none"> • Turn the machine off and on. • Load paper on the paper tray if needed. • If the error occurs when sending an e-mail, take one of the following solutions: <ul style="list-style-type: none"> - Lower the resolution. - Reduce the size. - Reduce the number of pages, and divide the job into several e-mails to send.
016-788					O	[Cause] Failed to retrieve a file from the Web browser. [Remedy] Take one of the following actions, and try again. <ul style="list-style-type: none"> • Reload the browser page. • Restart the browser. • Turn the machine off and on.
016-792					O	[Cause] Failed to get the job history report specified in [Job Counter Report]. [Remedy] The specified job history does not exist.
016-793					O	[Cause] Free space is insufficient on the hard disk. [Remedy] Either remove unnecessary data from the hard disk to increase free disk space, or initialize the hard disk.
016-798		O				[Cause] Unable to print the document because a HDD Extension Kit is unattached. [Remedy] Attach a HDD Extension Kit, and print again.
016-799		O				[Cause] An invalid print parameter is included. [Remedy] Check the print data and options, and print again.

* If the error persists after following the listed solution, contact our Customer Support Center. The contact number is printed on the label or card attached on the machine.

Error Code	Category					Cause and Remedy
	C	P	S	M	O	
018-502			○			<p>[Cause] During the transfer using [SMB] of the [Scan to PC] feature, the login to the server was failed because the computers permitted to log in were limited.</p> <p>[Remedy] Check the property information for the specified user, and check if the server sets the login limit for computers.</p>
018-505					○	<p>[Cause] If an error occurred during SMB authentication, the probable causes are as follows:</p> <ul style="list-style-type: none"> • Authentication failed because of the incorrect user name or incorrect password. • The time does not match on the SMB server and the machine. (This may occur when Windows Server 2003 is used.) • When the destination computer is Macintosh, the specified user has not been registered as a user who is permitted to use Windows Sharing. <p>If an error occurred during data transfer via SMB, the probable causes are as follows:</p> <ul style="list-style-type: none"> • Login to the SMB server failed while transferring the scanned image, due to the incorrect user name or incorrect password. • The time does not match on the SMB server and the machine. (This may occur when Windows Server 2003 is used.) • When the destination computer is Macintosh, the specified user has not been registered as a user who is permitted to use Windows Sharing. <p>[Remedy] Take one of the following actions, and try again:</p> <ul style="list-style-type: none"> • Check the user name and password with the network administrator. • When using Windows Server 2003, make sure to match the time set on the SMB server and the machine. • When the destination computer is Macintosh, specify a user who is permitted to use Windows Sharing. <p>Important • The password cannot be retrieved. If you have forgotten the password, reset the password.</p> <p>To reset the password:</p> <ol style="list-style-type: none"> 1) Select [Start] > [Programs] > [Administrative Tools] > [Active Directory Users and Computers] on the Active Directory domain controller where the user information is set. 2) Display the user information by selecting [Domains] > [Users] from the left side frame of the [Active Directory Users and Computers] window. 3) Right-click the appropriate user from the right side frame of the [Active Directory Users and Computers] window, then select [Reset Password].

* If the error persists after following the listed solution, contact our Customer Support Center. The contact number is printed on the label or card attached on the machine.

Error Code	Category					Cause and Remedy
	C	P	S	M	O	
018-543			O			<p>[Cause] During the transfer using [SMB] of the [Scan to PC] feature, logging in to the SMB server failed because one of the following problems occurred on the shared name of the SMB server.</p> <ul style="list-style-type: none"> • The specified shared name does not exist on the server. • Unavailable characters are used in the specified shared name. • When the server is Macintosh, the specified shared name may not have an access right. <p>[Remedy] Confirm the specified shared name, and set the name correctly.</p>
018-547			O			<p>[Cause] During the transfer using [SMB] of the [Scan to PC] feature, the number of login users to the SMB server have exceeded the limit.</p> <p>[Remedy] Take one of the following actions, and try again:</p> <ul style="list-style-type: none"> • Check how many users can access to the shared folder. • Check whether the number of login users have exceeded the limit.
018-596			O			<p>[Cause] An error occurred during LDAP server authentication.</p> <p>[Remedy] Try again. If the problem persists, contact our Customer Support Center.</p>
018-701			O			<p>[Cause] LDAP server protocol error caused by the Address Book operation. The server returned RFC2251 Result Message No "1" (operations error) for Address Book query.</p> <p>[Remedy] Check if [LDAP Server / Directory Service] under [Remote Authentication Server / Directory Service] has been set correctly. Or, the server may have a problem. Check with your network administrator.</p>
018-702			O			<p>[Cause] LDAP server protocol error caused by the Address Book operation. The server returned RFC2251 Result Message No "2" (protocol error) for Address Book query.</p> <p>[Remedy] Have the network administrator check the LDAP server settings, and try again.</p>
018-703			O			<p>[Cause] LDAP server protocol error caused by the Address Book operation. The server returned RFC2251 Result Message No "3" (timelimit exceeded) for Address Book query.</p> <p>[Remedy] Change the search conditions/start position to narrow the range of search area, and try again. If the problem persists, check with your network administrator.</p>
018-704			O			<p>[Cause] LDAP server protocol error caused by the Address Book operation. The server returned RFC2251 Result Message No "4" (sizelimit exceeded) for Address Book query.</p> <p>[Remedy] Change the search conditions/start position to narrow the range of search area, and try again. If the problem persists, check with your network administrator.</p>
018-705			O			<p>[Cause] LDAP server protocol error caused by the Address Book operation. The server returned RFC2251 Result Message No "5" (compare false) for Address Book query.</p> <p>[Remedy] The result may be different from the specified content. Have the network administrator check the LDAP server status.</p>

* If the error persists after following the listed solution, contact our Customer Support Center. The contact number is printed on the label or card attached on the machine.

Error Code	Category					Cause and Remedy
	C	P	S	M	O	
018-706			O			[Cause] LDAP server protocol error caused by the Address Book operation. The server returned RFC2251 Result Message No "6" (compare true) for Address Book query. [Remedy] The desired result has been achieved. No problem occurred.
018-707			O			[Cause] LDAP server protocol error caused by the Address Book operation. The server returned RFC2251 Result Message No "7" (strong authentication not supported) for Address Book query. [Remedy] The LDAP server does not support the specified authentication method. Change the authentication method. Check with your system administrator for another method.
018-708			O			[Cause] LDAP server protocol error caused by the Address Book operation. The server returned RFC2251 Result Message No "8" (strong authentication required) for Address Book query. [Remedy] Check if the authentication settings are correct. Check with your system administrator to consolidate the authentication, and try again.
018-710			O			[Cause] LDAP server protocol error caused by the Address Book operation. The server returned RFC2251 Result Message No "10" (referral) for Address Book query. [Remedy] No registered items were found in the specified retrieval range. Have the network administrator check the authentication settings.
018-711			O			[Cause] LDAP server protocol error caused by the Address Book operation. The server returned RFC2251 Result Message No "11" (admin limit exceeded) for Address Book query. [Remedy] Have the network administrator check the operational status of the server.
018-712			O			[Cause] LDAP server protocol error caused by the Address Book operation. The server returned RFC2251 Result Message No "12" (unavailable extension) for Address Book query. [Remedy] Have the network administrator check the operational status of the server.
018-713			O			[Cause] LDAP server protocol error caused by the Address Book operation. The server returned RFC2251 Result Message No "13" (confidentiality required) for Address Book query. [Remedy] Have the network administrator check the operational status of the server.
018-714			O			[Cause] LDAP server protocol error caused by the Address Book operation. The server returned RFC2251 Result Message No "14" (SASL bind in progress) for Address Book query. [Remedy] Retry after waiting for a while. If the problem persists, check with your network administrator.
018-716			O			[Cause] LDAP server protocol error caused by the Address Book operation. The server returned RFC2251 Result Message No "16" (no such attribute) for Address Book query. [Remedy] The LDAP server has an Attribute problem. Have the network administrator check the LDAP server status.

* If the error persists after following the listed solution, contact our Customer Support Center. The contact number is printed on the label or card attached on the machine.

Error Code	Category					Cause and Remedy
	C	P	S	M	O	
018-717			O			[Cause] LDAP server protocol error caused by the Address Book operation. The server returned RFC2251 Result Message No "17" (undefined type) for Address Book query. [Remedy] The LDAP server has an Attribute problem. Have the network administrator check the LDAP server status.
018-718			O			[Cause] LDAP server protocol error caused by the Address Book operation. The server returned RFC2251 Result Message No "18" (inappropriate matching) for Address Book query. [Remedy] The LDAP server has an Attribute problem. Have the network administrator check the LDAP server status.
018-719			O			[Cause] LDAP server protocol error caused by the Address Book operation. The server returned RFC2251 Result Message No "19" (constraint violation) for Address Book query. [Remedy] The LDAP server has an Attribute problem. Have the network administrator check the LDAP server status.
018-720			O			[Cause] LDAP server protocol error caused by the Address Book operation. The server returned RFC2251 Result Message No "20" (attribute exists) for Address Book query. [Remedy] The LDAP server has an Attribute problem. Have the network administrator check the LDAP server status.
018-721			O			[Cause] LDAP server protocol error caused by the Address Book operation. The server returned RFC2251 Result Message No "21" (invalid syntax) for Address Book query. [Remedy] The LDAP server has an Attribute problem. Have the network administrator check the LDAP server status.
018-732			O			[Cause] LDAP server protocol error caused by the Address Book operation. The server returned RFC2251 Result Message No "32" (no such object) for Address Book query. [Remedy] The target e-mail address does not exist. Check the e-mail address you entered and the e-mail address registered on the LDAP server.
018-733			O			[Cause] LDAP server protocol error caused by the Address Book operation. The server returned RFC2251 Result Message No "33" (incorrect alias) for Address Book query. [Remedy] The LDAP server has a Name problem. Have the network administrator check the LDAP server status.
018-734			O			[Cause] LDAP server protocol error caused by the Address Book operation. The server returned RFC2251 Result Message No "34" (invalid DN syntax) for Address Book query. [Remedy] The LDAP server has a Name problem. Check the user name and password to cancel an incorrect password. If the problem persists, have the network administrator check the authentication settings and status of the LDAP server.
018-735			O			[Cause] LDAP server protocol error caused by the Address Book operation. The server returned RFC2251 Result Message No "35" (object is leaf) for Address Book query. [Remedy] The LDAP server has a Name problem. Have the network administrator check the LDAP server status.

* If the error persists after following the listed solution, contact our Customer Support Center. The contact number is printed on the label or card attached on the machine.

Error Code	Category					Cause and Remedy
	C	P	S	M	O	
018-736			O			[Cause] LDAP server protocol error caused by the Address Book operation. The server returned RFC2251 Result Message No "36" (alias dereferencing problem) for Address Book query. [Remedy] The LDAP server has a Name problem. Have the network administrator check the LDAP server status.
018-748			O			[Cause] LDAP server protocol error caused by the Address Book operation. The server returned RFC2251 Result Message No "48" (inappropriate authentication) for Address Book query. [Remedy] The LDAP server has a security problem. Have the network administrator check the authentication settings on the LDAP server.
018-749			O			[Cause] LDAP server protocol error caused by the Address Book operation. The server returned RFC2251 Result Message No "49" (invalid credentials) for Address Book query. The address search was performed with an incorrect authentication user name and password. [Remedy] The LDAP server has a security problem. Check the authentication user name and password to cancel an incorrect login name. If the problem persists, have the network administrator check the authentication settings on the LDAP server.
018-750			O			[Cause] LDAP server protocol error caused by the Address Book operation. The server returned RFC2251 Result Message No "50" (insufficient access) for Address Book query. [Remedy] The LDAP server has a security problem. Have the network administrator check the access rights for the LDAP server.
018-751			O			[Cause] LDAP server protocol error caused by the Address Book operation. The server returned RFC2251 Result Message No "51" (busy) for Address Book query. [Remedy] The service has a problem. Retry after waiting for a while. If the problem persists, check with your network administrator.
018-752			O			[Cause] LDAP server protocol error caused by the Address Book operation. The server returned RFC2251 Result Message No "52" (unavailable) for Address Book query. [Remedy] The service has a problem. Retry after waiting for a while. If the problem persists, check with your network administrator.
018-753			O			[Cause] LDAP server protocol error caused by the Address Book operation. The server returned RFC2251 Result Message No "53" (unwilling to perform) for Address Book query. [Remedy] The service has a problem. Retry after waiting for a while. If the problem persists, check with your network administrator.
018-754			O			[Cause] LDAP server protocol error caused by the Address Book operation. The server returned RFC2251 Result Message No "54" (loop detected) for Address Book query. [Remedy] The service has a problem. Have the network administrator check the operational status of the service on the LDAP server.

* If the error persists after following the listed solution, contact our Customer Support Center. The contact number is printed on the label or card attached on the machine.

Error Code	Category					Cause and Remedy
	C	P	S	M	O	
018-764			O			[Cause] LDAP server protocol error caused by the Address Book operation. The server returned RFC2251 Result Message No "64" (naming violation) for Address Book query. [Remedy] The LDAP server has an Update problem. Have the network administrator check the LDAP server status.
018-765			O			[Cause] LDAP server protocol error caused by the Address Book operation. The server returned RFC2251 Result Message No "65" (object class violation) for Address Book query. [Remedy] The LDAP server has an Update problem. Have the network administrator check the LDAP server status.
018-766			O			[Cause] LDAP server protocol error caused by the Address Book operation. The server returned RFC2251 Result Message No "66" (not allowed on nonleaf) for Address Book query. [Remedy] The LDAP server has an Update problem. Have the network administrator check the LDAP server status.
018-767			O			[Cause] LDAP server protocol error caused by the Address Book operation. The server returned RFC2251 Result Message No "67" (not allowed on RDN) for Address Book query. [Remedy] The LDAP server has an Update problem. Have the network administrator check the LDAP server status.
018-768			O			[Cause] LDAP server protocol error caused by the Address Book operation. The server returned RFC2251 Result Message No "68" (already exists) for Address Book query. [Remedy] The LDAP server has an Update problem. Have the network administrator check the LDAP server status.
018-769			O			[Cause] LDAP server protocol error caused by the Address Book operation. The server returned RFC2251 Result Message No "69" (no object class modifications) for Address Book query. [Remedy] The LDAP server has an Update problem. Have the network administrator check the LDAP server status.
018-770			O			[Cause] LDAP server protocol error caused by the Address Book operation. The server returned RFC2251 Result Message No "70" (results too large) for Address Book query. [Remedy] Change the search conditions/start position to narrow the range of search area, and try again. If the problem persists, check with your network administrator.
018-771			O			[Cause] LDAP server protocol error caused by the Address Book operation. The server returned RFC2251 Result Message No "71" (affecting multiple DSAs) for Address Book query. [Remedy] Have the network administrator check the LDAP server status.
018-780			O			[Cause] LDAP server protocol error caused by the Address Book operation. The server returned RFC2251 Result Message No "80" (unknown error) for Address Book query. [Remedy] Have the network administrator check the LDAP server status.

* If the error persists after following the listed solution, contact our Customer Support Center. The contact number is printed on the label or card attached on the machine.

Error Code	Category					Cause and Remedy
	C	P	S	M	O	
018-781			O			[Cause] LDAP server protocol error caused by the Address Book operation. Connection to the server cannot be established for Address Book query. [Remedy] Take one of the following actions: • Check the network cable connection. • If the network cable connection has no problem, check the active status of the target server. • Check if the server name has been correctly set for [LDAP Server / Directory Service] under [Remote Authentication Server / Directory Service].
018-782			O			[Cause] LDAP server protocol error caused by the Address Book operation. The server returned RFC2251 Result Message No "82" (program error or SASL authentication error) for Address Book query. [Remedy] Have the network administrator check the LDAP server status.
018-783			O			[Cause] LDAP server protocol error caused by the Address Book operation. The server returned RFC2251 Result Message No "83" (encoding error) for Address Book query. [Remedy] Have the network administrator check the LDAP server status.
018-784			O			[Cause] LDAP server protocol error caused by the Address Book operation. The server returned RFC2251 Result Message No "84" (decoding error) for Address Book query. [Remedy] Have the network administrator check the LDAP server status.
018-785			O			[Cause] LDAP server protocol error caused by the Address Book operation. The server returned RFC2251 Result Message No "85" (timeout) for Address Book query. [Remedy] Change the search conditions/start position to narrow the range of search area, and try again. If the problem persists, check with your network administrator.
018-786			O			[Cause] LDAP server protocol error caused by the Address Book operation. The server returned RFC2251 Result Message No "86" (unknown authentication method) for Address Book query. [Remedy] Have the network administrator check the LDAP server status.
018-787			O			[Cause] LDAP server protocol error caused by the Address Book operation. The server returned RFC2251 Result Message No "87" (search filter error) for Address Book query. [Remedy] Check the search conditions set on Address Book. If the problem persists, check with your network administrator.
018-788			O			[Cause] LDAP server protocol error caused by the Address Book operation. The server returned RFC2251 Result Message No "88" (user cancelled operation) for Address Book query. [Remedy] Have the network administrator check the LDAP server status.
018-789			O			[Cause] LDAP server protocol error caused by the Address Book operation. The server returned RFC2251 Result Message No "89" (incorrect parameter) for Address Book query. [Remedy] Have the network administrator check the LDAP server status.

* If the error persists after following the listed solution, contact our Customer Support Center. The contact number is printed on the label or card attached on the machine.

Error Code	Category					Cause and Remedy
	C	P	S	M	O	
018-790			O			[Cause] LDAP server protocol error caused by the Address Book operation. The server returned RFC2251 Result Message No "90" (no memory) for Address Book query. [Remedy] Have the network administrator check the LDAP server status.
018-791			O			[Cause] LDAP server protocol error caused by the Address Book operation. The server returned RFC2251 Result Message No "91" (server connection error) for Address Book query. [Remedy] Have the network administrator check the LDAP server status.
018-792			O			[Cause] LDAP server protocol error caused by the Address Book operation. The server returned RFC2251 Result Message No "92" (unsupported feature) for Address Book query. [Remedy] Have the network administrator check the LDAP server status.
018-793			O			[Cause] LDAP server protocol error caused by the Address Book operation. The server returned RFC2251 Result Message No "93" (no results returned) for Address Book query. [Remedy] Have the network administrator check the LDAP server status.
018-794			O			[Cause] LDAP server protocol error caused by the Address Book operation. The server returned RFC2251 Result Message No "94" (no more results) for Address Book query. [Remedy] Have the network administrator check the LDAP server status.
018-795			O			[Cause] LDAP server protocol error caused by the Address Book operation. The server returned RFC2251 Result Message No "95" (results remaining) for Address Book query. [Remedy] Have the network administrator check the LDAP server status.
018-796			O			[Cause] LDAP server protocol error caused by the Address Book operation. The server returned RFC2251 Result Message No "96" (client loop detected) for Address Book query. [Remedy] Have the network administrator check the LDAP server status.
018-797			O			[Cause] LDAP server protocol error caused by the Address Book operation. The server returned RFC2251 Result Message No "97" (referral limit exceeded) for Address Book query. [Remedy] Have the network administrator check the LDAP server status.
024-700		O				[Cause] Secure Watermark Kit can not be used due to the malfunction of the hard disk or the memory. [Remedy] Turn the machine off and on. If the error persists, contact our Customer Support Center.
024-742		O				[Cause] Booklet printing was specified for [Print Options], but the number of print pages for the job exceeded the maximum number for booklet creation. [Remedy] Change the [Print Options] setting to split the pages appropriately to create separate volumes, or to cancel the booklet setting.
024-746		O				[Cause] The specified paper type is not compatible with the specified paper size, paper tray, output tray, or 2-sided printing. [Remedy] Check the print data.

* If the error persists after following the listed solution, contact our Customer Support Center. The contact number is printed on the label or card attached on the machine.

Error Code	Category					Cause and Remedy
	C	P	S	M	O	
024-747		O				[Cause] Incompatible print parameters are used. The combination of the specified features such as Document Size, Paper Size, Paper Tray, 2 sided print, and Output Tray is incompatible. [Remedy] Check the print data, and try to print again.
024-748		O				[Cause] The number of digits specified in [Number of Digits] of the [Page Number] screen does not match the value specified in [Start Number] of the [Page Number - Print On] screen. [Remedy] Set [Number of Digits] to [Auto Assign] or a value appropriate for the value specified in [Start Number].
024-775		O				Refer to 024-742.
026-700			O			[Cause] By Address Book operation, the machine received an unsupported protocol from the LDAP server. [Remedy] Try again. If the problem persists, contact our Customer Support Center.
026-701			O			[Cause] The number of queries to Address Book exceeded the machine's processing capability. [Remedy] Wait for a while and try again. If the number of queries to Address Book is only one, the machine's software may be defective. Contact our Customer Support Center.
026-702			O			[Cause] The number of access from the LDAP server to the machine exceeded the machine's processing capability. [Remedy] Wait for a while and try again. If the problem persists, contact our Customer Support Center.
027-500				O	O	[Cause] Unable to resolve the SMTP server name when returning e-mail. [Remedy] Check on the CentreWare Internet Services if the SMTP server settings are correct.
027-501				O	O	[Cause] Unable to resolve the POP3 server name when using the POP3 protocol. [Remedy] Check on CentreWare Internet Services if the POP3 server settings are correct.
027-502				O	O	[Cause] Failed to login to the POP3 server when using the POP3 protocol. [Remedy] Check on CentreWare Internet Services if the user name and password used in the POP3 server are correct.
027-503				O	O	[Cause] An error occurred in the POP server. [Remedy] Try again. If the error persists, contact our Customer Support Center.
027-504				O	O	[Cause] An error occurred in the SMTP server. [Remedy] Try again. If the error persists, contact our Customer Support Center.

* If the error persists after following the listed solution, contact our Customer Support Center. The contact number is printed on the label or card attached on the machine.

Error Code	Category					Cause and Remedy
	C	P	S	M	O	
027-513			O			<p>[Cause] The machine failed to transfer data using [SMB] of the [Scan to PC] feature because access to the SMB server was not permitted. When the server is Macintosh, a folder with the same name as the specified file name may exist on the server.</p> <p>[Remedy] Change the settings so that a file or a folder can be read and written at the save location. When the server is Macintosh, change the folder name on the server, or the file name to be transferred.</p>
027-514			O			<p>[Cause] The machine failed to transfer data using [SMB] of the [Scan to PC] feature because the machine could not resolve the host name or the server name of the SMB server when accessing the DNS.</p> <p>[Remedy] Check the connection to the DNS. Check if the forwarding destination SMB server name has been registered on the DNS.</p>
027-515			O			<p>[Cause] During the transfer using [SMB] of the [Scan to PC] feature, accessing the DNS failed because the DNS server was not set correctly.</p> <p>[Remedy] Set the DNS server address. Or, specify the destination SMB server address using its IP address.</p>

* If the error persists after following the listed solution, contact our Customer Support Center. The contact number is printed on the label or card attached on the machine.

Error Code	Category					Cause and Remedy
	C	P	S	M	O	
027-516			O			<p>[Cause] During the transfer using [SMB] of the [Scan to PC] feature, the SMB server could not be found.</p> <p>[Remedy] Take one of the following actions, and try again:</p> <ul style="list-style-type: none"> • Check the following to see if the destination SMB server and the machine are set up properly for network communications: <ul style="list-style-type: none"> - Check the network cables are plugged in securely. - Check the TCP/IP settings. - Check communications of port 137 (UDP), port 138 (UDP), port 139 (TCP). • Check the following to see if the computer correctly works as an SMB server. <ul style="list-style-type: none"> - Check if the file sharing service for Microsoft Network is activated. - Check if [NetBIOS over TCP/IP] for TCP/IP is activated. - Check if the file sharing service (using communication through port 137 (UDP), port 138 (UDP), and port 139 (TCP)) are authorized for the Firewall settings. • For communications which exceed the subnet, check the WINS server settings, and check if the server address can be resolved correctly. • For Windows NT 4.0 Server/Workstation, use the following steps to see if the NetBIOS interface device is activated on the destination SMB server: <ol style="list-style-type: none"> 1. Select [Start] > [Settings] > [Control Panel]. 2. Display [Services], then select [Messenger] service. 3. Select [Startup] > [Auto] > [OK], then select [Close]. 4. Select [Devices] in the [Control Panel], then select [NetBIOS Interface]. 5. Select [Startup] > [Auto] or [Manual] > [OK], then select [Close]. 6. Reboot the computer.
027-518			O			<p>[Cause] The machine failed to transfer data using [SMB] of the [Scan to PC] feature because the specified password was incorrect. When the server is Macintosh, the specified user may not have been registered as a user who are permitted to use Windows Sharing.</p> <p>[Remedy] Check the password for the shared folder. When the server is Macintosh, specify a user who is permitted to use Windows Sharing.</p>

* If the error persists after following the listed solution, contact our Customer Support Center. The contact number is printed on the label or card attached on the machine.

Error Code	Category					Cause and Remedy
	C	P	S	M	O	
027-519			O			<p>[Cause] During the transfer using [SMB] of the [Scan to PC] feature, an error occurred because the save location or file name specified for the scanned image had a problem.</p> <ul style="list-style-type: none"> • The specified save location does not exist on the server. • Unavailable characters are used in the save location or the file name. • Because the specified save location has the Distributed File System (DFS) settings, it is linked to other shared folders. <p>[Remedy] Take one of the following actions:</p> <ul style="list-style-type: none"> • Check if the save location is correct. • Check if the specified file name is available on the SMB server. • Use the following steps to check with the system administrator for the Distributed File System (DFS) settings: <ol style="list-style-type: none"> 1. Select [Start] > [Programs] > [Administrative Tools] > [Distributed File System]. 2. Select the specified save location from the left side frame of the [Distributed File System] window, and then check the target information displayed on the right side frame of the window. 3. Specify the SMB server, shared name, and save location based on the information you checked in step 2.
027-520			O			<p>[Cause] During the transfer using [SMB] of the [Scan to PC] feature, the file name or folder name could not be retrieved.</p> <p>[Remedy] Check the access privilege to the SMB server.</p>
027-521			O			<p>[Cause] During the transfer using [SMB] of the [Scan to PC] feature, the suffix of the file name or folder name exceeded the limit on the SMB server.</p> <p>[Remedy] Change the file name or destination folder on the SMB server. Or, move or delete the files from the destination folder.</p>
027-522			O			<p>[Cause] During the transfer using [SMB] of the [Scan to PC] feature, the scanned image file could not be created on the SMB server due to one of the following reasons:</p> <ul style="list-style-type: none"> • The specified file name has already been used on the server. • The specified file name has already been used. • The specified file name exists as a directory. • Unavailable characters are used in the file name. <p>[Remedy] Take one of the following actions:</p> <ul style="list-style-type: none"> • Check if the specified file name can be used in the save location. • Check whether or not the specified file name has been used by another user. • Check whether or not the specified file name has been used for another file or folder.

* If the error persists after following the listed solution, contact our Customer Support Center. The contact number is printed on the label or card attached on the machine.

Error Code	Category					Cause and Remedy
	C	P	S	M	O	
027-523			O			<p>[Cause] During the transfer using [SMB] of the [Scan to PC] feature, a lock folder could not be created on the SMB server due to the following reason:</p> <ul style="list-style-type: none"> • The specified lock folder already exists. <p>[Remedy] Take one of the following actions:</p> <ul style="list-style-type: none"> • If any lock directory (.LCK) exists in the forwarding destination, manually delete it, and then try again. • Check if the same name is being used for another folder.
027-524			O			<p>[Cause] During the transfer using [SMB] of the [Scan to PC] feature, a folder could not be created on the SMB server because the same folder already exists.</p> <p>[Remedy] Check if the specified name is being used for another file or folder on the SMB server.</p>
027-525			O			<p>[Cause] During the transfer using [SMB] of the [Scan to PC] feature, a file could not be deleted from the SMB server due to one of the following reasons:</p> <ul style="list-style-type: none"> • The file does not exist. • The file is opened. • The specified file name is being used as a directory. <p>[Remedy] Check whether or not the file is not being used by another user at the specified save location.</p>
027-526			O			<p>[Cause] During the transfer using [SMB] of the [Scan to PC] feature, a lock folder could not be deleted from the SMB server due to one of the following reasons:</p> <ul style="list-style-type: none"> • The file does not exist. • The directory is not empty. • The specified directory name does not exist. <p>[Remedy] If any lock directory (.LCK) exists in the forwarding destination, manually delete it, and then try again.</p>
027-527			O			<p>[Cause] During the transfer using [SMB] of the [Scan to PC] feature, a folder could not be deleted from the SMB server due to one of the following reasons:</p> <ul style="list-style-type: none"> • The file does not exist. • The directory is not empty. • The specified directory name does not exist. <p>[Remedy] Check whether or not the file is not being used by another user at the specified save location.</p>
027-528			O			<p>[Cause] During the transfer using [SMB] of the [Scan to PC] feature, no space is available at the save location on the SMB server.</p> <p>[Remedy] Check if the save location has free space.</p>
027-529			O			<p>[Cause] During the transfer using [SMB] of the [Scan to PC] feature, an unexpected error has occurred on the SMB server, or an unexpected internal error has occurred on the machine.</p> <p>[Remedy] Log in to the server from another computer using the same user name, to see if a file can be written into the same save location on the server. If the error persists, it may be an internal error. Contact our Customer Support Center.</p>

* If the error persists after following the listed solution, contact our Customer Support Center. The contact number is printed on the label or card attached on the machine.

Error Code	Category					Cause and Remedy
	C	P	S	M	O	
027-530			O			[Cause] During the transfer using [SMB] of the [Scan to PC] feature, a file could not be saved because [Cancel Job] had been selected for [File Name Conflict]. [Remedy] Select any option other than [Cancel Job] for [File Name Conflict].
027-531			O			[Cause] During the transfer using [SMB] of the [Scan to PC] feature, an error occurred because the filing policy was invalid. [Remedy] When selecting [Change Name and Save] in [File Name Conflict], make sure that the file format is not Multi-Page.
027-532			O			[Cause] During the transfer using [SMB] of the [Scan to PC] feature, an error occurred when accessing to the NEXTNAME.DAT file. [Remedy] If [Change Name and Save] has been selected for [File Name Conflict], check if the NEXTNAME.DAT file is correct.
027-533			O			[Cause] During the transfer using [SMB] of the [Scan to PC] feature, an internal error occurred. [Remedy] Try executing the same operation. If the error persists, contact our Customer Support Center.
027-543			O			[Cause] The SMB server (NetBIOS) name is invalid. [Remedy] Check if the server name of the SMB server is correct.
027-547					O	[Cause] SMB protocol error. An invalid character was detected in the specified domain name. [Remedy] If the error occurred during SMB authentication: Check with the network administrator for the domain name, then re-configure correctly. Also, check if the domain name set on the machine is correct, using the following procedure: 1. Enter the System Administration mode, and select [System Settings] > [System Settings] > [Network Settings] > [Remote Authentication Server / Directory Service] > [SMB Server Settings]. 2. Select the SMB server to check the domain name. If the error occurred during the transfer via SMB of [Scan to PC]: Check the domain name which has been specified when entering login name with the network administrator. To check the domain name on the server, take the following actions: 1. Select [Start] > [Programs] > [Administrative Tools] > [Active Directory Domains and Trusts]. 2. From the left side frame of the [Active Directory Domains and Trusts] window, select [Active Directory Domains and Trusts]. Right-click [Domains] to select [Properties]. 3. Select [General] tab in the domain properties window, check the domain name (prior to Windows 2000).

* If the error persists after following the listed solution, contact our Customer Support Center. The contact number is printed on the label or card attached on the machine.

Error Code	Category					Cause and Remedy
	C	P	S	M	O	
027-548					O	<p>[Cause] SMB protocol error. An invalid character was detected in the specified user name.</p> <p>[Remedy] The user name on the server needs to be set without using unauthorized characters by the network administrator. To check the user name on the server, take the following actions:</p> <ol style="list-style-type: none"> 1. Select [Start] > [Programs] > [Administrative Tools] > [Active Directory Users and Computers] on the Active Directory domain controller where the user information is set. 2. Select [Active Directory Users and Computers] > [Server] > [Domains] > [Users] from the left side frame of the [Active Directory Users and Computers] window, to display the user information. 3. Select the [Account] tab in the [User Properties] window, check the user name of [User Log On Name (Prior to Windows 2000)].
027-549					O	<p>[Cause] SMB protocol error</p> <p>[Remedy] Try again. If the problem persists, contact our Customer Support Center.</p>
027-564					O	<p>[Cause] SMB protocol error. The SMB server was not found.</p> <p>[Remedy] Check if the connection between the authentication server and the machine has been established via a network. For example, check the following points:</p> <ul style="list-style-type: none"> • Network cable connection • TCP/IP settings • Connection via Port 137 (UDP)/Port 138 (UDP)/Port 139 (TCP)
027-565					O	<p>[Cause] SMB protocol error</p> <p>[Remedy] Try again. If the problem persists, contact our Customer Support Center.</p>
027-566					O	<p>[Cause] SMB protocol error. SMB (TCP/IP) is not active.</p> <p>[Remedy] Check on CentreWare Internet Services that SMB (TCP/IP) is active on the [Port Status] screen of the [Properties] tab.</p>
027-569			O			<p>[Cause] The SMB (TCP/IP) port is not activated.</p> <p>[Remedy] Select [Properties] on CentreWare Internet Service, and check if the SMB(TCP/IP) is activated on the [Port Activation] screen.</p>
027-572 027-573 027-574 027-576 027-578					O	<p>[Cause] SMB protocol error</p> <p>[Remedy] Try again. If the problem persists, contact our Customer Support Center.</p>
027-584					O	<p>[Cause] SMB protocol error. The SMB server is in shared security mode.</p> <p>[Remedy] The SMB server may be on Windows 95, Windows 98, or Windows Me OS. Set the SMB server on an OS other than Windows 95, Windows 98, or Windows Me OS.</p>
027-585			O		O	<p>[Cause] SMB protocol error. Login disabled period.</p> <p>[Remedy] Check with the system administrator for the login-permitted period.</p>

* If the error persists after following the listed solution, contact our Customer Support Center. The contact number is printed on the label or card attached on the machine.

Error Code	Category					Cause and Remedy
	C	P	S	M	O	
027-586			O		O	[Cause] SMB protocol error. The password has expired. [Remedy] Obtain a valid password from the system administrator.
027-587			O		O	[Cause] SMB protocol error. The password must be changed. [Remedy] Log in to Windows, and change the password. Ask the system administrator for changing the setting so that you do not need to change the login password next time.
027-588			O		O	[Cause] SMB protocol error. The user is invalid. [Remedy] Ask the system administrator for validating the user.
027-589			O		O	[Cause] SMB protocol error. The user was locked out. [Remedy] Ask the system administrator for canceling the lockout status.
027-590			O		O	[Cause] SMB protocol error. The user account has expired. [Remedy] Obtain a valid user account from the system administrator. Or, ask the system administrator to extend the account expiration date.
027-591			O		O	[Cause] SMB protocol error. Users are restricted. A blank password is invalid. [Remedy] Set the password for the user.
027-599			O		O	[Cause] SMB protocol error [Remedy] Try again. If the problem persists, contact our Customer Support Center.
027-702			O	O		[Cause] The specified recipient's certificate does not exist. [Remedy] Register the certificate to the machine.
027-703			O	O		[Cause] The specified recipient's certificate has expired. [Remedy] Register a valid certificate to the machine.
027-704			O	O		[Cause] The CA certificate for the specified Address Book does not exist. [Remedy] Check the path to the recipient's certificate, and register the required CA certificate to the machine.
027-705				O		[Cause] The specified recipient's certificate has been revoked. [Remedy] Specify a valid certificate.
027-706				O		[Cause] Unable to find the S/MIME certificate associated with the machine's e-mail address when sending e-mail. [Remedy] Import the S/MIME certificate corresponding to the mail address to the machine.
027-707				O		[Cause] The S/MIME certificate associated with the machine's e-mail address has expired. [Remedy] Import a new S/MIME certificate to the machine.
027-708				O		[Cause] The S/MIME certificate associated with the machine's e-mail address is not reliable. [Remedy] Import a reliable S/MIME certificate to the machine.
027-709				O		[Cause] The S/MIME certificate associated with the machine's e-mail address has been discarded. [Remedy] Import a new S/MIME certificate to the machine.
027-710				O		[Cause] No S/MIME certificate is attached to the received e-mail. [Remedy] Ask the sender to send the e-mail with an S/MIME certificate.

* If the error persists after following the listed solution, contact our Customer Support Center. The contact number is printed on the label or card attached on the machine.

Error Code	Category					Cause and Remedy
	C	P	S	M	O	
027-711				O		[Cause] No S/MIME certificate was obtained from the received e-mail. [Remedy] Import the sender's S/MIME certificate to the machine, or attach an S/MIME certificate to S/MIME signature mail sent from the sender.
027-712				O		[Cause] The received S/MIME certificate has expired, or is an unreliable certificate. [Remedy] Ask the sender to send the e-mail with a valid S/MIME certificate.
027-713				O		[Cause] The received e-mail has been discarded because it might be altered on its transmission route. [Remedy] Tell the sender about it, and ask to send the e-mail again.
027-714				O		[Cause] The received e-mail has been discarded because the address in its From field was not the same as the mail address in the S/MIME signature mail. [Remedy] Tell the sender that the mail addresses are not identical, and ask to send the e-mail again.
027-715				O		[Cause] The received S/MIME certificate has not been registered on the machine, or has not been set to use on the machine. [Remedy] Import the sender's S/MIME certificate to the machine, or change settings to use the S/MIME certificate on the machine when the S/MIME certificate has already been registered.
027-716				O		[Cause] The received S/MIME certificate has been discarded because the certificate was unreliable. [Remedy] Ask the sender to send the e-mail with a reliable S/MIME certificate.
027-720				O		[Cause] Unable to find the server of an application interface destination. [Remedy] Check the DNS server address. Or, check whether or not the computer that the application (ApeosWare Flow Service) is installed on has been registered on the DNS server.
027-721				O		[Cause] An application interface destination does not exist. [Remedy] Check whether the application linked (ApeosWare Flow Service) operates correctly.
027-722				O		[Cause] The jobs was timed out during connection with an application interface destination. [Remedy] Try to process the job flow again.
027-723				O		[Cause] Authentication at the application interface destination (ApeosWare Flow Service) failed. [Remedy] Check the user name and password that is used when creating a job flow.
027-724			O			[Cause] An application interface destination (ApeosWare Flow Service) could not be accessed. [Remedy] Check whether ApeosWare Flow Service operates correctly. When it is operating correctly, check the log.

* If the error persists after following the listed solution, contact our Customer Support Center. The contact number is printed on the label or card attached on the machine.

Error Code	Category					Cause and Remedy
	C	P	S	M	O	
027-725					O	[Cause] A job operation failed using an application interface. [Remedy] Check whether the application linked (ApeosWare Flow Service) operates correctly. When it is operating correctly, check the log. When it is not operating, check the network environments.
027-726			O			[Cause] The status of the application interface destination (ApeosWare Flow Service) is unknown. [Remedy] Check whether ApeosWare Flow Service operates correctly. When it is operating correctly, check the log.
027-727					O	[Cause] A parameter is illegal during an application interface. [Remedy] Try to process the job flow again.
027-728					O	[Cause] The number of files that are to be sent to external services exceeded the maximum number. [Remedy] Reduce the number of files, and send them again.
027-730					O	[Cause] The number of the document pages attached to the SMTP mail is more than the maximum number of pages allowed for the Split Send feature. [Remedy] Reduce the number of the document pages, and try again.
027-737			O		O	[Cause] An error occurred while reading data from the job template pool server. [Remedy] Check to see whether you have privileges for the directory which stores the job template.
027-739			O		O	[Cause] Unable to find the specified job template server. [Remedy] Check the path name of the job template server.
027-740			O		O	[Cause] Unable to login to the job template pool server. [Remedy] Check the login user name and password.
027-741			O		O	[Cause] Unable to connect to the job template pool server. [Remedy] Ask the network administrator to check the network and server environments.
027-742			O		O	[Cause] Unable to store job template due to insufficient hard disk space. [Remedy] Remove unnecessary data from the hard disk to increase free disk space.
027-743			O		O	[Cause] The specified job template pool server is incorrect. [Remedy] Check the settings of the job template server.
027-744			O		O	[Cause] The domain name of the job template server has a problem. [Remedy] Make sure that the DNS server connection and the domain name have been registered to the DNS server.
027-745			O		O	[Cause] The address of the DNS server has not been registered on the machine. [Remedy] Either register the address of the DNS server on the machine, or set the address of the job template server with its IP address.
027-746			O		O	[Cause] The protocol settings on the job template pool server are incorrect. [Remedy] Set up the correct port.

* If the error persists after following the listed solution, contact our Customer Support Center. The contact number is printed on the label or card attached on the machine.

Error Code	Category					Cause and Remedy
	C	P	S	M	O	
027-750						O [Cause] Attempted to give a fax/print/iFax command to the scan document. [Remedy] Fax/print/iFax features are unavailable for scan documents. Set the job flow correctly.
027-751						O [Cause] An error occurred during job flow processing. [Remedy] Check the settings of the job flow.
027-752						O [Cause] A mandatory entry field is blank in the job flow. [Remedy] Take one of the following actions: <ul style="list-style-type: none"> • Link mailboxes only to job flows that do not have mandatory entry fields. • Set the default values to the mandatory fields of the job flow.
027-753						O [Cause] 1) Attempted to execute the service while the port necessary for the job flow is either deactivated or disabled. 2) Attempted to execute a job flow to send e-mail using the encryption or digital signature feature while S/MIME communication is disabled. [Remedy] For Cause 1) Have your System Administrator check the port status. For Cause 2) Enable S/MIME communication, or modify the job flow so that e-mail is sent by not using the encryption or digital signature feature.
027-754				O		[Cause] The setting contents for [DocuWorks Signature] or [PDF Signature] on the job flow are not appropriate. [Remedy] Check the DocuWorks and PDF signatures for both the system data settings (machine's current settings) and the executed job flow settings. If these settings are not the same, change either of them.
027-761						O [Cause] An on-demand print job was sent to the machine using the remote access feature, but the time interval of receiving the print job and starting the print processing exceeded the time limit specified on the machine. [Remedy] When multiple documents are to be printed, reduce the number of documents, and then try again. If the error persists, go to the system administration mode, and then select [System Settings] > [System Settings] > [Common Settings] > [Machine Clock/Timers] > [On-Demand Print Duration], and specify a larger value or "0". Note <ul style="list-style-type: none"> • When on-demand printing is performed using the remote access feature, the print processing time has a limit. If many documents are to be printed or if print processing takes time, therefore, a timeout may occur before all the data are received. To clear this problem, change the time limit value according to the document volume and type. If the error persists, contact our Customer Support Center.

* If the error persists after following the listed solution, contact our Customer Support Center. The contact number is printed on the label or card attached on the machine.

Error Code	Category					Cause and Remedy
	C	P	S	M	O	
027-762					O	<p>[Cause] An on-demand print job is sent to the machine using the remote access feature, however, the specified job ticket is invalid:</p> <ul style="list-style-type: none"> Abnormal change to the job ticket due to the machine software failure. Abnormal change to the job ticket due to a bug on the sender's remote server Abnormal change to the job ticket due to network trouble. Intentional alteration to the job ticket. <p>[Remedy] Try executing the print job again. If the error persists, contact our Customer Support Center.</p>
027-770		O			O	<p>[Cause] The print job has a problem.</p> <p>[Remedy] Submit a print job again.</p>
027-771		O			O	<p>[Cause] The hard disk of the server connected to the machine is full.</p> <p>[Remedy] Delete unnecessary data from the server.</p>
027-772					O	<p>[Cause] An error occurred during communication with the SMTP server.</p> <p>[Remedy] Use ASCII characters to modify the host name that has been specified under [System Settings] > [Network Settings] > [Machine's E-mail Address/Host Name]. If the error persists, check with your network administrator whether the SMTP server supports the HELO command.</p>
027-773					O	<p>[Cause] An error occurred during communication with the SMTP server.</p> <p>[Remedy] Wait for a while, and try again.</p>
027-774					O	<p>[Cause] The specified e-mail address contains unsupported characters.</p> <p>[Remedy] Specify the e-mail address using ASCII characters.</p>
027-775					O	<p>[Cause] Too many destination addresses have been specified.</p> <p>[Remedy] Reduce the number of destination addresses. If the error persists, check with your network administrator whether the SMTP server supports the EHLO command.</p>
027-776					O	<p>[Cause] An error occurred during communication with the SMTP server.</p> <p>[Remedy] Use ASCII characters to modify the host name that has been specified under [System Settings] > [Network Settings] > [Machine's E-mail Address/Host Name]. If the error persists, check with your network administrator whether the SMTP server supports the EHLO command.</p>
027-777					O	<p>[Cause] The destination SMTP server does not support SMTP-AUTH.</p> <p>[Remedy] Set [E-mail Send Authentication] to [Off] under [System Settings] > [Network Settings] > [Outgoing/Incoming E-mail Settings] > [SMTP Server Settings].</p>

* If the error persists after following the listed solution, contact our Customer Support Center. The contact number is printed on the label or card attached on the machine.

Error Code	Category					Cause and Remedy
	C	P	S	M	O	
027-778					O	[Cause] The destination SMTP server does not support the SMTP-AUTH system. [Remedy] Check with your network administrator about the authentication type supported by the SMTP server. The machine supports the following authentication types: PLAIN (plain text) authentication, LOGIN (BASE64) authentication, and CRAM-MD5 (challenge-response).
027-779					O	[Cause] Failed to authenticate the SMTP server. [Remedy] Check the login name and password set to SMTP-AUTH.
027-796		O		O	O	[Cause] The received e-mail was discarded because it had no attached documents. (The machine is set to print attached documents only.) [Remedy] To also print the mail body or header information, change settings in the Properties screen of CentreWare Internet Services. Refer to "E-mail Control" (P.179).
027-797				O	O	[Cause] The output destination of the received e-mail is invalid. [Remedy] Specify a correct output destination, and send the e-mail again.
047-210					O	[Cause] Output tray malfunction [Remedy] Contact our Customer Support Center.
062-210					O	[Cause] Document feeder malfunction [Remedy] Contact our Customer Support Center.
062-211					O	[Cause] An error occurred in the document feeder. [Remedy] Contact our Customer Support Center.
062-220					O	Refer to 062-210.
062-277					O	[Cause] A communication error occurred between the document scan unit and the document feeder. [Remedy] Contact our Customer Support Center.
062-278					O	[Cause] An error occurred in the document feeder. [Remedy] Contact our Customer Support Center.
062-790					O	[Cause] The scanned document is copy-protected. [Remedy] Check documents you can copy.
063-210 063-220 063-230 063-240					O	Refer to 062-211.
065-210 065-211 065-212 065-213					O	[Cause] An error occurred with the machine. [Remedy] Contact our Customer Support Center.
065-215 065-216					O	[Cause] An error occurred with the document feeder. [Remedy] Power-cycle the machine. If the problem persists, contact our Customer Support Center.

* If the error persists after following the listed solution, contact our Customer Support Center. The contact number is printed on the label or card attached on the machine.

Error Code	Category					Cause and Remedy
	C	P	S	M	O	
065-219 065-220					O	[Cause] The document feeder is defective. [Remedy] Contact our Customer Support Center.
071-210					O	[Cause] Tray 1 malfunction [Remedy] Contact our Customer Support Center. Trays other than the Tray 1 can be used.
072-210					O	[Cause] Tray 2 malfunction [Remedy] Contact our Customer Support Center. Trays other than the Tray 2 can be used.
073-210					O	[Cause] Tray 3 malfunction [Remedy] Contact our Customer Support Center. Trays other than the Tray 3 can be used.
074-210					O	[Cause] Tray 4 malfunction [Remedy] Contact our Customer Support Center. Trays other than the Tray 4 can be used.
075-210 075-211					O	[Cause] Tray 5 (bypass) malfunction [Remedy] Power-cycle the machine. If the machine is not improved by performing the relevant remedy, contact our Customer Support Center.
078-250					O	[Cause] Tray 6 (HCF) malfunction [Remedy] Power-cycle the machine. If the problem persists, contact our Customer Support Center.
078-260 078-261 078-262 078-263 078-264 078-265 078-266 078-267 078-268 078-269 078-270 078-271 078-272 078-273 078-274 078-275 078-276 078-277 078-278 078-279 078-280 078-281					O	[Cause] Tray 6 (A3 + High Capacity Tray) malfunction [Remedy] Check paper loaded in the Tray 6 (A3 + High Capacity Tray), and power-cycle the machine. If the machine is not improved by performing the relevant remedy, contact our Customer Support Center.

* If the error persists after following the listed solution, contact our Customer Support Center. The contact number is printed on the label or card attached on the machine.

Error Code	Category					Cause and Remedy
	C	P	S	M	O	
078-282 078-283					O	[Cause] Tray 5 (bypass) malfunction [Remedy] Power-cycle the machine. If the machine is not improved by performing the relevant remedy, contact our Customer Support Center.
112-700					O	[Cause] The finisher's punch scrap container is full. [Remedy] Empty the punch scrap container. For more information, refer to "Emptying the Punch Scrap Container for C-Finisher or C-Finisher with Booklet Maker" (P.59) or "Emptying the Punch Scrap Container for Booklet Finisher D2" (P.60).
116-701	O	O				[Cause] Unable to use the 2-sided printing feature due to insufficient memory. [Remedy] Add memory.
116-702		O				[Cause] A print job was processed using a substitute font. [Remedy] Check the print data.
116-703		O				[Cause] An error occurred during PostScript (optional) processing. [Remedy] Either check the print data, or click [Spool Settings] on the [Details] tab in the print driver to set bi-directional communication to off.
116-710		O				[Cause] A probable cause is that the correct document size could not be judged as the receive data exceeded the HP-GL/2 spool size. [Remedy] Increase the size assigned to HP-GL/2 auto-layout memory.
116-713					O	[Cause] The job was divided to be printed due to insufficient disk space. [Remedy] Remove unnecessary data from the hard disk to increase free disk space.
116-714		O				[Cause] An HP-GL/2 (optional) command error occurred. [Remedy] Check the print data.
116-720		O				[Cause] An error occurred during print processing due to insufficient memory. [Remedy] Stop unnecessary ports or remove unnecessary data from the hard disk, to increase free disk space.
116-725					O	[Cause] Unable to write the image log because the image log save space is insufficient on the machine. [Remedy] Execute the job again. If this error persists, take one of the following actions: <ul style="list-style-type: none"> • Delete unnecessary image logs. • Change the [Assurance Level] setting for image logs to [Low]. Note that selecting [Low] will not secure the contents of created image logs.
116-740		O				[Cause] Numerical value operation error occurred as a value exceeding the value limit of the printer was used in the print data. [Remedy] Check the print data.
116-747		O				[Cause] The paper margin value is too large for the HP-GL/2 effective coordinate area. [Remedy] Decrease the paper margin value, and try again.

* If the error persists after following the listed solution, contact our Customer Support Center. The contact number is printed on the label or card attached on the machine.

Error Code	Category					Cause and Remedy
	C	P	S	M	O	
116-748		O				[Cause] There is no plot data in the HP-GL/2 print data. [Remedy] Check the print data.
116-749		O				[Cause] The job was cancelled because the specified font does not exist. [Remedy] Install the font, or set the font replacement on the print driver.
116-752		O				[Cause] The descriptions of the PDF printing job ticket have a problem. [Remedy] Try again. If the problem persists, contact our Customer Support Center.
116-780				O	O	[Cause] There is a problem with the document attached to the received e-mail. [Remedy] Check the attached document.
116-790		O				[Cause] 1. If the operator cancelled printing a document that was received using the Fax to Mailbox or iFax to Mailbox feature: The first set of the document is not stapled. 2. For a cause other than Cause 1: All the sets of the document are not stapled. [Remedy] For Cause 1. Manually staple the first set of the document. Or, do not cancel printing a document that is received using the Fax to Mailbox or iFax to Mailbox feature. For Cause 2. Check if the staple position has been correctly specified, and try printing again.
124-701					O	[Cause] The output destination was changed to the center tray due to the malfunction of the specified output tray. [Remedy] Contact our Customer Support Center. Any trays other than the defective output tray can be used.
124-702					O	[Cause] The output destination was changed to the center tray due to the malfunction of the specified Finisher tray. [Remedy] Contact our Customer Support Center. Any trays other than the defective output tray can be used.
124-703					O	[Cause] The output destination was changed to the center tray due to the malfunction of the specified booklet tray. [Remedy] Contact our Customer Support Center. Any trays other than the defective output tray can be used.
124-704					O	[Cause] The output destination was changed to the center tray due to the malfunction of the specified output tray. [Remedy] Contact our Customer Support Center. Any trays other than the defective output tray can be used.
124-705	O					[Cause] The punch setting was cancelled. [Remedy] Check the punch position, and try again.
124-706	O					[Cause] The folding setting was cancelled. [Remedy] Check the folding setting, and try to print again.

* If the error persists after following the listed solution, contact our Customer Support Center. The contact number is printed on the label or card attached on the machine.

Error Code	Category					Cause and Remedy
	C	P	S	M	O	
124-708					O	<p>[Cause] The output destination was changed to the center tray. One of the following may be the cause:</p> <p>1) Paper of different size from the specified size is loaded for 2-sided copying.</p> <p>2) The punching feature of C-Finisher is out of order.</p> <p>[Remedy] For 1), check if the specified size paper is loaded in the tray. For 2), confirm that an error code 012-231, 012-232, 012-233, or 012-234 is displayed on the touch screen, and contact our Customer Support Center.</p> <p>[Remedy] Contact our Customer Support Center. Any trays other than the defective output tray can be used.</p>
124-709	O					<p>[Cause] The document exceeded the maximum number of pages that can be stapled.</p> <p>[Remedy] Reduce the number of pages, or cancel the stapling setting, then try to print again.</p>
133-700	O					<p>[Cause] The staple or punch setting was cancelled.</p> <p>[Remedy] Check the staple position, and try again.</p>

* If the error persists after following the listed solution, contact our Customer Support Center. The contact number is printed on the label or card attached on the machine.

Other Errors

Remedies are described for situations in which the following messages are displayed.

Error Message	Category					Cause and Remedy
	C	P	S	M	O	
A fault has occurred. Switch off the machine. (xxx-yyy)	O	O	O	O	O	[Cause] An error occurred. [Remedy] Turn off the power, wait until the touch screen goes dark, and then turn on power again. If the message persists, record the displayed contents for [(xxx-yyy)]. Switch off the machine immediately, wait for the touch screen to go dark, and contact our Customer Support Center.
Completed with an error. (xxx-yyy)	O	O	O	O	O	[Cause] An error occurred. [Remedy] Retry the same procedure after waiting for a period.
A fault has occurred. The machine has rebooted. Select [Close]. If the problem persists, call for service. (xxx-yyy)	O	O	O	O	O	[Cause] An auto-recoverable internal error occurred, and the machine restarted automatically. [Remedy] Select the [Close] button. The machine is operating normally now. If the error persists, call our Call Center.

Paper Jams

If paper is jammed inside the machine, the machine stops and an alarm sounds. A message is also displayed on the touch screen. Follow the instructions displayed to remove the jammed paper.

Gently remove the paper taking care not to tear it. If paper is torn while it is being removed from the machine, remove all the torn pieces making sure that none remain inside the machine.

If a paper jam message is displayed again after you have cleared the paper jam, paper is probably jammed at another location. Clear this by following the message.

When you have finished clearing the paper jam, printing is automatically resumed from the state before the paper jam occurred.

If a paper jam occurred during copying, press the <Start> button. Copying is resumed from the state before the paper jam occurred.

CAUTION

Do not attempt to remove a paper jammed deeply inside the product, particularly a paper wrapped around a fuser or a heat roller. Otherwise, it may cause injuries or burns. Switch off the product promptly and contact your local Fuji Xerox representative.

This section describes how to clear paper jams at the following locations. Refer to each section.

Paper Jams in the Trays 1 to 2	367
Paper Jams in the Tray 3	367
Paper Jams in the Tray 4	368
Paper Jams in the Tray 5 (Bypass).....	368
Paper Jams in the Tray 6 (HCF (A4 1 Tray))	369
Paper Jams in the Transfer Module.....	371
Paper Jams in the Bottom Left Cover	372
Paper jams in the Bottom Right Cover	373
Paper Jams in the Output Tray	374
Paper Jams in the C-Finisher and the C-Finisher with Booklet Maker	374
Paper jams in the Booklet Finisher D2	384

- Important**
- When a paper jam occurs, paper is sometimes torn and remains inside the machine if you pull out a paper tray without checking the paper jam position. This may cause machine malfunctions. Check where the paper jam occurred first.
 - If a piece of jammed paper remains inside the machine, the paper jam message will not disappear from the touch screen.
 - Clear the paper jams while the machine is on. When the power is turned off, all information stored to the machine's memory will be erased.
 - Do not touch components inside the machine. This may cause print defects.

Paper Jams in the Trays 1 to 2

The following describes how to clear paper jams in the Trays 1 to 2.

- 1 Pull out the tray where the paper jam occurred.

Important • Paper is sometimes torn and remains inside the machine if you pull out a tray without checking the paper jam position. This may cause machine malfunction. Check where the paper jam occurred first.

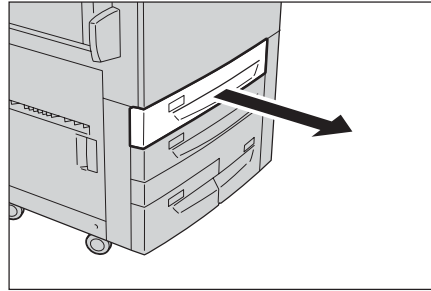

- 2 Remove the jammed paper.

Note • If paper is torn, check for any torn pieces of paper inside the machine.

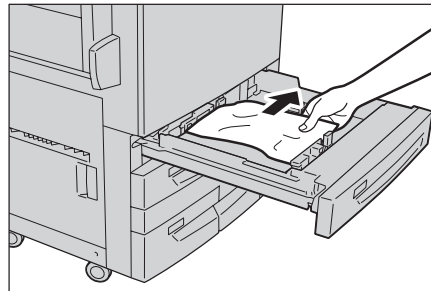

- 3 Push the tray in gently until it comes to a stop.

Paper Jams in the Tray 3

The following describes how to clear paper jams in the Tray 3.

- 1 Pull out the Tray 3.

Important • Paper is sometimes torn and remains inside the machine if you pull out a tray without checking the paper jam position. This may cause machine malfunction. Check where the paper jam occurred first.

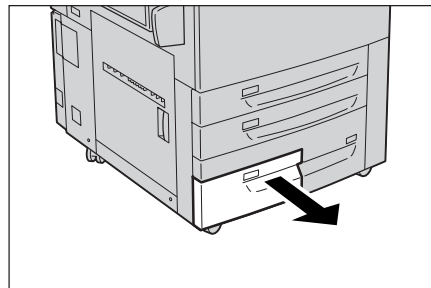

- 2 Remove the jammed paper.

Note • If paper is torn, check for any torn pieces of paper inside the machine.

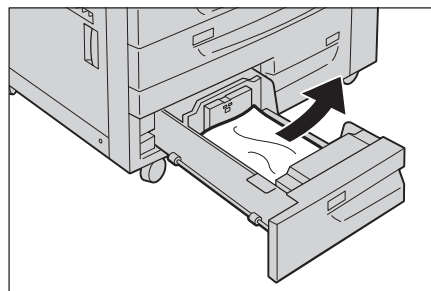

- 3 Push the tray in gently until it comes to a stop.

Paper Jams in the Tray 4

The following describes how to clear paper jams in the Tray 4.

- 1 Pull out the Tray 4.

Important • Paper is sometimes torn and remains inside the machine if you pull out a tray without checking the paper jam position. This may cause machine malfunction. Check where the paper jam occurred first.

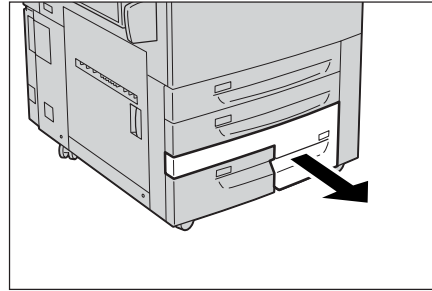

- 2 Remove the jammed paper.

Note • If paper is torn, check for any torn pieces of paper inside the machine.

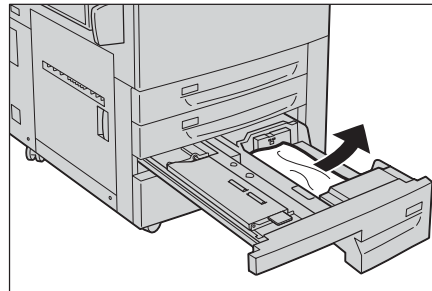

- 3 If paper is jammed in the paper feed section, open the inner cover and remove the paper.

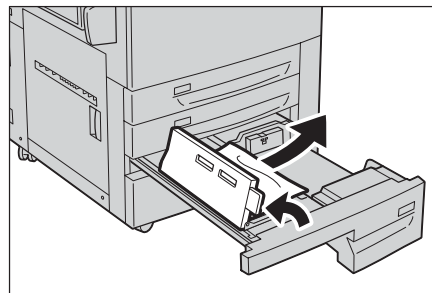

- 4 Push the tray in gently until it comes to a stop.

Paper Jams in the Tray 5 (Bypass)

The following describes how to clear paper jams in the Tray 5 (bypass).

- 1 Open the Tray 5 (bypass) top cover to remove the jammed paper.

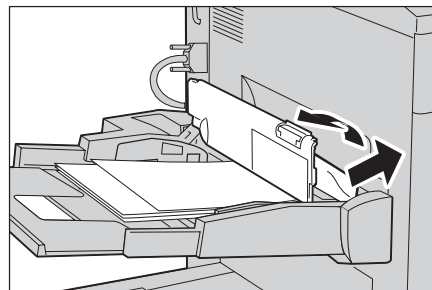

- Remove all paper loaded in the Tray 5 (bypass).

Important • When two or more sheets of paper are loaded, remove all of the sheets from the tray.

Note • If paper is torn, check for any torn pieces of paper inside the machine.

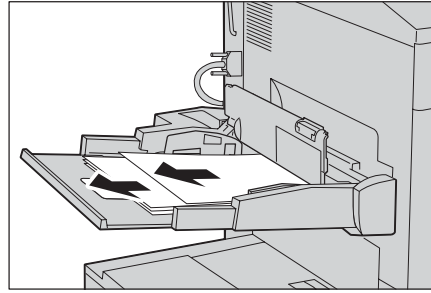

- Close the top cover.
- Fan the paper you removed making sure that all four corners are neatly aligned.

- Insert the paper into the tray with the printing side facing up until its leading edge lightly comes up against the paper feed entrance.

• Do not load paper exceeding the maximum fill line. It might cause paper jams or machine malfunctions.

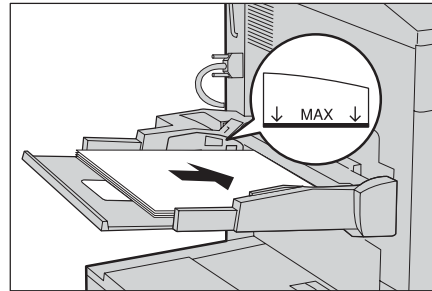

Paper Jams in the Tray 6 (HCF (A4 1 Tray))

The following describes how to clear paper jams in the Tray 6 (HCF (A4 1 Tray)).

This section describes how to clear paper jams at the following locations:

Paper Jams in the Tray 6 Exit.....	369
Paper Jams in the Tray 6 Top Cover.....	370
Paper Jams in the Tray 6.....	370

Paper Jams in the Tray 6 Exit

- Gently move the Tray 6 to the left until it stops by gripping the handle on the top left side of the Tray 6.

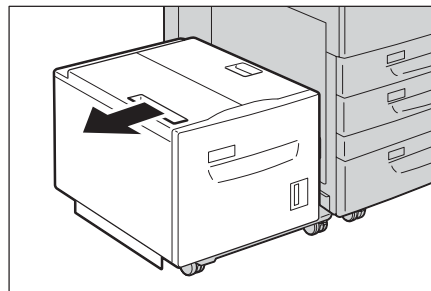

- Remove the jammed paper.

Note • If paper is torn, check for any torn pieces of paper inside the machine.

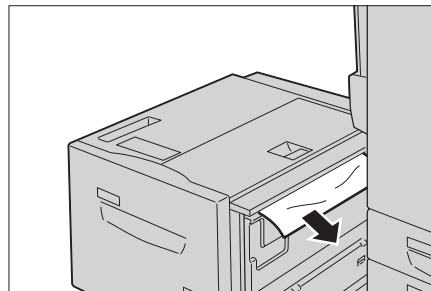

- Gently put the Tray 6 back into position.

Paper Jams in the Tray 6 Top Cover

- 1 Gently move the Tray 6 to the left until it stops by gripping the handle on the top left side of the Tray 6.

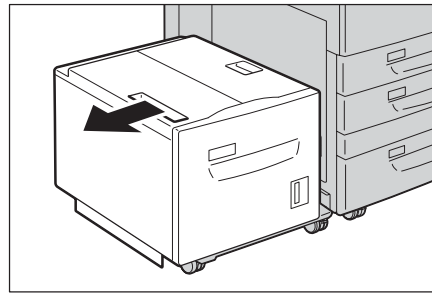

- 2 Open the Tray 6 top cover.

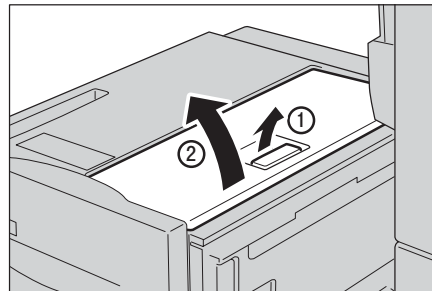

- 3 Remove the jammed paper.

Note • If paper is torn, check for any torn pieces of paper inside the machine.

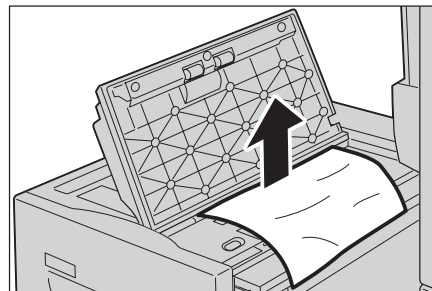

- 4 Close the top cover.

- 5 Gently put the Tray 6 back into position.

Paper Jams in the Tray 6

- 1 Pull out the Tray 6.

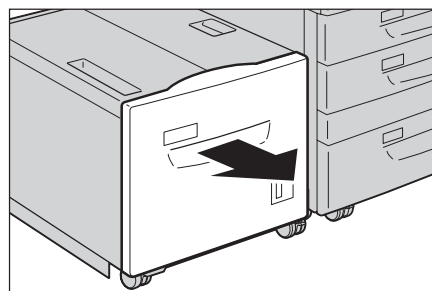

- 2 Remove the jammed paper.

Note • If paper is torn, check for any torn pieces of paper inside the machine.

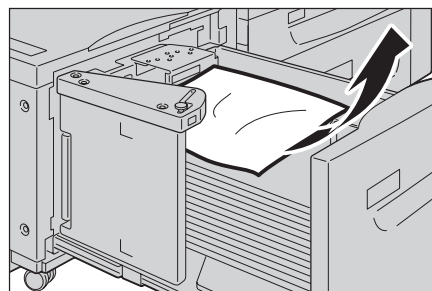

- 3 Push the tray in gently until it comes to a stop.

Paper Jams in the Transfer Module

The following describes how to clear paper jams in the transfer module.

- 1 Make sure that the machine has stopped before opening the front cover.

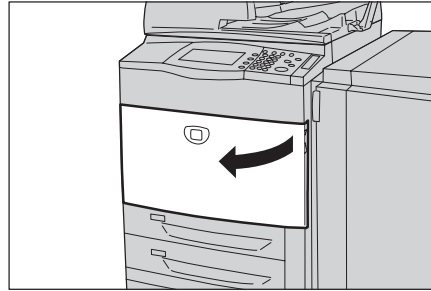

- 2 Turn the green lever 2 at the center of the transfer module to the right until it is in the horizontal position and then pull the transfer module out to the end.

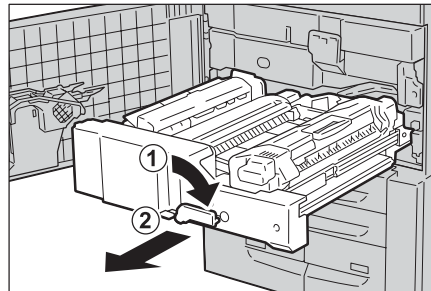

- 3 Remove the visible jammed paper.

Note • If paper is torn, check for any torn pieces of paper in the unit.

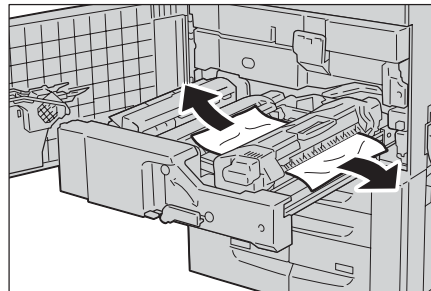

- 4 Move the lever 2a to the right and remove the jammed paper.

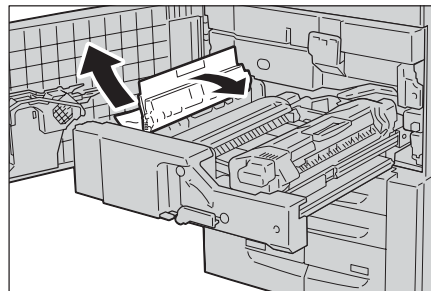

- 5 Pull down the lever 2b and remove the jammed paper.

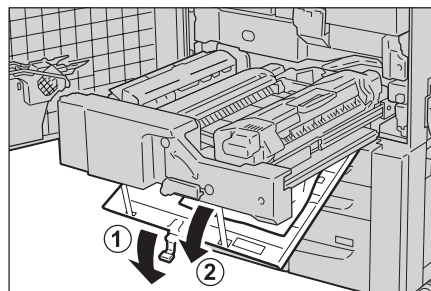

- 6 Return the lever 2a and 2b to the original position.

- 7** Insert the transfer module completely and turn the green lever 2 to the left.

Note • If you cannot turn the lever, pull the transfer module to the middle and insert it again.

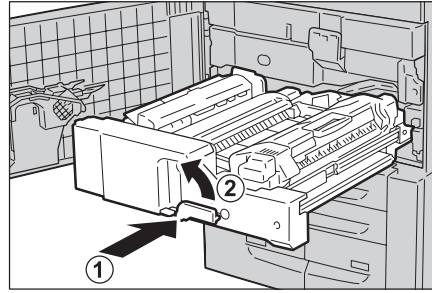

- 8** Close the front cover.

Note • A message will be displayed and the machine will not operate if the front cover is even slightly open.

Paper Jams in the Bottom Left Cover

Following describes how to clear paper jams in the bottom left cover.

- 1** If the Tray 6 (HCF (A4 1 Tray)) is installed, gently move the Tray 6 to the left until it stops by gripping the handle on the top left side of the Tray 6.

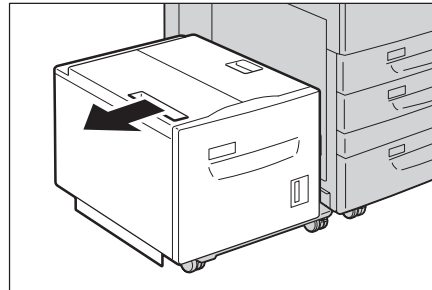

- 2** Open the bottom left cover while gripping the release lever.

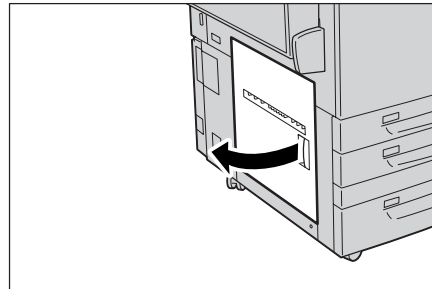

- 3** Remove the upper jammed paper.

Note • If paper is torn, check for any torn pieces of paper inside the machine.

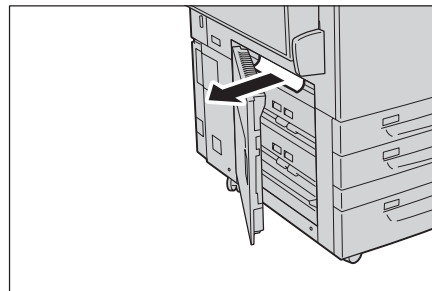

- 4** Remove the lower jammed paper.

Note • If paper is torn, check for any torn pieces of paper inside the machine.

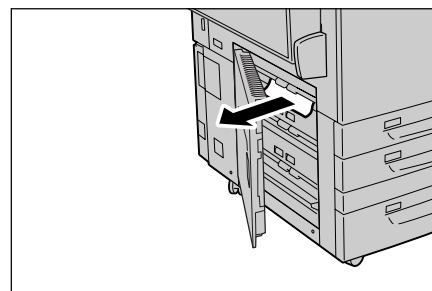

- 5** Close the bottom left cover.

- Note** • A message will be displayed and the machine will not operate if the bottom left cover is even slightly open.

- 6** If the Tray 6 (HCF (A4 1 Tray)) is installed, push the tray in gently until it comes to a stop.

Paper jams in the Bottom Right Cover

Following describes how to clear paper jams in the bottom right cover.

- 1** If the finisher is installed, open the front cover of the finisher and then pull down the lever 1a.

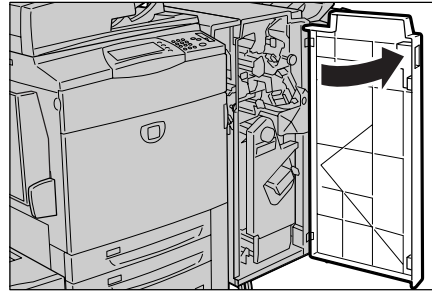

- 2** Open the bottom right cover while pressing the downward arrow button.

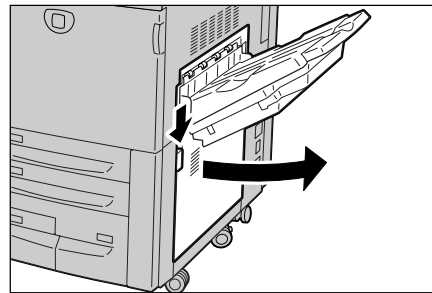

- 3** Remove the upper jammed paper.

- Note** • If paper is torn, check for any torn pieces of paper inside the machine.

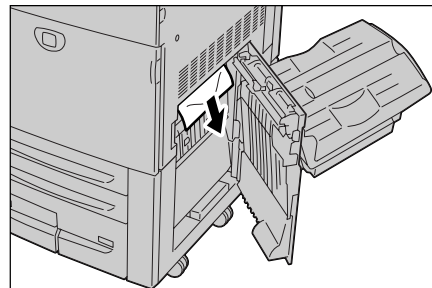

- 4** Remove the lower jammed paper.

- Note** • If paper is torn, check for any torn pieces of paper inside the machine.

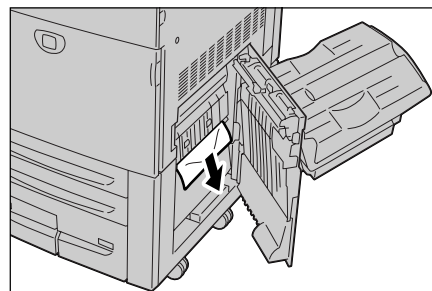

- 5** Check the lower parts of the machine. If there is jammed paper, remove it.

- Note** • If paper is torn, check for any torn pieces of paper inside the machine.

- 6** Close the bottom right cover.

- Note** • A message will be displayed and the machine will not operate if the bottom right cover is even slightly open.

Paper Jams in the Output Tray

Following describes how to clear paper jams in the output tray.

- 1** Remove jammed paper from the output tray.

Note • If paper is torn, check for any torn pieces of paper inside the machine.

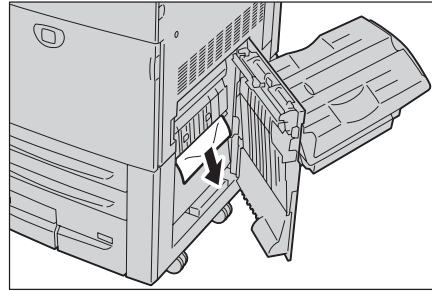

Paper Jams in the C-Finisher and the C-Finisher with Booklet Maker

The following describes how to clear paper jams in the finisher when the C-Finisher or the C-Finisher with Booklet Maker (optional) is installed.

This section describes how to clear paper jams at the following locations

Paper Jams at the Lever 1a.....	374
Paper Jams at the Lever 1d and the Wheel 1c.....	375
Paper Jams at the Levers 1a and 1b	376
Paper Jams at the Lever 2a.....	377
Paper Jams at the Lever 2a (Using the knob 2c).....	378
Paper Jams at the Lever 2b	379
Paper Jams at the Lever 2b (Using the Knob 2c).....	379
Paper Jams at the Lever 3	380
Paper Jams at the Lever 5	381
Paper Jams at the 4a (for the C-Finisher with Booklet Maker)	381
Paper Jams at the Lever 4b (for the C-Finisher with Booklet Maker).....	382
Paper Jams at the Booklet Tray (for the C-Finisher with Booklet Maker).....	383

The following example shows how to clear paper jams in the C-Finisher with Booklet Maker. The procedure is the same as for the C-Finisher.

Paper Jams at the Lever 1a

- 1** Make sure that the machine has stopped before opening the front cover of the finisher.

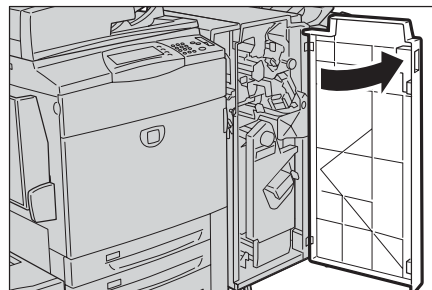

- 2** Move the lever 1a to the right.

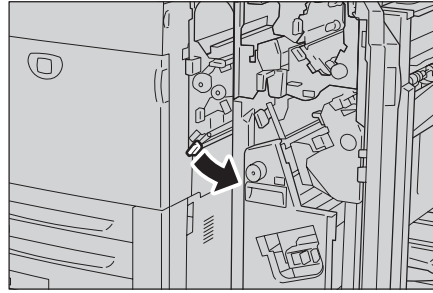

- 3** Remove the jammed paper.

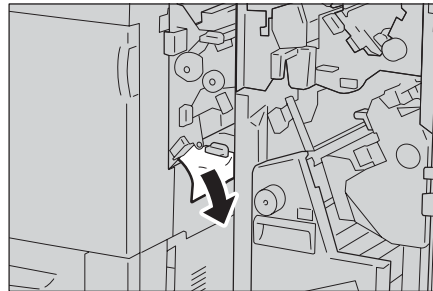

- 4** Return the lever 1a to the original position.

- 5** Close the front cover of the finisher.

Note • A message will be displayed and the machine will not operate if the front cover of the finisher is even slightly open.

Paper Jams at the Lever 1d and the Wheel 1c

- 1** Open the front cover of the finisher.

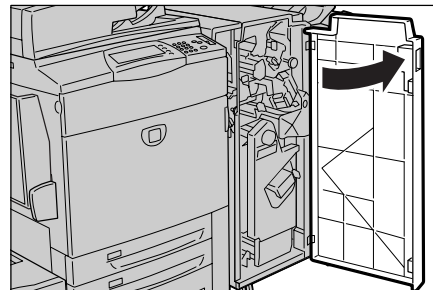

- 2** Move the lever 1d to the left, and then move the lever 6 upward.

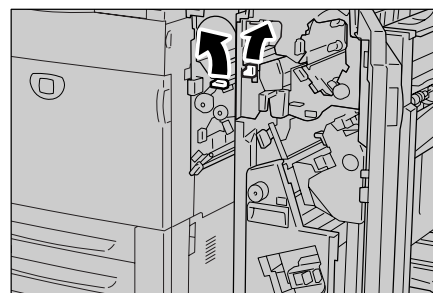

- 3** Turn the wheel 1c to the direction indicated by the arrow, and then remove the jammed paper.

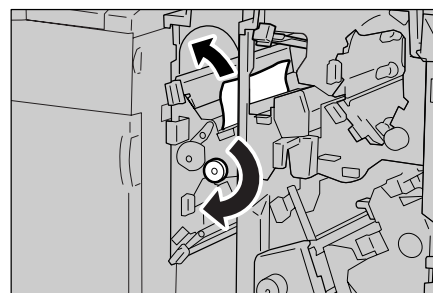

4 Return the lever 1d and 6 to the original position.

5 Close the front cover of the finisher.

Note • A message will be displayed and the machine will not operate if the front cover of the finisher is even slightly open.

Paper Jams at the Levers 1a and 1b

1 Open the front cover of the finisher.

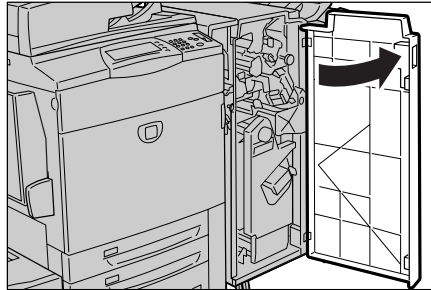

2 Move the lever 1a to the right.

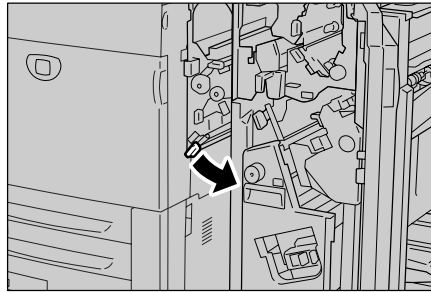

3 Remove the jammed paper.

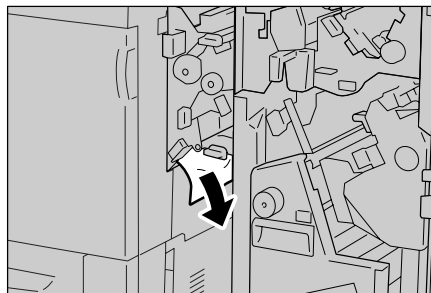

4 If the paper cannot be removed, return the lever 1a to the original position and move the lever 1b to the right.

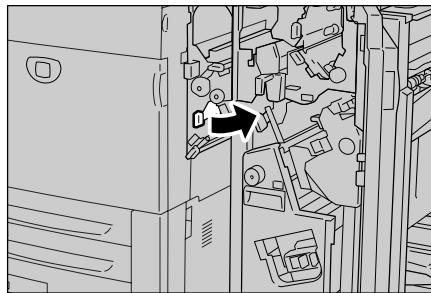

- 5** Gently pull out the paper to remove.

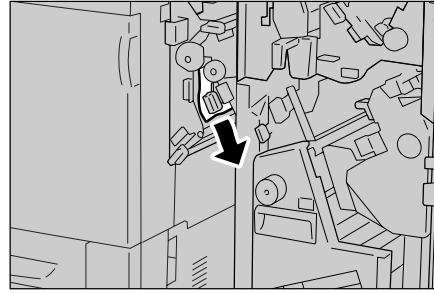

- 6** Return the levers 1b and 1a to the original positions.
- 7** Close the front cover of the finisher.

Note • A message will be displayed and the machine will not operate if the front cover of the finisher is even slightly open.

Paper Jams at the Lever 2a

- 1** If the edge of the jammed paper comes out from the exit of the output tray, gently pull out the paper to remove.

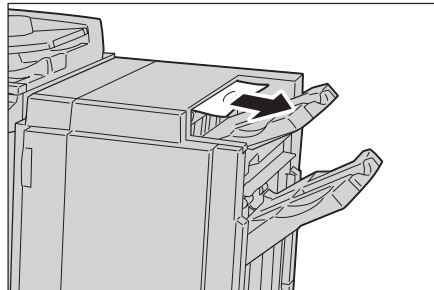

- 2** Open the front cover of the finisher.

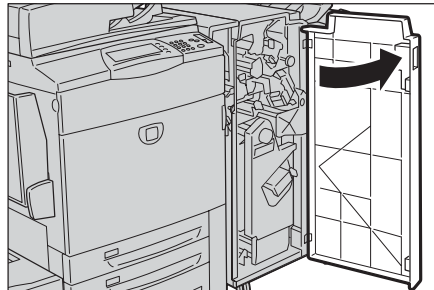

- 3** Move the lever 2a to the right.

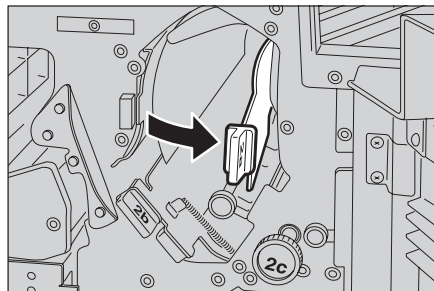

4 Remove the jammed paper.

Note • If paper is torn, check for any torn pieces of paper inside the machine.

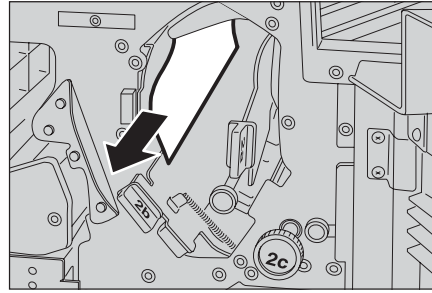

5 Return the lever 2a to the original position.

6 Close the front cover of the finisher.

Note • A message will be displayed and the machine will not operate if the front cover of the finisher is even slightly open.

Paper Jams at the Lever 2a (Using the knob 2c)

1 If the edge of the jammed paper comes out from the exit of the output tray, gently pull out the paper to remove.

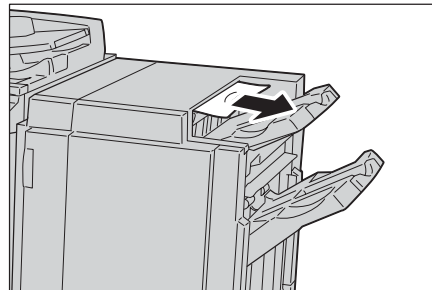

2 Open the front cover of the finisher.

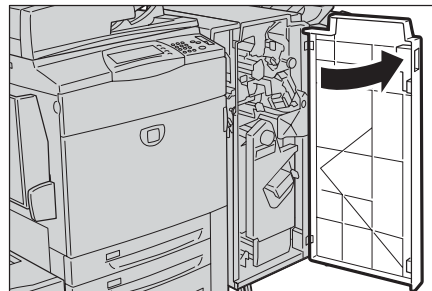

3 Move the lever 2a to the right.

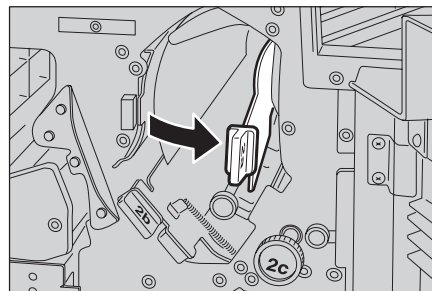

4 Turn the knob 2c to the direction indicated by the arrow, and then remove the jammed paper.

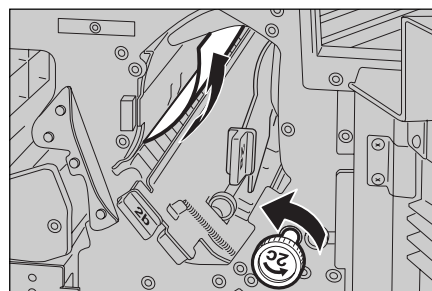

- 5** Gently pull out the paper to remove.

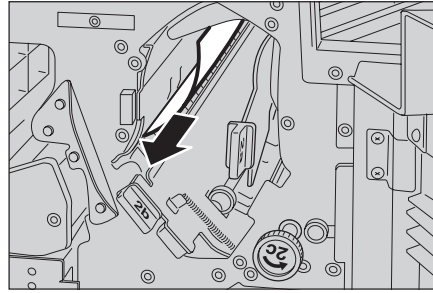

- 6** Return the lever 2a to the original position.

- 7** Close the front cover of the finisher.

Note • A message will be displayed and the machine will not operate if the front cover of the finisher is even slightly open.

Paper Jams at the Lever 2b

- 1** Open the front cover of the finisher.

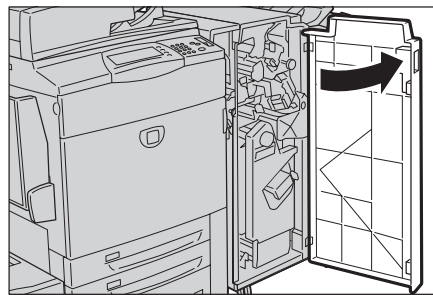

- 2** Move the lever 2b to the right and remove the jammed paper.

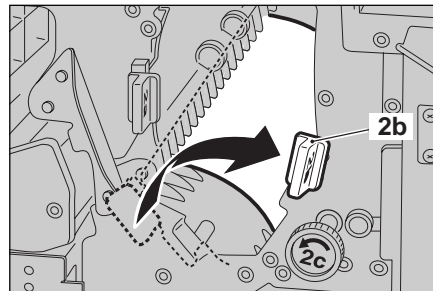

- 3** Return the lever 2b to the original position.

- 4** Close the front cover of the finisher.

Note • A message will be displayed and the machine will not operate if the front cover of the finisher is even slightly open.

Paper Jams at the Lever 2b (Using the Knob 2c)

- 1** Open the front cover of the finisher.

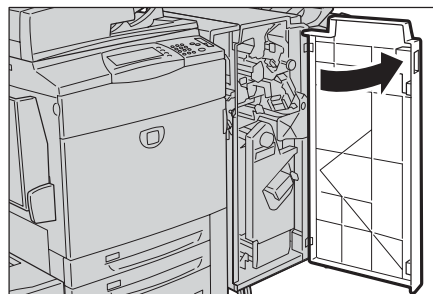

- 2** Move the lever 2b to the right.

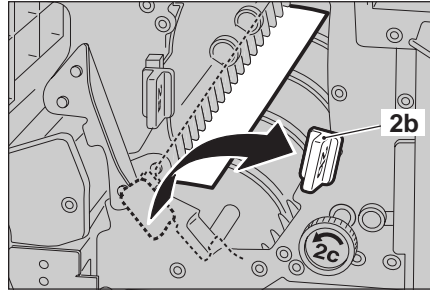

- 3** Turn the knob 2c to the direction indicated by the arrow, and then remove the jammed paper.

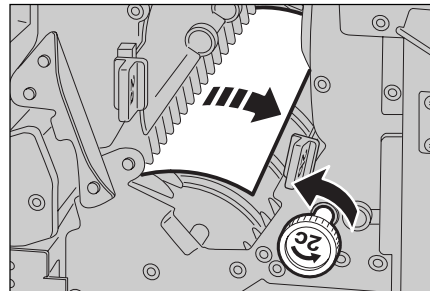

- 4** Gently pull out the paper to remove.

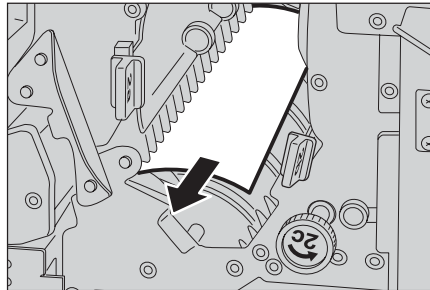

- 5** Return the lever 2b to the original position.

- 6** Close the front cover of the finisher.

Note • A message will be displayed and the machine will not operate if the front cover of the finisher is even slightly open.

Paper Jams at the Lever 3

- 1** Open the front cover of the finisher.

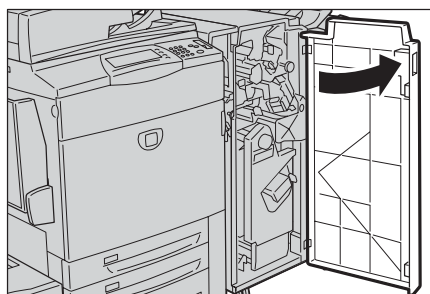

- 2** Pull down the lever 3.

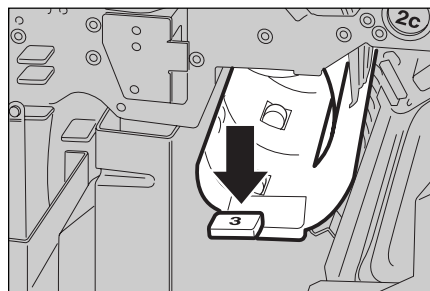

- 3** Remove the jammed paper.

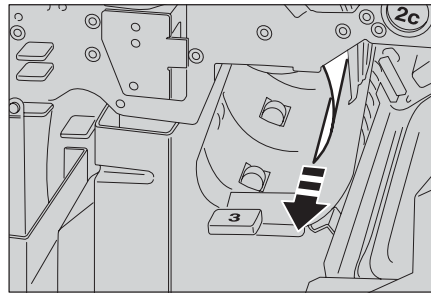

- 4** Return the lever 3 to the original position.

- 5** Close the front cover of the finisher.

Note • A message will be displayed and the machine will not operate if the front cover of the finisher is even slightly open.

Paper Jams at the Lever 5

- 1** Open the exit cover 5 of the finisher upward.

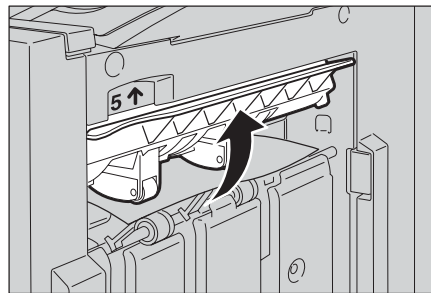

- 2** Gently pull out the paper to remove.

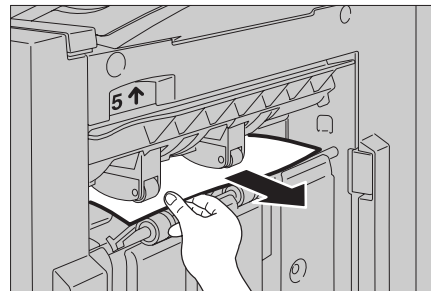

- 3** Return the exit cover 5 to the original position.

Paper Jams at the 4a (for the C-Finisher with Booklet Maker)

- 1** Open the front cover of the finisher.

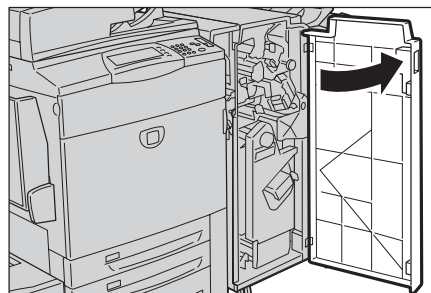

- 2** Pull out the unit 4.

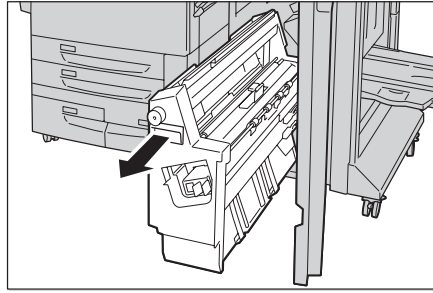

- 3** Turn the knob 4a to the left and remove the jammed paper.

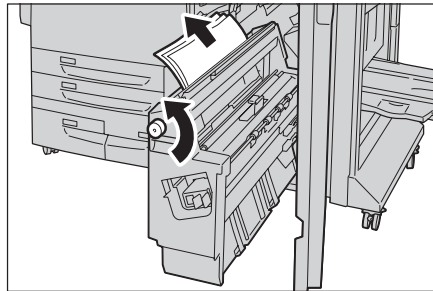

- 4** Return the unit 4 to the original position.

- 5** Close the front cover of the finisher.

Note • A message will be displayed and the machine will not operate if the front cover of the finisher is even slightly open.

Paper Jams at the Lever 4b (for the C-Finisher with Booklet Maker)

- 1** Open the front cover of the finisher.

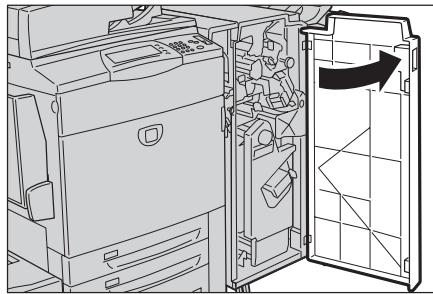

- 2** Move the lever 4b to the left.

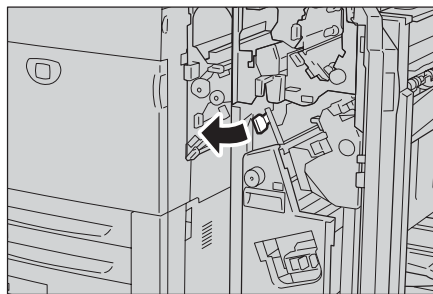

- 3** Remove the jammed paper if there is.



- 4** Pull out the unit 4.

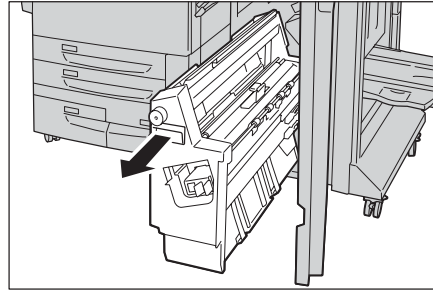

- 5** Remove all jammed paper that comes out from the left upper side and inside the unit.

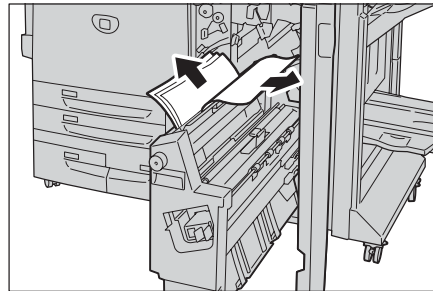

- 6** Return the unit 4 to the original position.

- 7** Return the lever 4b to the original position.

- 8** Close the front cover of the finisher.

Note • A message will be displayed and the machine will not operate if the front cover of the finisher is even slightly open.

Paper Jams at the Booklet Tray (for the C-Finisher with Booklet Maker)

- 1** Open the front cover of the finisher.

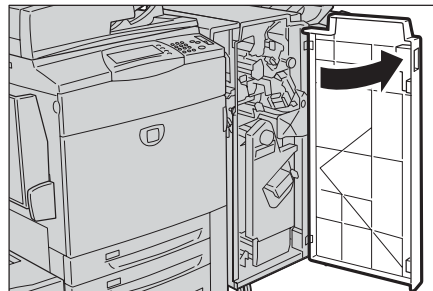

- 2** Turn the knob 4a to the right to eject the jammed paper onto the booklet tray.

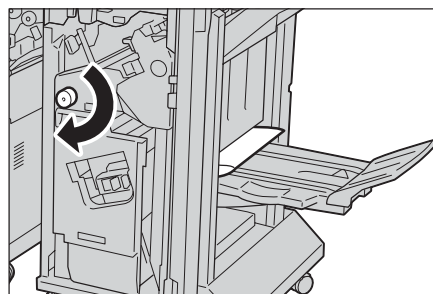

- 3** Remove the jammed paper.

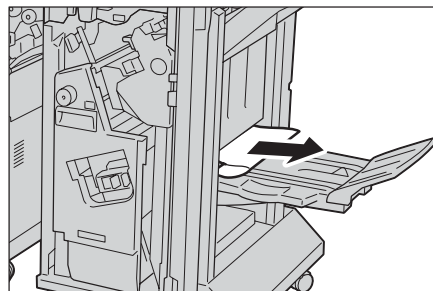

- 4** Close the front cover of the finisher.

- Note** • A message will be displayed and the machine will not operate if the front cover of the finisher is even slightly open.

Paper jams in the Booklet Finisher D2

The following describes how to clear paper jams in the finisher when the Booklet Finisher D2 (optional) is installed.

This section describes how to clear paper jams at the following locations:

Paper Jams in the Tray 8 (Interposer)	384
Paper Jams at the Lever 1a and the Knob 1c	385
Paper Jams at the Lever 1d	385
Paper Jams at the Lever 1b	386
Paper Jams at the Lever 3b and 3d.....	387
Paper Jams at the Lever 3e and the Knob 3c	388
Paper Jams at the Lever 3g and the Knob 3f.....	388
Paper Jams at the Lever 4b and the Knob 3a	389
Paper Jams at the Lever 2a and the Knob 3a when D2 Folder Unit is Installed	390
Paper Jams at the Lever 2b and the Knob 2c when D2 Folder Unit is Installed.....	390
Paper Jams at the Knob 2c, the Levers 2e/2f and the Tri-fold Output Tray 2d when D2 Folder Unit is Installed	391
Paper Jams at the Tri-fold Tray 2d and the Lever 2g when D2 Folder Unit is Installed	392
Paper Jams at the Unit 4 and Knob 4a for the Booklet Finisher D2	392
Paper Jams at the Output Tray	393
Paper Jams at the Finisher Tray	393
Paper Jams at the Booklet Output Tray for the Booklet Finisher D2	393

Paper Jams in the Tray 8 (Interposer)

Following describes how to clear paper jams in the Tray 8 (Interposer)

- 1 Press the <Cover> button.

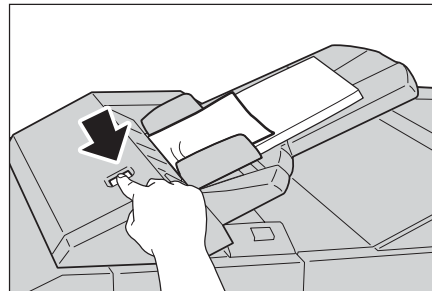

- 2 Open the cover [1e], and then remove the jammed paper and all paper loaded in the Interposer.

Important • When two or more sheets of paper are loaded, remove all of the sheets from the tray.

Note • If paper is torn, check for any torn pieces of paper inside the machine.

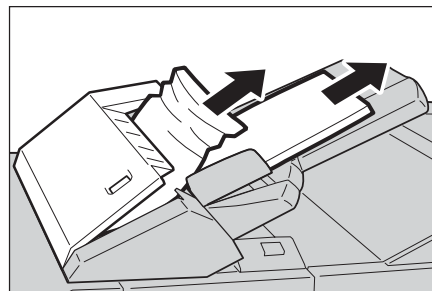

- 3 Fan the paper you removed making sure that all four corners are neatly aligned, and then load them again.

- 4** Push the cover [1e] until it clicks into place and close it.

Note

- A message will be displayed and the machine will not operate if the cover is even slightly open.

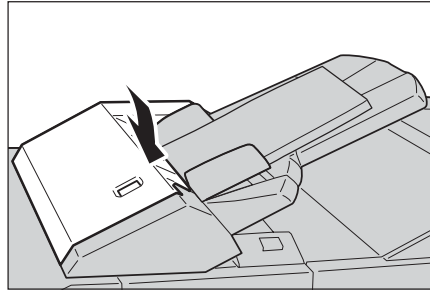

Paper Jams at the Lever 1a and the Knob 1c

- 1** Make sure that the machine has stopped before opening the left cover of the finisher.

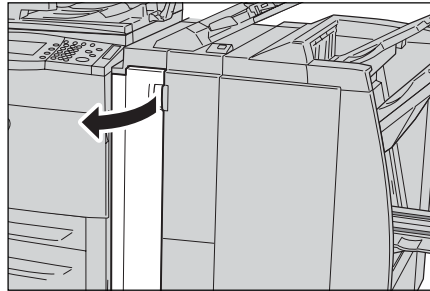

- 2** Move the lever 1a downwards and turn the knob 1c anti-clockwise. Remove the jammed paper.

Note

- If paper is torn, check for any torn pieces of paper inside the machine.

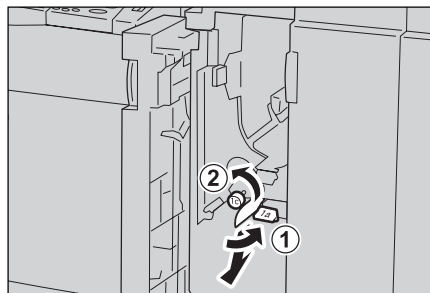

- 3** Return the lever 1a to the original position.

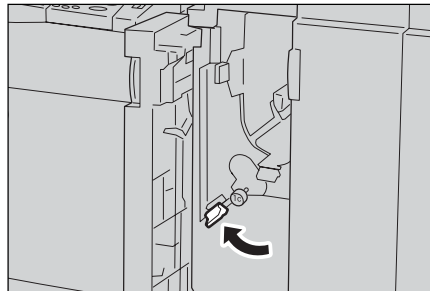

- 4** Close the finisher left cover.

Note

- A message will be displayed and the machine will not operate if the front cover of the finisher is even slightly open.

Paper Jams at the Lever 1d

- 1** Make sure that the machine has stopped before opening the left cover of the finisher.

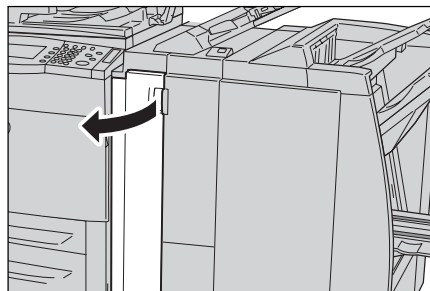

- 2** Move the lever 1d upwards and remove the jammed paper.

Note • If paper is torn, check for any torn pieces of paper inside the machine.

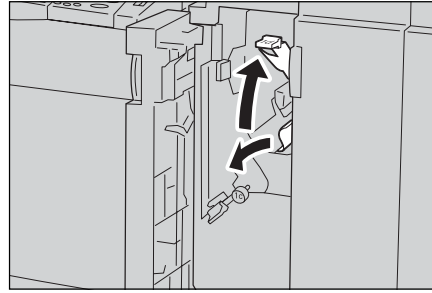

- 3** Return the lever 1d to the original position.

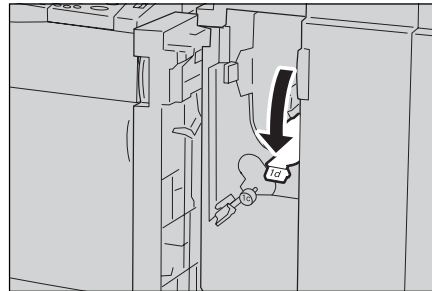

- 4** Close the finisher left cover.

Note • A message will be displayed and the machine will not operate if the front cover of the finisher is even slightly open.

Paper Jams at the Lever 1b

- 1** Make sure that the machine has stopped before opening the left cover of the finisher.

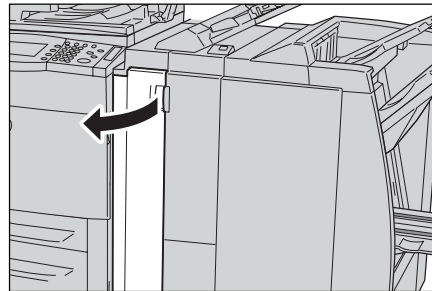

- 2** Move the lever 1b rightwards and remove the jammed paper.

Note • If paper is torn, check for any torn pieces of paper inside the machine.

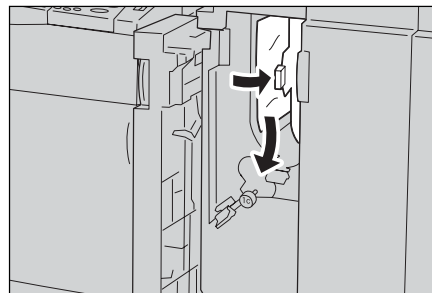

- 3** Return the lever 1b to the original position.

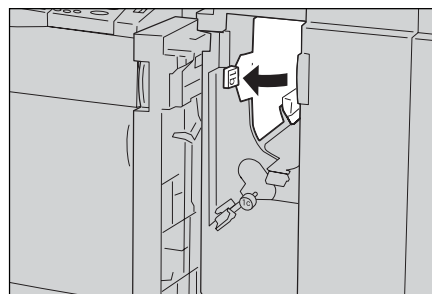

- 4** Close the finisher left cover.

Note • A message will be displayed and the machine will not operate if the front cover of the finisher is even slightly open.

Paper Jams at the Lever 3b and 3d

- 1 Make sure that the machine has stopped before opening the right cover of the finisher.

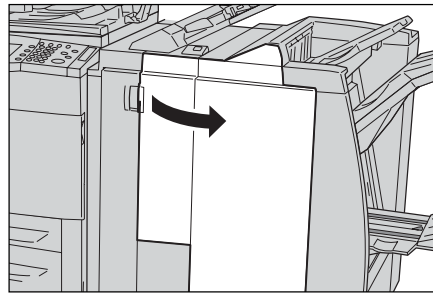

- 2 Move the levers 3b and 3d, and remove the jammed paper.

Note

- If paper is torn, check for any torn pieces of paper inside the machine.

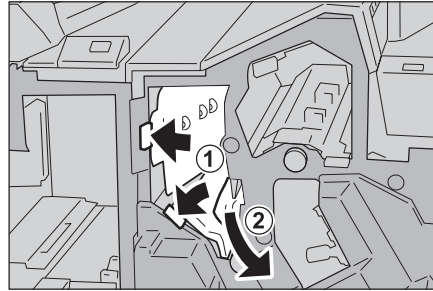

- 3 Return the lever 3b and 3d to the original position.

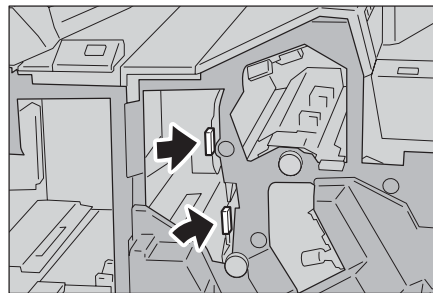

- 4 Close the finisher right cover.

Note

- A message will be displayed and the machine will not operate if the front cover of the finisher is even slightly open.

Paper Jams at the Lever 3e and the Knob 3c

- 1 Make sure that the machine has stopped before opening the right cover of the finisher.

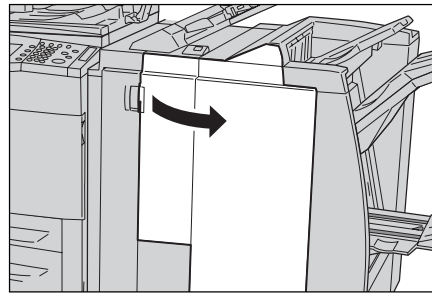

- 2 Move the levers 3e and turn the knob 3c to the right. Remove the jammed paper.

Note • If paper is torn, check for any torn pieces of paper inside the machine.

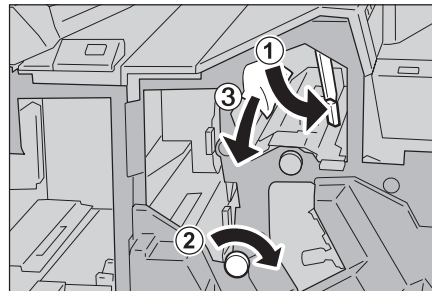

- 3 Return the lever 3e to the original position.



- 4 Close the finisher right cover.

Note • A message will be displayed and the machine will not operate if the front cover of the finisher is even slightly open.

Paper Jams at the Lever 3g and the Knob 3f

- 1 Make sure that the machine has stopped before opening the right cover of the finisher.

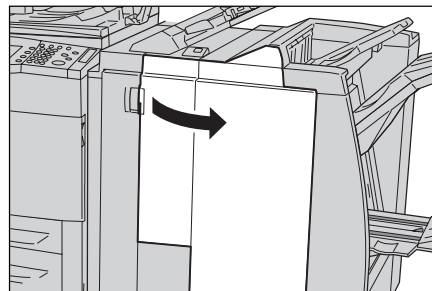

- 2 Move the levers 3g and turn the knob 3f to the left. Remove the jammed paper.

Note • If paper is torn, check for any torn pieces of paper inside the machine.

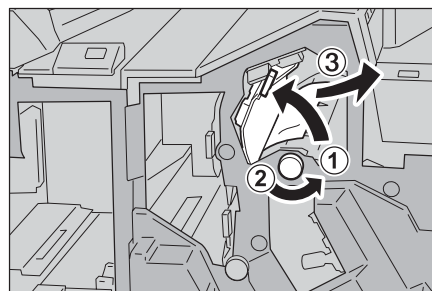

- 3** Return the lever 3g to the original position.

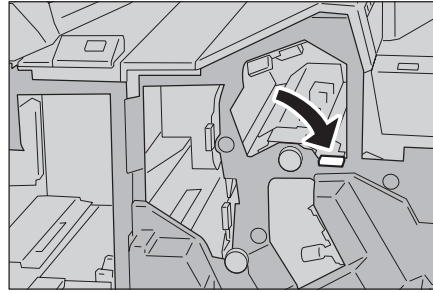

- 4** Close the finisher right cover.

Note • A message will be displayed and the machine will not operate if the front cover of the finisher is even slightly open.

Paper Jams at the Lever 4b and the Knob 3a

- 1** Make sure that the machine has stopped before opening the right cover of the finisher.

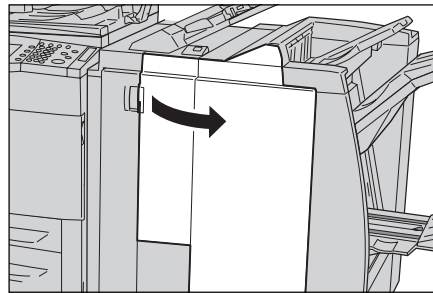

- 2** Move the levers 4b and turn the knob 3a to the right. Remove the jammed paper.

Note • If paper is torn, check for any torn pieces of paper inside the machine.

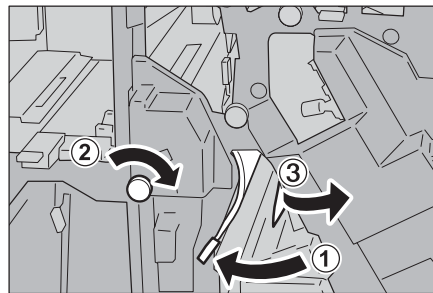

- 3** Return the lever 4b to the original position.

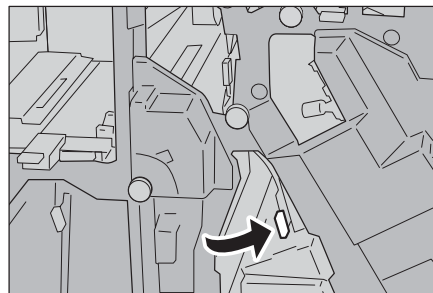

- 4** Close the finisher right cover.

Note • A message will be displayed and the machine will not operate if the front cover of the finisher is even slightly open.

Paper Jams at the Lever 2a and the Knob 3a when D2 Folder Unit is Installed

- 1 Make sure that the machine has stopped before opening the right cover of the finisher.

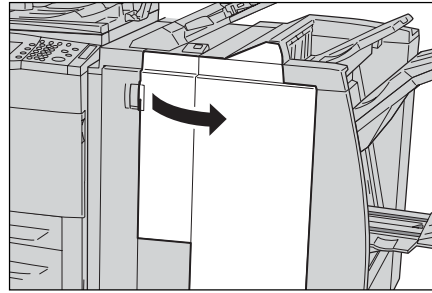

- 2 Move the lever 2a and turn the knob 3a to the left. Remove the jammed paper.

Note • If paper is torn, check for any torn pieces of paper inside the machine.

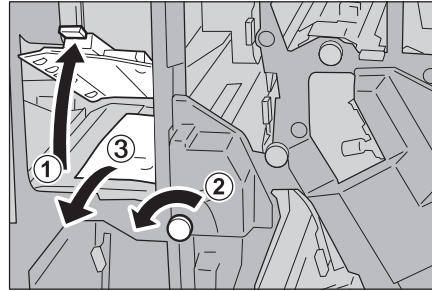

- 3 Return the lever 2a to the original position.

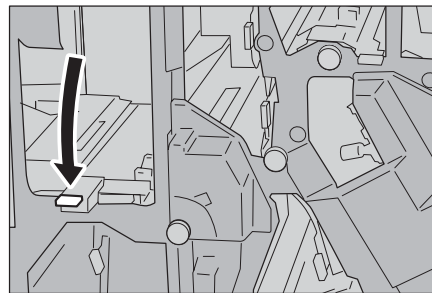

- 4 Close the finisher right cover.

Note • A message will be displayed and the machine will not operate if the front cover of the finisher is even slightly open.

Paper Jams at the Lever 2b and the Knob 2c when D2 Folder Unit is Installed

- 1 Make sure that the machine has stopped before opening the right cover of the finisher.

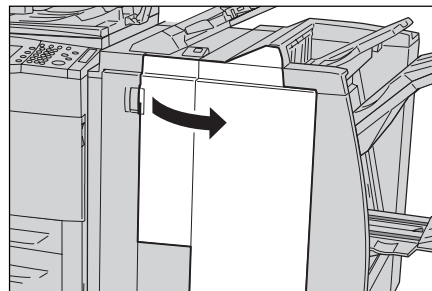

- 2 Move the levers 2b and turn the knob 3a to the right. Remove the jammed paper.

Note • If paper is torn, check for any torn pieces of paper inside the machine.

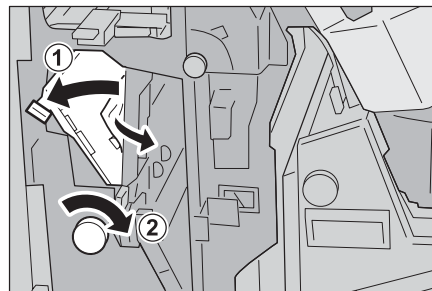

- 3** Return the lever 2b to the original position.

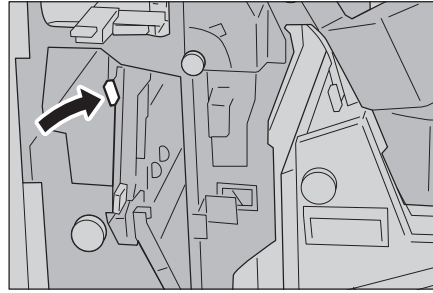

- 4** Close the finisher right cover.

Note • A message will be displayed and the machine will not operate if the front cover of the finisher is even slightly open.

Paper Jams at the Knob 2c, the Levers 2e/2f and the Tri-fold Output Tray 2d when D2 Folder Unit is Installed

- 1** Make sure that the machine has stopped before opening the right cover of the finisher.

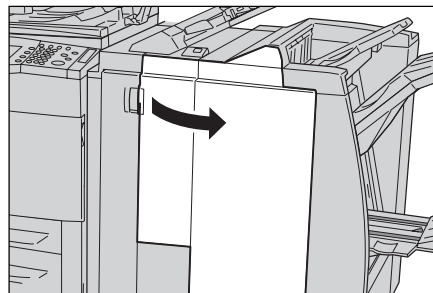

- 2** Pull out the tri-fold output tray 2d, swing the lever 2e, and remove the jammed paper.

Note • If paper is torn, check for any torn pieces of paper inside the machine.

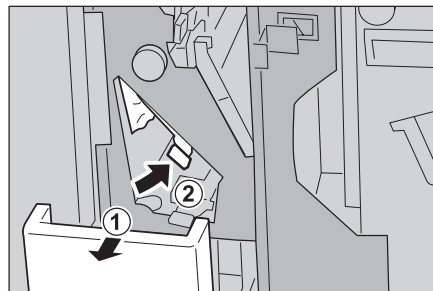

- 3** If you cannot remove the paper in Step 2, return the lever 2e to the original position. Swing the lever 2e, turn the knob 2c to the right, then remove the jammed paper.

Note • If paper is torn, check for any torn pieces of paper inside the machine.

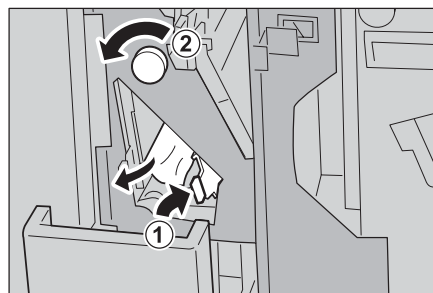

- 4** Swing back the opened lever (2f or 2e), and push back the tri-fold output tray 2d.

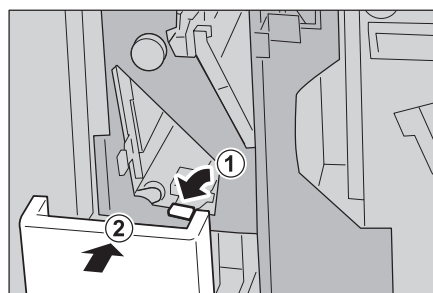

- 5** Close the finisher right cover.

Note • A message will be displayed and the machine will not operate if the front cover of the finisher is even slightly open.

Paper Jams at the Tri-fold Tray 2d and the Lever 2g when D2 Folder Unit is Installed

- 1 Make sure that the machine has stopped before opening the right cover of the finisher.

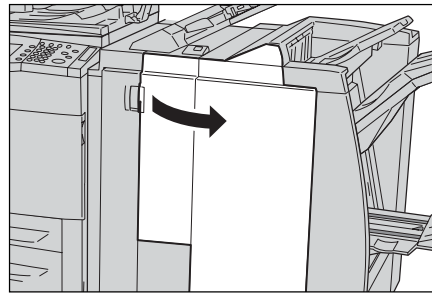

- 2 Pull out the tri-fold output tray 2d, swing the lever 2g, and remove the jammed paper.

Note • If paper is torn, check for any torn pieces of paper inside the machine.

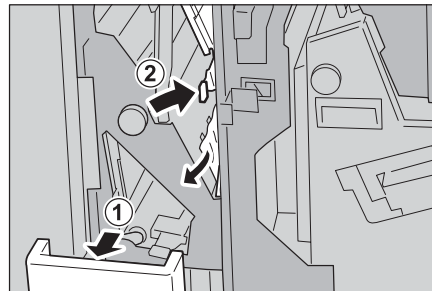

- 3 Return the lever 2g to the original position and push back the tri-fold output tray 2d.

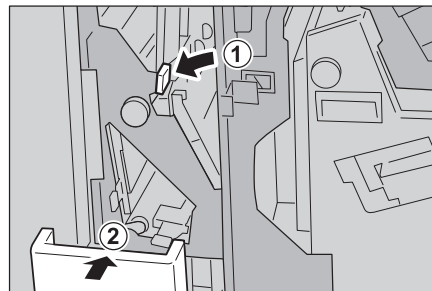

- 4 Close the finisher right cover.

Note • A message will be displayed and the machine will not operate if the front cover of the finisher is even slightly open.

Paper Jams at the Unit 4 and Knob 4a for the Booklet Finisher D2

- 1 Make sure that the machine has stopped before opening the right cover of the finisher.

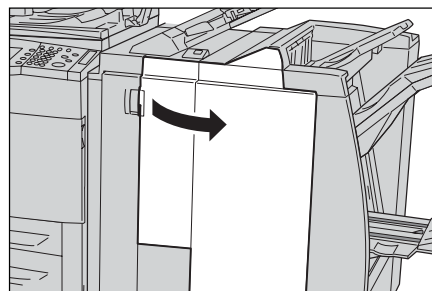

- 2 Pull out the unit 4.

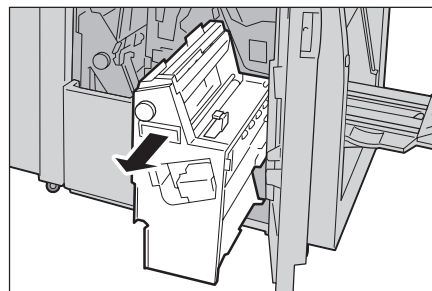

- 3** Turn the knob 4a to the left to remove all the jammed paper from the left side of the unit 4.

Note • If paper is torn, check for any torn pieces of paper inside the machine.

- 4** Return the unit 4 to the original position.

- 5** Close the finisher right cover.

Note • A message will be displayed and the machine will not operate if the front cover of the finisher is even slightly open.

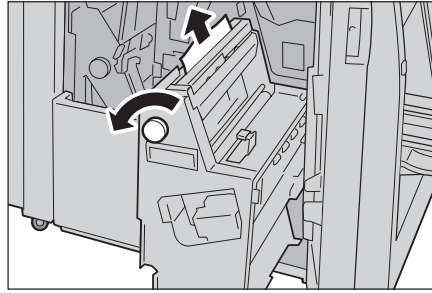

Paper Jams at the Output Tray

- 1** Remove jammed paper from the output tray.

Note • If paper is torn, check for any torn pieces of paper inside the machine.

- 2** Open and close the right cover of the finisher.

Note • A message will be displayed and the machine will not operate if the front cover of the finisher is even slightly open.

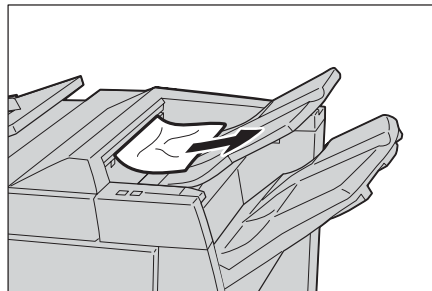

Paper Jams at the Finisher Tray

- 1** Remove jammed paper from the finisher tray.

Note • If paper is torn, check for any torn pieces of paper inside the machine.

- 2** Open and close the right cover of the finisher.

Note • A message will be displayed and the machine will not operate if the front cover of the finisher is even slightly open.

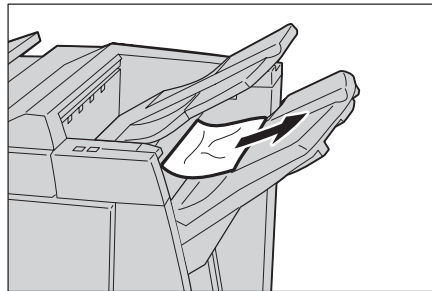

Paper Jams at the Booklet Output Tray for the Booklet Finisher D2

- 1** Make sure that the machine has stopped before opening the right cover of the finisher.

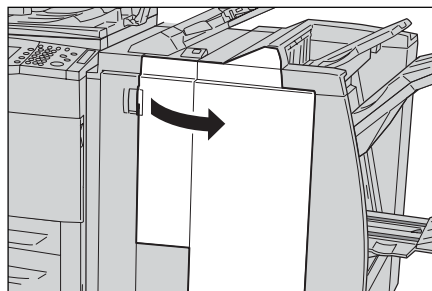

- 2** Turn the knob 4a to the right to remove the jammed paper at the booklet output tray.

Note • If paper is torn, check for any torn pieces of paper inside the machine.

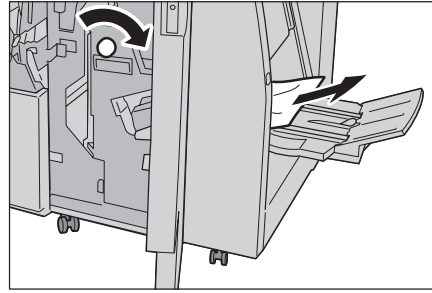

- 3** Close the finisher right cover.

Note • A message will be displayed and the machine will not operate if the front cover of the finisher is even slightly open.

Document Jams

If a document jams in the document feeder, the machine stops, and an error message is displayed on the screen. Clear the document jam according to the instructions displayed, and then load the document again on the document feeder.

This section describes how to clear document jams at the following locations:

Document Jams at the Covers	395
Document Jams at the Document Cover	396

Note • Remedy differs depending on where the document jam occurs. Follow the instructions displayed and remove the jammed paper.

Document Jams at the Covers

- 1 Grip the handle of the top cover of the document feeder, and open the top cover until it comes to a stop.

Note • When you fully open the cover, it enters a fixed position. Open the cover gently.

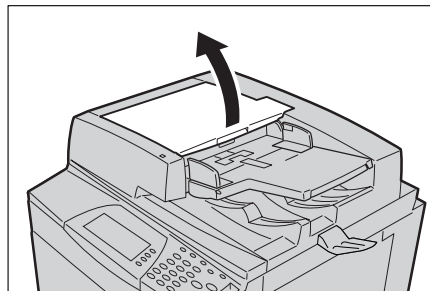

- 2 Open the left cover until it comes to a stop.

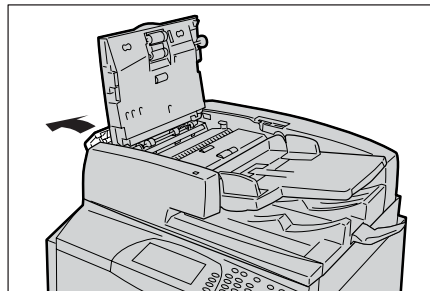

- 3 If the document is not caught in the entry of the document feeder, pull out the document.

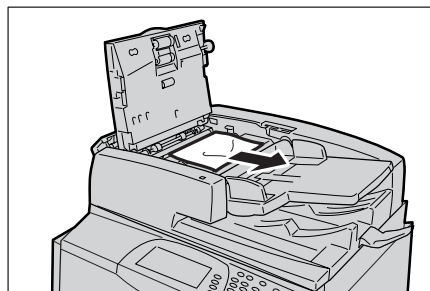

- 4 If there are instructions to open the inner cover, lift up the lever with the green label on it, and open the inner cover. Then remove the jammed paper.

Important • If the document is stuck, do not pull on it directly. The document could be damaged.

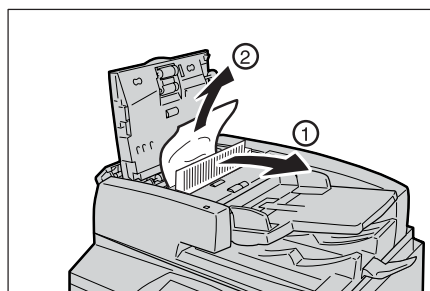

- 5** When the inside of the left cover is indicated, remove the jammed document.

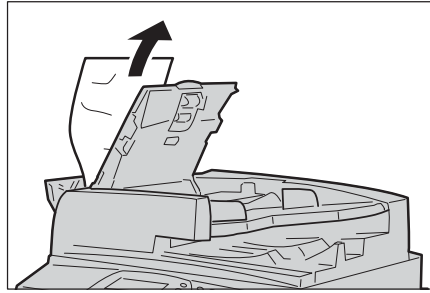

- 6** Close the top cover of the inner cover until it clicks into place.
7 Close the left cover of the document feeder until it clicks into place.
8 If the document cannot be found, pick up the document feeder slowly, and remove the document if it is there, then close the document feeder.
9 If the document is not found in step 10, then pick up the document feeder tray and remove the document.

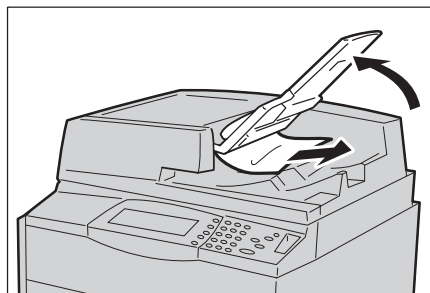

- 10** Gently return the document feeder tray.
11 Make sure that the document is not torn, wrinkled or folded, and load the document again following the instructions displayed on the screen.

Note • Torn, wrinkled or folded documents may cause document jams and damage. To scan such documents, directly place the document on the document glass to make copies.

Document Jams at the Document Cover

- 1** Open the document cover.

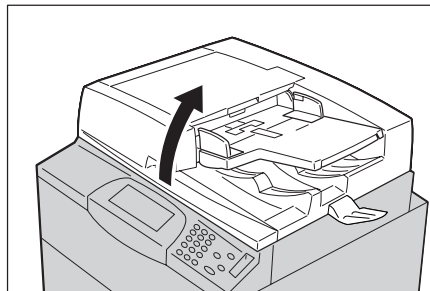

- 2** Open the belt of the document cover while gripping the lever, and remove the jammed document.

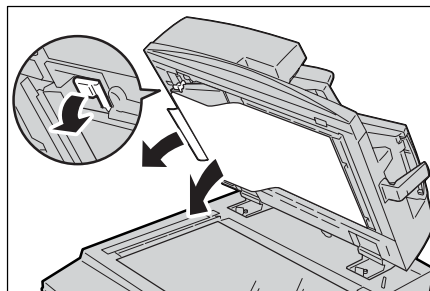

- 3 Gently return the belt to the original position.

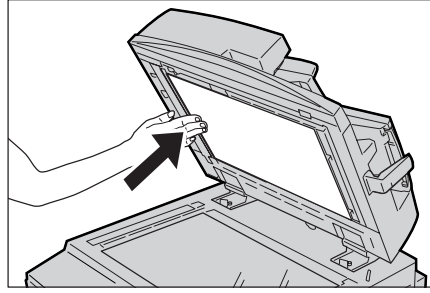

- 4 Return the document cover to the original position.

- 5 Make sure that the document is not torn, wrinkled or folded, and load the document again following the instructions displayed on the screen.

Note • Torn, wrinkled or folded documents may cause document jams and damage. To scan such documents, directly place the document on the document glass to make copies.

Stapler Faults

The following describes stapler troubles when the finisher (optional) is installed.

Follow the procedures on the following pages when copies are not stapled or staples are bent. Contact our Customer Support Center if the problem persists after you have tried the following solutions.

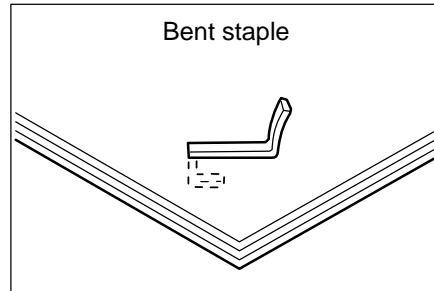
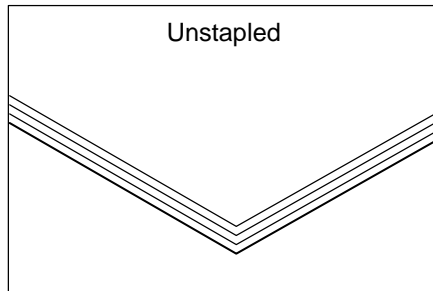

If copies are stapled as shown in the figures below, contact our Customer Support Center.

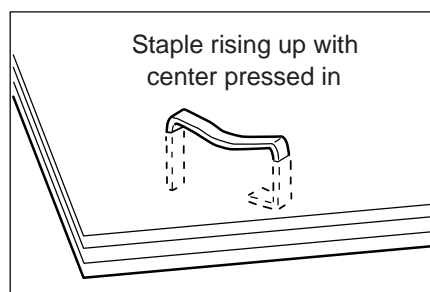
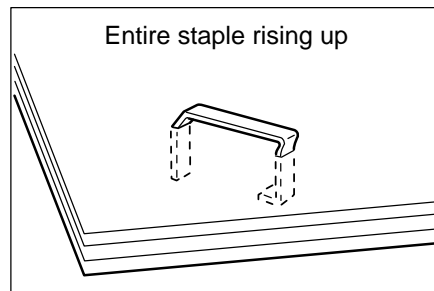
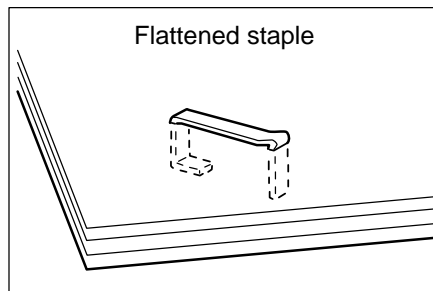
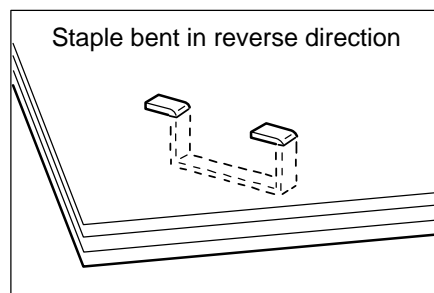
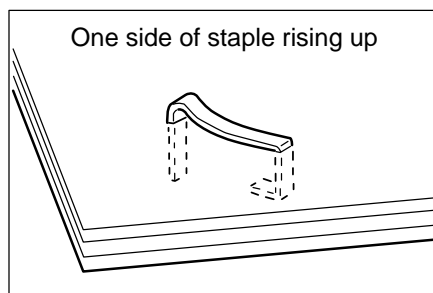

Important • When using Booklet Finisher D2, depending on the type of paper that is being stapled, the stapled nails may be bent. If the bent nails are stuck inside the machine, they may eventually cause paper jams.

- Remove the bent staple when opening the staple cartridge cover. If you do not remove the bent staple, a staple jam may occur as a result. Use the staple cartridge cover only when removing the bent staple.

Staple Jams in the Staple Cartridge for C-Finisher or C-Finisher with Booklet Maker

The following describes how to clear staple jams in the staple cartridge when the C-Finisher (optional) or the C-Finisher with Booklet Maker (optional) is installed.

The following example shows how to clear paper jams in the C-Finisher with Booklet Maker. The procedure is the same as for the C-Finisher.

⚠ CAUTION

Be careful in removing jammed staples.

- 1 Make sure that the machine has stopped before opening the front cover of the finisher.

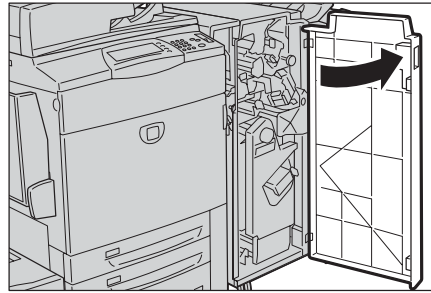

- 2 Grip the lever R1 of the staple cartridge holder, and pull out the holder to the right towards you.

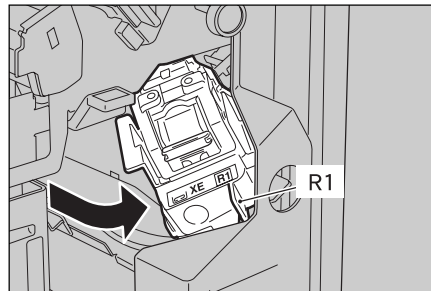

- 3 Remove the staple cartridge holder by gripping the orange lever.

Note

- The staple cartridge is firmly held. When remove the staple cartridge, strongly pull the cartridge.

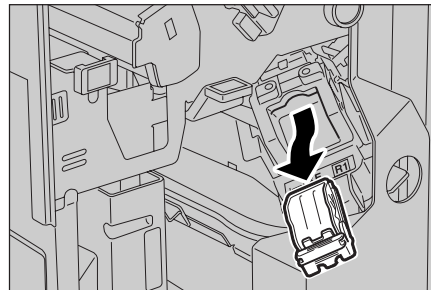

- 4 After removing the staple cartridge, check the inside of the finisher for any remaining staples.

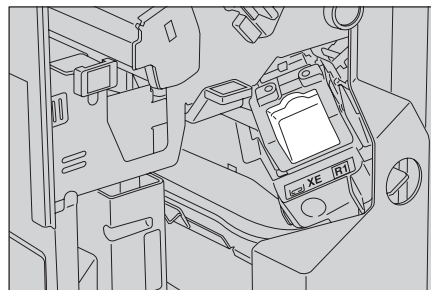

- 5** Pull up the metal part of the staple cartridge shown in the figure.

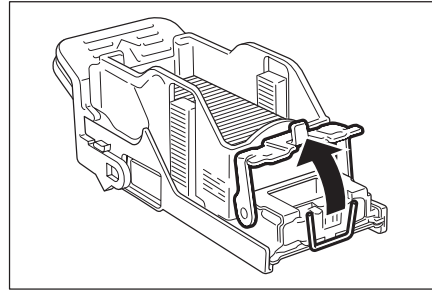

- 6** Remove the jammed staples (1), and return the metal part pulled up in step 5 to the original position (2).

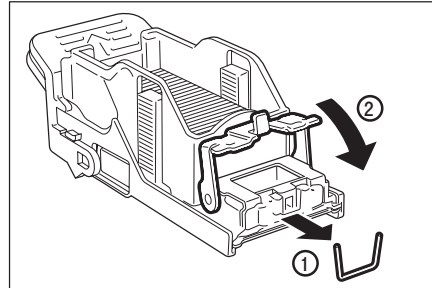

- 7** Insert the staple cartridge while gripping the orange lever until it clicks into place.

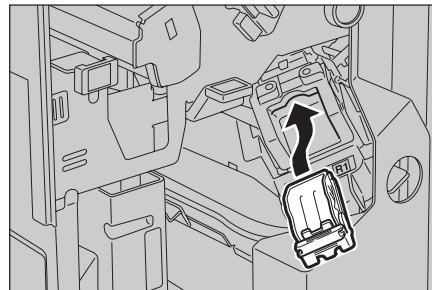

- 8** Close the front cover of the finisher.

Note • A message will be displayed and the machine will not operate if the front cover of the finisher is even slightly open.

If the staples cannot be removed after carrying out the above procedures, contact our Customer Support Center.

Staple Jams in the Booklet Staple Cartridge for the C-Finisher with Booklet Maker or Booklet Finisher D2

The following describes how to clear staple jams in the booklet staple cartridge when the C-Finisher with Booklet Maker or the Booklet Finisher D2 (optional) is installed.

The following example shows how to clear paper jams in the C-Finisher with Booklet Maker. The procedure is the same as for the Booklet Finisher D2.

⚠ CAUTION

Be careful when you try to remove jammed stapler needle.

- 1 Make sure that the machine has stopped before opening the front cover of the finisher.

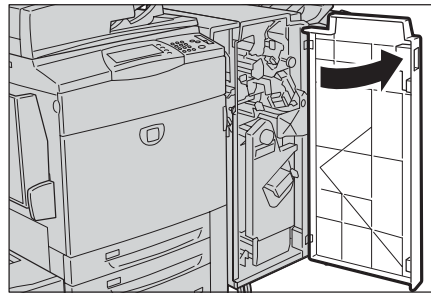

- 2 Press the levers R2 and R3 to the right, and pull out the unit.

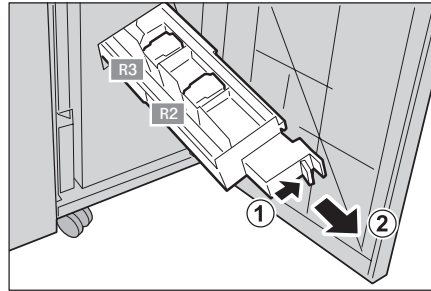

- 3 Hold the tabs of the staple cartridge, and then lift to remove it.

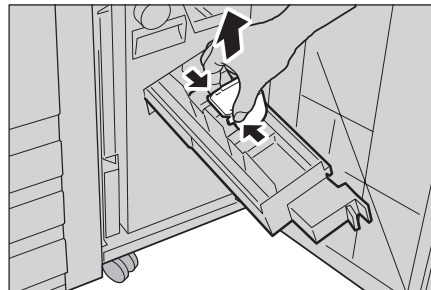

- 4 Remove the jammed staples as shown in the figure.

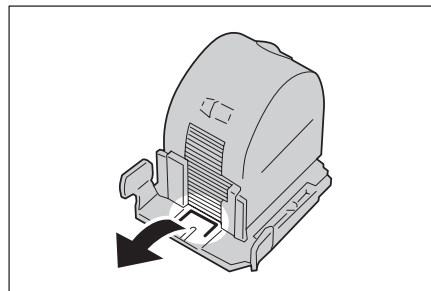

- 5 Holding the tabs of the removed staple cartridge, return the cartridge to the original position and gently push it until it clicks into place.

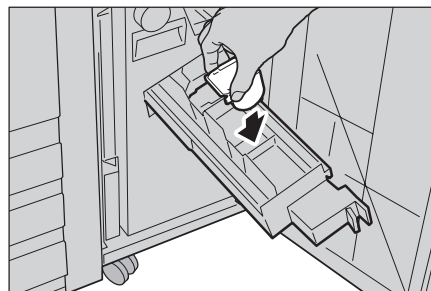

- 6 Return the unit to its original position.

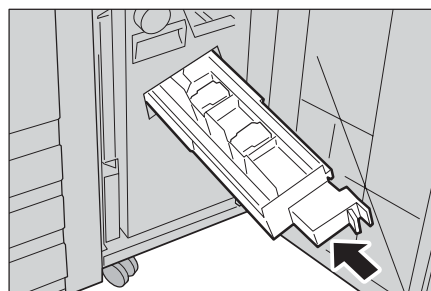

7 Close the front cover of the finisher.

- Note**
- A message will be displayed and the machine will not operate if the front cover of the finisher is even slightly open.

If the staples cannot be removed after carrying out the above procedures, contact our Customer Support Center.

Staple Jams in the Staple Cartridge for the Booklet Finisher D2

The following describes how to clear staple jams in the staple cartridge when the Booklet Finisher D2 (optional) is installed.

⚠ CAUTION

Be careful when you try to remove jammed stapler needle.

- 1** Make sure that the machine has stopped before opening the right cover of the finisher.

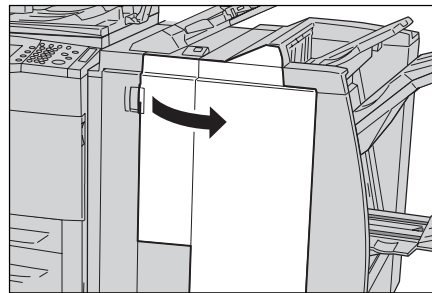

- 2** Hold the R1 at the position shown in the figure.

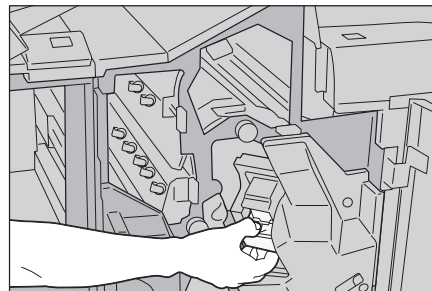

- 3** Pull out the unit.

- Note**
- After removing the unit, check the inside of the finisher for any remaining staples.

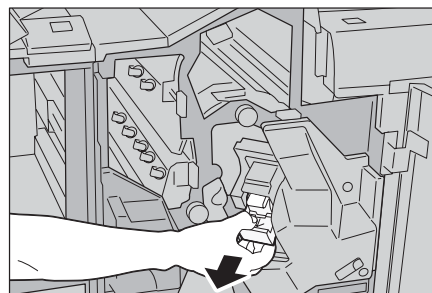

- 4** Open the unit as shown in the figure and remove the jammed staple.

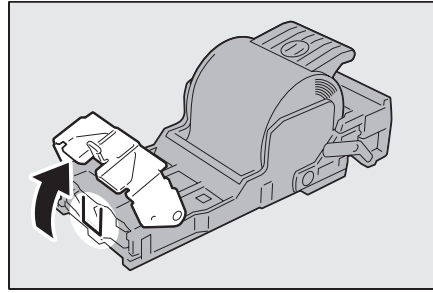

- 5** Push the removed unit back to the original position.

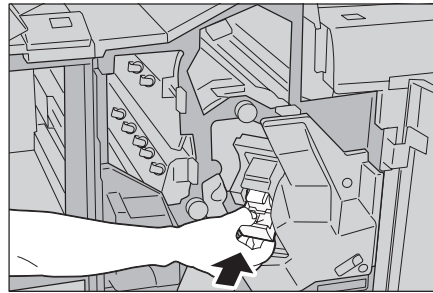

- 6** Close the right cover of the finisher.

Note • A message will be displayed and the machine will not operate if the front cover of the finisher is even slightly open.

If the staples cannot be removed after carrying out the above procedures, contact our Customer Support Center.

Staple Cartridge Taken Off from Unit for the Booklet Finisher D2

The following describes how to set the staple cartridge to its unit when it has been attached incorrectly or taken off from its unit accidentally.

⚠ CAUTION

Be careful when you try to remove jammed stapler needle.

- 1** Open the staple cartridge cover as shown in the figure, and remove the jammed staple.

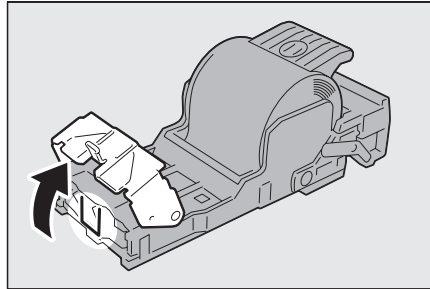

- 2** See a lever on the rear side of the unit.

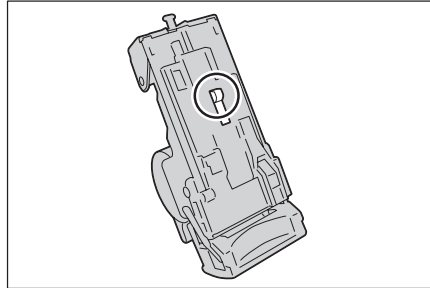

- 3** Move the lever in the direction of the arrow shown in the figure.

Important • Be careful when removing jammed staples to avoid hurting your fingers and nails.

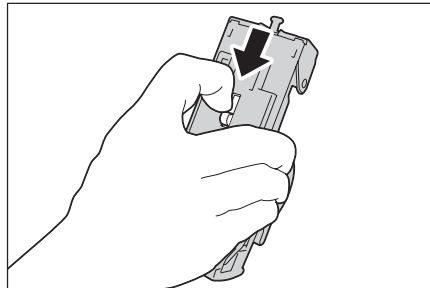

- 4** Turn the unit upside holding the lever, and then take off the staple cartridge from its unit.

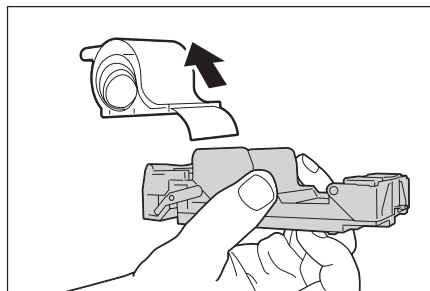

- 5** Tear the outside staples along the line as shown in the figure.

Important • Be careful when removing jammed staples to avoid hurting your fingers.

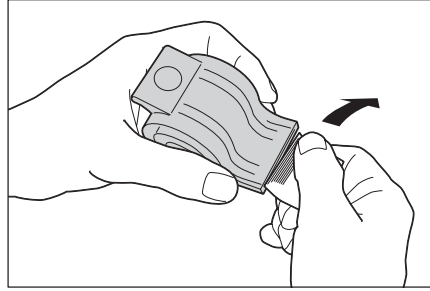

- 6** Push the staple cartridge in the unit.

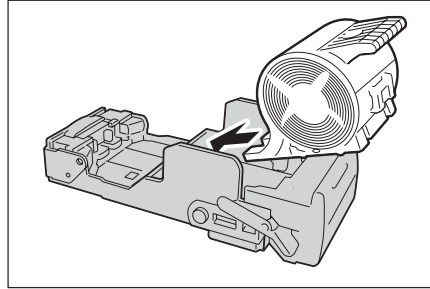

- 7** Return the unit to the original position.

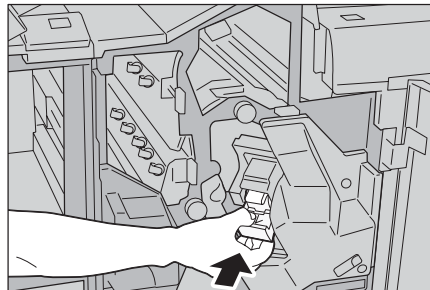

- 8** Close the right cover of the finisher.

Note • A message will be displayed and the machine will not operate if the front cover of the finisher is even slightly open.

Solving Curled Output for the Booklet Finisher D2

You can correct the curling of the output by pressing the De-curl button.

The De-curl button functions both in suspension and in operation if the power of the machine is on.

- Note**
- To change the curling correction mode while the machine is in operation, press the De-curl button and then the change will be applied immediately.
 - Pressing the Reset button on the control panel cannot change the curling correction mode.

- 1** Check how the output copy is curled.

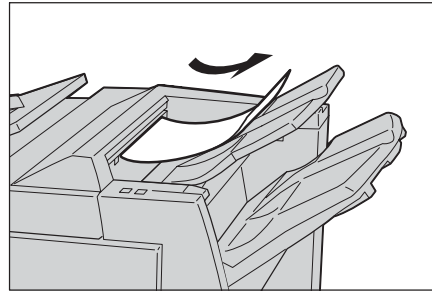

- 2** Check that De-curl lights up.

- Note**
- When turning on the power of this machine, the de-curl mode is set to Auto.
 - When you cancel the Power Saver Mode, the de-curl mode will be set to Auto.

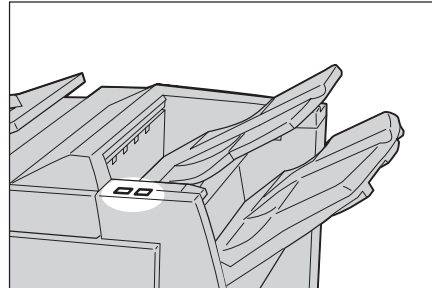

- 3** Press De-curl.

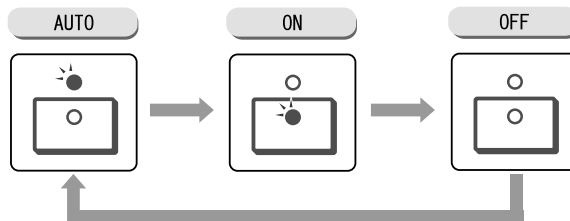

- Note**
- Pressing the De-curl button toggles the mode between Auto, ON, and OFF. For more information, refer to "Mode and function of <De-curl> button" (P.144).

Mode and function of <De-curl> button

The following describes the mode and function of <De-curl> button.

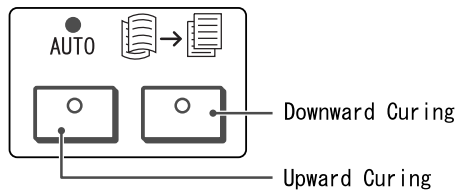

De-curl button		Functions
Indicator	Mode	
	<AUTO>	Performs curling correction automatically. The curling correction is automatically performed according to the paper size or output orientation. It is recommend that this feature be used in Auto mode. The Auto mode is entered in the following cases: <ul style="list-style-type: none"> • After turning on the power of this machine • After canceling the power saver mode
	Upward Curling <ON>	The upward curling can be corrected for all paper. If the output paper is curled upward, press this button to make it straight.
	Downward Curling <ON>	The downward curling can be corrected for all paper. If the output paper is curled downward, press this button to make it straight.
	<OFF>	When no indicator is lit, the machine does not perform the curling correction to straighten the curled output.

15 Appendix

This chapter contains information on the machine specifications, notes and restrictions, optional components, and printer emulation languages.

- Specifications..... 410
- Printable Area 420
- Internal Fonts..... 421
- Optional Components 423
- ESC/P-K Emulation 425
- PDF Direct Print..... 439
- PCL Emulation..... 441
- HP-GL2 Emulation..... 445
- Notes and Restrictions..... 459

Specifications

This section lists the main specifications of the machine. Note that the specifications and the appearance of the product may change without prior notice.

■ Copy Feature Specifications

Type	Console
Memory capacity	1 GB
Hard disk capacity	80 GB
Color support	Full Color
Scan resolution	600 × 600 dpi
Output resolution	2,400 × 2,400 dpi
Gradation	256 color gradation for each color (16,700,000 colors)
Warm-up time	150 seconds or less (at 20 °C room temperature) Important • It may take longer due to the network condition, or the image quality adjustment according to the machine condition.
Copy document	The maximum size is 297×432 mm (A3, 11 × 17") for both sheets and books.
Copy (sheet) size	Maximum : A3 (297×420 mm), Tabloid (11 x 17") Minimum : A5 (148×210 mm), (100 x 148 mm for the Tray 5 (bypass)) Image loss width: Top edge, 4 mm or less; bottom edge, 4 mm or less; left and right edges, 3 mm or less
Copy paper	Paper Tray 1 to 4 : 64 - 176 g/m ² Paper Tray 5 (Bypass): 64 - 280 g/m ² Important • The use of paper recommended by Fuji Xerox is suggested. Copying may not be performed correctly depending on the conditions.
First copy output time Important • The values may vary depending on the machine configuration.	<ul style="list-style-type: none"> For (A4 □)/monochrome priority mode (the default for the [Color Mode] is [Black] or [No Default]) Monochrome: 4.1 seconds For (A4 □)/color priority mode (the default for the [Output Color] is [Full Color], [Auto], [Dual Colors], or [Single Color]) Color: 7.8 seconds
Magnification	Size-for-Size 1:1±0.7% Preset % 1:0.500, 1:0.707, 1:0.816, 1:0.866, 1:1.154, 1:1.225, 1:1.414 Variable % 1:1:0.25-1:4.00 (1% increments)

<p>Continuous copy speed</p> <p>Important</p> <ul style="list-style-type: none"> • The speed may be reduced due to image quality adjustment. • The performance may be reduced depending on the paper type. 	<p><ApeosPort-II C7500, DocuCentre-II C7500></p> <ul style="list-style-type: none"> • Paper Tray 1 - 4 : Continuous 1 sided copy/same magnification <ul style="list-style-type: none"> [Monochrome] [Color] B5, A4 : 75 sheets/minute 50 sheets/minute B5, A4 : 54 sheets/minute 36 sheets/minute B4 : 44 sheets/minute 30 sheets/minute A3 : 37 sheets/minute 25 sheets/minute • Paper Tray 1 - 4 : Continuous 2 sided copy/same magnification <ul style="list-style-type: none"> [Monochrome] [Color] B5, A4 : 75 pages/minute 45 pages/minute*¹ B5, A4 : 50 pages/minute*¹ 36 pages/minute B4 : 44 pages/minute 30 pages/minute A3 : 37 pages/minute 25 pages/minute • Paper Tray 5*² : Continuous 1 sided copy/same magnification <ul style="list-style-type: none"> [Monochrome] [Color] B5, A4 : 50 sheets/minute 40 sheets/minute B5, A4 : 41 sheets/minute 32 sheets/minute B4 : 36 sheets/minute 28 sheets/minute A3 : 32 sheets/minute 24 sheets/minute • Paper Tray 5*² : Continuous 2 sided copy/same magnification <ul style="list-style-type: none"> [Monochrome] [Color] B5, A4 : 50 pages/minute 40 pages/minute B5, A4 : 41 pages/minute 32 pages/minute B4 : 36 pages/minute 28 pages/minute A3 : 32 pages/minute 24 pages/minute <p><ApeosPort-II C6500, DocuCentre-II C6500></p> <ul style="list-style-type: none"> • Paper Tray 1 - 4 : Continuous 1 sided copy/same magnification <ul style="list-style-type: none"> [Monochrome] [Color] B5, A4 : 65 sheets/minute 50 sheets/minute B5, A4 : 47 sheets/minute 36 sheets/minute B4 : 39 sheets/minute 30 sheets/minute A3 : 33 sheets/minute 25 sheets/minute • Paper Tray 1 - 4 : Continuous 2 sided copy/same magnification <ul style="list-style-type: none"> [Monochrome] [Color] B5, A4 : 59 pages/minute*¹ 45 pages/minute*¹ B5, A4 : 47 pages/minute 36 pages/minute B4 : 39 pages/minute 30 pages/minute A3 : 33 pages/minute 25 pages/minute • Paper Tray 5*² : Continuous 1 sided copy/same magnification <ul style="list-style-type: none"> [Monochrome] [Color] B5, A4 : 44 sheets/minute 40 sheets/minute B5, A4 : 36 sheets/minute 32 sheets/minute B4 : 31 sheets/minute 28 sheets/minute A3 : 28 sheets/minute 24 sheets/minute • Paper Tray 5*² : Continuous 2 sided copy/same magnification <ul style="list-style-type: none"> [Monochrome] [Color] B5, A4 : 44 pages/minute 40 pages/minute B5, A4 : 36 pages/minute 32 pages/minute B4 : 31 pages/minute 28 pages/minute A3 : 28 pages/minute 24 pages/minute <p>*1 After delivering the first page, the copy speed for remaining pages becomes the same speed as 1 sided copying.</p> <p>*2 When paper is fed from Tray 5 (Bypass) and the paper size is set to [Auto Size Detect], the printing speed for the first page will be slower.</p>
---	--

<p>Continuous copy speed</p> <p>Important</p> <ul style="list-style-type: none"> The speed may be reduced due to image quality adjustment. The performance may be reduced depending on the paper type. 	<p><ApeosPort-II C5400, DocuCentre-II C5400></p> <ul style="list-style-type: none"> Paper Tray 1 - 4 : Continuous 1 sided copy/same magnification <ul style="list-style-type: none"> [Monochrome] [Color] B5, A4 : 55 sheets/minute 40 sheets/minute B5, A4 : 40 sheets/minute 29 sheets/minute B4 : 33 sheets/minute 24 sheets/minute A3 : 28 sheets/minute 20 sheets/minute Paper Tray 1 - 4 : Continuous 2 sided copy/same magnification <ul style="list-style-type: none"> [Monochrome] [Color] B5, A4 : 50 pages/minute*1 40 pages/minute B5, A4 : 40 pages/minute 29 pages/minute B4 : 33 pages/minute 24 pages/minute A3 : 28 pages/minute 20 pages/minute Paper Tray 5*2 : Continuous 1 sided copy/same magnification <ul style="list-style-type: none"> [Monochrome] [Color] B5, A4 : 37 sheets/minute 32 sheets/minute B5, A4 : 30 sheets/minute 26 sheets/minute B4 : 27 sheets/minute 22 sheets/minute A3 : 24 sheets/minute 19 sheets/minute Paper Tray 5*2 : Continuous 2 sided copy/same magnification <ul style="list-style-type: none"> [Monochrome] [Color] B5, A4 : 37 pages/minute 32 pages/minute B5, A4 : 30 pages/minute 26 pages/minute B4 : 27 pages/minute 22 pages/minute A3 : 24 pages/minute 19 pages/minute <p>*1 After delivering the first page, the copy speed for remaining pages becomes the same speed as 1 sided copying.</p> <p>*2 When paper is fed from Tray 5 (Bypass) and the paper size is set to [Auto Size Detect], the printing speed for the first page will be slower.</p>
<p>Paper feed method/ Capacity</p>	<p>Standard: 500 sheets x 2 trays + 870 sheets + 1,140 sheets + 250 sheets (bypass tray)</p> <p>Optional :</p> <p>HCF (A4 1Tray): 2,000 sheets</p> <p>Maximum paper capacity: 5,260 sheets (standard + HCF (A4 1Tray))</p> <p>Important • When using 80 g/m² paper</p>
<p>Continuous copy pages</p>	<p>9999 images</p> <p>Note • The machine may pause temporarily to perform image stabilization.</p>
<p>Output tray capacity</p>	<p>Output tray: approximately 500 sheets (A4)</p> <p>Offset Catch Tray (optional): approximately 500 sheets (A4)</p> <p>Note • When using 80 g/m² paper</p>
<p>Power source</p>	<p>220 - 240V AC</p>
<p>Power consumption</p>	<p>Maximum power consumption : 2.2 kVA</p> <p>Low Power Mode : 148 W</p> <p>Sleep mode : 7 W</p>
<p>Dimensions</p>	<p>Width 700 × Depth 817 × Height 1,154 mm</p> <p>Width 1,011 × Depth 781 × Height 1,370 mm (when the Full Size Color UI is installed on the left side)</p> <p>Width 1,195 × Depth 781 × Height 1,451 mm (when the Full Size Color UI is installed on the right side)</p>

Weight (excluding paper and options)	246 kg 255 kg (when the Full Size Color UI is installed on the left side) 258 kg (when the Full Size Color UI is installed on the right side) Important • The weight is with a new toner cartridge without any paper.
Minimum Space Requirements	Width 1,574 × Depth 817 mm (when the bypass tray is extended completely) Width 1,574 × Depth 781 mm (when the Full Size Color UI is installed on the left side, and the bypass tray is extended completely) Width 1,664 × Depth 781 mm (when the Full Size Color UI is installed on the right side, and the bypass tray is extended completely)

■ Print Feature Specifications

Type	Built-in
Continuous printing speed	Same as the main unit
Resolution	Output resolution : 2,400 x 2,400 dpi Data processing resolution: 600 x 600 dpi, 1,200 x 1,200 dpi
Page description language	Standard : PCL6, PCL5 Option : Adobe PostScript 3
Supported protocols	Ethernet : TCP/IP (SMB, LPD, Port9100, IPP), NetBEUI (SMB), IPX/SPX (NetWare), EtherTalk (optional), Bonjour (optional) Important • EtherTalk is supported by Mac OS 8.6 - 9.2.2, and Mac OS X 10.3.9 -10.4.9 • Bonjour is supported by Mac OS X 10.3.9 or later
Supported operating systems	PCL6 : Microsoft® Windows® 2000, Microsoft® Windows® XP, Microsoft® Windows Server® 2003, Microsoft® Windows Vista™ PostScript (optional) : Microsoft® Windows® 2000, Microsoft® Windows® XP, Microsoft® Windows Server® 2003, Microsoft® Windows Vista™, Mac OS 8.6 - Mac OS 9.2.2 English, Mac OS X 10.3.9 -10.4.9 English Note • For information about the latest supported OS's, contact our Customer Support Center.
Built-in fonts	PCL : European 82 type faces, symbol 35 sets PostScript (optional): European 136 type faces
Emulation	ESC/P-K(LQ1900K II), HP-GL (HP7586B), HP-GL2/RTL (HP Design Jet 750C Plus), PCL5/PCL6 (HP Color Laser Jet 5500), KSSM, KS5843, KS5895
Memory capacity	1 GB
Interface	Standard : Ethernet (100BASE-TX/10BASE-T), Option : USB 2.0* Important • USB 2.0 is supported by Windows 2000/XP/Vista, Windows Server 2003, Mac OS 8.6 - Mac OS 9.2.2, and Mac OS X 10.3.9 - 10.4.9.

■ Scan Feature Specifications

Type	Color scanner
Scan Size	The maximum size is 297×432 mm (A3, 11×17") for both sheets and books.
Scan Resolution	600 × 600 dpi, 400 × 400 dpi, 300 × 300 dpi, 200 × 200 dpi
Scan gradation	10-bit input / 8-bit output for each RGB color
Scanning speed	<p>Monochrome, 1 sided : 100 sheets/min. Color, 1 sided : 50 sheets/min. Monochrome, 2 sided : 200 pages/min*. (For ITU-T No.1 Chart A4□ 200 dpi, Scan to Mailbox)</p> <p>*: The scan speed may be reduced when Secure Watermark Kit is installed and Secure Watermark feature is enabled.</p> <p>Important • The scanning speed varies depending on documents.</p>
Interface	Ethernet 10BASE-T/100BASE-TX
Scan to Mailbox	<p>Supported protocols: TCP/IP (Salutation, HTTP) Output format*¹ :</p> <p>Monochrome binary : TIFF (Compression type: MH, MMR), PDF*², DocuWorks*² Gray scale/full color : TIFF, JPEG, PDF*², DocuWorks*²</p> <p>Driver : TWAIN (Salutation) Driver supported OS: Microsoft® Windows® 2000, Microsoft® Windows® XP, Microsoft® Windows Server® 2003, Microsoft® Windows Vista™</p> <p>*1 When the driver is used, the output format depends on the application for the driver. *2 Supported only when documents are received using CentreWare Internet Services.</p> <p>Note • For information about the latest supported OS's, contact our Customer Support Center.</p>
Scan to PC	<p>Supported protocol : TCP/IP(SMB, FTP) Supported OS :</p> <p>SMB: Microsoft® Windows® 2000, Microsoft® Windows® XP, Microsoft® Windows Server® 2003, Microsoft® Windows Vista™, Mac OS X 10.3.9/10.4.x</p> <p>FTP: Microsoft® Windows® 2000, Microsoft® Windows® XP, Microsoft® Windows Server® 2003, Microsoft® Windows Vista™, Mac OS X 10.3.9/10.4.2/10.4.4 English, NetWare® 5.11/5.12</p> <p>For information about the latest supported OS's, contact our Customer Support Center.</p> <p>Output format :</p> <p>Monochrome binary : TIFF (Compression type: MH, MMR), PDF, DocuWorks Gray scale/full color : TIFF (Compression type: JPEG), JPEG, PDF, DocuWorks, high-compressed DocuWorks*¹, high-compressed PDF*¹</p> <p>*1 High Compression Image Kit is needed.</p>

Send as E-mail	Supported protocols: TCP/IP (SMTP) Output format : Monochrome binary : TIFF (Compression type: MH, MMR), PDF, DocuWorks Gray scale/full color : TIFF (Compression type: JPEG), JPEG, PDF, DocuWorks, high-compressed DocuWorks* ¹ , high-compressed PDF* ¹ *1 High Compression Image Kit is needed.
----------------	---

■ Document Feeder Specifications

Document feeder type	Duplex automatic document feeder
Document size/type	Maximum: 297mm×432mm (A3, 11×17") Minimum : 139.7×210mm (A5) 38 - 200 g/m ² (2 sided : 50 - 128 g/m ²)
Number of originals held	250 sheets Important • When using 80 g/m ² paper
Scanning speed	<ApeosPort-II C7500/C6500, DocuCentre-II C7500/C6500> Monochrome: 80 sheets/minute A4☐ 1-sided) : 80 sheets/minute A4☐ 2-sided) Color : 50 sheets/minute (A4☐ 1-sided) : 33 sheets/minute A4☐ 2-sided) <ApeosPort-II C5400, DocuCentre-II C5400> Monochrome: 80 sheets/minute A4☐ 1-sided) : 80 sheets/minute A4☐ 2-sided) Color : 40 sheets/minute (A4☐ 1-sided) : 33 sheets/minute A4☐ 2-sided)

■ C-Finisher Specifications

Tray type	Output tray × 1 : Collate (offset stacking available)/ Stack (offset stacking available) Finisher tray × 1: Collate (offset stacking available)/ Stack (offset stacking available)
Paper size/Supported paper	Output tray Maximum: 13×19", Minimum: postcards, 64 - 280 g/m ² Finisher tray Maximum: 12×18", Minimum: B5☐, 64 - 176 g/m ²
Tray capacity	Output tray : 500 sheets Finisher tray (not stapled) paper (width: 216 mm or less) :3,000 sheets paper (width: more than 216 mm):1,500 sheets Mixed stack* :300 sheets Finisher tray (stapled) paper (width: 216 mm or less) :200 sets or 3,000 sheets paper (width: more than 216 mm):100 sets or 1,500 sheets Mixed stack* :70 sets or 200 sheets * Larger size paper is stacked on top of smaller size paper. Important • When using 80 g/m ² paper

Staple	<p>Maximum stapled sheets: 50 sheets (90g/m² or less)</p> <p>Paper size : Maximum: A3, 11 x 17", Minimum: B5□</p> <p>Stapling position : 1 place (front/back, angled stapling), 2 places (parallel stapling)</p> <p>Important • When using 80 g/m² paper</p>
Punching	<p>Size suitable for punching : A3, 11 × 17", A4, A4□, 8.5 × 11", 8.5 × 11"□, B4, B5□</p> <p>Number of punching holes: 2 or 4, 3 (optional)</p> <p>Paper Type : 64 - 176 g/m²</p> <p>Important • When using 80 g/m² paper</p>
Dimensions/Weight	Width 772 × Depth 650 × Height 1,010 mm, 55 kg
Space requirements (when connected to the main unit)	<p>Width 2,038 × Depth 817 mm (main unit + C-Finisher, when the bypass tray is extended completely)</p> <p>Width 2,038 × Depth 781 mm (main unit + C-Finisher, when the Full Size Color UI is installed, and the bypass tray is extended completely)</p>

■C-Finisher with Booklet Maker Specifications

Tray type	<p>Output tray × 1 : Collate (offset stacking available)/ Stack (offset stacking available)</p> <p>Finisher tray × 1: Collate (offset stacking available)/ Stack (offset stacking available)</p> <p>Booklet tray × 1</p>
Paper size/Supported paper	<p>Output tray Maximum: 13 × 19", Minimum: postcards, 64 - 280 g/m²</p> <p>Finisher tray Maximum: 13 × 19", Minimum: B5□, 64 - 176 g/m²</p> <p>Booklet tray Maximum: 13 × 18", Minimum: 8.5 × 11", 64 - 90 g/m²</p>
Tray capacity	<p>Output tray : 500 sheets</p> <p>Finisher tray (not stapled)</p> <p>paper (width: 216 mm or less) : 3,000 sheets</p> <p>paper (width: more than 216 mm): 1,500 sheets</p> <p>Mixed stack* : 300 sheets</p> <p>Finisher tray (stapled)</p> <p>paper (width: 216 mm or less) : 200 sets or 1,500 sheets</p> <p>paper (width: more than 216 mm): 100 sets or 1,500 sheets</p> <p>Mixed stack* : 70 sets or 200 sheets</p> <p>Booklet tray : 15 sheets x 20 sets</p> <p>* Larger size paper is stacked on top of smaller size paper.</p> <p>Important • When using 80 g/m² paper</p>
Staple	<p>Maximum stapled sheets: 50 sheets (90 g/m² or less)</p> <p>Paper size : Maximum: A3, 11 × 17", Minimum: B5□</p> <p>Stapling position : 1 place (front/back, angled stapling), 2 places (parallel stapling)</p>
Punching	<p>Size suitable for punching : Maximum: 11×17", Minimum: B5</p> <p>Number of punching holes: 2 or 4, 3 (optional)</p> <p>Paper Type : 64 - 176 g/m²</p>

Center binding/folding	Maximum number of sheets: center binding: 15 sheets (90 g/m ² or less) center folding : 5 sheets Paper size:Maximum: 13 × 18", Minimum: A4 Paper type: center binding: 64 - 90 g /m ² center folding : 64 - 105 g /m ²
Dimensions/Weight	Width 921 × Depth 650 × Height 1,010 mm, 86 kg
Space requirements (when connected to the main unit)	Width 2,096 × Depth 817 mm (main unit + C-Finisher with Booklet Maker, when the bypass tray is extended completely) Width 2,096 × Depth 781 mm (main unit + C-Finisher with Booklet Maker, when the Full Size Color UI is installed, and the bypass tray is extended completely)

■Booklet Finisher D2 Specifications

Tray type	Top tray × 1 : Collate / Stack Finisher tray × 1: Collate (offset stacking available)/ Stack (offset stacking available) Booklet tray × 1
Paper size/Supported paper	Top tray Maximum: 13 × 19", Minimum: A6 (postcards), 64 - 280 g/m ² Finisher tray Maximum: 13 × 19", Minimum: B5□ , 64 - 280 g/m ² Booklet tray Maximum: 13 × 18", Minimum: A4, 8.5 × 11", 64 - 90 g/m ² Important • A paper for cover is available 220 g/m ² or less. • Paper for contents is available 60 -80 g/m ² , when a paper 91 - 220 g/m ² is used for a cover attached.
Tray capacity	Output tray : 500 sheets Finisher tray (not stapled) paper (width: 216 mm or less) : 2,000 sheets paper (width: more than 216 mm): 1,500 sheets Mixed stack* ¹ : 300 sheets Finisher tray (stapled) paper (width: 216 mm or less) : 200 sets or 2,000 sheets paper (width: more than 216 mm): 100 sets or 1,500 sheets Booklet tray : 20 sets* ² * ¹ Larger size paper is stacked on top of smaller size paper. * ² Some papers may not be placed into tray depending on the paper type. Important • When using 80 g/m ² paper
Staple	Maximum stapled sheets: 100 sheets (when using 80 g/m ² paper) Important • When using paper over A4, or 8.5 × 11", maximum stapled sheets is 65 sheets. • Depending on the type of paper that is being stapled, the stapled nails may be bent. Paper size : Maximum: A3, 11 × 17", Minimum: B5□ Stapling position : 1 place (front : angled stapling, center : parallel stapling, back : parallel stapling*) : 2 places (parallel stapling) * angled stapling for A3 and A4

Punching	Size suitable for punching : Maximum: A3, 11×17" : Minimum: B5□ (2 holes), A4□ (4 holes) Number of punching holes: 2 or 4, 3 (optional) Paper type : 64 - 200 g/m ²
Center binding/folding	Maximum number of sheets: center binding: 15 sheets center folding : 5 sheets Important • When using 80 g/m ² paper • When a cover is attached, maximum number of sheets is 14 sheets. • Maximum staple-enabled number of paper can be changed because of customer engineer setting. Paper size: Maximum: 13 × 18", Minimum: A4, 8.5 × 11" Paper type: center binding: 64 - 90 g/m ² center folding : 64 - 105 g/m ² Important • A paper for cover is available 220 g/m ² or less. • Paper for contents is available 64 -80 g/m ² , when a paper 91 - 220 g/m ² is used for a cover attached.
Folding (when D2 Folder Unit is installed)	<Z-Fold> Paper size : A3, B4, 11 × 17" Paper type : 64 - 90 g/m ² <Tri-Fold> Paper size : A4, 8.5 × 11" Paper type : 64 - 90 g/m ²
Interposer	Paper size : Maximum: A3, 11 × 17", Minimum: B5□ Important • You cannot copy on the paper loaded in interposer. Capacity : 200 sheets Important • When using 80 g/m ² paper Paper type : 64 - 220 g/m ²
Power source/Maximum Power consumption	220 - 240V AC / 203 W
Dimensions/Weight	Width 1,050 × Depth 725 × Height 1,165 mm, 130 kg When D2 Folder Unit is installed : Width 1,250 × Depth 725 × Height 1,165 mm, 170 kg Note • This weight includes staple cartridge.
Space requirements (when connected to the main unit)	Width 2,425 × Depth 817 mm (main unit + Booklet Finisher D2 (when D2 Folder Unit is installed), when the bypass tray is extended completely) Width 2,425 × Depth 781 mm (main unit + Booklet Finisher D2 (when D2 Folder Unit is installed), when the Full Size Color UI is installed, and the bypass tray is extended completely)

■HCF (A4 1 Tray) Specifications

Paper size/Paper type	Maximum: A4□, 8.5 × 11"□, Minimum: B5□ 64 - 176 g/m ²
Paper feed method/ Capacity	2,000 sheets x 1 tray Important • When using 80 g/m ² paper
Dimensions/Weight	Width 389 × Depth 610 × Height 377 mm, 29 kg

Space requirements (when connected to the main unit)	Width 1,574 × Depth 817 mm (when the bypass tray is extended completely) Width 1,574 × Depth 781 mm (when the Full Size Color UI is installed on the left side, and the bypass tray is extended completely) Width 1,664 × Depth 781 mm (when the Full Size Color UI is installed on the right side, and the bypass tray is extended completely)
--	--

Printable Area

The area on paper that can be printed is as follows.

Standard Printable Area

The standard printable area is an area on paper excluding the 4 mm margins on all four edges of paper. For 13 x 18" (320 mm width), the printable area is an area on paper excluding the 3.5 mm left and right margins. The actual printable area, however, may vary depending on the printer (plotter) control language.

Extended Printable Area

With the extended printable area setting, for printing, both the printable area and the print assured area can be extended to 323 x 480 mm at a maximum. For copying, both the printable area and the print assured area can be extended to 317 x 432 mm at a maximum.

The un-printable area, however, may vary depending on the size of paper.

Note • To extend the print area, change the PCL print driver setting, or the [Print Area] setting on the touch screen.

For the setting method on the print driver, refer to the online help provided for the print driver. For more about the setting on the control panel, refer to "Print Area" (P.171)..

	■When the paper width is 12.6 inches (320 mm width)	■When the paper width is 330mm (320 mm width)
Printing		
Copying		

Internal Fonts

The following fonts are available as standard.

Refer to the manual in the PostScript Driver Library CD-ROM for the PostScript fonts.

Stroke fonts (for PCL5 and HP-GL/2)		• European Stroke fonts	
Outline fonts	Euro- pean	ESC/P-K	Roman Sans Serif
		PDF	Arial Arial Italic Arial Bold Arial Bold Italic Courier Courier Italic Courier Bold Courier Bold Italic Symbol Times New Roman Times New Roman Bold Italic ITC Zapf Dingbats GoldSEMM Gold SAMM
		PCL	CG Times CG Times Italic CG Times Bold CG Times Bold Italic Univers Medium Univers Medium Italic Univers Bold Univers Bold Italic Univers Medium Condensed Univers Medium Condensed Italic Univers Bold Condensed Univers Bold Condensed Italic Antique Olive Antique Olive Italic Antique Olive Bold CG Omega CG Omega Italic CG Omega Bold CG Omega Bold Italic Garamond Antiqua Garamond Kursiv Garamond Halbfett Garamond Kursiv Halbfett (Default): Courier Courier Italic Courier Bold Courier Bold Italic Letter Gothic Letter Gothic Italic Letter Gothic Bold Albertus Medium Albertus Extra Bold Clarendon Condensed Coronet Marigold Arial Arial Italic Arial Bold Arial Bold Italic Times New Times New Italic Times New Bold Times New Bold Italic Symbol Wingdings Line Printer Times Roman Times Italic Times Bold Times Bold Italic Helvetica Helvetica Oblique Helvetica Bold Helvetica Bold Oblique CourierPS CourierPS Oblique CourierPS Bold CourierPS Bold Oblique SymbolPS Palatino Roman Palatino Italic Palatino Bold Palatino Bold Italic ITC Bookman Light ITC Bookman Light Italic ITC Bookman Demi ITC Bookman Demi Italic Helvetica Narrow Helvetica Narrow Oblique Helvetica Narrow Bold Helvetica Narrow Bold Oblique New Century Schoolbook Roman New Century Schoolbook Italic New Century Schoolbook Bold New Century Schoolbook Bold Italic ITC Avant Garde Book ITC Avant Garde Book Oblique ITC Avant Garde Demi ITC Avant Garde Demi Oblique ITC Zapf Chancery Medium Italic ITC Zapf Dingbats OCR-B

Japanese	PCL	Heisei Mincho W3	Heisei Gothic W5
KO	PCL5	Muyngio Gothic R- Gothic	Graphic Kungso Saemmul
	KS	Muyngio Gothic R- Gothic Graphic Kungso Saemmul	T-Myungio T-Gothic TR-Gothic T-Graphic T-Kungso T-Saemmul
TC	PCL5	ShuSong	
SC	PCL5 ESC/P-K	ShuSong	

Optional Components

The following are the principal options available. To purchase these options, contact our Customer Support Center.

Product Name	Description
Offset Catch Tray	This unit allows to eject paper with an offset.
C-Finisher	Staples or hole-punches output.
C-Finisher with Booklet Maker	Staples or hole-punches output. It also folds output in half or staples folded output.
US 2/3 Hole Punch Kit for C-Finisher	The number of punching holes can be changed to 3.
Booklet Finisher D2	Staples or hole-punches output. It also folds output in half or staples folded output. Interposer is installed for loading paper to be used as separators and covers.
D2 Folder Unit	This unit allows to fold in z-folded or tri-folded output.
US 2/3 Hole Punch Kit for D2-Finisher)	The number of punching holes can be changed to 3.
HCF (A4 1 Tray)	Allows you to load 2,000 sheets of papers (when using 80 g/m ² paper) into this tray.
Full Size Color UI	A control panel with full size color touch screen.
Full Size Color UI Installation Kit Left	A kit to set the Full Size Color UI on the left side of the machine.
Full Size Color UI Installation Kit Right	A kit to set the Full Size Color UI on the right side of the machine.
Address Book Extension Kit	Increases the number of addresses that can be registered to the address book to 999.
Scanner Kit* ¹	Adds the scan feature to the machine.
Server Fax Kit	Adds the Server Fax feature to the machine.
USB 2.0 Kit	Allows you to use USB 2.0 on the machine.
Adobe PostScript 3 Kit	Allows you to use the machine as a PostScript printer. Also enables printing from Macintosh.
External Access Kit* ²	Allows you to link to a remote application through the control panel.
High Compression Image Kit	Allows you to create high-compressed DocuWorks or PDF files for the [E-mail] or [Scan to Mailbox] feature.
Image Expansion Kit	Required when the Image Log Control feature is used.
Copy Management Expansion Kit	Prints dates or serial numbers on all the pages of confidential documents to restrict duplication.
Network Accounting Kit	Allows you to keep track of user accounts via an external authentication server.
Data Security Kit	Enhances the security of data written to the hard disk.
Image Log Kit* ²	Allows you to attach job logs, which include information on a user, time, and the number of sets output, to the copies/prints that have been output on the machine.

Product Name	Description
Preview Image Kit ^{*2}	Allows you to preview images stored in the Mailbox. You can rotate and enlarge the previewed images as necessary.
Secure Watermark Kit	Allows you to manage security by embedding information in documents to restrict duplication.

*1: DocuCentre series models only

*2: ApeosPort series models only

- Note**
- The optional components are subject to change without notice.
 - For the latest information, contact our Customer Support Center.

ESC/P-K Emulation

This section explains how to use ESC/P-K emulation.

Emulation

The following describes the printer language emulations available on this machine.

Print data follows certain rules (grammars). These rules (grammars) are called printer languages.

This machine supports two types of printer languages: a page description language, which is used to create images on a page-by-page basis, and an emulation, which is used to obtain the print results similar to that of other printers. To "emulate" means to imitate the print results of other printers.

Emulation Mode

When printing data written in a language other than the page description language supported by this machine, switch this machine to the emulation mode. The relationships between the emulation mode and the printer to be emulated are as follows.

Emulation Mode	Printer to be Emulated
ESC/P-K emulation mode (ESC/P-K mode)	LQ1900K II

Host Interfaces and Emulation

Different host interfaces support different printer languages. The host interfaces that support printer languages are as follows.

- USB port
- NetWare port
- lpd port
- SMB port
- IPP port
- Port 9100 port

Switching between Printer Languages

The machine provides a multi-emulation feature that allows to switch between different printer languages.

There are three methods of switching between printer languages.

■ Switching by Commands

Commands for switching between printer languages are provided. Upon receipt of a command, the machine switches to the relevant printer language.

■ Automatic Switching

The machine analyzes the data received by a host interface, and automatically identifies the printer language to be used. It then switches to the identified printer language.

■ Interface-dependent

You can set a printer language for each host interface using the control panel. The machine switches to a printer language corresponding to the host interface that received data.

Fonts

This section explains the fonts used for emulation.

Available fonts

Available fonts are the followings:

- Roman
- Sans serif

User-defined Characters

On this machine, you can use user-defined characters. User-defined characters can be stored only in memory. Therefore, they are erased when the machine is switched off. When the HDD Extension Kit (optional) is added to the machine, user-defined characters can be stored on the hard disk, and are not erased even when the machine is switched off. The volume of user-defined characters that can be stored on the hard disk drive is the same as the volume when stored in memory.

The total capacity of memory for storing user-defined characters and other user-defined data can be set on the control panel. This value is retained after the machine is switched off.

User-defined characters are registered as bitmap fonts, and cannot be shared among different printer languages.

Font Caching

To ensure hi-speed printing, outline fonts of up to a certain size are cached. Outline fonts are converted into bit map data temporarily and then printed. To minimize this processing time, the processed bit map data is saved in the memory. This process is called font caching.

The saved bit map data is deleted upon power-off or system reset.

Output Feature

This section describes the machine's output feature.

Outputting a Pending Print Job

The jobs received by the printer can be prioritized over other jobs.

For information on how to give priority to the jobs received by the printer, refer to "Printing Pending Jobs" (P.84).

ESC/P-K Emulation Print Features

Multiple-Up

The multiple-up feature reduces the size of multiple-sheet documents and prints them on a single sheet of paper.

The multiple-up feature can be used in the ESC/P-K emulation mode. In the ESC/P-K mode, 2 Up can be used.

Form Overlay

In the ESC/P-K mode, you can register an original form to the printer, and overprint it on a printed output.

A form to be overprinted can be specified on the control panel.

Barcodes

In the ESC/P-K mode, you can use barcodes. The barcodes that can be used are as follows.

- JAN code
- CODE39
- CODABAR
- Industrial 2 of 5
- Interleaved 2 of 5

Forms

You can use ESC/P-K to register forms on the machine. Up to 64 forms can be registered.

ESC/P-K Emulation Settings

The following tables show the basic and extended settings that can be configured on the ESC/P-K emulation mode menu.

Basic Settings

Setting Item	Item Number	Value
Output color	5	Sets the color mode. [0] (Default) : Color [1] : Monochrome
Paper tray	3	Sets the paper tray to be used for printing. [0] : Auto [1] (Default) : Tray 1 [2] : Tray 2 [3] : Tray 3 [4] : Tray 4 [5] : Tray 5 (Bypass) [6] : Tray 6 (HCF) If printing from Tray 5 (Bypass), instruct printing and then operate the machine to start printing. To cancel the setting, change the setting for "Tray 5 Confirmation". Important • When Tray 1 to 4, or Tray 6 is selected, the size of paper loaded in the tray becomes the output paper size, and thus [Paper Size] cannot be set. Note • When [Auto] is selected, and if the paper of the same size is loaded in the same orientation in multiple trays, paper will be supplied in the order of Tray 1 → Tray 2 → Tray 3→ Tray 4→ Tray 6. If paper of the same size is loaded in multiple trays but in different orientations, the paper loaded in the landscape orientation is given priority.

Setting Item	Item Number	Value
Document size	1	<p>Sets the client-created document size.</p> <p>[99] (Default) : Paper [100] : Continuous form paper (10 x 12) [101] : Continuous form paper (10 x 11) [102] : Continuous form paper (15 x 12) [103] : Continuous form paper (15 x 11) [3] : A3 [4] : A4 [5] : A5 [14] : B4 [15] : B5 [21] : 8.5 x 14 [22] : 8.5 x 13 [23] : 8.5 x 11 [24] : 11 x 17 [0] : Postcard</p> <p>The number of characters printed is: 80 characters/72 rows for continuous form paper (10 x 12), 80 characters/66 rows for continuous form paper (10 x 11), 136 characters/72 rows for continuous form paper (15 x 12), and 136 characters/66 rows for continuous form paper (15 x 11).</p> <p>Note</p> <ul style="list-style-type: none"> • When a continuous form paper is selected for [Original Size], [Paper Position] cannot be set. • When [Preset%] or [Fit to Cut Sheet] is selected for [Reduce/Enlarge], the machine automatically calculates the magnification based on [Original Size] and [Paper Size]. If the magnification, however, is not within 45-210%, the original will not be reduced/enlarged, and will be printed in a scale of 100%. When [2 Up] is selected, the machine automatically calculates the magnification based on [Original Size] and 1/2 of [Paper Size]. • The orientation set here is that of the original. It is not affected by the orientation of paper loaded in the paper trays.
Orientation	19	<p>Sets the orientation of paper.</p> <p>[0] (Default) : Portrait [1] : Landscape</p>
Paper size	2	<p>Sets the size of paper to be printed. This setting can be made only when [Paper Tray] is set to [Auto] or [Tray 5 (Bypass)]. This setting can be made only for cut sheets.</p> <p>[3] : A3 [4] : A4 [5] : A5 [14] : B4 [15] : B5 [21] : 8.5 x 14 [22] : 8.5 x 13 [23] : 8.5 x 11 [24] : 11 x 17 [0] : Postcard</p> <p>Important • If [Paper Tray] is set to Tray 1, 2, 3, 4, or 6 [Paper Size] cannot be set.</p> <p>Note</p> <ul style="list-style-type: none"> • If [Preset%] or [Fit to Cut Sheet] is selected for [Reduce/Enlarge], the machine automatically calculates the magnification based on [Original Size] and [Paper Size]. If the magnification, however, is not within 45-210%, the original will not be reduced/enlarged, and will be printed in a scale of 100%. When [2 Up] is selected, the machine automatically calculates the magnification based on [Original Size] and 1/2 of [Paper Size].

Extended Settings

Setting Item	Item Number	Value
Paper position	20	<p>Sets the paper position.</p> <p>[0] (Default) : Without cut sheet feeder (left) [1] : With cut sheet feeder (center)</p> <p>Note • When a continuous form paper is selected for [Original Size], [Paper Position] cannot be set.</p>
Output quantity	8	<p>Sets the number of copies to be printed.</p> <p>[1 to 250] (Default: 1): 1-250 copies</p> <p>Important • When the output quantity is specified by a client, the copies of that set of number will be printed. After printing, the number set on the control panel will be changed to that number. However, the number of copies specified from NetWare or lpd port will not change the number set on the control panel.</p>
Reduce/enlarge	54 (Reduce/enlarge mode)	<p>Sets the print magnification.</p> <p>[0] (Default) : Preset % [1] : Variable % [2] : Fit to Cut Sheet</p> <p>[Preset %] is a magnification calculated automatically based on [Original Size] and [Paper Size], and reduces/enlarges the printable area of the original to fit to the printable area of the output paper. Therefore, if the size of the original and that of the output paper are the same, the magnification will be 100%. Also, if [2 Up] is selected, the original will be reduced to the size where two pages fit into one sheet of paper.</p> <p>[Variable %] is a magnification set in [Variable %] under [Reduce/Enlarge]. A reference point for scaling (reducing/enlarging) is the upper left corner of the printable area. This reference point applies to all text, images, and graphics.</p> <p>[Fit to Cut Sheet] prints the entire cut sheet area to the printable area of the output paper. It is a magnification calculated automatically based on [Original Size] and [Paper Size], and reduces/enlarges the whole original (including the area outside of the printable area) to fit to the printable area of the output paper.</p>
	17 (Variable %/ vertical magnification)	<p>Sets the magnification for the vertical or horizontal direction.</p> <p>[45 to 210] (Default:100):45-210%</p> <p>Note • When a continuous form paper is selected for [Original Size], both [Preset %] and [Fit to Cut Sheet] produce the same print result.</p>
	18 (Variable %/ horizontal magnification)	
2 Up mode	21	<p>Sets whether to print in 2 Up or page by page. 2 Up is a feature that prints two pages onto one sheet of paper. Depending on the paper orientation, the two pages are printed side by side, or one above the other.</p> <p>[0] (Default) : Off [1] : Reverse [2] : Forward</p> <p>Important • When [Landscape] is selected for [Original Size], [Forward] or [Reverse] produce the same print result.</p>
Output destination	9	<p>Sets the output tray where the output will be delivered.</p> <p>[0] (Default) : Center Tray [80] : Finisher Tray (optional)</p>

Setting Item	Item Number	Value
Tray 5 confirmation	67	Prints from Tray 5 (Bypass), after instructing to print and then operating the machine to start printing. [0] (Default) : Off [1] : On
Grid lines	22	Sets the method for printing 2-byte grid lines. The options are as follows. [0] (Default) : Image [1] : Font
2 Sided printing	12	Sets the 2-sided printing. [0] (Default) : Off [1] : Head to Head [2] : Head to Toe Important • When [Postcard] is selected for [Paper Size], [Head to Head] and [Head to Toe] cannot be selected. Note • This feature does not appear for some models. An optional package is necessary. For more information, contact our Customer Support Center.
Font	14 (alphanumeric font)	Sets the font for 1-byte characters (ANK). [0] (Default) : Roman [1] : Sanserif Important • Since this feature selects the default value, its setting will not be affected when an extended command is received.
Print control	51 (Blank sheet output)	Sets whether to print blank pages if included in the original. [0] (Default) : Off [1] : On Note • Even when [Off] is selected, blank pages will be printed if they are spaces created with user-defined characters or images in white color. • If [Off] is selected, and if 2 Up or 2-sided printing is specified, blank pages will not be printed.
	52 (Character print area)	Extends the position of the right margin. [0] (Default) : Standard [1] : Extended Important • If the character print area is changed from [Extended] to [Standard], the left and right margins will be initialized to the default values. • When the position of the right margin is set here, that position will be the right edge of the character print area.
	53 (Image enhancement)	Sets whether or not to enable the Image Enhancement feature. Image Enhancement makes border between black and white smooth, with rough edges reduced, giving the appearance of higher resolution. [0] : Off [1] (Default) : On

Setting Item	Item Number	Value
ESCP switch	55 (Text quality)	Sets the Text Quality mode to high quality or draft. [0] (Default) : High Quality [1] : Draft Important • Since the [Text Quality], [Reduced Characters], [Character Code Table], [Page Length], and [1-inch Perforation Skip] features select the default values, their settings will not be affected when the an extended command is received. Note • When the setting is changed, only the state of the setting changes, not the actual printing quality. • This setting affect the Text Quality selection commands.
	56 (Reduced characters)	Reduces the size of 1-byte alphanumeric characters when printing. Sets whether to reduce their sizes or to print them in a scale of 100%. [0] (Default) : Off [1] : On
	58 (1 Page length)	Sets the length of a page (printable area) to 11 inches or 12 inches. [0] (Default) : 11 inches [1] : 12 inches
	59 (1-Inch perforation skip)	Sets whether or not to leave a 1-inch space between pages. [0] (Default) : Off [1] : On Important • This is only effective when CSF under [Paper Position] is set to [Off].
	60 (Paper feed position)	Sets the position to start printing to 8.5 mm or 22 mm below the top edge of paper. [0] (Default) : 8.5 mm [1] : 22 mm
	61 (CR feature)	Sets the action to be performed when a CR command is received. [0] (Default) : Carriage return [1] : Carriage return and linefeed
Position adjustment	15 (Vertical position adjustment)	Adjusts the printing position vertically or horizontally, and changes the positions of the margins. [0] (Default) : Off [1-500] : -250 to +250 mm
	16 (Horizontal position adjustment)	Important • Data outside the printable area will not be printed even when the printing position is adjusted. In addition, data moved outside the printable area due to the adjustment of the printing position will not be printed.
Escape sequence	62 (Escape sequence)	Important • This feature is not available on the machine. Note • The syntax of an extended command starts with an escape sequence, then the data identifying the command, and followed by parameters if any. The escape sequence is the first two bytes of an extended command (an ESC, which is a hexadecimal 1BH, plus the semicolon (3BH) followed by it). This setting specifies whether or not to enable the escape sequence you specified. When enabled, an extended command can be controlled using a text code. The default setting is "Disabled". [0] (Default) : Disabled [1] : Enabled
	63 (Escape sequence character)	To control an extended command with a text code, an escape sequence (the first two bytes) of the extended command must be specified. Enter two characters using the keyboard displayed on the screen. (Default: &%)

Setting Item	Item Number	Value
Form overlay	64	<p>Important • This feature is not available on the machine.</p> <p>Constantly performs Form Overlay by selecting a form name (No. 01-64) registered on the machine.</p> <p>[0] (Default) : Off [1-64] : No. 1 - No. 64</p> <p>Important • Since this setting selects the default value, it is not affected when an extended command is received.</p> <ul style="list-style-type: none"> • Once a form name is selected, it will remain displayed even if the form is deleted. When a form name is selected using the up and down arrow keys, it will not be displayed. In this case, the setting is set to "Off".
Stapling	66	<p>Sets the stapling position.</p> <p>[0] (Default) : Off [1] : Top left [2] : Top Double [3] : Top Right [4] : Left Double [5] : Right Double [6] : Bottom Left [7] : Bottom Double [8] : Bottom Right</p>
Bypass Tray - Wait User	67	<p>Sets whether to suspend the print processing when feeding paper from Bypass Tray. The processing is resumed by a user operation on the machine.</p>
Number of holes	70	<p>Select the number of punch holes.</p> <p>[0] (Default) : 2 holes [1] : 3 holes [2] : 4 holes</p>
Binary character strings	72	<p>Sets the specified character strings when entering commands in hexadecimal format.</p> <p>[0] (Default) : Off [1] : &\$\$%\$ [2] : \$?!#</p>
0 Style	73	<p>Sets the typeface for "0".</p> <p>[0] (Default) : 0 [1] : Ø</p>
Number of sets	74	<p>Sets which value to use as the number of print sets.</p> <p>[0] : Protocol [1] : Panel [2] (Default) : Command</p>

Magnification Table

Preset %

Document Size	Paper Size	A3	A4	A5	B4	B5	11 x 17	8.5 x 14	8.5 x 13	8.5 x 11	Postcard
A3	Long edge	100	70	49	86	60	103	84	78	66	100
	Short edge	100	70	48	86	60	94	72	72	72	100
A4	Long edge	143	100	70	123	86	147	120	112	94	48
	Short edge	143	100	69	123	86	135	103	103	103	45
A5	Long edge	204	143	100	177	123	210	172	160	135	69
	Short edge	207	145	100	178	124	195	149	149	149	65
B4	Long edge	116	81	57	100	70	119	98	90	76	100
	Short edge	116	81	56	100	70	109	83	83	83	100
B5	Long edge	164	116	81	143	100	171	140	130	109	56
	Short edge	164	116	81	143	100	156	120	120	120	53
11 x 17	Long edge	97	68	48	84	59	100	82	76	64	100
	Short edge	106	74	51	92	64	100	77	77	77	100
8.5 x 14	Long edge	119	83	58	102	72	122	100	93	78	100
	Short edge	139	97	67	120	84	131	100	100	100	100
8.5 x 13	Long edge	128	90	63	111	77	132	108	100	84	100
	Short edge	139	97	67	120	84	131	100	100	100	100
8.5 x 11	Long edge	152	106	74	131	92	156	128	119	100	100
	Short edge	139	97	67	120	84	131	100	100	100	100
Postcard	Long edge	100	100	145	100	178	100	100	100	100	100
	Short edge	100	100	153	100	190	100	100	100	100	100
15 x 1	Long edge	119	83	58	103	72	122	100	93	78	100
	Short edge	103	72	50	89	62	97	74	74	74	100
15 x 2	Long edge	119	83	58	103	72	122	100	93	78	100
	Short edge	95	66	46	81	57	89	68	68	68	100
10 x 11	Long edge	147	103	72	127	89	151	124	115	97	50
	Short edge	142	99	68	122	85	133	102	102	102	45
10 x 12	Long edge	135	95	66	117	81	139	114	105	89	46
	Short edge	142	99	68	122	85	133	102	102	102	45

Unit: %

- Note**
- If the magnification for either the long edge or short edge is not within the range of 45 - 210%, the magnifications for both the long edge and short edge will be 100%.

Preset % (2-Up Printing)

Document Size	Paper Size	A3/2	A4/2	A5/2	B4/2	B5/2	11 x 17 /2	8.5 x 14 /2	8.5 x 13 /2	8.5 x 11 /2	Postcard /2
A3	Long edge	70	49	100	60	100	66	50	50	50	100
	Short edge	70	48	100	60	100	72	59	54	45	100
A4	Long edge	100	70	48	86	60	94	72	72	72	100
	Short edge	100	69	48	86	59	103	84	78	65	100
A5	Long edge	143	100	69	123	86	135	103	103	103	45
	Short edge	145	100	69	124	86	149	121	112	94	47
B4	Long edge	81	57	100	70	49	76	58	58	58	100
	Short edge	81	56	100	70	48	83	68	63	53	100
B5	Long edge	116	81	56	100	70	109	83	83	83	100
	Short edge	116	80	55	100	69	120	98	90	76	100
11 x 17	Long edge	68	48	100	59	100	64	49	49	49	100
	Short edge	74	51	100	64	100	77	62	58	48	100
8.5 x 14	Long edge	83	58	100	72	50	78	60	60	60	100
	Short edge	97	67	100	84	57	100	82	75	63	100
8.5 x 13	Long edge	90	63	100	77	54	84	64	64	64	100
	Short edge	97	67	100	84	57	100	82	75	63	100
8.5 x 11	Long edge	106	74	51	92	64	100	77	77	77	100
	Short edge	97	67	46	84	57	100	82	75	63	100
Postcard	Long edge	100	145	100	178	124	100	149	149	149	65
	Short edge	100	153	105	190	131	100	185	172	144	71
15 x 11	Long edge	83	58	100	72	100	78	60	60	60	100
	Short edge	72	50	100	62	100	74	60	56	47	100
15 x 12	Long edge	83	58	100	72	100	78	60	60	100	100
	Short edge	66	46	100	57	100	68	55	51	100	100
10 x 11	Long edge	103	72	50	89	62	97	74	74	74	100
	Short edge	99	68	47	85	59	102	83	77	64	100
10 x 12	Long edge	95	66	46	81	57	89	68	68	68	100
	Short edge	99	68	47	85	59	102	83	77	64	100

Unit: %

- Note**
- If the magnification for either the long edge or short edge is not within the range of 45 - 210%, the magnifications for both the long edge and short edge will be 100%.

Fit to Cut Sheet

Document Size	Paper Size	A3	A4	A5	B4	B5	11 x 17	8.5 x 14	8.5 x 13	8.5 x 11	Postcard
A3	Long edge	98	69	48	85	59	101	83	77	64	100
	Short edge	97	68	47	84	58	91	70	70	70	100
A4	Long edge	138	97	68	120	84	142	117	108	91	100
	Short edge	137	96	66	118	82	129	99	99	99	100
A5	Long edge	196	137	96	169	118	201	165	153	129	66
	Short edge	195	136	94	168	117	183	140	140	140	62
B4	Long edge	113	79	55	98	68	116	95	88	74	100
	Short edge	112	78	54	97	67	105	81	81	81	100
B5	Long edge	160	112	78	138	97	165	135	125	105	54
	Short edge	158	110	76	136	95	149	114	114	114	50
11 x 17	Long edge	95	67	47	82	57	98	80	74	63	100
	Short edge	103	72	50	89	62	97	74	74	74	100
8.5 x 14	Long edge	116	81	57	100	70	119	98	90	76	100
	Short edge	133	93	64	115	80	125	96	96	96	100
8.5 x 13	Long edge	125	87	61	108	75	128	105	97	82	100
	Short edge	133	93	64	115	80	125	96	96	96	100
8.5 x 11	Long edge	147	103	72	127	89	151	124	115	97	100
	Short edge	133	93	64	115	80	125	96	96	96	100
Postcard	Long edge	100	195	136	100	168	100	100	100	183	94
	Short edge	100	201	139	100	173	100	100	100	207	91
15 x 11	Long edge	135	95	66	117	81	139	105	114	89	46
	Short edge	142	99	68	122	85	133	102	102	102	45
15 x 12	Long edge	135	95	66	117	81	139	105	114	89	46
	Short edge	142	99	68	122	85	133	102	102	102	45
10 x 11	Long edge	147	103	72	127	89	151	115	124	97	50
	Short edge	142	99	68	122	85	133	102	102	102	45
10 x 12	Long edge	147	103	72	127	89	151	124	115	97	50
	Short edge	142	99	68	122	85	133	102	102	102	45

Unit: %

- Note**
- If the magnification for either the long edge or short edge is not within the range of 45 - 210%, the magnifications for both the long edge and short edge will be 100%.

Fit to Cut Sheet (When 2 Up is specified)

Document Size	Paper Size	A3/2	A4/2	A5/2	B4/2	B5/2	11 x 17/ 2	8.5 x 14 /2	8.5 x 13 /2	8.5 x 11 /2	Postcard /2
A3	Long edge	69	48	100	59	100	64	49	49	100	100
	Short edge	68	47	100	58	100	70	57	53	100	100
A4	Long edge	97	68	47	84	58	91	70	70	70	100
	Short edge	96	66	46	82	57	99	80	74	62	100
A5	Long edge	137	96	66	118	82	129	99	99	99	100
	Short edge	136	84	65	117	80	140	114	106	88	100
B4	Long edge	79	55	100	68	48	74	57	57	57	100
	Short edge	78	54	100	67	46	81	66	61	51	100
B5	Long edge	112	78	54	97	67	105	81	81	81	100
	Short edge	110	76	53	95	65	114	93	86	72	100
11 x 17	Long edge	67	47	100	57	100	63	48	48	48	100
	Short edge	72	50	100	62	100	74	60	56	47	100
8.5 x 14	Long edge	81	47	100	70	49	76	58	58	58	100
	Short edge	93	50	100	80	55	96	78	72	61	100
8.5 x 13	Long edge	87	61	100	75	52	82	63	63	63	100
	Short edge	93	64	100	80	55	96	78	72	61	100
8.5 x 11	Long edge	103	89	100	89	72	97	74	74	74	100
	Short edge	93	80	100	80	55	96	78	72	61	100
Postcard	Long edge	195	136	94	168	117	183	140	140	140	62
	Short edge	201	139	96	173	119	207	169	156	131	65
15 x 11	Long edge	95	66	46	81	57	89	68	68	68	100
	Short edge	99	68	47	85	59	102	83	77	64	100
15 x 12	Long edge	95	66	46	81	57	89	68	68	68	100
	Short edge	99	68	47	85	59	102	83	77	64	100
10 x 11	Long edge	103	72	50	89	62	97	74	74	74	100
	Short edge	99	68	47	85	59	102	83	77	64	100
10 x 12	Long edge	103	72	50	89	62	97	74	74	74	100
	Short edge	99	68	47	85	59	102	83	77	64	100

Unit: %

- Note**
- If the magnification for either the long edge or short edge is not within the range of 45 - 210%, the magnifications for both the long edge and short edge will be 100%.

Paper Size and Number of Printable Characters

When the paper feed position is 22 mm

Paper Size	Portrait		Landscape	
	Characters	Lines	Characters	Lines
A3	113	92	161	63
B4	97	78	139	53
A4	79	63	113	42
B5	68	53	97	35
A5	54	42	79	27
Postcard	35	30	54	19
11 x 17	106	94	166	58
8.5 x 14	81	76	136	43
8.5 x 13	81	70	126	43
8.5 x 11	81	58	106	43

When the paper feed position is 8.5 mm

Paper Size	Portrait		Landscape	
	Characters	Lines	Characters	Lines
A3	113	95	161	66
B4	97	82	139	56
A4	79	66	113	45
B5	68	56	97	39
A5	54	45	79	31
Postcard	35	30	54	19
11 x 17	106	98	166	62
8.5 x 14	81	80	136	47
8.5 x 13	81	74	126	47
8.5 x 11	81	62	106	47

- Note**
- The values are based on 10-cpi character pitch and 6-lpi line pitch.
 - The magnifications for both the long edge and short edge are 100%.
 - Some paper sizes are not available for use depending on the hardware configuration.

Fit to Cut Sheet

Paper Size	Portrait		Landscape	
	Characters	Lines	Characters	Lines
A3	116	99	165	70
B4	101	85	143	60
A4	82	70	116	49
B5	71	60	101	42
A5	58	49	82	34
Postcard	39	34	58	23
11 x 17	110	102	170	66
8.5 x 14	85	84	140	51
8.5 x 13	85	78	130	51
8.5 x 11	85	66	110	51

- Note**
- The values are based on 10-cpi character pitch and 6-lpi line pitch.
 - Some paper sizes are not available for use depending on the hardware configuration.

15-inch Continuous Form Mode (When Aligned at Left in Portrait Orientation)

Paper Size	Portrait		Landscape	
	Characters	Lines	Characters	Lines
All supported paper sizes	136	66	136	72

- Note**
- The values are based on 10-cpi character pitch and 6-lpi line pitch.

10-inch Continuous Form Mode

Paper Size	Portrait		Landscape	
	Characters	Lines	Characters	Lines
All supported paper sizes	80	66	80	72

- Note**
- The values are based on 10-cpi character pitch and 6-lpi line pitch.

PDF Direct Print

PDF Direct Print is a feature that prints PDF files by directly using the lpr command instead of a print driver. When this feature is used, the following items will be printed based on the settings on the control panel.

- Output Quantity
- 2 Sided Printing
- Print Mode
- Collate
- Layout
- Paper Size
- Print Processing Mode
- Output Color

- Note**
- When using the lpr command to print, specify the number of copies to be printed in the lpr command. The copy quantity setting made on the control panel becomes invalid. If the copy quantity is not specified in the lpr command, only one copy is printed.
 - When printing a PDF file using the lpr command, the LPD protocol of the machine must be started using the control panel or CentreWare Internet Services.

PDF Direct Print Settings

This section explains the setting items for the PDF Direct Print feature.

The settings configured here are valid when printing PDF files without using "ContentsBridge" provided by Fuji Xerox.

- Note**
- For information on printing PDF files using ContentsBridge Utility, refer to the manual provided on the driver CD kit CD-ROM.

Setting Item	Item Number	Value
Output Quantity	401	Sets the number of copies to be printed. [1-999] (Default: 1): 1-999 sheets
2 Sided Printing	402	Sets the 2-sided printing option. [0] (Default) : 1 Sided [1] : 2 Sided (Flip on long edge) [2] : 2 Sided (Flip on short edge) [2 Sided (Flip on long edge)] prints 2 sided in the orientation so that pages can be bound along the long edge. [2 Sided (Flip on short edge)] prints 2 sided in the orientation so that pages can be bound along the short edge. Note <ul style="list-style-type: none"> • This feature does not appear for some models. An optional package is necessary. For more information, contact our Customer Support Center.
Print Mode	403	Sets whether to give priority to the print speed or the image quality. [0] (Default) : Standard [1] : High Speed [2] : Fine The [Standard] setting prints in a standard speed and quality. The [High Speed] setting gives priority to the print speed. The [Fine] quality setting prints in high quality but in a slower speed.
Collate	404	Sets whether to print multiple-sheet documents as collated sets (1, 2, 3...1, 2, 3...). [0] (Default) : Off [1] : On

Setting Item	Item Number	Value
Layout	405	<p>Sets the layout for printing.</p> <p>Note</p> <ul style="list-style-type: none"> This item can be set when [PDF Bridge] is selected for [Print Processing Mode]. <p>[0] (Default) : Auto % [1] : Booklet [2] : 2-up [3] : 4-up [4] : 100% (size-by-size)</p> <p>The [Auto %] setting automatically calculates the largest magnification possible to fit to the output paper size. It automatically selects A4 or letter size paper based on the size of the original PDF file.</p> <p>The [Booklet] setting prints the images side by side, on both sides of each page, in the correct order to make a booklet. Some documents may not be printed in a booklet fashion depending on the structure of their pages. In such case, they will be printed with the [Auto %] setting.</p> <p>Note</p> <ul style="list-style-type: none"> If the 2-sided feature is unsupported, documents are printed on one side of paper. When [A4] is selected for [Paper Size], documents will be printed on A4 size paper. When [Paper Size] is set to [Auto], documents will be printed on A3 or A4 size paper. <p>The 2-up setting prints two pages onto one sheet of paper. When 2 Up is selected, the paper size is fixed at A4.</p> <p>The 4-up setting prints four pages on each sheet of paper. When 4 Up is selected, the paper size is fixed at A4.</p>
Paper Size	406	<p>Set the size of the paper to be printed.</p> <p>[0] (Default) : Auto [1] : A4</p> <p>The [Auto] setting automatically determines the paper size, based on the size of a PDF file to be printed and the settings configured for it.</p>
Output Color	407	<p>Selects color printing or black and white printing.</p> <p>[0] (Default) : Auto [1] : Black and white</p> <p>The Auto setting automatically determines for each page of the original whether it is color or black and white. If colors other than black and white are used, then it is printed in color, and if black and white only are used, black and white printing is used.</p>
Print Processing Mode	408	<p>Sets the print processing mode when using the PDF Direct Print feature.</p> <p>[0] (Default) : PDF Bridge [1] : PS</p> <p>[PDF Bridge] processes PDF files using the PDF Direct Print feature provided by Fuji Xerox.</p> <p>[PS] processes PDF files using the PostScript feature provided by Adobe.</p> <p>Note</p> <ul style="list-style-type: none"> This item appears only when the optional Adobe PostScript 3 kit is installed. The print results may be different between the [PDF Bridge] and [PS] selections. When [PS] is selected, the [Layout] setting becomes invalid.

PCL Emulation

The following table shows the emulation parameters and their values for PCL emulation.

For information on how to change parameter values, refer to "Print Mode" (P.91)

Parameter	Item No.	Value
Paper Tray	201	0 (Default): Auto 1: Tray 1 2: Tray 2 3: Tray 3 4: Tray 4 5: Tray 5 (Bypass) 6: Tray 6 (HCF) Selects the paper tray. When [Auto] is selected, the machine automatically selects the tray that contains the paper whose size is specified on the [Paper Supply] screen.
Auto Size	202	3: A3 4 (Default*): A4 5: A5 14: B4 15: B5 21: 8.5 × 14" 22: 8.5 × 13" 23 (Default*): 8.5 × 11" 24: 11 × 17" 25: Custom Size 30: 8K Sets the default paper size when the machine is set to select the paper size automatically. Only available when [Paper Tray] is set to [Auto]. * The default value will be either [4] or [23] depending on the region of use.
Bypass Size	203	3: A3 4 (Default*): A4 5: A5 14: B4 15: B5 21: 8.5 × 14" 22: 8.5 × 13" 23 (Default*): 8.5 × 11" 24: 11 × 17" 25: Custom Size Sets the paper size for the bypass tray. Only available when [Paper Tray] is set to [Tray 5 (Bypass)]. * The default value will be either [4] or [23] depending on the region of use.
Orientation	205	0 (Default): Portrait 1: Landscape Sets the document orientation.

Parameter	Item No.	Value
2 Side Print	206	0 (Default): Off 1: On Sets whether to enable double-sided printing.
Default Font	207	0: CG Times 1: CG Times Italic 2: CG Times Bold 3: CG Times Bold Italic 4: Univers Medium 5: Univers Medium Italic 6: Univers Bold 7: Univers Bold Italic 8: Univers Medium Condensed 9: Univers Medium Condensed Italic 10: Univers Bold Condensed 11: Univers Bold Condensed Italic 12: Antique Olive 13: Antique Olive Italic 14: Antique Olive Bold 15: CG Omega 16: CG Omega Italic 17: CG Omega Bold 18: CG Omega Bold Italic 19: Garamond Antiqua 20: Garamond Kursiv 21: Garamond Halbfett 22: Garamond Kursiv Halbfett 23 (Default): Courier 24: Courier Italic 25: Courier Bold 26: Courier Bold Italic 27: Letter Gothic 28: Letter Gothic Italic 29: Letter Gothic Bold 30: Albertus Medium 31: Albertus Extra Bold 32: Clarendon Condensed 33: Coronet 34: Marigold 35: Arial 36: Arial Italic 37: Arial Bold 38: Arial Bold Italic 39: Times New 40: Times New Italic 41: Times New Bold 42: Times New Bold Italic 43: Symbol 44: Wingdings 45: Line Printer 46: Times Roman 47: Times Italic 48: Times Bold 49: Times Bold Italic 50: Helvetica 51: Helvetica Oblique 52: Helvetica Bold 53: Helvetica Bold Oblique 54: CourierPS 55: CourierPS Oblique 56: CourierPS Bold 57: CourierPS Bold Oblique 58: SymbolPS 59: Palatino Roman 60: Palatino Italic 61: Palatino Bold 62: Palatino Bold Italic 63: ITC Bookman Light 64: ITC Bookman Light Italic 65: ITC Bookman Demi 66: ITC Bookman Demi Italic 67: Helvetica Narrow 68: Helvetica Narrow Oblique 69: Helvetica Narrow Bold 70: Helvetica Narrow Bold Oblique 71: New Century Schoolbook Roman 72: New Century Schoolbook Italic 73: New Century Schoolbook Bold 74: New Century Schoolbook Bold Italic 75: ITC Avant Garde Book 76: ITC Avant Garde Book Oblique 77: ITC Avant Garde Demi 78: ITC Avant Garde Demi Oblique 79: ITC Zapf Chancery Medium Italic 80: ITC Zapf Dingbats

Parameter	Item No.	Value
Symbol Set	208	0 (Default): Roman 8 1: ISO 8859-1 Latin 1 2: ISO 8859-2 Latin 2 3: ISO 8859-9 Latin 5 4: ISO 8859-10 Latin 6 5: PC-8 6: PC-8 DN 7: PC-775 8: PC-850 9: PC-852 10: PC-1004 (OS/2) 11: PC Turkish 12: Windows 3.1 Latin 1 13: Windows 3.1 Latin 2 14: Windows 3.1 Latin 5 15: DeskTop 16: PS Text 17: MC Text 18: Microsoft Publishing 19: Math 8 20: PS Math 21: Pi Font 22: Legal 23: ISO 4 United Kingdom 24: ISO 6 ASCII 25: ISO 11 Swedish:names 26: ISO 15 Italian 27: ISO 17 Spanish 28: ISO 21 German 29: ISO 60 Norwegian v1 30: ISO 69 French 31: Windows 3.0 Latin 1 32: Windows Baltic 33: Symbol 34: Wingdings
Font Size	209	400 - 5000 (Default: 1200): Specifies the point size of a font in increments of 25. The value of 100 represents 1 point.
Font Pitch	210	600 - 2400 (Default: 1000): Specifies the pitch size of a font. The value of 100 represents the pitch size of 1.
Form Line	211	5 - 128 (Default: 64 or 60*): Specifies the number of lines on a page. * The default value will be [64] if the default value of the item 202/203 is [4]; [60] if the value for 202/203 is [23].
Print Sets	212	1 - 999 (Default: 1): Specifies the number of print sets.
Image Enhance	213	0: Off 1 (Default): On Sets whether to enable the enhanced image mode.
Hex Dump	214	0 (Default): Off 1: On Sets whether to enable hex dump.
Draft Mode	215	0 (Default): Off 1: On Sets whether to enable the draft mode.
Color Mode	216	0 (Default): Auto 1: Color 2: Monochrome Sets the color mode.
Binding	217	0 (Default): LEF 1: SEF Specifies which edge of paper is to be bound.
Line Termination	218	0 (Default): Off 1: Add-LF (Appends an LF to CR) 2: Add-CR (Appends a CR to LF and FF) 3: CR-XX (Appends a CR to LF and FF, and LF to CR)

Parameter	Item No.	Value
Default Custom Paper Size	219 (Short edge)	2100 (Default short-edge value): 210.0 mm 2970 (Default long-edge value): 297.0 mm 0 to 9999: 0 to 999.9 mm
	220 (Long edge)	Specifies the default custom paper size.

HP-GL2 Emulation

This section explains how to operate the HP-GL mode menu and the settings that can be made with it.

HP-GL Settings List

Items that can be set using the HP-GL mode menu are explained in two groups: basic settings and advanced settings.

■Basic Settings

Document Size	101	<p>99 (Default): Auto 100: Paper 0: A0 1: A1 2: A2 3: A3 4: A4 5: A5 10: B0 11: B1 12: B2 13: B3 14: B4 15: B5</p> <p>Sets the document size created by a PC client. When Auto (99) is specified, the document size is determined based on the Scaling Mode setting (the item number 160).</p>
Paper Size	102	<p>99: Auto 101 (Default): A Size 3: A3 4: A4 5: A5 14: B4 15: B5</p> <p>Sets the paper size to be printed. This can be set if the paper tray setting is either "Auto" or "Tray 5 (Manual Feed)". In addition, settings can only be made for cut paper. When Auto (99) is specified, the paper size is determined based on the Scaling Mode setting (the item number 160).</p>
Paper Tray	103	<p>0 (Default): Auto 1: Tray 1 2: Tray 2 3: Tray 3 4: Tray 4 5: Manual Feed 6: Tray 6 (HCF)</p> <p>Sets the paper tray to be used for printing.</p>
Coordinate Rotation	104	<p>0 (Default): 0 degrees 1: 90 degrees</p> <p>Sets the paper orientation for printing.</p>

Color Mode	105	1 (Default): Color 2: Grayscale 3: Monochrome Sets the color mode.
------------	-----	---

■Advanced Settings

Auto Layout	106	0 (Default): ON 1: OFF Selects whether aligning the position of the document and the paper is to be done automatically or not.
Active Palette	107	0 (Default): Command 1: Panel Selects whether to use a pen specified by command or set on the panel.
No. of Prints	108	1 - 250 (Default): 1): 1 - 250 Sets the number of prints to be made.
Output Tray	109	0 (Default): Center Output Tray 1: Side Output Tray 80: Finisher Tray Sets the output tray.
Two-Sided Printing	110	0 (Default): None 1: Head to head 2: Head to toe Sets the two-sided printing. [None]...Prints one side. [Head to Head]...Place the paper as in the [Paper Orientation], and it prints both sides so that the orientation of the up-sides are aligned for each page when the left side is closed. [Head to Toe]...Place the paper as in the [Paper Orientation], and it prints both sides so that the orientation of the up-sides are aligned for each page when the top side is closed.
Chinese Fonts	111	0: Stroke Specifies 2-byte character fonts, including Chinese characters. The setting cannot be changed for this model.
Alphanumeric Fonts	112	0: Stroke Specifies 1 byte character fonts. The setting cannot be changed for this model.
Vertical Position Adjustment	113	0 (Default): Does not move the hard clip area. 1 to 500: -250 to +250 mm Moves the hard clip area vertically. -1 to -250 mm for setting numbers 1 - 250 +1 to +250 mm for setting numbers 251 - 500

Horizontal Position Adjustment	114	<p>0 (Default): Does not move the hard clip area. 1 to 500: -250 to +250mm</p> <p>Moves the hard clip area horizontally. -1 to -250 mm for setting numbers 1 - 250 +1 to +250 mm for setting numbers 251 - 500</p>
Print Quantity Setup	115	<p>0 (Default): Protocol 1: Panel 2: Command</p> <p>Sets the method for specifying the print quantity.</p>
HP-GL Mode	150	<p>0 (Default): HP-GL 1: HP-GL/2</p> <p>A graphics language can be selected.</p>
Hard Clip	151	<p>0: Standard 2 (Default): Paper</p> <p>Sets the size for the area where drawings can be made (hard clip area). [Standard]...Hard clip area for A4, A3, letter, and ledger are the same as for the Hewlett Packard HP7550A. Hard clip area for other paper sizes is the same as this M/C printable area. [Paper]...Make the hard clip area the same area as the paper.</p>
Eject Command	152 (SP) 153 (SPO) 154 (NR) 155 (FR) 156 (PG) 157 (AF) 158 (AH)	<p>0 (Default): OFF 1: ON</p> <p>Sets the command that indicates a drawing is finished. When the command specified here is received, drawing is terminated and the paper is ejected. [Off]...Does not process as an eject command. [On]...Processes as an eject command. ON is set as the default for SPO only.</p>
Scaling	159	<p>0: OFF 1 (Default): ON</p> <p>Determines the setting to either enlarge or reduce the document size so that the document size fits the paper size. [OFF]...Prints in the same size without enlargement/reduction, even if the document size and paper size are different. [ON]...Prints while enlarging/reducing the data on document size so that it fits the paper size.</p>
Scaling Mode	160	<p>0 (Default): Paper Size 1: Active Coordinate Area</p> <p>Determines how the document size and the paper size are determined when Document Size (the item number 101) and/or Paper Size (102) is set to Auto (99). [Paper Size]...Make the document size the minimum size that combines the active coordinate area from the active coordinate determining method and the active coordinate obtained by the settings of Origin Position and Paper Margin. [Active Coordinate Area]...Make the document size the area from which the paper margin is subtracted from the active coordinate area obtained by the active coordinate determining method.</p>

Active Area Determining Command	161	<p>0 (Default): Auto 1: PS 2: IW 3: IP 4: Adapted</p> <p>When auto-scaling is in use, this sets the method for obtaining the active coordinate area. [Auto]...Determines any of the methods listed below: PS, IW, IP, or Adapted. [PS]...Area specified by the first PS command is to be a rectangular area. [IW]...Area specified by the very last IW command is to be a rectangular area. [IP]...Area which combines all the IP commands is to be a rectangular area. [Adapted]...The maximum/minimum coordinates within the areas and coordinates plotted using the drawing command, and the maximum size of characters and line width specified in the page, are used to calculate the rectangular area.</p>
Paper Margin	162	<p>0 to 99 (Default): 0): 0 - 99 mm</p> <p>Sets the paper margin when auto scaling is being used.</p>
Image Enhancement	163	<p>0: OFF 1 (Default): ON</p> <p>Sets whether to artificially increase the resolution of an image and smooth its edges.</p>
Stapling	164	<p>0 (Default): None 1: Top Left 2: Top Double 3: Top Right 4: Left Double 5: Right Double 6: Bottom Left 7: Bottom Double 8: Bottom Right 9: Center</p> <p>Sets the stapling position.</p>
Manual Feed Tray Check Indicator	165	<p>0: None 1 (Default): Yes</p>
Punching	166	<p>0: None 1 (Default): Top 2: Bottom 3: Left 4: Right</p> <p>Sets the punch position.</p>
Number of holes	167	<p>0 (Default): 2 holes 1: 3 holes 2: 4 holes</p>
Paper Folding	168	<p>0 (Default): None 1: Z-Fold</p>

Emulation Item	169	0 (Default): HP750C 1: FX4036
Pen Width (No. 0-No.15)	800-815	0 to 255 (Default): 3): 0 to 25.5 mm Sets the width of the pen (thickness of the line). Width units are 0.1 mm. Can be set in steps of 0.1 mm.
Line End Shape (No. 0-No.15)	850-865	0 (Default): Cut 1: Round 2: Rectangular Sets the line end shape.
Pen Intersects (No. 0-No.15)	900-915	0 (Default): None 1: Intersect 2: Round 3: Cut Sets the process for when pens' lines intersect.
Pen Color (No. 0~No.15)	950-965	0 - 255 Sets the color.

Hard Clip Area

In the HP-GL mode, the plottable area is determined in line with the paper size, apart from the printable area. This area is called a "hard clip area", and determines the maximum range of pen movement. Accordingly, images cannot be drawn outside the boundary of the hard clip area. This machine allows you to select a hard clip area from the following.

■Standard

Defines the printable area of this machine as the hard clip area.

■Paper

Defines a size that is the same as the paper as the hard clip area. However, the area that allows actual printing is within the printable area.

The hard clip area can be set either via HP-GL emulation mode settings or by the specified hard clip command "& 1".

The following coordinate values present an example of when the origin is set at the lower left (Auto Layout in HP-GL/2) of A3 sheet.

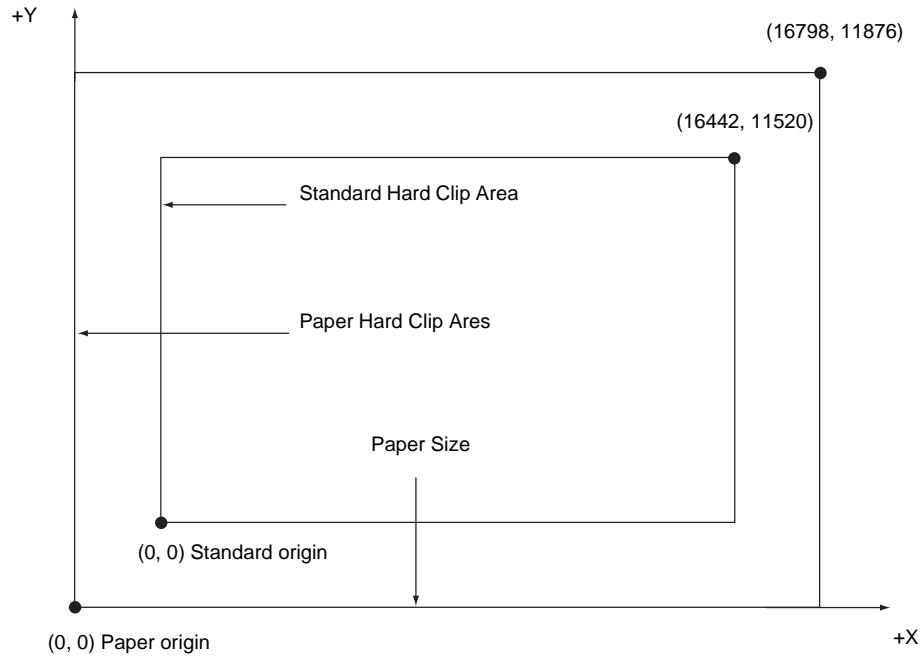

Printable Area

The printable area in the HP-GL mode is as follows.

■ Paper Size and Printable Area

Paper size	Paper Length (1/7200 inch)		Coordinate Value (1/7200 inch)							
	X Axis	Y Axis	Margin		Printable Area		Top-right Edge		Margin	
	Width	Height	Bottom-left X	Bottom Left Y	Long Side	Short Side	Top-right X	Top-right Y	XR	YU
A3	119052	84168	1260	1260	116532	81648	117792	82908	1260	1260
A4	84168	59508	1260	1260	81648	56988	82908	58248	1260	1260
A5	59508	41940	1260	1260	56988	39420	58248	40680	1260	1260
B4	103176	72828	1260	1260	100656	70308	101916	71568	1260	1260
B5	72828	51588	1260	1260	70308	49068	71568	71568	1260	1260

Note • The HP-GL emulation supports 5 paper sizes: A3,A5,A4, B4 and B5.

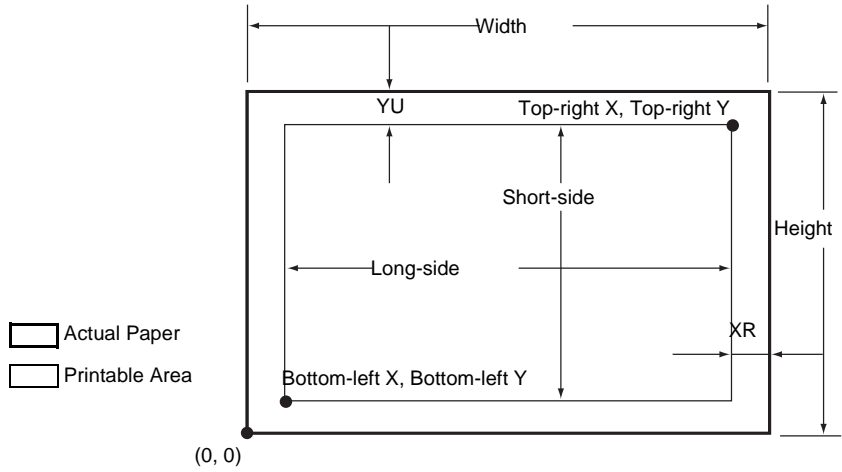

Paper size	Paper Length (1/7200 inch)		Coordinate Value (1/7200 inch)							
	X Axis	Y Axis	Margin		Printable Area		Top-right Edge		Margin	
	Width	Height	Bottom-left X	Bottom Left Y	Long Side	Short Side	Top-right X	Top-right Y	XR	YU
A3	84168	119052	1260	1260	81648	116532	82908	117792	1260	1260
A4	59508	84168	1260	1260	56988	81648	58248	82908	1260	1260
A5	41940	59508	1260	1260	39420	56988	40680	58248	1260	1260
B4	72828	103176	1260	1260	70308	100656	71568	101916	1260	1260
B5	51588	72828	1260	1260	49068	70308	50328	71568	1260	1260

Note • The HP-GL emulation supports 5 paper sizes: A3,A5,A4, B4 and B5.

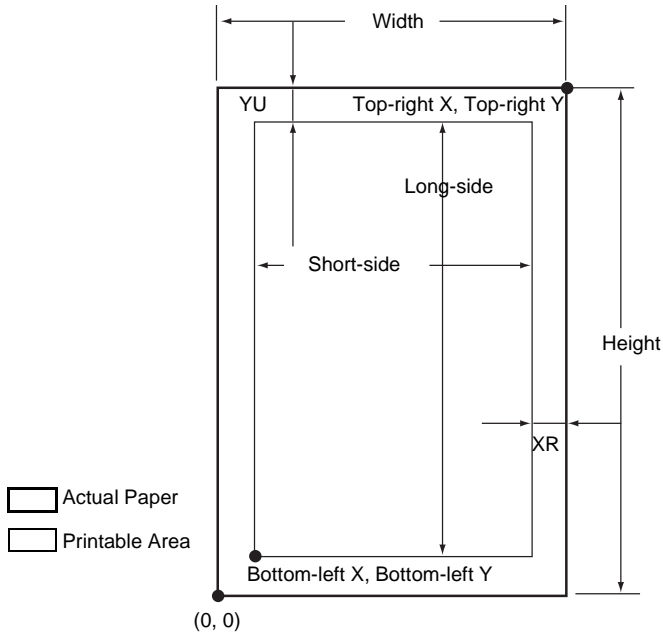

Auto Layout

This section explains Auto Layout.

1. What is Auto Layout?

Auto Layout is a function that evaluates document size based on the HP-GL data entered from the host system and enlarges/reduces it in line with the paper size to be plotted so that the plotted data is laid out in the center of the paper. Using the Auto Scale and Auto Layout functions enable you to print a document in the HP-GL mode without regard for the document size and origin position.

All specification in Auto Layout can be made via the operation panel. The settings cannot be made with advanced commands.

2. Activating the Auto Layout Function

Set the following items with the operation panel to activate the Auto Layout function.

- Set the document size to AUTO. The default value is AUTO.
- Set the Auto Layout to ON for setting the origin position. The default value is ON.
- Set Scaling to ON. The default value is ON.
- Select a method for obtaining the active coordinate area using the area determining mode. The default value is AUTO.
- Set the paper margin using Paper Margin. The default value is 0 mm.
- Set the Scaling Mode. The default value is Paper Size.

3. Details on Setting Items

Details on each item are as follows.

■ Document Size

Press the mode button and select AUTO under document size and it will be possible to set Auto Layout to ON.

■ Auto Layout

After pressing the mode button, press the menu button and set Auto Layout to ON. Once you set it to ON, the settings for scaling, area determination mode, paper margins and scaling mode all become active.

■ Scaling

Determines the setting to either enlarge or reduce (scaling) the document size so that the document size fits the paper size.

■ Area Determination Mode

Based on HP-GL data, the methods for obtaining the active coordinates area are as follows:

Auto

The method for determining the active coordinate area is automatically selected from among PS, IW, IP and Adapted.

In this mode the order of priority is PS, IW, IP, Adapted.

IW

The area specified by the very last IW command in the data becomes the active coordinate area.

If there are no IW commands in the data, the active coordinate area is determined by Adapted.

IP

The area that encompasses all the areas specified by IP commands in the data becomes the active coordinate area.

If there are no IP commands in the data, the active coordinate area is determined by Adapted.

Adapted

The ACA is determined by the following conditions.

Min/Max position coordinates plotted by drawing commands

Max font size specified within the page

Max line width

PS

The area that encompasses all the areas specified by PS commands in the data becomes the active coordinate area.

If there are no PS commands in the data, the active coordinate area is determined by Adapted.

■Paper Margin

Set the range from 0 to 99 mm. The default value is 0 mm. To get the active coordinate area, subtract the area set in paper margins from the ACA obtained in the area determination mode.

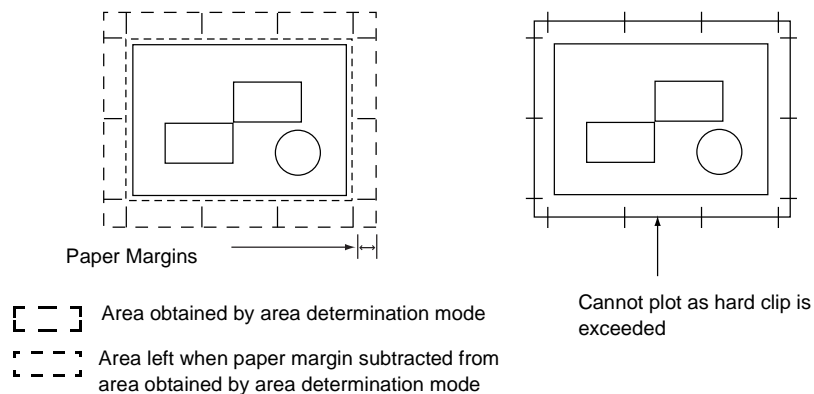

■Scaling Mode

Select the mode for determining the document size from the obtained ACA. Also, judge whether it will be portrait or landscape according to the ACA.

If it is an ACA

To get the document size, subtract the area set in paper margins from the area obtained in the area determination mode.

If it is a Paper Size

Set the document size from the obtained ACA and the origin point setting. The document size can be selected from A-size papers (6 sizes: A0, A1, A2, A3, A4 or A5).

4. How to Determine Document Size

The document size is determined by comparing the hard clip area for each paper size, based on the ACA obtained in the scaling mode, paper margins, and area determination mode.

■If the Scaling Mode is a Paper Size

- 1) Obtain the coordinate area to be active from the HP-GL data entered, in accord with the area determination mode.
- 2) As a margin, add the larger value of either the font size specified in the page, the default size or one half the specified pen width, to the ACA obtained in **1**.
- 3) Subtract the value set in paper margins from the ACA obtained in **2**.
- 4) The minimum size that includes the ACA obtained in **3** will be the document size.

■If the Scaling Mode is the ACA

- 1) Obtain the coordinate area to be active from the HP-GL data entered, in accord with the area determination mode.
- 2) As a margin, add the larger value of either the font size specified in the page, the default size or one half the specified pen width, to the ACA obtained in **1**.
- 3) Subtract the value set in paper margins from the ACA obtained in **2**.
- 4) The ACA obtained in the process up to **3** will be the document size.

■Ex.

If the following data is entered when the scaling mode = paper size, origin position = Auto, paper margin is 10mm, area determination mode = IP:

All pen width settings are 0.1 mm

The following data does not contain a character size specification command and the physical size of the area specified by IP/IW is A3.

```
IN;
IP-8399, -5938, 8399, 5938;
IW-8399, -5938, 8399, 5938;
PU;
SP1;
:
:
SP0;
```

- 1) As the area determination mode is IP, the ACA is specified as the area -8399,-5938,8399,5938 by an IP command.

YYY

- 2) In the example above, as there are no font size specification commands and all the pen widths are 0.1 mm, add the height/2 of the default font size for A3 size paper (75 plotter units) to the ACA obtained in **1**.
The ACA obtained in **2** is -8474, -6013, 8474, 6013.

- 3) The value set in paper margins (10 mm = 400 plotter units) is subtracted from the ACA obtained in **2**.
The ACA obtained in **3** is -8074, -5613, 80740, 5613.
- 4) As the ACA obtained in **3** exceeds the A4 size and is A3 size, the document size is determined to be A3.

In addition, as the ACA area when the paper margin setting is 0 mm is 8474, -6013, 8474, 6013, and this exceeds A3, but is A2 or smaller, the document size is determined to be A2.

5. How to Determine Paper Size

If the operation panel settings are as follows, the paper size is determined as below.

Document size: Auto

Paper Tray: Auto

The method for determining the paper size differs according to the paper size and scaling mode settings on the operation panel.

■If the Paper Size Setting is A Sizes

The possibilities for paper size are those that are actually loaded in the trays, from among the three sizes, A3, A4 and A5.

If A-sized papers (A3, A4, A5) are not loaded in the trays, all of the sizes, A3, A4 and A5 become possible sizes; a message is displayed on the operation panel prompting the user to load A-sized paper.

■If the Paper Size Setting is Auto

The possibilities for paper size are those that are actually loaded in the trays, from among the 5 sizes, A3, B4, A4, B5 and A5.

If A3, B4, A4, B5 or A5 paper is not loaded in the trays, all of the sizes become possible sizes; a message is displayed on the operation panel prompting the user to load paper.

■If the Scaling Mode Setting is Paper Size

If the paper size and the document size are the same, select paper that is the same size as the document.

If the document size is larger than any possible paper sizes, select the largest paper.

If the document size is smaller than any possible paper sizes, select the closest paper.

■If the Scaling Mode Setting is ACA

Select the smallest paper size that can contain the ACA.

If the ACA is larger than any possible paper sizes, select the largest paper.

If the ACA is smaller than any possible paper sizes, select the closest paper.

Supplementary Notes

If the document size is set to anything other than Auto, the paper size is the size set on the operation panel.

If the paper tray is set to Auto, the paper size is the size loaded in each tray. However, If paper whose size is not supported is loaded, an error message will be displayed prompting the user to load a supported paper.

6. How to Determine the Scaling Factor

When auto-scaling is being used, although the scaling factor is determined by the document size and paper size, it differs according to the scale mode setting.

Supplementary Notes

To activate scaling, turn the scaling setting to ON on the operation panel. If it is OFF, it is plotted at the same scale (100%).

■If the Document Size is Auto and the Scaling Mode is Paper Size

The hard clip setting is inactive. The hard clip area is always the paper's hard clip area.

If the document size = paper size, it plots at the same scale (100%).

If the document size > paper size, it plots at a reduced scale.

If the document size < paper size, it plots at the same scale (100%).

	A3	A4	A5	B4	B5
A0	35	25	100	31	100
A1	50	35	25	43	31
A2	71	50	35	61	43
A3	100	71	50	87	61
A4	100	100	71	100	87
A5	100	100	100	100	100

If the origin position for the plotting position is Layout, the document is laid out and drawn in the center. If the origin position is bottom left or center, the origin of the document and the paper are aligned and drawn.

■If the Document Size is Auto and the Scaling Mode is ACA

The hard clip setting is inactive. The hard clip area is always the advanced hard clip area.

The scaling factor is determined according to the ACA and the paper size. The range for the ACA for each paper size is as follows:

Paper Size	0 Degrees				90 Degrees			
	Min Value		Max Value		Min Value		Max Value	
	P2x - P1x	P2y - P1y	P2x - P1x	P2y - P1y	P2x - P1x	P2y - P1y	P2x - P1x	P2y - P1y
A3	7829	5485	73075	51200	5485	7829	51200	73075
A4	5485	3828	51200	35733	3828	5485	35733	51200
A5	3828	2648	35733	24720	2648	3828	44088	35733
B4	6762	4723	63120	44088	4723	6762	44088	63120
B5	4723	3297	44088	30773	3297	4723	30773	44088

Unit: Plotter Unit

The maximum scaling factor is 210% of the advanced hard clip area for each paper size and the minimum scaling factor is 22.5%.

7. Restrictions When Plotting under Auto Layout

■If the Printer is Equipped with Hard Disk(s)

When Auto Layout is used, print data is stored on the hard disk.

■If the Printer is Not Equipped with hard disk(s)

When Auto Layout is used, print data is stored in layout memory.

The default layout memory is set at 100kbyte. Consequently, when print data exceeding 100kbyte is received, a printer error occurs.

If this happens, change the Auto Layout memory capacity on the operation panel.

However, the Auto Layout memory capacity max is 5120 Kbyte. So, print data larger than 5120 Kbyte cannot be received.

When using the Auto Layout function, we recommend the printer be equipped with a hard disk.

8. Examples of Combinations of Each Function

The following are examples showing the print results that can be achieved by combining various functions.

■Document: Auto, Coordinate Origin: 0 Degrees, Scaling Mode: Paper Size, Scaling: ON

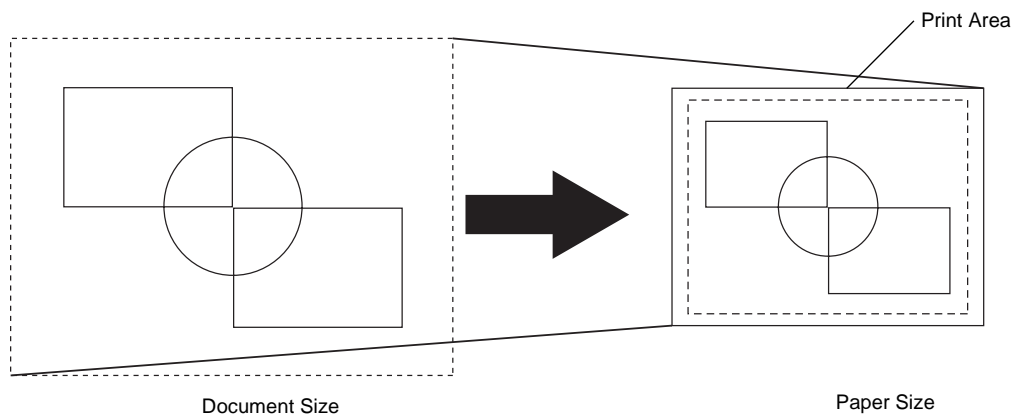

■Document: Auto, Coordinate Origin: 0 Degrees, Scaling Mode: Paper Size, Scaling: OFF

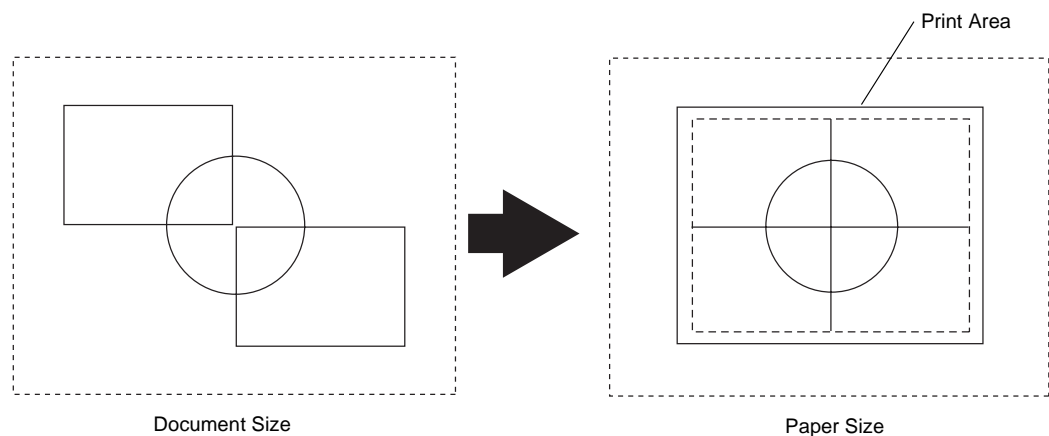

■ Document: Auto, Coordinate Origin: 0 Degrees, Scaling Mode: Active Coordinate Area, Scaling: ON

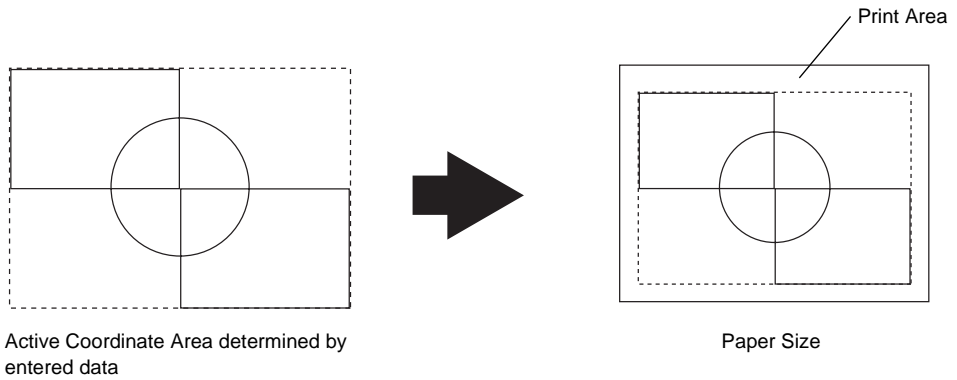

■ Document: Auto, Coordinate Origin: 0 Degrees, Scaling Mode: Active Coordinate Area, Scaling: OFF

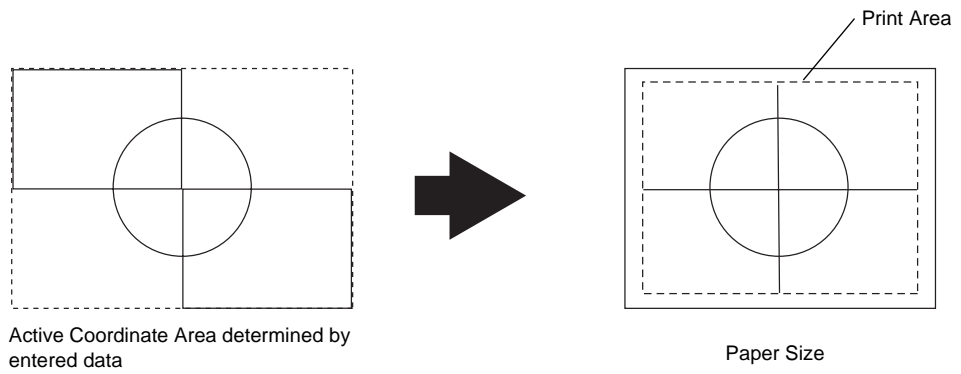

Notes and Restrictions

This section describes the notes and restrictions to observe when using the machine.

Notes and Restrictions on the Use of the Machine

■ When the Print Results Differ from the Settings

As in the following cases, insufficient memory for the print page buffer may cause print results to be different from what was expected from the settings. If this happens, we recommend you to increase the memory.

- Printed only on one side when 2-sided printing was specified.
- A job was terminated (If data on a page cannot be written to the print page buffer, the job including that page will be terminated).

■ Options

- To use the Print to Mailbox feature, optional Scanner Kit needs to be installed.

■ Installing and Moving the Machine

- When moving the machine to another location, contact our Customer Support Center.
- When the machine is in operation, do not subject it to shock.
- When closing the document cover, be careful not to trap your fingers.
- Do not place any objects near the ventilation opening of the machine's extractor fan.

■ Meter Counts for 2-Sided Printing

- When printing 2 sided, depending on the application the machine uses, blank sheets can be inserted automatically to adjust pages. Such blank sheets inserted by the application are also counted by the meter.

■ Job Counter Report

When you have specified two or more different [Multiple-up] settings using the Build Job feature, the numbers of pages for [2-up] and [Other than 2-up] displayed on Job Counter Reports are calculated according to the latest N-up setting you specified.

Example 1)

When you select [2 sheets → 1 sheet (2-up)] for Document 1 (4 pages) and [No] for Document 2 (2 pages), both Documents 1 and 2 are set to [No] and the number of printed pages is calculated as follows:

- Total pages: 4
- 2 up: 0

Example 2)

When you select [No] for Document 1 (4 pages) and [2 sheets → 1 sheet (2-up)] for Document 2 (2 pages), both Documents 1 and 2 are set to [2 sheets → 1 sheet (2-up)] and the number of printed pages is calculated as follows:

- Total pages: 5
- 2 up: 5

The numbers of pages for 2in1, 4in1, and 8in1 are also calculated in the same way as above on DocuLyzer and ApeosWare Accounting Service.

The meter on the [Billing Meter] screen calculates the number of printed pages correctly regardless of the [Multiple-up] setting.

■Addresses Registered on Job Flows

When an abbreviated number or address registered on Address Book has been used for a job flow creation on the machine, any number of address change on Address Book will not be reflected to the job flow. To send to the changed address, the address registered on the job flow must be directly changed.

■Possibility of Slowing Down the Print Job Speed by Operations on the Control Panel

While processing a print job on ApeosPort series models or DocuCentre series models that are fitted with Full Size Color UI (optional), using the control panel for any operations or displaying the [Job Status] screen to check on the print job status may possibly slow down the print job speed.

Notes and Restrictions in the Interrupt Mode

If you press the <Interrupt> button while running a print job, the machine temporarily stops printing and goes into the interrupt mode.

Important • However, if a scan job is running at the same time, the print job cannot be interrupted.

The jobs that can be/cannot be interrupted are as follows.

Job		Job Instruction from the Control Panel *1	Job Execution
Copy		Required	O
Print	Printing of a document *2 instructed from a client computer	Required*4	O
	Printing of a document*3 instructed from [Job Status] > [Stored Documents]	Required	O
Scan	Scan to Mailbox, Scan to PC, E-mail, Network Scanning	Required	O
Report/List	Automatic printing of a report/list other than a job history report	Not required	X
	Automatic printing of a job history report	Not required	O
	Printing of a report/list instructed from [Billing Meter/Print Report] > [Print Report/List]	Required	O
Mailbox	Printing of a stored document (scanned document/print document) instructed from the control panel	Required	X
	Automatic printing of a stored document	Required*4	O
Job Flow Sheet	Execution of a job flow sheet instructed in [Mailbox] or [Job Flow Sheets] on the touch screen	Required	O

O The job can be executed during the interrupt mode.

X The job cannot be executed during the interrupt mode.

△ The job request is accepted, but cannot be executed during the interrupt mode.

*1 The job instruction from the control panel is required/not required to execute the job.

*2 Regular Print, the first set of Sample Print, Delayed Print (auto print)

*3 Security Print, Private Charge Print, Sample Print, Delayed Print, Charge Print

*4 During interruption, any document displayed as a pending job on the [Job Status] screen can be printed by selecting

[Promote Job]. When priority printing is instructed during interruption, the next priority printing is disabled until the instructed print job is completed.

Notes and Restrictions when Connecting with Internet Service Provider

This section describes notes and restrictions on features relating e-mail that accesses with a Internet service provider (ISP).

The following shows the features relating e-mail.

- Mail scanning
- Mail Notice Service
- E-mail Printing

■Notes and Restrictions on accessing ISP

The following are the notes and restrictions on connecting the machine to ISP.

- Dial-up connection is not supported. Continuous connection is required.
- Connect the machine under circumstances using IP masquerade. Assigning a global IP address to the machine is not supported.
- Make sure to assign an exclusive e-mail account to the machine for POP receiving. Sharing an e-mail account with other users may cause troubles.
- Make sure to set size limitation for sending e-mail. The applicable e-mail size may vary depending on the ISP used, however, it is recommended you set a small value.
- Continuous connection other than ADSL or cable connection is also supported; however, it burdens the machine when image data is sent or received.
- SMTP receiving is not supported. This machine supports only POP receiving.
- When installing the machine in a circumstance using a mail transfer agent (MTA) in a private segment, set the machine to fit the operation system.
- For information about supported ISPs, contact our Customer Support Center.

■Feature Specifications

The following shows the features relating to e-mail.

- Transmission specifications

Supported protocol : SMTP

Port number : 25

Authentication for transmission

SMTP authentication : supported

POP before SMTP : Plain and APOP

Waiting time for POP authentication : cannot change

Encryption communication (SSL) : not supported

- Receiving specifications

Supported protocol : POP3

POP3 port number : 110

Authentication method for POP3 : Plain and APOP

E-mail processing after receiving POP3: delete received e-mail from a server after receiving. Settings to store e-mail on the server is not supported.

Encryption communication (SSL) : not supported

Note • IMAP4 is not supported.

■ IP address settings

The machine does not support a global IP address. Make sure to use the machine under circumstances using IP masquerade.

- Operating with fixed address

Register the machine's IP address to a router or a server managing IP addresses for control servers.

- Operating with DHCP

No settings are needed. Depending on settings of a router and a DHCP server, registration may be needed. Confirm operation rules for the router and DHCP server you use. When access is restricted by MAC address, registration to the DHCP server may be required.

■ Settings from the control panel

Before using mail scanning, set the maximum data size for sending e-mail on the control panel. Refer to the ISP guidelines for the maximum limit. Recommended value is 1 to 2 MB.

In the System Administration mode, select [System Settings] - [System Settings] - [Mail Settings] - [Control Mail Sending] - [Maximum E-mail Size] to perform the setting.

For more information, refer to "Maximum E-mail Size" (P.179).

The following shows adequate image sizes:

- A4 full-color 200dpi with standard compression : around 700 KB
- A4 full-color 200dpi with high compression : around 400 KB
- A4 black-white 200dpi (text document) : around 25 KB
- A4 black-white 200dpi (text & photo document): around 200 KB

Note • The sizes described above are those for sending e-mail. The actual size may be different.

■ Settings from CentreWare Internet Services

For settings to be performed on CentreWare Internet Services, refer to "Setting Items Using CentreWare Internet Services" (P.215).

Important • Set [POP3 Server Check Interval] to 10 minutes or longer when connecting ISP.

Notes and Restrictions for Using SMB

The following are the notes and restrictions for using SMB.

Configuration on the Machine

- IP addresses are managed throughout the system as a whole. The configuration should be performed only after consulting with your network administrator.
- Subnet Mask and Gateway addresses may be necessary depending on the network environment. Confirm with the network administrator and set up the necessary items.
- When the port status is set to [Enable], it sometimes automatically switches to [Disable] if the machine has insufficient memory. If this happens, either set an unused port to [Disable], or adjust the assigned memory size.

- Adjust the receiving buffer [SMB (Spool)] size according to usage. When the receiving buffer [SMB (Spool)] size is smaller than the transmitted data, the machine may not be able to receive the data.

Configuration on a Computer

- IP addresses are managed throughout the system as a whole. The configuration should be performed only after consulting with your network administrator.

Switching Off the Power

Check the following points when switching off the machine.

- When [SMB (Spool)] is set to [Memory].

All print data spooled within the machine memory, including the data which is being printed is erased. The print data will not be found when the machine is powered on again.

However, if the power was switched off immediately after a computer instructed a print job, the job may remain on the computer. In this case, the stored data on the computer will be printed out in order before any later instructions when the machine is powered back on.

- When [SMB (Spool)] is set to [Hard Disk].

All print data spooled in the machine hard disk, including the data which is being printed is preserved. In this case, the stored data on the machine hard disk will be printed out in order before any later instructions when the machine is powered back on.

- When [SMB (Spool)] is set to [Off].

All print data spooled in the machine receiving buffer, including the data which is being printed is erased. The print data will not be found when the machine is powered on again.

However, if the power was switched off immediately after a computer instructed a print job, the job may remain on the computer. In this case, the stored data on the computer will be printed out in order before any later instructions when the machine is powered back on.

While Printing

- When [SMB (Spool)] is set to either [Hard Disk] or [Memory].

If the transmitted print data size exceeded the available amount of either hard disk or memory, the print data will not be received.

- Note**
- When the print data has exceeded the receivable size, some computers may immediately re-transmit the print data. When this occurs, the computer appears to be halted. Deal with this problem by canceling the print data transmission from the computer.

- When [SMB (Spool)] is set to [Off].

While the machine is receiving a print request from a computer, the machine cannot accept any print requests from other computers.

- When a computer's IP address or a computer name is changed.

When a computer's IP address or a computer name is changed, queries and cancel processes from the machine will not be performed correctly. Switch the machine off and on when there is no print data in the receiving buffer.

- Note**
- Canceling print jobs or forcing the machine to print the remaining jobs in the receiving buffer can be operated from the control panel on the machine. For information on the operation, refer to "Job Status" (P.71).

- When the machine is off-line.

If a computer instructs a print job while the machine is off-line, the machine will not receive the data and a write error dialog will be displayed on the computer.

Environment for Printing through SMB

- When using Windows 2000, Windows XP or Windows Server 2003, if [Unicode Support] is enabled, no printing is available on the SMB environment.
- When printing through the SMB port on Windows XP, the user name may not be displayed correctly.

SMB Authentication

When an IP address or a host name is used to designate the authentication server for SMB authentication, even if the domain name is not correct, if a correct user name and passcode are entered, the authentication succeeds.

Notes and Restrictions for Using TCP/IP

The following are the notes and restrictions for using TCP/IP (LPD).

Configuration on the Machine

- IP addresses are managed throughout the system as a whole. The configuration should be performed only after consulting with your network administrator.
- Subnet Mask and Gateway addresses may be necessary depending on the network environment. Confirm with the network administrator and set up the necessary items.
- When the port status is set to [Enable], it sometimes automatically switches to [Disable] if the machine has insufficient memory. If this happens, either set an unused port to [Disable], or adjust the assigned memory size.
- Adjust the receiving buffer [lpd (Spool)] size according to usage. When the receiving buffer [lpd (Spool)] size is smaller than the transmitted data, the machine may not be able to receive the data.

Configuration on the Computer

- IP addresses are managed throughout the system as a whole. The configuration should be performed only after consulting with your network administrator.
- When performing network settings (IP address, etc.) on a host under the NIS (Network Information Service) management, consult with the NIS administrator.

Switching Off the Power

Check the following points when switching off the machine.

- When [lpd (Spool)] is set to [Memory]

All print data spooled within the machine memory, including the data which is being printed is erased. The print data will not be found when the machine is powered on again.

However, if the power was switched off immediately after a computer instructed a print job, the job may remain on the computer. In this case, the stored data on the computer will be printed out in order before any later instructions when the machine is powered back on.

- When [lpd (Spool)] is set to [Hard Disk]
All print data spooled in the machine hard disk, including the data which is being printed is preserved. In this case, the stored data on the machine hard disk will be printed out in order before any later instructions when the machine is powered back on.
- When [lpd (Spool)] is set to [Off]
All print data spooled in the machine receiving buffer, including the data which is being printed is erased. The print data will not be found when the machine is powered on again.

However, if the power was switched off immediately after a computer instructed a print job, the job may remain on the computer. In this case, the stored data on the computer will be printed out in order before any later instructions when the machine is powered back on.

While Printing

- When [lpd (Spool)] is set to either [Hard Disk] or [Memory]
If the transmitted print data size exceeded the available amount of either hard disk or memory, the print data will not be received.
Note
 - When the print data has exceeded the receivable size, some computers may immediately re-transmit the print data. When this occurs, the computer appears to be halted. Deal with this problem by canceling the print data transmission from the computer.
- When [lpd (Spool)] is set to [Off]
While the machine is receiving a print request from a computer, the machine cannot accept any print requests from other computers.
- When a computer's IP address or a name is changed
When a computer's IP address or a name is changed, queries and cancel processes from the machine will not be performed correctly. Switch the machine off and on when there is no print data in the receiving buffer.
Note
 - Canceling print jobs or forcing the machine to print the remaining jobs in the receiving buffer can be operated from the control panel on the machine. For information on the operation, refer to "Job Status" (P.71).

Notes and Restrictions for Using EtherTalk

The following are the notes and restrictions for using EtherTalk.

Printer Name

Printer names used to be identified by clients are set not to duplicate each other. When assigning a new printer name, If the same printer name has already existed on the network, the system automatically change the printer name on startup.

<Rules for changing printer name>

Printer names are changed according to the following rules:

- Names of 31 characters or less

Add a number to the end of the printer name. If the same printer name with the number added has still existed on the network, increase the added number by 1.

- Names of 32 characters

Change the last character of the printer name to a number. If the same printer name with the last character changed has still existed on the network, increase the changed number by 1.

If the printer name has been changed, when browsing [Protocol Settings] on the [Properties] tab of CentreWare Internet Services, the previous printer name set before the change is displayed. However, the changed printer name is registered on the network, clients can browse the printer using the changed printer name. If the printer is turned off and then on while the printer name has been changed, the printer is activated with the changed printer name. If the same printer name has already existed on the network, the printer name will be changed according to the rules described above on startup.

Assign a printer name not to duplicate to other printer names on the network.

Zone Name

Zone names can be set in [Protocol Settings] on the [Properties] tab of CentreWare Internet Services. However, if the zone name set does not exist on the network to which the printer is connected, the zone name is automatically set as default. To set a zone name, use the zone name that has already existed on the network.

Notes and Restrictions for Using Bonjour

The following are the notes and restrictions for using Bonjour.

Supported Environment for Bonjour

Bonjour is available on Printer Setup Tool (Print Center, Printer Setup Utility) of Mac OS X 10.3.9 or later, or Macintosh computers that use Safari. The discovery feature of Bonjour is available only in the same subnet.

Printer Name

- If a printer name or a host name that is already assigned is changed, documents may be printed by a printer that is not selected.
- If a printer name or a host name is duplicated on the same network, one of the duplicated names is automatically changed by adding a number to avoid confliction.
- When changing a printer name or a host name, because of the limitation on the number or type of characters used, a name differing from the designated name may be assigned in some cases. We recommend not to change printer names or host names.

Notes and Restrictions for Using Scanner Features

The following are the notes and restrictions for using the scanner features.

Refer to the Readme contained in the CentreWare Utilities CD-ROM for the notes and restrictions on Network Scan Driver and Mailbox Viewer2.

Retrieving Documents from Mailbox

- When [Delete/Save Documents] is set to [Save], the same document can be accessed by multiple clients.
When [Delete/Save Documents] is set to [Delete], only one client can access any given document. The document which is being imported by a client cannot be seen by other clients.
In both cases, documents can be added to a mailbox while it is accessed.
- When documents are retrieved from CentreWare Internet Services, the documents will not be deleted regardless of the setting of [Delete Documents After Retrieval].

Using Network Scan Driver and Mailbox Viewer2 Simultaneously

You cannot use both the network scan driver and Mailbox Viewer2 on a single computer to make a connection to the machine.

A maximum of three computers using either the Network Scan Driver or Mailbox Viewer2 may retrieve documents simultaneously from one machine.

Using TIFF Files

The TIFF files created by Mailbox Viewer2 are compressed into the MMR, MH, JBIG, or JPEG format. When opening the TIFF files, use the appropriate application software which supports the format.

Note • Mailbox Viewer2 cannot create a TIFF file compressed into JBIG format.

Restriction on Scanning Capacity

The maximum scanning capacity for one page is 297 x 432 mm. For standard sizes, A3 or 11 x 17 inches.

Number of Sheets for Scanning (for Mailbox)

A maximum of 999 pages can be scanned in at once for mailboxes. The number of pages may differ depending on the document size and resolution.

Network Reference on SMB Environment

- On Windows 2000, Windows XP, or Windows Server 2003, if more than 256 shared resources other than shared folders (such as shared printers) are configured, shared resources other than shared folders may be displayed in the shared folder list.
- Workgroup names, server names, shared names and the like on the network may not be displayed alphabetically on the list.

Notes and Restrictions when Connecting to Internet or Intranet

The following are the notes and restrictions when connecting to the Internet or intranet.

Internet/Intranet Connection

Depending on the web server, server application, proxy server and firewall, connection to the Internet or intranet may not be able to be established.

To connect to the Internet or intranet using a third-party server application, proxy, or firewall, the following requirements must be satisfied:

- Supporting Windows2000, Windows XP, or Windows Server 2003
- Being compliant with the following:
 - RFC2616: Hypertext Transfer Protocol HTTP/1.1
(Standard connection/SSL connection/Proxy authentication)
 - RFC2617: HTTP Authentication: Basic and Digest Access Authentication
(only Basic authentication is supported, the other authentications are not supported)
 - RFC2817: Upgrading to TLS Within HTTP/1.1
 - RFC2818: HTTP Over TLS
- Supporting the HTTP/HTTPS schemes
- Supporting the GET/CONNECT/POST methods

Index

Numerics

100BASE-TX	221
10BASE-T	221
2 Sided Copying (System Settings)	148
2 Sided Report (System Settings)	132

A

Account ID Characters (System Settings)	206
Account Limit (System Settings)	203, 204
Address Book	100, 196
Address Book (Address Number) (System Settings)	196
Address Number (System Settings)	196
Address Type (System Settings)	197
Adjust Image Position (System Settings)	132
administrator shared job flow sheet	275
administrator shared mailbox	278
Adobe PostScript 3 Kit	221, 235
Alert Tone (System Settings)	125
All Feature Access Settings	205
All Services (System Settings)	126
Allocate Memory (System Settings)	169
Attribute Name of Custom Items 1 to 3 (System Settings)	166
Attribute Type of Custom Items 1 to 3 (System Settings)	166
Attribute Type of E-mail Address (System Settings)	166
Attribute Type of First Name (System Settings)	166
Attribute Type of Last Name (System Settings)	166
Attribute Type of Recipient Name (System Settings)	166
Auditron Administration	101
Auditron Mode (System Settings)	210
Auditron Report (Copy Jobs)	102
Auditron Report (Fax Jobs)	103
Auditron Report (Print Jobs)	102
Auditron Report (Scan Jobs)	103
authenticated user	272
authentication and auditron administration	282

Authentication System (System Settings)	163
Auto Clear (System Settings)	122
Auto Clear Alert Tone (System Settings)	125
Auto Display of Login Screen (System Settings)	125
auto gradation adjustment	66
Auto Job Promotion (System Settings)	138
Auto Job Release (System Settings)	122
Auto Paper Off (System Settings)	151
Auto Power Saver (System Settings)	123
Auto Print (System Settings)	122
Auto Print Delivery Confirmation Mail (System Settings)	180
Auto Print Error Mail (System Settings)	179
Auto Tray Switching (System Settings)	128
automatically printed reports/lists	103

B

Background Pattern (System Settings)	133
Background Suppress (Photo & Text) (System Settings)	152
Background Suppression (B/W Copy) (System Settings)	130
Background Suppression (Color Copy) (System Settings)	130
Background Suppression (Scan Jobs) (System Settings)	130
Background Suppression (System Settings)	148, 175
Background Suppression Level (System Settings)	177
Background Suppression Level (Text)	152
Banner Sheet (System Settings)	172
Banner Sheet Tray (System Settings)	173
Base Tone (System Settings)	124
Billing Meter/Print Report	95
booklet staple cartridge	56
built-in fonts	413

C

calibration	66
-------------------	----

E

Edge Erase - Left & Right Edges (System Settings)	148, 176
Edge Erase - Top & Bottom Edge (System Settings)	148
Edge Erase - Top & Bottom Edges (System Settings)	176
Edge Erase (System Settings)	175
E-mail	238, 246, 415
e-mail address	242
E-mail Address (System Settings)	197, 203
E-mail Control (System Settings)	179
E-mail Encryption	266
E-mail Printing	238
E-mail Receive Protocol (System Settings)	168
E-mail/Internet Fax Settings (System Settings)	179
emulation	413, 425
emulation mode	425
encryption	262
Encryption Key for Confidential Data (System Settings)	143
error code	323
Error History Report	98, 105
ESC/P Form Memory (System Settings)	169
ESC/P Settings List	99
ESC/P Stored Programming List	99
ESC/P User Defined List	99
Ethernet II	221
EtherTalk	221, 235
Extended Features Settings List	100
extension flap	29

F

Failed Access Log (System Settings)	206
Fault Tone (System Settings)	124
Faults	105
Fax Number (System Settings)	197
Fax Service (System Settings)	137
Feature Access (System Settings)	203
Feature in 2nd Column (System Settings)	174
File Format (System Settings)	175
Fine-tune 100% (System Settings)	152
first copy output time	410

First Name (System Settings)	197
Fonts List	99
Force Watermark - Client Print (System Settings)	134
Force Watermark - Copy Job (System Settings)	134
Force Watermark - Mailbox Print (System Settings)	134
FTP	251

G

General Settings Tab - Features Allocation (System Settings)	145
general shared mailbox	278
gradation	410

H

handling error terminations	85
hard disk capacity	410
heavyweight settings	126
Hide Account ID (***) (System Settings)	206
Hide User ID (***) (System Settings)	206
holding	418
hole punching	416, 418
host name	242
HP-GL/2 Palette List	99
HP-GL/2 Settings List	99
HP-GL/2 Stored Programming List	99
HP-GL2 emulation	445
HTTP	212
HTTP - SSL/TLS Communication (System Settings)	167
HTTP - SSL/TLS Port Number (System Settings)	167
HTTPS	264

I

IEEE802.3	221
Image Compression (System Settings)	176
Image Enhancement (System Settings)	130
Image Log Control (System Settings)	136
Image Log Generation (System Settings)	136
Image Log Target (System Settings)	136

Image Log Transfer (System Settings)	136
Image Quality (System Settings)	129
image quality problems	294
Image Rotation (System Settings)	149
Image Rotation Direction (System Settings)	149
Image Shift - Side 1 (System Settings)	149
Image Shift - Side 2 (System Settings)	149
Image Transfer Screen (System Settings)	178
Index (System Settings)	199
Initialize Hard Disk (System Settings)	132
interface	413, 414
Internet Printing Protocol	233
Internet service	254
interposer	418
IPP	233
IPP port	233

J

Job Completion Notice	238
Job Counter Report	101
Job Flow Error Report	103
Job Flow Error Report (System Settings)	132
Job Flow Scanning	246
Job Flow Sheet Keywords (System Settings)	195
job flow sheet shared by general users	275
job flow sheet types	275
Job Flow Sheets (System Settings)	190
job flow sheets created on the Check Mailbox screen	276
job flows created on the Job Flow Sheets screen	276
Job History Report	97
Job History Report (System Settings)	131
<Job in Memory> indicator	70
Job Status	72
Job Status/Activity Report	97
Job Template List	100
Job Template Scanning	246, 249
Job Type on Job Status Screen (System Settings)	126
jobs that can be managed for each service	285

K

Kerberos Server 1 through 5 (System Settings)	163
Keyboard Input Restriction (System Settings) ...	141

L

label paper	26
Language	126
Last Name (System Settings)	197
LDAP - SSL/TLS Communication (System Settings)	167
LDAP Server/Directory Service (System Settings)	164
license	17
Lighten/Darken (System Settings)	147, 175
Link Job Flow Sheet to Mailbox (System Settings)	189
linking job flow sheets to mailboxes	280
loading paper	27
local access	273
local machine authentication	272
Login Setup/Auditron Administration (System Settings)	202
Login Setup/Auditron Mode (System Settings)	209
Low Toner Alert Tone (System Settings)	125
LPD port	225, 229
LPD protocol	225

M

machine configuration	90
machine information	89
Machine Ready Tone (System Settings)	124
Machine Status	88
machine trouble	289
Machine's E-mail Address/Host Name (System Settings)	160
Macintosh	222
magnification	410
Mailbox (System Settings)	188
Mailbox Access (System Settings)	210
mailbox job flow sheet	275
Mailbox List	101
Mailbox Name (System Settings)	189

- manageable features and services 283
- Max No. of Pages for Split Send
(System Settings) 180
- Maximum Address Entries (System Settings) ... 179
- maximum continuous copy run 412
- Maximum E-mail Size (System Settings) 179
- maximum fill line 28, 29, 31, 32, 33, 34, 35, 37
- Maximum Login Attempts (System Settings) 201
- maximum power 412, 418
- Maximum Search Results(System Settings) 166
- Maximum Stored Pages (System Settings)
..... 151, 177
- memory capacity 410, 413
- Memory Full Procedure (System Settings)
..... 151, 177
- messages 323, 366
- Microsoft Networks 231
- Millimeters/Inches (System Settings) 141
- Mixed Sized Originals - Copy to Side 2
(System Settings) 151
- Mixed Sized Originals (System Settings)
..... 148, 175
- ## N
- NetWare port 228
- network authentication 273
- network environment 222
- network printer 220
- Network Scanning 246
- Network Settings (System Settings) 155
- Non-Copy Job Complete Tone (System Settings)
..... 124
- notes and restrictions 459
- ## O
- Object Class of Search Target
(System Settings) 166
- Offset Stacking (System Settings) 138
- Operation of Up/Down Buttons (System Settings)
..... 141
- Original Orientation (System Settings) 149, 175
- Original Size Defaults (System Settings) .. 153, 176
- Original Type - Auto (Black) (System Settings)
..... 147
- Original Type - Auto (System Settings) 147
- Original Type - Lightweight Originals
(System Settings) 152
- Original Type (System Settings) 147, 174
- Out of Paper Warning Tone (System Settings) . 125
- outline fonts 421
- Output Color (System Settings) 147
- Output Color Recognition (System Settings) 130
- Output Destination (System Settings) 149
- output resolution 410, 413
- Output Size Defaults (System Settings) 176
- output tray capacity 412
- overview of Auditron Administration 282
- overview of authentication 272
- Overwrite Hard Disk 91
- Overwrite Hard Disk (System Settings) 141
- ## P
- Page - Position (System Settings) 150
- page description language 413
- Page Number Style (System Settings) 150
- paper capacity 415
- paper feed method/capacity 412, 418
- paper guides 29, 30
- paper jams 366
- Paper Size / Auto Paper Select
(System Settings) 127
- Paper Size Settings (System Settings) 138
- paper size/supported paper 415, 416, 417, 418
- Paper Supply (System Settings) 146
- Paper Type Mismatch (System Settings) 172
- Paper Type Priority (System Settings) 128
- paper types 24
- Passcode (System Settings) 203
- Passcode Entry from Control Panel
(System Settings) 208
- Password (System Settings) 199
- PCL Form List 98
- PCL Settings List 98
- PDF Settings List 98
- PDF/DocuWorks Signature Settings
(System Settings) 168
- personal job flow sheet 275
- personal mailbox 278
- Photo & Text Recognition (System Settings) 129

Photo & Text/Printed Original (System Settings)	152
Photo Image Quality (System Settings)	130
Photo Reproduction Level (System Settings)	130
PJL Output Command Control (System Settings)	207
PJL Receive Command Control (System Settings)	207
PKI (Public Key) Settings (System Settings)	167
plain paper (printable paper)	24
POP3	242
POP3 Server Settings (System Settings)	162
Port 9100 port	225
Port 9100 protocol	225
Port Number (System Settings)	199
Port Settings (System Settings)	155
PostScript Default Color (System Settings)	173
PostScript Font Absence (System Settings)	173
PostScript Font Substitution (System Settings)	173
PostScript Fonts List	99
PostScript Memory (System Settings)	169
PostScript Paper Supply (System Settings)	173
power	412, 418
preferentially printing pending jobs	84
Print Area (System Settings)	171
Print Mode	92
Print Mode Settings	98
Print Mode Settings (System Settings)	169
print quality trouble	294
Print User ID (System Settings)	172
printable area	450
Printer Lockout Duration (System Settings)	122
printing a report/list	70, 97
printing delayed print documents	79
printing sample print documents	78
printing secure print documents	77, 83
printing security print documents	77, 83
printing stored documents	75
Private Charge Print	81
Programming	92
Promote Job	73
Protocol Settings (System Settings)	158
PS Logical Printers List	99
punch scrap container	59, 60

R

Read Status (MDN) (System Settings)	180
Realm Name (System Settings)	164
Receive Control (System Settings)	207
Receiving Buffer - EtherTalk (System Settings)	170
Receiving Buffer - IPP Spool (System Settings)	170
Receiving Buffer - LPD Spool (System Settings)	170
Receiving Buffer - NetWare (System Settings) .	170
Receiving Buffer - Port 9100 (System Settings)	171
Receiving Buffer - SMB Spool (System Settings)	170
Receiving Buffer - USB (System Settings)	169
receiving protocol	242
Recipient Name (System Settings)	197
Reduce/Enlarge (System Settings)	146
Reduce/Enlarge -2nd to 4th Buttons (System Settings)	174
Reduce/Enlarge Presets (System Settings)	153, 177
remote access	274
Remote Access (System Settings)	210
remote authentication	273
replacing the stamp cartridge	59, 60
Reset Account	204
Reset Total Impressions (System Settings)	204
Reset User Accounts (System Settings)	205
resolution	413
Response to Read Receipts (System Settings)	180
Retrieve Programming	92
RSA BSAFE	17

S

S/MIME	243
S/MIME Settings (System Settings)	168
Salutation	247
Sample Set (System Settings)	149
Saturation (System Settings)	147, 177
Save in (System Settings)	198
Scan Defaults (System Settings)	174

- Scan Mode Settings 100
- Scan Mode Settings (System Settings) 174
- scan resolution 410, 414
- Scan Resolution (System Settings) 175
- Scan Service (System Settings) 177
- scan size 414
- Scan to Mailbox 246, 414
- Scan to PC 246, 414
- scanning gradation 414
- scanning speed 414, 415
- Scope of Search from Root Entry
(System Settings) 165
- screen 66
- Screen After Auto Clear (System Settings) 125
- Screen Default (System Settings) 125
- Screen/Button Settings (System Settings) 125
- Search Entries by First Name
(System Settings) 166
- Search Entries by Last Name
(System Settings) 166
- Search Entries by Recipient Name
(System Settings) 166
- Search Login Name (System Settings) 165
- Search Password (System Settings) 165
- Search Root Entry DN (System Settings) 165
- Search Time-Out (System Settings) 166
- Secondary Server Name (System Settings) 164
- Secondary Server Port Number
(System Settings) 164
- Serial Number 89
- Server Application (System Settings) 166
- Server Fax 255
- Server Name/IP Address (System Settings) 198
- Service Rep. Restricted Operation
(System Settings) 144
- Settings List - Common Items 98
- Setup Menu (System Settings) 188
- Shadow Suppression (System Settings) 175
- Shadow Suppression Level (System Settings)
..... 178
- Shared Name (SMB Only) (System Settings) ... 198
- Sharpness (System Settings) 147, 175
- Single Color (System Settings) 147
- SMB 251
- SMB port 231
- SMTP 242
- SMTP Server Settings (System Settings) 162
- SNMP port 249, 253
- SOAP port 253
- Software Download (System Settings) 144
- Software Options (System Settings) 132
- software version 90
- space requirements 413
- Stamp Color (System Settings) 150
- Stamp Density (System Settings) 152
- Stamp Position (System Settings) 149
- Stamp Size (System Settings) 149
- Stamp Text (System Settings) 149
- staple cartridge 54, 57, 399, 402
- Staple cartridge for 100 sheets XA 42
- Staple cartridge for 50 sheets XE 42
- Staple cartridge for booklet maker finisher XC 42
- staple scrap container 61
- stapler faults 398
- stapling 416, 417
- Store User Details (System Settings) 206
- Store/Delete Programming 93
- Stored Programming Tone (System Settings) ... 125
- Substitute Tray (System Settings) 171
- Supplies 104
- supported frame types 221
- supported interfaces 221
- supported OS 413
- Supported Paper Types 25
- supported protocol 413
- System Administrator Login ID
(System Settings) 200
- System Administrator mode 108
- System Administrator Settings (System Settings)
..... 200
- System Administrator's Meter (Copy Jobs)
(System Settings) 205
- System Administrators Passcode
(System Settings) 200
- system settings menu list 112

T

- target job types for the Auditron Administration
feature 285
- TCP/IP protocol 225
- Text Size (System Settings) 133

Text/Background Contrast (System Settings)	133
Thumbnail - Outgoing E-mail (System Settings)	
.....	175
Thumbnail - Scan to PC	175
TIFF Format (System Settings)	178
TIFF Logical Printers List	99
TIFF Settings List	99
Time (System Settings)	122
Time Server IP Address (System Settings)	122
Time Zone (system settings)	123
toner cartridge	42, 43
Transfer Protocol (System Settings)	176, 198
Transmission Report	103
Transmission Report - Undelivered	103
transparency films	291
Tray 5 (Bypass) - Paper Size Defaults	
(System Settings)	128
tray capacity	415, 416, 417
tray type	415, 416, 417
trouble during printing	303
troubleshooting	288
type	410, 413, 414
types of authentication	272
types of mailboxes	278

U

unable to copy	299
unable to print	303
unauthenticated user	272
UNIX	222
Unregistered Forms (System Settings)	172
USB interface	223
USB port	223
User Account Billing Meter	96
User Details Setup (System Settings)	205
User ID (System Settings)	203
User ID Characters (System Settings)	206
User Name (System Settings)	199, 203
using ESC/P-K emulation	425

V

Verify User Details (System Settings)	209
---	-----

W

warm-up time	410
waste toner bottle	42, 45
Web Applications Settings (System Settings) ...	186
web browser	212
WebDAV	248
weight	413
Windows 2000	222
Windows Server 2003	222
Windows Vista	222
Windows XP	222

ApeosPort-II C7500/C6500/C5400, DocuCentre-II C7500/C6500/C5400 Administrator Guide

DE3694E2-1 (Edition 1)

September 2007

Fuji Xerox Co., Ltd.

Copyright © 2007 by Fuji Xerox Co., Ltd.



Before Using the Machine

Paper and Other Media

Maintenance

Job Status

Machine Status

System Settings

Using CentreWare Internet Services

Printer Environment Settings

E-mail Environment Settings

Scanner Environment Settings

Using the Server Fax Service

Security

Authentication and Auditoron
Administration

Problem Solving

Appendix



Edition 1
September 2007
DE3694E2-1
896E53120



Free Manuals Download Website

<http://myh66.com>

<http://usermanuals.us>

<http://www.somanuals.com>

<http://www.4manuals.cc>

<http://www.manual-lib.com>

<http://www.404manual.com>

<http://www.luxmanual.com>

<http://aubethermostatmanual.com>

Golf course search by state

<http://golfingnear.com>

Email search by domain

<http://emailbydomain.com>

Auto manuals search

<http://auto.somanuals.com>

TV manuals search

<http://tv.somanuals.com>