

DocuPrint M385 z
DocuPrint M375 z
DocuPrint M375 df
User Guide

Table of Contents

Before You Use Your Fuji Xerox Machine	8
Definitions of Notes	9
Trademarks	10
Important Note	11
Introduction to Your Fuji Xerox Machine	12
Before Using Your Machine	13
Control Panel Overview	14
Interface Overview	15
Touchscreen LCD Overview	16
How to Navigate the Touchscreen LCD	19
Settings Screen Overview	21
Setting the Home Screen	22
Access Fuji Xerox Utilities (Windows®)	23
Uninstall the Fuji Xerox Software and Drivers (Windows®)	25
Paper Handling	26
Load Paper	27
Load and Print Using the Paper Tray	28
Load and Print Using the Multi-purpose Tray (MP Tray)	35
Paper Settings	43
Change the Paper Size and Paper Type	44
Select the Tray to Be Used For Printing	45
Change the Check Paper Size Setting	46
Change the Tray Size for 2-sided Printing	47
Load Documents	48
Load Documents in the Automatic Document Feeder (ADF)	49
Load Documents on the Scanner Glass	51
Unscannable and Unprintable Areas	52
Using Special Paper	53
Print	54
Print from Your Computer (Windows®)	55
Print a Document (Windows®)	56
Print More Than One Page on a Single Sheet of Paper (N in 1) (Windows®)	58
Print as a Poster (Windows®)	59
Print on Both Sides of the Paper (Windows®)	60
Print as a Booklet (Windows®)	63
Secure Print (Windows®)	65
Use a Macro from Your Computer (Windows®)	66
Use a Preset Print Profile (Windows®)	67
Change the Default Print Settings (Windows®)	70
Print a Document Using the PS3 emulate Printer Driver (Windows®)	72
Monitor the Status of the Machine from Your Computer (Windows®)	73
Print Settings (Windows®)	74
Print from Your Computer (Mac)	78

Print a Document (Mac)	79
Print on Both Sides of the Paper (Mac)	80
Print More Than One Page on a Single Sheet of Paper (N in 1) (Mac)	82
Secure Print (Mac)	83
Monitor the Status of the Machine from Your Computer (Mac)	84
Print Options (Mac)	85
Print One Page Duplicates on Different Types of Paper	90
Cancel a Print Job	91
Test Print	92
Scan	93
Scan Using the Scan Button on Your Fuji Xerox Machine	94
Scan Photos and Graphics	95
Save Scanned Data to a Folder as a PDF File	97
Save Scanned Data to a USB Flash Drive	99
Scan to an Editable Text File (OCR)	101
Scan to Email Attachment	103
Send Scanned Data to an Email Server	105
Scan to FTP	107
Scan to SSH FTP (SFTP)	112
Scan to Network (Windows®)	120
Scan to SharePoint®	126
Web Services for Scanning on Your Network (Windows® 7, Windows® 8 and Windows® 10)	131
Change Scan Button Settings from ControlCenter4 (Windows®)	135
Change Scan Button Settings from iPrint&Scan (Mac)	138
Configure Certificate for Signed PDF	139
Disable Scanning from Your Computer	140
Scan from Your Computer(Windows®)	141
Scan Using ControlCenter4 Home Mode (Windows®)	142
Scan Using ControlCenter4 Advanced Mode (Windows®)	159
Scan Using Nuance™ PaperPort™ 14SE or Other Windows® Applications	176
Scan Using Windows® Photo Gallery or Windows® Fax and Scan	178
Configure Scan Settings Using Web Based Management	182
Set the Scan Job Email Report Using Web Based Management	183
Scan Using iPrint&Scan (Mac)	184
Copy	185
Copy a Document	186
Enlarge or Reduce Copied Images	188
Make N in 1 Copies Using the Page Layout Feature	189
Sort Copies	191
Copy an ID Card	192
Copy on Both Sides of the Paper (2-sided Copy)	193
Copy Options	195
Fax	197
Send a Fax	198
Send a Fax	199
Send a 2-sided Fax from the ADF	201

Send a Fax Manually	202
Send a Fax at the End of a Conversation	203
Send the Same Fax to More than One Recipient (Broadcasting)	204
Send a Fax in Real Time	206
Send a Fax at a Specified Time (Delayed Fax)	207
Add a Cover Page to Your Fax	208
Cancel a Fax in Progress	211
Check and Cancel a Pending Fax	212
Fax Options	213
Receive a Fax	214
Receive Mode Settings	215
Memory Receive (Remote Fax) Options	225
Remote Fax Retrieval	232
Voice Operations and Fax Numbers	238
Voice Operations	239
Store Fax Numbers	242
Set up Groups for Broadcasting	246
Combine Address Book Numbers	250
Telephone Services and External Devices	251
Distinctive Ring	252
FaxAbility	256
External TAD (Telephone Answering Device)	259
External and Extension Telephones	262
Multi-line Connections (PABX)	267
Fax Reports	268
Print a Transmission Verification Report	269
Print a Fax Journal	270
PC-FAX	271
PC-FAX for Windows®	272
PC-FAX for Mac	296
Print Data Directly from a USB Flash Drive	299
Compatible USB Flash Drives	300
Print Data Directly from a USB Flash Drive or Digital Camera Supporting Mass Storage	301
Create a PRN File for Direct Printing (Windows®)	303
Network	304
Get Started	305
Supported Basic Network Features	306
Network Management Software and Utilities	307
Learn about Network Management Software and Utilities	308
Additional Methods of Configuring Your Fuji Xerox Machine for a Wireless Network	309
Before Configuring Your Fuji Xerox Machine for a Wireless Network	310
Configure Your Machine for a Wireless Network	311
Configure Your Machine for a Wireless Network Using the One Push Method of Wi-Fi Protected Setup™ (WPS)	312
Configure Your Machine for a Wireless Network Using the PIN Method of Wi-Fi Protected Setup™ (WPS)	313
Configure Your Machine for a Wireless Network in Ad-Hoc Mode (For IEEE 802.11b/g/n)	316

Configure Your Machine for a Wireless Network Using the Machine's Control Panel Setup Wizard	320
Configure Your Machine for a Wireless Network When the SSID Is Not Broadcast	322
Configure Your Machine for an Enterprise Wireless Network	324
Use Wi-Fi Direct®	327
Advanced Network Features	337
Print the Network Configuration Report	338
Configure Your Mail Server Settings Using Web Based Management	339
Configure the Fuji Xerox Machine for Email or Internet Fax (I-Fax)	342
I-Fax Options	357
Use the Send Fax to Server Feature	362
Print the WLAN Report	366
Configure and Operate LDAP Search	369
Synchronize Time with the SNTP Server Using Web Based Management	372
Technical Information for Advanced Users	376
Gigabit Ethernet (Wired Network Only)	377
Reset the Network Settings to the Factory Settings	379
Security	380
Lock the Machine Settings	381
About Using Setting Lock	382
Network Security Features	386
Before Using Network Security Features	387
Secure Function Lock 3.0	388
Use Active Directory® Authentication	394
Use LDAP Authentication	399
Manage Your Network Machine Securely Using SSL/TLS	403
Manage Your Network Machine Securely Using IPsec	435
Send or Receive an Email Securely	453
Use IEEE 802.1x Authentication for a Wired or a Wireless Network	460
Store Print Log to Network	465
Mobile	471
Google Cloud Print	472
Google Cloud Print Overview	473
Before Using Google Cloud Print	474
Print from Google Chrome™ or Chrome OS™	478
Print from Google Drive™ for Mobile	479
Print from Gmail™ Webmail Service for Mobile	480
Mobile Printing for Windows®	481
Mopria® Print Service	482
Print Utility	483
ControlCenter	484
ControlCenter4 (Windows®)	485
Change the Operation Mode in ControlCenter4 (Windows®)	486
Scan Using ControlCenter4 Home Mode (Windows®)	488
Scan Using ControlCenter4 Advanced Mode (Windows®)	489
Set Up the Fuji Xerox Machine Using ControlCenter4 (Windows®)	490
Create a Custom Tab Using ControlCenter4 Advanced Mode (Windows®)	492

iPrint&Scan for Mac	494
iPrint&Scan Overview	495
Troubleshooting	496
Error and Maintenance Messages	497
Transfer Your Faxes or Fax Journal Report	503
Document Jams	507
Document is Jammed in the Top of the ADF Unit	508
Document is Jammed under the Document Cover	509
Remove Small Scraps of Paper Jammed in the ADF	510
Paper Jams	511
Paper is Jammed in the MP tray	512
Paper is Jammed in the Paper Tray	513
Paper is Jammed in the Back of the Machine	515
Paper is Jammed inside the Machine	517
Paper is Jammed in the 2-sided Tray	519
Printing Problems	522
Improve the Print Quality	525
Telephone and Fax Problems	530
Set Dial Tone Detection	533
Set Telephone Line Compatibility for Interference and VoIP Systems	534
Network Problems	535
Error Messages	536
Use the Network Connection Repair Tool (Windows®)	538
Where Can I Find My Fuji Xerox Machine's Network Settings?	539
I Cannot Complete the Wireless Network Setup Configuration	540
My Fuji Xerox Machine Cannot Print, Scan, or PC-FAX Receive over the Network	542
I Want to Check that My Network Devices are Working Correctly	544
Google Cloud Print Problems	545
Other Problems	546
Check the Machine Information	548
Reset Your Fuji Xerox Machine	549
Reset Functions Overview	550
Routine Maintenance	551
Replace Supplies	552
Replace the Toner Cartridge	554
Replace the Drum Cartridge	557
Clean the Machine	560
Clean the Scanner	562
Clean the Touchscreen LCD	563
Clean the Corona Wire	564
Clean the Drum Cartridge	566
Clean the Paper Pick-up Rollers	570
Check the Remaining Life of Parts	572
Replace Periodic Maintenance Parts	573
Machine Settings	574
Change Machine Settings from the Control Panel	575







In the Event of Power Failure (Memory Storage)	576
General Settings	577
Save Your Favourite Settings as a Shortcut	595
Print Reports	598
Settings and Features Tables	601
Change Machine Settings from Your Computer	620
Change Machine Settings Using Web Based Management	621
Change the Machine Settings Using Remote Setup	626
Appendix	633
Specifications	634
How to Enter Text on Your Fuji Xerox Machine	642
Supplies	643
Accessories	644
Contacting Fuji Xerox	645
New Zealand FAX Modem Statements	646

Before You Use Your Fuji Xerox Machine

- [Definitions of Notes](#)
- [Trademarks](#)
- [Important Note](#)

Definitions of Notes

We use the following symbols and conventions throughout this User's Guide:

 WARNING	WARNING indicates a potentially hazardous situation which, if not avoided, could result in death or serious injuries.
 CAUTION	CAUTION indicates a potentially hazardous situation which, if not avoided, may result in minor or moderate injuries.
IMPORTANT	IMPORTANT indicates a potentially hazardous situation which, if not avoided, may result in damage to property or loss of product functionality.
NOTE	NOTE specifies the operating environment, conditions for installation, or special conditions of use.
	Tips icons indicate helpful hints and supplementary information.
	Electrical Hazard icons alert you to possible electrical shock.
	Fire Hazard icons alert you to the possibility of a fire.
	Hot Surface icons warn you not to touch hot machine parts.
	Prohibition icons indicate actions you must not perform.
Bold	Bold style identifies buttons on the machine's control panel or computer screen.
<i>Italics</i>	Italicised style emphasises an important point or refers you to a related topic.
Courier New	Courier New font identifies messages shown on the machine's LCD.



Related Information

- [Before You Use Your Fuji Xerox Machine](#)

Trademarks

Microsoft, Windows, Windows Server, SharePoint, Internet Explorer, Outlook, PowerPoint, Active Directory, OneNote, Windows phone and OneDrive are either registered trademarks or trademarks of Microsoft Corporation in the United States and/or other countries.

Apple, Mac, macOS, Safari, iPad, iPhone and iPod touch are trademarks of Apple Inc., registered in the United States and other countries.

Nuance and PaperPort are trademarks or registered trademarks of Nuance Communications, Inc. or its affiliates in the United States and/or other countries.

Wi-Fi CERTIFIED, Wi-Fi, Wi-Fi Alliance, Wi-Fi Direct and Wi-Fi Protected Access are registered trademarks of Wi-Fi Alliance®.

WPA, WPA2, Wi-Fi Protected Setup and Wi-Fi Protected Setup logo are trademarks of Wi-Fi Alliance®.

Flickr is a registered trademark of Yahoo! Inc.

Android, Google Cloud Print, Google Drive, Google Play, Picasa Web Albums and Google Chrome are trademarks of Google Inc. Use of these trademarks is subject to Google Permissions.

Mopria is a trademark of Mopria Alliance, Inc.

UNIX is a registered trademark of The Open Group in the United States and other countries.

Linux is the registered trademark of Linus Torvalds in the U.S. and other countries.

Intel is a trademark of Intel Corporation in the U.S. and/or other countries.

Evernote is a trademark of Evernote Corporation and used under a license.

All product/brand names are trademarks or registered trademarks of the respective holders.

Each company whose software title is mentioned in this manual has a Software License Agreement specific to its proprietary programs.

Microsoft product screen shot(s) reprinted with permission from Microsoft Corporation.

Xerox, Xerox and Design, as well as Fuji Xerox and Design are registered trademarks or trademarks of Xerox Corporation in Japan and/or other countries.



Related Information

- [Before You Use Your Fuji Xerox Machine](#)

Important Note

- Do not use this product outside the country of purchase as it may violate the wireless telecommunication and power regulations of that country.
- Windows® 10 in this document represents Windows® 10 Home, Windows® 10 Pro, Windows® 10 Education and Windows® 10 Enterprise.
- Windows Server® 2008 in this document represents Windows Server® 2008 and Windows Server® 2008 R2.
- The screens in this User's Guide are for illustration purposes only and may differ from the actual screens.
- Unless otherwise specified, the screens in this manual are from Windows® 7 and macOS v10.13.x. Screens on your computer may vary depending on your operating system.
- The contents of this guide and the specifications of this product are subject to change without notice.
- Not all features are available in countries subject to applicable export restrictions.



Related Information

- [Before You Use Your Fuji Xerox Machine](#)
-

Introduction to Your Fuji Xerox Machine

- [Before Using Your Machine](#)
- [Control Panel Overview](#)
- [Interface Overview](#)
- [Touchscreen LCD Overview](#)
- [How to Navigate the Touchscreen LCD](#)
- [Settings Screen Overview](#)
- [Setting the Home Screen](#)
- [Access Fuji Xerox Utilities \(Windows®\)](#)

Before Using Your Machine

Before attempting any printing operation, confirm the following:

- Make sure you have installed the Fuji Xerox software and drivers.
- For USB or network cable users: Make sure the interface cable is physically secure.

Simultaneous printing, scanning and faxing

Your machine can print from your computer while sending or receiving a fax into memory or while scanning a document into the computer. Fax sending will not be stopped during printing from your computer. However, when the machine is copying or receiving a fax on paper, it pauses the printing operation, and then continues printing when copying or fax receiving has finished.

Firewall (Windows®)

If your computer is protected by a firewall and you are unable to network print, network scan, or PC-FAX, you may need to configure the firewall settings. If you are using the Windows® Firewall and you installed the Fuji Xerox software and drivers from the Fuji Xerox installation disc, the necessary firewall settings have already been set. If you are using any other personal firewall software, see the User's Guide for your software or contact the software manufacturer.



Related Information

- [Introduction to Your Fuji Xerox Machine](#)

Control Panel Overview



1. Touchscreen Liquid Crystal Display (LCD)

Access menus and options by pressing them on the touchscreen.

2. Touchpanel



(Back)

Press to go back to the previous menu.



(Home)

- Press to return to the Home screen.
- While the machine is in Sleep Mode, the Home icon blinks.





(Cancel)

Press to cancel an operation (available when lit).

Dial Pad (Numerical buttons)

Press the numbers on the touchpanel to dial telephone or fax numbers and to enter the number of copies.

3. Power On/Off

- Turn the machine on by pressing .
- Turn the machine off by pressing and holding down . The LCD displays [Shutting Down] for a few seconds before going off. If you have an external telephone or TAD connected, it is always available.

4. (Wi-Fi) (DocuPrint M385 z/DocuPrint M375 z)

(For infrastructure mode)

When the **Wi-Fi** light is on, your Fuji Xerox machine is connected to a wireless access point. When the **Wi-Fi** light blinks, the wireless connection is down, or your machine is in the process of connecting to a wireless access point.

(For Ad-Hoc mode)

The **Wi-Fi** LED is always off.



Related Information

- [Introduction to Your Fuji Xerox Machine](#)

Interface Overview

The available connection interfaces vary depending on the model.

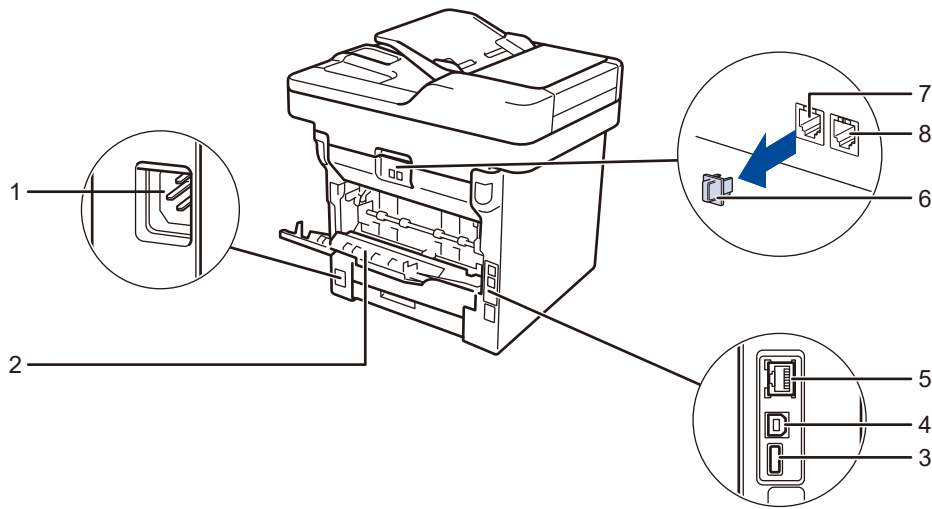

1. AC Power Connector
2. Back Cover (Output Tray)
3. USB Accessory Port (DocuPrint M385 z)
4. USB Port
Connects a USB cable for printing.
5. Network Port
Connects to a network cable.
6. Phone Connector CAP
7. Phone Connector
Enables you to connect the device to a telephone device.
Do not connect any device (fax system) other than a telephone.
8. Wall Jack Connector
Use this connector to connect to a telephone line.



Related Information

- [Introduction to Your Fuji Xerox Machine](#)

Touchscreen LCD Overview

You can select from two types of screens to set the Home screen: Function screens and Shortcuts screen. When a Function screen is displayed, swipe left or right or press ◀ or ▶ to display the other Function screens.

The Home screen displays the machine's status when the machine is idle. This screen is also called the Ready Mode screen. When displayed, this screen indicates that your machine is ready for the next command.

If Active Directory® Authentication or LDAP Authentication is enabled, the machine's control panel will be locked.

The available features vary depending on your model.

Function screens

The Function screens provide access to features, such as Fax, Copy and Scan.

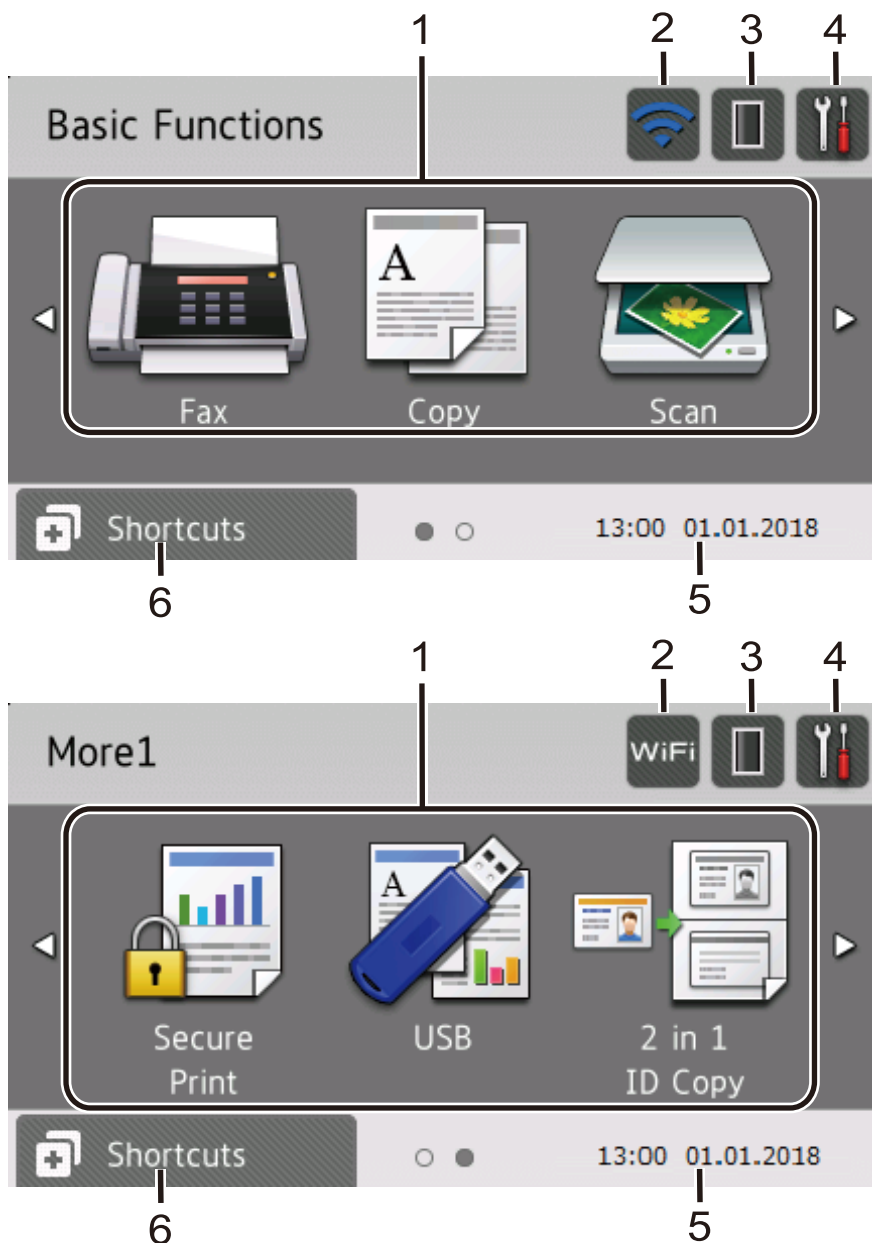





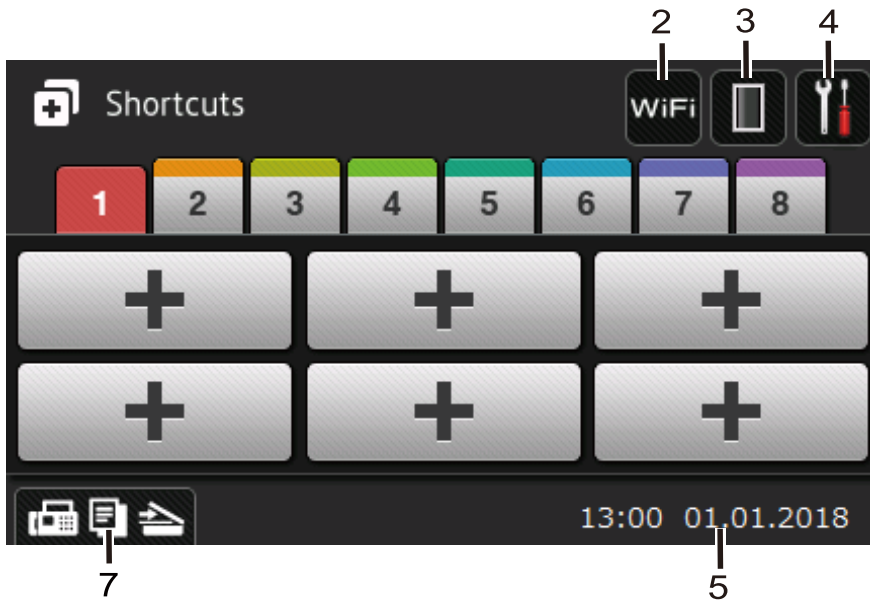

Shortcuts screen

Create Shortcuts for frequently-used operations, such as sending a fax, making a copy and scanning.

 Eight Shortcuts tabs are available with six Shortcuts on each Shortcuts tab. A total of 48 Shortcuts are available.



1. Modes

-  [Fax]
Press to access Fax mode.
-  [Copy]
Press to access Copy mode.
-  [Scan]
Press to access Scan mode.
-  [Secure Print]
Press to access the [Secure Print] option.
-  [USB]
Press to access the Direct Print and Scan to USB menus.
-  [2 in 1 ID Copy]
Press to access the 2 in 1 ID Copy option.

2. or (Wireless Status)

Press to configure wireless settings.

If you are using a wireless connection, a four-level indicator displays the current wireless signal strength.



3. (Toner)

Displays the remaining toner cartridge life. Press to access the [Toner] menu.



4. (Settings)

Press to access the [Settings] menu.

If Setting Lock has been turned on, a lock  icon appears on the LCD. You must unlock the machine to change settings.

5. Date & Time

Displays the date and time set on the machine.

6.  [Shortcuts]
Press to access the [Shortcuts] screen.
7.  (Function screens)
Press to access the Function screens.

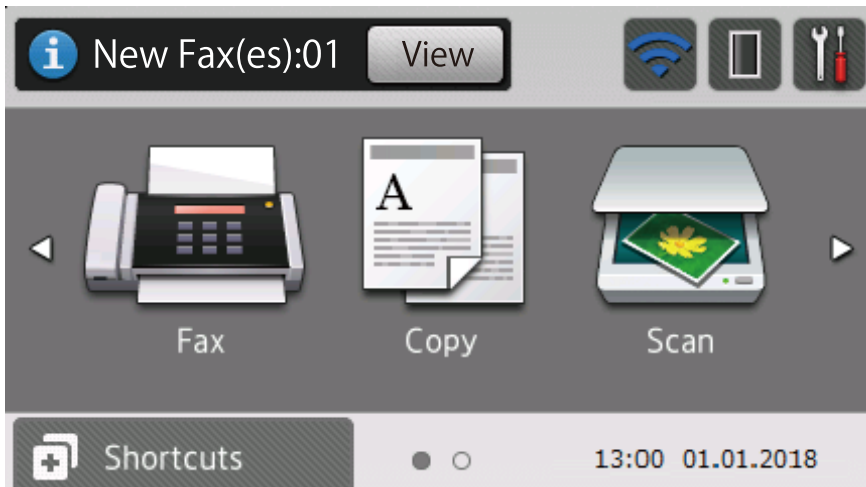

New Fax

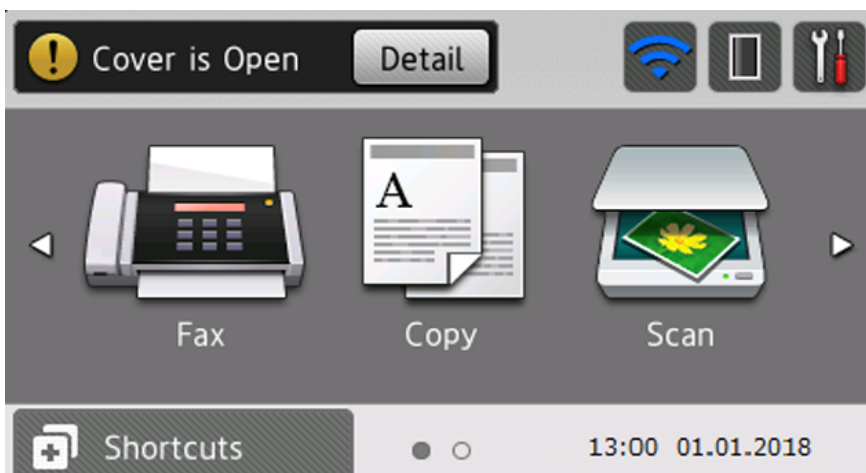

When [Fax Preview] is set to [On], the number of new faxes you received into the memory appears at the top of the screen.

Warning icon



The warning icon  appears when there is an error or maintenance message; press  to view it, and then press  to return to Ready Mode.

NOTE

This product adopts the font of ARPHIC TECHNOLOGY CO., LTD.

Related Information

- [Introduction to Your Fuji Xerox Machine](#)

How to Navigate the Touchscreen LCD

Press your finger on the LCD to operate it. To display and access all the options, swipe left, right, up, down or press ◀▶ or ▲▼ on the LCD to scroll through them.

The following steps explain how to change a machine setting. In this example, the LCD Backlight setting is changed from [Light] to [Med].

IMPORTANT

DO NOT press the LCD with a sharp object, such as a pen or stylus. It may damage the machine.

NOTE

DO NOT touch the LCD immediately after plugging in the power cord or turning on the machine. Doing this may cause an error.

1. Press  [Settings].
2. Press [All Settings].
3. Swipe up or down or press ▲ or ▼ to display the [General Setup] option, and then press [General Setup].

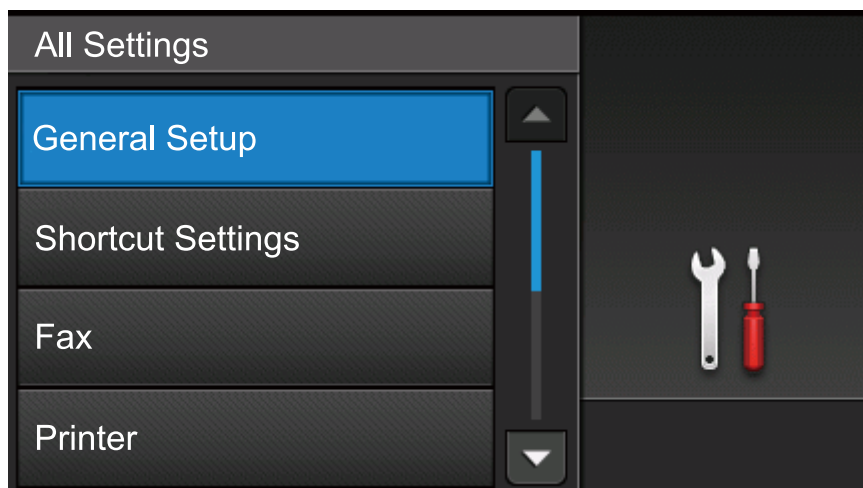

4. Swipe up or down or press ▲ or ▼ to display the [LCD Settings] option, and then press [LCD Settings].

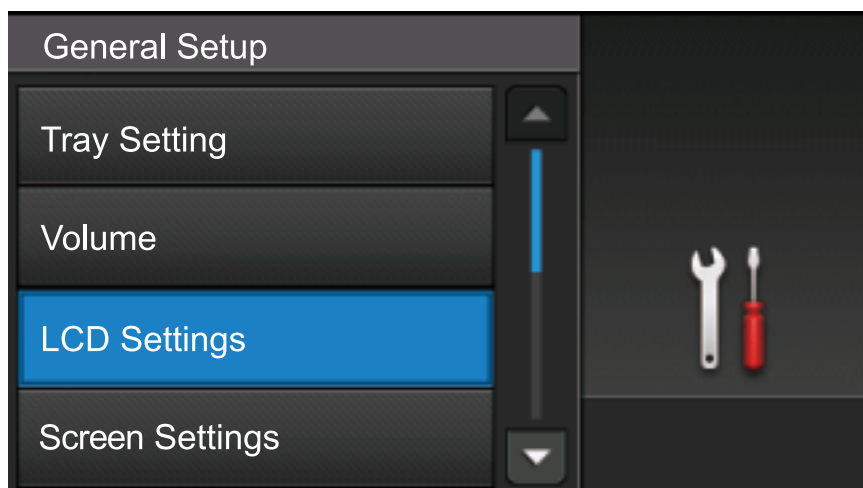

5. Press [Backlight].

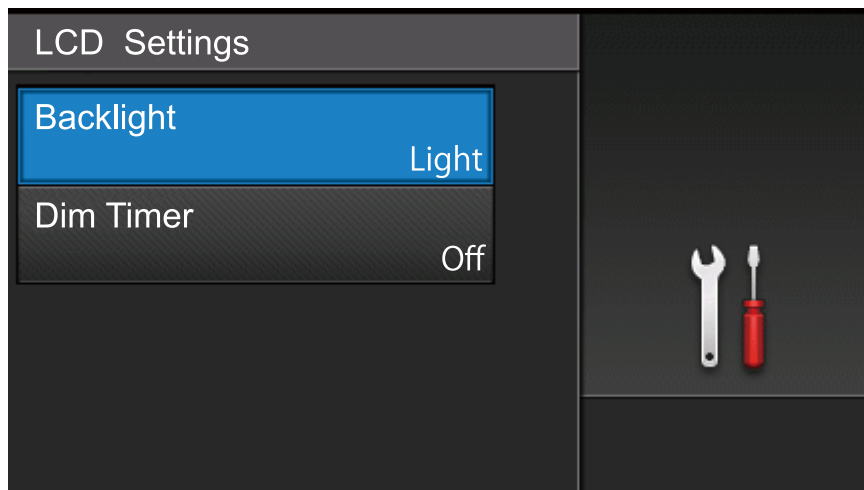

6. Press [Med].

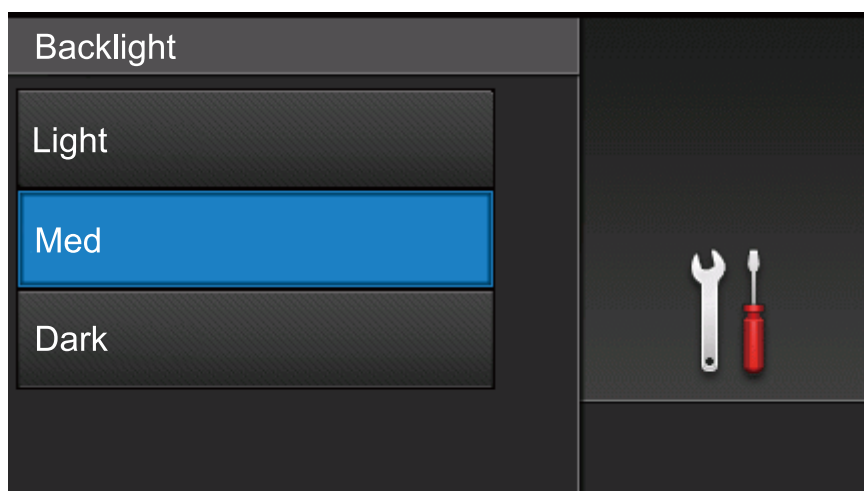

7. Press .



Related Information

- [Introduction to Your Fuji Xerox Machine](#)

Settings Screen Overview

Press  to view the current machine status on the LCD.

Use the Settings menu to access all of your Fuji Xerox machine's settings.

The available features vary depending on your model.

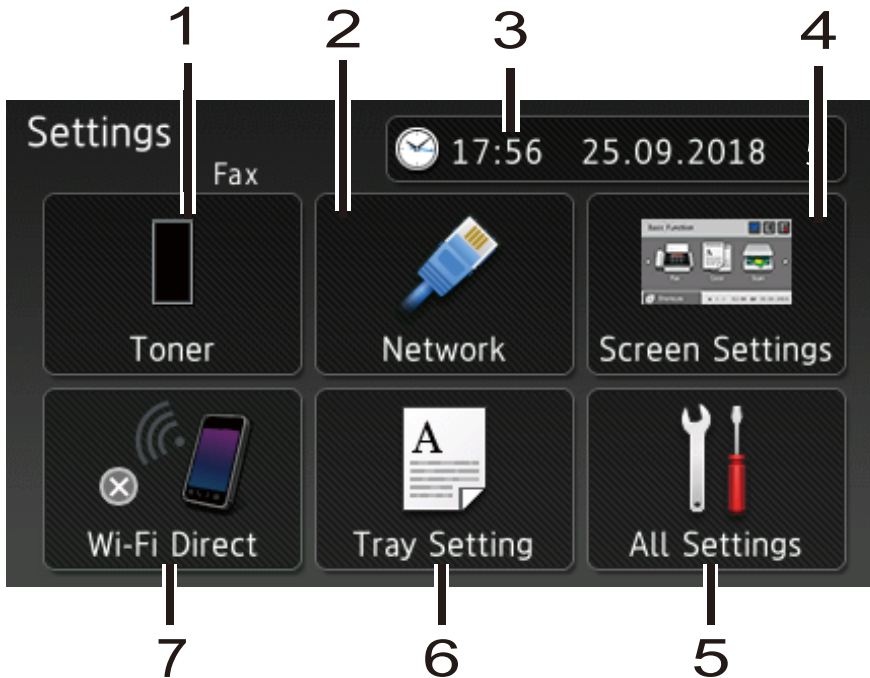

1. Toner

- Displays the remaining toner cartridge life.
- Press to access the [Toner] menu.

2. Network (For wired network models)

- Press to set up a network connection.
- A four level indicator on the screen displays the current wireless signal strength if you are using a wireless connection.

3. Date & Time

Displays the date and time set on the machine.

Press to access the [Date & Time] menu.

4. Screen Settings

Press to access the [Screen Settings] menu.

5. All Settings

Press to access a menu of all machine settings.

6. Tray Setting

Press to change the paper size and paper type settings.

7. Wi-Fi Direct (For DocuPrint M385 z/DocuPrint M375 z)

Press to set up a Wi-Fi Direct network connection.

Fax Preview (For DocuPrint M375 df)

- Display the Fax Preview status.
- Press to access the Fax Preview setting.





Related Information

- [Introduction to Your Fuji Xerox Machine](#)

Setting the Home Screen

Set the Home screen to either [Basic Functions], [More1], [More2], [Shortcuts 1], [Shortcuts 2], [Shortcuts 3], [Shortcuts 4], [Shortcuts 5], [Shortcuts 6], [Shortcuts 7] or [Shortcuts 8].

When the machine is idle or you press , the touchscreen will return to the screen you set.

1. Press  [Settings] > [Screen Settings] > [Home Screen].
2. Swipe up or down or press ▲ or ▼ to display the screen settings, and then press the setting you want.
3. Press .

The machine will go to your chosen Home screen.



Related Information

- [Introduction to Your Fuji Xerox Machine](#)

Access Fuji Xerox Utilities (Windows®)

Fuji Xerox Utilities is an application launcher that offers convenient access to all Fuji Xerox applications installed on your computer.

1. Do one of the following:

- (Windows® 7)

Click  (**Start**) > **All Programs** > **Fuji Xerox** > **Fuji Xerox Utilities**.

- (Windows® 8)

Tap or click  (**Fuji Xerox Utilities**) either on the **Start** screen or the desktop.

- (Windows® 8.1)

Move your mouse to the lower left corner of the **Start** screen and click  (if you are using a touch-based device, swipe up from the bottom of the **Start** screen to bring up the **Apps** screen).

When the **Apps** screen appears, tap or click  (**Fuji Xerox Utilities**).

- (Windows® 10)

Click  > **Fuji Xerox** > **Fuji Xerox Utilities**.

2. Select your machine (where XXXXX is the name of your model).

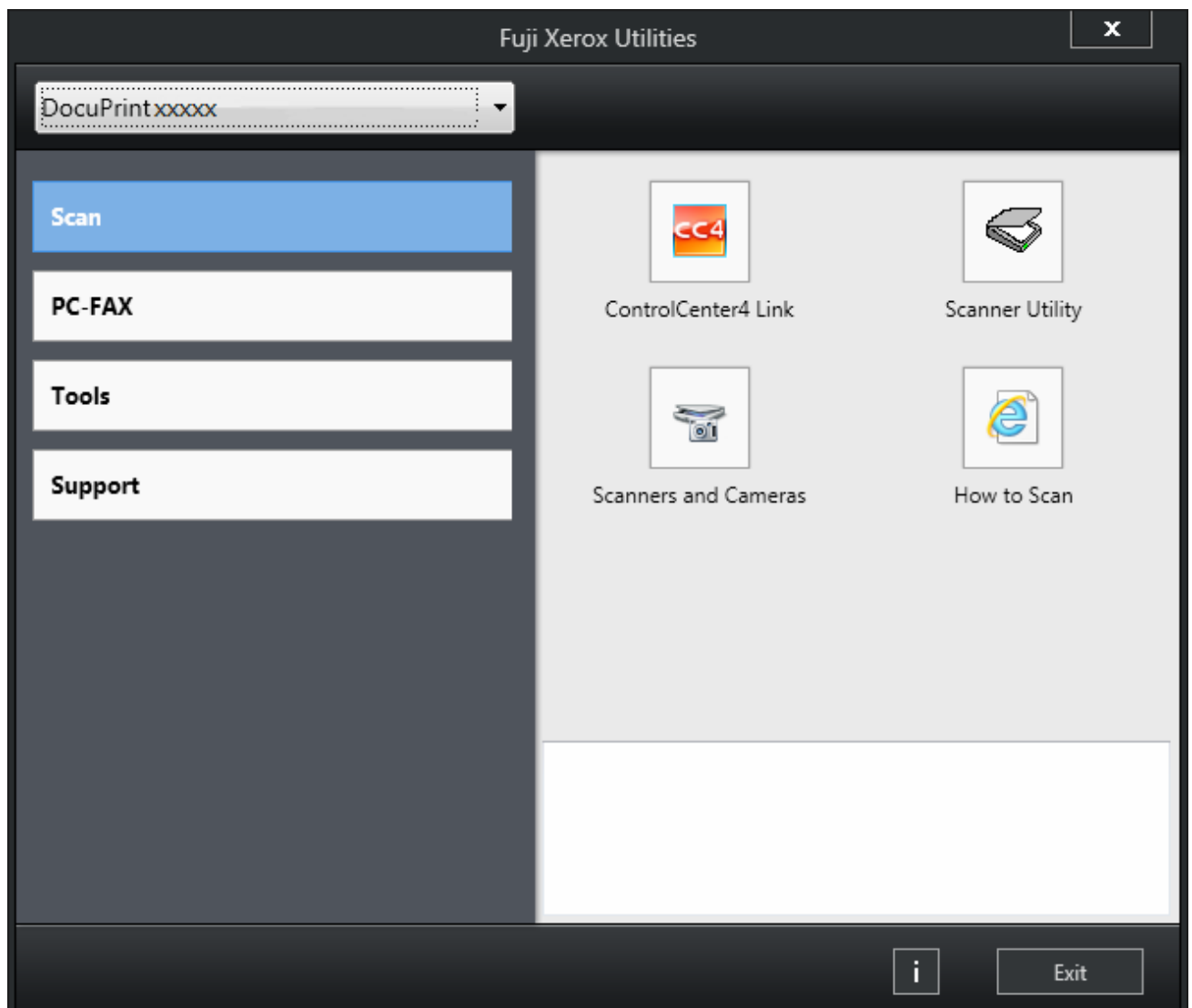

3. Choose the operation you want to use.



Related Information

- [Introduction to Your Fuji Xerox Machine](#)
 - [Uninstall the Fuji Xerox Software and Drivers \(Windows®\)](#)
-

Uninstall the Fuji Xerox Software and Drivers (Windows®)

1. Do one of the following:

- (Windows® 7)

Click  (**Start**) > **All Programs** > **Fuji Xerox** > **Fuji Xerox Utilities**.

- (Windows® 8)

Tap or click  (**Fuji Xerox Utilities**) either on the **Start** screen or the desktop.

- (Windows® 8.1)

Move your mouse to the lower left corner of the **Start** screen and click  (if you are using a touch-based device, swipe up from the bottom of the **Start** screen to bring up the **Apps** screen).

When the **Apps** screen appears, tap or click  (**Fuji Xerox Utilities**).

- (Windows® 10)

Click  > **Fuji Xerox** > **Fuji Xerox Utilities**.

2. Click the drop-down list, and then select your model name (if not already selected). Click **Tools** in the left navigation bar, and then click **Uninstall**.

Follow the instructions in the dialog box to uninstall the software and drivers.



Related Information

- [Access Fuji Xerox Utilities \(Windows®\)](#)

Paper Handling

- [Load Paper](#)
- [Paper Settings](#)
- [Change the Tray Size for 2-sided Printing](#)
- [Load Documents](#)
- [Unscannable and Unprintable Areas](#)
- [Using Special Paper](#)

Load Paper

- [Load and Print Using the Paper Tray](#)
- [Load and Print Using the Multi-purpose Tray \(MP Tray\)](#)

Load and Print Using the Paper Tray

- [Load Plain Paper, Letterhead, Coloured Paper, Thin Paper and Recycled Paper in the Paper Tray](#)
- [Load Thick Paper in the Paper Tray](#)
- [Printing Problems](#)
- [Error and Maintenance Messages](#)

Load Plain Paper, Letterhead, Coloured Paper, Thin Paper and Recycled Paper in the Paper Tray

- If the Check Size setting is set to On and you pull the paper tray out of the machine, a message appears on the LCD asking if you want to change the paper size and paper type. Change the paper size and paper type settings if needed, following the LCD instructions.
- When you load a different size and type of paper in the tray, you must change the Paper Size and Paper Type settings in the machine or on your computer, also.

1. Pull the paper tray completely out of the machine.

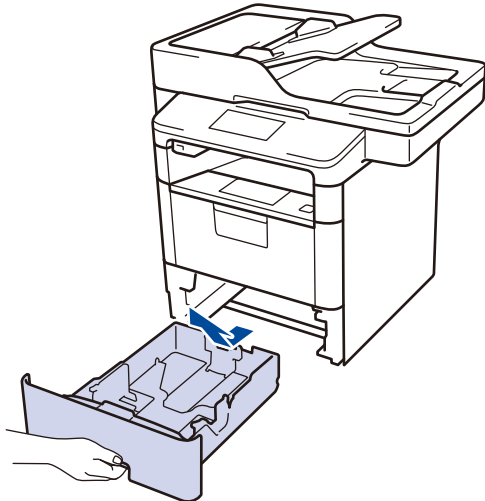

2. Press and slide the paper guides to fit the paper.
Press the green release levers to slide the paper guides.

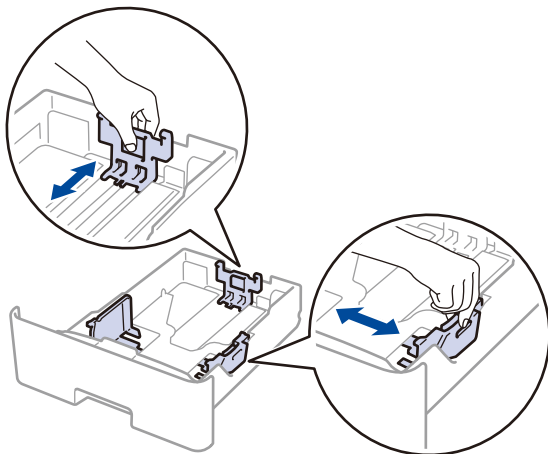



For Legal or Folio size paper, press the release button (1) in the bottom of the paper tray or the release lever (2) in the back of the tray, and then pull out the back of the paper tray. (Legal and Folio size paper are not available in some regions.)

For trays with a release button:

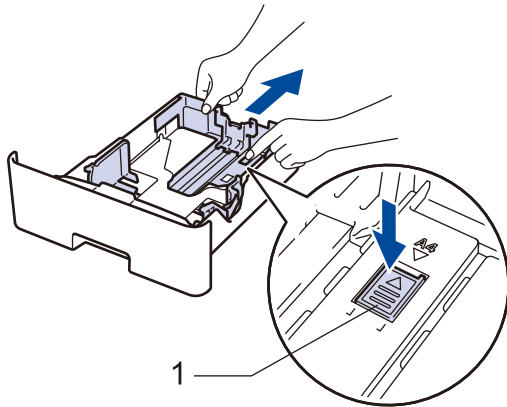

For trays with a release lever:

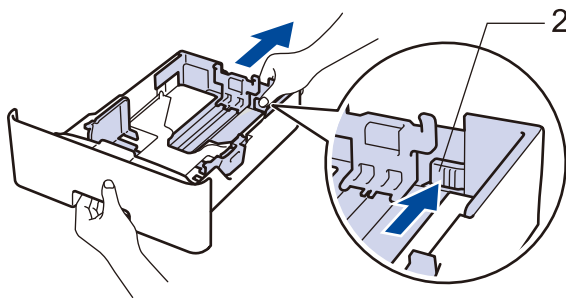

3. Fan the stack of paper well.

4. Load paper in the paper tray with the printing surface *face down*.

When you use Letterhead or Preprinted paper, load the paper in the correct orientation as shown in the illustrations.

Paper Orientation for Letterhead and Preprinted Paper

For 1-sided printing

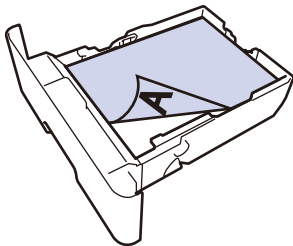

- face down
- top edge toward the front of the paper tray

For automatic 2-sided printing (long edge binding)

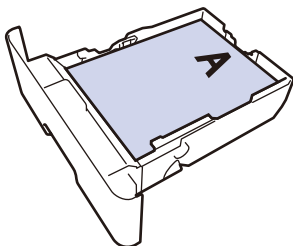

- face up
- bottom edge toward the front of the paper tray



- DO NOT load different sizes and types of paper in the paper tray at the same time. Doing this may cause the paper to jam or misfeed.
- When you use Letterhead or Preprinted paper for 2-sided printing, change the machine's setting by completing the following step:
 - Press  [Settings] > [All Settings] > [Printer] > [2-sided] > [Single Image] > [2-sided Feed].

5. Make sure the paper is below the maximum paper mark (▼ ▼ ▼).
Overfilling the paper tray will cause paper jams.

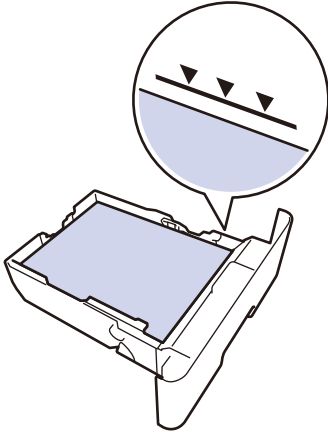

6. Slowly push the paper tray completely into the machine.
7. Lift the support flap to prevent paper from sliding off the output tray.



Related Information

- [Load and Print Using the Paper Tray](#)

Load Thick Paper in the Paper Tray

- If the Check Size setting is set to On and you pull the paper tray out of the machine, a message appears on the LCD asking if you want to change the paper size and paper type. Change the paper size and paper type settings if needed, following the LCD instructions.
- When you load a different size and type of paper in the tray, you must change the Paper Size and Paper Type settings in the machine or on your computer, also.

1. Pull the paper tray completely out of the machine.

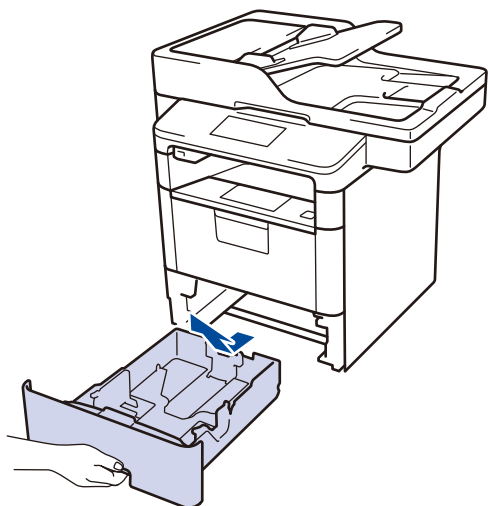

2. Press and slide the paper guides to fit the paper.
Press the green release levers to slide the paper guides.

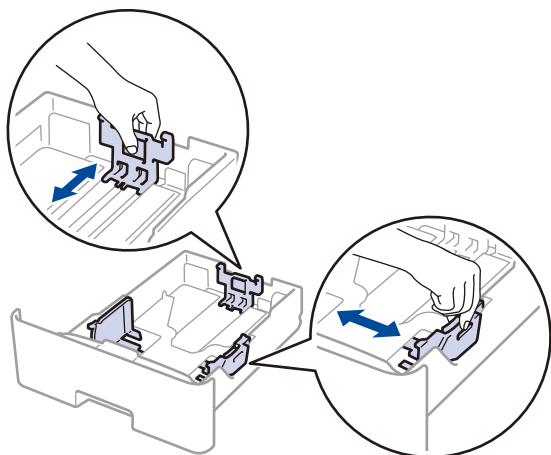



For Legal or Folio size paper, press the release button (1) in the bottom of the paper tray or the release lever (2) in the back of the tray, and then pull out the back of the paper tray. (Legal and Folio size paper are not available in some regions.)

For trays with a release button:

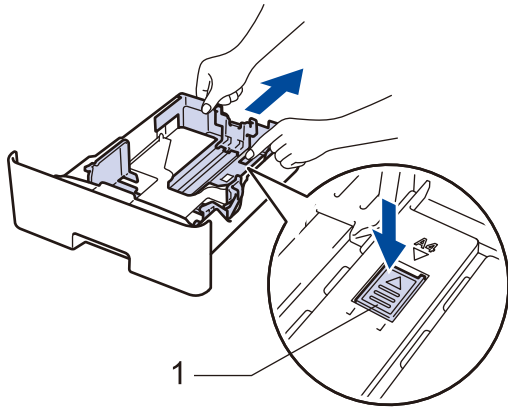

For trays with a release lever:

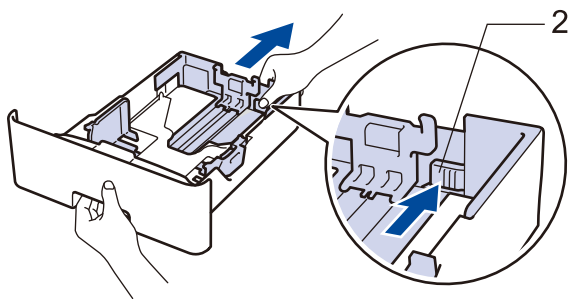

-
3. Fan the stack of paper well.
 4. Load paper in the paper tray with the printing surface *face down*.



DO NOT load different sizes and types of paper in the paper tray at the same time. Doing this may cause the paper to jam or misfeed.

5. Make sure the paper is below the maximum paper mark (▼ ▼ ▼).
Overfilling the paper tray will cause paper jams.

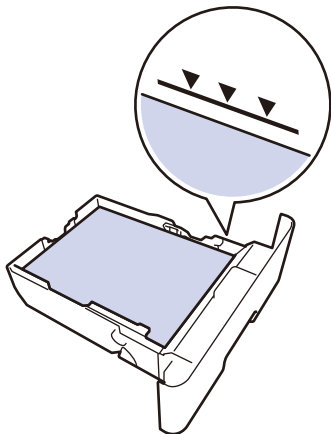

6. Slowly push the paper tray completely into the machine.
7. Open the machine's back cover (the face up output tray).

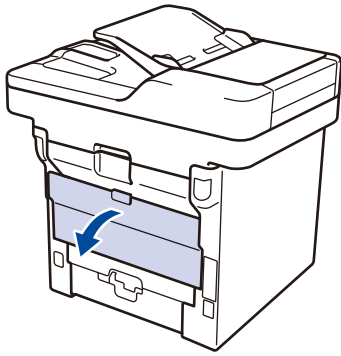

8. Open the paper stopper (Available only for certain models).

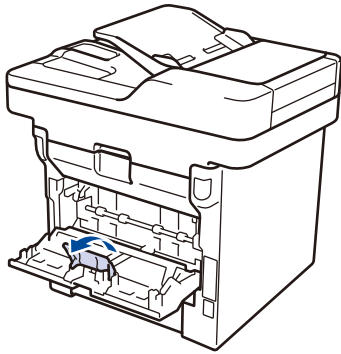

9. Send your print job to the machine.



Change your print preferences in the Print dialog box before sending the print job from your computer.

10. Close the paper stopper (Available only for certain models).

11. Close the back cover (the face up output tray) until it locks in the closed position.



Related Information

- [Load and Print Using the Paper Tray](#)
-

Load and Print Using the Multi-purpose Tray (MP Tray)

You can load up to ten envelopes, letterhead, coloured paper, thin paper, thick paper, thicker paper, recycled paper, Bond paper, labels, or up to 50 sheets of plain paper in the MP tray.

- [Load Paper in the Multi-purpose Tray \(MP Tray\)](#)
- [Load and Print Thick Paper and Labels Using the MP Tray](#)
- [Load and Print on Envelopes Using the MP Tray](#)
- [Printing Problems](#)
- [Error and Maintenance Messages](#)

Load Paper in the Multi-purpose Tray (MP Tray)

When you load a different size and type of paper in the tray, you must change the Paper Size and Paper Type settings in the machine or on your computer, also.

1. Lift the support flap to prevent paper from sliding off the face down output tray.



2. Open the MP tray and lower it gently.

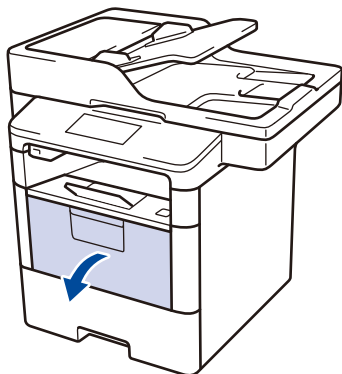

3. Pull out the MP tray support (1) and unfold the flap (2).



4. Slide the MP tray paper guides to fit the width of the paper you are using. If the paper guide on the right side has a lever, press it and slide the paper guide.



5. Load paper with the printing surface *face up* in the MP tray. When you use Letterhead or Preprinted paper, load the paper in the correct orientation as shown in the illustrations.

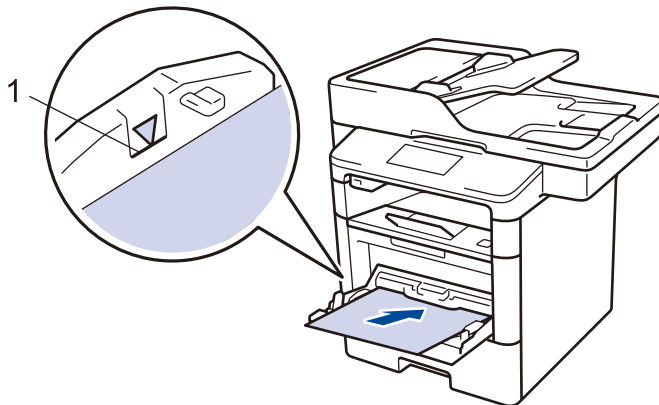

Make sure the paper is below the maximum paper mark (1).

Paper Orientation for Letterhead and Preprinted Paper

For 1-sided printing

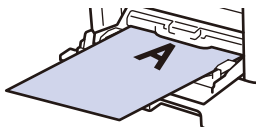

- face up
- top edge first

For automatic 2-sided printing (long edge binding)

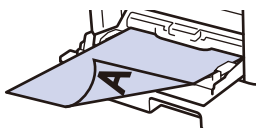

- face down
- bottom edge first



When you use Letterhead or Preprinted paper for 2-sided printing, change the machine's setting by completing the following step:

- Press  [Settings] > [All Settings] > [Printer] > [2-sided] > [Single Image] > [2-sided Feed].



Related Information

- [Load and Print Using the Multi-purpose Tray \(MP Tray\)](#)

Load and Print Thick Paper and Labels Using the MP Tray

When the back cover (face up output tray) is pulled down, the machine has a straight paper path from the MP tray through to the back of the machine. Use this paper feed and output method when you print on thick paper or labels.

When you load a different size and type of paper in the tray, you must change the Paper Size and Paper Type settings in the machine or on your computer, also.

1. Open the machine's back cover (the face up output tray).

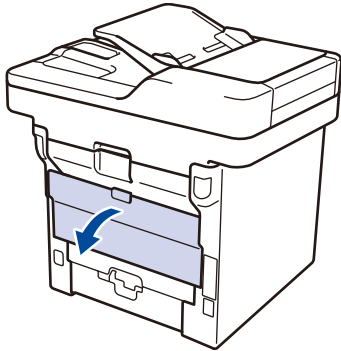

2. Open the paper stopper (Available only for certain models).

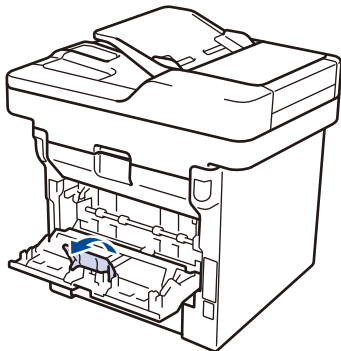

3. On the front of the machine, open the MP tray and lower it gently.

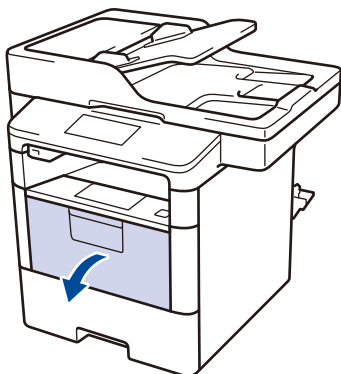

4. Pull out the MP tray support (1) and unfold the flap (2).



5. Slide the MP tray paper guides to fit the width of the paper that you are using. If the paper guide on the right side has a lever, press it and slide the paper guide.



6. Load paper or labels in the MP tray.

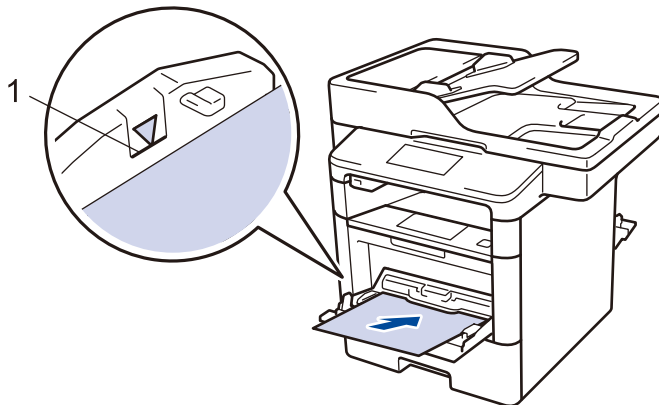

- Make sure the paper is below the maximum paper mark (1).
- Load paper into the MP tray with the printing surface face up.

7. Send your print job to the machine.



Change your print preferences in the Print screen before sending the print job from your computer.

8. Close the paper stopper (Available only for certain models).
9. Close the back cover (the face up output tray) until it locks in the closed position.



Related Information

- [Load and Print Using the Multi-purpose Tray \(MP Tray\)](#)

Load and Print on Envelopes Using the MP Tray

- You can load up to ten envelopes in the MP tray.
- Before loading, press the corners and sides of the envelopes to make them as flat as possible.

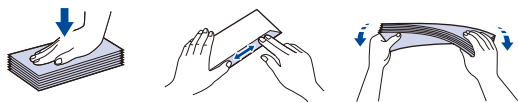

- When you load a different size and type of paper in the tray, you must change the Paper Size and Paper Type settings in the machine or on your computer, also.

1. Open the machine's back cover (the face up output tray).

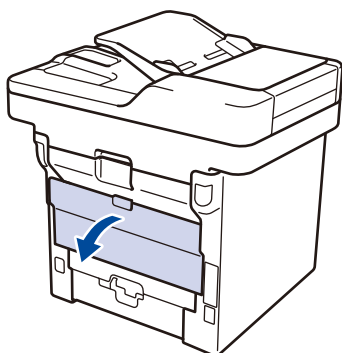

2. Open the paper stopper (Available only for certain models).

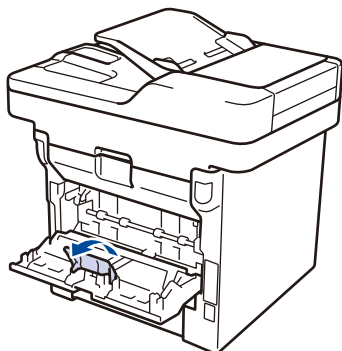

3. On the front of the machine, open the MP tray and lower it gently.

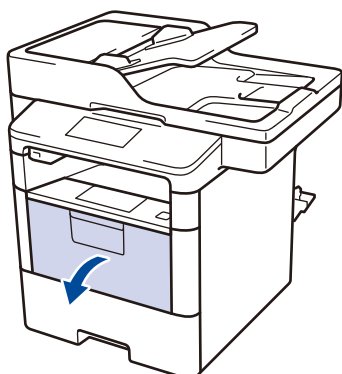

4. Pull out the MP tray support (1) and unfold the flap (2).



5. Slide the MP tray paper guides to fit the width of the envelopes that you are using. If the paper guide on the right side has a lever, press it and slide the paper guide.



6. Load envelopes in the MP tray.

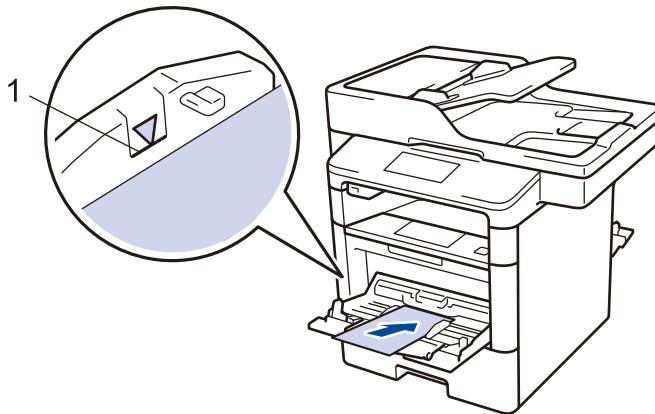

Load up to 10 envelopes in the MP tray with the printing surface face up. Make sure the envelopes are below the maximum paper mark (1). Loading more than 10 envelopes may cause paper jams.

7. Send your print job to the machine.



Change your print preferences in the Print dialog box before sending the print job from your computer.

Settings	Options for Envelopes
Paper Size	Com-10 DL C5 Monarch
Media Type	Envelopes Env. Thick Env. Thin

-
8. Close the paper stopper (Available only for certain models).
 9. Close the back cover (the face up output tray) until it locks in the closed position.



Related Information



- [Load and Print Using the Multi-purpose Tray \(MP Tray\)](#)
-

Paper Settings

- [Change the Paper Size and Paper Type](#)
- [Select the Tray to Be Used For Printing](#)
- [Change the Check Paper Size Setting](#)

Change the Paper Size and Paper Type

When you change the size and type of the paper you load in the tray, you must change the Paper Size and Paper Type settings on the LCD at the same time.

1. Press  [Settings] > [All Settings] > [General Setup] > [Tray Setting] > [Paper Type].
2. Swipe up or down or press ▲ or ▼ to display the paper tray options, and then press the option you want.
3. Swipe up or down or press ▲ or ▼ to display the paper type options, and then press the option you want.
4. Press .
5. Swipe up or down or press ▲ or ▼ to display the [Paper Size] option, and then press [Paper Size].
6. Swipe up or down or press ▲ or ▼ to display the paper tray options, and then press the option you want.
7. Swipe up or down or press ▲ or ▼ to display the paper size options, and then press the option you want.
8. Press .





Related Information

- [Paper Settings](#)

Select the Tray to Be Used For Printing

Change the default tray the machine will use for printing copies, received faxes, and print jobs from your computer.

1. Press  [Settings] > [All Settings] > [General Setup] > [Tray Setting].
2. Swipe up or down or press ▲ or ▼ to display the [Tray Use: Copy], [Tray Use: Fax], or [Tray Use: Print] option, and then press the option you want.
3. Swipe up or down or press ▲ or ▼ to display the option you want, and then press it. For example, when you select the [MP>T1] option, the machine pulls paper from the MP tray until it is empty, and then from Tray 1.
4. Press .



- When you make a copy using the ADF and give priority to multiple trays, the machine looks for the tray with the most suitable paper and pulls paper from that tray.
- When you make a copy using the scanner glass, your document is copied from the higher priority tray even if more suitable paper is in another paper tray.
- Use the following sizes of paper for printing faxes: Letter, A4, Legal, Folio, Mexico Legal or India Legal. When an appropriate size is not in any of the trays, the machine stores received faxes and [Size Mismatch] appears on the touchscreen.
- If the tray is out of paper and received faxes are in the machine's memory, [No Paper] appears on the touchscreen. Load paper in the empty tray.





Related Information

- [Paper Settings](#)

Change the Check Paper Size Setting

When you turn on your machine's Check Size setting, the machine displays a message when you remove a paper tray or load paper using the MP tray, asking if you changed the paper size and paper type.

The default setting is On.

1. Press  [Settings] > [All Settings] > [General Setup] > [Tray Setting] > [Check Size].
2. Press [On] or [Off].
3. Press .



Related Information

- [Paper Settings](#)
-

Change the Tray Size for 2-sided Printing

When you print on both sides of the paper, you must set the 2-sided tray size to the paper size. If you do not set the 2-sided tray, the paper will not feed correctly, resulting in a skewed printout or a paper jam.

This feature is not available in some countries.

1. Slide the lever on the 2-sided tray to the correct paper size.

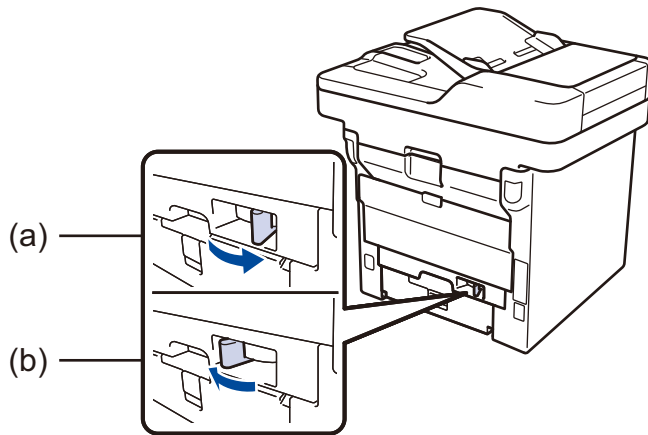

- a. A4 (for A4)
- b. Letter (for Letter, Legal, Mexico Legal, India Legal and Folio)



Related Information

- [Paper Handling](#)

Load Documents

You can send a fax, make copies and scan from the Automatic Document Feeder (ADF) and from the scanner glass.

- [Load Documents in the Automatic Document Feeder \(ADF\)](#)
- [Load Documents on the Scanner Glass](#)

Load Documents in the Automatic Document Feeder (ADF)

Use the ADF when copying or scanning multiple-page, standard-sized documents.

- The ADF can hold the following pages and feed each sheet individually:
 - (DocuPrint M375 df)
up to 50 pages
 - (DocuPrint M385 z/DocuPrint M375 z)
up to 70 pages
- Use standard 80 g/m² paper.
- Make sure documents with correction fluid or written in ink are completely dry.

IMPORTANT

- DO NOT leave thick documents on the scanner glass. If you do this, the ADF may jam.
- DO NOT use paper that is curled, wrinkled, folded, ripped, stapled, paper-clipped, pasted, or taped.
- DO NOT use cardboard, newspaper, or fabric.
- To avoid damaging your machine while using the ADF, DO NOT pull on the document while it is feeding.

Document Sizes Supported

Length:	150 to 357.6 mm
Width:	146 to 218 mm
Weight:	64 to 90 g/m ²

1. Unfold the ADF document output support flap.

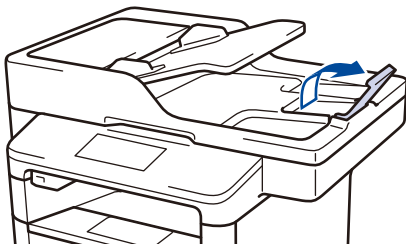

2. Fan the pages well.
3. Stagger the pages of your document and load it *face up* and *top edge first*, into the ADF as shown in the illustration.

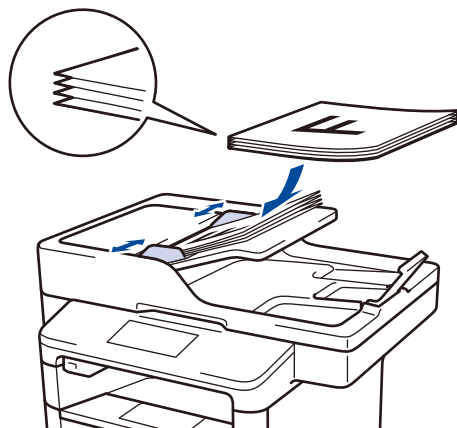

4. Adjust the paper guides to fit the width of your document.



Related Information

- [Load Documents](#)
-

Load Documents on the Scanner Glass

Use the scanner glass to fax, copy, or scan one page at a time.

⚠ CAUTION

- Do not apply excessive force to hold thick document on the document glass. It may break the glass and cause injuries.

Document Sizes Supported

Length:	<ul style="list-style-type: none">• (DocuPrint M375 df) Up to 300 mm• (DocuPrint M385 z/DocuPrint M375 z) Up to 355.6mm
Width:	Up to 215.9 mm
Weight:	Up to 2 kg



To use the scanner glass, the ADF must be empty.

1. Lift the document cover.
2. Place the document on the scanner glass *face down*.

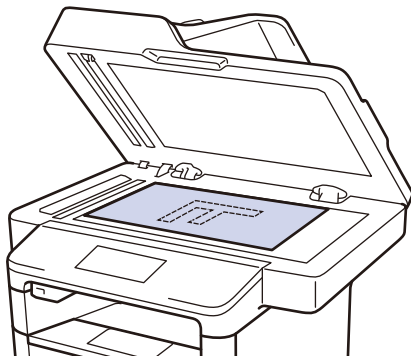

3. Place the corner of the page in the upper left corner of the scanner glass.

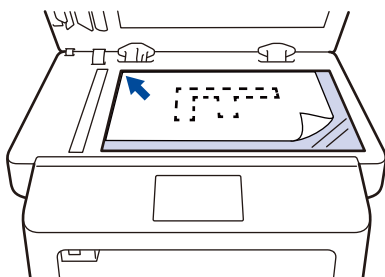

4. Close the document cover.
If the document is a book or is thick, gently press on the document cover.



Related Information

- [Load Documents](#)

Unscannable and Unprintable Areas

The figures in the table show maximum unscannable and unprintable areas from the edges of the most commonly-used paper sizes. These measurements may vary depending on the paper size or settings in the application you are using.

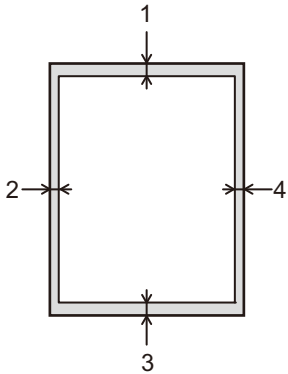

Do not attempt to scan, copy, or print into these areas; your output will not reflect anything in these areas.

Usage	Document Size	Top (1) Bottom (3)	Left (2) Right (4)
Fax (Sending)	Letter, Legal	3 mm	4 mm
	A4	3 mm	(ADF) 1 mm (Scanner Glass) 3 mm
Copy *1	Letter, Legal	4 mm	4 mm
	A4	4 mm	3 mm
Scan	Letter	3 mm	3 mm
	A4	3 mm	3 mm
	Legal	3 mm	3 mm
Print	Letter, Legal	4.2 mm	4.2 mm
	A4	4.2 mm	4.2 mm

*1 a single copy or a 1 in 1 copy



Related Information

- [Paper Handling](#)

Related Topics

- [Printing Problems](#)

Using Special Paper

Always test paper samples before purchasing them to ensure desirable performance.

WARNING

- Do not use conductive paper such as origami paper, carbonic paper or conductively-coated paper. When paper jam occurs, it may cause short-circuit and eventually a fire accident.

- DO NOT use inkjet paper; it may cause a paper jam or damage your machine.
- If you use bond paper, paper with a rough surface, or paper that is wrinkled or creased, the paper may exhibit degraded performance.

Store paper in its original packaging and keep it sealed. Keep the paper flat and away from moisture, direct sunlight and heat.

IMPORTANT

Some types of paper may not perform well or may cause damage to your machine.

DO NOT use paper:

- that is highly textured
- that is extremely smooth or shiny
- that is curled or warped
- that is coated or has a chemical finish
- that is damaged, creased or folded
- that exceeds the recommended weight specification in this guide
- with tabs and staples
- with letterheads using low temperature dyes or thermography
- that is multipart or carbonless
- that is designed for inkjet printing

If you use any of the types of paper listed above, they may damage your machine. This damage is not covered under any Fuji Xerox warranty or service agreement.



Related Information

- [Paper Handling](#)

Print

- [Print from Your Computer \(Windows®\)](#)
- [Print from Your Computer \(Mac\)](#)
- [Print One Page Duplicates on Different Types of Paper](#)
- [Cancel a Print Job](#)
- [Test Print](#)

Print from Your Computer (Windows®)

- [Print a Document \(Windows®\)](#)
- [Print More Than One Page on a Single Sheet of Paper \(N in 1\) \(Windows®\)](#)
- [Print as a Poster \(Windows®\)](#)
- [Print on Both Sides of the Paper \(Windows®\)](#)
- [Print as a Booklet \(Windows®\)](#)
- [Secure Print \(Windows®\)](#)
- [Use a Macro from Your Computer \(Windows®\)](#)
- [Use a Preset Print Profile \(Windows®\)](#)
- [Change the Default Print Settings \(Windows®\)](#)
- [Print a Document Using the PS3 emulate Printer Driver \(Windows®\)](#)
- [Monitor the Status of the Machine from Your Computer \(Windows®\)](#)
- [Print Settings \(Windows®\)](#)

Print a Document (Windows®)

1. Select the print command in your application.
2. Select **FX DocuPrint XXXXX** (where XXXXX is the name of your model), and then click the printing properties or preferences button.

The printer driver window appears.

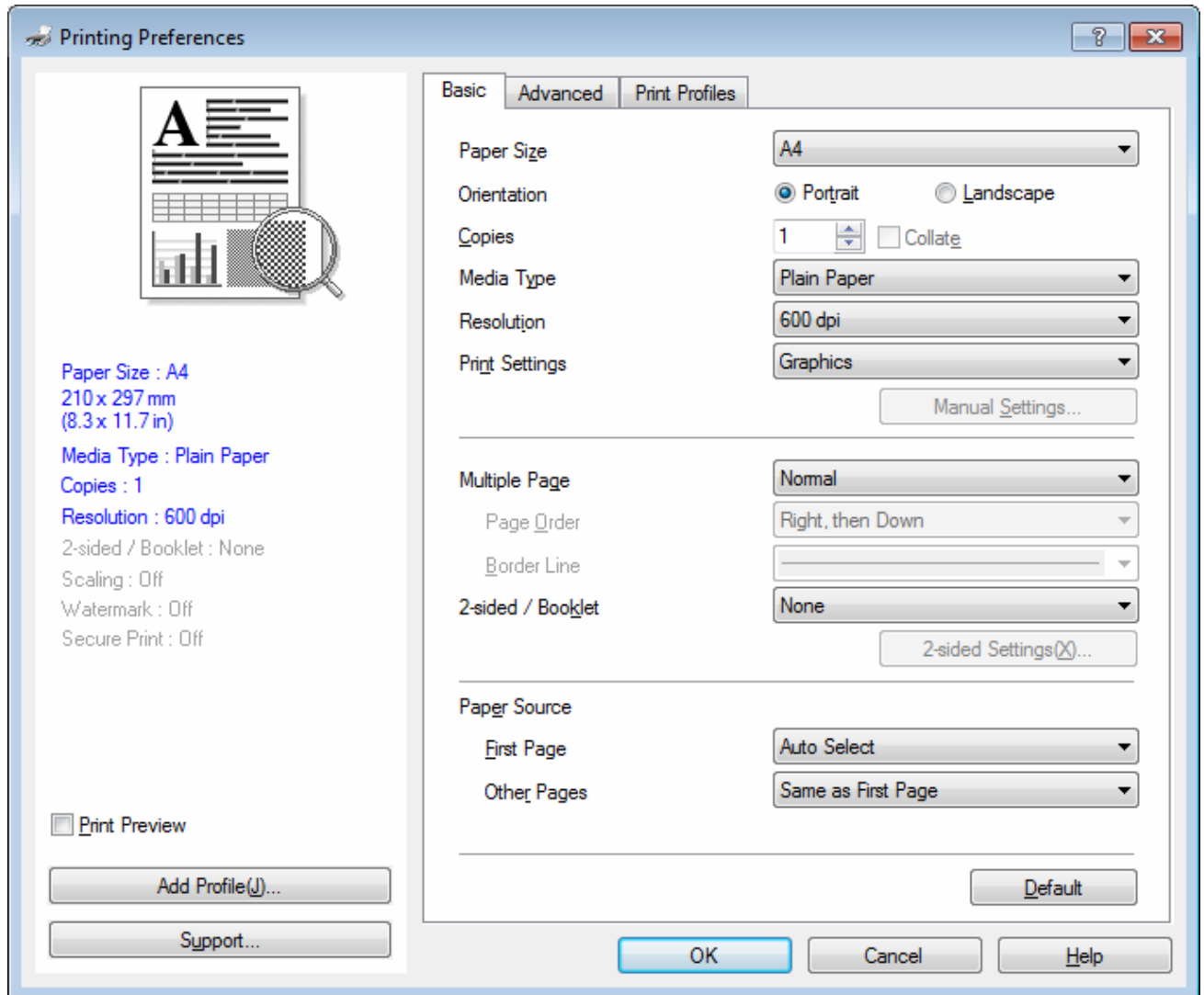

3. Make sure you have loaded the correct size paper in the paper tray.
4. Click the **Paper Size** drop-down list, and then select your paper size.
5. In the **Orientation** field, select the **Portrait** or **Landscape** option to set the orientation of your printout.



If your application contains a similar setting, we recommend that you set the orientation using the application.

6. Type the number of copies (1-999) you want in the **Copies** field.
7. Click the **Media Type** drop-down list, and then select the type of paper you are using.
8. To print multiple pages on a single sheet of paper or print one page of your document on multiple sheets, click the **Multiple Page** drop-down list, and then select your options.
9. Change other printer settings if needed.
10. Click **OK**.

11. Complete your print operation.



Related Information

- [Print from Your Computer \(Windows®\)](#)

Related Topics

- [Print Settings \(Windows®\)](#)
-

Print More Than One Page on a Single Sheet of Paper (N in 1) (Windows®)



1. Select the print command in your application.
2. Select **FX DocuPrint XXXXX** (where XXXXX is the name of your model), and then click the printing properties or preferences button.
The printer driver window appears.
3. In the **Orientation** field, select the **Portrait** or **Landscape** option to set the orientation of your printout.



If your application contains a similar setting, we recommend that you set the orientation using the application.

4. Click the **Multiple Page** drop-down list, and then select the **2 in 1**, **4 in 1**, **9 in 1**, **16 in 1**, or **25 in 1** option.
5. Click the **Page Order** drop-down list, and then select your page order.
6. Click the **Border Line** drop-down list, and then select your border line type.
7. Change other printer settings if needed.
8. Click **OK**.
9. Complete your print operation.



Related Information

- [Print from Your Computer \(Windows®\)](#)

Related Topics

- [Print Settings \(Windows®\)](#)
-

Print as a Poster (Windows®)

Enlarge your print size and print the document in poster mode.

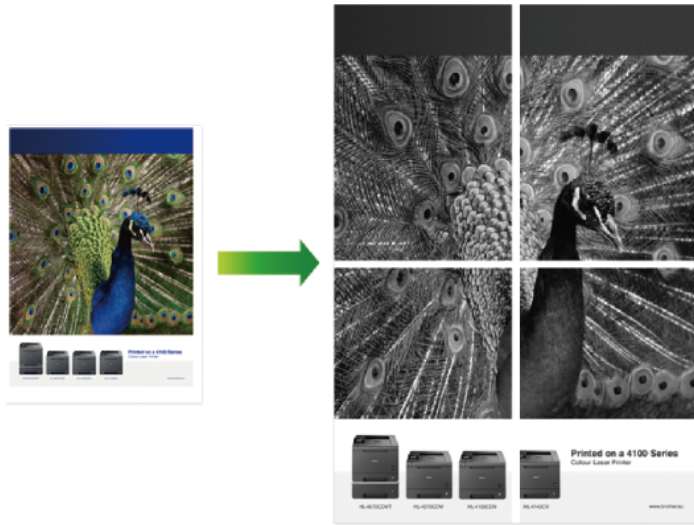

1. Select the print command in your application.
2. Select **FX DocuPrint XXXXX** (where XXXXX is the name of your model), and then click the printing properties or preferences button.
The printer driver window appears.
3. Click the **Multiple Page** drop-down list, and then select the **1 in 2x2 Pages**, **1 in 3x3 Pages**, **1 in 4x4 Pages**, or **1 in 5x5 Pages** option.
4. Select the **Print cut-out line** check box, if needed.

Print cut-out line

Prints a faint cut-out line around the printable area so that you can easily cut it out.

5. Change other printer settings if needed.
6. Click **OK**.
7. Complete your print operation.



Related Information

- [Print from Your Computer \(Windows®\)](#)

Related Topics

- [Print Settings \(Windows®\)](#)

Print on Both Sides of the Paper (Windows®)

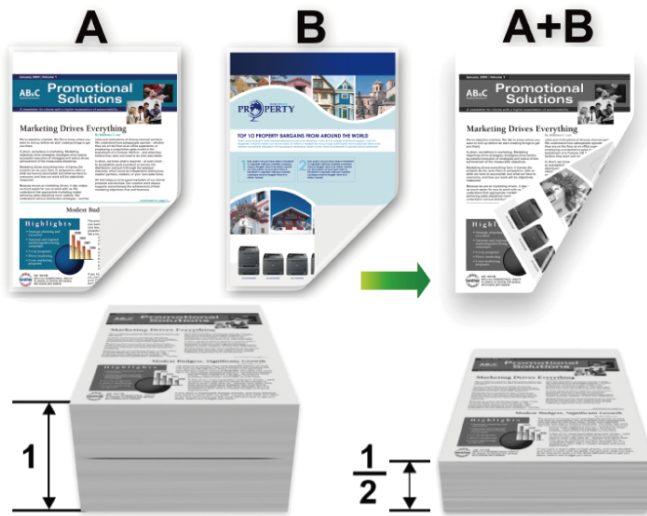

- (For models without the lever on the 2-sided tray) Select A4 sized paper when using the automatic 2-sided printing function.
- (For models with the lever on the 2-sided tray) Select A4, Letter, Legal, Mexico Legal, India Legal or Folio sized paper when using the automatic 2-sided printing function.
- Make sure the 2-sided tray is set to the paper size. If it is not, the paper may not be fed correctly, resulting in a skewed or a paper jam.
- Make sure the back cover is closed.
- If paper is curled, straighten it and put it back in the paper tray.
- Use regular paper or thin paper. DO NOT use bond paper.
- If the paper is too thin, it may wrinkle.
- When you use the manual 2-sided printing function, it is possible there may be paper jams or poor print quality.

1. Select the print command in your application.
2. Select **FX DocuPrint XXXXX** (where XXXXX is the name of your model), and then click the printing properties or preferences button.
The printer driver window appears.
3. In the **Orientation** field, select the **Portrait** or **Landscape** option to set the orientation of your printout.



If your application contains a similar setting, we recommend that you set the orientation using the application.

4. Click the **2-sided / Booklet** drop-down list, and then select the **2-sided** or **2-sided (Manual)** option.

Option	Description
2-sided	Automatically prints on both sides of the paper.
2-sided (Manual)	The machine prints all the even-numbered pages on one side of the paper first. Then, the printer driver instructs you (with a pop-up message) to reinsert the paper.

5. Click the **2-sided Settings** button.
6. Select one of the options from the **2-sided Type** menu.
When 2-sided is selected, four types of 2-sided binding are available for each orientation:

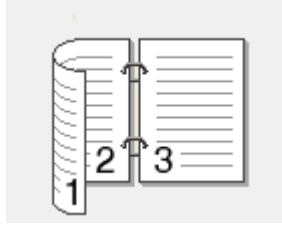
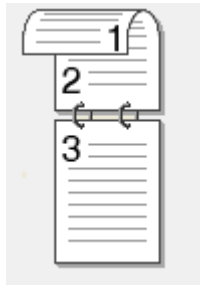
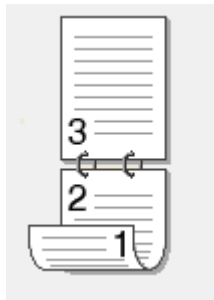
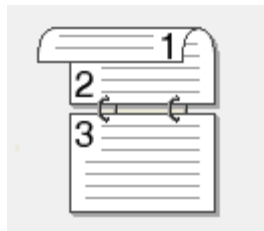
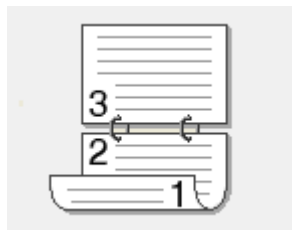
Option for Portrait**Description****Long Edge (Left)****Long Edge (Right)****Short Edge (Top)****Short Edge (Bottom)****Option for Landscape****Description****Long Edge (Top)****Long Edge (Bottom)**

Option for Landscape	Description
----------------------	-------------

Short Edge (Right)	
---------------------------	---

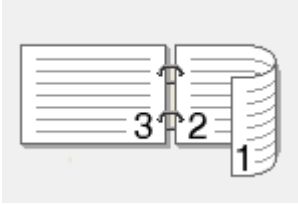

Short Edge (Left)	
--------------------------	---

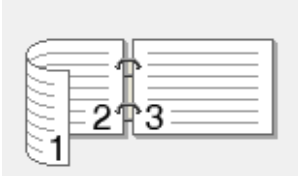

-
7. Select the **Binding Offset** check box if you want to specify the offset for binding in inches or millimetres.
 8. Click **OK**.
 9. Change other printer settings if needed.
 10. Do one of the following:
 - For automatic 2-sided printing, click **OK** again, and then complete your print operation.
 - For manual 2-sided printing, click **OK** again and follow the on-screen instructions.

If the paper is not feeding correctly, it may be curled. Remove the paper, straighten it, and put it back in the paper tray.



Related Information

- [Print from Your Computer \(Windows®\)](#)

Related Topics

- [Print Settings \(Windows®\)](#)
-

Print as a Booklet (Windows®)

Use this option to print a document in booklet format using 2-sided printing. The document's pages will be arranged according to the correct page number and will allow you to fold the print output at the centre, without having to change the order of the printed pages.

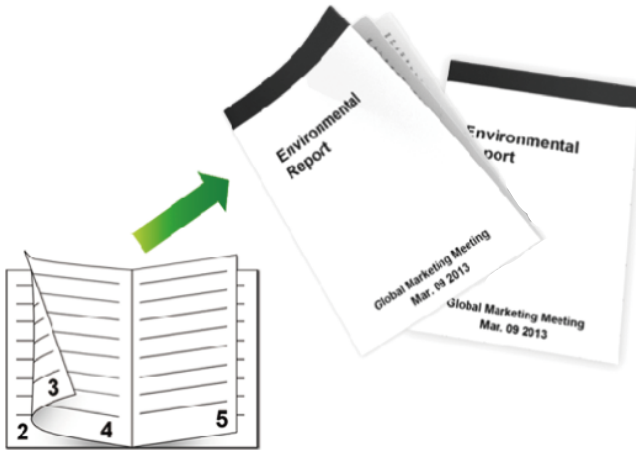

- (For models without the lever on the 2-sided tray) Select A4 sized paper when using the automatic 2-sided printing function.
- (For models with the lever on the 2-sided tray) Select A4, Letter, Legal, Mexico Legal, India Legal or Folio sized paper when using the automatic 2-sided printing function.
- Make sure the 2-sided tray is set to the paper size. If it is not, the paper may not be fed correctly, resulting in a skewed or a paper jam.
- Make sure the back cover is closed.
- If paper is curled, straighten it and put it back in the paper tray.
- Use regular paper or thin paper. DO NOT use bond paper.
- If the paper is too thin, it may wrinkle.
- When you use the manual 2-sided printing function, it is possible there may be paper jams or poor print quality.

1. Select the print command in your application.
2. Select **FX DocuPrint XXXXX** (where XXXXX is the name of your model), and then click the printing properties or preferences button.

The printer driver window appears.

3. In the **Orientation** field, select the **Portrait** or **Landscape** option to set the orientation of your printout.



If your application contains a similar setting, we recommend that you set the orientation using the application.

4. Click the **2-sided / Booklet** drop-down list, and then select the **Booklet** or **Booklet (Manual)** option.

Option	Description
Booklet	Automatically prints as a booklet.
Booklet (Manual)	Manually prints as a booklet.

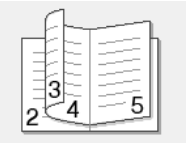
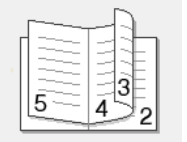

5. Click the **2-sided Settings** button.
6. Select one of the options from the **2-sided Type** menu.

There are two types of 2-sided binding directions available for each orientation:

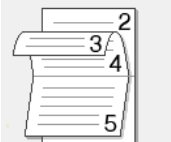
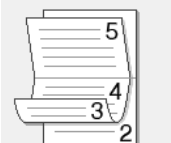
Option for Portrait	Description
Left Binding	
Right Binding	

Option for Landscape	Description
Top Binding	
Bottom Binding	

7. Select one of the options from the **Booklet Printing Method** menu.

Option	Description
All Pages at Once	Every page will be printed in booklet format (four pages to every piece of paper, two pages per side). Fold your printout in the centre to create the booklet. 
Divide into Sets	This option prints the whole booklet in smaller individual booklet sets, allowing you to fold at the centre of the smaller individual booklet sets without having to change the order of the printed pages. You can specify the number of sheets in each smaller booklet set (from 1-15). This option can be helpful when folding a printed booklet that has a large number of pages. 

8. Select the **Binding Offset** check box if you want to specify the offset for binding in inches or millimetres.

9. Click **OK**.

10. Change other printer settings if needed.

11. Do one of the following:

- For automatic booklet printing, click **OK** again, and then complete your print operation.
- For manual booklet printing, click **OK** again and follow the on-screen instructions.



Related Information

- [Print from Your Computer \(Windows®\)](#)

Related Topics

- [Print Settings \(Windows®\)](#)

Secure Print (Windows®)

Use Secure Print to ensure that confidential or sensitive documents do not print until you enter a password on the machine's control panel.

- The secure data is deleted from the machine when you turn off the machine.

1. Select the print command in your application.
2. Select **FX DocuPrint XXXXX** (where XXXXX is the name of your model), and then click the printing properties or preferences button.
The printer driver window appears.
3. Click the **Advanced** tab.
4. Click the **Settings** button in the **Secure Print** field.
5. Select the **Secure Print** check box.
6. Type your four-digit password in the **Password** field, your **User Name** and **Job Name** in the **Job Information** field, and then click **OK**.



You must set a separate password for each document.

7. Click **OK**.
8. Complete your print operation.
9. On the machine's control panel, swipe left or right or press ◀ or ▶ to display the [Secure Print] option, and then press [Secure Print].
10. Swipe up or down or press ▲ or ▼ to display user names, and then press your user name.
The LCD displays the list of secured jobs for your name.
11. Swipe up or down or press ▲ or ▼ to display the print job, and then press it.
12. Enter your four-digit password, and then press [OK].
13. Enter the number of copies you want.
14. Press [Start].
The machine prints the data.

After you print the secured data, it will be cleared from the machine's memory.



Related Information

- [Print from Your Computer \(Windows®\)](#)

Use a Macro from Your Computer (Windows®)

If you have stored the electronic forms (macros) in your machine's memory, you can use the macro to print the data as an overlay on the print job you want.

1. Select the print command in your application.
2. Select **FX DocuPrint XXXXX** (where XXXXX is the name of your model), and then click the printing properties or preferences button.
The printer driver window appears.
3. Click the **Advanced** tab.
4. Click the **Other Print Options** button.
5. Select **Macro**.
6. Click the **Macro Settings** button.
7. Enter **Macro ID** and **Macro Name** you want to use.
8. Select **Insert Macro Command**.
9. Select the page to overlay the macro data.

Option	Description
All Pages	Lets you insert the macro onto all pages.
Page	Lets you insert the macro onto a specific page. Select this option, and then enter a page number within the range 1 to 255.
Add to Top of Page	Send the macro data to the top of the page.
Add to End of Page	Send the macro data to the bottom of the page.



When **Booklet** has been selected, the **Page** setting in **Insert Macro Command** is disabled.

10. Click **OK**.
11. Click **OK** to return to the printer driver window.
12. Click **OK**.
13. Complete your print operation.
The macro data is printed as an overlay.



Related Information

- [Print from Your Computer \(Windows®\)](#)

Related Topics

- [Print One Page Duplicates on Different Types of Paper](#)

Use a Preset Print Profile (Windows®)

Print Profiles are presets designed to give you quick access to frequently-used printing configurations.

1. Select the print command in your application.
2. Select **FX DocuPrint XXXXX** (where XXXXX is the name of your model), and then click the printing properties or preferences button.
The printer driver window appears.
3. Click the **Print Profiles** tab.

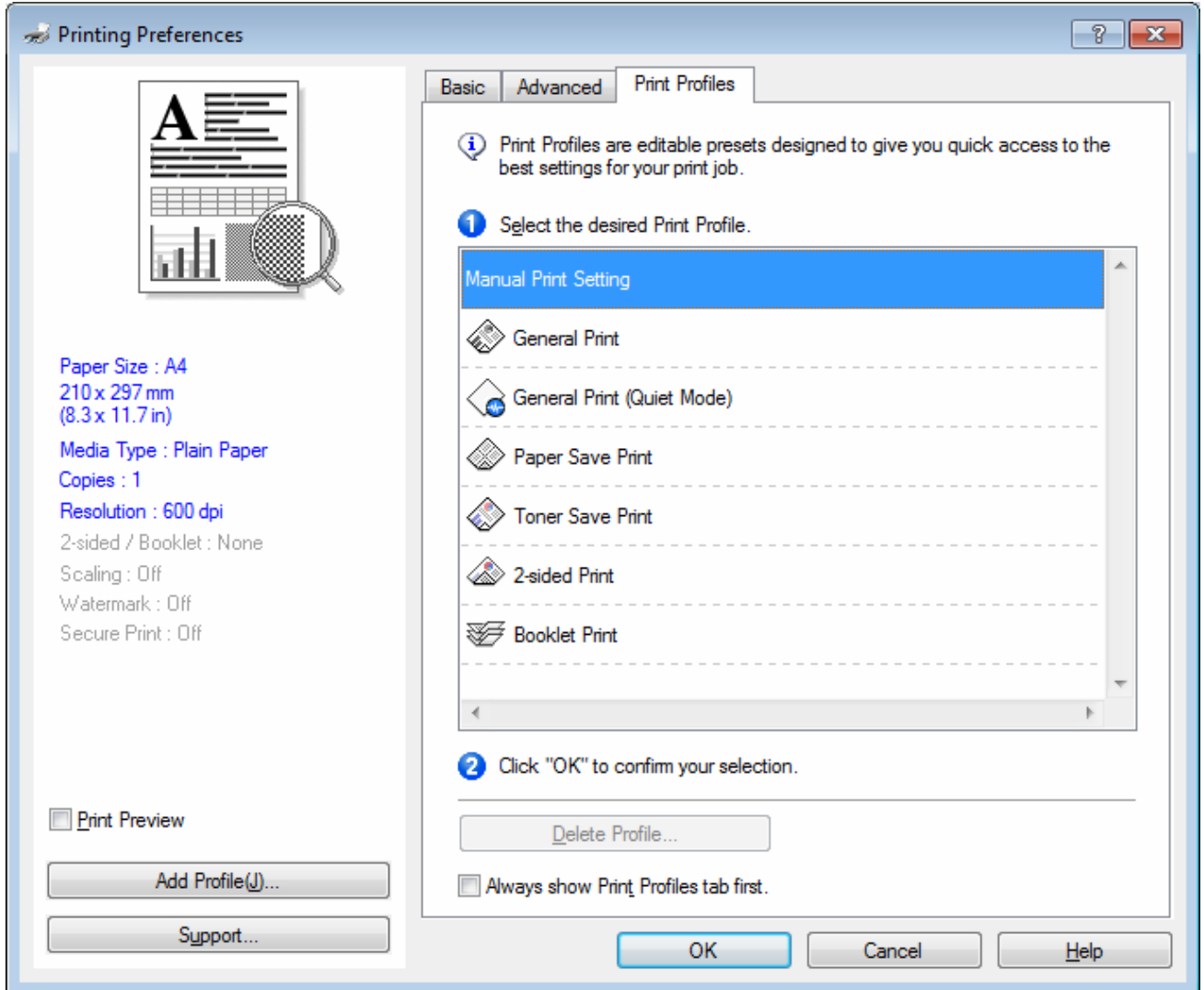

4. Select your profile from the print profile list.
The profile settings are shown on the left side of the printer driver window.
5. Do one of the following:
 - If the settings are correct for your print job, click **OK**.
 - To change the settings, go back to the **Basic** or **Advanced** tab, change settings, and then click **OK**.



To display the **Print Profiles** tab at the front of the window the next time you print, select the **Always show Print Profiles tab first.** check box.



Related Information

- [Print from Your Computer \(Windows®\)](#)
 - [Create or Delete Your Print Profile \(Windows®\)](#)

Related Topics

- [Print Settings \(Windows®\)](#)
-

Create or Delete Your Print Profile (Windows®)

Add up to 20 new print profiles with customised settings.

1. Select the print command in your application.
2. Select **FX DocuPrint XXXXX** (where XXXXX is the name of your model), and then click the printing properties or preferences button.
The printer driver window appears.
3. Click the **Basic** tab and the **Advanced** tab, and configure the print settings you want for the new Print Profile.
4. Click the **Print Profiles** tab.
5. Do one of the following:

To create a new print profile:

- a. Click **Add Profile**.
The **Add Profile** dialog box appears.
- b. Type the new profile name in the **Name** field.
- c. Click the icon you want to use to represent this profile from the icon list.
- d. Click **OK**.
The new Print Profile name is added to the list in the **Print Profiles** tab.

To delete a print profile that you created:

- a. Click **Delete Profile**.
The **Delete Profile** dialog box appears.
- b. Select the profile you want to delete.
- c. Click **Delete**.
- d. Click **Yes**.
- e. Click **Close**.





Related Information

- [Use a Preset Print Profile \(Windows®\)](#)

Change the Default Print Settings (Windows®)

When you change an application's print settings, the changes only apply to documents printed with that application. To change print settings for all Windows® applications, you must configure the printer driver properties.

1. Do one of the following:
 - For Windows Server® 2008
Click  (**Start**) > **Control Panel** > **Hardware and Sound** > **Printers**.
 - For Windows® 7 and Windows Server® 2008 R2
Click  (**Start**) > **Devices and Printers**.
 - For Windows® 8
Move your mouse to the lower right corner of your desktop. When the menu bar appears, click **Settings**, and then click **Control Panel**. In the **Hardware and Sound** group, click **View devices and printers**.
 - For Windows® 10 and Windows Server® 2016
Click  > **Windows System** > **Control Panel**. In the **Hardware and Sound** group, click **View devices and printers**.
 - For Windows Server® 2012
Move your mouse to the lower right corner of your desktop. When the menu bar appears, click **Settings**, and then click **Control Panel**. In the **Hardware** group, click **View devices and printers**.
 - For Windows Server® 2012 R2
Click **Control Panel** on the **Start** screen. In the **Hardware** group, click **View devices and printers**.
2. Right-click the **FX DocuPrint XXXXX** icon (where XXXXX is your model name), and then select **Printer properties**. If printer driver options appear, select your printer driver.
3. Click the **General** tab, and then click the **Printing Preferences...** or **Preferences...** button.
The printer driver dialog box appears.



-
- To configure the tray settings, click the **Device Settings** tab.
 - To change the printer port, click the **Ports** tab.
-

4. Select the print settings you want to use as defaults for all of your Windows® programs.
5. Click **OK**.
6. Close the printer properties dialog box.



Related Information

- [Print from Your Computer \(Windows®\)](#)
 - [Configure the Tray Module \(Optional\) Settings \(Windows®\)](#)



Related Topics

- [Print Settings \(Windows®\)](#)
-

Configure the Tray Module (Optional) Settings (Windows®)

Access your machine's Properties to auto-detect your machine's Tray Module (Optional) and serial number.

The printer driver automatically detects the Tray Module (Optional) during the driver installation. If you added the Tray Module (Optional) after the driver installation, follow these steps.

1. Do one of the following:
 - For Windows Server® 2008
Click  (**Start**) > **Control Panel** > **Hardware and Sound** > **Printers**.
 - For Windows® 7 and Windows Server® 2008 R2
Click  (**Start**) > **Devices and Printers**.
 - For Windows® 8
Move your mouse to the lower right corner of your desktop. When the menu bar appears, click **Settings**, and then click **Control Panel**. In the **Hardware and Sound** group, click **View devices and printers**.
 - For Windows® 10 and Windows Server® 2016
Click  > **Windows System** > **Control Panel**. In the **Hardware and Sound** group, click **View devices and printers**.
 - For Windows Server® 2012
Move your mouse to the lower right corner of your desktop. When the menu bar appears, click **Settings**, and then click **Control Panel**. In the **Hardware** group, click **View devices and printers**.
 - For Windows Server® 2012 R2
Click **Control Panel** on the **Start** screen. In the **Hardware** group, click **View devices and printers**.
2. Right-click the **FX DocuPrint XXXXX** icon (where XXXXX is your model name), and then select **Printer properties**. If printer driver options appear, select your printer driver.
3. Select the **Device Settings** tab.
4. Click the **Auto Detect** button.
The Tray Module (Optional) and the machine's serial number are automatically detected.
5. Click the **Apply** button.

The **Auto Detect** function is not available under the following machine conditions:

- The machine power switch is off.
- The machine is in an error state.
- The machine is in a network shared environment.
- The cable is not connected to the machine correctly.



Related Information

- [Change the Default Print Settings \(Windows®\)](#)

Print a Document Using the PS3 emulate Printer Driver (Windows®)

To install the PS3 emulate printer driver, launch Fuji Xerox installation disc, select **Custom** in Select Machine section, and then check **PS Driver** check box.

1. Select the print command in your application.
2. Select **FX DocuPrint XXXXX PS3 emulate** (where XXXXX is the name of your model), and then click the printing properties or preferences button.

The printer driver window appears.

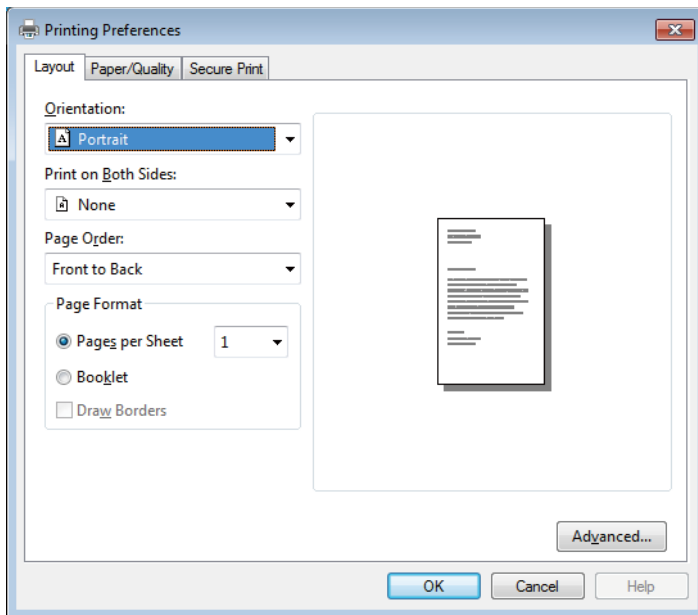

3. Click the **Layout**, **Paper/Quality**, or **Secure Print** tab to change basic print settings. Click the **Layout** or **Paper/Quality** tab, and then click the **Advanced...** button to change advanced print settings.
4. Click **OK**.
5. Complete your print operation.

✓ Related Information

- [Print from Your Computer \(Windows®\)](#)

Monitor the Status of the Machine from Your Computer (Windows®)

The Status Monitor utility is a configurable software tool for monitoring the status of one or more devices, allowing you to get immediate notification of errors.

- Do one of the following:

- Double-click the  icon in the task tray.
- (Windows® 7)



Click  (**Start**) > **All Programs** > **Fuji Xerox** > **Fuji Xerox Utilities**.

Click the drop-down list and select your model name (if not already selected). Click **Tools** in the left navigation bar, and then click **Status Monitor**.

- (Windows® 8)

Click  (**Fuji Xerox Utilities**), and then click the drop-down list and select your model name (if not already selected). Click **Tools** in the left navigation bar, and then click **Status Monitor**.

- (Windows® 8.1)

Move your mouse to the lower left corner of the **Start** screen and click  (if you are using a touch-based device, swipe up from bottom of the **Start** screen to bring up the **Apps** screen). When the **Apps** screen appears, tap or click  (**Fuji Xerox Utilities**), and then click the drop-down list and select your model name (if not already selected). Click **Tools** in the left navigation bar, and then click **Status Monitor**.

- (Windows® 10)

Click  > **Fuji Xerox** > **Fuji Xerox Utilities**.

Click the drop-down list and select your model name (if not already selected). Click **Tools** in the left navigation bar, and then click **Status Monitor**.



Related Information

- [Print from Your Computer \(Windows®\)](#)

Related Topics

- [Printing Problems](#)

Print Settings (Windows®)

Basic Tab

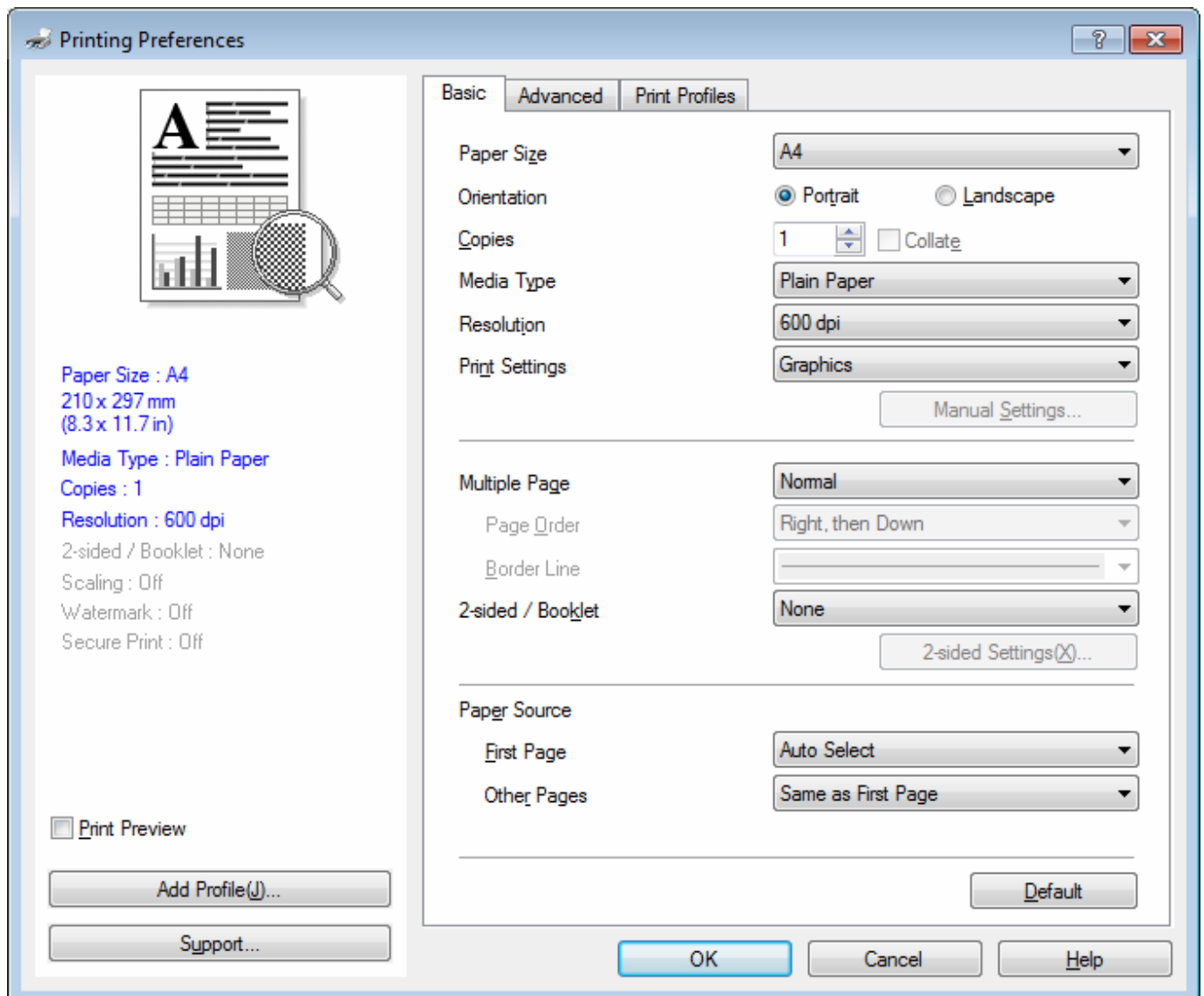

1. Paper Size

Select the size of the paper you want to use. You can either choose from standard paper sizes or create a custom paper size.

2. Orientation

Select the orientation (portrait or landscape) of your printout.

If your application contains a similar setting, we recommend that you set the orientation using the application.

3. Copies

Type the number of copies (1-999) that you want to print in this field.

Collate

Select this option to print sets of multi-page documents in the original page order. When this option is selected, one complete copy of your document will print, and then reprint according to the number of copies you choose. If this option is not selected, then each page will print according to the number of copies chosen before the next page of the document is printed.

4. Media Type

Select the type of media you want to use. To achieve the best print results, the machine automatically adjusts its print settings according to the selected media type.

5. Resolution

Select the print resolution. As print resolution and speed are related, the higher the resolution, the longer it will take to print the document.

6. Print Settings

Select the type of document you want to print.

Manual Settings...

Specify advanced settings such as brightness, contrast, and other settings.

Graphics

Use Printer Halftone

Select this option to use the printer driver to express halftones.

Brightness

Specify the brightness.

Contrast

Specify the contrast.

Graphics Quality

Select either Graphics or Text for the best print quality, based on the type of document you are printing.

Improve Grey Printing

Select this option to improve the image quality of shaded areas.

Improve Pattern Printing

Select this option to improve the pattern printing if printed fills and patterns are different from the fills and patterns you see on your computer screen.

Improve Thin Line

Select this option to improve the image quality of thin lines.

Use System Halftone

Select this option to use Windows® to express halftones.

TrueType Mode(Available only for certain models)

Mode

Select how the fonts are processed for printing.

Use Printer TrueType Fonts

Select whether to use built-in fonts for the font processing.

7. Multiple Page

Select this option to print multiple pages on a single sheet of paper or print one page of your document on multiple sheets.

Page Order

Select the page order when printing multiple pages on a single sheet of paper.

Border Line

Select the type of border to use when printing multiple pages on a single sheet of paper.

8. 2-sided / Booklet

Select this option to print on both sides of the paper or print a document in booklet format using 2-sided printing.

2-sided Settings button

Click this button to select the type of 2-sided binding. Four types of 2-sided bindings are available for each orientation.

9. Paper Source

Select the paper source setting according to your print conditions or purpose.

First Page

Select the paper source to use for printing the first page.

Other Pages

Select the paper source to use for printing the second and subsequent pages.

Advanced Tab

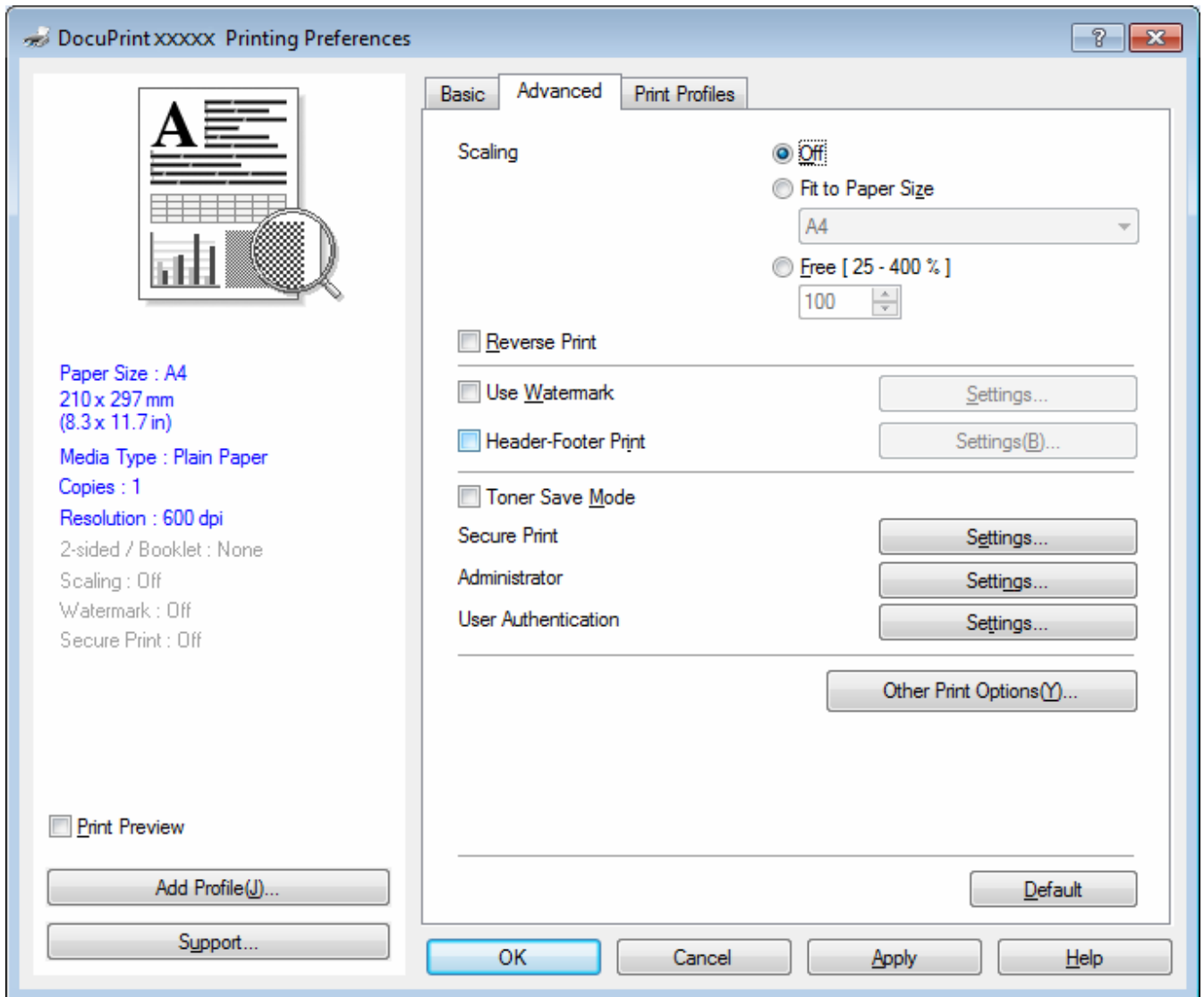

1. Scaling

Select these options to enlarge or reduce the size of the pages in your document.

Fit to Paper Size

Select this option to enlarge or reduce the document pages to fit a specified paper size. When you select this option, select the paper size you want from the drop-down list.

Free

Select this option to enlarge or reduce the document pages manually. When you select this option, type a value into the field.

2. Reverse Print

Select this option to rotate the printed image 180 degrees.

3. Use Watermark

Select this option to print a logo or text on your document as a watermark. Select one of the preset watermarks, add a new watermark, or use an image file you have created.

4. Header-Footer Print

Select this option to print the date, time and PC login user name on the document.

5. Toner Save Mode

Select this feature to conserve toner by using less toner to print documents; printouts appear lighter, but are still legible.

6. Secure Print

This feature ensures that confidential or sensitive documents do not print until you enter a password on the machine's control panel.

7. Administrator

This feature allows you to change the administrator password and restrict various printing functions.

8. User Authentication

This feature allows you to confirm the restrictions for each user.

9. Other Print Options button

Macro

Select this feature to print an electronic form (macro), which you have stored in your machine's memory, as an overlay on the print job.

Density Adjustment

Specify the print density.

Improve Print Output

Select this option to reduce the amount of paper curling and improve the toner fixing.

Skip Blank Page

Select this option to allow the printer driver to automatically detect blank pages and exclude them from printing.

Print Text in Black

Select this option when you want to print colour text in black.

Print Archive

Select this option to save the print data as a PDF file to your computer.

Eco settings

Select this option to reduce printing noise.



Related Information

- [Print from Your Computer \(Windows®\)](#)

Related Topics

- [Print a Document \(Windows®\)](#)
 - [Print More Than One Page on a Single Sheet of Paper \(N in 1\) \(Windows®\)](#)
 - [Print as a Poster \(Windows®\)](#)
 - [Print on Both Sides of the Paper \(Windows®\)](#)
 - [Print as a Booklet \(Windows®\)](#)
 - [Use a Preset Print Profile \(Windows®\)](#)
 - [Change the Default Print Settings \(Windows®\)](#)
-

Print from Your Computer (Mac)

- [Print a Document \(Mac\)](#)
- [Print on Both Sides of the Paper \(Mac\)](#)
- [Print More Than One Page on a Single Sheet of Paper \(N in 1\) \(Mac\)](#)
- [Secure Print \(Mac\)](#)
- [Monitor the Status of the Machine from Your Computer \(Mac\)](#)
- [Print Options \(Mac\)](#)

Print a Document (Mac)

1. Make sure you have loaded the correct size paper in the paper tray.
2. From an application, such as TextEdit, click the **File** menu, and then select **Print**.
3. Select **FUJI XEROX DocuPrint XXXXX** (where XXXX is your model name).



For more page setup options, click the **Show Details** button.

4. Type the number of copies you want in the **Copies** field.
5. Click the **Paper Size** pop-up menu, and then select your paper size.
6. Select the **Orientation** option that matches the way you want the document to print.
7. Click the application pop-up menu, and then select **Print Settings**.
The **Print Settings** options appear.
8. Click the **Media Type** pop-up menu, and then select the type of paper you are using.
9. Change other printer settings, if needed.
10. Click **Print**.



Related Information

- [Print from Your Computer \(Mac\)](#)

Related Topics

- [Print Options \(Mac\)](#)
-

Print on Both Sides of the Paper (Mac)

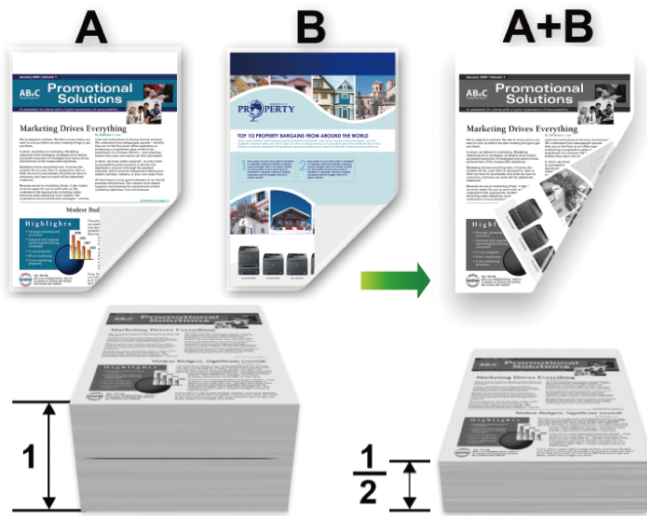

- (For models without the lever on the 2-sided tray) Select A4 sized paper when using the automatic 2-sided printing function.
- (For models with the lever on the 2-sided tray) Select A4, Letter, Legal, Mexico Legal, India Legal or Folio sized paper when using the automatic 2-sided printing function.
- Make sure the 2-sided tray is set to the paper size. If it is not, the paper may not be fed correctly, resulting in a skewed or a paper jam.
- Make sure the back cover is closed.
- If paper is curled, straighten it and put it back in the paper tray.
- Use regular paper or thin paper. DO NOT use bond paper.
- If the paper is too thin, it may wrinkle.
- When you use the manual 2-sided printing function, it is possible there may be paper jams or poor print quality.

1. From an application, such as TextEdit, click the **File** menu, and then select **Print**.
2. Select **FUJI XEROX DocuPrint XXXXX** (where XXXX is your model name).



For more page setup options, click the **Show Details** button.

3. Select the **Orientation** option that matches the way you want the document to print.
4. For automatic 2-sided printing, do the following:
 - a. Click the application pop-up menu, and then select **Layout**.
The **Layout** setting options appear.
 - b. In the **Two-Sided** section, select the **Short-Edge binding** or **Long-Edge binding** option.
 - c. Change other printer settings, if needed.
 - d. Click **Print**.
5. For manual 2-sided printing, do the following:
 - a. Click the application pop-up menu, and then select **Paper Handling**.
The **Paper Handling** options appear.
 - b. In the **Pages to Print** pop-up menu, select **Even Only**.
 - c. Change other print settings, if needed.

-
- d. Click the **Print** button.
 - e. After the machine prints the even-numbered pages, remove the printed pages from the output paper tray.
 - f. Make sure the pages are completely flat, and put the paper back in the tray, blank side facing down.
 - g. Repeat steps 1-3, selecting the same printer and settings you used to print the even-numbered pages.
 - h. Click the application pop-up menu, and then select **Paper Handling**. The **Paper Handling** options appear.
 - i. In the **Pages to Print** pop-up menu, select **Odd Only**.
 - j. Click **Print**.



Related Information

- [Print from Your Computer \(Mac\)](#)

Related Topics

- [Print Options \(Mac\)](#)
-

Print More Than One Page on a Single Sheet of Paper (N in 1) (Mac)



1. From an application, such as TextEdit, click the **File** menu, and then select **Print**.
2. Select **FUJI XEROX DocuPrint XXXXX** (where XXXX is your model name).



For more page setup options, click the **Show Details** button.

3. Click the application pop-up menu, and then select **Layout**.
The **Layout** setting options appear.
4. Click the **Pages per Sheet** pop-up menu, and then select the number of pages to print on each sheet.
5. Select the **Layout Direction** option.
6. Click the **Border** pop-up menu, and then select your border line type.
7. Change other printer settings if needed.
8. Click **Print**.



Related Information

- [Print from Your Computer \(Mac\)](#)

Related Topics

- [Print Options \(Mac\)](#)
-

Secure Print (Mac)

Use Secure Print to ensure that confidential or sensitive documents do not print until you enter a password on the machine's control panel.

- The secure data is deleted from the machine when you turn off the machine.

1. From an application, such as TextEdit, click the **File** menu, and then select **Print**.
2. Select **FUJI XEROX DocuPrint XXXXX** (where XXXX is your model name).



For more page setup options, click the **Show Details** button.

3. Click the application pop-up menu, and then select the **Secure Print** option. The **Secure Print** options appear.
4. Select the **Secure Print** check box.
5. Type your user name, job name and a four-digit password.
6. Click **Print**.
7. On the machine's control panel, swipe left or right or press ◀ or ▶ to display the [Secure Print] option, and then press [Secure Print].
8. Swipe up or down or press ▲ or ▼ to display user names, and then press your user name.
The LCD displays the list of secured jobs for your name.
9. Swipe up or down or press ▲ or ▼ to display the print job, and then press it.
10. Enter your four-digit password, and then press [OK].
11. Enter the number of copies you want.
12. Press [Start].
The machine prints the data.

After you print the secured data, it will be cleared from the machine's memory.



Related Information

- [Print from Your Computer \(Mac\)](#)

Monitor the Status of the Machine from Your Computer (Mac)

The Status Monitor utility is a configurable software tool for monitoring the status of a device, allowing you to get immediate notification of error messages, such as paper empty or paper jam, at preset update intervals. You can also access Web Based Management.

1. Click the **System Preferences** menu, select **Print & Scan** or **Printers & Scanners**, and then select your machine.
2. Click the **Options & Supplies** button.
3. Click the **Utility** tab, and then click the **Open Printer Utility** button.

Status Monitor starts.

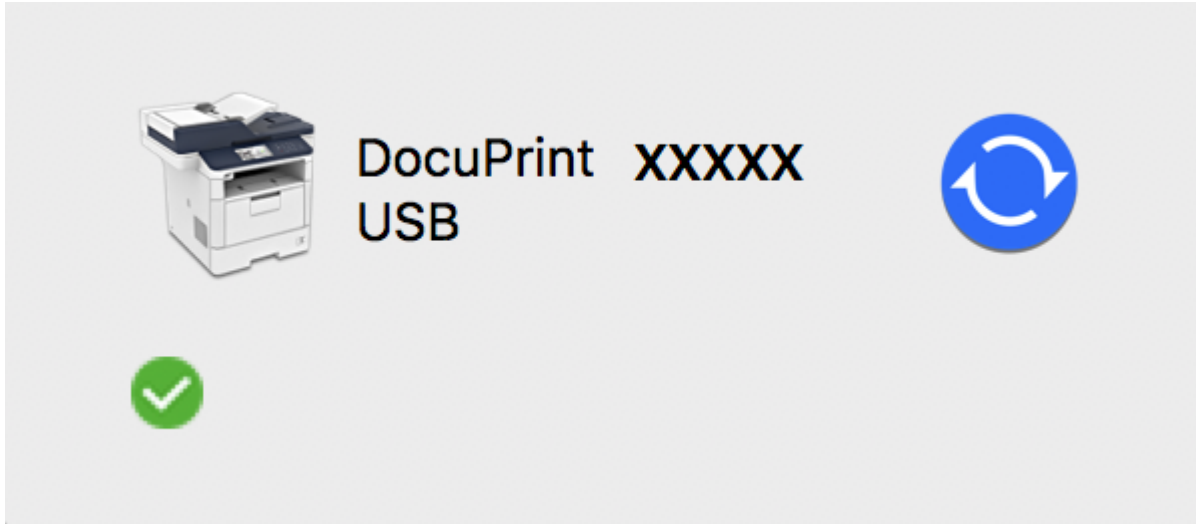

Updating the machine's status

To view the latest machine status while the **Status Monitor** window is open, click the  icon. You can set the interval at which the software updates machine status information. Click **Fuji Xerox Status Monitor** in the menu bar, and then select **Preferences**.

Web Based Management (Network Connection Only)

Access the Web Based Management System by clicking the machine icon on the **Status Monitor** screen. You can use a standard Web Browser to manage your machine using HTTP (Hyper Text Transfer Protocol).

Related Information

- [Print from Your Computer \(Mac\)](#)

Related Topics

- [Printing Problems](#)

Print Options (Mac)

Page Setup

Format For: FUJI XEROX DocuPrint XXXXX
FX DocuPrint XXXXX CUPS

Paper Size: A4
210 by 297 mm

Orientation: Portrait Landscape

Scale: 100%

? Cancel OK

1. Paper Size

Select the size of the paper you want to use. You can either choose from standard paper sizes or create a custom paper size.

2. Orientation

Select the orientation (portrait or landscape) of your printout.

If your application contains a similar setting, we recommend that you set the orientation using the application.

3. Scale

Type a value into the field to enlarge or reduce the pages in your document to fit the selected paper size.

Layout

Printer: FUJI XEROX DocuPrint XXXXX

Presets: Default Settings

Copies: 1 Two-Sided

Pages: All
 From: 1 to: 1

Paper Size: A4 210 by 297 mm

Orientation: Portrait Landscape Scale: 100%

Layout

Pages per Sheet: 1

Layout Direction: Z S U N

Border: None

Two-Sided: Off

Reverse page orientation
 Flip horizontally

? PDF Hide Details Cancel Print

1. Pages per Sheet

Select the number of pages to print on a single sheet of paper.

2. Layout Direction

Select the page order when printing multiple pages on a single sheet of paper.

3. Border

Select the type of border to use when printing multiple pages on a single sheet of paper.

4. Two-Sided

Select whether to print on both sides of the paper.

5. Reverse page orientation

Select this option to rotate the printed image 180 degrees.

6. Flip horizontally

Select this option to reverse the printed image on the page horizontally from left to right.

Paper Handling

Printer: FUJI XEROX DocuPrint XXXXX

Presets: Default Settings

Copies: 1 Two-Sided

Pages: All
 From: 1 to: 1

Paper Size: A4 210 by 297 mm

Orientation: Scale: 100%

Paper Handling

Collate pages

Pages to Print: All pages

Page Order: Automatic

Scale to fit paper size

Destination Paper Size: Suggested Paper: A4

Scale down only

1 of 1

PDF Hide Details Cancel Print

1. Collate pages

Select this option to print sets of multi-page documents in the original page order. When this option is selected, one complete copy of your document will print, and then reprint according to the number of copies you choose. If this option is not selected, then each page will print according to the number of copies chosen before the next page of the document is printed.

2. Pages to Print

Select which pages you want to print (even pages or odd pages).

3. Page Order

Select the page order.

4. Scale to fit paper size

Select this option to enlarge or reduce the pages in your document to fit the selected paper size.

5. Destination Paper Size

Select the paper size to print on.

6. Scale down only

Select this option if you want to reduce the pages in your document when they are too large for the selected paper size. If this option is selected and the document is formatted for a paper size that is smaller than the paper size you are using, the document will be printed at its original size.

Print Settings

Printer: FUJI XEROX DocuPrint XXXXX

Presets: Default Settings

Copies: 1 Two-Sided

Pages: All
 From: 1 to: 1

Paper Size: A4 210 by 297 mm

Orientation: Scale: 100%

Print Settings

Media Type: Plain Paper

Print Quality: 600 dpi

Paper Source: Auto Select

1 of 1

Advanced

? PDF Hide Details Cancel Print

1. Media Type

Select the type of media you want to use. To achieve the best print results, the machine automatically adjusts its print settings according to the selected media type.

2. Print Quality

Select the print resolution you want. Because print quality and speed are related, the higher the quality, the longer it will take to print the document.

3. Paper Source

Select the paper source setting according to your print conditions or purpose.

4. Advanced

Toner Save Mode

Select this feature to conserve toner by using less toner to print documents; printouts appear lighter, but are still legible.

Graphics Quality

Select either Graphics or Text for the best print quality, based on the type of document you are printing.

Improve Print Output

Select this option to reduce the amount of paper curling and improve the toner fixing.

Density Adjustment

Specify the print density.

Quiet Mode

Select this option to reduce printing noise.

Other Print Options

Skip Blank Page

Select this option to allow the printer driver to automatically detect blank pages and exclude them from printing.

Secure Print

Printer: FUJI XEROX DocuPrint XXXXX

Presets: Default Settings

Copies: 1 Two-Sided

Pages: All
 From: 1 to: 1

Paper Size: A4 210 by 297 mm

Orientation: Scale: 100%

Secure Print

Secure Print

User Name :

Job Name :

Password :

? PDF Hide Details Cancel Print

1. Secure Print

This feature ensures that confidential or sensitive documents do not print until you enter a password on the machine's control panel.



Related Information

- [Print from Your Computer \(Mac\)](#)

Related Topics

- [Print a Document \(Mac\)](#)
- [Print on Both Sides of the Paper \(Mac\)](#)
- [Print More Than One Page on a Single Sheet of Paper \(N in 1\) \(Mac\)](#)

Print One Page Duplicates on Different Types of Paper

Use the Carbon Copy function to make multiple copies of the same print data, as if printing on carbon paper. Send the data to individual paper trays that you pre-loaded with different paper types or colours.

For example, you may want to set the machine to send your print data to Tray1, which you have pre-loaded with blue coloured paper, and then reprint the data in a certain location on the page from the MP Tray, which you have pre-loaded with yellow coloured paper that already contains text.

If you load blue paper in Tray 1 and yellow paper in the MP tray, the printer will automatically feed paper for Sheet 1 from Tray 1 and Sheet 2 from the MP Tray.

If you enable the Carbon Copy function, the machine will always make copies automatically.



(Windows®)

The carbon copy function also allows you to select a different printing macro for each page.

1. Press  [Settings] > [All Settings] > [Printer] > [Carbon Menu] > [Carbon Copy] > [On].
2. Swipe up or down or press ▲ or ▼ to display the [Copies] option, and then press the [Copies] option.
3. Enter the number of copies you want, and then press [OK].
4. Swipe up or down or press ▲ or ▼ to display the [Copy1 Tray] option, and then press the [Copy1 Tray] option.
5. Swipe up or down or press ▲ or ▼ to display the paper tray you want to configure the [Copy1 Tray] option, and then press the paper tray.



(Windows®)

- a. Swipe up or down or press ▲ or ▼ to display the [Copy1 Macro] option, and then press the [Copy1 Macro] option.
- b. Swipe up or down or press ▲ or ▼ to display the ID number of macro you want to use, and then press it.

6. Repeat these steps until you have selected all the tray settings for each copy.
7. Press .
8. Send your print job to the machine.



Related Information

- [Print](#)

Related Topics

- [Use a Macro from Your Computer \(Windows®\)](#)

Cancel a Print Job

1. Press .



To cancel multiple print jobs, press and hold  for about four seconds.



Related Information



- [Print](#)

Related Topics

- [Printing Problems](#)

Test Print

If there are problems with print quality, follow these instructions to do a test print.

1. Press  [Settings] > [All Settings] > [Printer] > [Print Options] > [Test Print] > [Yes].
2. Press .



Related Information

- [Print](#)

Related Topics

- [Improve the Print Quality](#)
-

Scan

- [Scan Using the Scan Button on Your Fuji Xerox Machine](#)
- [Scan from Your Computer\(Windows®\)](#)
- [Configure Scan Settings Using Web Based Management](#)
- [Scan Using iPrint&Scan \(Mac\)](#)

Scan Using the Scan Button on Your Fuji Xerox Machine



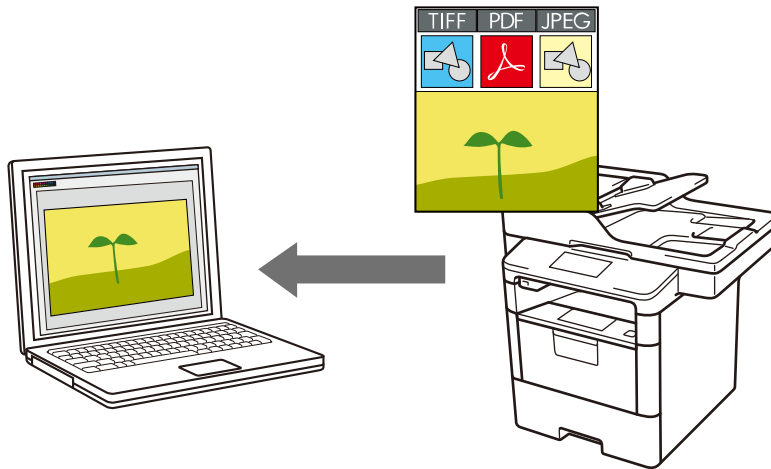

- [Scan Photos and Graphics](#)
- [Save Scanned Data to a Folder as a PDF File](#)
- [Save Scanned Data to a USB Flash Drive](#)
- [Scan to an Editable Text File \(OCR\)](#)
- [Scan to Email Attachment](#)
- [Send Scanned Data to an Email Server](#)
- [Scan to FTP](#)
- [Scan to SSH FTP \(SFTP\)](#)
- [Scan to Network \(Windows®\)](#)
- [Scan to SharePoint®](#)
- [Web Services for Scanning on Your Network \(Windows® 7, Windows® 8 and Windows® 10\)](#)
- [Change Scan Button Settings from ControlCenter4 \(Windows®\)](#)
- [Change Scan Button Settings from iPrint&Scan \(Mac\)](#)
- [Configure Certificate for Signed PDF](#)
- [Disable Scanning from Your Computer](#)

Scan Photos and Graphics

Send scanned photos or graphics directly to your computer.



Use the Scan button on the machine to make temporary changes to the scan settings. To make permanent changes, use Fuji Xerox's ControlCenter software.

1. Load your document.
2. Press  [Scan].
3. Swipe left or right to display  [to Image].
4. Press  [to Image].
The icon moves to the middle of the touchscreen and is highlighted in blue.
5. Press  [to Image].
6. If the machine is connected over the network, swipe up or down or press ▲ or ▼ to display the computer where you want to send data, and then press the computer name.



If the LCD prompts you to enter a PIN for the computer, enter the four-digit PIN on the LCD, and then press [OK].

7. Do one of the following:
 - To change the scan settings, press [Options], and then go to the next step.
 - To use the default scan settings, press [Start].
The machine starts scanning. If you are using the machine's scanner glass, follow the touchscreen instructions to complete the scanning job.



To change scan settings, a computer with Fuji Xerox's Control Center software installed must be connected to the machine.

8. To scan both sides of the document (DocuPrint M385 z/DocuPrint M375 z):
 - Press [2-sided Scan], and then select the document type.

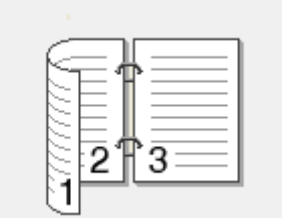
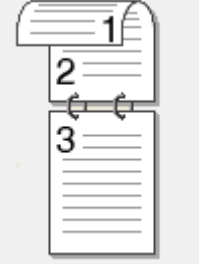
Option	Description
2-sided Scan: Long Edge	
2-sided Scan: Short Edge	

9. Select the scan settings you want to change:

- [Scan Settings]
- [Scan Type]
- [Resolution]
- [File Type]
- [Document Size]
- [Brightness]
- [Contrast]
(available only for the [Colour] and [Grey] options)
- [ADF Auto Deskew]
- [Skip Blank Page]
- [Remove Background Colour]
(available only for the [Colour] and [Grey] options)



To save the settings as a shortcut, press [Save as Shortcut].

10. Press [OK].

11. Press [Start].

The machine starts scanning. If you are using the machine's scanner glass, follow the touchscreen instructions to complete the scanning job.



Related Information

- [Scan Using the Scan Button on Your Fuji Xerox Machine](#)

Related Topics



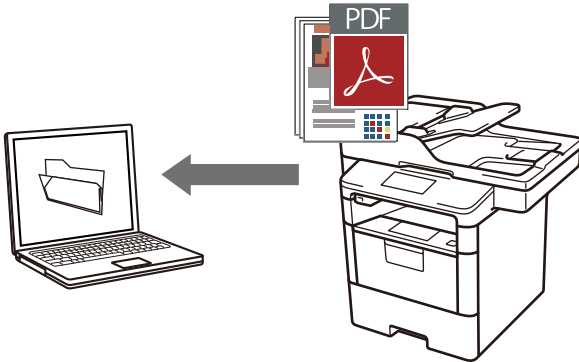

- [Change Scan Button Settings from ControlCenter4 \(Windows®\)](#)
- [Change Scan Button Settings from iPrint&Scan \(Mac\)](#)

Save Scanned Data to a Folder as a PDF File

Scan documents and save them to a folder on your computer as PDF files.



Use the Scan button on the machine to make temporary changes to the scan settings. To make permanent changes, use Fuji Xerox's ControlCenter software.

1. Load your document.
2. Press  [Scan].
3. Swipe left or right to display  [to File].
4. Press  [to File].
The icon moves to the middle of the touchscreen and is highlighted in blue.
5. Press  [to File].
6. If the machine is connected over the network, swipe up or down or press ▲ or ▼ to display the computer where you want to send data, and then press the computer name.



If the LCD prompts you to enter a PIN for the computer, enter the four-digit PIN on the LCD, and then press [OK].

7. Do one of the following:
 - To change the scan settings, press [Options], and then go to the next step.
 - To use the default scan settings, press [Start].
The machine starts scanning. If you are using the machine's scanner glass, follow the touchscreen instructions to complete the scanning job.



To change scan settings, a computer with Fuji Xerox's Control Center software installed must be connected to the machine.

8. To scan both sides of the document (DocuPrint M385 z/DocuPrint M375 z):
 - Press [2-sided Scan], and then select the document type.

Option	Description
--------	-------------

2-sided Scan: Long Edge

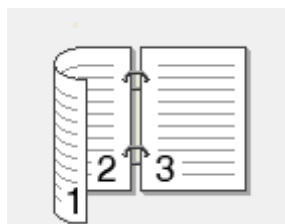

Option	Description
2-sided Scan: Short Edge	

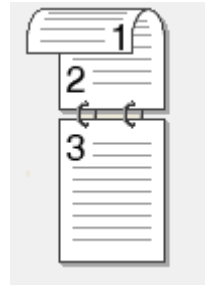

9. Select the scan settings you want to change:

- [Scan Settings]
- [Scan Type]
- [Resolution]
- [File Type]
- [Document Size]
- [Brightness]
- [Contrast]
(available only for the [Colour] and [Grey] options)
- [ADF Auto Deskew]
- [Skip Blank Page]
- [Remove Background Colour]
(available only for the [Colour] and [Grey] options)



To save the settings as a shortcut, press [Save as Shortcut].

10. Press [OK].

11. Press [Start].

The machine starts scanning. If you are using the machine's scanner glass, follow the touchscreen instructions to complete the scanning job.



Related Information

- [Scan Using the Scan Button on Your Fuji Xerox Machine](#)

Related Topics

- [Change Scan Button Settings from ControlCenter4 \(Windows®\)](#)
 - [Change Scan Button Settings from iPrint&Scan \(Mac\)](#)
-

Save Scanned Data to a USB Flash Drive

Scan documents directly to a USB flash drive.

1. Load your document.
2. Insert a USB flash drive into your machine.
The LCD automatically changes.
3. Press [Scan to USB].
4. Do one of the following:
 - To change the settings, press [Options], and then select the button you want to change. Follow the machine's instructions.



- To set your own default settings: after making changes to settings, press the [Set New Default] option, and then press [Yes].
- To restore the factory settings: press [Factory Reset], and then press [Yes].

- Press [Start] to start scanning without changing additional settings.
5. To scan both sides of the document (DocuPrint M385 z/DocuPrint M375 z):
 - Press [2-sided Scan], and then select the document type.

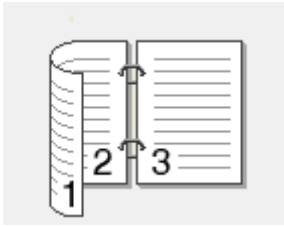
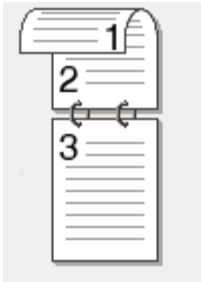
Option	Description
2-sided Scan: Long Edge	
2-sided Scan: Short Edge	

6. Select the scan settings you want to change:
 - [Scan Type]
 - [Resolution]
 - [File Type]
 - [Document Size]
 - [File Name]
 - [File Name Style]
 - [File Size]
 - [Brightness]
 - [Contrast]
(available only for the [Colour] and [Grey] options)

-
- [ADF Auto Deskew]
 - [Skip Blank Page]
 - [Remove Background Colour]
(available only for the [Colour] and [Grey] options)
-



To save the settings as a shortcut, press [Save as Shortcut].

7. Press [OK].

8. Press [Start].

The machine starts scanning. If you are using the machine's scanner glass, follow the touchscreen instructions to complete the scanning job.

IMPORTANT

The LCD displays a message while reading the data. DO NOT unplug the power cord or remove the USB flash drive from the machine while it is reading the data. You could lose your data or damage the USB flash drive.



Related Information

- [Scan Using the Scan Button on Your Fuji Xerox Machine](#)
-

Scan to an Editable Text File (OCR)

Your machine can convert characters in a scanned document to text using optical character recognition (OCR) technology. You can edit this text using your preferred text-editing application.

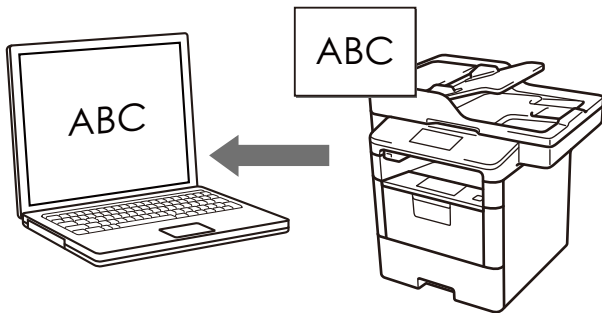

- The Scan to OCR feature is available for certain languages.
- Use the Scan button on the machine to make temporary changes to the scan settings. To make permanent changes, use Fuji Xerox's ControlCenter software.

1. Load your document.

2. Press  [Scan].

3. Swipe left or right to display  [to OCR].

4. Press  [to OCR].

The icon moves to the middle of the touchscreen and is highlighted in blue.

5. Press  [to OCR].

6. If the machine is connected over the network, swipe up or down or press ▲ or ▼ to display the computer where you want to send data, and then press the computer name.



If the LCD prompts you to enter a PIN for the computer, enter the four-digit PIN on the LCD, and then press [OK].

7. Do one of the following:

- To change the scan settings, press [Options], and then go to the next step.
- To use the default scan settings, press [Start].

The machine starts scanning. If you are using the machine's scanner glass, follow the touchscreen instructions to complete the scanning job.



To change scan settings, a computer with Fuji Xerox's Control Center software installed must be connected to the machine.

8. To scan both sides of the document (DocuPrint M385 z/DocuPrint M375 z):

- Press [2-sided Scan], and then select the document type.

Option	Description
--------	-------------

2-sided Scan: Long Edge

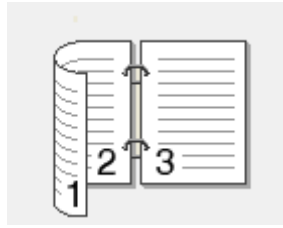

2-sided Scan: Short Edge

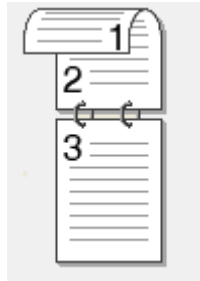

9. Select the scan settings you want to change:

- [Scan Settings]
- [Scan Type]
- [Resolution]
- [File Type]
- [Document Size]
- [Brightness]
- [Contrast]
(available only for the [Colour] and [Grey] options)
- [ADF Auto Deskew]
- [Skip Blank Page]
- [Remove Background Colour]
(available only for the [Colour] and [Grey] options)



To save the settings as a shortcut, press [Save as Shortcut].

10. Press [OK].

11. Press [Start].

The machine starts scanning. If you are using the machine's scanner glass, follow the touchscreen instructions to complete the scanning job.



Related Information

- [Scan Using the Scan Button on Your Fuji Xerox Machine](#)

Related Topics

- [Change Scan Button Settings from ControlCenter4 \(Windows®\)](#)
- [Change Scan Button Settings from iPrint&Scan \(Mac\)](#)

Scan to Email Attachment



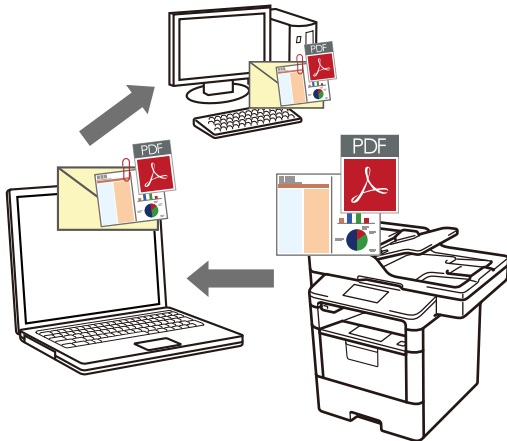

Send a scanned document as an email attachment.



- Use the Scan button on the machine to make temporary changes to the scan settings. To make permanent changes, use Fuji Xerox's ControlCenter software.
- The Scan to Email feature does not support Webmail services. Use the Scan to Image or Scan to File feature to scan a document or a picture, and then attach the scanned file to an email message.



The machine scans to your default email client.

1. Load your document.
2. Press  [Scan].
3. Swipe left or right to display  [to E-mail].
4. Press  [to E-mail].
The icon moves to the middle of the touchscreen and is highlighted in blue.
5. Press  [to E-mail].
6. If the machine is connected over the network, swipe up or down or press ▲ or ▼ to display the computer where you want to send data, and then press the computer name.



If the LCD prompts you to enter a PIN for the computer, enter the four-digit PIN on the LCD, and then press [OK].

7. Do one of the following:
 - To change the scan settings, press [Options], and then go to the next step.
 - To use the default scan settings, press [Start].
The machine starts scanning. If you are using the machine's scanner glass, follow the touchscreen instructions to complete the scanning job.



To change scan settings, a computer with Fuji Xerox's Control Center software installed must be connected to the machine.

8. To scan both sides of the document (DocuPrint M385 z/DocuPrint M375 z):
 - Press [2-sided Scan], and then select the document type.

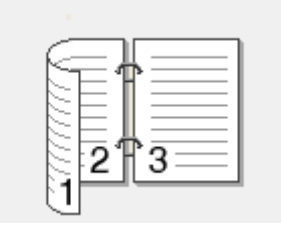
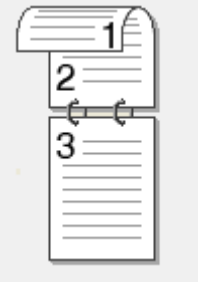
Option	Description
2-sided Scan: Long Edge	
2-sided Scan: Short Edge	

9. Select the scan settings you want to change:

- [Scan Settings]
- [Scan Type]
- [Resolution]
- [File Type]
- [Document Size]
- [Brightness]
- [Contrast]
(available only for the [Colour] and [Grey] options)
- [ADF Auto Deskew]
- [Skip Blank Page]
- [Remove Background Colour]
(available only for the [Colour] and [Grey] options)



To save the settings as a shortcut, press [Save as Shortcut].

10. Press [OK].

11. Press [Start].

The machine starts scanning. If you are using the machine's scanner glass, follow the touchscreen instructions to complete the scanning job.



Related Information

- [Scan Using the Scan Button on Your Fuji Xerox Machine](#)

Related Topics

- [Change Scan Button Settings from ControlCenter4 \(Windows®\)](#)
- [Change Scan Button Settings from iPrint&Scan \(Mac\)](#)

Send Scanned Data to an Email Server

Related Models: DocuPrint M385 z/DocuPrint M375 z

Send scanned data from your Fuji Xerox machine directly to your email server, for delivery to an email recipient without using a computer.

- To send scanned data to an email server, you must configure your machine to communicate with your network and mail server. You can configure these items from the machine's control panel, Web Based Management, or Remote Setup.

1. Load your document.

2. Press  [Scan].

3. Swipe left or right to display  [to E-mail Server].

4. Press  [to E-mail Server].

The icon moves to the middle of the touchscreen and is highlighted in blue.

5. Press  [to E-mail Server].

6. Do one of the following to enter the destination email address:

- To enter the email address manually, press [Manual], and then enter the email address using the keyboard on the LCD. When finished, press [OK].
- If the email address is stored in the machine's address book, press [Address Book], and then select the email address. Press [OK].

7. Confirm the email address, and then press [Next].

8. Do one of the following:

- To change the settings, press [Options], and then select the button you want to change. Follow the machine's instructions.



- To set your own default settings: after making changes to settings, press the [Set New Default] option, and then press [Yes].
- To restore the factory settings: press [Factory Reset], and then press [Yes].

- Press [Start] to start scanning without changing additional settings.

9. To scan both sides of the document (DocuPrint M385 z/DocuPrint M375 z):

- Press [2-sided Scan], and then select the document type.

Option	Description
--------	-------------

2-sided Scan: Long Edge

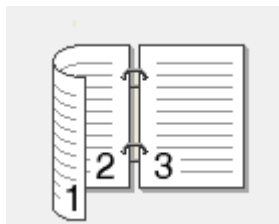

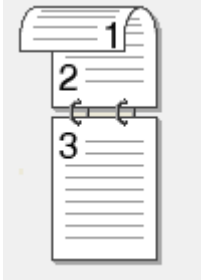
Option	Description
2-sided Scan: Short Edge	

10. Select the scan settings you want to change:

- [Scan Type]
- [Resolution]
- [File Type]
- [Document Size]
- [File Name]
- [File Name Style]
- [File Size]
- [Brightness]
- [Contrast]
(available only for the [Colour] and [Grey] options)
- [ADF Auto Deskew]
- [Skip Blank Page]
- [Remove Background Colour]
(available only for the [Colour] and [Grey] options)



To save the settings as a shortcut, press [Save as Shortcut].
(This function may not be available depending on your machine conditions.)

11. Press [OK].

12. Press [Start].

The machine starts scanning. If you are using the machine's scanner glass, follow the touchscreen instructions to complete the scanning job.



Related Information

- [Scan Using the Scan Button on Your Fuji Xerox Machine](#)

Related Topics

- [How to Enter Text on Your Fuji Xerox Machine](#)

Scan to FTP

Scan documents directly to an FTP server when you need to share the scanned information. For added convenience, configure different profiles to save your favourite Scan to FTP destinations.

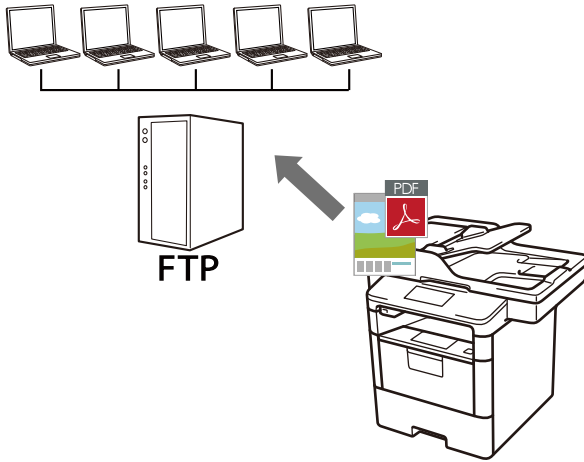

- [Set up a Scan to FTP Profile](#)
- [Upload Scanned Data to an FTP Server](#)

Set up a Scan to FTP Profile

Set up a Scan to FTP Profile to scan and upload the scanned data directly to an FTP location.

We recommend Microsoft® Internet Explorer® 11/Edge for Windows® and Safari 9/10/11 for Mac. Make sure that JavaScript and Cookies are always enabled in whichever browser you use.

1. Start your web browser.

Type "http://machine's IP address" in your browser's address bar (where "machine's IP address" is the IP address of the machine or the print server name). For example: http://192.0.2.1

Type a password, and then click . The default password is "x-admin". To ensure security, it is important you change the password.

2. Click the **Scan** tab.
3. Click the **Scan to FTP/SFTP/Network/SharePoint** menu in the left navigation bar.
4. Select the **FTP** option, and then click **Submit**.

Scan to FTP/SFTP/Network/SharePoint

Profile 1	<input checked="" type="radio"/> FTP <input type="radio"/> SFTP <input type="radio"/> Network <input type="radio"/> SharePoint
Profile 2	<input checked="" type="radio"/> FTP <input type="radio"/> SFTP <input type="radio"/> Network <input type="radio"/> SharePoint
Profile 3	<input checked="" type="radio"/> FTP <input type="radio"/> SFTP <input type="radio"/> Network <input type="radio"/> SharePoint
Profile 4	<input checked="" type="radio"/> FTP <input type="radio"/> SFTP <input type="radio"/> Network <input type="radio"/> SharePoint
Profile 5	<input checked="" type="radio"/> FTP <input type="radio"/> SFTP <input type="radio"/> Network <input type="radio"/> SharePoint
Profile 6	<input checked="" type="radio"/> FTP <input type="radio"/> SFTP <input type="radio"/> Network <input type="radio"/> SharePoint
Profile 7	<input checked="" type="radio"/> FTP <input type="radio"/> SFTP <input type="radio"/> Network <input type="radio"/> SharePoint
Profile 8	<input checked="" type="radio"/> FTP <input type="radio"/> SFTP <input type="radio"/> Network <input type="radio"/> SharePoint
Profile 9	<input checked="" type="radio"/> FTP <input type="radio"/> SFTP <input type="radio"/> Network <input type="radio"/> SharePoint
Profile 10	<input checked="" type="radio"/> FTP <input type="radio"/> SFTP <input type="radio"/> Network <input type="radio"/> SharePoint
Profile 11	<input checked="" type="radio"/> FTP <input type="radio"/> SFTP <input type="radio"/> Network <input type="radio"/> SharePoint
Profile 12	<input checked="" type="radio"/> FTP <input type="radio"/> SFTP <input type="radio"/> Network <input type="radio"/> SharePoint
Profile 13	<input checked="" type="radio"/> FTP <input type="radio"/> SFTP <input type="radio"/> Network <input type="radio"/> SharePoint
Profile 14	<input checked="" type="radio"/> FTP <input type="radio"/> SFTP <input type="radio"/> Network <input type="radio"/> SharePoint
Profile 15	<input checked="" type="radio"/> FTP <input type="radio"/> SFTP <input type="radio"/> Network <input type="radio"/> SharePoint
Profile 16	<input checked="" type="radio"/> FTP <input type="radio"/> SFTP <input type="radio"/> Network <input type="radio"/> SharePoint
Profile 17	<input checked="" type="radio"/> FTP <input type="radio"/> SFTP <input type="radio"/> Network <input type="radio"/> SharePoint
Profile 18	<input checked="" type="radio"/> FTP <input type="radio"/> SFTP <input type="radio"/> Network <input type="radio"/> SharePoint
Profile 19	<input checked="" type="radio"/> FTP <input type="radio"/> SFTP <input type="radio"/> Network <input type="radio"/> SharePoint
Profile 20	<input checked="" type="radio"/> FTP <input type="radio"/> SFTP <input type="radio"/> Network <input type="radio"/> SharePoint
Profile 21	<input checked="" type="radio"/> FTP <input type="radio"/> SFTP <input type="radio"/> Network <input type="radio"/> SharePoint
Profile 22	<input checked="" type="radio"/> FTP <input type="radio"/> SFTP <input type="radio"/> Network <input type="radio"/> SharePoint
Profile 23	<input checked="" type="radio"/> FTP <input type="radio"/> SFTP <input type="radio"/> Network <input type="radio"/> SharePoint
Profile 24	<input checked="" type="radio"/> FTP <input type="radio"/> SFTP <input type="radio"/> Network <input type="radio"/> SharePoint
Profile 25	<input checked="" type="radio"/> FTP <input type="radio"/> SFTP <input type="radio"/> Network <input type="radio"/> SharePoint

- Click the **Scan to FTP/SFTP/Network/SharePoint Profile** menu in the left navigation bar.
- Select the profile you want to set up or change.
- In the **Profile Name** field, type a name for this server profile (up to 15 alphanumeric characters). The machine will display this name on the LCD.
- In the **Host Address** field, type the Host Address (for example: ftp.example.com; up to 64 characters) or the IP address (for example: 192.23.56.189).
- In the **Username** field, type a user name (up to 32 characters) that has permission to write data to the FTP server.
- In the **Password** field, type the password (up to 32 characters) associated with the user name you entered in the **Username** field. Type the password again in the **Retype password** field.
- In the **Store Directory** field, type the path to the folder on the FTP server where you want to send your scanned data. Do not type a slash mark at the beginning of the path (see example).

Store Directory

fujjxerox/abc

12. Click the **File Name** drop-down list, and then select a file name prefix from the preset names provided, or from user-defined names. The file name used for the scanned document will be the file name prefix you select, followed by the last six digits of the flatbed/ADF scanner counter and the file extension (for example: "Estimate_098765.pdf").
13. Click the **Quality** drop-down list, and then select a quality setting. If you choose the **User Select** option, the machine will prompt users to select a setting each time they use the scan profile.
14. Click the **File Type** drop-down list, and then select the file type you want to use for the scanned document. If you choose the **User Select** option, the machine will prompt users to select a setting each time they use the scan profile.
15. Click the **Document Size** drop-down list, and then select your document size from the list. This is necessary to make sure the scanned file is the correct size.
16. Click the **File Size** drop-down list, and then select your file size from the list.
17. Click the **Remove Background Color** drop-down list, and then select the level from the list. You can use this feature to remove the background colour of documents to make the scanned data more legible.
18. Set the **Passive Mode** option to off or on depending on your FTP server and network firewall configuration. The default setting is on. In most cases this setting does not need to be changed.
19. Change the **Port Number** setting used to access the FTP server. The default for this setting is port 21. In most cases this setting does not need to be changed.
20. Click **Submit**.



Using the following characters: ?, /, \, ", :, <, >, | or * may cause a sending error.



Related Information

- [Scan to FTP](#)
-

Upload Scanned Data to an FTP Server

Share scanned information by saving it to your FTP server.

1. Load your document.

2. Press  [Scan].

3. Swipe left or right to display  [to FTP/SFTP].

4. Press  [to FTP/SFTP].

The icon moves to the middle of the touchscreen and is highlighted in blue.

5. Press  [to FTP/SFTP].

6. The FTP and SFTP server profiles you have set up using Web Based Management are listed. Swipe up or down or press ▲ or ▼ to select one of the FTP server profiles listed, and then press the profile you want. If the profile is not complete (for example, if the logon account name and password are missing, or if the quality or file type is not specified), you will be prompted to enter any missing information.

7. Press [Start].

The machine starts scanning. If you are using the machine's scanner glass, follow the touchscreen instructions to complete the scanning job.



Related Information

- [Scan to FTP](#)

Related Topics

- [How to Enter Text on Your Fuji Xerox Machine](#)

Scan to SSH FTP (SFTP)

Scan documents directly to an SFTP server, a secure version of an FTP server. For added convenience, configure different profiles to save your favourite Scan to SFTP destinations.

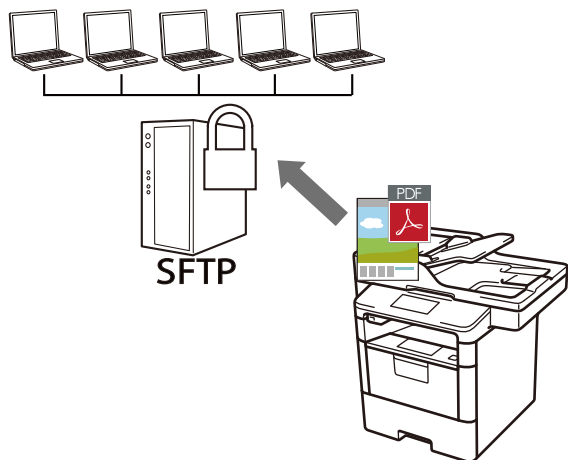

- [Set up a Scan to SFTP Profile](#)
- [Create a Client Key Pair Using Web Based Management](#)
- [Export a Client Key Pair Using Web Based Management](#)
- [Import a Server Public Key Using Web Based Management](#)
- [Upload Scanned Data to an SFTP Server](#)

Set up a Scan to SFTP Profile

Set up a Scan to SFTP Profile to scan and upload scanned data directly to an SFTP location.

We recommend Microsoft® Internet Explorer® 11/Edge for Windows® and Safari 9/10/11 for Mac. Make sure that JavaScript and Cookies are always enabled in whichever browser you use.

1. Start your web browser.

Type "http://machine's IP address" in your browser's address bar (where "machine's IP address" is the IP address of the machine or the print server name). For example: http://192.0.2.1

Type a password, and then click . The default password is "x-admin". To ensure security, it is important you change the password.

2. Click the **Scan** tab.
3. Click the **Scan to FTP/SFTP/Network/SharePoint** menu in the left navigation bar.
4. Select the **SFTP** option, and then click **Submit**.

Scan to FTP/SFTP/Network/SharePoint

Profile 1	<input type="radio"/> FTP	<input checked="" type="radio"/> SFTP	<input type="radio"/> Network	<input type="radio"/> SharePoint
Profile 2	<input type="radio"/> FTP	<input checked="" type="radio"/> SFTP	<input type="radio"/> Network	<input type="radio"/> SharePoint
Profile 3	<input type="radio"/> FTP	<input checked="" type="radio"/> SFTP	<input type="radio"/> Network	<input type="radio"/> SharePoint
Profile 4	<input type="radio"/> FTP	<input checked="" type="radio"/> SFTP	<input type="radio"/> Network	<input type="radio"/> SharePoint
Profile 5	<input type="radio"/> FTP	<input checked="" type="radio"/> SFTP	<input type="radio"/> Network	<input type="radio"/> SharePoint
Profile 6	<input type="radio"/> FTP	<input checked="" type="radio"/> SFTP	<input type="radio"/> Network	<input type="radio"/> SharePoint
Profile 7	<input type="radio"/> FTP	<input checked="" type="radio"/> SFTP	<input type="radio"/> Network	<input type="radio"/> SharePoint
Profile 8	<input type="radio"/> FTP	<input checked="" type="radio"/> SFTP	<input type="radio"/> Network	<input type="radio"/> SharePoint
Profile 9	<input type="radio"/> FTP	<input checked="" type="radio"/> SFTP	<input type="radio"/> Network	<input type="radio"/> SharePoint
Profile 10	<input type="radio"/> FTP	<input checked="" type="radio"/> SFTP	<input type="radio"/> Network	<input type="radio"/> SharePoint
Profile 11	<input type="radio"/> FTP	<input checked="" type="radio"/> SFTP	<input type="radio"/> Network	<input type="radio"/> SharePoint
Profile 12	<input type="radio"/> FTP	<input checked="" type="radio"/> SFTP	<input type="radio"/> Network	<input type="radio"/> SharePoint
Profile 13	<input type="radio"/> FTP	<input checked="" type="radio"/> SFTP	<input type="radio"/> Network	<input type="radio"/> SharePoint
Profile 14	<input type="radio"/> FTP	<input checked="" type="radio"/> SFTP	<input type="radio"/> Network	<input type="radio"/> SharePoint
Profile 15	<input type="radio"/> FTP	<input checked="" type="radio"/> SFTP	<input type="radio"/> Network	<input type="radio"/> SharePoint
Profile 16	<input type="radio"/> FTP	<input checked="" type="radio"/> SFTP	<input type="radio"/> Network	<input type="radio"/> SharePoint
Profile 17	<input type="radio"/> FTP	<input checked="" type="radio"/> SFTP	<input type="radio"/> Network	<input type="radio"/> SharePoint
Profile 18	<input type="radio"/> FTP	<input checked="" type="radio"/> SFTP	<input type="radio"/> Network	<input type="radio"/> SharePoint
Profile 19	<input type="radio"/> FTP	<input checked="" type="radio"/> SFTP	<input type="radio"/> Network	<input type="radio"/> SharePoint
Profile 20	<input type="radio"/> FTP	<input checked="" type="radio"/> SFTP	<input type="radio"/> Network	<input type="radio"/> SharePoint
Profile 21	<input type="radio"/> FTP	<input checked="" type="radio"/> SFTP	<input type="radio"/> Network	<input type="radio"/> SharePoint
Profile 22	<input type="radio"/> FTP	<input checked="" type="radio"/> SFTP	<input type="radio"/> Network	<input type="radio"/> SharePoint
Profile 23	<input type="radio"/> FTP	<input checked="" type="radio"/> SFTP	<input type="radio"/> Network	<input type="radio"/> SharePoint
Profile 24	<input type="radio"/> FTP	<input checked="" type="radio"/> SFTP	<input type="radio"/> Network	<input type="radio"/> SharePoint
Profile 25	<input type="radio"/> FTP	<input checked="" type="radio"/> SFTP	<input type="radio"/> Network	<input type="radio"/> SharePoint

- Click the **Scan to FTP/SFTP/Network/SharePoint Profile** menu in the left navigation bar.
- Select the profile you want to set up or change.
- In the **Profile Name** field, type a name for this server profile (up to 15 alphanumeric characters). The machine will display this name on the LCD.
- In the **Host Address** field, type the Host Address (for example: sftp.example.com; up to 64 characters) or the IP address (for example: 192.23.56.189).
- In the **Username** field, type the user name (up to 32 characters) that has permission to write data to the SFTP server.
- In the **Auth. Method** field, select **Password** or **Public Key**.
- Do one of the following:
 - When you select **Password**, type the password (up to 32 characters) associated with the user name you typed in the **Username** field. Type the password again in the **Retype password** field.
 - When you select **Public Key**, select the authentication type from the **Client Key Pair** drop-down list.

12. Select the authentication type from the **Server Public Key** drop-down list.
13. In the **Store Directory** field, type the path to the folder on the SFTP server where you want to send your scanned data. Do not type a slash mark at the beginning of the path (see example).

Store Directory

fujixerox/abc

14. Click the **File Name** drop-down list, and then select a file name prefix from the preset names provided, or from user-defined names. The file name used for the scanned document will be the file name prefix you select, followed by the last six digits of the flatbed/ADF scanner counter and the file extension (for example: "Estimate_098765.pdf").
15. Click the **Quality** drop-down list, and then select a quality setting. If you choose the **User Select** option, the machine will prompt users to select a setting each time they use the scan profile.
16. Click the **File Type** drop-down list, and then select the file type you want to use for the scanned document. If you choose the **User Select** option, the machine will prompt users to select a setting each time they use the scan profile.
17. Click the **Document Size** drop-down list, and then select your document size from the list. This is necessary to make sure the scanned file is the correct size.
18. Click the **File Size** drop-down list, and then select your file size from the list.
19. Click the **Remove Background Color** drop-down list, and then select the level from the list. You can use this feature to remove the background colour of documents to make the scanned data more legible.
20. You can change the **Port Number** setting used to access the SFTP server. The default for this setting is port 22. In most cases this setting does not need to be changed.
21. Click **Submit**.



Using the following characters: ?, /, \, ", :, <, >, | or * may cause a sending error.



Related Information

- [Scan to SSH FTP \(SFTP\)](#)
-

Create a Client Key Pair Using Web Based Management

1. Start your web browser.
2. Type "http://machine's IP address" in your browser's address bar (where "machine's IP address" is the machine's IP address).

For example:

http://192.0.2.1



- If you are using a Domain Name System or enable a NetBIOS name, you can type another name, such as "SharedPrinter" instead of the IP address.

- For example:

http://SharedPrinter

If you enable a NetBIOS name, you can also use the node name.

- For example:

http://fxnxxxxxxxxxxxx

The NetBIOS name can be found in the Network Configuration Report.

- For Mac, access Web Based Management by clicking the machine's icon on the **Status Monitor** screen.

3. Type a password, and then click . The default password is "x-admin". To ensure security, it is important you change the password.
4. Click the **Network** tab.
5. Click the **Security** tab.
6. Click **Client Key Pair** in the left navigation bar.
7. Click **Create New Client Key Pair**.
8. In the **Client Key Pair Name** field, type the name (up to 20 characters) you want.
9. Click the **Public Key Algorithm** drop-down list, and then select the algorithm you want.
10. Click **Submit**.

The client key pair is created and saved in your machine's memory. The client key pair name and public key algorithm will be displayed in the **Client Key Pair List**.



Related Information

- [Scan to SSH FTP \(SFTP\)](#)

Export a Client Key Pair Using Web Based Management

1. Start your web browser.
2. Type "http://machine's IP address" in your browser's address bar (where "machine's IP address" is the machine's IP address).

For example:

http://192.0.2.1



- If you are using a Domain Name System or enable a NetBIOS name, you can type another name, such as "SharedPrinter" instead of the IP address.

- For example:

http://SharedPrinter

If you enable a NetBIOS name, you can also use the node name.

- For example:

http://fxnxxxxxxxxxxxx

The NetBIOS name can be found in the Network Configuration Report.

- For Mac, access Web Based Management by clicking the machine's icon on the **Status Monitor** screen.

3. Type a password, and then click . The default password is "x-admin". To ensure security, it is important you change the password.
4. Click the **Network** tab.
5. Click the **Security** tab.
6. Click **Client Key Pair** in the left navigation bar.
7. Click **Export Public Key** shown with **Client Key Pair List**.
8. Click **Submit**.
9. Specify the location where you want to save the file.

The client key pair is exported to your computer.



Related Information

- [Scan to SSH FTP \(SFTP\)](#)

Import a Server Public Key Using Web Based Management

1. Start your web browser.
2. Type "http://machine's IP address" in your browser's address bar (where "machine's IP address" is the machine's IP address).

For example:

http://192.0.2.1



- If you are using a Domain Name System or enable a NetBIOS name, you can type another name, such as "SharedPrinter" instead of the IP address.

- For example:

http://SharedPrinter

If you enable a NetBIOS name, you can also use the node name.

- For example:

http://fxnxxxxxxxxxxxx

The NetBIOS name can be found in the Network Configuration Report.

- For Mac, access Web Based Management by clicking the machine's icon on the **Status Monitor** screen.

3. Type a password, and then click . The default password is "x-admin". To ensure security, it is important you change the password.
4. Click the **Network** tab.
5. Click the **Security** tab.
6. Click **Server Public Key** in the left navigation bar.
7. Click **Import Server Public Key**.
8. Specify the file that you want to import.
9. Click **Submit**.





The server public key is imported to your machine.



Related Information

- [Scan to SSH FTP \(SFTP\)](#)

Upload Scanned Data to an SFTP Server

1. Load your document.
2. Press  [Scan].
3. Swipe left or right to display  [to FTP/SFTP].
4. Press  [to FTP/SFTP].
The icon moves to the middle of the touchscreen and is highlighted in blue.
5. Press  [to FTP/SFTP].
6. The FTP and SFTP server profiles you have set up using Web Based Management are listed. Swipe up or down or press ▲ or ▼ to select one of the SFTP server profiles listed, and then press the profile you want. If the profile is not complete (for example, if the logon account name and password are missing, or if the quality or file type is not specified), you will be prompted to enter any missing information.
7. Press [Start].
The machine starts scanning. If you are using the machine's scanner glass, follow the touchscreen instructions to complete the scanning job.



Related Information

- [Scan to SSH FTP \(SFTP\)](#)

Scan to Network (Windows®)

Scan documents directly to a CIFS server on your local network. For added convenience, you can configure different profiles to save your favourite Scan to Network destinations.

- [Set up a Scan to Network Profile](#)
- [Upload Scanned Data to a CIFS Server](#)

Set up a Scan to Network Profile

Set up a Scan to Network Profile to scan and upload scanned data directly to a folder on a CIFS server.

We recommend Microsoft® Internet Explorer® 8.0/10.0/11.0 for Windows®. Make sure that JavaScript and Cookies are always enabled in whichever browser you use. If a different web browser is used, make sure it is compatible with HTTP 1.0 and HTTP 1.1.

1. Start your web browser.

Type "http://machine's IP address" in your browser's address bar (where "machine's IP address" is the IP address of the machine or the print server name). For example: http://192.0.2.1

Type a password, and then click . The default password is "x-admin". To ensure security, it is important you change the password.

2. Click the **Scan** tab.
3. Click the **Scan to FTP/SFTP/Network/SharePoint** menu in the left navigation bar.
4. Select the **Network** option, and then click **Submit**.

Scan to FTP/SFTP/Network/SharePoint

Profile 1	<input type="radio"/> FTP	<input type="radio"/> SFTP	<input checked="" type="radio"/> Network	<input type="radio"/> SharePoint
Profile 2	<input type="radio"/> FTP	<input type="radio"/> SFTP	<input checked="" type="radio"/> Network	<input type="radio"/> SharePoint
Profile 3	<input type="radio"/> FTP	<input type="radio"/> SFTP	<input checked="" type="radio"/> Network	<input type="radio"/> SharePoint
Profile 4	<input type="radio"/> FTP	<input type="radio"/> SFTP	<input checked="" type="radio"/> Network	<input type="radio"/> SharePoint
Profile 5	<input type="radio"/> FTP	<input type="radio"/> SFTP	<input checked="" type="radio"/> Network	<input type="radio"/> SharePoint
Profile 6	<input type="radio"/> FTP	<input type="radio"/> SFTP	<input checked="" type="radio"/> Network	<input type="radio"/> SharePoint
Profile 7	<input type="radio"/> FTP	<input type="radio"/> SFTP	<input checked="" type="radio"/> Network	<input type="radio"/> SharePoint
Profile 8	<input type="radio"/> FTP	<input type="radio"/> SFTP	<input checked="" type="radio"/> Network	<input type="radio"/> SharePoint
Profile 9	<input type="radio"/> FTP	<input type="radio"/> SFTP	<input checked="" type="radio"/> Network	<input type="radio"/> SharePoint
Profile 10	<input type="radio"/> FTP	<input type="radio"/> SFTP	<input checked="" type="radio"/> Network	<input type="radio"/> SharePoint
Profile 11	<input type="radio"/> FTP	<input type="radio"/> SFTP	<input checked="" type="radio"/> Network	<input type="radio"/> SharePoint
Profile 12	<input type="radio"/> FTP	<input type="radio"/> SFTP	<input checked="" type="radio"/> Network	<input type="radio"/> SharePoint
Profile 13	<input type="radio"/> FTP	<input type="radio"/> SFTP	<input checked="" type="radio"/> Network	<input type="radio"/> SharePoint
Profile 14	<input type="radio"/> FTP	<input type="radio"/> SFTP	<input checked="" type="radio"/> Network	<input type="radio"/> SharePoint
Profile 15	<input type="radio"/> FTP	<input type="radio"/> SFTP	<input checked="" type="radio"/> Network	<input type="radio"/> SharePoint
Profile 16	<input type="radio"/> FTP	<input type="radio"/> SFTP	<input checked="" type="radio"/> Network	<input type="radio"/> SharePoint
Profile 17	<input type="radio"/> FTP	<input type="radio"/> SFTP	<input checked="" type="radio"/> Network	<input type="radio"/> SharePoint
Profile 18	<input type="radio"/> FTP	<input type="radio"/> SFTP	<input checked="" type="radio"/> Network	<input type="radio"/> SharePoint
Profile 19	<input type="radio"/> FTP	<input type="radio"/> SFTP	<input checked="" type="radio"/> Network	<input type="radio"/> SharePoint
Profile 20	<input type="radio"/> FTP	<input type="radio"/> SFTP	<input checked="" type="radio"/> Network	<input type="radio"/> SharePoint
Profile 21	<input type="radio"/> FTP	<input type="radio"/> SFTP	<input checked="" type="radio"/> Network	<input type="radio"/> SharePoint
Profile 22	<input type="radio"/> FTP	<input type="radio"/> SFTP	<input checked="" type="radio"/> Network	<input type="radio"/> SharePoint
Profile 23	<input type="radio"/> FTP	<input type="radio"/> SFTP	<input checked="" type="radio"/> Network	<input type="radio"/> SharePoint
Profile 24	<input type="radio"/> FTP	<input type="radio"/> SFTP	<input checked="" type="radio"/> Network	<input type="radio"/> SharePoint
Profile 25	<input type="radio"/> FTP	<input type="radio"/> SFTP	<input checked="" type="radio"/> Network	<input type="radio"/> SharePoint

5. Click the **Scan to FTP/SFTP/Network/SharePoint Profile** menu in the left navigation bar.
6. Select the profile you want to set up or change.
7. In the **Profile Name** field, type a name for this server profile (up to 15 alphanumeric characters). The machine will display this name on the LCD.
8. In the **Network Folder Path** field, type the path to the folder on the CIFS server where you want to send your scanned data.
9. Click the **File Name** drop-down list, and then select a file name prefix from the preset names provided, or from user-defined names. The file name used for the scanned document will be the file name prefix you select, followed by the last six digits of the flatbed/ADF scanner counter and the file extension (for example: "Estimate_098765.pdf").
10. Click the **Quality** drop-down list, and then select a quality setting. If you choose the **User Select** option, the machine will prompt users to select a setting each time they use the scan profile.

-
11. Click the **File Type** drop-down list, and then select the file type you want to use for the scanned document. If you choose the **User Select** option, the machine will prompt users to select a setting each time they use the scan profile.
 12. Click the **Document Size** drop-down list, and then select your document size from the list. This is necessary to make sure the scanned file is the correct size.
 13. Click the **File Size** drop-down list, and then select your file size from the list.
 14. Click the **Remove Background Color** drop-down list, and then select the level from the list. You can use this feature to remove the background colour of documents to make the scanned data more legible.
 15. To PIN-protect this profile, in the **Use PIN for Authentication** field, select **On**.
 16. If you selected **On** for the **Use PIN for Authentication** field, type a four-digit PIN in the **PIN Code** field.
 17. To set your authentication method, select **Auto**, **Kerberos**, or **NTLMv2** from the **Auth. Method** menu.
 18. In the **Username** field, type a user name (up to 96 characters) that has permission to write data to the folder specified in the **Network Folder Path** field. If the user name is part of a domain, enter the user name in one of the following styles:
user@domain
domain\user
 19. In the **Password** field, type the password (up to 32 characters) associated with the user name you entered in the **Username** field. Type the password again in the **Retype password** field.
 20. To set the Kerberos Server Address manually, in the **Kerberos Server Address** field, type the Kerberos Server Address (for example: kerberos.example.com; up to 64 characters).
 21. Click **Submit**.



Using the following characters: ?, /, \, ", :, <, >, | or * may cause a sending error.

22. You must configure the SNTP protocol (network time server) or you must set the date, time and time zone correctly on the control panel for all authentication methods. The time must match the time used by the Kerberos Server and CIFS Server.



Related Information

- [Scan to Network \(Windows®\)](#)
 - [Set the Date and Time Using Web Based Management](#)
-

Set the Date and Time Using Web Based Management

Make sure the date and time and the time zone settings are set correctly using Web Based Management or the control panel, so the machine's time matches the time being used by the server providing authentication.

Ignore step 1, if you already have a Web Based Management window open.

1. Start your web browser.

Type "http://machine's IP address" in your browser's address bar (where "machine's IP address" is the IP address of the machine or the print server name). For example: http://192.0.2.1

Type a password, and then click . The default password is "x-admin". To ensure security, it is important you change the password.

2. Click the **Administrator** tab.
3. Click the **Date&Time** menu in the left navigation bar.

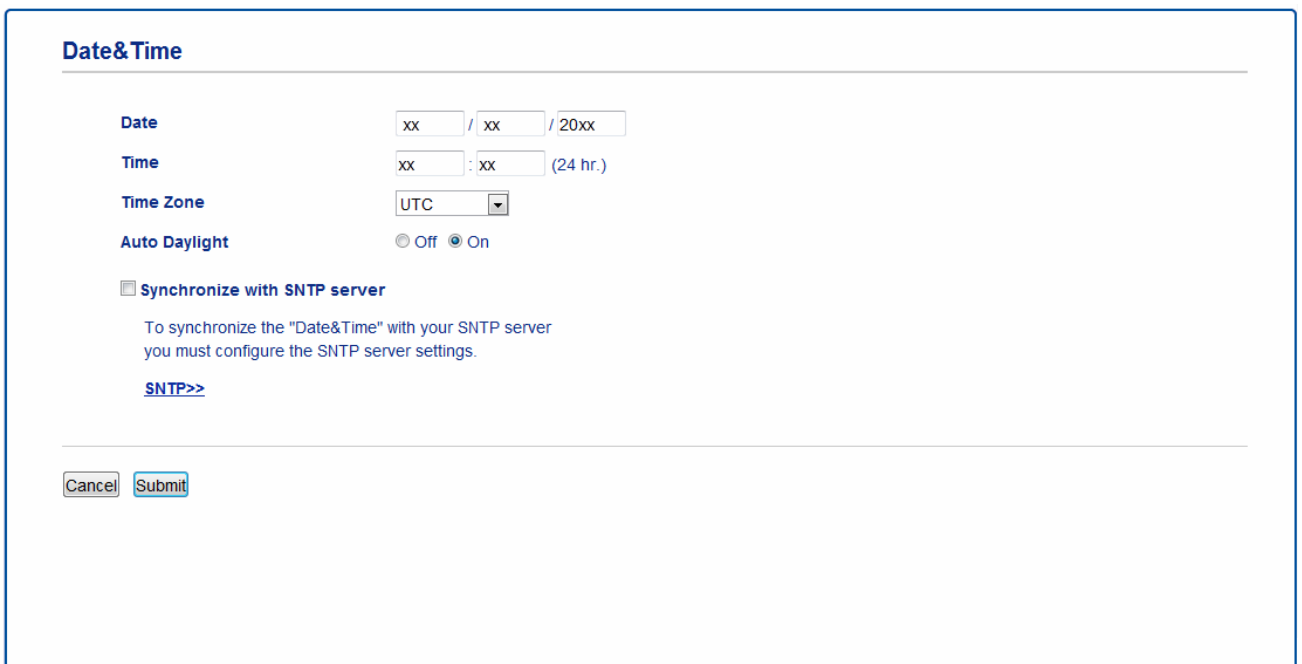

The screenshot shows the "Date&Time" configuration page. It includes the following fields and options:

- Date:** Three input fields for day, month, and year (xx / xx / 20xx).
- Time:** Two input fields for hour and minute (xx : xx) with a "(24 hr.)" label.
- Time Zone:** A dropdown menu currently set to "UTC".
- Auto Daylight:** Radio buttons for "Off" and "On", with "On" selected.
- Synchronize with SNTP server:** A checkbox that is currently unchecked.
- SNTP server settings:** A link labeled "SNTP>>" with a note: "To synchronize the 'Date&Time' with your SNTP server you must configure the SNTP server settings."
- Buttons:** "Cancel" and "Submit" buttons at the bottom left.





4. In the **Date** fields, enter the date.
5. Select the clock type from the **Clock Type** field (available only for some countries).
6. In the **Time** fields, enter the time.
7. Select the time difference between your location and UTC from the **Time Zone** drop-down list, for example, the time zone for Eastern time in the USA and Canada is UTC-05:00.
8. In the **Auto Daylight** field, click **On** to set the machine to change automatically for Daylight Saving Time. It will reset itself forward one hour in the spring, and back one hour in the autumn (available only for some countries).
9. Click **Submit**.



Related Information

- [Set up a Scan to Network Profile](#)

Upload Scanned Data to a CIFS Server

1. Load your document.
2. Press  [Scan].
3. Swipe left or right to display  [to Network].
4. Press  [to Network].
The icon moves to the middle of the touchscreen and is highlighted in blue.
5. Press  [to Network].
6. Swipe up or down or press ▲ or ▼ to select one of the network server profiles listed, and then press the profile you want. If the profile is not complete (for example, if the logon account name and password are missing, or if the quality or file type is not specified), you will be prompted to enter any missing information.
7. Press [Start].
The machine starts scanning. If you are using the machine's scanner glass, follow the touchscreen instructions to complete the scanning job.



Related Information

- [Scan to Network \(Windows®\)](#)

Scan to SharePoint®

Scan documents directly to a SharePoint® server when you need to share the scanned information. For added convenience, configure different profiles to save your favourite Scan to SharePoint® destinations.

- [Set up a Scan to SharePoint® Profile](#)
- [Upload Scanned Data to a SharePoint® Server](#)

Set up a Scan to SharePoint® Profile

Set up a Scan to SharePoint® Profile to scan and upload the scanned data directly to a SharePoint® location.

We recommend Microsoft® Internet Explorer® 11/Edge for Windows® and Safari 9/10/11 for Mac. Make sure that JavaScript and Cookies are always enabled in whichever browser you use.

1. Start your web browser.

Type "http://machine's IP address" in your browser's address bar (where "machine's IP address" is the IP address of the machine or the print server name). For example: http://192.0.2.1

Type a password, and then click . The default password is "x-admin". To ensure security, it is important you change the password.

2. Click the **Scan** tab.
3. Click the **Scan to FTP/SFTP/Network/SharePoint** menu in the left navigation bar.
4. Select the **SharePoint** option, and then click **Submit**.

Scan to FTP/SFTP/Network/SharePoint

Profile 1	<input type="radio"/> FTP <input type="radio"/> SFTP <input type="radio"/> Network <input checked="" type="radio"/> SharePoint
Profile 2	<input type="radio"/> FTP <input type="radio"/> SFTP <input type="radio"/> Network <input checked="" type="radio"/> SharePoint
Profile 3	<input type="radio"/> FTP <input type="radio"/> SFTP <input type="radio"/> Network <input checked="" type="radio"/> SharePoint
Profile 4	<input type="radio"/> FTP <input type="radio"/> SFTP <input type="radio"/> Network <input checked="" type="radio"/> SharePoint
Profile 5	<input type="radio"/> FTP <input type="radio"/> SFTP <input type="radio"/> Network <input checked="" type="radio"/> SharePoint
Profile 6	<input type="radio"/> FTP <input type="radio"/> SFTP <input type="radio"/> Network <input checked="" type="radio"/> SharePoint
Profile 7	<input type="radio"/> FTP <input type="radio"/> SFTP <input type="radio"/> Network <input checked="" type="radio"/> SharePoint
Profile 8	<input type="radio"/> FTP <input type="radio"/> SFTP <input type="radio"/> Network <input checked="" type="radio"/> SharePoint
Profile 9	<input type="radio"/> FTP <input type="radio"/> SFTP <input type="radio"/> Network <input checked="" type="radio"/> SharePoint
Profile 10	<input type="radio"/> FTP <input type="radio"/> SFTP <input type="radio"/> Network <input checked="" type="radio"/> SharePoint
Profile 11	<input type="radio"/> FTP <input type="radio"/> SFTP <input type="radio"/> Network <input checked="" type="radio"/> SharePoint
Profile 12	<input type="radio"/> FTP <input type="radio"/> SFTP <input type="radio"/> Network <input checked="" type="radio"/> SharePoint
Profile 13	<input type="radio"/> FTP <input type="radio"/> SFTP <input type="radio"/> Network <input checked="" type="radio"/> SharePoint
Profile 14	<input type="radio"/> FTP <input type="radio"/> SFTP <input type="radio"/> Network <input checked="" type="radio"/> SharePoint
Profile 15	<input type="radio"/> FTP <input type="radio"/> SFTP <input type="radio"/> Network <input checked="" type="radio"/> SharePoint
Profile 16	<input type="radio"/> FTP <input type="radio"/> SFTP <input type="radio"/> Network <input checked="" type="radio"/> SharePoint
Profile 17	<input type="radio"/> FTP <input type="radio"/> SFTP <input type="radio"/> Network <input checked="" type="radio"/> SharePoint
Profile 18	<input type="radio"/> FTP <input type="radio"/> SFTP <input type="radio"/> Network <input checked="" type="radio"/> SharePoint
Profile 19	<input type="radio"/> FTP <input type="radio"/> SFTP <input type="radio"/> Network <input checked="" type="radio"/> SharePoint
Profile 20	<input type="radio"/> FTP <input type="radio"/> SFTP <input type="radio"/> Network <input checked="" type="radio"/> SharePoint
Profile 21	<input type="radio"/> FTP <input type="radio"/> SFTP <input type="radio"/> Network <input checked="" type="radio"/> SharePoint
Profile 22	<input type="radio"/> FTP <input type="radio"/> SFTP <input type="radio"/> Network <input checked="" type="radio"/> SharePoint
Profile 23	<input type="radio"/> FTP <input type="radio"/> SFTP <input type="radio"/> Network <input checked="" type="radio"/> SharePoint
Profile 24	<input type="radio"/> FTP <input type="radio"/> SFTP <input type="radio"/> Network <input checked="" type="radio"/> SharePoint
Profile 25	<input type="radio"/> FTP <input type="radio"/> SFTP <input type="radio"/> Network <input checked="" type="radio"/> SharePoint

5. Click the **Scan to FTP/SFTP/Network/SharePoint Profile** menu in the left navigation bar.
6. Select the profile you want to set up or change.
7. In the **Profile Name** field, type a name for this server profile (up to 15 alphanumeric characters). The machine will display this name on the LCD.
8. In the **SharePoint Site Address** field, Copy and Paste the full destination address shown in the address bar of your browser (for example: <http://SharePointSiteAddress/Shared%20Documents/Forms/AllItems.aspx>) or the IP address (for example: <http://192.0.2.1/Shared%20Documents/Forms/AllItems.aspx>).
9. Click the **File Name** drop-down list, and then select a file name prefix from the preset names provided, or from user-defined names. The file name used for the scanned document will be the file name prefix you select, followed by the last six digits of the flatbed/ADF scanner counter and the file extension (for example: "Estimate_098765.pdf").
10. Click the **Quality** drop-down list, and then select a quality setting. If you choose the **User Select** option, the machine will prompt users to select a setting each time they use the scan profile.

-
11. Click the **File Type** drop-down list, and then select the file type you want to use for the scanned document. If you choose the **User Select** option, the machine will prompt users to select a setting each time they use the scan profile.
 12. Click the **Document Size** drop-down list, and then select your document size from the list. This is necessary to make sure the scanned file is the correct size.
 13. Click the **File Size** drop-down list, and then select your file size from the list.
 14. Click the **Remove Background Color** drop-down list, and then select the level from the list. You can use this feature to remove the background colour of documents to make the scanned data more legible.
 15. To PIN-protect this profile, in the **Use PIN for Authentication** field, select **On**.
 16. If you selected **On** for the **Use PIN for Authentication** field, type a four-digit PIN in the **PIN Code** field.
 17. To set your authentication method, select **Auto**, **NTLMv2**, **Kerberos**, or **Basic** from the **Auth. Method** menu. If you choose **Auto**, the authentication method will be detected automatically.
 18. In the **Username** field, type the user name (up to 96 characters) that has permission to write data to the folder specified in the **SharePoint Site Address** field. If the user name is part of a domain, enter the user name in one of the following styles:
user@domain
domain\user
 19. In the **Password** field, type the password (up to 32 characters) associated with the user name you entered in the **Username** field. Type the password again in the **Retype password** field.
 20. To set the Kerberos Server Address manually, in the **Kerberos Server Address** field, type the Kerberos Server Address (for example: kerberos.example.com; up to 64 characters).
 21. Click **Submit**.







Using the following characters: ?, /, \, ", :, <, >, | or * may cause a sending error.



Related Information

- [Scan to SharePoint®](#)
-

Upload Scanned Data to a SharePoint® Server

1. Load your document.
2. Press  [Scan].
3. Swipe left or right to display  [to SharePoint].
4. Press  [to SharePoint].
The icon moves to the middle of the touchscreen and is highlighted in blue.
5. Press  [to SharePoint].
6. The SharePoint® server profiles you have set up using Web Based Management are listed. Swipe up or down or press ▲ or ▼ to select one of the SharePoint® server profiles listed, and then press the profile you want. If the profile is not complete (for example, if the logon account name and password are missing, or if the quality or file type is not specified), you will be prompted to enter any missing information.
7. Press [Start].
The machine starts scanning. If you are using the machine's scanner glass, follow the touchscreen instructions to complete the scanning job.



Related Information

- [Scan to SharePoint®](#)

Web Services for Scanning on Your Network (Windows® 7, Windows® 8 and Windows® 10)

The Web Services protocol enables Windows® 7, Windows® 8 and Windows® 10 users to scan using a Fuji Xerox machine on the network. You must install the driver via Web Services.

- [Use Web Services to Install Drivers Used for Scanning \(Windows® 7, Windows® 8 and Windows® 10\)](#)
- [Scan Using Web Services from the Fuji Xerox Machine \(Windows® 7 or greater, Windows® 8 and Windows® 10\)](#)
- [Configure Scan Settings for Web Services](#)

Use Web Services to Install Drivers Used for Scanning (Windows® 7, Windows® 8 and Windows® 10)

Use Web Services to monitor printers on the network.

- Make sure you have installed the Fuji Xerox software and drivers.
- Verify that the host computer and the Fuji Xerox machine are on the same subnet, or that the router is correctly configured to pass data between the two devices.
- You must configure the IP address on your Fuji Xerox machine before you configure this setting.

1. Do one of the following:

- Windows® 7

Click  (**Start**) > **Control Panel** > **Network and Internet** > **View network computers and devices**.

The machine's Web Services Name appears with the printer icon.

Right-click the machine you want to install.

- Windows® 8

Move your mouse to the lower right corner of your desktop. When the menu bar appears, click **Settings** > **Change PC settings** > **Devices** > **Add a device**.

The machine's Web Services Name appears.

- Windows® 8.1

Move your mouse to the lower right corner of your desktop. When the menu bar appears, click **Settings** > **Change PC settings** > **PC and devices** > **Devices** > **Add a device**.

The machine's Web Services Name appears.

- Windows® 10

Click  > **Windows System** > **Control Panel**. In the **Hardware and Sound** group, click **Add a device**.



- The Web Services Name for the Fuji Xerox machine is your model name and the MAC Address (Ethernet Address) of your machine (for example, Fuji Xerox DocuPrint XXXXX (model name) [XXXXXXXXXXXXX] (MAC Address / Ethernet Address)).

- Windows® 8/Windows® 10

Move your mouse over the machine name to display the machine's information.

2. Do one of the following:

- Windows® 7

Click **Install** in the displayed menu.

- Windows® 8/Windows® 10

Select the machine you want to install, and then follow the on-screen instructions.



To uninstall drivers, click **Uninstall** or  (**Remove device**).







Related Information

- [Web Services for Scanning on Your Network \(Windows® 7, Windows® 8 and Windows® 10\)](#)

Scan Using Web Services from the Fuji Xerox Machine (Windows® 7 or greater, Windows® 8 and Windows® 10)

If you have installed the driver for scanning via Web Services, you can access the Web Services scanning menu on your Fuji Xerox machine's LCD.

Certain characters in the messages displayed on the LCD may be replaced with spaces if the language settings of your OS and your Fuji Xerox machine are different.

1. Load your document.
2. Press  [Scan].
3. Swipe left or right to display  [WS Scan].
4. Press  [WS Scan].
The icon moves to the middle of the touchscreen and is highlighted in blue.
5. Press  [WS Scan].
6. Swipe up or down or press ▲ or ▼ to display the scan options, and then press the type of scan.
7. Swipe up or down or press ▲ or ▼ to display the computer name where you want to send data, and then press the computer name.
8. Press [Start].
The machine starts scanning.

If you are requested to select a scanning application, select Windows® Fax and Scan or Windows® Photo Gallery from the list.



Related Information

- [Web Services for Scanning on Your Network \(Windows® 7, Windows® 8 and Windows® 10\)](#)

Configure Scan Settings for Web Services

1. Do one of the following:

- Windows® 7

Click  (**Start**) > **Devices and Printers**.

- Windows® 8

Move your mouse to the lower right corner of your desktop. When the menu bar appears, click **Settings**, and then click **Control Panel**. In the **Hardware and Sound** group, click **View devices and printers**.

- Windows® 10

Click  > **Windows System** > **Control Panel**. In the **Hardware and Sound** group, click **View devices and printers**.

2. Right-click the machine icon, and then select **Scan profiles...**. The **Scan Profiles** dialog box appears.

3. Select the scan profile you want to use.

4. Make sure the scanner selected in the **Scanner** list is a Fuji Xerox machine that supports Web Services for scanning, and then click the **Set as Default** button.

5. Click **Edit...**

The **Edit Default Profile** dialog box appears.

6. Select the **Source**, **Paper size**, **Color format**, **File type**, **Resolution (DPI)**, **Brightness** and **Contrast** settings.

7. Click the **Save Profile** button.

These settings will be applied when you scan using the Web Services protocol.

If you are requested to select a scanning application, select Windows® Fax and Scan from the list.



Related Information

- [Web Services for Scanning on Your Network \(Windows® 7, Windows® 8 and Windows® 10\)](#)

Change Scan Button Settings from ControlCenter4 (Windows®)

1. Click the  (ControlCenter4) icon in the task tray, and then click **Open**.
2. Click the **Device Settings** tab.
3. Click the **Device Scan Settings** button.

The **Device Scan Settings** dialog box appears.

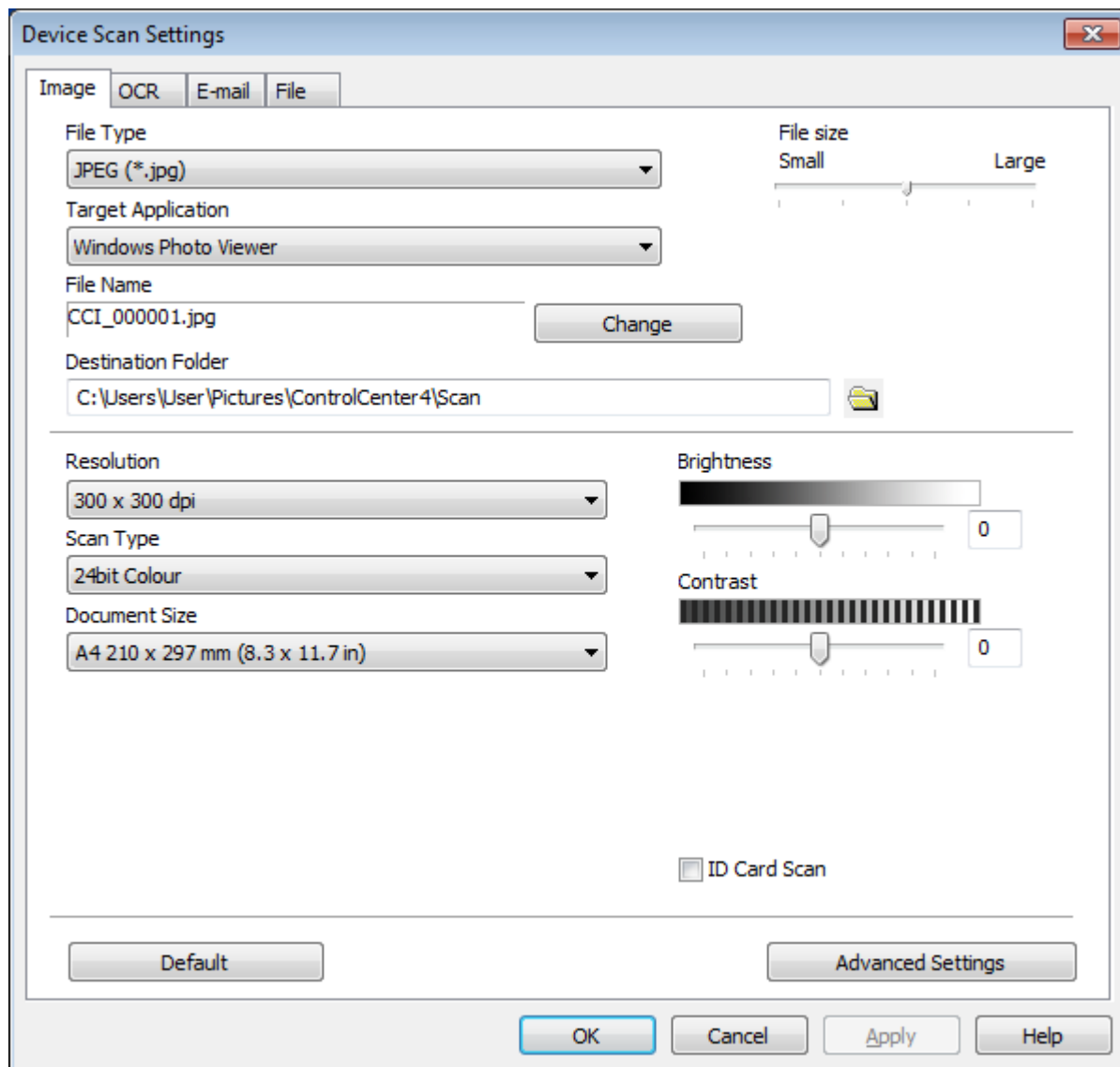

4. Click the tab for the Scan to action you want to change (**Image**, **OCR**, **E-mail**, or **File**).
5. Change the settings as needed.
6. Click **OK**.



Each tab represents one of the scanning destinations, as outlined in the table below.

Change your Scan to settings by clicking on the corresponding tab and customising the setting you want.

Tab Name	Corresponding Feature
Image	Scan to Image
OCR	Scan to OCR
E-mail	Scan to Email
File	Scan to File

Settings	Applicable Features			
	Image	OCR	E-mail	File
File Type	Yes	Yes	Yes	Yes
Target Application	Yes	Yes	-	-
OCR Language	-	Yes	-	-
File Name	Yes	Yes	Yes	Yes
Destination Folder	Yes	Yes	Yes	Yes
Show Folder	-	-	-	Yes
File size	Yes	-	Yes	Yes
Resolution	Yes	Yes	Yes	Yes
Scan Type	Yes	Yes	Yes	Yes
Document Size	Yes	Yes	Yes	Yes
Brightness	Yes	Yes	Yes	Yes
Contrast	Yes	Yes	Yes	Yes
ID Card Scan	Yes	Yes	Yes	Yes
Default	Yes	Yes	Yes	Yes

File Type

Select the file type you want to use for the scanned data.

Target Application

Select the destination application from the drop-down list.

OCR Language

Set the OCR language to match the language of the scanned document's text.

File Name

Click **Change** to change the file name's prefix.

Destination Folder

Click the folder icon to browse and select the folder where you want to save your scanned documents.

Show Folder

Select this option to automatically display the destination folder after scanning.

File size

Adjust the data compression ratio of the scanned image. Change the file size by moving the **File size** slider to the right or left.

Resolution

Select a scanning resolution from the **Resolution** drop-down list. Higher resolutions take more memory and transfer time, but produce a finer scanned image.

Scan Type

Select from a range of scan colour depths.

- **Auto**
Use for any type of document. This mode automatically picks an appropriate colour depth for the document.
- **Black & White**
Use for text or line art images.
- **Grey (Error Diffusion)**
Use for photographic images or graphics. (Error Diffusion is a method for creating simulated grey images without using true grey dots. Black dots are put in a specific pattern to give a grey appearance.)
- **True Grey**
Use for photographic images or graphics. This mode is more accurate because it uses up to 256 shades of grey.
- **24bit Colour**
Use to create an image with the most accurate colour reproduction. This mode uses up to 16.8 million colours to scan the image, but it requires the most memory and has the longest transfer time.

Document Size

Select the exact size of your document from the **Document Size** drop-down list.

- If you select **1 to 2 (A4)**, the scanned image will be divided into two A5-size documents.

Brightness

Set the **Brightness** level by dragging the slider to the right or left to lighten or darken the image. If the scanned image is too light, set a lower brightness level and scan the document again. If the image is too dark, set a higher brightness level and scan the document again. You can also type a value into the field to set the **Brightness** level.

Contrast

Increase or decrease the **Contrast** level by moving the slider to the right or left. An increase emphasises dark and light areas of the image, while a decrease reveals more details in grey areas. You can also type a value into the field to set the **Contrast** level.

ID Card Scan

Select this check box to scan both sides of an identification card onto one page.

Default

Select this option to restore all settings to their factory setting values.



Related Information

- [Scan Using the Scan Button on Your Fuji Xerox Machine](#)

Related Topics

- [Scan Photos and Graphics](#)
 - [Save Scanned Data to a Folder as a PDF File](#)
 - [Scan to an Editable Text File \(OCR\)](#)
 - [Scan to Email Attachment](#)
-

Change Scan Button Settings from iPrint&Scan (Mac)

1. In the **Finder** menu bar, click **Go > Applications > Fuji Xerox**, and then double-click the iPrint&Scan icon. The iPrint&Scan screen appears.
2. If your Fuji Xerox machine is not selected, click the **Select your Machine** button, and then follow the on-screen instructions to select your Fuji Xerox machine.
3. Click the **Machine Scan Settings** button, and then follow the on-screen instructions to change the scan settings.



Related Information

- [Scan Using the Scan Button on Your Fuji Xerox Machine](#)

Related Topics

- [Scan Using iPrint&Scan \(Mac\)](#)
- [Scan Photos and Graphics](#)
- [Save Scanned Data to a Folder as a PDF File](#)
- [Scan to an Editable Text File \(OCR\)](#)
- [Scan to Email Attachment](#)

Configure Certificate for Signed PDF

If you select Signed PDF for Scan to USB, Scan to Email server, Scan to FTP, Scan to SFTP, Scan to Network or Scan to SharePoint® features, you must configure a certificate on your machine using Web Based Management.

To use Signed PDF, you must install a certificate on your machine and your computer.

1. Start your web browser.

Type "http://machine's IP address" in your browser's address bar (where "machine's IP address" is the IP address of the machine or the print server name). For example: http://192.0.2.1

Type a password, and then click . The default password is "x-admin". To ensure security, it is important you change the password.

2. Click the **Administrator** tab.
3. Click the **Signed PDF** menu in the left navigation bar.
The Signed PDF configuration dialog box appears.

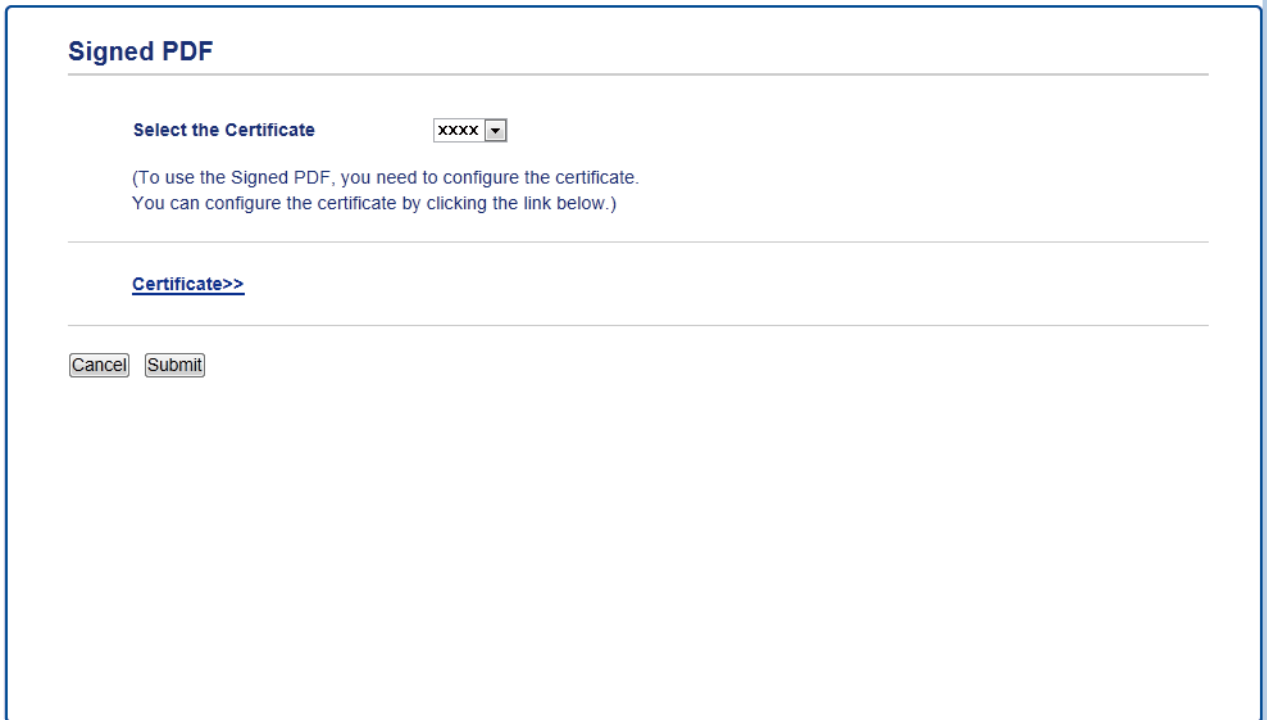

Signed PDF

Select the Certificate

(To use the Signed PDF, you need to configure the certificate.
You can configure the certificate by clicking the link below.)

[Certificate>>](#)

4. Click the **Select the Certificate** drop-down list, and then select the certificate.
5. Click **Submit**.



Related Information

- [Scan Using the Scan Button on Your Fuji Xerox Machine](#)

Disable Scanning from Your Computer

You can disable the ability to scan from your computer. Set the pull scan setting using Web Based Management.

1. Start your web browser.

Type "http://machine's IP address" in your browser's address bar (where "machine's IP address" is the IP address of the machine or the print server name). For example: http://192.0.2.1

Type a password, and then click . The default password is "x-admin". To ensure security, it is important you change the password.

2. Click the **Scan** tab.
3. Click the **Scan from PC** menu in the left navigation bar.
4. In the **Pull Scan** field, click **Disabled**.
5. Click **Submit**.



Related Information

- [Scan Using the Scan Button on Your Fuji Xerox Machine](#)

Scan from Your Computer(Windows®)

There are several ways you can use your computer to scan photos and documents on your Fuji Xerox machine. Use the software applications provided by Fuji Xerox, or use your favourite scanning application.

- [Scan Using ControlCenter4 Home Mode \(Windows®\)](#)
- [Scan Using ControlCenter4 Advanced Mode \(Windows®\)](#)
- [Scan Using Nuance™ PaperPort™ 14SE or Other Windows® Applications](#)
- [Scan Using Windows® Photo Gallery or Windows® Fax and Scan](#)

Scan Using ControlCenter4 Home Mode (Windows®)

Use ControlCenter4 Home Mode to access your machine's main features.

- [Scan Using ControlCenter4 Home Mode \(Windows®\)](#)
- [Save Scanned Data to a Folder as a PDF File Using ControlCenter4 Home Mode \(Windows®\)](#)
- [Scan Both Sides of a Document Automatically Using ControlCenter4 Home Mode \(Windows®\)](#)
- [Scan Settings for ControlCenter4 Home Mode \(Windows®\)](#)



Scan Using ControlCenter4 Home Mode (Windows®)

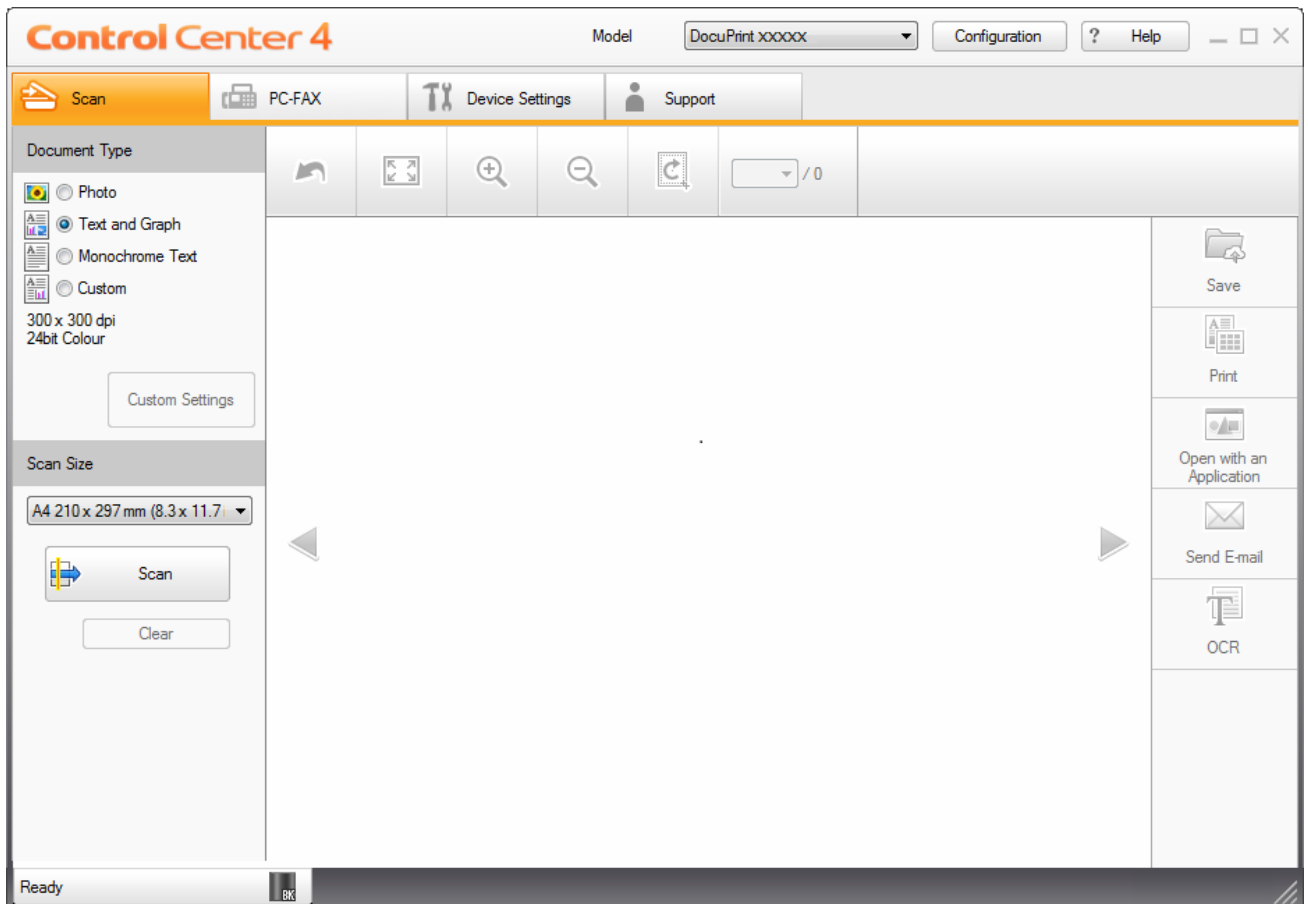

Select **Home Mode** as the mode setting for ControlCenter4.

1. Load your document.
2. Click the  (**ControlCenter4**) icon in the task tray, and then click **Open**.
3. Click the **Scan** tab.



4. Select the **Document Type**.
5. Change the document's **Scan Size**, if needed.
6. Click  (**Scan**).

The machine starts scanning, and the scanned image appears in the image viewer.
7. Click the left or right arrow buttons to preview each scanned page.
8. Crop the scanned image, if needed.
9. Do one of the following:
 - Click  (**Save**) to save scanned data.
 - Click  (**Print**) to print scanned data.
 - Click  (**Open with an Application**) to open scanned data in another application.

-
- Click  (**Send E-mail**) to attach scanned data to an email.
 - Click  (**OCR**) to convert your scanned document to an editable text file. (available only for certain models)



Related Information

- [Scan Using ControlCenter4 Home Mode \(Windows®\)](#)
 - [Select Document Type Using ControlCenter4 Home Mode \(Windows®\)](#)
 - [Change Scan Size Using ControlCenter4 Home Mode \(Windows®\)](#)
 - [Crop a Scanned Image Using ControlCenter4 Home Mode \(Windows®\)](#)
 - [Print Scanned Data Using ControlCenter4 Home Mode \(Windows®\)](#)
 - [Scan to an Application Using ControlCenter4 Home Mode \(Windows®\)](#)
-

Home > Scan > Scan from Your Computer(Windows®) > Scan Using ControlCenter4 Home Mode (Windows®) > Scan Using ControlCenter4 Home Mode (Windows®) > Select Document Type Using ControlCenter4 Home Mode (Windows®)

Select Document Type Using ControlCenter4 Home Mode (Windows®)

- Select the **Document Type** option that matches the type of original you want to scan.

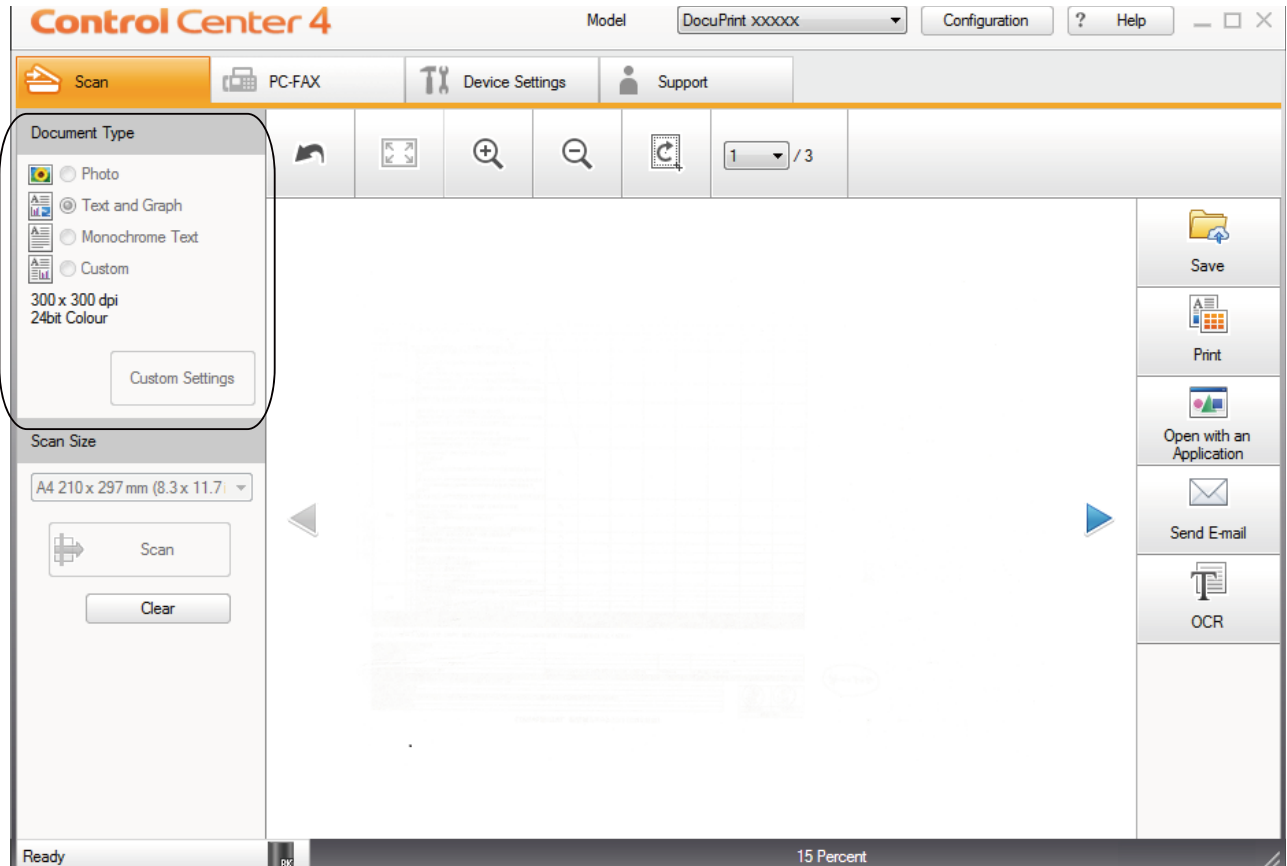

Option	Description
Photo	600 x 600 dpi 24bit Colour
Text and Graph	300 x 300 dpi 24bit Colour
Monochrome Text	200 x 200 dpi Black & White
Custom	300 x 300 dpi (24bit Colour as default) Select the scan settings you want from the Custom Settings button.



Related Information

- Scan Using ControlCenter4 Home Mode (Windows®)
 - Custom Scan Settings (Windows®)

Custom Scan Settings (Windows®)

Select **Custom** in the **Document Type** list to change advanced scan settings.

- Select **Custom**, and then click the **Custom Settings** button.

The **Custom Scan Settings** dialog box appears.

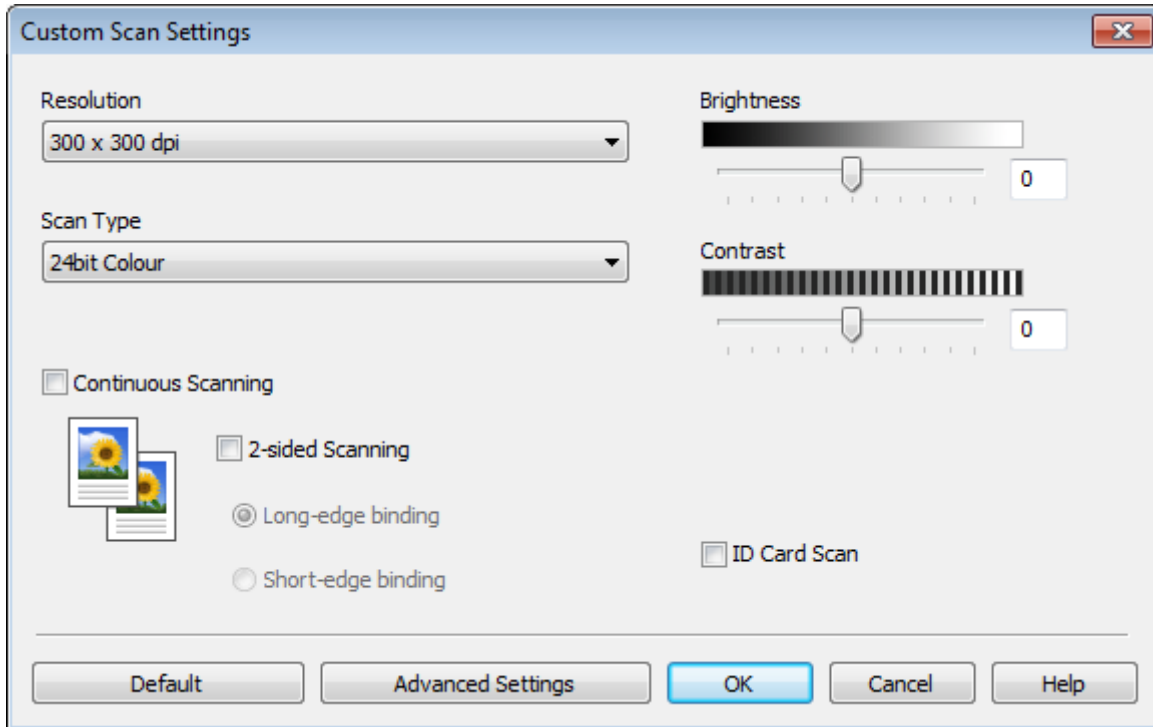

You can change the following settings:

Resolution

Select a scanning resolution from the **Resolution** drop-down list. Higher resolutions take more memory and transfer time, but produce a finer scanned image.

Scan Type

Select from a range of scan colour depths.

- Auto

Use for any type of document. This mode automatically picks an appropriate colour depth for the document.

- Black & White

Use for text or line art images.

- Grey (Error Diffusion)

Use for photographic images or graphics. (Error Diffusion is a method for creating simulated grey images without using true grey dots. Black dots are put in a specific pattern to give a grey appearance.)

- True Grey

Use for photographic images or graphics. This mode is more accurate because it uses up to 256 shades of grey.

- 24bit Colour

Use to create an image with the most accurate colour reproduction. This mode uses up to 16.8 million colours to scan the image, but it requires the most memory and has the longest transfer time.

Brightness

Set the **Brightness** level by dragging the slider to the right or left to lighten or darken the image. If the scanned image is too light, set a lower brightness level and scan the document again. If the image is too dark, set a higher brightness level and scan the document again. You can also type a value into the field to set the **Brightness** level.

Contrast

Increase or decrease the **Contrast** level by moving the slider to the right or left. An increase emphasises dark and light areas of the image, while a decrease reveals more details in grey areas. You can also type a value into the field to set the **Contrast** level.

Continuous Scanning

Select this option to scan multiple pages from the scanner glass or ADF (Available only for certain models). After a page is scanned, select either continue scanning or finish. Use this method to scan more pages than the maximum ADF capacity.

2-sided Scanning

Select this check box to scan both sides of the document. When using the Automatic 2-sided Scan feature, you must select the **Long-edge binding** or **Short-edge binding** option, depending on the layout of your original, to make sure the data file you create appears correctly.

(DocuPrint M385 z/DocuPrint M375 z)

ID Card Scan

Select this check box to scan both sides of an identification card onto one page.

Advanced Settings

Configure advanced settings by clicking the **Advanced Settings** button in the Scan Settings dialog box.

- Remove Background Colour

Remove the base colour of documents to make the scanned data more legible. Choose from three settings: high, medium, and low.

(available only for the **Auto**, **True Grey** and **24bit Colour** options)

- Skip Blank Page

Remove the document's blank pages from the scanning results.

(DocuPrint M385 z/DocuPrint M375 z)

- Display Scanning Results

Show the numbers of total pages saved and blank pages skipped on your computer screen.

(DocuPrint M385 z/DocuPrint M375 z)

- ADF Auto Deskew

When scanning the document from the ADF, the machine corrects skewing of the document automatically.



Related Information

- [Select Document Type Using ControlCenter4 Home Mode \(Windows®\)](#)
-

Home > Scan > Scan from Your Computer(Windows®) > Scan Using ControlCenter4 Home Mode (Windows®) > Scan Using ControlCenter4 Home Mode (Windows®) > Change Scan Size Using ControlCenter4 Home Mode (Windows®)

Change Scan Size Using ControlCenter4 Home Mode (Windows®)

For faster scan speeds, select the exact size of your document from the **Scan Size** drop-down menu.

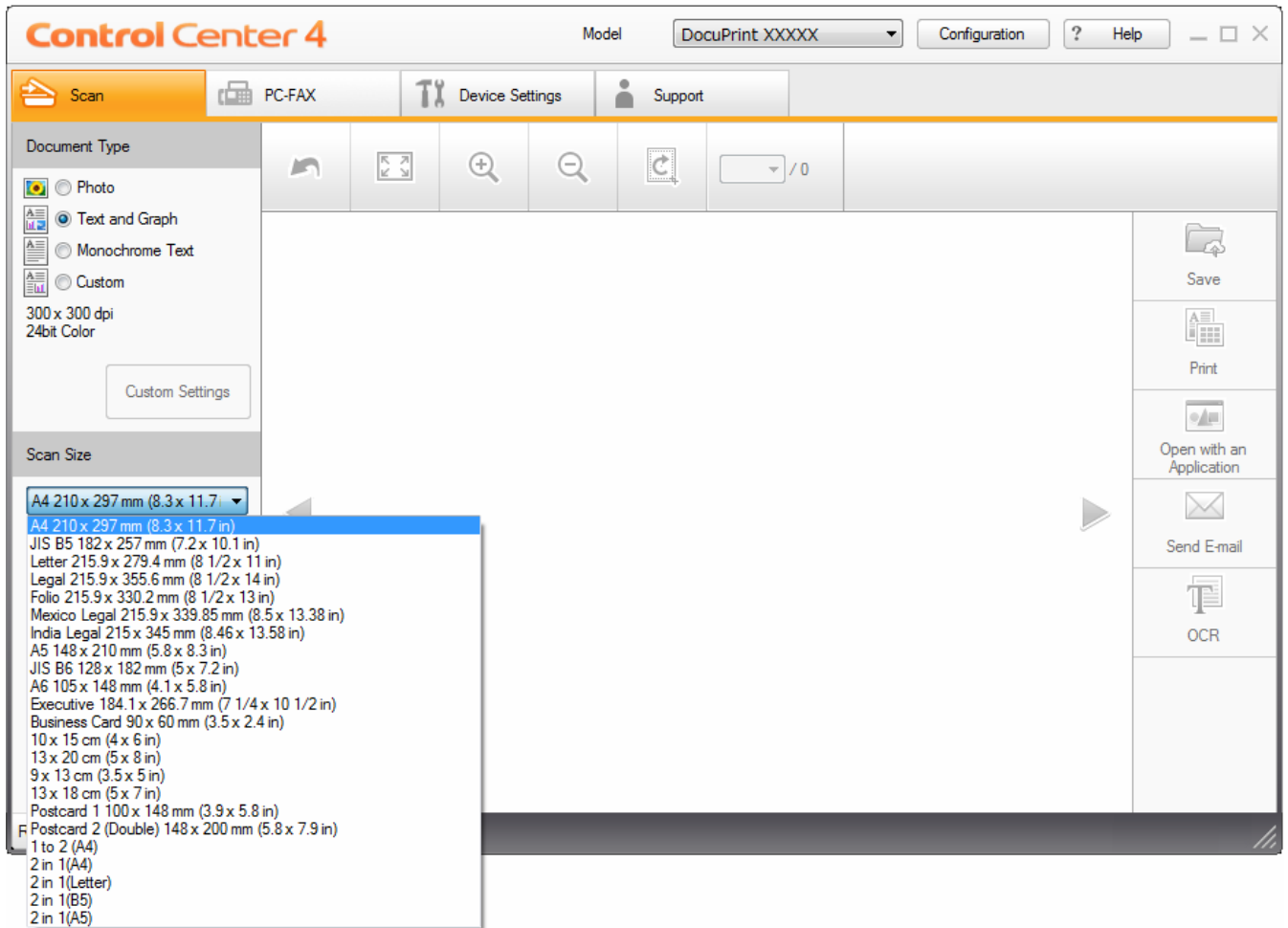

Related Information

- [Scan Using ControlCenter4 Home Mode \(Windows®\)](#)

Crop a Scanned Image Using ControlCenter4 Home Mode (Windows®)

The crop tool on the Image Editing Toolbar lets you trim unwanted areas from your scanned image. Use the **Zoom In** and **Zoom Out** tools to help view the image to be cropped.

Image Editing Toolbar

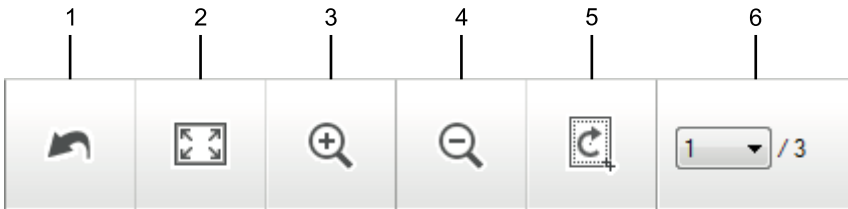

1. Restart

Cancels all the edits applied to the selected image. The edited image returns to its original state.

2. Fit to Window

Displays the scanned image so that the entire image fits in the window.

3. Zoom In

Zooms in on the scanned image.

4. Zoom Out

Zooms out of the scanned image.

5. Crop and Edit

Removes the outer parts of the image. Click the **Crop and Edit** button, and then change the frame to contain the area you want to keep after cropping.

6. Page Counter

Indicates the page number of the scanned page currently shown in the image viewer. To display a different page, select the desired page number from the drop-down page number list.



If you have scanned multiple pages, you can see the next or previous scanned page by clicking the left or right arrow buttons in the preview window.

1. Scan a document.

2. Click  (**Crop and Edit**) to edit the scanned image.

The **Crop and Edit - ControlCenter4** window appears.

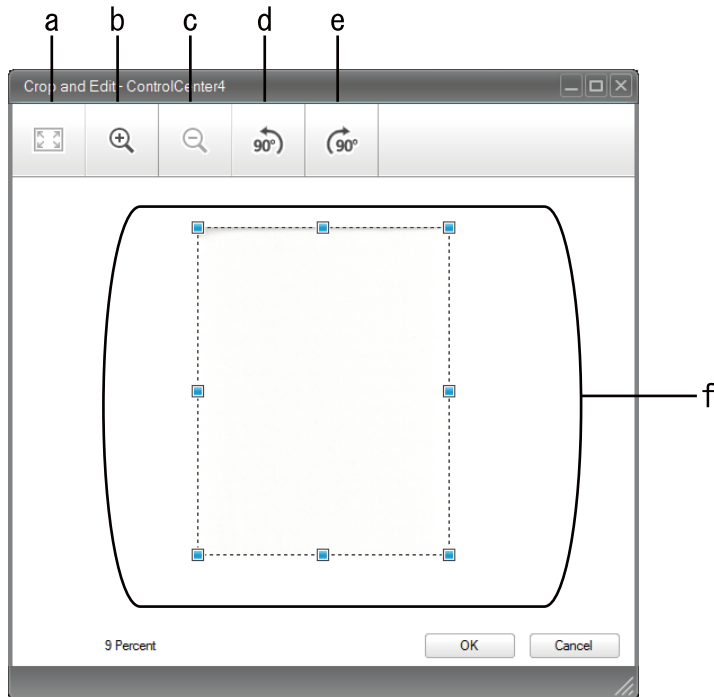

- a. Expands the scanned image so that the entire image fits in the window.
 - b. Zooms in on the image.
 - c. Zooms out of the image.
 - d. Rotates the image counter-clockwise 90 degrees.
 - e. Rotates the image clockwise 90 degrees.
 - f. Click and drag the frame to adjust the area to be cropped.
3. Click **OK**.
The edited image appears in the image viewer.



Related Information

- [Scan Using ControlCenter4 Home Mode \(Windows®\)](#)

Print Scanned Data Using ControlCenter4 Home Mode (Windows®)

Scan a document on your Fuji Xerox machine, and then print copies using the printer driver features that are available in ControlCenter4.

1. Scan a document.
2. Click **Print**.

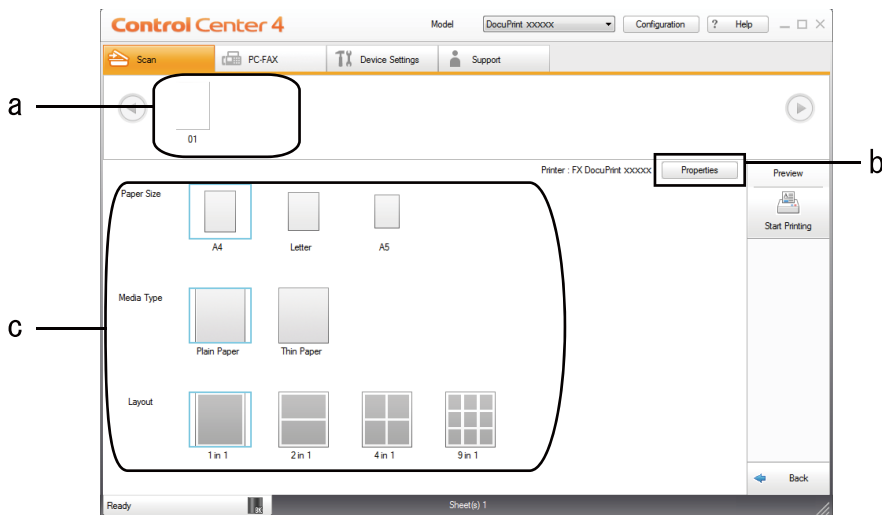

- a. Shows which images are currently selected, and how many copies of each image will print.
 - b. Click the **Properties** button to change specific printer settings.
 - c. Select the **Paper Size**, **Media Type** and **Layout** options. The current settings are enclosed in a blue square.
3. Configure the print settings, and then click the **Start Printing** button.



Related Information

- [Scan Using ControlCenter4 Home Mode \(Windows®\)](#)

Scan to an Application Using ControlCenter4 Home Mode (Windows®)

The **Open with an Application** button lets you scan an image directly into your graphics application for editing.

Select **Home Mode** as the mode setting for ControlCenter4.

1. Load your document.
2. Click the  (**ControlCenter4**) icon in the task tray, and then click **Open**.
3. Click the **Scan** tab.

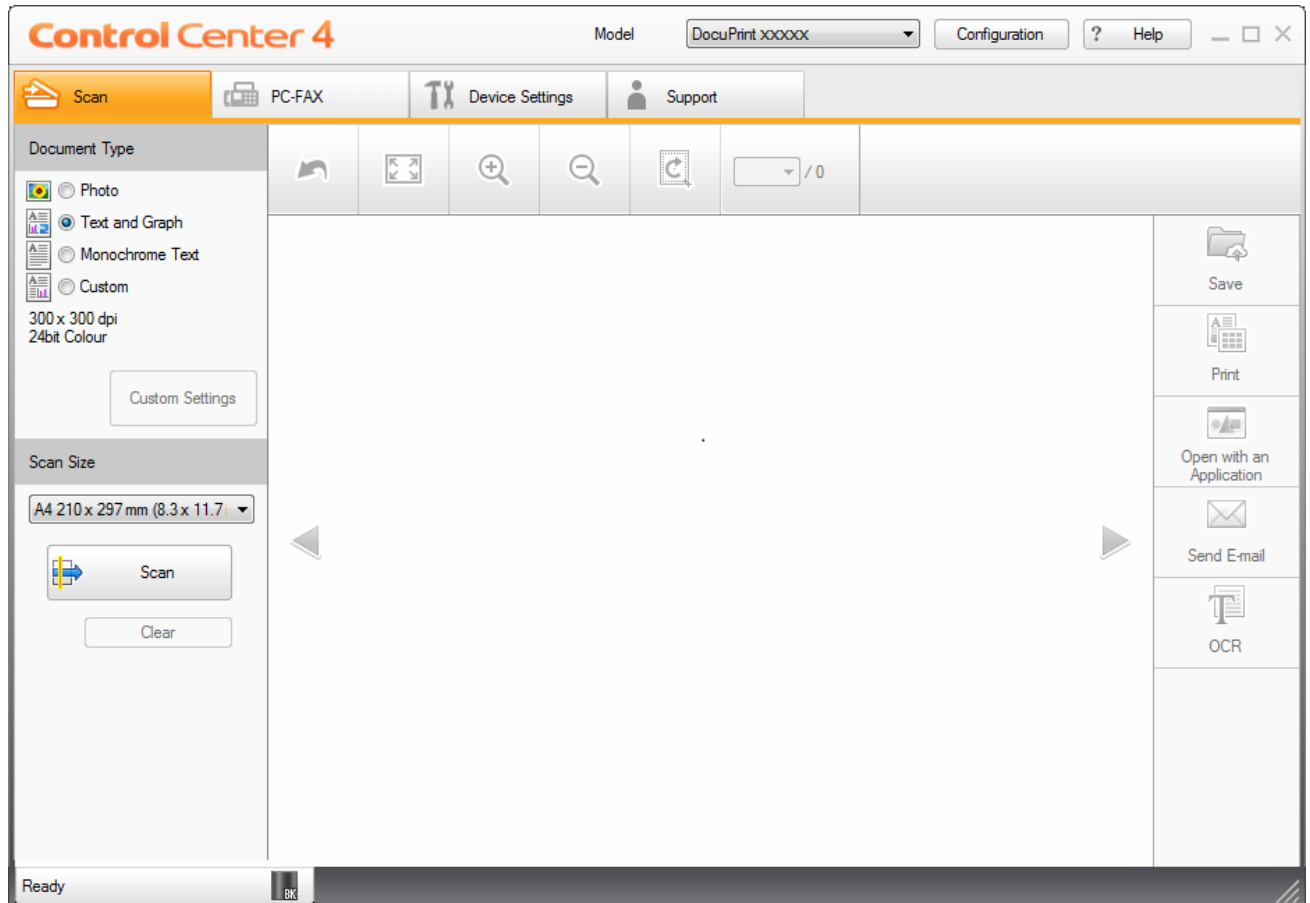

4. Select the **Document Type**.
5. Change the size of your document, if needed.
6. Click  (**Scan**).
The machine starts scanning, and the scanned image appears in the image viewer.
7. Click the left or right arrow buttons to preview each scanned page.
8. Crop the scanned image, if needed.
9. Click the **Open with an Application** button.
10. Select the application from the drop-down list, and then click **OK**.
The image opens in the application you have selected.

✓ Related Information

- [Scan Using ControlCenter4 Home Mode \(Windows®\)](#)

Save Scanned Data to a Folder as a PDF File Using ControlCenter4 Home Mode (Windows®)

Select **Home Mode** as the mode setting for ControlCenter4.

1. Load your document.
2. Click the  (ControlCenter4) icon in the task tray, and then click **Open**.
3. Click the **Scan** tab.

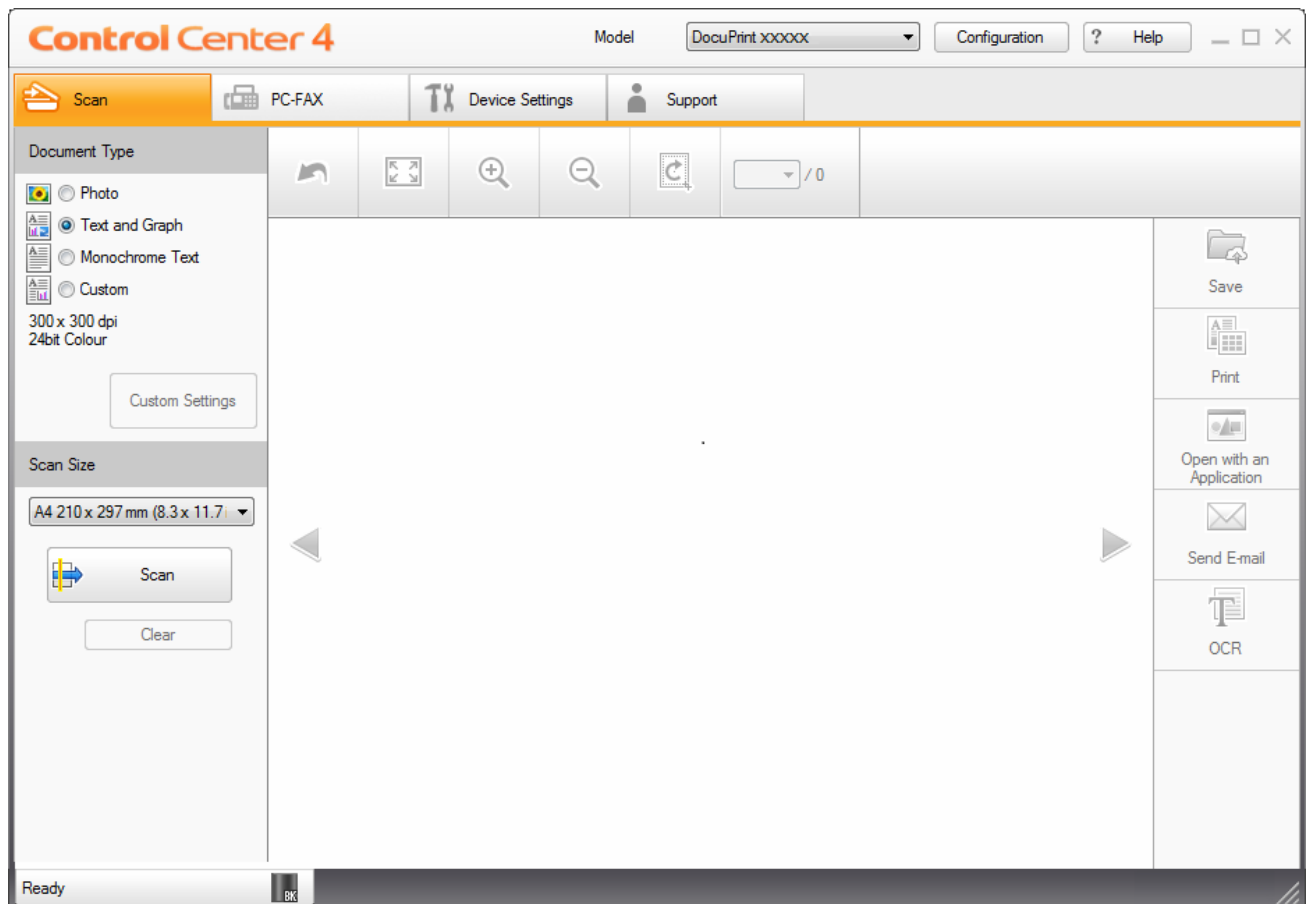

4. Select the **Document Type**.
5. Change the size of your document, if needed.
6. Click  (**Scan**).
The machine starts scanning, and the scanned image appears in the image viewer.
7. Click the left or right arrow buttons to preview each scanned page.
8. Click **Save**.
The **Save** dialog box appears.
9. Click the **File Type** drop-down list, and then select a PDF file.

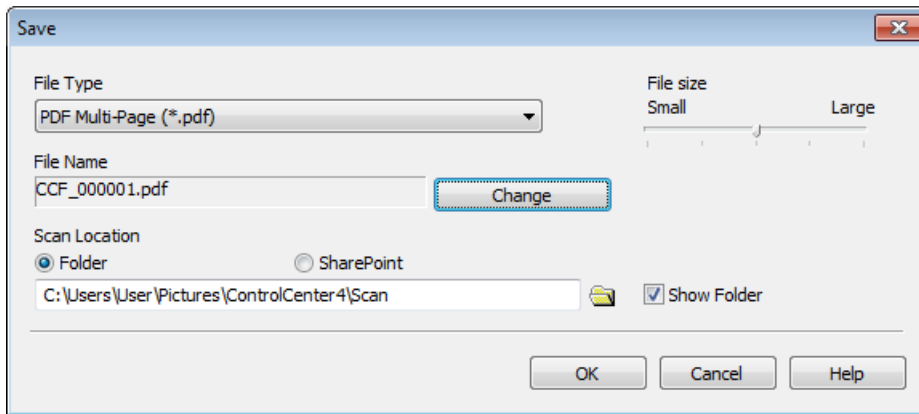

To save the document as a password-protected PDF, select **Secure PDF Single-Page (*.pdf)** or **Secure PDF Multi-Page (*.pdf)** from the **File Type** drop-down list, click , and then type the password.

10. To change the file name, click the **Change** button, if needed.
11. Click the folder icon to browse and select the folder where you want to save your scanned documents.
12. Click **OK**.

The scanned document is saved to the destination folder as a PDF.



Related Information

- [Scan Using ControlCenter4 Home Mode \(Windows®\)](#)

Scan Both Sides of a Document Automatically Using ControlCenter4 Home Mode (Windows®)

Related Models: DocuPrint M385 z/DocuPrint M375 z

Select **Home Mode** as the mode setting for ControlCenter4.

1. Load documents in the ADF.





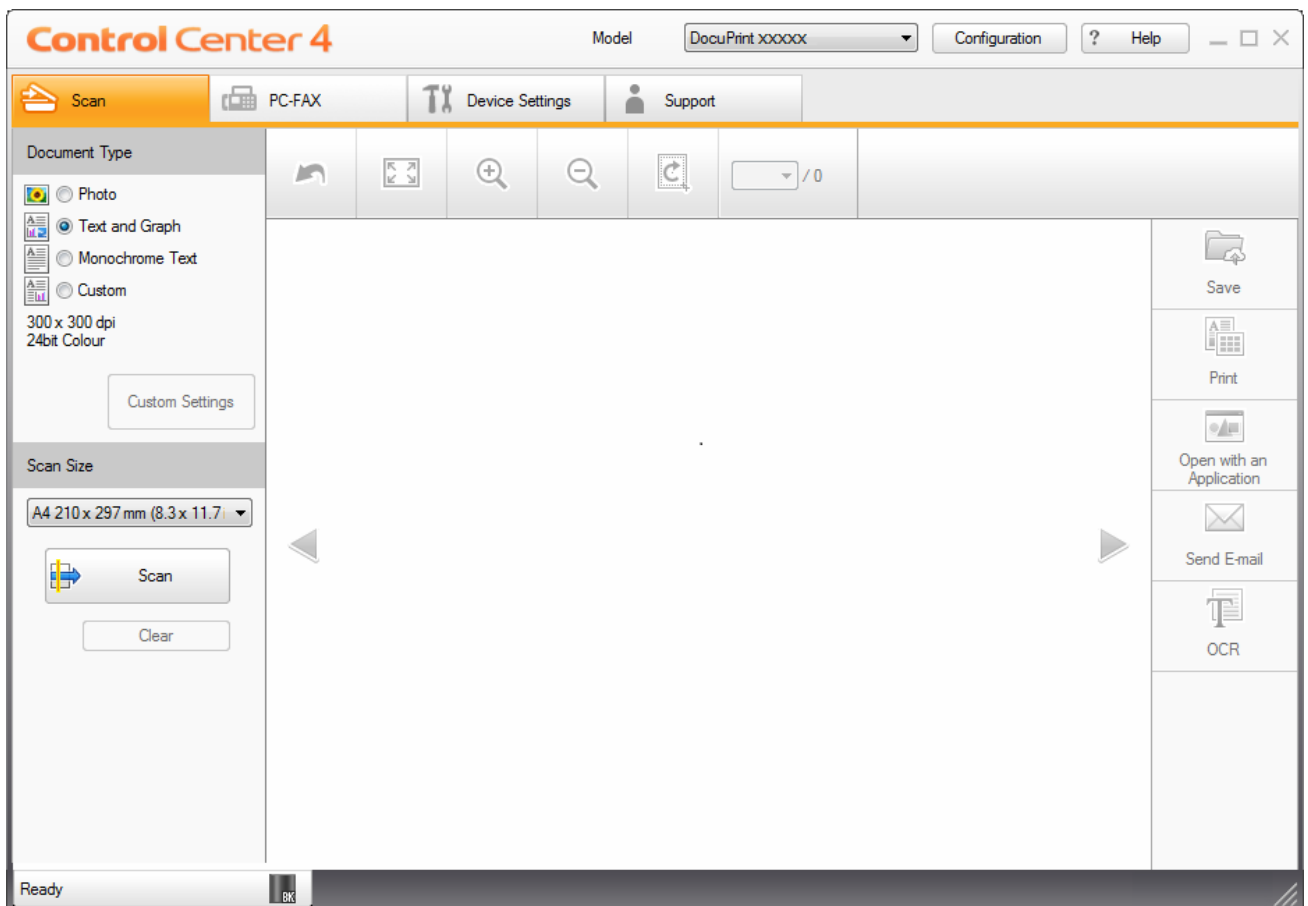

To scan both sides of a document automatically, you must use the ADF, not the flatbed scanner glass.

2. Click the  (**ControlCenter4**) icon in the task tray, and then click **Open**.
3. Click the **Scan** tab.

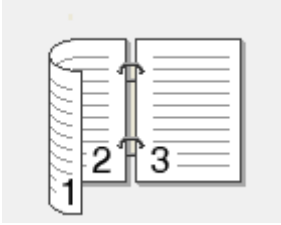

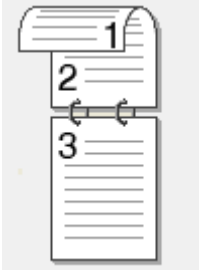
4. Under **Document Type**, select **Custom**, and then click the **Custom Settings** button.
The **Custom Scan Settings** dialog box appears.
5. Select the **2-sided Scanning** check box.
6. Select the **Long-edge binding** or **Short-edge binding** option, depending on the Original layout (see table for layout examples).

2-sided Scan setting	Original layout	Scan Result
Long-edge binding		
Short-edge binding		

7. Configure other **Custom Scan Settings**, if needed.





8. Click **OK**.

9. Click  (**Scan**).

The machine starts scanning, and the scanned image appears in the image viewer.

10. Click the left or right arrow buttons to preview each scanned page.

11. Do one of the following:

- Click  (**Save**) to save scanned data.
- Click  (**Print**) to print scanned data.
- Click  (**Open with an Application**) to open scanned data in another application.
- Click  (**Send E-mail**) to attach scanned data to an email.
- Click  (**OCR**) to convert your scanned document to an editable text file. (available only for certain models)



Related Information

- [Scan Using ControlCenter4 Home Mode \(Windows®\)](#)

Scan Settings for ControlCenter4 Home Mode (Windows®)

Settings	Applicable Features			
	Open with an Application	OCR	Send E-mail	Save
File Type	-	Yes	Yes	Yes
Target Application	Yes	Yes	-	-
OCR Language	-	Yes	-	-
File Name	-	-	-	Yes
Scan Location	-	-	-	Yes
Show Folder	-	-	-	Yes
File size	-	-	Yes	Yes

File Type

Select the file type you want to use for the scanned data.

For Send E-mail and Save

- **Windows Bitmap (*.bmp)**
- **JPEG (*.jpg)** (recommended for most users when scanning pictures)
- **TIFF Single-Page (*.tif)**
- **TIFF Multi-Page (*.tif)**
- **Portable Network Graphics (*.png)**
- **PDF Single-Page (*.pdf)** (recommended for scanning and sharing documents)
- **PDF Multi-Page (*.pdf)** (recommended for scanning and sharing documents)
- **PDF/A Single-Page (*.pdf)** (recommended for scanning and sharing documents)
- **PDF/A Multi-Page (*.pdf)** (recommended for scanning and sharing documents)
- **High Compression PDF Single-Page (*.pdf)**
- **High Compression PDF Multi-Page (*.pdf)**
- **Secure PDF Single-Page (*.pdf)**
- **Secure PDF Multi-Page (*.pdf)**
- **Searchable PDF Single-Page (*.pdf)**
- **Searchable PDF Multi-Page (*.pdf)**
- **XML Paper Specification (*.xps)** (the XML Paper Specification is available for Windows® 7 , Windows® 8 and Windows® 10, and when using applications that support XML Paper Specification files)
- **Microsoft Office Word (*.docx)** (Available only for certain models)
- **Microsoft Office PowerPoint (*.pptx)** (Available only for certain models)

For OCR

- **HTML 3.2 (*.htm)**
- **HTML 4.0 (*.htm)**
- **Microsoft Excel 2003, XP (*.xls)**
- **RTF Word 2000 (*.rtf)**
- **WordPad (*.rtf)**
- **WordPerfect 9, 10 (*.wpd)**
- **Text (*.txt)**
- **Searchable PDF Single-Page (*.pdf)**
- **Searchable PDF Multi-Page (*.pdf)**

Target Application

Select the destination application from the drop-down list.

OCR Language

Set the optical character recognition (OCR) language to match the language of the scanned document's text.

File Name

Click **Change** to change the file name's prefix.

Scan Location

Select the **Folder** or **SharePoint** button to specify the destination where you would like to save your scanned documents.

Show Folder

Select this option to automatically display the destination folder after scanning.

File size

Adjust the data compression ratio of the scanned image. Change the file size by moving the **File size** slider to the right or left.

Custom Settings

Select the **Custom** option, click the **Custom Settings** button, and then change settings.

Scan Size

Select the exact size of your document from the **Scan Size** drop-down menu.

**Related Information**

- [Scan Using ControlCenter4 Home Mode \(Windows®\)](#)

Scan Using ControlCenter4 Advanced Mode (Windows®)

ControlCenter4 Advanced Mode gives you more control over the details of your machine's features and allows you to customise one-button scan actions.

- [Scan Photos and Graphics Using ControlCenter4 Advanced Mode \(Windows®\)](#)
- [Save Scanned Data to a Folder as a PDF File Using ControlCenter4 Advanced Mode \(Windows®\)](#)
- [Scan Both Sides of a Document Automatically Using ControlCenter4 Advanced Mode \(Windows®\)](#)
- [Scan Both Sides of an ID Card Using ControlCenter4 Advanced Mode \(Windows®\)](#)
- [Scan to Email Attachment Using ControlCenter4 Advanced Mode \(Windows®\)](#)
- [Scan to an Editable Text File \(OCR\) Using ControlCenter4 Advanced Mode \(Windows\)](#)
- [Scan Settings for ControlCenter4 Advanced Mode \(Windows®\)](#)

Scan Photos and Graphics Using ControlCenter4 Advanced Mode (Windows®)

Send scanned photos or graphics directly to your computer.

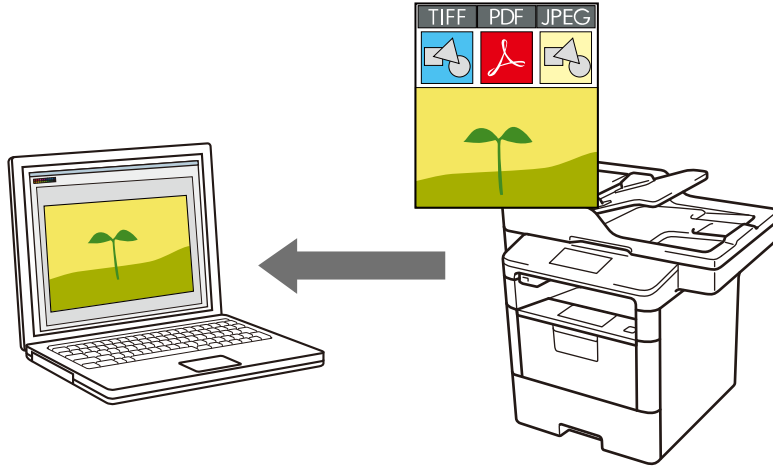

Select **Advanced Mode** as the mode setting for ControlCenter4.

1. Load your document.
2. Click the  (ControlCenter4) icon in the task tray, and then click **Open**.
3. Click the **Scan** tab.



4. Click the **Image** button.
The scan settings dialog box appears.

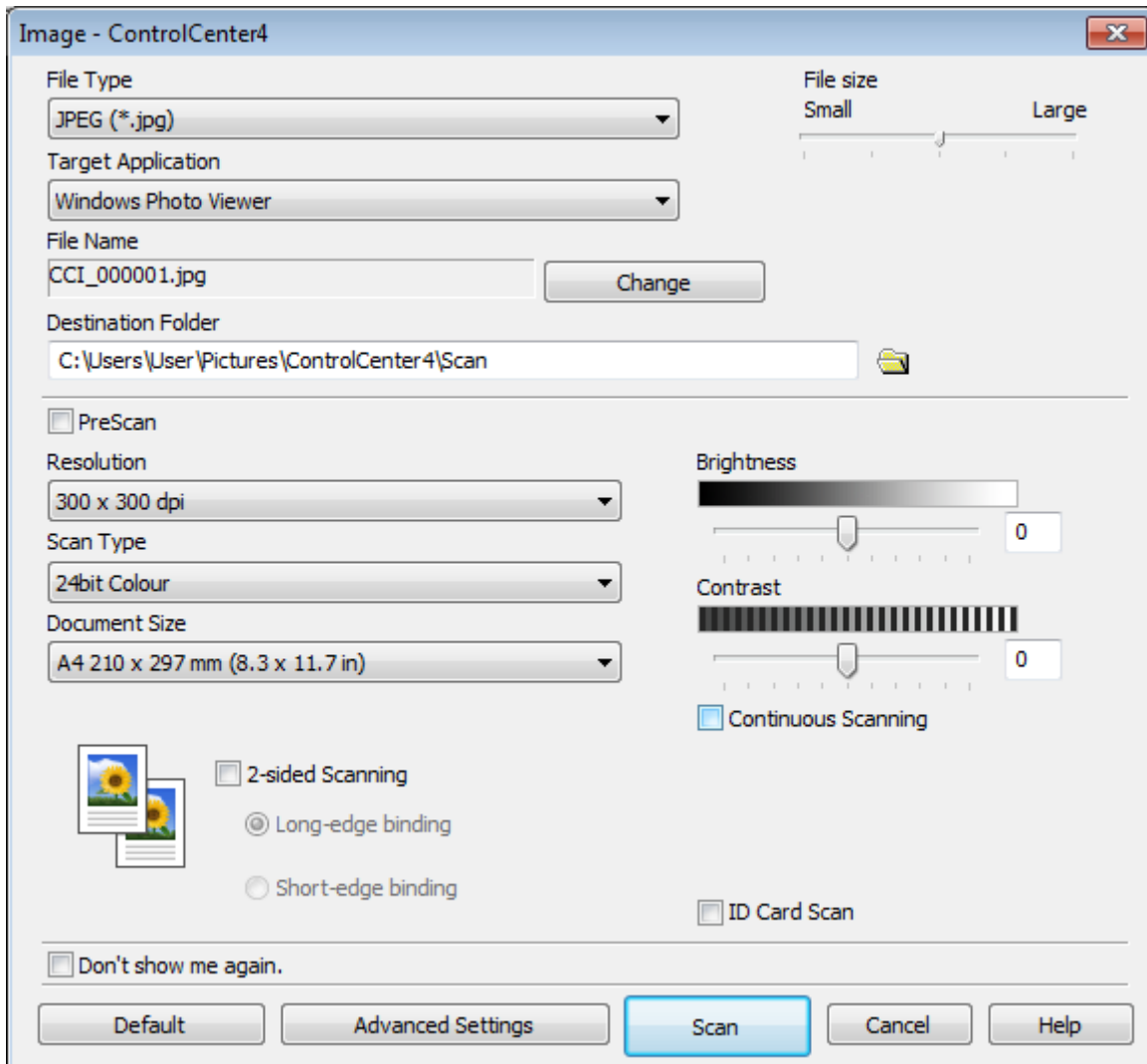

5. Change the scan settings, such as file format, file name, destination file path, resolution and colour, if needed.



- To change the file name, click **Change**.
- To change **Destination Folder**, click the folder icon.
- To preview and configure the scanned image, select the **PreScan** check box.

6. Click **Scan**.

The machine starts scanning. The image opens in the application you have selected.



Related Information

- [Scan Using ControlCenter4 Advanced Mode \(Windows®\)](#)

Home > Scan > Scan from Your Computer(Windows®) > Scan Using ControlCenter4 Advanced Mode (Windows®) > Save Scanned Data to a Folder as a PDF File Using ControlCenter4 Advanced Mode (Windows®)

Save Scanned Data to a Folder as a PDF File Using ControlCenter4 Advanced Mode (Windows®)

Scan documents and save them to a folder on your computer as PDF files.

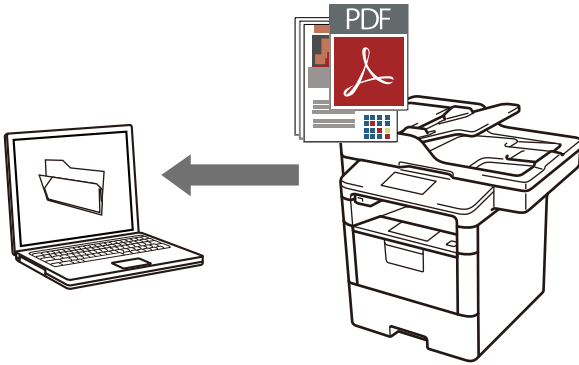

Select **Advanced Mode** as the mode setting for ControlCenter4.

1. Load your document.
2. Click the  (ControlCenter4) icon in the task tray, and then click **Open**.
3. Click the **Scan** tab.



4. Click the **File** button.

The scan settings dialog box appears.

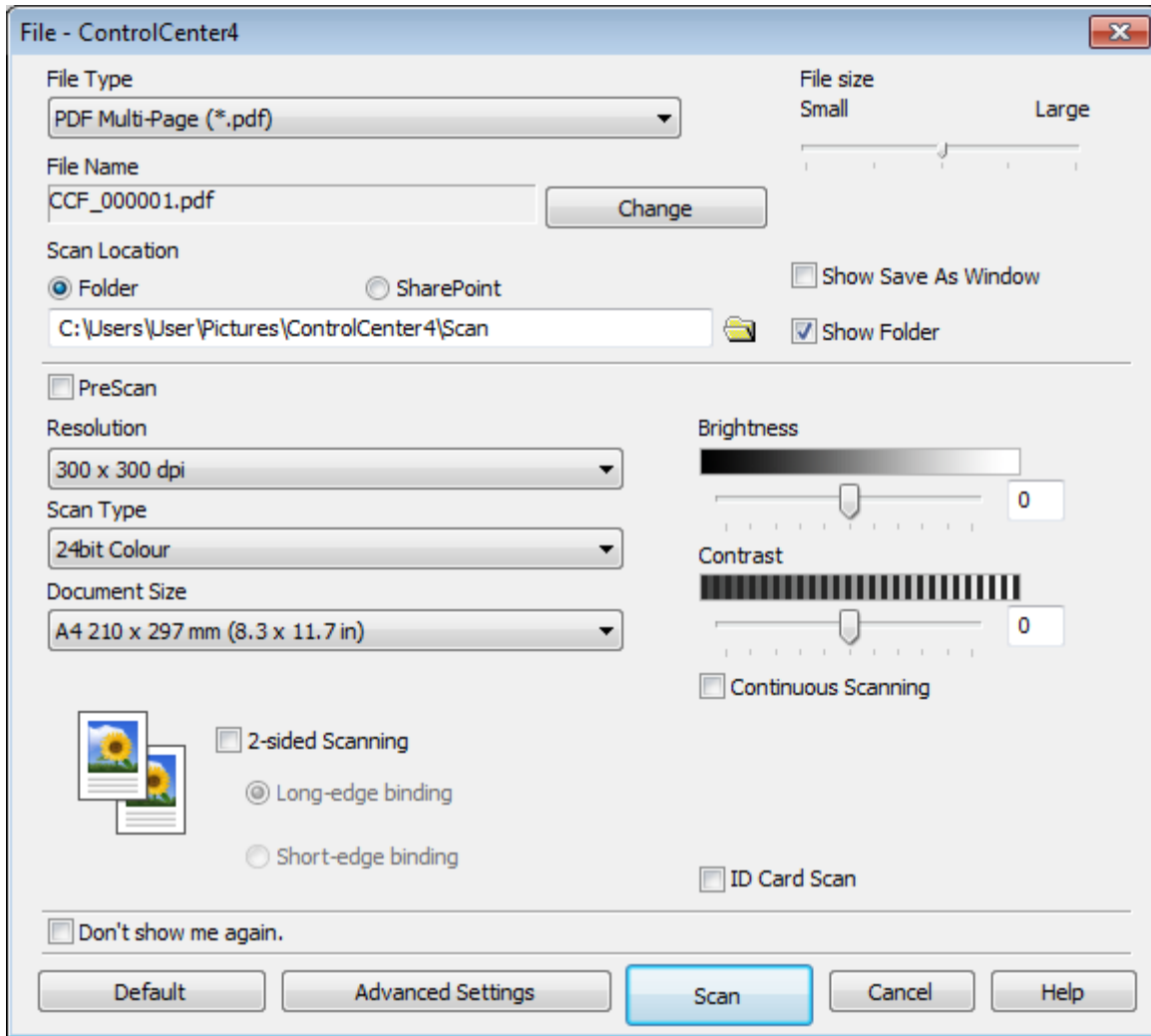

5. Click the **File Type** drop-down list, and then select a PDF file.



To save the document as a password-protected PDF, select **Secure PDF Single-Page (*.pdf)** or **Secure PDF Multi-Page (*.pdf)** from the **File Type** drop-down list, click , and then type the password..

6. Click the folder icon to browse and select the folder where you want to save your scanned documents.
7. Change the scan settings, such as file format, file name, resolution and colour, if needed.



To preview and configure the scanned image, select the **PreScan** check box.

8. Click **Scan**.

The machine starts scanning. The file is saved in the folder you selected.



Related Information

- [Scan Using ControlCenter4 Advanced Mode \(Windows®\)](#)

Scan Both Sides of a Document Automatically Using ControlCenter4 Advanced Mode (Windows®)

Related Models: DocuPrint M385 z/DocuPrint M375 z

Select **Advanced Mode** as the mode setting for ControlCenter4.

1. Load documents in the ADF.





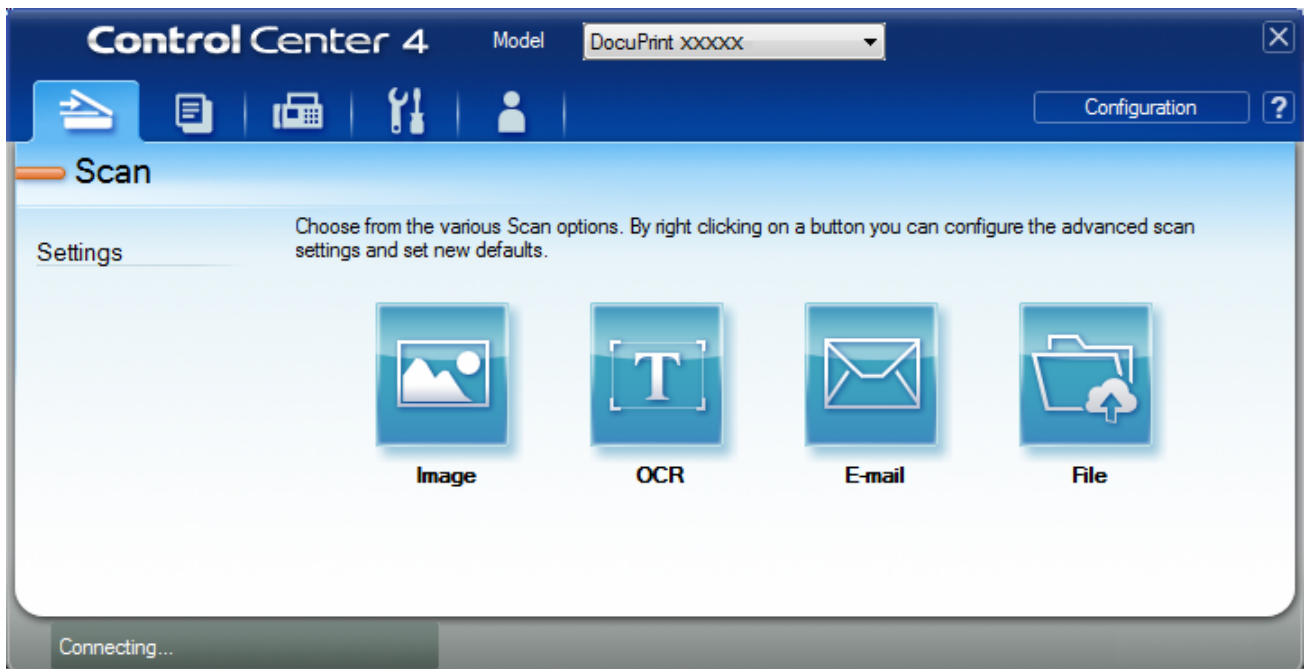

To scan both sides of a document automatically, you must use the ADF, not the flatbed scanner glass.

2. Click the  (**ControlCenter4**) icon in the task tray, and then click **Open**.
3. Click the **Scan** tab.

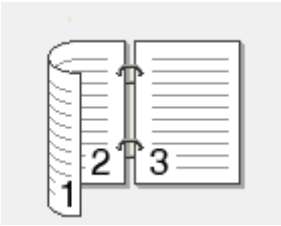

4. Click the button for the setting you want to change (**Image**, **OCR**, **E-mail**, or **File**). The scan settings dialog box appears.
5. Select the **2-sided Scanning** check box.
6. Select the **Long-edge binding** or **Short-edge binding** option, depending on the Original layout (see table for layout examples).

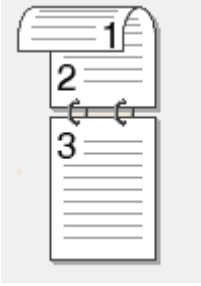
2-sided Scan setting	Original layout	Scan Result
Long-edge binding		

2-sided Scan setting	Original layout	Scan Result
Short-edge binding		

7. Change the scan settings, such as file format, file name, destination file path, resolution and colour, if needed.



- To change the file name, click **Change**.
- To change **Destination Folder**, click the folder icon.

8. Click **Scan**.

The machine starts scanning.

You have now changed the default settings for your selected Scan to action. These settings will be used the next time one of the scan options (**Image**, **OCR**, **E-mail**, or **File**) is selected for this action.



Related Information

- [Scan Using ControlCenter4 Advanced Mode \(Windows®\)](#)

Scan Both Sides of an ID Card Using ControlCenter4 Advanced Mode (Windows®)

Select **Advanced Mode** as the mode setting for ControlCenter4.

1. Place an ID card on the scanner glass.
2. Click the  (ControlCenter4) icon in the task tray, and then click **Open**.
3. Click the **Scan** tab.



4. Click the **File** button.

The scan settings dialog box appears.

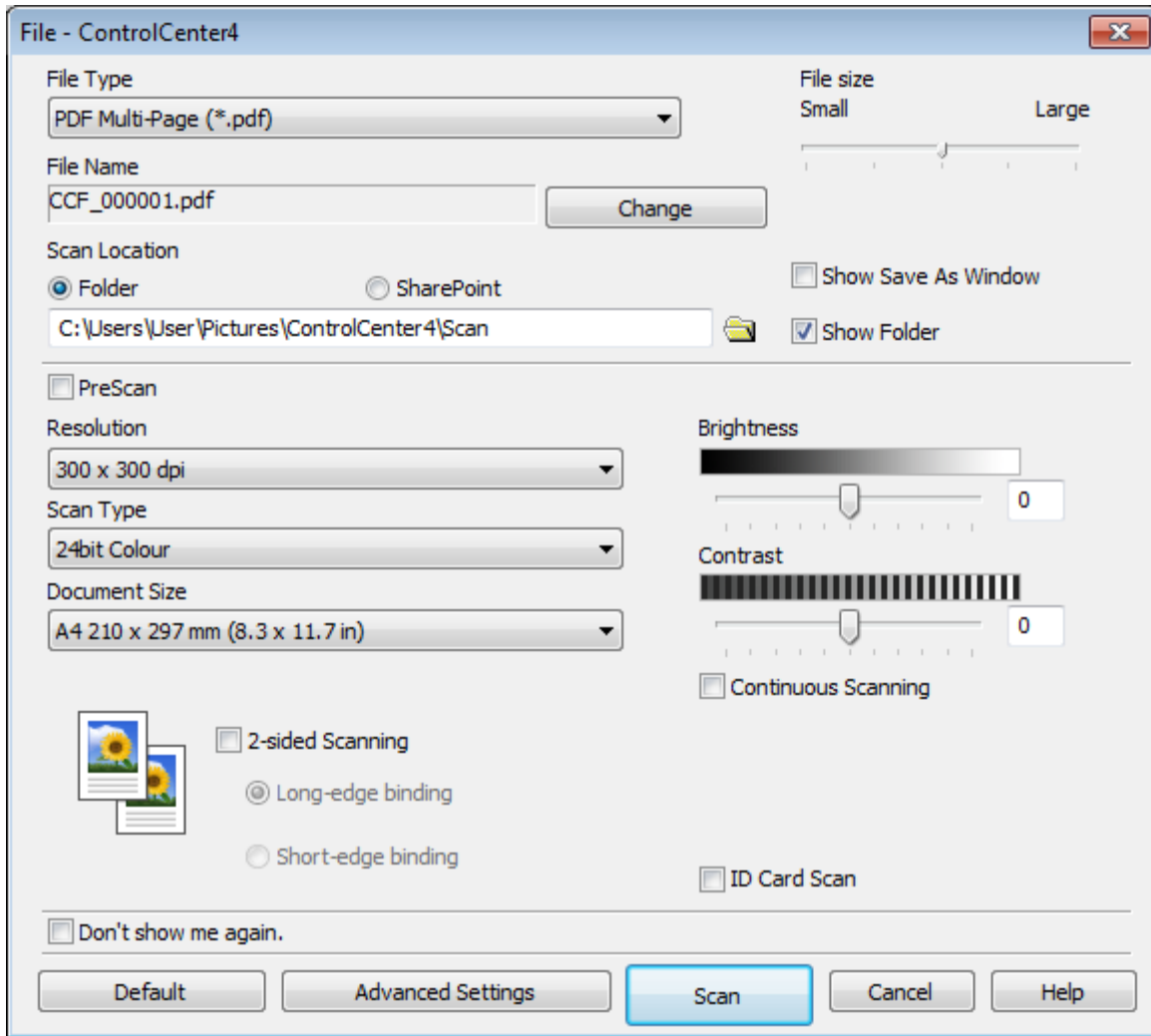

5. Select the **ID Card Scan** check box.

The instruction dialog box appears.

6. Read the instructions on the screen, and then press **OK**.

7. Change the scan settings, such as file format, file name, scan location, resolution and colour, if needed.

8. Click **Scan**.

The machine starts scanning one side of the identification card.

9. After the machine has scanned one side, turn over the identification card, and then click **Continue** to scan the other side.

10. Click **Finish**.



Related Information

- [Scan Using ControlCenter4 Advanced Mode \(Windows®\)](#)

Scan to Email Attachment Using ControlCenter4 Advanced Mode (Windows®)

Send a scanned document as an email attachment.

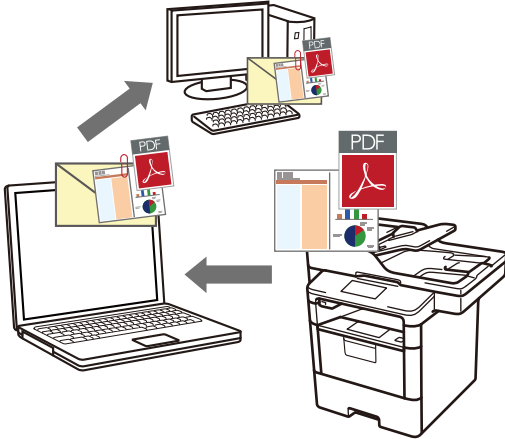

Select **Advanced Mode** as the mode setting for ControlCenter4.

- The Scan to Email feature does not support Webmail services. Use the Scan to Image or Scan to File feature to scan a document or a picture, and then attach the scanned file to an email message.



The machine scans to your default email client.

1. Load your document.
2. Click the  (**ControlCenter4**) icon in the task tray, and then click **Open**.
3. Click the **Scan** tab.

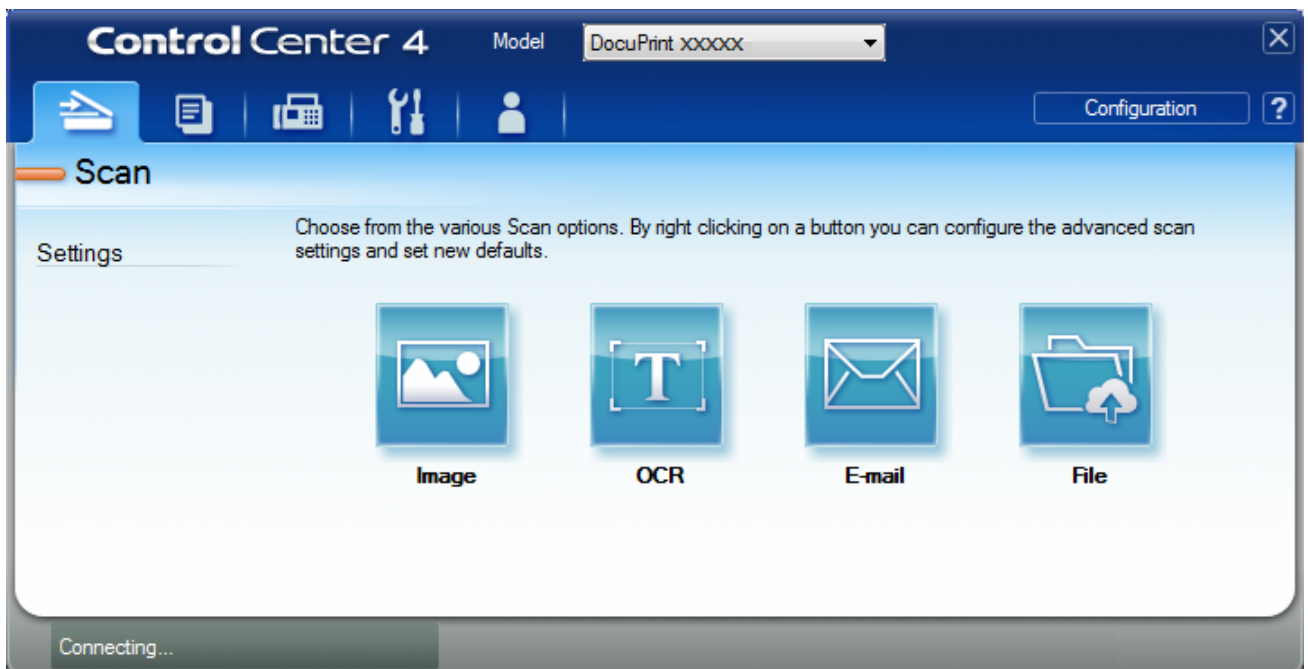

4. Click the **E-mail** button.
The scan settings dialog box appears.

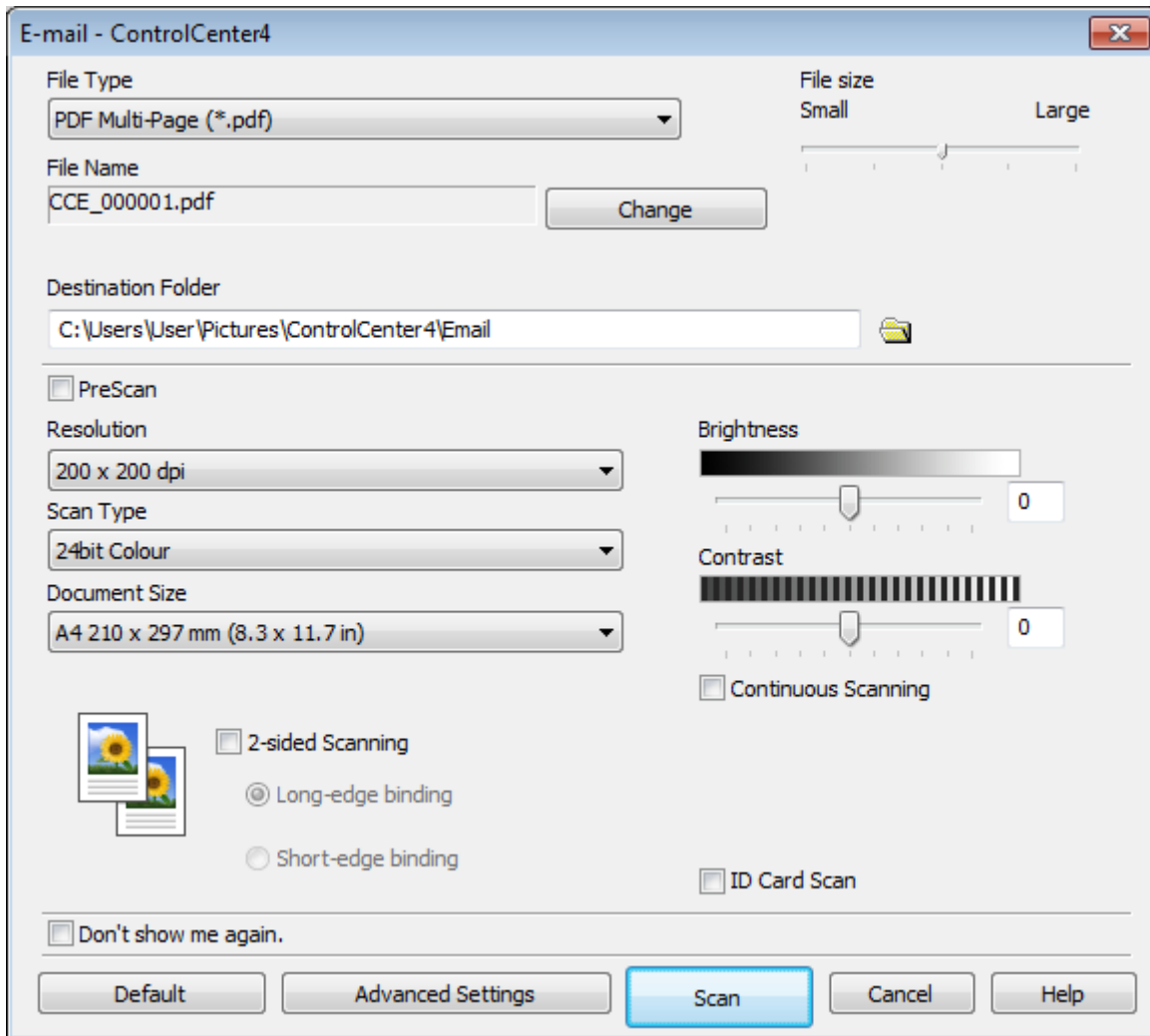

5. Change the scan settings, such as file format, file name, destination file path, resolution and colour, if needed.



- To change the file name, click **Change**.
- To change **Destination Folder**, click the folder icon.
- To preview and configure the scanned image, select the **PreScan** check box.

6. Click **Scan**.

The machine starts scanning. Your default email application opens and the scanned image is attached to a new, blank email message.



Related Information

- [Scan Using ControlCenter4 Advanced Mode \(Windows®\)](#)

Scan to an Editable Text File (OCR) Using ControlCenter4 Advanced Mode (Windows)

Your machine can convert characters in a scanned document to text using optical character recognition (OCR) technology. You can edit this text using your preferred text-editing application.

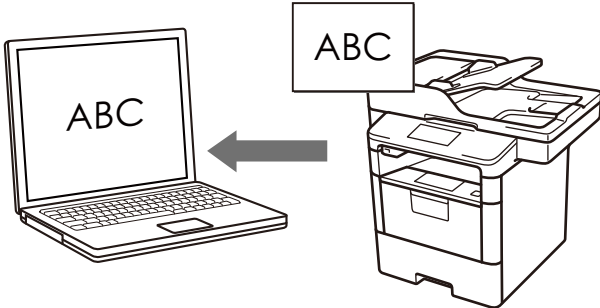

Select **Advanced Mode** as the mode setting for ControlCenter4.

1. Load your document.
2. Click the  (**ControlCenter4**) icon in the task tray, and then click **Open**.
3. Click the **Scan** tab.



4. Click the **OCR** button.
The scan settings dialog box appears.

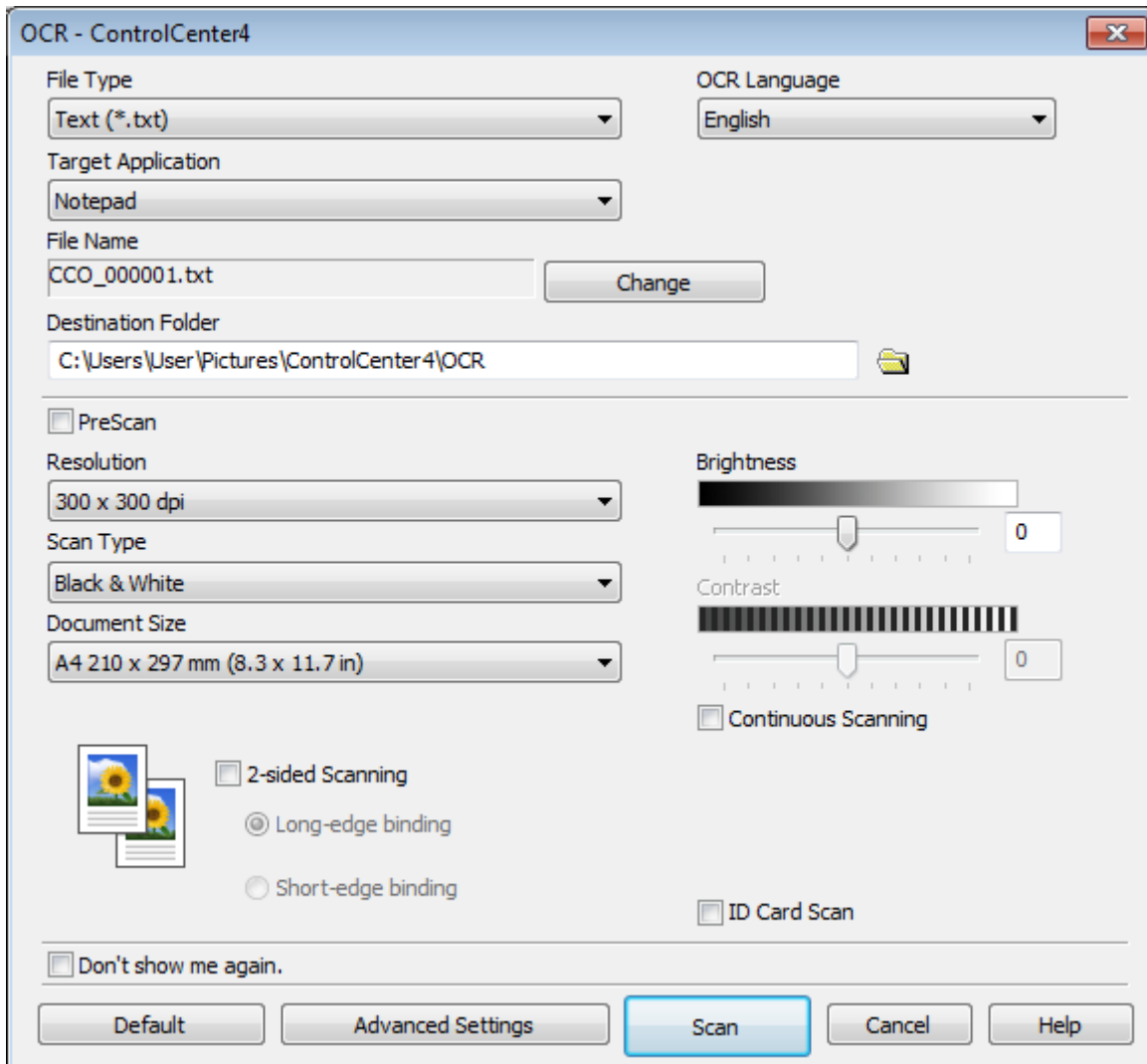

5. Change the scan settings, such as file format, file name, destination file path, resolution and colour, if needed.



- To change the file name, click **Change**.
- To change **Destination Folder**, click the folder icon.
- To preview and configure the scanned image, select the **PreScan** check box.

6. Click **Scan**.

The machine scans the document, converts it to editable text, and then sends it to your default word processing application.



Related Information

- [Scan Using ControlCenter4 Advanced Mode \(Windows®\)](#)

Scan Settings for ControlCenter4 Advanced Mode (Windows®)

Settings	Applicable Features			
	Image	OCR	E-mail	File
File Type	Yes	Yes	Yes	Yes
Target Application	Yes	Yes	-	-
OCR Language	-	Yes	-	-
File Name	Yes	Yes	Yes	Yes
Scan Location or Destination Folder	Yes	Yes	Yes	Yes
Show Folder	-	-	-	Yes
Show Save As Window	-	-	-	Yes
File size	Yes	-	Yes	Yes
PreScan	Yes	Yes	Yes	Yes
Resolution	Yes	Yes	Yes	Yes
Scan Type	Yes	Yes	Yes	Yes
Document Size	Yes	Yes	Yes	Yes
Brightness	Yes	Yes	Yes	Yes
Contrast	Yes	Yes	Yes	Yes
Continuous Scanning	Yes	Yes	Yes	Yes
2-sided Scanning	Yes	Yes	Yes	Yes
ID Card Scan	Yes	Yes	Yes	Yes
Advanced Settings	Yes	Yes	Yes	Yes
Default	Yes	Yes	Yes	Yes

File Type

Select the file type you want to use for the scanned data.

For Image, Email and File

- **Windows Bitmap (*.bmp)**
- **JPEG (*.jpg)** (recommended for most users when scanning pictures)
- **TIFF Single-Page (*.tif)**
- **TIFF Multi-Page (*.tif)**
- **Portable Network Graphics (*.png)**
- **PDF Single-Page (*.pdf)** (recommended for scanning and sharing documents)
- **PDF Multi-Page (*.pdf)** (recommended for scanning and sharing documents)
- **PDF/A Single-Page (*.pdf)** (recommended for scanning and sharing documents)
- **PDF/A Multi-Page (*.pdf)** (recommended for scanning and sharing documents)
- **High Compression PDF Single-Page (*.pdf)**
- **High Compression PDF Multi-Page (*.pdf)**
- **Secure PDF Single-Page (*.pdf)**
- **Secure PDF Multi-Page (*.pdf)**
- **Searchable PDF Single-Page (*.pdf)**

-
- **Searchable PDF Multi-Page (*.pdf)**
 - **XML Paper Specification (*.xps)** (the XML Paper Specification is available for Windows® 7, Windows® 8 and Windows® 10, and when using applications that support XML Paper Specification files)

For Email and File

- **Microsoft Office Word (*.docx)** (Available only for certain models)
- **Microsoft Office PowerPoint (*.pptx)** (Available only for certain models)

For OCR

- **HTML 3.2 (*.htm)**
- **HTML 4.0 (*.htm)**
- **Microsoft Excel 2003, XP (*.xls)**
- **RTF Word 2000 (*.rtf)**
- **WordPad (*.rtf)**
- **WordPerfect 9, 10 (*.wpd)**
- **Text (*.txt)**
- **Searchable PDF Single-Page (*.pdf)**
- **Searchable PDF Multi-Page (*.pdf)**

Target Application

Select the destination application from the drop-down list.

OCR Language

Set the OCR language to match the language of the scanned document's text.

File Name

Click **Change** to change the file name's prefix.

Scan Location

Select the **Folder** or **SharePoint** button to specify the destination where you would like to save your scanned documents.

Destination Folder

Click the folder icon to browse and select the folder where you want to save your scanned documents.

Show Folder

Select this option to automatically display the destination folder after scanning.

Show Save As Window

Select this option to specify the scanned image's destination every time you scan.

File size

Adjust the data compression ratio of the scanned image. Change the file size by moving the **File size** slider to the right or left.

PreScan

Select **PreScan** to preview your image and crop unwanted portions before scanning.

Resolution

Select a scanning resolution from the **Resolution** drop-down list. Higher resolutions take more memory and transfer time, but produce a finer scanned image.

Scan Type

Select from a range of scan colour depths.

- **Auto**
Use for any type of document. This mode automatically picks an appropriate colour depth for the document.
- **Black & White**
Use for text or line art images.

-
- **Grey (Error Diffusion)**
Use for photographic images or graphics. (Error Diffusion is a method for creating simulated grey images without using true grey dots. Black dots are put in a specific pattern to give a grey appearance.)
 - **True Grey**
Use for photographic images or graphics. This mode is more accurate because it uses up to 256 shades of grey.
 - **24bit Colour**
Use to create an image with the most accurate colour reproduction. This mode uses up to 16.8 million colours to scan the image, but it requires the most memory and has the longest transfer time.

Document Size

Select the exact size of your document from the **Document Size** drop-down list.

- If you select **1 to 2 (A4)**, the scanned image will be divided into two A5-size documents.

Brightness

Set the **Brightness** level by dragging the slider to the right or left to lighten or darken the image. If the scanned image is too light, set a lower brightness level and scan the document again. If the image is too dark, set a higher brightness level and scan the document again. You can also type a value into the field to set the **Brightness** level.

Contrast

Increase or decrease the **Contrast** level by moving the slider to the right or left. An increase emphasises dark and light areas of the image, while a decrease reveals more details in grey areas. You can also type a value into the field to set the **Contrast** level.

Continuous Scanning

Select this option to scan multiple pages from the scanner glass or ADF (Available only for certain models). After a page is scanned, select either continue scanning or finish. Use this method to scan more pages than the maximum ADF capacity.

2-sided Scanning

Select this check box to scan both sides of the document. When using the Automatic 2-sided Scan feature, you must select the **Long-edge binding** or **Short-edge binding** option, depending on the layout of your original, to make sure the data file you create appears correctly.

(DocuPrint M385 z/DocuPrint M375 z)

ID Card Scan

Select this check box to scan both sides of an identification card onto one page.

Advanced Settings

Configure advanced settings by clicking the **Advanced Settings** button in the Scan Settings dialog box.

- **Remove Background Colour**
Remove the base colour of documents to make the scanned data more legible. Choose from three settings: high, medium, and low.
(available only for the **Auto**, **True Grey** and **24bit Colour** options)
- **Skip Blank Page**
Remove the document's blank pages from the scanning results.
(DocuPrint M385 z/DocuPrint M375 z)
- **Display Scanning Results**
Show the numbers of total pages saved and blank pages skipped on your computer screen.
(DocuPrint M385 z/DocuPrint M375 z)
- **ADF Auto Deskew**
When scanning the document from the ADF, the machine corrects skewing of the document automatically.

Default

Select this option to restore all settings to their factory setting values.



Related Information

- [Scan Using ControlCenter4 Advanced Mode \(Windows®\)](#)



Scan Using Nuance™ PaperPort™ 14SE or Other Windows® Applications

You can use the Nuance™ PaperPort™ 14SE application for scanning.

- To install the Nuance™ PaperPort™ 14SE application, launch the Fuji Xerox installation disc, click **Install** in the **Additional Software** section.
- Nuance™ PaperPort™ 14SE supports Windows® 7, Windows® 8, Windows® 8.1 and Windows® 10.
- For detailed instructions on using each application, click the application's **Help** menu, and then click **Getting Started Guide** in the **Help** ribbon.



The instructions for scanning in these steps are for PaperPort™ 14SE. For other Windows® applications, the steps will be similar. PaperPort™ 14SE supports both TWAIN and Windows Image Acquisition (WIA) drivers; the TWAIN driver (recommended) is used in these steps.

1. Load your document.
2. Start PaperPort™ 14SE.
Do one of the following:
 - Windows® 7
Using your computer, click  (**Start**) > **All Programs** > **Nuance PaperPort 14** > **PaperPort**.
 - Windows® 8
Click  (**PaperPort**).
 - Windows® 10
Click  **Nuance PaperPort 14** > **PaperPort**.
3. Click the **Desktop** menu, and then click **Scan Settings** in the **Desktop** ribbon.
The **Scan or Get Photo** panel appears on the left side of the screen.
4. From the available Scanners list, select **TWAIN: TW-FX DocuPrint XXXXX** or **TWAIN: TW-FX DocuPrint XXXXX LAN** (where XXXXX is the model name of your machine). To use the Windows Image Acquisition (WIA) driver, select the Fuji Xerox driver that has "Windows Image Acquisition (WIA)" as the prefix.
5. Select the **Display scanner dialog box** check box in the **Scan or Get Photo** panel.
6. Click **Scan**.
The Scanner Setup dialog box appears.

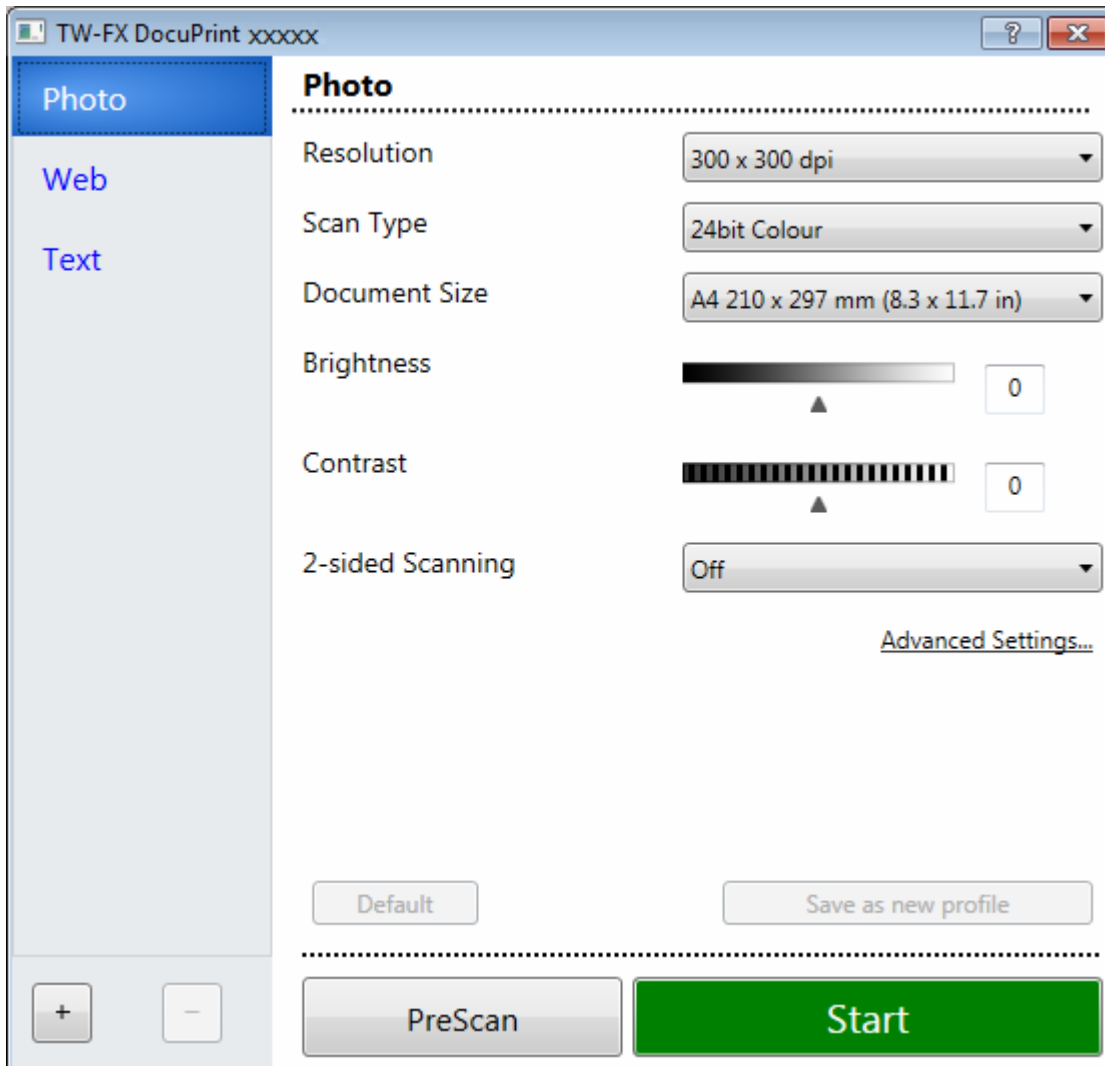

7. Adjust the settings in the Scanner Setup dialog box, if needed.
8. Click the **Document Size** drop-down list, and then select your document size.



To scan both sides of the document (DocuPrint M385 z/DocuPrint M375 z):
Automatic 2-sided scan is available only when using the ADF.
You cannot use PreScan to preview an image.

9. Click **PreScan** if you want to preview your image and crop unwanted portions before scanning.
10. Click **Start**.
The machine starts scanning.



Related Information

- [Scan from Your Computer\(Windows®\)](#)
-

Scan Using Windows® Photo Gallery or Windows® Fax and Scan

Windows® Photo Gallery or Windows® Fax and Scan applications are other options that you can use for scanning.

- These applications use the Windows Image Acquisition (WIA) scanner driver.
- If you want to crop a portion of a page after pre-scanning the document, you must scan using the scanner glass (also called the flatbed).

1. Load your document.
2. Launch your scanning application. Do one of the following:
 - (Windows® Photo Gallery)
Click **File > Import from Camera or Scanner**.
 - (Windows® Fax and Scan)
Click **File > New > Scan**.
3. Select the scanner you want to use.
4. Click **Import** or **OK**.
The **New Scan** dialog box appears.

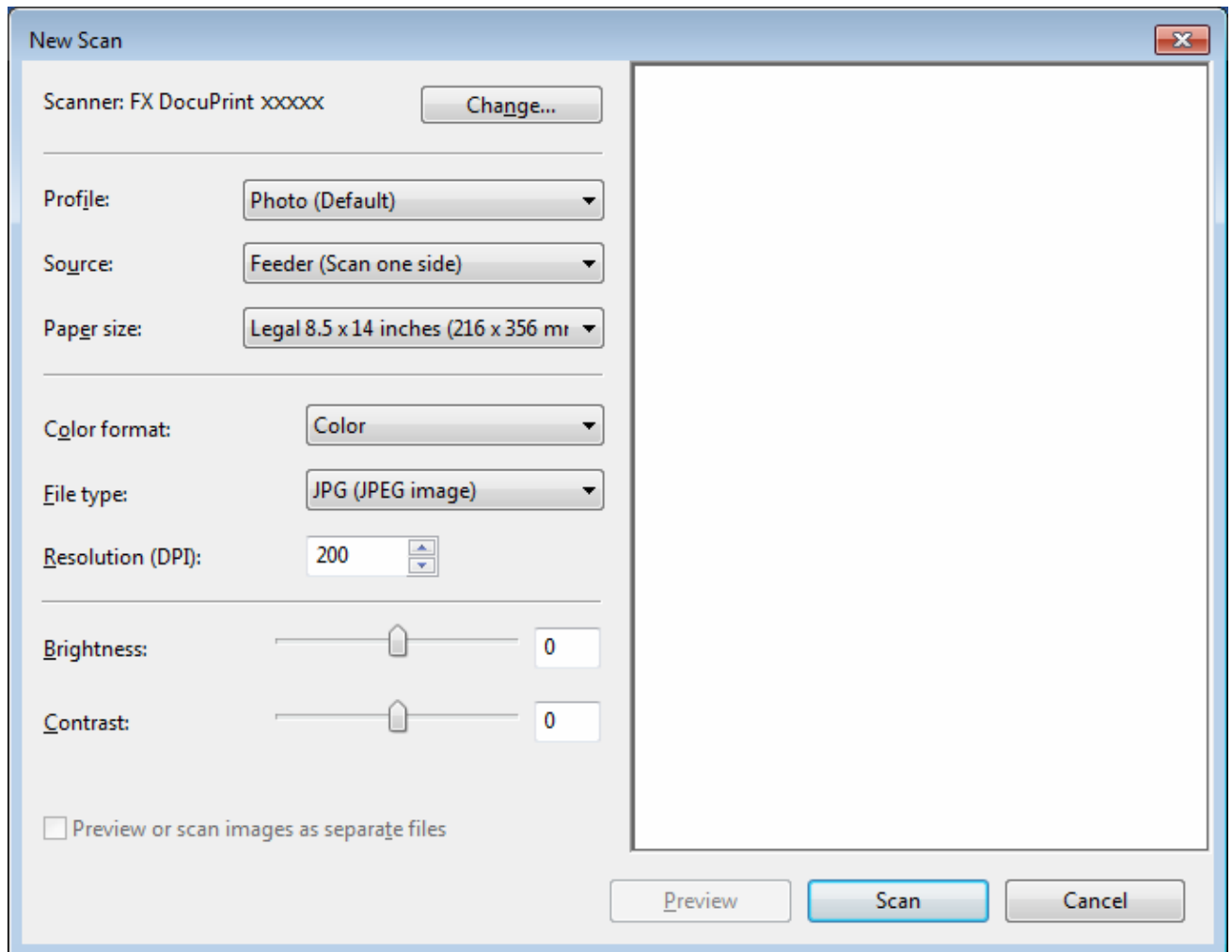

5. Adjust the settings in the Scanner Setup dialog box, if needed.
The scanner resolution can be set to a maximum of 1200 dpi. If you want to scan at higher resolutions, use the **Scanner Utility** software of **Fuji Xerox Utilities**.
If your machine supports 2-sided Scan and you want to scan both sides of your document, select **Feeder (Scan both sides)** as **Source**.

6. Click **Scan**.

The machine starts scanning the document.



Related Information

- [Scan from Your Computer\(Windows®\)](#)
 - [Windows Image Acquisition \(WIA\) Driver Settings \(Windows®\)](#)
-

Windows Image Acquisition (WIA) Driver Settings (Windows®)

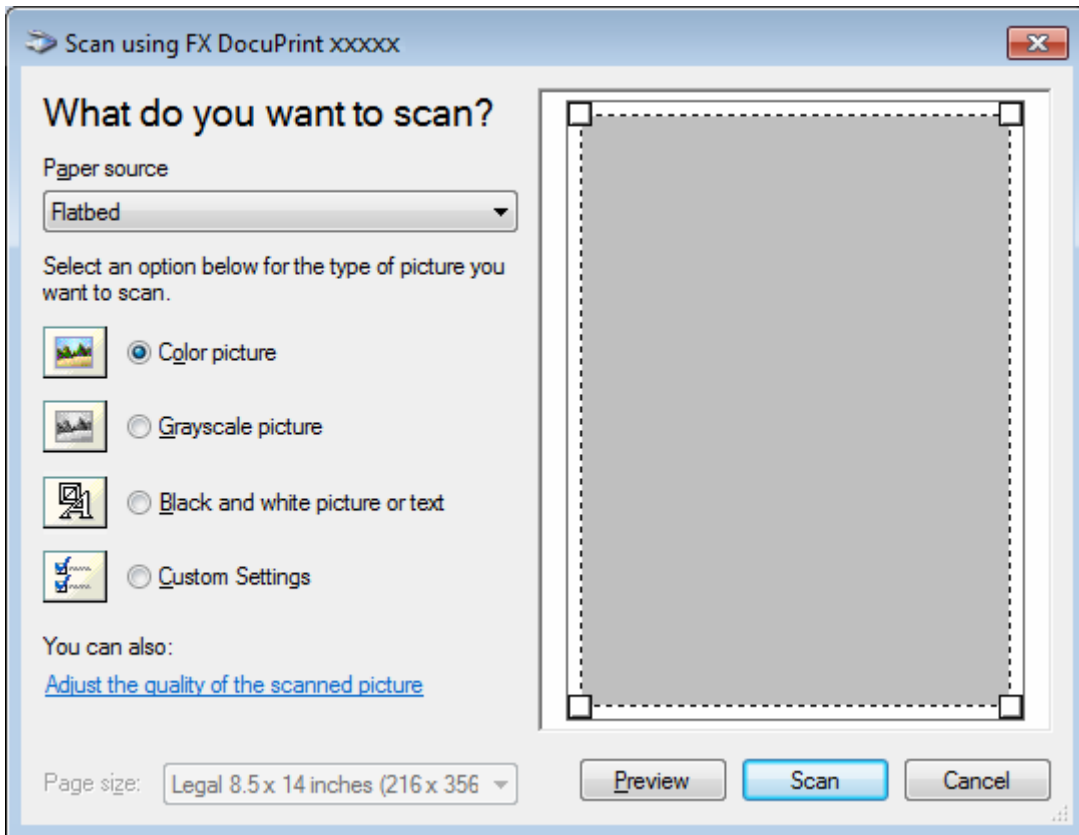

Paper source

Select the **Document Feeder** or **Flatbed** option from the drop-down list.

Picture Type (Image Type)

Select **Color picture**, **Grayscale picture**, **Black and white picture or text**, or **Custom Settings** for the type of document you want to scan.

To change advanced settings, click the **Adjust the quality of the scanned picture** link.

Page size

The **Page size** option is available if you select the **Document Feeder** as the **Paper source** option.

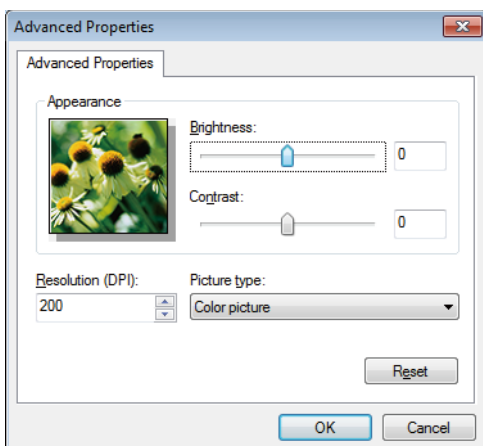

Brightness

Set the **Brightness** level by dragging the slider to the right or left to lighten or darken the image. If the scanned image is too light, set a lower brightness level and scan the document again. If the image is too dark, set a higher brightness level and scan the document again.

Contrast

Increase or decrease the **Contrast** level by moving the slider to the right or left. An increase emphasises dark and light areas of the image, while a decrease reveals more details in grey areas. You can also type a value in the field to set the contrast level.

Resolution (DPI)

Select a scanning resolution from the **Resolution (DPI)** list. Higher resolutions take more memory and transfer time, but produce a finer scanned image.



Related Information

- [Scan Using Windows® Photo Gallery or Windows® Fax and Scan](#)
-

Configure Scan Settings Using Web Based Management

- [Set the Scan Job Email Report Using Web Based Management](#)

Set the Scan Job Email Report Using Web Based Management

When you scan a document, the machine will send a scan job email report automatically to the registered email address.

1. Start your web browser.

Type "http://machine's IP address" in your browser's address bar (where "machine's IP address" is the IP address of the machine or the print server name). For example: http://192.0.2.1

Type a password, and then click . The default password is "x-admin". To ensure security, it is important you change the password.

2. Click the **Scan** tab.
3. Click the **Scan Job e-mail report** menu in the left navigation bar.
4. In the **Administrator Address** field, type the email address.
5. For the scan functions you want, select **On** to send a scan job email report.
6. Click **Submit**.



Related Information

- [Configure Scan Settings Using Web Based Management](#)

Scan Using iPrint&Scan (Mac)

1. In the **Finder** menu bar, click **Go > Applications > Fuji Xerox**, and then double-click the iPrint&Scan icon. The iPrint&Scan screen appears.
2. If your Fuji Xerox machine is not selected, click the **Select your Machine** button, and then follow the on-screen instructions to select your Fuji Xerox machine.
3. Click the **Scan** icon, and then follow the on-screen instructions to scan your documents.



Related Information

- [Scan](#)

Related Topics

- [iPrint&Scan for Mac](#)
 - [Change Scan Button Settings from iPrint&Scan \(Mac\)](#)
-

Copy

- [Copy a Document](#)
- [Enlarge or Reduce Copied Images](#)
- [Make N in 1 Copies Using the Page Layout Feature](#)
- [Sort Copies](#)
- [Copy an ID Card](#)
- [Copy on Both Sides of the Paper \(2-sided Copy\)](#)
- [Copy Options](#)

Copy a Document

1. Make sure you have loaded the correct size paper in the paper tray.
2. Do one of the following:
 - Place the document *face up* in the ADF.
(If you are copying multiple pages, we recommend using the ADF.)

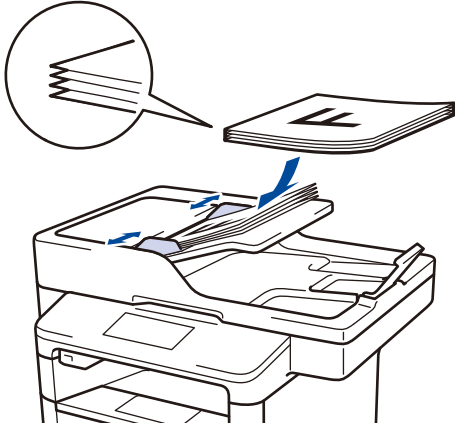

- Place the document *face down* on the scanner glass.

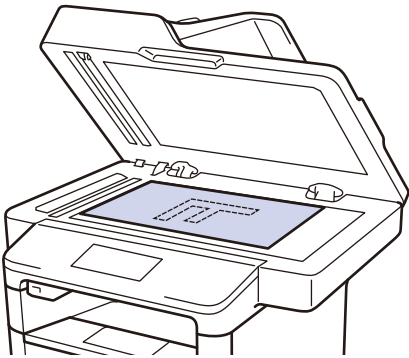





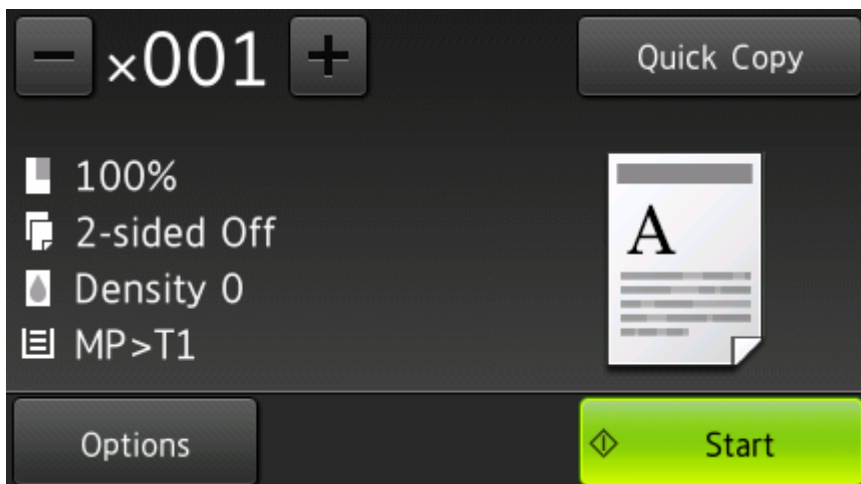

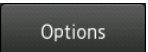

3. Press  [Copy].

The LCD displays:



4. Change the copy settings, if needed.
 - **x001** (Number of copies)
Enter the number of copies in one of the following ways:

-
- Press  or  on the LCD.
 - Press the numbers on the control panel.
 - [Options]
Press  to change the copy settings for the next copy only.
 - When finished, press [OK].
 - After you have finished choosing new options, you can save them by pressing the [Save as Shortcut] button.
 - [Quick Copy]
Press  to access the preset copy settings.
 - Current setting indications
Press the following icons to change these settings for the next copy only.
 -  [Enlarge/Reduce]
 -  [2-sided Copy]
 -  [Density]
 -  [Tray Use]

5. Press [Start].



To stop copying, press .







Related Information

- [Copy](#)
-

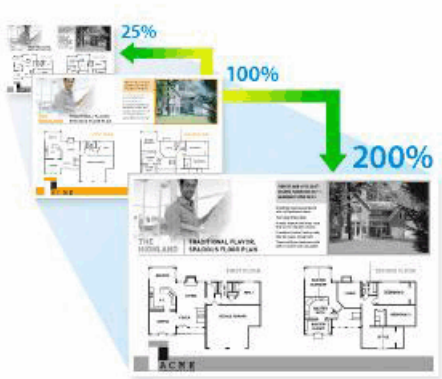
Enlarge or Reduce Copied Images

Select an enlargement or reduction ratio to resize your copied data.



1. Load your document.
 2. Press  [Copy].
 3. Enter the number of copies.
 4. Press [Options] > [Enlarge/Reduce].
 5. Swipe up or down or press ▲ or ▼ to display the available options, and then press the option you want.
 6. Do one of the following:
 - If you select [Enlarge] or [Reduce], press the enlargement or reduction ratio you want to use.
 - If you select [Custom (25-400%)], press  (backspace) to erase the displayed percentage, or press ◀ to move the cursor, and then enter an enlargement or reduction ratio from [25] to [400]. Press [OK].
 - If you selected [100%] or [Auto], go to the next step.
-
-  • [Auto] sets the machine to calculate the reduction ratio that best fits the size of paper.
- [Auto] is only available when using the ADF.
-
7. When finished, press [OK].
 8. Press [Start].

Related Information

- [Copy](#)

Make N in 1 Copies Using the Page Layout Feature

The N in 1 copy feature saves paper by copying two or four pages of your document onto one page of the copy.



If you are copying from the ADF, insert the documents face up in the direction as shown below:

- 2 in 1 (Portrait)



- 2 in 1 (Landscape)



- 4 in 1 (Portrait)

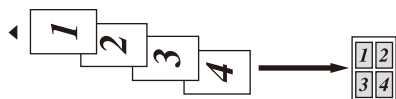

- 4 in 1 (Landscape)

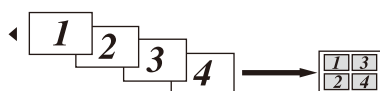

If you are copying from the scanner glass, place the document face down in the direction as shown below:

- 2 in 1 (Portrait)



- 2 in 1 (Landscape)

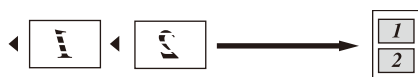

- 4 in 1 (Portrait)



- 4 in 1 (Landscape)

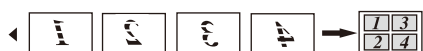

-
1. Load your document.
 2. Press  [Copy].
 3. Enter the number of copies.
 4. Press [Options] > [Page Layout].
 5. Swipe up or down or press ▲ or ▼ to display the [2in1 (Portrait)], [2in1 (Landscape)], [4in1 (Portrait)] or [4in1 (Landscape)] option, and then press the option you want.
 6. When finished, press [OK].
 7. Press [Start].
If you placed the document in the ADF, the machine scans the pages and starts printing.
 8. **If you are using the scanner glass, repeat the following steps for each page of the document:**
 - Place the next page on the scanner glass, and then press [Continue] to scan the page.
 - After scanning all the pages, press [Finish].



Related Information

- [Copy](#)
-

Sort Copies

Sort multiple copies. Pages will be stacked in the order they are fed, that is: 1, 2, 3, and so on.

1. Load your document.
2. Press  [Copy].
3. Enter the number of copies.
4. Press [Options] > [Stack/Sort] > [Sort].
5. When finished, press [OK].
6. Press [Start].

If you placed the document in the ADF, the machine scans the pages and starts printing.

7. If you are using the scanner glass, repeat the following steps for each page of the document:

- Place the next page on the scanner glass, and then press [Continue] to scan the page.
- After scanning all the pages, press [Finish].



Related Information

- [Copy](#)

Copy an ID Card

Use the [2 in 1 ID Copy] feature to copy both sides of an identification card onto one page, keeping the original card size.

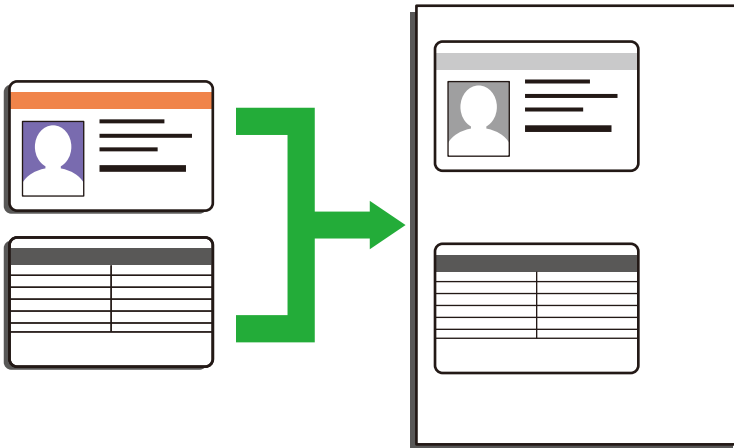

- You may copy an identification card only to the extent permitted under applicable laws. For more information, see the *Safety Guide*.

1. Place your identification card *face down* near the upper left corner of the scanner glass.

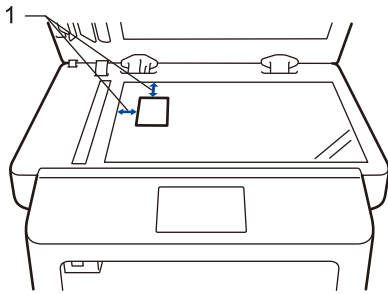

1: Distance 4.0 mm or greater (top, left)

2. Swipe left or right or press ◀ or ▶ to display the [2 in 1 ID Copy] option, and then press [2 in 1 ID Copy].
3. Enter the number of copies.
4. Press [Start].
The machine scans one side of the identification card.
5. After the machine has scanned the first side, turn over the identification card.

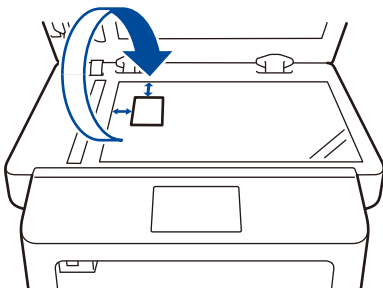

6. Press [Continue] to scan the other side.



Related Information

- Copy

Copy on Both Sides of the Paper (2-sided Copy)

Reduce the amount of paper you use by copying onto both sides of the paper.

- You must choose a 2-sided copy layout from the following options before you can start 2-sided copying.
- The layout of your original document determines which 2-sided copy layout you should choose.
- To use the automatic 2-sided copy feature, you must load your document in the ADF.
- When you manually make 2 sided copies from a 2-sided document, use the scanner glass.
- (For models without the lever on the 2-sided tray) Select A4 sized paper when using the 2-sided copy option.
- (For models with the lever on the 2-sided tray) Select A4, Letter, Legal, Mexico Legal, India Legal or Folio sized paper when using the 2-sided copy option.
- Make sure the 2-sided tray is set to the correct paper size. If it is not, the paper may not be fed correctly, resulting in a skewed printout or a paper jam.

Portrait

2-sided to 2-sided

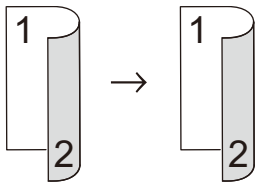

1-sided to 2-sided (Long Edge Flip)

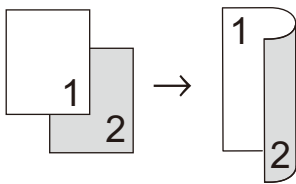

1-sided to 2-sided (Short Edge Flip)

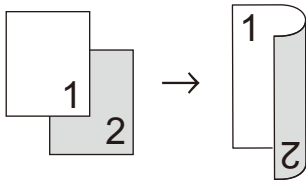

Landscape

2-sided to 2-sided

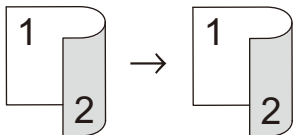

1-sided to 2-sided (Long Edge Flip)

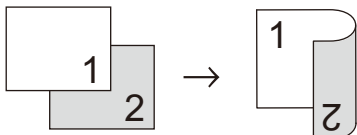

1-sided to 2-sided (Short Edge Flip)

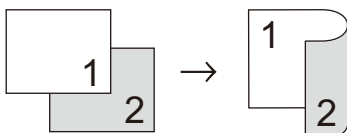

1. Load your document.

2. Press  [Copy].

3. Enter the number of copies.

4. Press [Options] > [2-sided Copy].

5. Do one of the following:

- (DocuPrint M385 z/DocuPrint M375 z)
To make 2-sided copies of a 2-sided document automatically, press [2-sided⇒2-sided].



Load your document in the ADF to use the automatic 2-sided copy feature.

- (DocuPrint M375 df)
To make 2-sided copies of a 2-sided document manually, press [2-sided⇒2-sided].



Use the scanner glass to make 2-sided copies of a 2-sided document manually.

- To make 2-sided copies from a 1-sided document, follow these steps:
 - a. To change the layout options, press [Layout], and then press [Long Edge Flip] or [Short Edge Flip].
 - b. Press [1-sided⇒2-sided].

6. When finished, press [OK].

7. Press [Start].

If you placed the document in the ADF, the machine scans the pages and starts printing.

8. If you are using the scanner glass, repeat the following steps for each page of the document:



- For a 2-sided document, turn the sheet over along the long edge to scan the other side.
-
- Place the next page on the scanner glass, and then press [Continue] to scan the page.
 - After scanning all the pages, press [Finish].



Related Information

- [Copy](#)
-

Copy Options

To change Copy settings, press [Options].

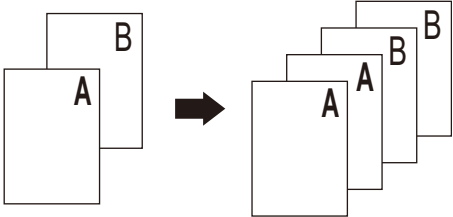
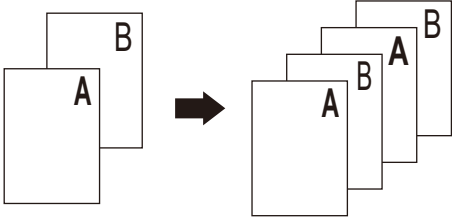
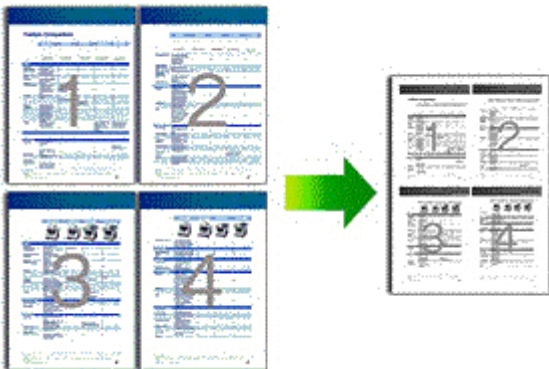
Menu selections	Options	
Quality	Select the copy quality for your type of document.	
Enlarge/Reduce	100%	-
	Enlarge	Select an enlargement ratio for the next copy.
	Reduce	Select a reduction ratio for the next copy.
	Auto	Adjusts the copy size to fit on the paper size you have set.
	Custom (25-400%)	Enter an enlargement or reduction ratio.
Density	Increase the density to make the text darker. Decrease the density to make the text lighter.	
Contrast	Increase the contrast to make an image clearer. Decrease the contrast to make an image more subdued.	
Stack/Sort	Select to stack or sort multiple copies. Stack  Sort 	
Page Layout	Make N in 1 or 2 in 1 ID copies. 4 in 1 	

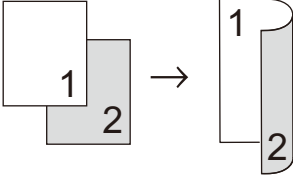
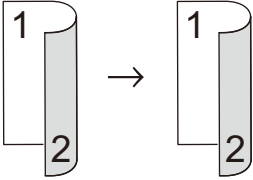
Menu selections	Options
2-sided Copy	<p>Select to copy on both sides of the paper.</p> <p>1-sided → 2-sided</p>  <p>2-sided → 2-sided</p>  <p>The available options will vary depending on your model.</p>
2-sided Copy Page Layout (available only for certain settings)	Select long edge binding or short edge binding.
Tray Use	Select a paper tray for the next copy.
Save as Shortcut	Add the current settings as a shortcut.



Related Information

- [Copy](#)

Fax

- [Send a Fax](#)
- [Receive a Fax](#)
- [Voice Operations and Fax Numbers](#)
- [Telephone Services and External Devices](#)
- [Fax Reports](#)
- [PC-FAX](#)

Send a Fax

- [Send a Fax](#)
- [Send a 2-sided Fax from the ADF](#)
- [Send a Fax Manually](#)
- [Send a Fax at the End of a Conversation](#)
- [Send the Same Fax to More than One Recipient \(Broadcasting\)](#)
- [Send a Fax in Real Time](#)
- [Send a Fax at a Specified Time \(Delayed Fax\)](#)
- [Add a Cover Page to Your Fax](#)
- [Cancel a Fax in Progress](#)
- [Check and Cancel a Pending Fax](#)
- [Fax Options](#)

Send a Fax

1. Do one of the following:

- Place the document *face up* in the ADF.
(If you are faxing multiple pages, we recommend using the ADF.)

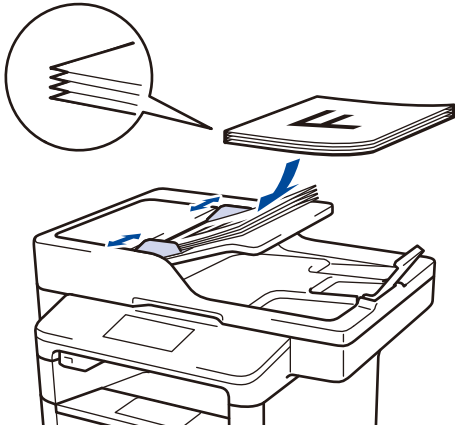

- Place the document *face down* on the scanner glass.

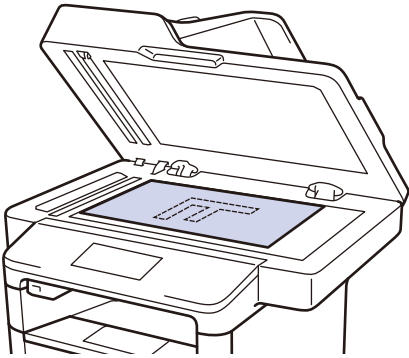

2. Press  [Fax].

3. Enter the fax number.

- **Using the dial pad**
Press the digits to enter the fax number.

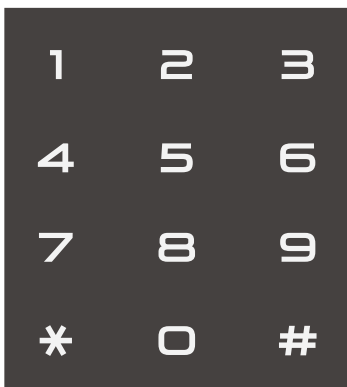

- **Using the Address Book**

Press  [Address Book], and then do one of the following:

- Swipe up or down or press ▲ or ▼ to display the number you want, and then press it.
- Press  [Search:], and then enter the name and press [OK]. Press the name you want to dial.

When finished, press [Apply].

- **Using the call history**

Press  [Call History], and then press the [Outgoing Call] option.

Swipe up or down or press ▲ or ▼ to display the fax number you want, and then press it.

To send a fax, press [Apply].

4. Press [Fax Start].

The machine scans and sends the document.

If you placed the document on the scanner glass, follow the instructions in the table.

Option	Description
Yes	To scan the next page, press the Yes option, and then place the next page on the scanner glass. Press OK to scan the page.
No	After you have scanned the last page, press the No option. The machine sends the document.

To stop faxing, press , and then press .

Related Information

- [Send a Fax](#)
-

Send a 2-sided Fax from the ADF

Related Models: DocuPrint M385 z/DocuPrint M375 z

You must select a 2-sided scanning format before sending a 2-sided fax. Select either Long Edge or Short Edge, depending on the layout of your document.

1. Load your document.
2. Press  [Fax] > [Options] > [2-sided Fax].
3. Do one of the following:
 - If your document is flipped on the Long edge, press the [2-sided Scan: Long Edge] option.
 - If your document is flipped on the Short edge, press the [2-sided Scan: Short Edge] option.
4. Press [OK].
5. Enter the fax number.
6. Press [Fax Start].



Related Information

- [Send a Fax](#)

Send a Fax Manually

Manual fax transmission lets you hear the dialling, ringing and fax-receiving tones while sending a fax.

1. Load your document.
2. Press  [Fax].
3. Press [Hook] and listen for a dial tone.
4. Dial the fax number you want to call.
5. When you hear the fax tone, press [Fax Start].
 - If you are using the scanner glass, press [Send].



Related Information

- [Send a Fax](#)
-

Send a Fax at the End of a Conversation

At the end of a conversation, you can send a fax to the other party before you both hang up.

1. Ask the other party to wait for fax tones (beeps) and then to press the Start or Send key before hanging up.
2. Load your document.
3. Press [Fax Start].
 - If you are using the scanner glass, press [Send].
4. Replace the handset of an external telephone.



Related Information

- [Send a Fax](#)
-

Send the Same Fax to More than One Recipient (Broadcasting)

Use the Broadcasting feature to send the same fax to multiple fax numbers at the same time.

- The same broadcast can include Groups, Address Book numbers (One Touch Dial numbers and Speed Dial numbers in some models) and up to 50 manually dialled numbers.
- Touchscreen LCD models
If you did not use any of the Address Book numbers for Groups, you can broadcast faxes to as many as 350 different numbers.
- Address Book numbers (One Touch Dial numbers and Speed Dial numbers in some models) must be stored in the machine's memory before they can be used in a broadcast.
- Group numbers must also be stored in the machine's memory before they can be used in a broadcast. Group numbers include many stored Address Book numbers (One Touch Dial numbers and Speed Dial numbers in some models) for easier dialling.

1. Load your document.

2. Press  [Fax] > [Options] > [Broadcasting].

3. Press [Add Number].

You can add numbers to the broadcast in the following ways:

- Press [Add Number] and enter a number using the LCD. Press [OK].



(DocuPrint M385 z/DocuPrint M375 z)

If you want to broadcast using an email address, press , enter the email address, and press [OK].

- Press [Add from Address book]. Swipe up or down or press ▲ or ▼ to display the number you want to add to the broadcast. Select the check boxes of the broadcast. After you select all the numbers you want, press [OK].
- Press [Search in Address book]. Press the name and press [OK]. Press the name, and then press the number you want to add.

4. When finished, press [OK].

5. Press [Fax Start]. After the broadcast is finished, the machine will print a broadcast report to let you know the results.



- The machine's available memory will vary depending on the types of jobs in the memory and the numbers used for broadcasting. If you broadcast to the maximum number available, you will not be able to use dual access and delayed fax.
- If the [Out of Memory] message appears, press  to stop the job. If more than one page has been scanned, press [Send Now] to send the portion that is in the machine's memory.





Related Information

- [Send a Fax](#)
- [Cancel a Broadcast in Progress](#)

Cancel a Broadcast in Progress

While broadcasting you can cancel the fax currently being sent or the whole broadcast job.

1. Press .
2. Press .
3. Do one of the following:
 - To cancel the entire broadcast, press [Entire Broadcast].
 - To cancel the current job, press the name or number being dialled on the LCD.
 - To exit without cancelling, press .



Related Information

- [Send the Same Fax to More than One Recipient \(Broadcasting\)](#)

Send a Fax in Real Time

When sending a fax, the machine scans the document into the memory before sending it. As soon as the telephone line is free, the machine starts dialling and sending. If you want to send an important document immediately without waiting for the machine to retrieve the scan from its memory, turn on [Real Time TX].

- If the memory is full and you are sending a fax from the ADF, the machine sends the document in real time (even if [Real Time TX] is set to [Off]). If the memory is full, faxes from the scanner glass cannot be sent until you clear some of the memory.
- In Real Time Transmission, the automatic redial feature does not work when using the scanner glass.
- If [Real Time TX] is set to on, the option to scan 2-sided documents is not available.

1. Load your document.
2. Press  [Fax] > [Options] > [Real Time TX].
3. Press [On] or [Off].
4. Press [OK].
5. Enter the fax number.
6. Press [Fax Start].





Related Information

- [Send a Fax](#)

Send a Fax at a Specified Time (Delayed Fax)

You can store up to 50 faxes in the machine's memory to be sent within the next twenty-four hour period.

1. Load your document.
2. Press  [Fax] > [Options] > [Delayed Fax] > [Delayed Fax].
3. Press [On].
4. Press [Set Time].
5. Enter the time you want the fax to be sent (in 24-hour format), and then press [OK].
(For example, enter 19:45 for 7:45 PM.)
6. Press [OK].
7. Enter the fax number.
8. Press [Fax Start].
9. Press .





Related Information

- [Send a Fax](#)

Add a Cover Page to Your Fax

You can add a cover page to the next fax or every outgoing fax.

- This feature will not work unless you have programmed your Station ID.
- Your cover page includes your Station ID, a comment, and the name stored in the Address Book, One Touch Dial, or Speed Dial (in some models).

1. Load your document.
2. Press  [Fax] > [Options] > [Coverpage Setup] > [Coverpage Setup].
3. Press [On].
4. Press [Coverpage Note].
5. Swipe up or down or press ▲ or ▼ to choose the comment you want to use, and then press the comment.
Press .
6. Press [OK].
7. Enter the fax number.
8. Press [Fax Start].

The cover page will be added to the next fax. If you want to add the cover page to every outgoing fax, set the settings as the new default.





Related Information

- [Send a Fax](#)
- [Compose Your Own Comments](#)
- [Use a Printed Cover Page](#)

Compose Your Own Comments

You can set up two comments of your own.

1. Press  [Settings] > [All Settings] > [Fax] > [Setup Send] > [Coverpage Setting] > [Coverpage Note].
2. Press [5.] or [6.] to store your own comment.
3. Enter your own comment using the LCD. Press [OK].
Press  to choose numbers, letters or special characters.
4. Press .





Related Information

- [Add a Cover Page to Your Fax](#)

Use a Printed Cover Page

If you want a printed cover page you can write on, print the sample page and attach it to your fax.



1. Press  [Settings] > [All Settings] > [Fax] > [Setup Send] > [Coverage Setting] > [Print Sample].
2. Press [Yes].
The machine prints the sample cover page.
3. Press .



Related Information

- [Add a Cover Page to Your Fax](#)

Cancel a Fax in Progress

1. Press .
2. Press  while the machine is dialling or sending a fax.
The LCD will display [Cancel Job?].
3. Press an option in the table to cancel or continue the fax job in progress.

Option	Description
Yes	The machine cancels sending the fax job.
No	The machine exits from the process without cancelling the fax job.





Related Information

- [Send a Fax](#)

Check and Cancel a Pending Fax

You can cancel a fax job before it is sent, by cancelling the fax job while it is stored and waiting in the memory.

1. Press  [Settings] > [All Settings] > [Fax] > [Remaining Jobs].
2. Swipe up or down or press ▲ or ▼ to scroll through the waiting jobs, and then press the job you want to cancel.
3. Press [Cancel].
4. Press [Yes] to confirm or press [No] to exit without cancelling.
5. When finished cancelling jobs, press .



Related Information

- [Send a Fax](#)
-

Fax Options

To change fax-sending settings, press the [Options] button.

Option	Description
Fax Resolution	Set the resolution for outgoing faxes. The fax quality often can be improved by changing the Fax Resolution.
2-sided Fax (For automatic 2-sided scanning models)	Set the 2-sided scanning format.
Contrast	Adjust the contrast. If your document is very light or very dark, changing the contrast may improve the fax quality.
Broadcasting	Send the same fax message to more than one fax number at the same time.
Delayed Fax	Set the time of day the delayed faxes will be sent.
Real Time TX	Send a fax immediately without waiting for the machine to retrieve the scan from its memory.
Coverpage Setup	Set the machine to automatically send a cover page that you have pre-programmed.
Overseas Mode	Set to On if you have difficulty sending faxes overseas.
Glass Scan Size	Adjust the scan area of the scanner glass to the size of the document.
Set New Default	Save your settings as the default.
Factory Reset	Restore all settings back to the factory settings.



You can save the current settings by pressing [Save as Shortcut].



Related Information

- [Send a Fax](#)

Receive a Fax

- [Receive Mode Settings](#)
- [Memory Receive \(Remote Fax\) Options](#)
- [Remote Fax Retrieval](#)

Receive Mode Settings

- [Receive Modes Overview](#)
- [Choose the Correct Receive Mode](#)
- [Set the Number of Rings Before the Machine Answers \(Ring Delay\)](#)
- [Set the F/T Ring Time \(Fast Double-ring\)](#)
- [Set Fax Detect](#)
- [Shrink Page Size of an Oversized Incoming Fax](#)
- [Set the 2-sided Printing for Received Faxes](#)
- [Set the Fax Receive Stamp](#)
- [Receive a Fax at the End of a Telephone Conversation](#)

Receive Modes Overview

Some receive modes answer automatically (Fax Only Mode and Fax/Tel Mode). You may want to change the Ring Delay before using these modes.

Fax Only Mode

([Fax] or [Fax Only] in the machine's menu)

Fax Only Mode automatically answers every call as a fax.

Fax/Tel Mode

([Fax/Tel] in the machine's menu)

Fax/Tel Mode helps you manage incoming calls, by recognising whether they are fax or voice calls and handling them in the following ways:

- Faxes will be received automatically.
- Voice calls will start the F/T ring to tell you to pick up the call. The F/T ring is a fast pseudo/double-ring made by your machine.

Manual Mode

([Manual] in the machine's menu)

Manual Mode turns off all automatic answering operations unless you are using the Distinctive Ring Receive feature.

FaxAbility is equivalent to the Distinctive Ring Receive feature in New Zealand.

To receive a fax in Manual Mode, lift the handset of the external telephone connected to the machine or press the button in the table.

Applicable Models	Alternate way to lift the handset
DocuPrint M385 z/DocuPrint M375 z/DocuPrint M375 df	 Fax and then Hook

When you hear fax tones (short repeating beeps), press the buttons in the table to receive a fax. Use the Fax Detect feature to receive faxes when you have lifted a handset on the same line as the machine.

Applicable Models	To receive the fax
DocuPrint M385 z/DocuPrint M375 z/DocuPrint M375 df	Fax Start and then Receive

External TAD Mode

([External TAD] in the machine's menu)

External TAD Mode lets an external answering device manage your incoming calls.

Incoming calls will be handled in the following ways:

- Faxes will be received automatically.
- Voice callers can record a message on the external TAD.



Related Information

- [Receive Mode Settings](#)

Choose the Correct Receive Mode

You must choose a Receive Mode depending on the external devices and telephone services you have on your line.

By default, your machine will automatically receive any faxes that are sent to it. The diagram below will help you select the correct mode.

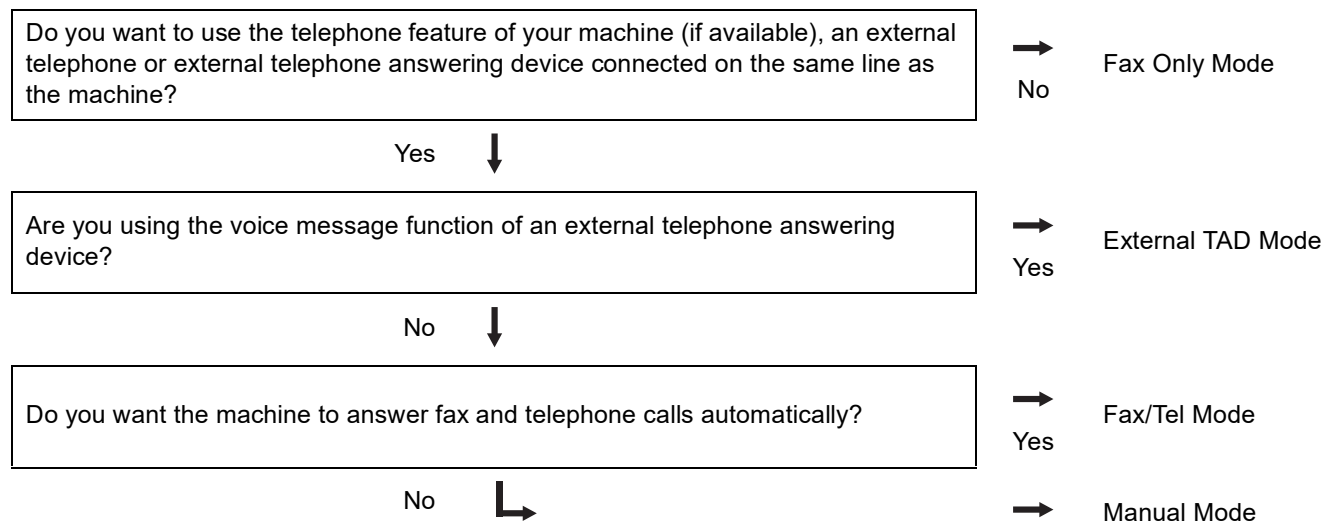

1. Press  [Settings] > [All Settings] > [Fax] > [Setup Receive] > [Receive Mode].



If you cannot change the [Receive Mode], make sure the Distinctive Ring ¹ feature is set to Off.

2. Press [Fax], [Fax/Tel], [External TAD], or [Manual].
3. Press .



Related Information

- [Receive Mode Settings](#)

Related Topics

- [Telephone and Fax Problems](#)
- [Turn Off Distinctive Ring](#)

¹ Fax Ability in New Zealand.

Set the Number of Rings Before the Machine Answers (Ring Delay)

When somebody calls your machine, you will hear the normal telephone ring sound. The number of rings is set in the Ring Delay option.

- The Ring Delay setting sets the number of times the machine rings before it answers in the Fax Only and Fax/Tel Modes.
- If you have external or extension telephones on the same line as the machine, choose the maximum number of rings.

1. Press  [Settings] > [All Settings] > [Fax] > [Setup Receive] > [Ring Delay].
2. Swipe up or down or press ▲ or ▼ to select the number of rings you want, and then press the number.



If you select [0], the machine will answer immediately and the line will not ring at all (available only for some countries).

3. Press .



Related Information

- [Receive Mode Settings](#)

Related Topics



- [Telephone and Fax Problems](#)

Set the F/T Ring Time (Fast Double-ring)

When you set the Receive Mode to Fax/Tel Mode, if the call is a fax, your machine will automatically receive it. However, if it is a voice call, the machine will sound the F/T ring (fast double-ring) for the time you set in the F/T Ring Time option. When you hear the F/T ring, it means that a voice caller is on the line.

- The F/T Ring Time feature works when you set Fax/Tel Mode as the Receive Mode.

Because the F/T ring is made by the machine, extension and external telephones will not ring; however, you can still answer the call on any telephone.

1. Press  [Settings] > [All Settings] > [Fax] > [Setup Receive] > [F/T Ring Time].
2. Press how long you want the machine to ring to alert you that you have a voice call.
3. Press .



Even if the caller hangs up during the pseudo/double-ringing, the machine will continue to ring for the set time.



Related Information

- [Receive Mode Settings](#)

Set Fax Detect



If Fax Detect is On: The machine receives a fax call automatically, even if you answer the call. When you see [Receiving] on the LCD or when you hear “chirps” through the handset you are using, just replace the handset. Your machine will do the rest.

If Fax Detect is Off: If you are at the machine and answer a fax call by lifting the handset, press the buttons in the following table to receive the fax. If you answered at an extension or external telephone, press *51 (*91 for New Zealand).

Applicable Models	To receive the fax
DocuPrint M385 z/DocuPrint M375 z/DocuPrint M375 df	Fax Start and then Receive



- If this feature is set to [On], but your machine does not connect a fax call when you lift an extension or external telephone handset, press the remote activation code *51 (*91 for New Zealand).
- If you send faxes from a computer on the same telephone line and the machine intercepts them, set Fax Detect to [Off].

1. Press  [Settings] > [All Settings] > [Fax] > [Setup Receive] > [Fax Detect].
2. Press [On] or [Off].
3. Press .



Related Information



- [Receive Mode Settings](#)

Related Topics

- [Operation from External and Extension Telephones](#)

Shrink Page Size of an Oversized Incoming Fax

If you enable the auto reduction function, the machine reduces each page of an incoming fax to fit on your paper. The machine calculates the reduction ratio by using the page size of the fax and your Paper Size setting.

1. Press  [Settings] > [All Settings] > [Fax] > [Setup Receive] > [Auto Reduction].
2. Press [On] or [Off].
3. Press .





Related Information

- [Receive Mode Settings](#)

Set the 2-sided Printing for Received Faxes

Your machine prints received faxes on both sides of the paper when [2-sided] is set to [On].

- (For Australia and New Zealand) Use A4 size paper (60 to 105 g/m²) for this function.
- (For Other countries) Use A4, Letter, Legal, Folio, Mexico Legal or India Legal size paper for this function (60 to 105 g/m²). Make sure the 2-sided tray is set to the correct paper size. If it is not, the paper may not be fed correctly, resulting in a skewed printout or a paper jam.
- When 2-sided printing is enabled, incoming faxes are automatically reduced to fit the paper in the paper tray.

1. Press  [Settings] > [All Settings] > [Fax] > [Setup Receive] > [2-sided].
2. Press [On] or [Off].
3. Press .





Related Information

- [Receive Mode Settings](#)

Set the Fax Receive Stamp

You can set the machine to print the received date and time at the top centre of each received fax page.

- Make sure you have set the current date and time on the machine.
- The received time and date will not appear when using Internet Fax.

1. Press  [Settings] > [All Settings] > [Fax] > [Setup Receive] > [Fax Rx Stamp].
2. Press [On] or [Off].
3. Press .



Related Information

- [Receive Mode Settings](#)

Receive a Fax at the End of a Telephone Conversation

If you are speaking on the telephone connected to your Fuji Xerox machine and the other party is also speaking on a telephone connected to his fax machine, at the end of the conversation, the other party can send you a fax before you both hang up.

Your machine's ADF must be empty.

1. Ask the other party to place the document in their machine and to press the Start or Send key.
2. When you hear the CNG tones (slowly repeating beeps), press [Fax Start].



If the machine is in Automatic Redial, wait until it is finished and try again.

3. Press [Receive] to receive a fax.
4. Replace the external handset.



Related Information

- [Receive Mode Settings](#)

Memory Receive (Remote Fax) Options

Use Memory Receive (Remote Fax) options to direct incoming faxes while you are away from the machine. You can use only one Memory Receive option at a time.

Memory Receive (Remote Fax) can be set to:

- Fax Forwarding
 - Fax Storage
 - PC-Fax Receive
 - Off
-
- [Forward Incoming Faxes to Another Machine](#)
 - [Store Incoming Faxes in the Machine's Memory](#)
 - [Change Memory Receive Options](#)
 - [Turn Off Memory Receive](#)
 - [Print a Fax Stored in the Machine's Memory](#)
 - [Use PC-Fax Receive to Transfer Received Faxes to Your Computer \(Windows® only\)](#)

Forward Incoming Faxes to Another Machine

Use the Fax Forwarding feature to automatically forward your incoming faxes to another machine.

1. Press  [Settings] > [All Settings] > [Fax] > [Setup Receive] > [Memory Receive].
2. Press [Fax Forward].
3. Do one of the following:
 - Press [Manual] to enter the forwarding fax number (up to 20 characters) using the LCD. Press [OK].



(DocuPrint M385 z/DocuPrint M375 z)

To forward a fax using an email address, press , enter the email address, and press [OK].

- Swipe up or down or press ▲ or ▼ to display to scroll until you find the fax number or email address where you want your faxes to be forwarded. Press the fax number or email address you want.

NOTE

- Press [Backup Print: On] or [Backup Print: Off]. If you select [Backup Print: On], the machine also prints a copy of received faxes at your machine.

4. Press .





Related Information

- [Memory Receive \(Remote Fax\) Options](#)

Store Incoming Faxes in the Machine's Memory

Use the Fax Storage feature to store incoming faxes in the machine's memory. Retrieve your stored fax messages from your fax machine when you are at another location using the Remote Retrieval commands. Your machine will print a backup copy of each stored fax.

1. Press  [Settings] > [All Settings] > [Fax] > [Setup Receive] > [Memory Receive].
2. Swipe up or down or press ▲ or ▼ to display the [Fax Storage] option, and then press [Fax Storage].
3. Press .



Related Information

- [Memory Receive \(Remote Fax\) Options](#)

Related Topics

- [How Your Fuji Xerox Machine Receives an Internet Fax \(I-Fax\)](#)

Change Memory Receive Options

If received faxes are in your machine's memory when you change the Remote Fax operations, the LCD will ask you one of the following questions:

If received faxes have been printed automatically, the LCD displays [Erase all documents?]

- Do one of the following:
 - If you press [Yes], faxes in the memory will be erased before the setting changes.
 - If you press [No], faxes in the memory will not be erased and the setting will be unchanged.

If unprinted faxes are in the machine's memory, the LCD displays [Print all faxes?]

- Do one of the following:
 - If you press [Yes], faxes in the memory will be printed before the setting changes.
 - If you press [No], faxes in the memory will not be printed and the setting will be unchanged.

If received faxes are left in the machine's memory when you change to [PC Fax Receive] from another option ([Fax Forward] or [Fax Storage]).

- Press [<USB>] or the name of the computer if you are on a network, and then press [OK].

The LCD displays:

[Send Fax to PC?]

- If you press [Yes], faxes in the memory will be sent to your computer before the setting changes. You will be asked if you want to turn on Backup Print.
- If you press [No], faxes in the memory will not be erased and the setting will be unchanged.



Related Information

- [Memory Receive \(Remote Fax\) Options](#)

Turn Off Memory Receive

Turn off Memory Receive if you do not want the machine to save or transfer incoming faxes.

1. Press  [Settings] > [All Settings] > [Fax] > [Setup Receive] > [Memory Receive].
2. Press [Off].



The LCD displays options if there are received faxes still in your machine's memory.

3. Press .



Related Information

- [Memory Receive \(Remote Fax\) Options](#)

Print a Fax Stored in the Machine's Memory

If you select [Fax Storage], you can still print a fax from the memory when you are at your machine.

1. Press  [Settings] > [All Settings] > [Fax] > [Print Document].
2. Press [Yes].



Related Information

- [Memory Receive \(Remote Fax\) Options](#)

Use PC-Fax Receive to Transfer Received Faxes to Your Computer (Windows® only)

Turn on the PC-Fax Receive feature, automatically store incoming faxes to your machine's memory, and then send them to your computer. Use your computer to view and store these faxes.

To transfer the received faxes to your computer you must have the PC-FAX Receiving software running on your computer.

Even if you have turned off your computer (at night or on the weekend, for example), your machine will receive and store your faxes in its memory.

When you start your computer and the PC-FAX Receiving software runs, your machine transfers your faxes to your computer automatically.

If you selected [Backup Print: On], the machine will also print the fax.

1. Press  [Settings] > [All Settings] > [Fax] > [Setup Receive] > [PC Fax Receive].
2. Press [OK], and then following the LCD instruction.



- PC-Fax Receive is not available for the Mac operating systems.
- If you get an error message and the machine cannot print the faxes in the memory, you can use this setting to transfer your faxes to your computer.

3. Press [<USB>] or the name of the computer you want to receive faxes if you are on a network, and then press [OK].
4. Press [Backup Print: On] or [Backup Print: Off].
5. Press .



Related Information

- [Memory Receive \(Remote Fax\) Options](#)

Related Topics

- [Transfer Faxes to Your Computer](#)
- [Receive Faxes Using PC-FAX Receive \(Windows®\)](#)

Remote Fax Retrieval

Use Remote Retrieval to call your machine from any touch-tone telephone or fax machine, and use a remote access code and remote commands to retrieve fax messages.

- [Set a Remote Access Code](#)
- [Use Your Remote Access Code](#)
- [Remote Retrieval Commands](#)
- [Forward Faxes Remotely](#)
- [Change the Fax Forwarding Number](#)

Set a Remote Access Code

Set a Remote Access Code to access and control your Fuji Xerox machine even when you are away from it.

Before you can use the remote access and retrieval features, you must set up your own code. The factory default code is the inactive code (---*).

1. Press  [Settings] > [All Settings] > [Fax] > [Remote Access].
2. Enter a three-digit code using the numbers [0] to [9], [*] or [#] using the LCD (the preset '*' cannot be changed), and then press [OK].



- DO NOT use the same code used for your Remote Activation Code (*51) (*91 for New Zealand) or Remote Deactivation Code (#51) (#91 for New Zealand).
- To make your code inactive, press and hold  to restore the inactive setting (---*), and then press [OK].

3. Press .



Related Information

- [Remote Fax Retrieval](#)

Use Your Remote Access Code

1. Dial your fax number from a telephone or another fax machine using touch tone.
2. When your machine answers, immediately enter your Remote Access Code (three digits followed by *).
3. The machine signals if it has received messages:
 - One long beep -- Fax messages
 - No beeps -- No messages
4. When the machine gives two short beeps, enter a command.
 - The machine will hang up if you wait longer than 30 seconds to enter a command.
 - The machine will beep three times if you enter an invalid command.
5. Press 9 0 to reset the machine when you are finished.
6. Hang up.
 - If your machine is set to Manual mode and you want to use the remote retrieval features, wait for about 100 seconds after it starts ringing, and then enter the remote access code within 30 seconds.
 - This function may not be available in some countries or supported by your local telephone company.



Related Information

- [Remote Fax Retrieval](#)

Remote Retrieval Commands

Use the Remote Commands in this table to access fax commands and options when you are away from your Fuji Xerox machine. When you call the machine and enter your remote access code (three digits followed by *), the system will sound two short beeps and you must enter a Remote Command (column 1), followed by one of the options (column 2) for that command.

Remote commands	Options	Operation details
95	Change the Fax Forwarding, or Fax Storage settings	
	1 OFF	You can select <i>Off</i> after you retrieve or erase all your messages.
	2 Fax Forwarding	One long beep means the change is accepted. If you hear three short beeps, you cannot make a change because something has not been set up (for example, a Fax Forwarding number has not been registered). You can register your Fax Forwarding number by entering 4. After you register the number, Fax Forwarding will work.
	4 Fax Forwarding number	
	6 Fax Storage	
96	Retrieve a fax	
	2 Retrieve all faxes	Enter the fax number of a remote fax machine to receive stored fax messages.
	3 Erase faxes from memory	If you hear one long beep, fax messages have been erased from memory.
97	Check the receiving status	
	1 Fax	Check whether your machine has received any faxes. If yes, you will hear one long beep. If not, you will hear three short beeps.
98	Change the Receive Mode	
	1 External TAD	One long beep means the change has been accepted.
	2 Fax/Tel	
	3 Fax Only	
90	Exit	Press 9 0 to stop remote retrieval. Wait for the long beep, then hang up.



Related Information

- [Remote Fax Retrieval](#)

Forward Faxes Remotely

Call your Fuji Xerox machine from any touch-tone telephone or fax machine to forward incoming faxes to another machine.

You must turn on Fax Storage to use this feature.

1. Dial your fax number.
2. When your machine answers, enter your Remote Access Code (three digits followed by *). If you hear one long beep, you have messages.
3. When you hear two short beeps, press 9 6 2.
4. Wait for the long beep, and then use the dial pad to enter the number of the remote fax machine where you want your fax messages sent, followed by # # (up to 20 digits).



You cannot use * and # as dial numbers. However, press # if you want to create a pause.

5. Hang up after you hear your machine beep. Your machine will call the other fax machine, which will then print your fax messages.



Related Information

- [Remote Fax Retrieval](#)

Change the Fax Forwarding Number

You can change your fax forwarding number from another touch-tone telephone or fax machine.

1. Dial your fax number.
2. When your machine answers, enter your Remote Access Code (three digits followed by *). If you hear one long beep, you have messages.
3. When you hear two short beeps, press 9 5 4.
4. Wait for the long beep, enter the new number (up to 20 digits) of the remote fax machine you want your fax messages forwarded to using the dial pad, then enter # #.

You will hear one long beep.



You cannot use * and # as dial numbers. However, press # if you want to create a pause.

5. When you hear two short beeps, press 9 0 to stop Remote Access when you have finished.
6. Hang up after you hear your machine beep.



Related Information

- [Remote Fax Retrieval](#)
-

Voice Operations and Fax Numbers

- [Voice Operations](#)
- [Store Fax Numbers](#)
- [Set up Groups for Broadcasting](#)
- [Combine Address Book Numbers](#)

Voice Operations

- [Send Tone Signals](#)
- [Pick up a Voice Call in Fax/Tel Receive Mode](#)

Send Tone Signals

If you have a Pulse dialling service, but must send Tone signals (for example, for telephone banking), follow these steps. If you have a Touch Tone service, you will not need this feature to send tone signals. (This feature is not available in New Zealand.)

1. Press  [Fax].
2. Press [Hook].
3. Press # on the machine's LCD.
Any digits dialled after this will send tone signals.

When you are finished with the call, the machine will return to the Pulse dialling service.



Related Information

- [Voice Operations](#)

Pick up a Voice Call in Fax/Tel Receive Mode

When the machine is in Fax/Tel mode, it will use the F/T Ring (fast double-ring) to alert you to pick up a voice call. If you are at the machine, lift the external telephone's handset, and then press the button in the following table to answer:

Applicable Models	To pick up voice call
DocuPrint M385 z/DocuPrint M375 z/DocuPrint M375 df	Pickup

If you are at an extension telephone, lift the handset during the F/T Ring, and then press #51 (#91 for New Zealand) between the fast double-rings. If no one is on the line, or if someone wants to send you a fax, send the call back to the machine by pressing *51 (*91 for New Zealand).



Related Information

- [Voice Operations](#)

Store Fax Numbers

- [Store Address Book Numbers](#)
- [Change or Delete Address Book Names or Numbers](#)
- [How to Enter Text on Your Fuji Xerox Machine](#)

Store Address Book Numbers

1. Press  [Fax] > [Address Book].
2. Do the following steps:
 - a. Press [Edit].
 - b. Press [Add New Address].
 - c. Press [Name].
 - d. Enter the name using the LCD (up to 16 characters), and then press [OK].
 - e. Press [Address].
 - f. Enter the fax or telephone number using the LCD (up to 20 digits), and then press [OK].



-
- (DocuPrint M385 z/DocuPrint M375 z)

To store an email address to use with Internet Fax or Scan to Email server, press  and enter the email address and press [OK].

- g. Press [OK].

To store another Address Book number, repeat these steps.

3. Press .



Related Information

- [Store Fax Numbers](#)
 - [Store Address Book Numbers from Outgoing Calls](#)
-

Store Address Book Numbers from Outgoing Calls

You can store Address Book numbers from the Outgoing Call history.

1. Press  [Fax] > [Call History] > [Outgoing Call].
2. Swipe up or down or press ▲ or ▼ to display the number you want, and then press it.
3. Press [Edit] > [Add to Address Book] > [Name].



To delete the number, press [Edit] > [Delete]. Press [Yes] to confirm.

4. Enter the name using the LCD (up to 16 characters).
5. Press [OK].
6. Press [OK] to confirm the fax or telephone number you want to store.
7. Press .



Related Information

- [Store Address Book Numbers](#)
-

Change or Delete Address Book Names or Numbers

1. Press  [Fax] > [Address Book] > [Edit].
2. Do one of the following:
 - Press [Change] to edit the names or fax or telephone numbers. Swipe up or down or press ▲ or ▼ to display the number you want to change, and then press it.
 - To change the name, press [Name]. Enter the new name (up to 16 characters) using the LCD, and then press [OK].
 - To change the fax or telephone number, press [Address]. Enter the new fax or telephone number (up to 20 digits) using the LCD, and then press [OK].Press [OK] to finish.



How to enter text:

To change a character, press ◀ or ▶ to position the cursor to highlight the incorrect character, and then press



Enter the new character.

- To delete numbers, press [Delete].
 - Select the fax or telephone numbers you want to delete by pressing them to display a red check mark, and then press [OK].
3. Press .



Related Information

- [Store Fax Numbers](#)

Set up Groups for Broadcasting

A Group, which can be stored in the Address Book (One Touch Dial or Speed Dial in some models) allows you to send the same fax message to many fax numbers.

First, you must store each fax number in the Address Book. Then you can include them as numbers in the Group. Each Group uses up an Address Book (a One Touch Dial, or a Speed Dial in some models) number.

Applicable Models	Maximum number of Group	Maximum numbers in a large Group
DocuPrint M385 z/DocuPrint M375 z/DocuPrint M375 df	20 groups	299 numbers

1. Press  [Fax] > [Address Book].
2. Do the following steps:
 - a. Press [Edit] > [Setup Groups] > [Name].
 - b. Enter the Group name (up to 16 characters) using the LCD, and then press [OK].
 - c. Press [Add/Delete].
 - d. Add Address Book numbers to the Group by pressing them to display a red checkmark, and then press [OK].
 - e. Read and confirm the displayed list of names and numbers you have chosen, and then press [OK] to save your Group.

To store another Group for broadcasting, repeat these steps.

3. Press .



Related Information

- [Voice Operations and Fax Numbers](#)
- [Change a Group Name](#)
- [Delete a Group](#)
- [Add or Delete Group Members](#)

Change a Group Name

1. Press  [Fax] > [Address Book] > [Edit] > [Change].
2. Swipe up or down or press ▲ or ▼ to display the Group you want, and then press the Group name.
3. Press [Name].
4. Enter the new Group name (up to 16 characters) using the LCD, and then press [OK].



How to change the stored name:

To change a character, press ◀ or ▶ to position the cursor to highlight the incorrect character, and then press



Enter the new character.



5. Press [OK].
6. Press .



Related Information

- [Set up Groups for Broadcasting](#)

Delete a Group



1. Press  [Fax] > [Address Book] > [Edit] > [Delete].
2. Swipe up or down or press ▲ or ▼ to display the Group you want, and then press the Group name.
3. Press [OK].
4. Press .



Related Information

- [Set up Groups for Broadcasting](#)

Add or Delete Group Members

1. Press  [Fax] > [Address Book] > [Edit] > [Change].
2. Swipe up or down or press ▲ or ▼ to display the Group you want, and then press the Group name.
3. Swipe up or down or press ▲ or ▼ to display the [Add/Delete] option, and then press [Add/Delete].
4. Swipe up or down or press ▲ or ▼ to display the number you want to add or delete.
5. Do the following for each number you want to change:
 - To add a number to the Group, press the check box of the number to add a check mark.
 - To delete a number from the Group, press the check box of the number to remove the check mark.
6. Press [OK].
7. Press [OK].
8. Press .



Related Information

- [Set up Groups for Broadcasting](#)

Combine Address Book Numbers

Sometimes you may want to choose from several long-distance carriers when you send a fax. Rates may vary depending on the time and destination. To take advantage of low rates, you can store the access codes of long-distance carriers and credit card numbers as Address Book numbers.

You can store these long dialling sequences by dividing them and setting them up as separate Address Book numbers in any combination. You can even include manual dialling using the dial pad.

For example: You might have stored '01632' and '960555' in your machine as shown in the following table.

Applicable Models	'01632' stored in	'960555' stored in
DocuPrint M385 z/DocuPrint M375 z/DocuPrint M375 df	Address Book: Fuji Xerox 1	Address Book: Fuji Xerox 2

You can use them both to dial '01632-960555' by using the following procedure.

1. Press  [Fax] > [Address Book].
2. Swipe up or down or press ▲ or ▼ to display the number of Fuji Xerox 1.
3. Press the number.
4. Press [Apply].
5. Press [Address Book].
6. Press [OK].
7. Swipe up or down or press ▲ or ▼ to display the number of Fuji Xerox 2.
8. Press the number.
9. Press [Apply].
10. Press [Fax Start].

The machine will dial '01632-960555'.

To temporarily change a number, you can substitute part of the number by pressing it using the LCD. For example, to change the number to '01632-960556', you could enter the number (Fuji Xerox 1: 01632) using Address Book, press [Apply], and then press 960556 using the LCD.



If you must wait for another dial tone or signal at any point in the dialling sequence, create a pause in the number by pressing [Pause].



Related Information

- [Voice Operations and Fax Numbers](#)

Telephone Services and External Devices

- [Distinctive Ring](#)
- [FaxAbility](#)
- [External TAD \(Telephone Answering Device\)](#)
- [External and Extension Telephones](#)
- [Multi-line Connections \(PABX\)](#)

Distinctive Ring



This feature is available only for some countries.

For Australia

Distinctive Ring is a function of your Fuji Xerox machine that allows a person with one line to receive fax and voice calls through two different phone numbers on that one line. Fuji Xerox uses the term “Distinctive Ring”, but telephone companies market the service under a variety of names. This service establishes a second telephone number on the same line as your existing telephone number, and each number has its own ring pattern. Typically, the original number rings with the standard ring pattern and is used for receiving voice calls, and the second number rings with a different ring pattern and is used for receiving faxes. Only one call can be answered (or made) at any one time and while this call is in progress, incoming calls to either number will be presented with a busy tone.



- Contact your Telephone Service Provider to determine Distinctive Ring availability and any other related details.
- After you have set the Distinctive Ring feature to On, the receive mode is set to [Manual] automatically. Your Distinctive Ring Number does not allow Voice calls - only Faxes. You can not change the receive mode from [Manual] mode while the Distinctive Ring is set to on.

How does your telephone company’s ‘Distinctive Ring’ service work?

Using “Distinctive Ring” service of your telephone company is the most efficient way to receive both fax and telephone calls on the same line. When the voice call comes in, all phones (extension and external) and the fax machine will ring to alert you to pick it up. If a fax call comes in, the fax machine will answer automatically without ringing, whereas the extension and external phones will ring twice with a Distinctive Ring pattern. It is also a more efficient way of operating a Fax machine with an extension phone as you do not have to use the remote activation codes. It gives you two independent numbers without the higher cost of a second line.

Flowchart Sequence of Incoming call

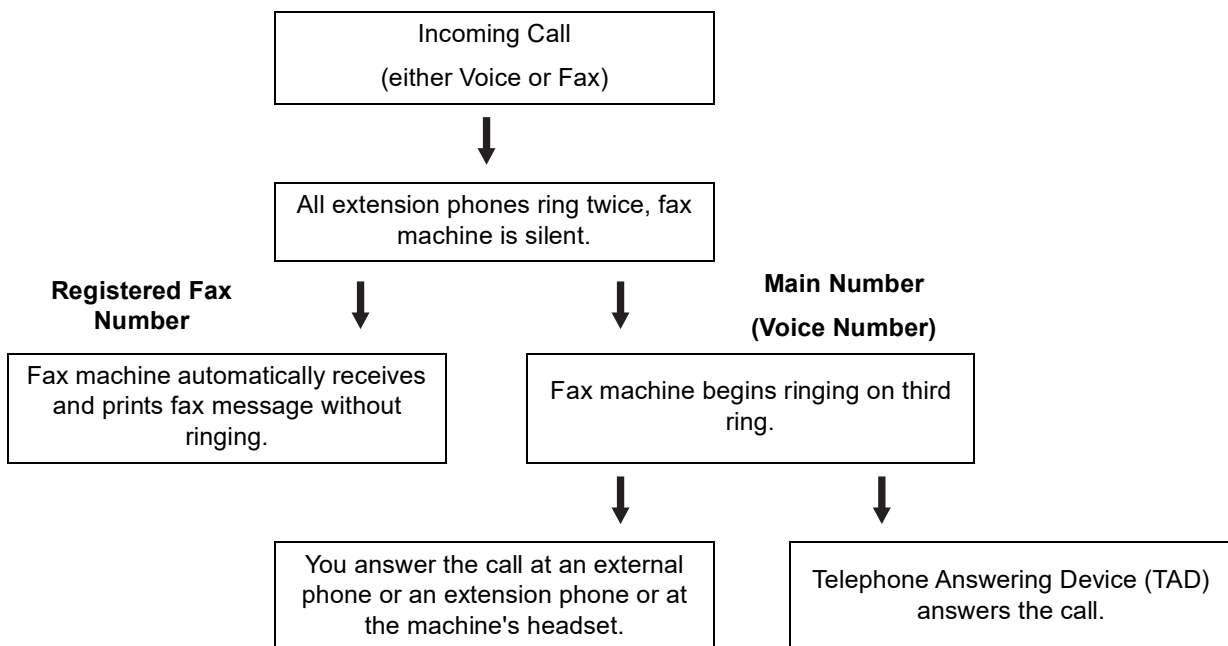

What does Fuji Xerox’s ‘Distinctive Ring’ do?

The Fuji Xerox machine has a Distinctive Ring feature that allows you to use your machine to take full advantage of the telephone company’s Distinctive Ring service. The new telephone number on your line can just receive faxes.

For Singapore and Hong Kong

This machine feature lets you use the Distinctive Ring subscriber service offered by some telephone companies, which allows you to have several telephone numbers on one phone line. Each phone number has its own Distinctive Ring pattern, so you will know which phone number is ringing. This is one way you can have a separate phone number for your machine.

Your machine has a Distinctive Ring function, allowing you to dedicate one phone number just for receiving faxes. You will need to set Distinctive Ring to On.



- You can switch it off temporarily, then turn it back on. When you get a new fax number, make sure you reset this function.
 - The machine will answer only calls to the Distinctive Ring number.
-



Related Information

- [Telephone Services and External Devices](#)
 - [Turn On Distinctive Ring](#)
 - [Turn Off Distinctive Ring](#)
-

Turn On Distinctive Ring

For Australia



After you set the Distinctive Ring feature to [On], the receive mode is automatically set to [Manual]. Your Distinctive Ring Number does not allow Voice calls - only Faxes. You cannot change the receive mode to another mode while the Distinctive Ring is set to on.

For Singapore and Hong Kong

After you set the Distinctive Ring feature to [On], the receive mode is automatically set to [Manual]. Unless you have a TAD or Voice Mail set up on the Distinctive Ring number, Manual mode means you must answer all the calls yourself. You cannot change the receive mode to another mode while the Distinctive Ring is set to on.



When Distinctive Ring is on, the LCD will display [D/R] as the Receive Mode.



1. Press  [Settings] > [All Settings] > [Fax] > [Miscellaneous] > [Distinctive].
2. Press [On].
3. Press .



Related Information

- [Distinctive Ring](#)

Turn Off Distinctive Ring

1. Press  [Settings] > [All Settings] > [Fax] > [Miscellaneous] > [Distinctive].
2. Press [Off].
3. Press .

If you turn off Distinctive Ring, the machine will stay in Manual Mode. You must set the Receive Mode again.



Related Information

- [Distinctive Ring](#)

Related Topics

- [Choose the Correct Receive Mode](#)

FaxAbility

This feature is available only in New Zealand.

FaxAbility is a service offered by Telecom that allows you to have an additional number on one phone line, with its own distinctive ring pattern. This way, when you get an incoming call, you can identify the number being called by its ring.

How Will the Fax Machine Treat All Other Numbers?

FaxAbility mode ensures that the machine will answer calls to the FaxAbility (secondary) number. When a call comes in to your main number, all the phones will ring. You can set an external answering device (TAD) to answer calls on the other number(s). (See the chart below.)

What is the Advantage of Using the FaxAbility Function?

Using FaxAbility is the most efficient way to receive both fax and telephone calls on the same line. It is much easier for your callers who dial manually. The fax machine will answer with receiving tones so they will not have to press an activation code. And the people who call to talk on your main number will not have to talk to your fax machine. Basically, it gives you two independent numbers without the higher cost of a second line.

How Does FaxAbility Work?

For example, Your telephone number will have the standard ring pattern of long, long tone, while the new number will have a ring pattern of long, silence, long. When FaxAbility is On, you will not hear the first ring of all incoming calls on the fax machine. Extension phones will ring as usual. If the fax machine recognises the ring pattern, all ringing will stop and the fax machine will answer and automatically receive the fax message. Otherwise, you will hear the extension phones and the fax machine continue to ring. The fax machine always listens to the ring pattern before it answers, so do not pick up the phone during that time. You will quickly learn to recognise the ring pattern for faxes, so you will not be tempted to answer that number. Either you or a telephone answering device can answer the main number(s).

Flowchart Sequence of Incoming call

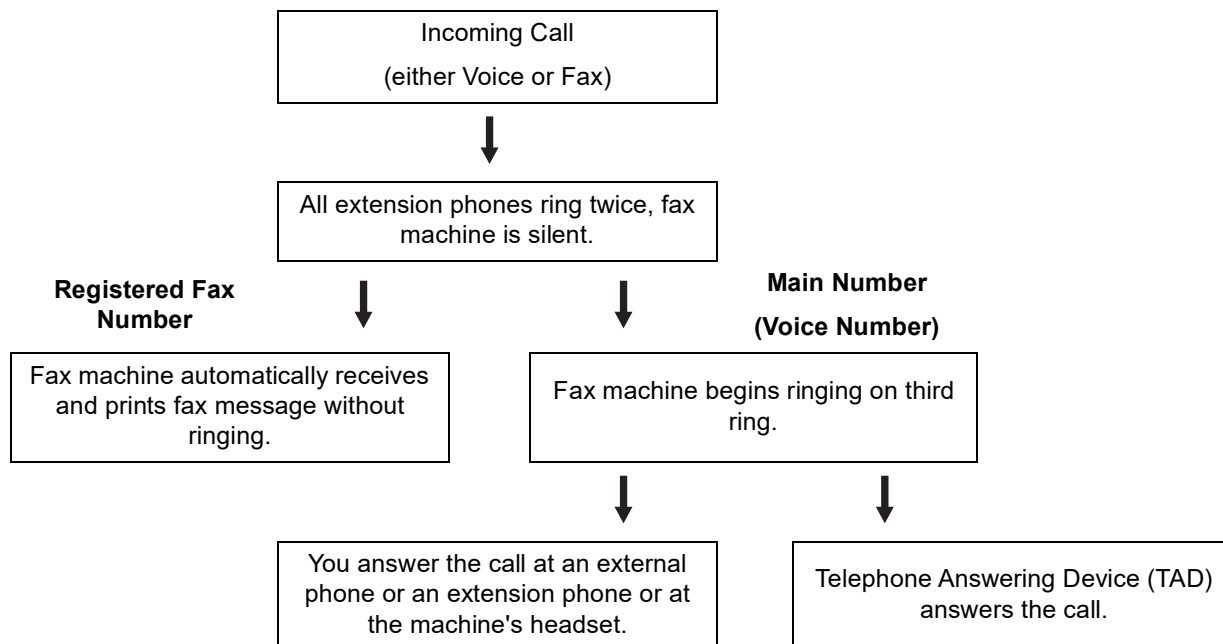

After you have set the FaxAbility feature to on, the receive mode is set to [Manual] automatically. Unless you have a TAD or Voice Mail set up on the FaxAbility number, Manual mode means you must answer all the call yourself. You can not change the receive mode to the other mode while the FaxAbility is set to on. When FaxAbility is on, the LCD will show [D/R] as the Receive Mode.



Related Information

- [Telephone Services and External Devices](#)
- [Turn FaxAbility On or Off](#)

Turn FaxAbility On or Off

This feature is available only in New Zealand.

The FaxAbility function is designed to accommodate the FaxAbility service provided by Telecom.

Call Waiting beeps caused by incoming calls on your main number can affect fax transmissions. If you have FaxAbility Service but don't have Call Waiting, you need do nothing at this stage. If you do have Call Waiting as well as FaxAbility, set the Call Waiting menu option to On.

1. Press  [Settings] > [All Settings] > [Fax] > [Miscellaneous] > [FaxAbility].
2. Press [On] or [Off].



- If you have FaxAbility service, select [On].
- To turn off FaxAbility, select [Off].

3. Press [Call Waiting].
4. Press [On] or [Off].



- If you have Call Waiting service, select [On] to avoid the trouble caused by Call Waiting.
- To turn off Call Waiting, select [Off].

5. Press .



Related Information

- [FaxAbility](#)

External TAD (Telephone Answering Device)

You can connect an external Telephone Answering Device (TAD) to the same line as your machine. When the TAD answers a call, your machine will “listen” for the CNG (fax calling) tones sent by a sending fax machine. If it hears them it will take over the call and receive the fax. If it does not hear them, it will let your TAD take a voice message and the LCD will show [Telephone].

The external TAD must answer within four rings (we recommend setting it to two rings). This is because your machine cannot hear the CNG tones until the external TAD has picked up the call. The sending machine will send CNG tones for only eight to ten seconds longer. We do not recommend using the toll saver feature on your external TAD if it needs more than four rings to activate it.

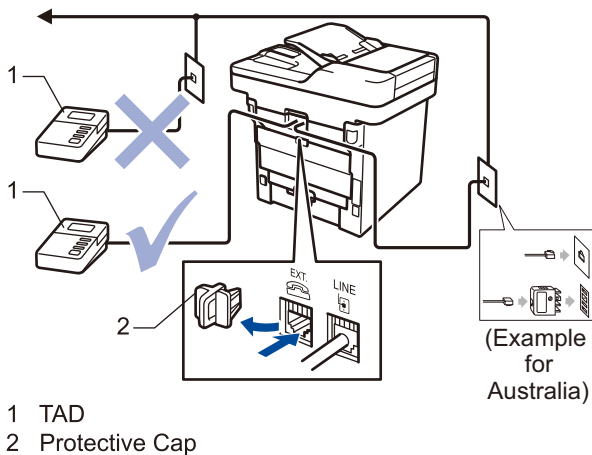

IMPORTANT

DO NOT connect a TAD elsewhere on the same telephone line.



If you have problems receiving faxes, reduce the Ring Delay setting on your external TAD.



Related Information

- [Telephone Services and External Devices](#)
 - [Connect an External TAD](#)
 - [Record an Outgoing Message \(OGM\) on the External TAD](#)

Connect an External TAD

1. Set your external TAD to one or two rings. (The machine's Ring Delay setting does not apply.)
2. Record an outgoing message on your external TAD.
3. Set the TAD to answer calls.
4. Set the Receive Mode on your machine to [External TAD].



Related Information

- [External TAD \(Telephone Answering Device\)](#)

Record an Outgoing Message (OGM) on the External TAD

1. Record 5 seconds of silence at the beginning of your message. This allows your machine time to listen for fax tones.
2. Limit your speaking to 20 seconds.
3. End your 20-second message by giving your Remote Activation Code for people sending manual faxes. For example: "After the beep, leave a message or press *51 and Start to send a fax."

NOTE

We recommend beginning your OGM with an initial 5 second silence because the machine cannot hear fax tones over a loud voice. You may try leaving out this pause, but if your machine has trouble receiving faxes, then you should re-record the OGM to include it.



Related Information

- [External TAD \(Telephone Answering Device\)](#)

External and Extension Telephones

- [Connect an External or Extension Telephone](#)
- [Operation from External and Extension Telephones](#)
- [Use the Remote Codes](#)

Connect an External or Extension Telephone

You can connect a separate telephone to your machine as shown in the diagram below.

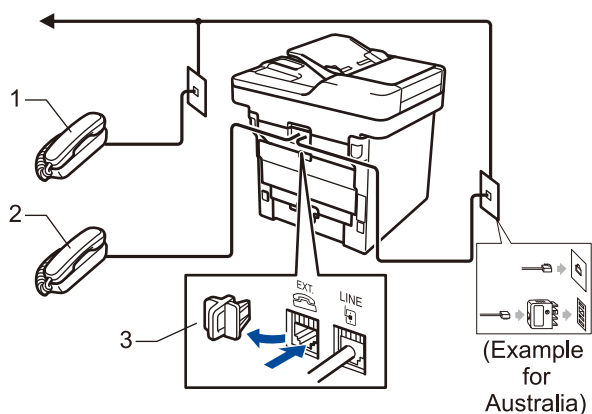

- 1 Extension telephone
- 2 External telephone
- 3 Protective Cap



Related Information

- [External and Extension Telephones](#)

Operation from External and Extension Telephones

If you answer a fax call at an extension or an external telephone, you can make your machine take the call by using the Remote Activation Code. When you press the Remote Activation Code ***51** (***91** for New Zealand), the machine starts to receive the fax.

If the machine answers a voice call and pseudo/double-rings for you to take over, you can take the call at an extension telephone by pressing the Remote Deactivation Code **#51** (**#91** for New Zealand).

If you answer a call and no one is on the line:

You should assume that you're receiving a manual fax.

Press ***51** (***91** for New Zealand) and wait for the chirp or until the LCD displays [Receiving], and then hang up.



You can also use the Fax Detect feature to make your machine automatically take the call.



Related Information

- [External and Extension Telephones](#)

Related Topics

- [Set Fax Detect](#)

Use the Remote Codes

Remote Activation Code

If you answer a fax call on an extension or external telephone, you can tell your machine to receive it by pressing the Remote Activation Code *51 (*91 for New Zealand). Wait for the chirping sounds, and then replace the handset.

If you answer a fax call at the external telephone, you can make the machine receive the fax by pressing the buttons in the following table:

Applicable Models	To make the machine receive the fax
DocuPrint M385 z/DocuPrint M375 z/DocuPrint M375 df	Fax Start and then Receive





Related Information

- [External and Extension Telephones](#)
- [Change the Remote Codes](#)

Change the Remote Codes

The preset Remote Activation Code is *51 (*91 for New Zealand). The preset Remote Deactivation Code is #51 (#91 for New Zealand). If you are always disconnected when accessing your External TAD remotely, try changing the three-digit remote codes using the numbers 0-9, *, #.

1. Press  [Settings] > [All Settings] > [Fax] > [Setup Receive] > [Remote Codes].
2. Do one of the following:
 - To change the Remote Activation Code, press [Act.Code]. Enter the new code, and then press [OK].
 - To change the Remote Deactivation Code, press [Deact.Code]. Enter the new code, and then press [OK].
 - If you do not want to change the Codes, go to the next step.
 - To turn off (or turn on) the Remote Codes, press [Remote Codes], and then press [Off] (or [On]).
3. Press .



Related Information

- [Use the Remote Codes](#)

Multi-line Connections (PABX)

Most offices use a central telephone system.

Fuji Xerox recommends that all our machines be connected to a discreet (dedicated) line. Although a particular PABX may appear to work with a particular model of fax machine, we cannot guarantee that the unit will operate correctly.

While it is often relatively simple to connect a fax machine to a PABX, (Private Automatic Branch Exchange), we suggest that you contact the company that installed your telephone system and ask them to connect the fax machine for you.

Fuji Xerox does not recommend the use of a PABX line. PABX limitations in general can cause some functions of the fax machine not to work correctly.



Related Information

- [Telephone Services and External Devices](#)
-

Fax Reports

The Transmission Verification Report and the Fax Journal are available to confirm the results of fax transmission.



- [Print a Transmission Verification Report](#)
- [Print a Fax Journal](#)

Print a Transmission Verification Report

You can use the Transmission Verification Report as proof that you sent a fax. This report lists the receiving party's name or fax number, the time and date of transmission, duration of transmission, number of pages sent, and whether or not the transmission was successful.

There are several settings available for the Transmission Verification Report:

On	Prints a report after every fax you send.
On+Image	Prints a report after every fax you send. A portion of the fax's first page appears on the report.
Off	Prints a report if your fax is unsuccessful due to a transmission error. <i>Off</i> is the factory setting.
Off+Image	Prints a report if your fax is unsuccessful due to a transmission error. A portion of the fax's first page appears on the report.
No Report	Your Fuji Xerox machine does not print any reports after sending faxes.



1. Press  [Settings] > [All Settings] > [Fax] > [Report Setting] > [XMIT Report].
 2. Swipe up or down or press ▲ or ▼ to select the option you want, and then press it.
If you select [On+Image] or [Off+Image], the image will not appear on the Transmission Verification Report if Real Time Transmission is set to [On].
 3. Press .
- If the transmission is successful, OK appears next to RESULT on the Transmission Verification Report. If the transmission is not successful, NG appears next to RESULT.

Related Information

- [Fax Reports](#)

Print a Fax Journal

You can set the machine to print a Fax Journal at specific intervals (every 50 faxes, 6, 12 or 24 hours, 2 or 7 days).

1. Press  [Settings] > [All Settings] > [Fax] > [Report Setting] > [Journal Period] > [Journal Period].
2. Swipe up or down or press ▲ or ▼ to select an interval, and then press it.
 - Every 6, 12, 24 hours, 2 or 7 days
The machine will print the report at the selected time and then erase all reception and transmission log data from its memory. If the machine's memory becomes full with 200 log data before the time you selected has passed, the machine will print the Journal early and then erase all jobs from the memory. If you want an extra report before it is due to print, you can print it without erasing the log data from the memory.
 - Every 50 Faxes
The machine will print the Journal when the machine has stored 50 reception and transmission log data.
3. If you selected every 6, 12, 24 hours, 2 or 7 days, press [Time] and enter the time to start printing (in 24-hour format) using the LCD, and then press [OK]. (For example: enter 19:45 for 7:45 PM.)
4. If you selected [Every 7 Days], press [Day].
5. Swipe up or down or press ▲ or ▼ to display the [Every Monday], [Every Tuesday], [Every Wednesday], [Every Thursday], [Every Friday], [Every Saturday] or [Every Sunday] option, and then press the first day of the 7-day countdown.
6. Press .



Related Information

- [Fax Reports](#)

PC-FAX

- [PC-FAX for Windows®](#)
- [PC-FAX for Mac](#)

PC-FAX for Windows®

- [PC-FAX Overview \(Windows®\)](#)
- [Send a Fax Using PC-FAX \(Windows®\)](#)
- [Receive Faxes on Your Computer \(Windows®\)](#)

PC-FAX Overview (Windows®)

Reduce paper consumption and save time by using Fuji Xerox's PC-FAX software to send faxes directly from your machine.

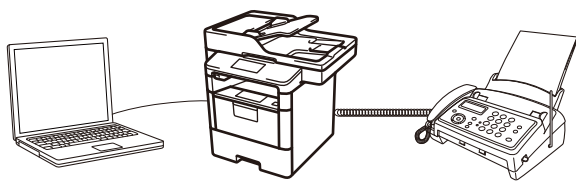

- [Configure PC-FAX \(Windows®\)](#)
- [Configure your PC-Fax Address Book \(Windows®\)](#)

Configure PC-FAX (Windows®)

Before sending faxes using PC-FAX, personalise the send options in each tab of the **PC-FAX Setup** dialog box.

1. Do one of the following:

- Windows® 7

Click  (**Start**) > **All Programs** > **Fuji Xerox** > **Fuji Xerox Utilities**.

Click the drop-down list and select your model name (if not already selected). Click **PC-FAX** in the left navigation bar, and then click **Setup Sending**.

- Windows® 8 and Windows® 10

Launch  (**Fuji Xerox Utilities**), and then click the drop-down list and select your model name (if not already selected). Click **PC-FAX** in the left navigation bar, and then click **Setup Sending**.

The **PC-FAX Setup** dialog box appears.

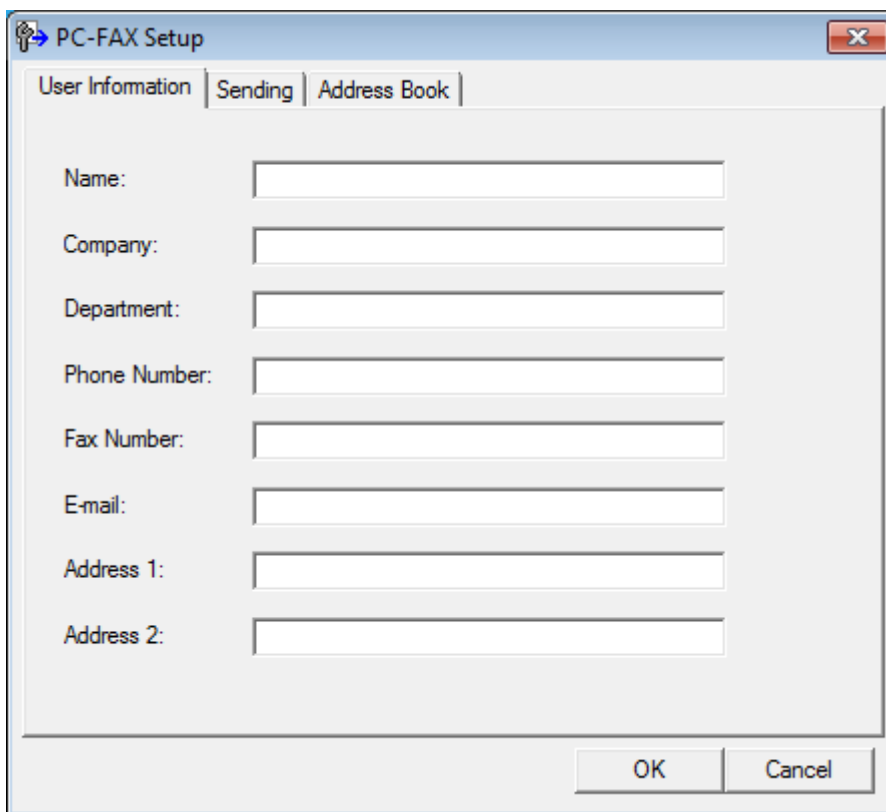

2. Do one of the following:

- Click the **User Information** tab, and then type your user information in the fields.



Each Microsoft® account can have its own customised **User Information** screen for custom fax headers and cover pages.

- Click the **Sending** tab, and then type the number needed to access an outside line (if needed) in the **Outside line access** field. Select the **Include header** check box to include the header information.
- Click the **Address Book** tab, and then select the address book you want to use for PC-FAX from the **Select Address Book** drop-down list.

3. Click **OK**.



Related Information

- [PC-FAX Overview \(Windows®\)](#)

Related Topics

- [Transfer Faxes to Your Computer](#)
-

Configure your PC-Fax Address Book (Windows®)

Add, edit and delete members and groups to personalise your Fuji Xerox **Address Book**.

- [Add a Member to your PC-FAX Address Book \(Windows®\)](#)
- [Create a Group in your PC-FAX Address Book \(Windows®\)](#)
- [Edit Member or Group Information in your PC-FAX Address Book \(Windows®\)](#)
- [Delete a Member or Group in your PC-FAX Address Book \(Windows®\)](#)
- [Export your PC-FAX Address Book \(Windows®\)](#)
- [Import Information to your PC-FAX Address Book \(Windows®\)](#)

Add a Member to your PC-FAX Address Book (Windows®)

Add new people and their fax information to the PC-Fax Address Book if you want to send a fax using Fuji Xerox PC-Fax software.

1. Do one of the following:

- Windows® 7

Click  (**Start**) > **All Programs** > **Fuji Xerox** > **Fuji Xerox Utilities**.

Click the drop-down list and select your model name (if not already selected). Click **PC-FAX** in the left navigation bar, and then click **Address Book (Send)**.

- Windows® 8 and Windows® 10

Launch  (**Fuji Xerox Utilities**), and then click the drop-down list and select your model name (if not already selected). Click **PC-FAX** in the left navigation bar, and then click **Address Book (Send)**.

The **Address Book** dialog box appears.

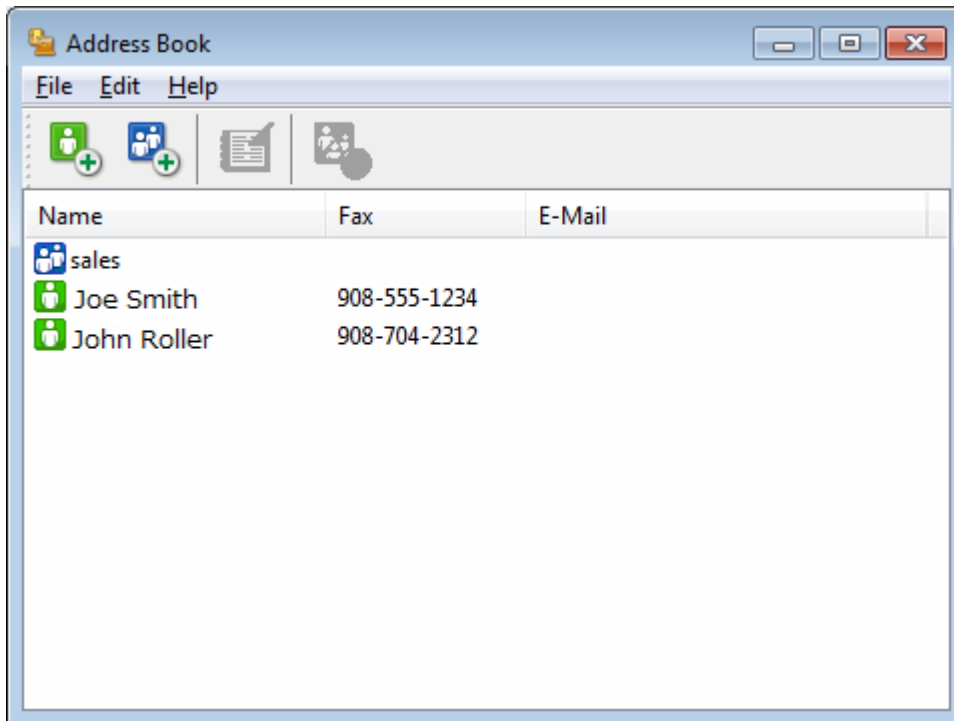

2. Click .

The **Address Book Member Setup** dialog box appears.

Address Book Member Setup

Name: Title:

Company:

Department: Job Title:

Street Address:

City: State/Province:

Zip Code/Post Code: Country/Region:

Business Phone: Home Phone:

Fax: Mobile Phone:

E-Mail:

OK Cancel

3. Type the member's information in the corresponding fields. Only the **Name** field is required.
4. Click **OK**.



Related Information

- [Configure your PC-Fax Address Book \(Windows®\)](#)

Create a Group in your PC-FAX Address Book (Windows®)

Create a group to broadcast the same PC-FAX to several recipients at one time.

1. Do one of the following:

- Windows® 7

Click  (**Start**) > **All Programs** > **Fuji Xerox** > **Fuji Xerox Utilities**.

Click the drop-down list and select your model name (if not already selected). Click **PC-FAX** in the left navigation bar, and then click **Address Book (Send)**.

- Windows® 8 and Windows® 10

Launch  (**Fuji Xerox Utilities**), and then click the drop-down list and select your model name (if not already selected). Click **PC-FAX** in the left navigation bar, and then click **Address Book (Send)**.

The **Address Book** dialog box appears.

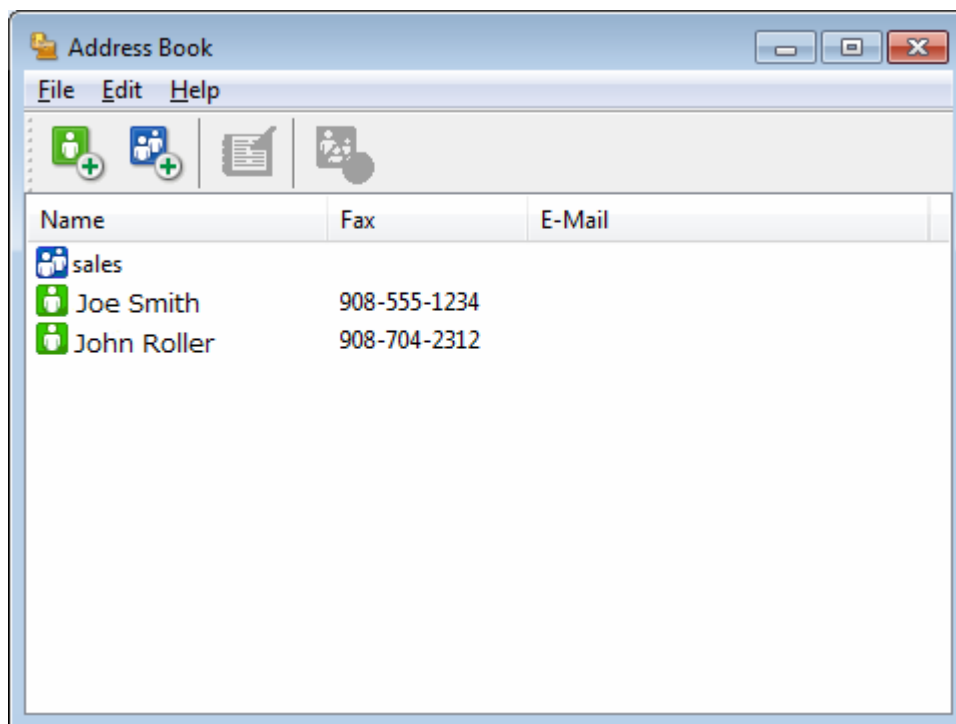

2. Click .

The **Address Book Group Setup** dialog box appears.

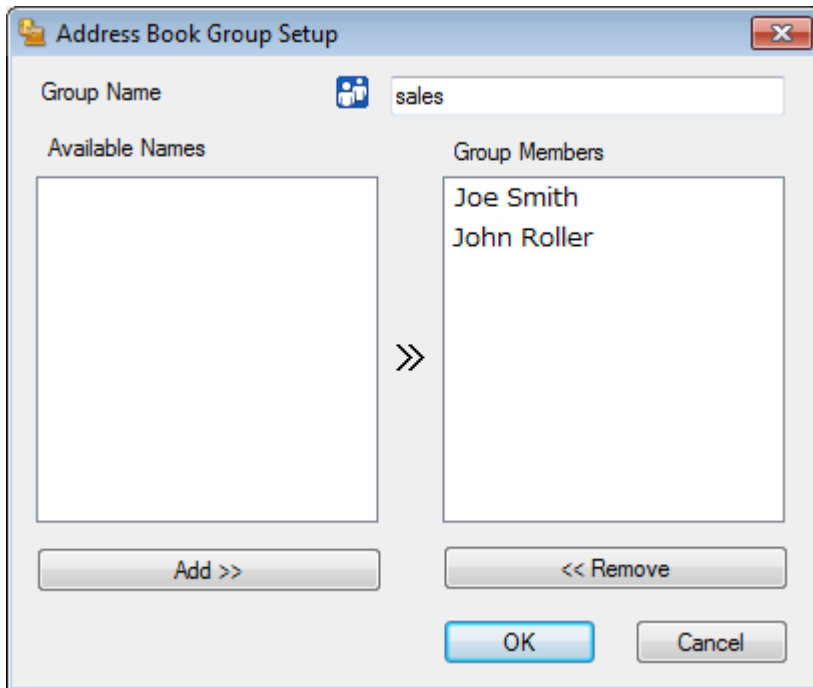

3. Type the name of the new group in the **Group Name** field.
4. In the **Available Names** field, select each name you want to include in the group, and then click **Add >>**. Members added to the group appear in the **Group Members** box.
5. When finished, click **OK**.



Each group can contain up to 50 members.



Related Information

- [Configure your PC-Fax Address Book \(Windows®\)](#)
-

Edit Member or Group Information in your PC-FAX Address Book (Windows®)

1. Do one of the following:

- Windows® 7

Click  (**Start**) > **All Programs** > **Fuji Xerox** > **Fuji Xerox Utilities**.

Click the drop-down list and select your model name (if not already selected). Click **PC-FAX** in the left navigation bar, and then click **Address Book (Send)**.

- Windows® 8 and Windows® 10

Launch  (**Fuji Xerox Utilities**), and then click the drop-down list and select your model name (if not already selected). Click **PC-FAX** in the left navigation bar, and then click **Address Book (Send)**.

The **Address Book** dialog box appears.

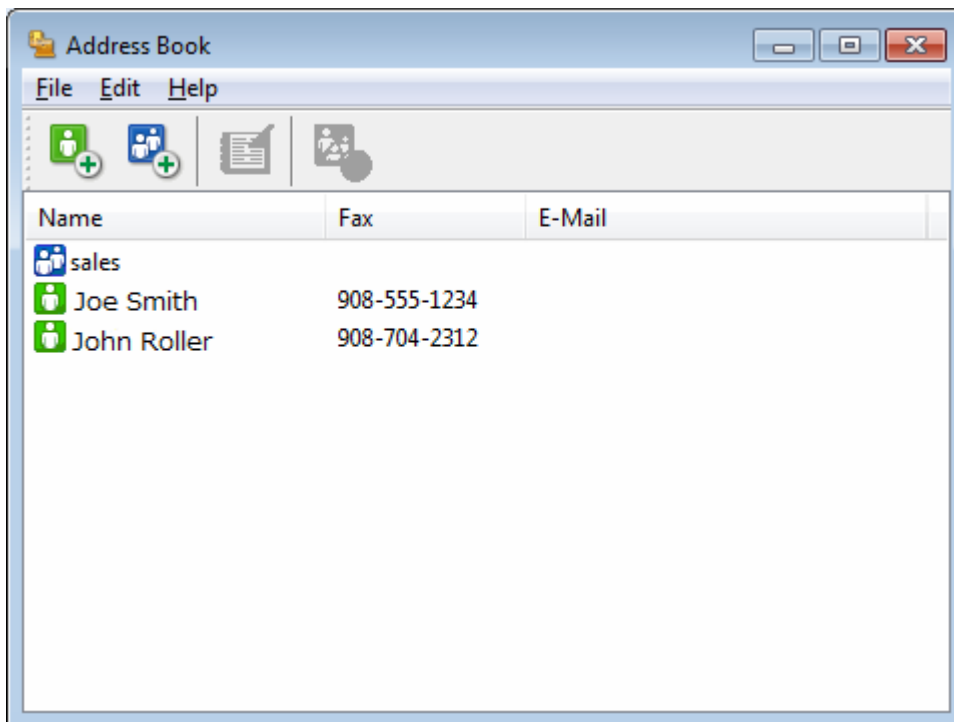

2. Select the member or group you want to edit.

3. Click  (**Properties**).

4. Change the member or group information.

5. Click **OK**.



Related Information

- [Configure your PC-Fax Address Book \(Windows®\)](#)

Delete a Member or Group in your PC-FAX Address Book (Windows®)

1. Do one of the following:

- Windows® 7

Click  (**Start**) > **All Programs** > **Fuji Xerox** > **Fuji Xerox Utilities**.

Click the drop-down list and select your model name (if not already selected). Click **PC-FAX** in the left navigation bar, and then click **Address Book (Send)**.

- Windows® 8 and Windows® 10

Launch  (**Fuji Xerox Utilities**), and then click the drop-down list and select your model name (if not already selected). Click **PC-FAX** in the left navigation bar, and then click **Address Book (Send)**.

The **Address Book** dialog box appears.

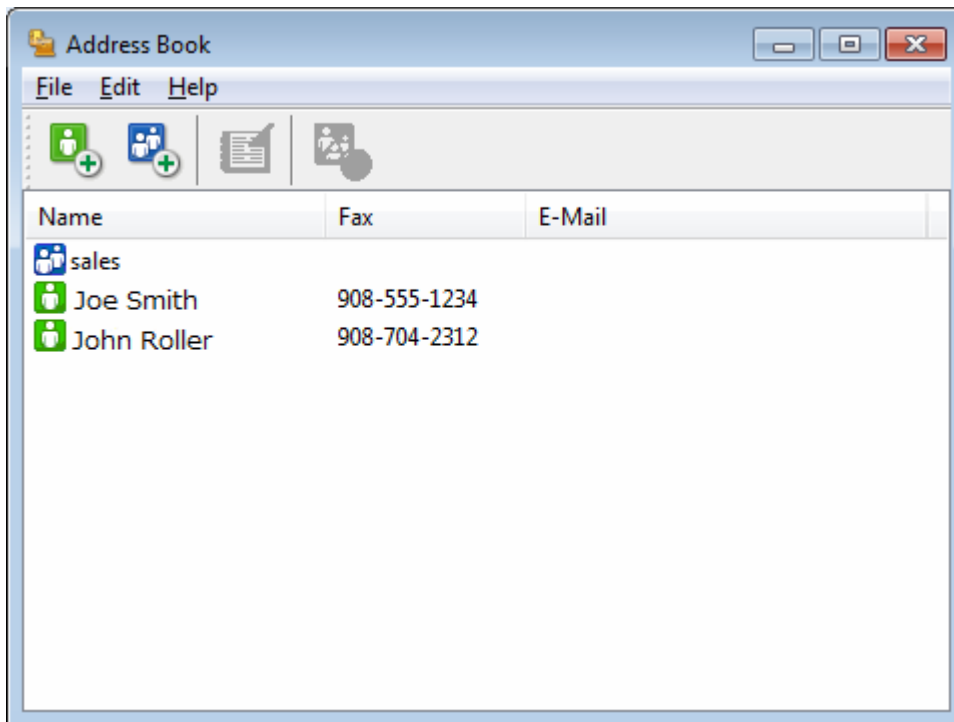

2. Select the member or group you want to delete.

3. Click  (**Delete**).

4. When the confirmation dialog box appears, click **OK**.



Related Information

- [Configure your PC-Fax Address Book \(Windows®\)](#)

Export your PC-FAX Address Book (Windows®)

You can export the Address Book as an ASCII text file (*.csv), a vCard (an electronic business card), or **Remote Setup Dial Data** and save it on your computer.

- You cannot export the group settings when you export the **Address Book** data.

1. Do one of the following:

- Windows® 7

Click  (**Start**) > **All Programs** > **Fuji Xerox** > **Fuji Xerox Utilities**.

Click the drop-down list and select your model name (if not already selected). Click **PC-FAX** in the left navigation bar, and then click **Address Book (Send)**.

- Windows® 8 and Windows® 10

Launch  (**Fuji Xerox Utilities**), and then click the drop-down list and select your model name (if not already selected). Click **PC-FAX** in the left navigation bar, and then click **Address Book (Send)**.

The **Address Book** dialog box appears.

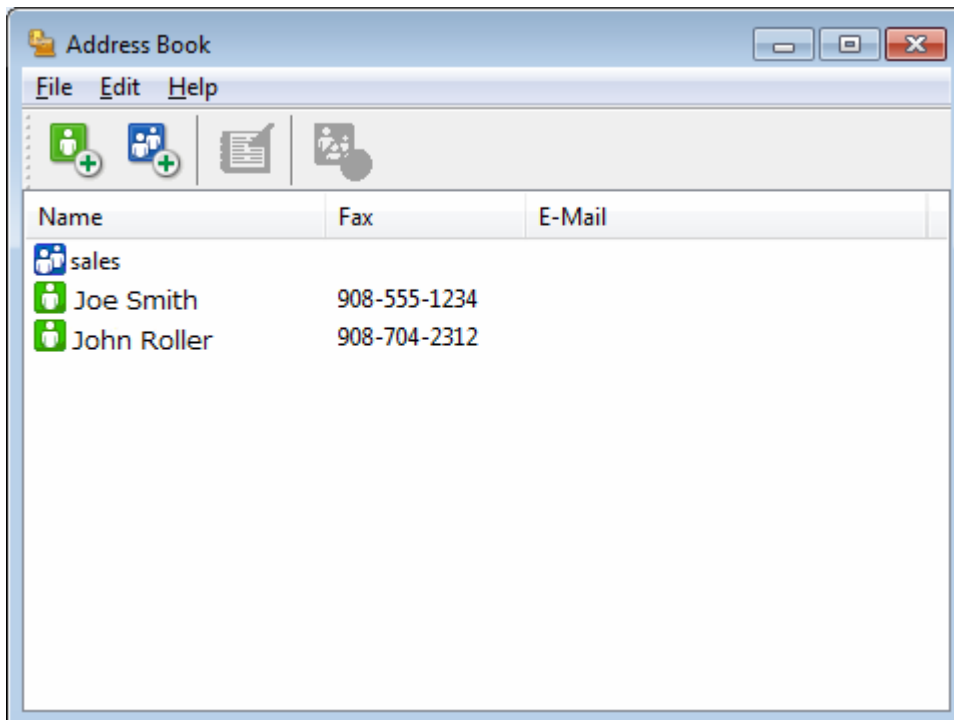

2. Click the **File** menu, and then select **Export**.

3. Select one of the following:

- Text**

The **Select Items** dialog box appears. Go to step 4.

- vCard**

You must select the member you want to export from your address book before selecting this option.

Browse to the folder where you want to save the vCard, type the vCard name in the **File name** field, and then click **Save**.

- Remote Setup Dial Data**

Browse to the folder where you want to save the data, type the file name in the **File name** field, and then click **Save**.

4. In the **Available Items** field, select the data you want to export, and then click **Add >>**.

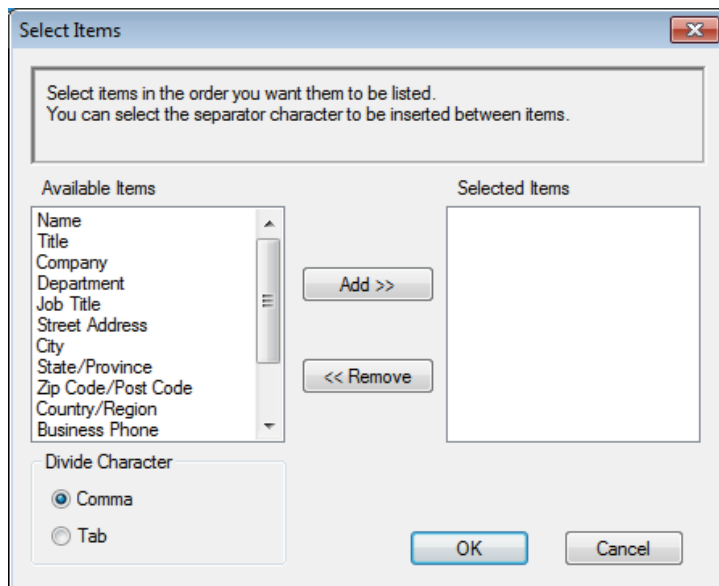

Select and add the items in the order you want them listed.

5. If you are exporting to an ASCII file, under the **Divide Character** section, select the **Tab** or **Comma** option to separate the data fields.
6. Click **OK**.
7. Browse to the folder on your computer where you want to save the data, type the file name, and then click **Save**.



Related Information

- [Configure your PC-Fax Address Book \(Windows®\)](#)

Import Information to your PC-FAX Address Book (Windows®)

You can import ASCII text files (*.csv), vCards (electronic business cards), or **Remote Setup Dial Data** into your Address Book.

1. Do one of the following:

- Windows® 7

Click  (**Start**) > **All Programs** > **Fuji Xerox** > **Fuji Xerox Utilities**.

Click the drop-down list and select your model name (if not already selected). Click **PC-FAX** in the left navigation bar, and then click **Address Book (Send)**.

- Windows® 8 and Windows® 10

Launch  (**Fuji Xerox Utilities**), and then click the drop-down list and select your model name (if not already selected). Click **PC-FAX** in the left navigation bar, and then click **Address Book (Send)**.

The **Address Book** dialog box appears.

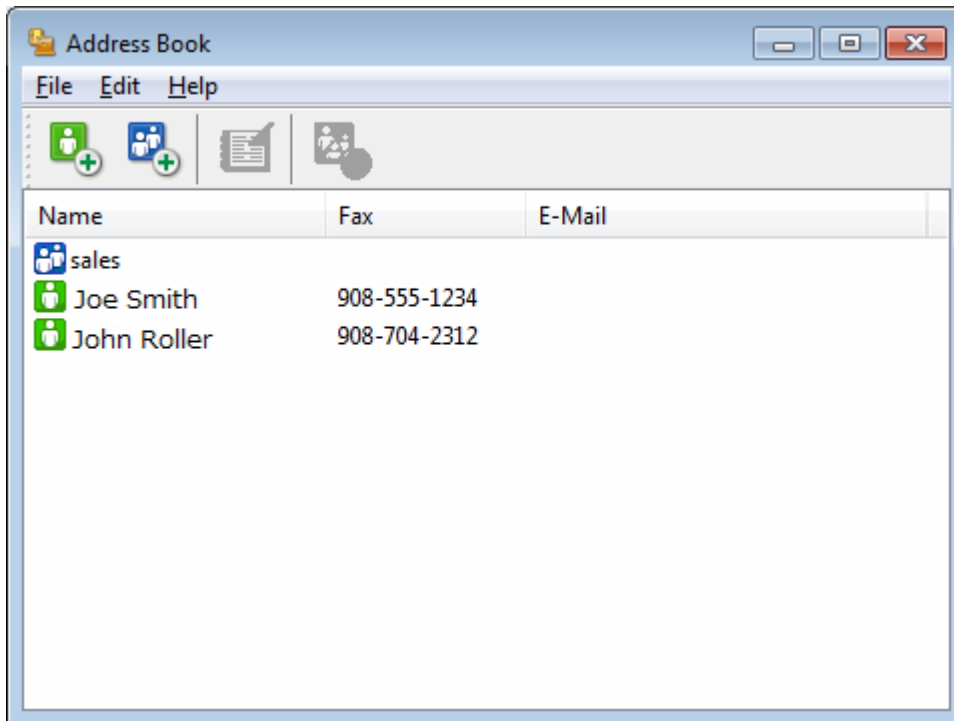

2. Click the **File** menu, and then select **Import**.

3. Select one of the following:

- Text**
The **Select Items** dialog box appears. Go to step 4.
- vCard**
Go to step 7.
- Remote Setup Dial Data**
Go to step 7.

4. In the **Available Items** field, select the data you want to import, and then click **Add >>**.

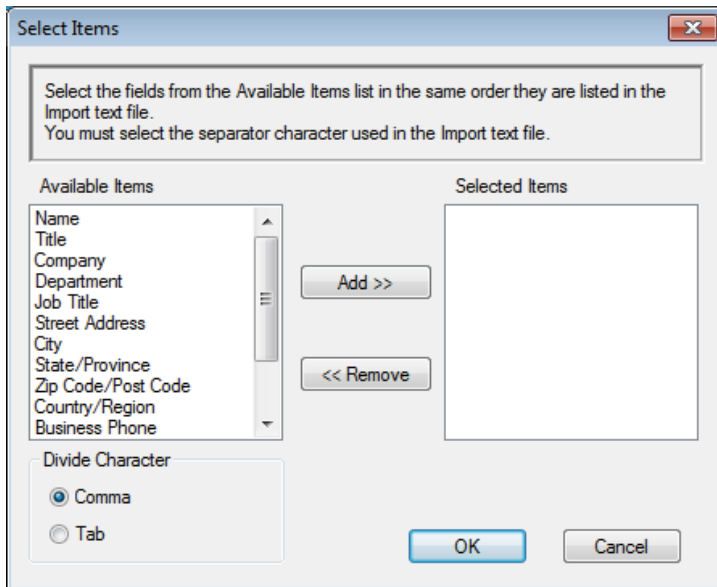

You must select and add fields from the **Available Items** list in the same order they are listed in the import text file.

5. If you are importing an ASCII file, under the **Divide Character** section, select the **Tab** or **Comma** option to separate the data fields.
6. Click **OK**.
7. Browse to the folder where you want to import the data, type the file name, and then click **Open**.

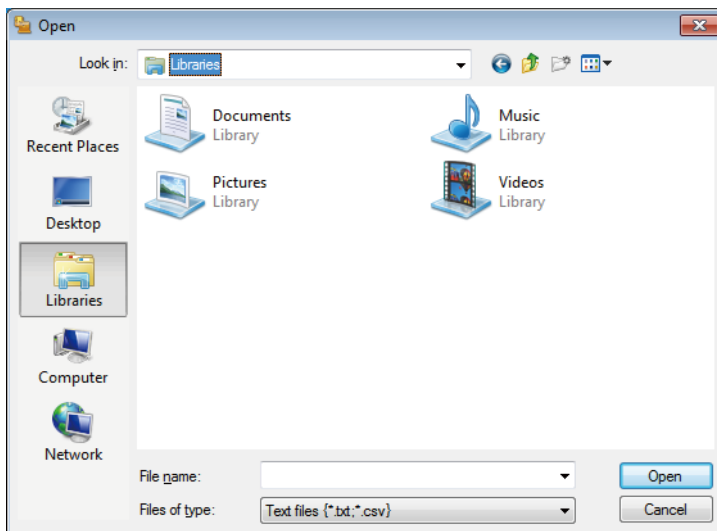

Related Information

- [Configure your PC-Fax Address Book \(Windows®\)](#)

Send a Fax Using PC-FAX (Windows®)

PC-FAX supports only monochrome faxes. A monochrome fax will be sent even if the original data is colour and the receiving fax machine supports colour faxes.

1. Create a file in any application on your computer.
2. Select the print command in your application.
3. Select **PC-FAX** as your printer, and then complete your print operation.
The **PC-FAX** dialog box appears.

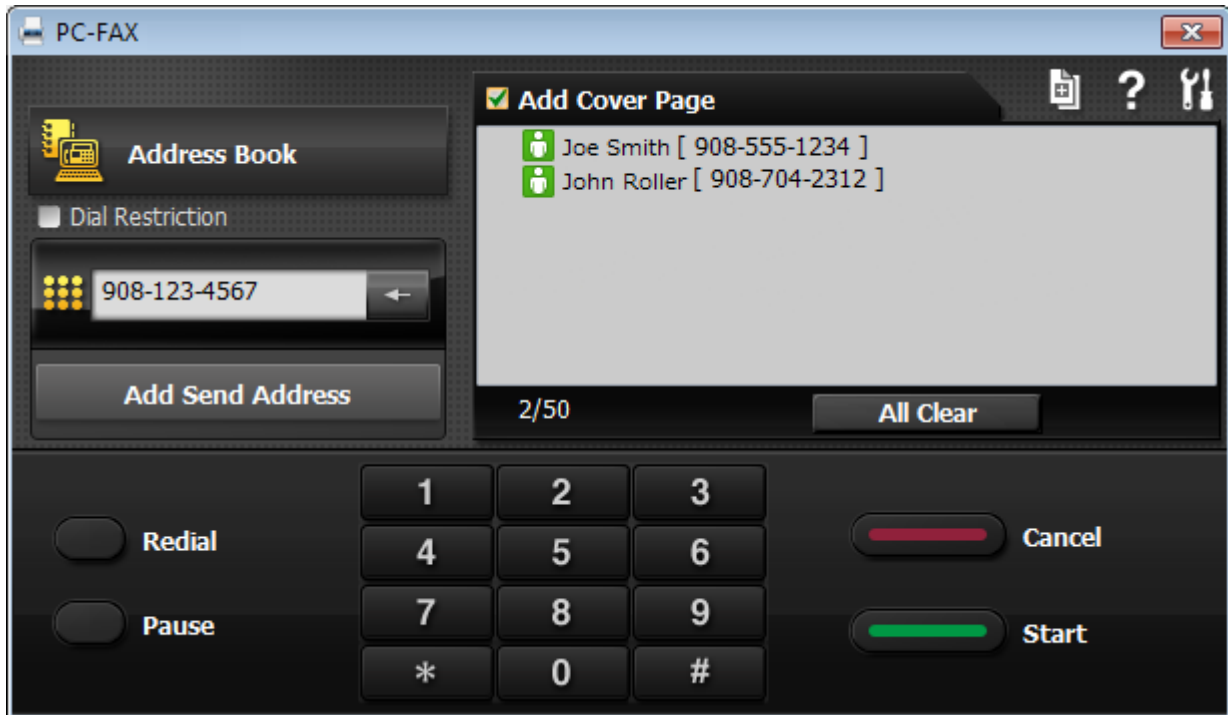

4. Type a fax number using one of the following methods:

- Click the numbers on the dial pad to type the number, and then click **Add Send Address**.



If you select the **Dial Restriction** check box, a confirmation dialog box will appear for you to re-type the fax number using the keyboard. This feature helps to prevent transmissions to the wrong destination.

- Click the **Address Book** button, and then select a member or group from the Address Book.



If you make a mistake, click **All Clear** to delete all entries.

5. To include a cover page, select the **Add Cover Page** check box. You can also click  to create or edit a cover page.
6. Click **Start** to send the fax.



- To cancel the fax, click **Cancel**.
- To redial a number, click **Redial** to show the last five fax numbers, select a number, and then click **Start**.



Related Information

- [PC-FAX for Windows®](#)

Receive Faxes on Your Computer (Windows®)

Use Fuji Xerox's PC-FAX software to receive faxes on your computer, screen them and print only those faxes you want.

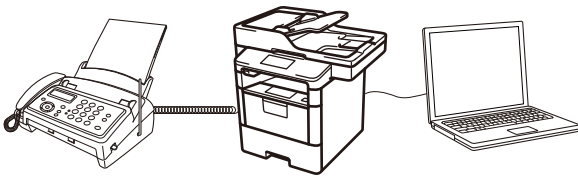

- [Receive Faxes Using PC-FAX Receive \(Windows®\)](#)

Receive Faxes Using PC-FAX Receive (Windows®)

Fuji Xerox's PC-FAX Receive software lets you view and store faxes on your computer. It is automatically installed when you install the Fuji Xerox software and drivers and works on locally- or network-connected machines.

- PC-FAX Receive supports only monochrome faxes.

When you turn off your computer, your machine will continue to receive and store faxes in your Fuji Xerox machine's memory. The machine's LCD will display the number of stored faxes received. When you start this application, the software will transfer all received faxes to your computer at once. You can enable the Backup Print option if you want the machine to print a copy of the fax before the fax is sent to your computer, or before the computer is switched off. You can configure the Backup Print settings from your Fuji Xerox machine.



Related Information

- [Receive Faxes on Your Computer \(Windows®\)](#)
 - [Run Fuji Xerox's PC-FAX Receive on Your Computer \(Windows®\)](#)
 - [View Received Messages \(Windows®\)](#)

Related Topics

- [Use PC-Fax Receive to Transfer Received Faxes to Your Computer \(Windows® only\)](#)

Run Fuji Xerox's PC-FAX Receive on Your Computer (Windows®)



We recommend selecting the **Start PC-FAX Receive on computer startup** check box so that the software runs automatically and can transfer any faxes upon computer startup.

1. Do one of the following:

- Windows® 7

Click  (**Start**) > **All Programs** > **Fuji Xerox** > **Fuji Xerox Utilities**.

Click the drop-down list and select your model name (if not already selected). Click **PC-FAX** in the left navigation bar, and then click **Receive**.

- Windows® 8 and Windows® 10

Launch  (**Fuji Xerox Utilities**), and then click the drop-down list and select your model name (if not already selected). Click **PC-FAX** in the left navigation bar, and then click **Receive**.

2. Confirm the message and click **Yes**.

The **PC-FAX Receive** window appears. The  (**PC-Fax Receive (Ready)**) icon also appears in your computer task tray.



Related Information

- [Receive Faxes Using PC-FAX Receive \(Windows®\)](#)
 - [Set Up Your Computer for PC-FAX Receiving \(Windows®\)](#)
 - [Add Your Fuji Xerox Machine to PC-FAX Receiving \(Windows®\)](#)

Set Up Your Computer for PC-FAX Receiving (Windows®)

1. Double-click the  (PC-Fax Receive (Ready)) icon in your computer task tray.
The **PC-FAX Receive** window appears.
2. Click **Settings**.
3. Configure these options as needed:

Preferences

Configure to start PC-FAX Receive automatically when you start Windows®.

Save

Configure the path to save PC-FAX files and select the received document format.

Upload to

Configure the path to the SharePoint® server and select the option to upload automatically or manually (available only for Administrators).

Device

Select the Fuji Xerox machine that you want to receive PC-FAX.

Lock(available only for Administrators)

Restrict users who do not have administrator privileges from configuring the settings options shown above.

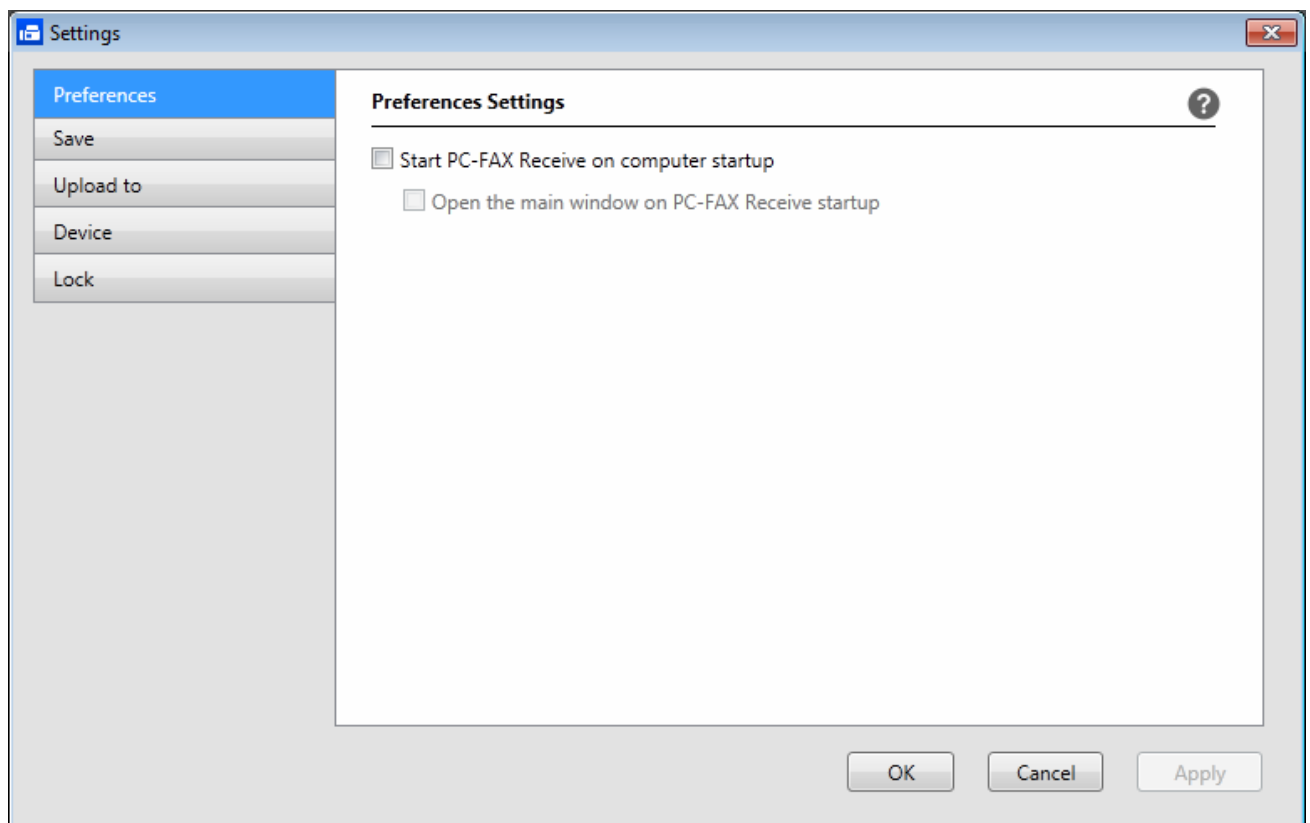

4. Click **OK**.



Related Information

- [Run Fuji Xerox's PC-FAX Receive on Your Computer \(Windows®\)](#)

Add Your Fuji Xerox Machine to PC-FAX Receiving (Windows®)

- If you installed the machine following the instructions for a network user, then the machine should already be configured for your network.

1. Double-click the  (PC-Fax Receive (Ready)) icon in your computer task tray.
The PC-FAX Receive window appears.
2. Click **Settings**.
3. Click **Device > Add**.

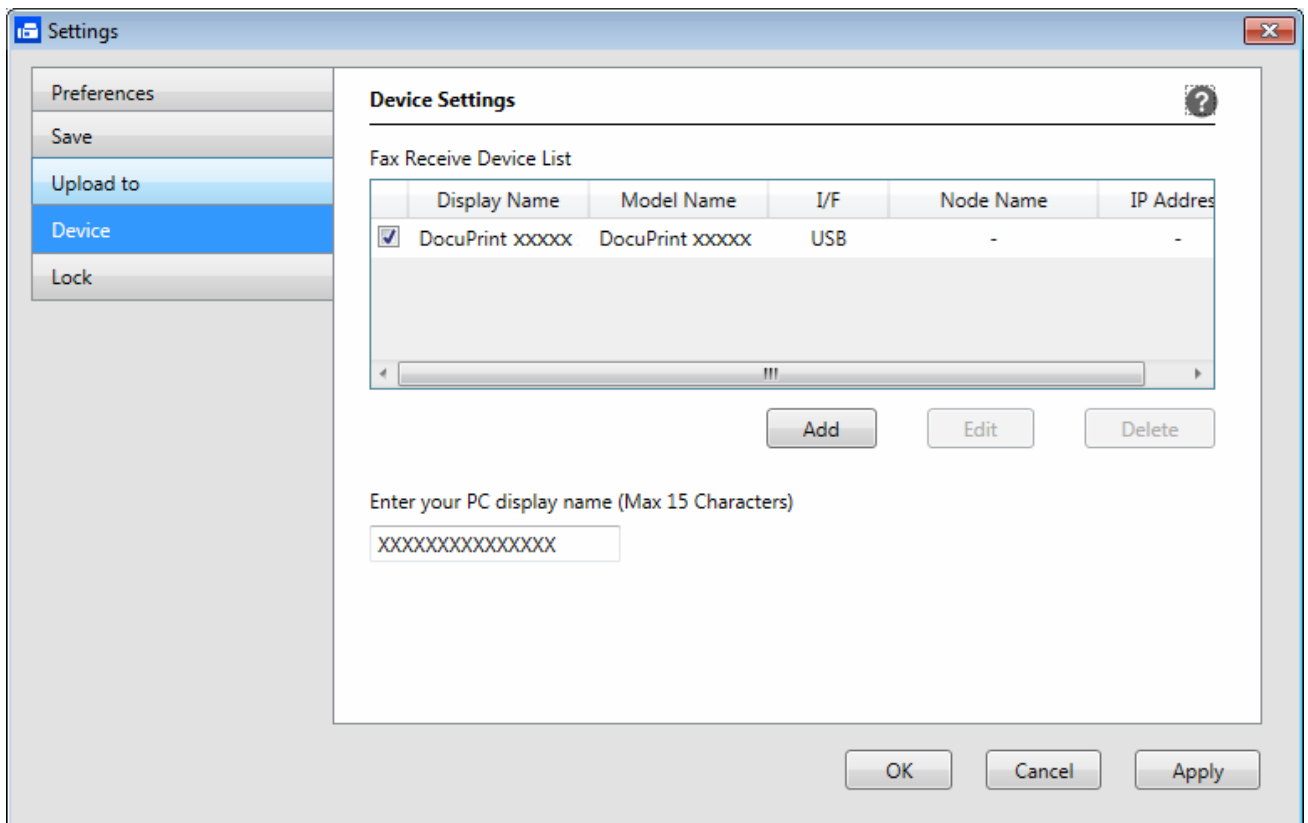

4. Select the appropriate connection method.

Select your machine from the automatic search results below.

Connected Fuji Xerox machines will be displayed. Select a device from the list. Click **OK**.

Specify your machine by IP address

Type the machine's IP address in the **IP Address** field, and then click **OK**.

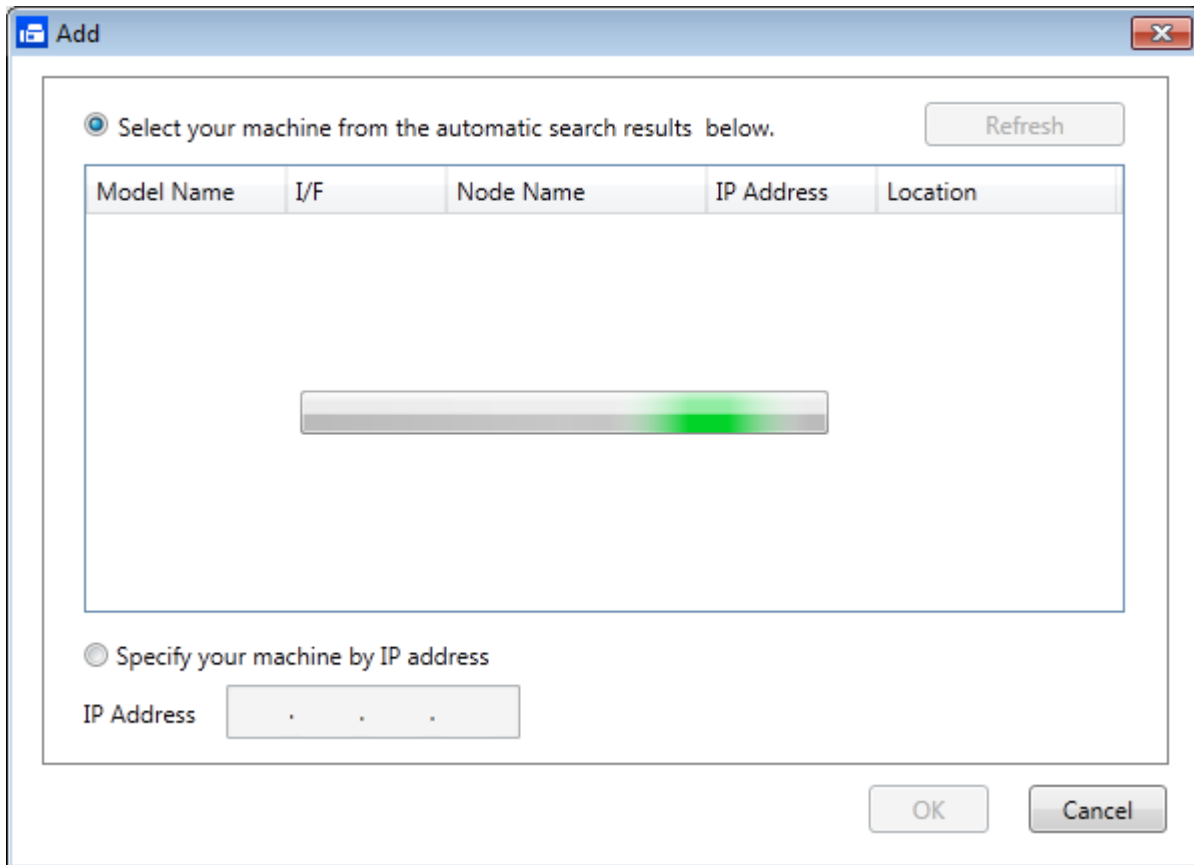

5. To change the computer name that will appear on the machine's LCD, type the new name in the **Enter your PC display name (Max 15 Characters)** field.
6. Click **OK**.







Related Information

- [Run Fuji Xerox's PC-FAX Receive on Your Computer \(Windows®\)](#)

View Received Messages (Windows®)

Receiving Status

Icon	Indicated Status
	Standby mode No unread messages
	Receiving messages
	Messages received Unread messages

1. Double-click the  (**PC-Fax Receive (Ready)**) icon in your computer task tray.
The **PC-FAX Receive** window appears.

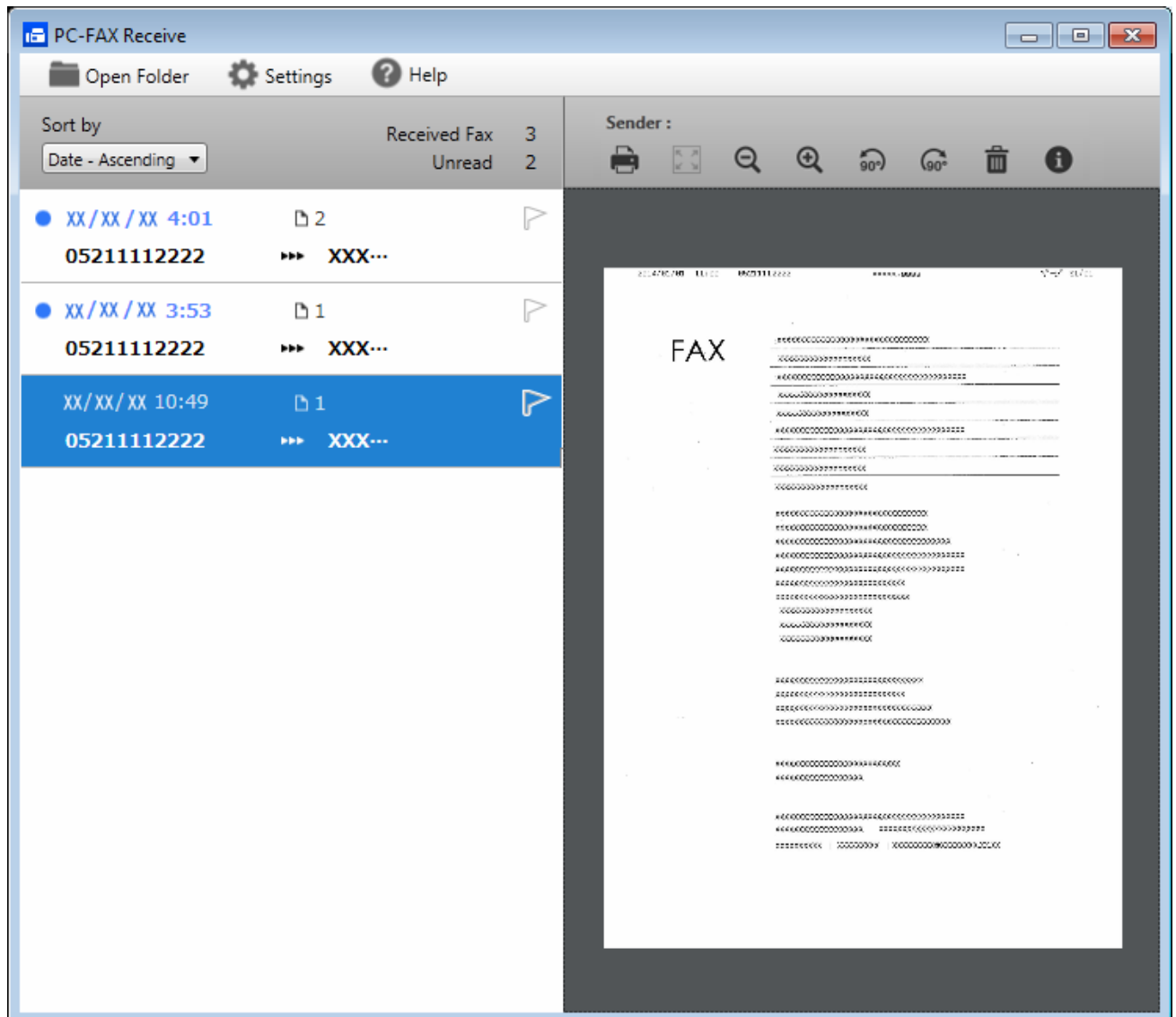

2. Click any faxes in the list to view them.
3. When finished, click  in the right top corner of the window to close it.



Even after closing the window, PC-FAX Receive is active and the  (PC-Fax Receive (Ready)) icon will remain in your computer task tray. To close PC-FAX Receive, click the icon in the computer task tray and click **Close**.



Related Information

- [Receive Faxes Using PC-FAX Receive \(Windows®\)](#)
-

PC-FAX for Mac

Use Fuji Xerox's PC-FAX software to send faxes directly from your Mac without printing them. This feature helps reduce your paper consumption and save time.

- [Send Faxes from Your Application \(Mac\)](#)

Send Faxes from Your Application (Mac)

PC-FAX supports only monochrome faxes. A monochrome fax will be sent even if the original data is colour and the receiving fax machine supports colour faxes.

1. Create a document in a Mac application.
2. From an application, such as Apple TextEdit, click the **File** menu, and then select **Print**.



For more page setup options, click the **Show Details** button.

3. Click the application pop-up menu, and then select the **Send Fax** option.

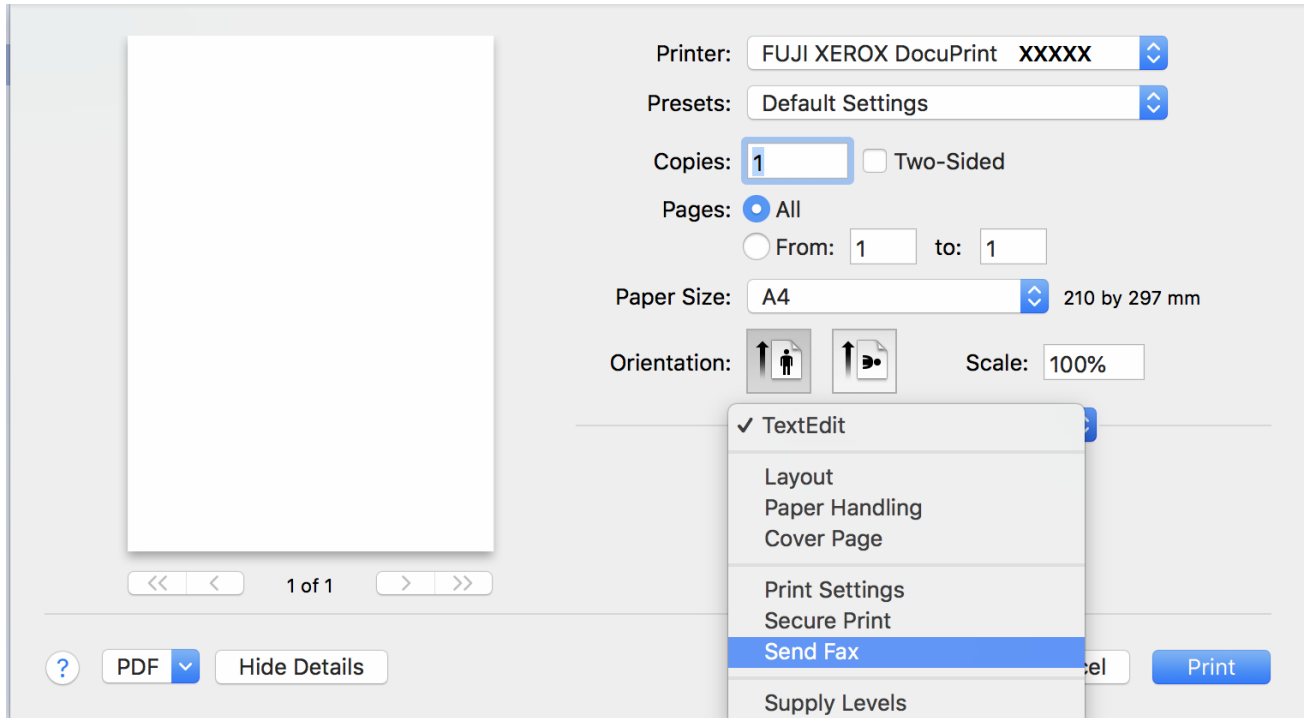

4. Click the **Output** pop-up menu, and then select the **Facsimile** option.

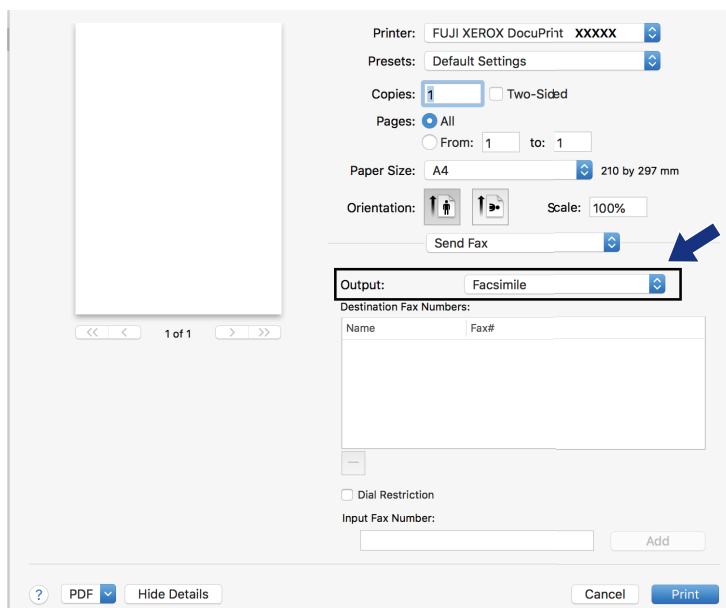

5. Type a fax number in the **Input Fax Number** field, and then click **Add**.
The fax number is displayed in the **Destination Fax Numbers** field.



To send a fax to more than one number, click the **Add** button after entering the first fax number and type the next fax number. The destination fax numbers will be listed in the **Destination Fax Numbers** field.

The screenshot shows a fax software interface with the following elements:

- Printer:** FUJI XEROX DocuPrint XXXXX
- Presets:** Default Settings
- Copies:** 1 (with a checkbox for Two-Sided)
- Pages:** All (with radio buttons for From: 1 to: 1)
- Paper Size:** A4 (210 by 297 mm)
- Orientation:** Portrait (with icons for Portrait and Landscape) and Scale: 100%
- Send Fax:** A dropdown menu.
- Output:** Facsimile
- Destination Fax Numbers:** A table with two columns: Name and Fax#. One entry is visible: Name (blank), Fax# 222-111-3333.
- Input Fax Number:** A text field with an **Add** button next to it. A blue arrow points to the **Add** button.
- Buttons:** ? (help), PDF (dropdown), Hide Details, Cancel, and Print.

6. Click **Print** to send the fax.



Related Information

- [PC-FAX for Mac](#)

Print Data Directly from a USB Flash Drive

You can print photos directly from digital camera media or a USB flash drive, or scan documents and save them directly to a USB flash drive.

Supported file types are PDF, JPEG, TIFF, XPS (XML Paper Specification), and PRN.

- [Compatible USB Flash Drives](#)
- [Print Data Directly from a USB Flash Drive or Digital Camera Supporting Mass Storage](#)
- [Create a PRN File for Direct Printing \(Windows®\)](#)

Compatible USB Flash Drives

IMPORTANT

The USB direct interface supports only USB flash drives, PictBridge-compatible cameras and digital cameras that use the USB mass storage standard. Other USB devices are not supported.

Compatible USB Flash Drives	
USB Class	USB Mass Storage Class
USB Mass Storage Sub Class	SCSI or SFF-8070i
Transfer protocol	Bulk transfer Only
Format *1	FAT12/FAT16/FAT32/exFAT
Sector size	Max. 4096 Byte
Encryption	Encrypted devices are not supported.

*1 NTFS format is not supported.



Related Information

- [Print Data Directly from a USB Flash Drive](#)

Print Data Directly from a USB Flash Drive or Digital Camera Supporting Mass Storage

- Make sure your digital camera is turned on.
- Your digital camera must be switched from PictBridge mode to mass storage mode.

IMPORTANT

To prevent damage to your machine, DO NOT connect any device other than a digital camera or USB flash drive to the USB direct interface.

1. Connect your USB flash drive or digital camera to the USB direct interface on the front of the machine. The touchscreen will automatically display the USB menu to confirm the USB flash drive or digital camera is correctly connected.

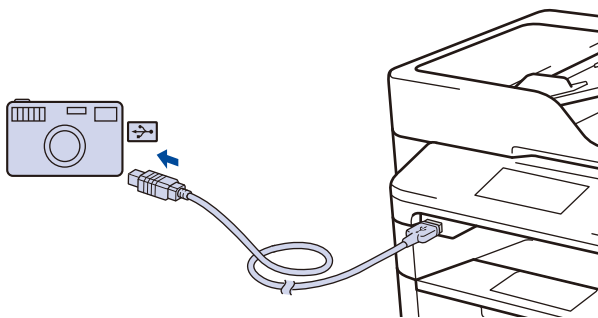
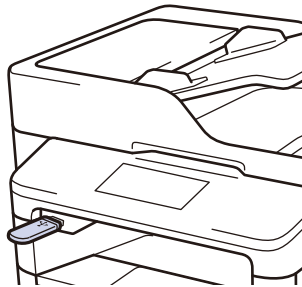

- If an error occurs, the USB menu will not appear on the touchscreen.
- When the machine is in Deep Sleep mode, the touchscreen does not display any information even if you connect a USB flash drive to the USB direct interface. Press the touchscreen to wake up the machine.

2. Press [Direct Print].



If your machine has been set to Secure Function Lock On, you may not be able to access Direct Print.

3. Swip up or down, or press ▲ or ▼ to display the file you want to print, and then select the file.



To print an index of the files, press [Index Print] on the touchscreen. Press [Yes] to print the data.

4. Do one of the following:

- To change the settings, press [Print Settings]. Go to the next step.
- If you want to use the default settings, enter the number of copies, and then press [Start].

5. Select the print settings you want to change:

- [Paper Type]
- [Paper Size]
- [Multiple Page]
- [Orientation]
- [2-sided]
- [Collate]
- [Tray Use]
- [Print Quality]
- [PDF Option]

NOTE

Depending on the file type, some of these settings may not appear.

6. Press [OK].
7. Enter the number of copies you want.
8. Press [Start] to print the data.
9. Press .

IMPORTANT

DO NOT remove the USB flash drive or digital camera from the USB direct interface until the machine has finished printing.



Related Information

- [Print Data Directly from a USB Flash Drive](#)
-

Create a PRN File for Direct Printing (Windows®)

These instructions may vary depending on your print application and operating system.

1. Select the print command in your application.
2. Select your model, and then select the print to file option.
3. Complete your print operation.
4. Enter the required information to save the file.



If the computer prompts you to enter a file name only, you can also specify the folder where you want to save the file by typing the directory name (for example: C:\Temp\FileName.prn).

If a USB flash drive is connected to your computer, you can save the file directly to the USB flash drive.



Related Information

- [Print Data Directly from a USB Flash Drive](#)

Network

- [Get Started](#)
- [Network Management Software and Utilities](#)
- [Additional Methods of Configuring Your Fuji Xerox Machine for a Wireless Network](#)
- [Advanced Network Features](#)
- [Technical Information for Advanced Users](#)

Get Started

We recommend setting up and connecting to your network using the Fuji Xerox installation disc. This section provides more information about network connection types, introduces various methods to manage your network and explains some useful network features of your Fuji Xerox machine.

- [Supported Basic Network Features](#)

Supported Basic Network Features

The print server supports various features depending on the operating system. Use this table to see which network features and connections are supported by each operating system.

Operating Systems	Windows® 7 Windows® 8 Windows® 10	Windows Server® 2008 Windows Server® 2008 R2 Windows Server® 2012 Windows Server® 2012 R2 Windows Server® 2016 Windows Server® 2019	macOS v10.12.x macOS v10.13.x macOS v10.14.x
Printing	Yes	Yes	Yes
Scanning	Yes		Yes
PC Fax Send (Available only for certain models)	Yes		Yes
PC Fax Receive (Available only for certain models)	Yes		
BRAdmin Light	Yes	Yes	
Web Based Management	Yes	Yes	Yes
Remote Setup (Available only for certain models)	Yes		
Status Monitor	Yes	Yes	Yes
Vertical Pairing (Available only for certain models)	Yes		



- To use BRAdmin Light, access the supplied Fuji Xerox installation disc to install BRAdmin Light.



Related Information

- [Get Started](#)

Network Management Software and Utilities

Configure and change your Fuji Xerox machine's network settings using a management utility.

- [Learn about Network Management Software and Utilities](#)
- [Change Machine Settings from Your Computer](#)
- [Change Machine Settings Using Web Based Management](#)

Learn about Network Management Software and Utilities

Web Based Management

Web Based Management is a utility that uses a standard web browser to manage your machine using the Hyper Text Transfer Protocol (HTTP) or Hyper Text Transfer Protocol over Secure Socket Layer (HTTPS). Type your machine's IP address into your web browser to access and change your print server settings.

BRAdmin Light (Windows®)

BRAdmin Light is a utility for the initial setup of Fuji Xerox network-connected devices. This utility can search for Fuji Xerox products on your network, view the status and configure the basic network settings, such as IP address.

To use BRAdmin Light, access the supplied Fuji Xerox installation disc to install BRAdmin Light.



- If you are using Windows® Firewall, or the firewall function of an anti-spyware or antivirus application, temporarily disable them. When you are sure you can print, configure the software settings following the instructions.

Remote Setup (Windows®) (Available only for certain models)

Remote Setup is a program for configuring many machine and network settings from either a Windows® or a Mac application. When you start this application, the settings on your machine are automatically downloaded to your computer and displayed on your computer screen. If you change the settings, you can upload them directly to the machine.



This utility can be used for either a USB or a network connection.



Related Information

- [Network Management Software and Utilities](#)

Additional Methods of Configuring Your Fuji Xerox Machine for a Wireless Network

Related Models: DocuPrint M385 z/DocuPrint M375 z

To connect your machine to your wireless network, we recommend using the Fuji Xerox installation disc.

- [Before Configuring Your Fuji Xerox Machine for a Wireless Network](#)
- [Configure Your Machine for a Wireless Network](#)
- [Configure Your Machine for a Wireless Network Using the One Push Method of Wi-Fi Protected Setup™ \(WPS\)](#)
- [Configure Your Machine for a Wireless Network Using the PIN Method of Wi-Fi Protected Setup™ \(WPS\)](#)
- [Configure Your Machine for a Wireless Network in Ad-Hoc Mode \(For IEEE 802.11b/g/n\)](#)
- [Configure Your Machine for a Wireless Network Using the Machine's Control Panel Setup Wizard](#)
- [Configure Your Machine for a Wireless Network When the SSID Is Not Broadcast](#)
- [Configure Your Machine for an Enterprise Wireless Network](#)
- [Use Wi-Fi Direct®](#)

Before Configuring Your Fuji Xerox Machine for a Wireless Network

Related Models: DocuPrint M385 z/DocuPrint M375 z

Before attempting to configure a wireless network, confirm the following:

- Before configuring wireless settings, you must know your Network name (SSID) and Network Key. If you are using an enterprise wireless network, you must know the User ID and Password.



If you do not know the security information, please consult the router manufacture, your system administrator, or your Internet provider.

- To achieve optimum results with normal everyday document printing, place the Fuji Xerox machine as close to the wireless LAN access point/router as possible with minimal obstructions. Large objects and walls between the two devices and interference from other electronic devices can affect the data transfer speed of your documents.

Due to these factors, wireless may not be the best method of connection for all types of documents and applications. If you are printing large files, such as multi-page documents with mixed text and large graphics, you may want to consider selecting wired Ethernet for faster data transfer (supported models only), or USB for the fastest throughput speed.

- Although the Fuji Xerox machine can be used in both a wired and wireless network (supported models only), only one connection method can be used at a time. However, a wireless network connection and Wi-Fi Direct connection, or a wired network connection (supported models only) and Wi-Fi Direct connection can be used at the same time.



Related Information

- [Additional Methods of Configuring Your Fuji Xerox Machine for a Wireless Network](#)

Configure Your Machine for a Wireless Network

Related Models: DocuPrint M385 z/DocuPrint M375 z

1. Turn on your computer and insert the Fuji Xerox installation disc into your computer.
 - For Windows®, follow these instructions:
 - The printer driver for Mac is available from the download page for your model on the Fuji Xerox website at <http://www.fujixerox.com>.
2. The opening screen appears automatically.
Choose your language, and then follow the on-screen instructions.



If the Fuji Xerox screen does not appear, do the following:

- (Windows® 7)
Go to **Computer**. Double-click the CD/DVD icon, and then double-click **start.exe**.
- (Windows® 8 and Windows® 10)
Click the  (**File Explorer**) icon on the taskbar, and then go to **Computer (This PC)**. Double-click the CD/DVD icon, and then double-click **start.exe**.
- If the **User Account Control** screen appears, click **Yes**.

3. Choose **Wireless Network Connection (Wi-Fi)**, and then click **Next**.
4. Follow the on-screen instructions.

You have completed the wireless network setup. To install **Full Driver & Software Package** necessary for operating your device, insert the Fuji Xerox installation disc into your computer or go to the download page for your model on the Fuji Xerox website at <http://www.fujixerox.com>.



Related Information

- [Additional Methods of Configuring Your Fuji Xerox Machine for a Wireless Network](#)

Configure Your Machine for a Wireless Network Using the One Push Method of Wi-Fi Protected Setup™ (WPS)

Related Models: DocuPrint M385 z/DocuPrint M375 z

If your wireless access point/router supports WPS (Push Button Configuration), you can use WPS from your machine's control panel menu to configure your wireless network settings.



Routers or access points that support WPS are marked with this symbol:



1. Press  [Settings] > [All Settings] > [Network] > [WLAN] > [WPS].
2. When [Enable WLAN?] appears, press [Yes].
This will start the wireless setup wizard. To cancel, press [No].
3. When the touchscreen displays [Start WPS on your wireless access point/router, then press [OK].], press the WPS button on your wireless access point/router. Then press [OK] on your machine. Your machine will automatically detect your wireless access point/router and try to connect to your wireless network.

If your wireless device is connected successfully, the machine's LCD displays [Connected].

You have completed the wireless network setup. To install drivers and software necessary for operating your device, insert the Fuji Xerox installation disc to your computer or go to the download page for your model on the Fuji Xerox website at <http://www.fujixerox.com>.



Related Information

- [Additional Methods of Configuring Your Fuji Xerox Machine for a Wireless Network](#)

Related Topics

- [Wireless LAN Report Error Codes](#)

Configure Your Machine for a Wireless Network Using the PIN Method of Wi-Fi Protected Setup™ (WPS)

Related Models: DocuPrint M385 z/DocuPrint M375 z

If your wireless LAN access point/router supports WPS, you can use the Personal Identification Number (PIN) Method to configure your wireless network settings.

The PIN Method is one of the connection methods developed by the Wi-Fi Alliance®. By submitting a PIN created by an Enrollee (your machine) to the Registrar (a device that manages the wireless LAN), you can set up the wireless network and security settings. For more information on how to access WPS mode, see the instructions provided with your wireless access point/router.

Type A

Connection when the wireless LAN access point/router (1) doubles as Registrar.

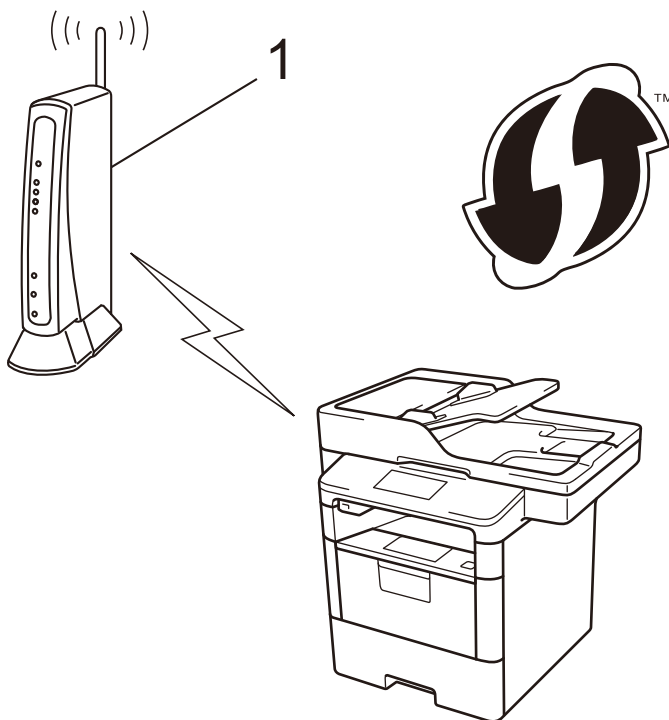

Type B

Connection when another device (2), such as a computer, is used as Registrar.

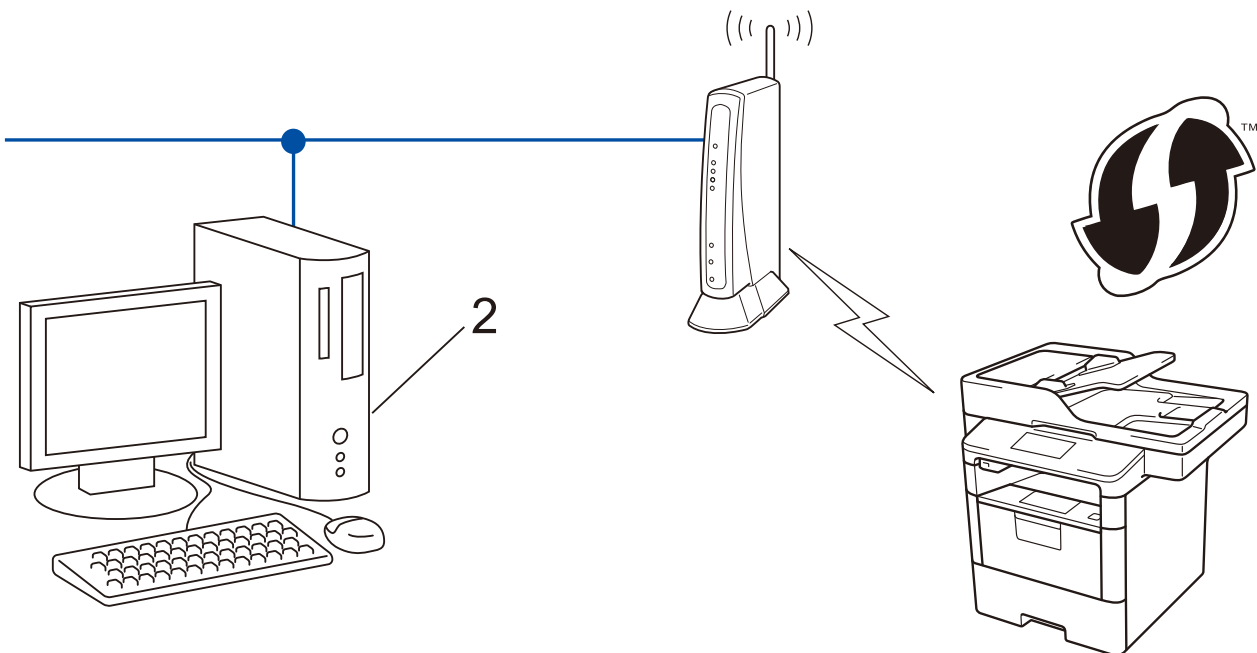

 Routers or access points that support WPS are marked with this symbol:



1. Press  [Settings] > [All Settings] > [Network] > [WLAN] > [WPS w/ PIN Code].
2. When [Enable WLAN?] appears, press [Yes].
This will start the wireless setup wizard. To cancel, press [No].
3. The LCD displays an eight-digit PIN and the machine starts searching for a wireless LAN access point/router.
4. Using a computer that is on the network, type "http://access point's IP address" in your browser (where "access point's IP address" is the IP address of the device that is being used as the Registrar).
5. Go to the WPS settings page and type the PIN, and then follow the on-screen instructions.

- 
- The Registrar is usually the wireless LAN access point/router.
 - The settings page will differ depending on the brand of wireless LAN access point/router. For more information, see the instructions supplied with your wireless LAN access point/router.

If you are using a Windows® 7, Windows® 8, or Windows® 10 computer as a Registrar, complete the following steps:

6. Do one of the following:
 - Windows® 7
Click  (Start) > **Devices and Printers** > **Add a device**.
 - Windows® 8
Move your mouse to the lower right corner of your desktop. When the menu bar appears, click **Settings** > **Control Panel** > **Hardware and Sound** > **Devices and Printers** > **Add a device**.

-
- Windows® 10

Click  > **Windows System** > **Control Panel**. In the **Hardware and Sound** group, click **Add a device**.



- To use a Windows® 7, Windows® 8, or Windows® 10 computer as a Registrar, you must register it to your network in advance. For more information, see the instructions supplied with your wireless LAN access point/router.
 - If you use Windows® 7, Windows® 8, or Windows® 10 as a Registrar, you can install the printer driver after the wireless configuration by following the on-screen instructions. To install the full driver and software package, use the Fuji Xerox installation disc.
-

7. Select your machine and click **Next**.
8. Type the PIN displayed on the machine's LCD, and then click **Next**.
9. Select your network, and then click **Next**.
10. Click **Close**.

If your wireless device is connected successfully, the machine's LCD displays [Connected].

You have completed the wireless network setup. To install drivers and software necessary for operating your device, insert the Fuji Xerox installation disc to your computer or go to the download page for your model on the Fuji Xerox website at <http://www.fujixerox.com>.



Related Information

- [Additional Methods of Configuring Your Fuji Xerox Machine for a Wireless Network](#)

Related Topics

- [Wireless LAN Report Error Codes](#)
-

Configure Your Machine for a Wireless Network in Ad-Hoc Mode (For IEEE 802.11b/g/n)

- [Configure Your Machine for a Wireless Network in Ad-Hoc Mode Using a New SSID](#)
- [Configure Your Machine for a Wireless Network in Ad-Hoc Mode Using an Existing SSID](#)

Configure Your Machine for a Wireless Network in Ad-Hoc Mode Using a New SSID

Related Models: DocuPrint M385 z/DocuPrint M375 z

You must connect to a new SSID from your computer when it is configured for Ad-Hoc mode.

1. Press [] [Settings] > [All Settings] > [Network] > [WLAN] > [Setup Wizard].
2. When [Enable WLAN?] appears, press [Yes].
This will start the wireless setup wizard. To cancel, press [No].
3. The machine will search for your network and display a list of available SSIDs. Swipe up or down or press ▲ or ▼ to display [<New SSID>]. Press [<New SSID>], and then press [OK].
4. Enter the SSID name, and then press [OK].
5. Press [Ad-hoc] when instructed.
6. Select the Encryption type [None] or [WEP].
7. If you selected the [WEP] option for Encryption type, select and enter the WEP key, and then press [OK].



- Your Fuji Xerox machine supports the use of the first WEP key only.

8. The machine will attempt to connect to the wireless device you have selected.

If your wireless device is connected successfully, the machine's LCD displays [Connected].

You have completed the wireless network setup. To install drivers and software necessary for operating your device, insert the Fuji Xerox installation disc to your computer or go to the download page for your model on the Fuji Xerox website at <http://www.fujixerox.com>.



Related Information

- [Configure Your Machine for a Wireless Network in Ad-Hoc Mode \(For IEEE 802.11b/g/n\)](#)

Related Topics

- [How to Enter Text on Your Fuji Xerox Machine](#)
- [Wireless LAN Report Error Codes](#)

Configure Your Machine for a Wireless Network in Ad-Hoc Mode Using an Existing SSID

Related Models: DocuPrint M385 z/DocuPrint M375 z

If you are trying to pair your Fuji Xerox machine to a computer that is already in Ad-Hoc mode and has a configured SSID, use these instructions.

Before configuring your machine, we recommend writing down your wireless network settings. You will need this information before you continue with the configuration.

1. Check and record the current wireless network settings of the computer to which you are connecting.



The wireless network settings of the computer you are connecting with must be set to Ad-Hoc mode with an SSID already configured. For more information on how to configure your computer in Ad-Hoc mode, see the instructions included with your computer or contact your network administrator.

Network Name (SSID)

Communication Mode	Encryption Mode	Network Key
Ad-Hoc	NONE	-
	WEP	

For example:

Network Name (SSID)
HELLO

Communication Mode	Encryption Mode	Network Key
Ad-Hoc	WEP	12345



Your Fuji Xerox machine supports the use of the first WEP key only.

2. Press [Settings] > [All Settings] > [Network] > [WLAN] > [Setup Wizard].
3. When [Enable WLAN?] appears, press [Yes].
This will start the wireless setup wizard. To cancel, press [No].
4. The machine will search for your network and display a list of available SSIDs. If a list of SSIDs is displayed, swipe up or down or press ▲ or ▼ to display the SSID to which you want to connect, and then press the SSID.
5. Press [OK].
6. Enter the WEP key, and then press [OK].



Your Fuji Xerox machine supports the use of the first WEP key only.

7. The machine attempts to connect to the wireless device you have selected.

If your wireless device is connected successfully, the machine's LCD displays [Connected].

You have completed the wireless network setup. To install drivers and software necessary for operating your device, insert the Fuji Xerox installation disc to your computer or go to the download page for your model on the Fuji Xerox website at <http://www.fujixerox.com>.



Related Information

- [Configure Your Machine for a Wireless Network in Ad-Hoc Mode \(For IEEE 802.11b/g/n\)](#)

Related Topics

- [How to Enter Text on Your Fuji Xerox Machine](#)
 - [Wireless LAN Report Error Codes](#)
-

Configure Your Machine for a Wireless Network Using the Machine's Control Panel Setup Wizard

Related Models: DocuPrint M385 z/DocuPrint M375 z

Before configuring your machine, we recommend writing down your wireless network settings. You will need this information before you continue with the configuration.

1. Check and record the current wireless network settings of the computer to which you are connecting.

Network Name (SSID)

Network Key

For example:

Network Name (SSID)
HELLO

Network Key
12345



- Your access point/router may support the use of multiple WEP keys, however your Fuji Xerox machine supports the use of the first WEP key only.
- If you need assistance during setup and want to contact Fuji Xerox customer service, make sure you have your SSID (Network Name) and Network Key ready. We cannot assist you in locating this information.
- If you do not know this information (SSID and Network Key), you cannot continue the wireless setup.

How can I find this information?

- a. Check the documentation provided with your wireless access point/router.
- b. The initial SSID could be the manufacturer's name or the model name.
- c. If you do not know the security information, please consult the router manufacturer, your system administrator, or your Internet provider.

2. On your Fuji Xerox machine's LCD, press [] [Settings] > [All Settings] > [Network] > [WLAN] > [Setup Wizard].
3. When [Enable WLAN?] appears, press [Yes].
This will start the wireless setup wizard. To cancel, press [No].
4. The machine will search for your network and display a list of available SSIDs.
If a list of SSIDs is displayed, swipe up or down or press ▲ or ▼ to display the SSID to which you want to connect, and then press the SSID.
5. Press [OK].
6. Do one of the following:
 - If you are using an authentication and encryption method that requires a Network Key, enter the Network Key you wrote down in the first step.
When you have entered all the characters, press [OK].

-
- If your authentication method is Open System and your encryption mode is None, go to the next step.
7. The machine attempts to connect to the wireless device you have selected.

If your wireless device is connected successfully, the machine's LCD displays [Connected].

You have completed the wireless network setup. To install drivers and software necessary for operating your device, insert the Fuji Xerox installation disc to your computer or go to the download page for your model on the Fuji Xerox website at <http://www.fujixerox.com>.



Related Information

- [Additional Methods of Configuring Your Fuji Xerox Machine for a Wireless Network](#)

Related Topics

- [How to Enter Text on Your Fuji Xerox Machine](#)
 - [Wireless LAN Report Error Codes](#)
-

Configure Your Machine for a Wireless Network When the SSID Is Not Broadcast

Related Models: DocuPrint M385 z/DocuPrint M375 z

Before configuring your machine, we recommend writing down your wireless network settings. You will need this information before you continue with the configuration.

1. Check and record the current wireless network settings.

Network Name (SSID)

Communication Mode	Authentication Method	Encryption Mode	Network Key
Infrastructure	Open System	NONE	-
		WEP	
	Shared Key	WEP	
	WPA/WPA2-PSK	AES	
		TKIP (TKIP is supported for WPA-PSK only.)	

For example:

Network Name (SSID)
HELLO

Communication Mode	Authentication Method	Encryption Mode	Network Key
Infrastructure	WPA2-PSK	AES	12345678



If your router uses WEP encryption, enter the key used as the first WEP key. Your Fuji Xerox machine supports the use of the first WEP key only.

2. Press  [Settings] > [All Settings] > [Network] > [WLAN] > [Setup Wizard].
3. When [Enable WLAN?] appears, press [Yes].
This will start the wireless setup wizard. To cancel, press [No].
4. The machine will search for your network and display a list of available SSIDs. Swipe up or down or press ▲ or ▼ to display [<New SSID>]. Press [<New SSID>], and then press [OK].
5. Enter the SSID name, and then press [OK].
6. Press [Infrastructure] when instructed.
7. Select the Authentication Method.
8. Do one of the following:
 - If you selected the [Open System] option, press the Encryption type [None] or [WEP].
If you selected the [WEP] option for Encryption type, select and enter the WEP key, and then press [OK].

-
- If you selected the [Shared Key] option, select and enter the WEP key, and then press [OK].
 - If you selected the [WPA/WPA2-PSK] option, press the Encryption type [TKIP+AES] or [AES]. Enter the WPA key, and then press [OK].
-



- Your Fuji Xerox machine supports the use of the first WEP key only.
-

9. The machine will attempt to connect to the wireless device you have selected.

If your wireless device is connected successfully, the machine's LCD displays [Connected].

You have completed the wireless network setup. To install drivers and software necessary for operating your device, insert the Fuji Xerox installation disc to your computer or go to the download page for your model on the Fuji Xerox website at <http://www.fujixerox.com>.



Related Information

- [Additional Methods of Configuring Your Fuji Xerox Machine for a Wireless Network](#)

Related Topics

- [I Cannot Complete the Wireless Network Setup Configuration](#)
 - [How to Enter Text on Your Fuji Xerox Machine](#)
 - [Wireless LAN Report Error Codes](#)
-

Configure Your Machine for an Enterprise Wireless Network

Related Models: DocuPrint M385 z/DocuPrint M375 z

Before configuring your machine, we recommend writing down your wireless network settings. You will need this information before you continue with the configuration.

1. Check and record the current wireless network settings.

Network Name (SSID)

Communication Mode	Authentication Method	Encryption Mode	User ID	Password
Infrastructure	LEAP	CKIP		
	EAP-FAST/NONE	AES		
		TKIP		
	EAP-FAST/MS-CHAPv2	AES		
		TKIP		
	EAP-FAST/GTC	AES		
		TKIP		
	PEAP/MS-CHAPv2	AES		
		TKIP		
	PEAP/GTC	AES		
		TKIP		
	EAP-TTLS/CHAP	AES		
		TKIP		
	EAP-TTLS/MS-CHAP	AES		
		TKIP		
	EAP-TTLS/MS-CHAPv2	AES		
		TKIP		
	EAP-TTLS/PAP	AES		
		TKIP		
	EAP-TLS	AES		
TKIP				-

For example:

Network Name (SSID)
HELLO

Communication Mode	Authentication Method	Encryption Mode	User ID	Password
Infrastructure	EAP-FAST/MS-CHAPv2	AES	Fuji Xerox	12345678



-
- If you configure your machine using EAP-TLS authentication, you must install the client certificate issued by a CA before you start configuration. Contact your network administrator about the client certificate. If you have installed more than one certificate, we recommend writing down the certificate name you want to use.
 - If you verify your machine using the common name of the server certificate, we recommend writing down the common name before you start configuration. Contact your network administrator about the common name of the server certificate.
-

2. Press [] [Settings] > [All Settings] > [Network] > [WLAN] > [Setup Wizard].
3. When [Enable WLAN?] appears, press [Yes].
This will start the wireless setup wizard. To cancel, press [No].
4. The machine will search for your network and display a list of available SSIDs. Swipe up or down or press ▲ or ▼ to display [<New SSID>]. Press [<New SSID>], and then press [OK].
5. Enter the SSID name, and then press [OK].
6. Press [Infrastructure] when instructed.
7. Select the Authentication Method.
8. Do one of the following:
 - If you selected the [LEAP] option, enter the user ID, and then press [OK]. Enter the Password, and then press [OK].
 - If you selected the [EAP-FAST], [PEAP] or [EAP-TTLS] option, select the Inner Authentication method [NONE], [CHAP], [MS-CHAP], [MS-CHAPv2], [GTC] or [PAP].



Depending on your Authentication method, the Inner Authentication method selections differ.

Select the encryption type [TKIP+AES] or [AES].

Select the verification method [No Verification], [CA] or [CA + Server ID].

- If you selected the [CA + Server ID] option, enter the server ID, user ID and password (if required), and then press [OK] for each option.
- For other selections, enter the user ID and Password, and then press [OK] for each option.



If you have not imported a CA certificate into your machine, the machine displays [No Verification].

- If you selected the [EAP-TLS] option, select the encryption type [TKIP+AES] or [AES]. The machine will display a list of available Client Certificates, and then select the certificate. Select the verification method [No Verification], [CA] or [CA + Server ID].
 - If you selected the [CA + Server ID] option, enter the server ID and user ID, and then press [OK] for each option.
 - For other selections, enter the user ID, and then press [OK].



If you have not imported a CA certificate into your machine, the machine displays [No Verification].

9. The machine attempts to connect to the wireless device you have selected.

If your wireless device is connected successfully, the machine's LCD displays [Connected].

You have completed the wireless network setup. To install drivers and software necessary for operating your device, insert the Fuji Xerox installation disc to your computer or go to the download page for your model on the Fuji Xerox website at <http://www.fujixerox.com>.



Related Information

- [Additional Methods of Configuring Your Fuji Xerox Machine for a Wireless Network](#)

Related Topics

- [Wireless LAN Report Error Codes](#)
-

Use Wi-Fi Direct®

- [Print or Scan from Your Mobile Device Using Wi-Fi Direct](#)
- [Configure Your Wi-Fi Direct Network](#)
- [I Cannot Complete the Wireless Network Setup Configuration](#)

Print or Scan from Your Mobile Device Using Wi-Fi Direct

Related Models: DocuPrint M385 z/DocuPrint M375 z

Wi-Fi Direct is one of the wireless configuration methods developed by the Wi-Fi Alliance®. It allows you to configure a secured wireless network between your Fuji Xerox machine and a mobile device, such as an Android™ device, Windows Phone® device, iPhone™, iPod touch, or iPad, without using an access point. Wi-Fi Direct supports wireless network configuration using the one-push or PIN Method of Wi-Fi Protected Setup™ (WPS). You can also configure a wireless network by manually setting an SSID and password. Your Fuji Xerox machine's Wi-Fi Direct feature supports WPA2™ security with AES encryption.

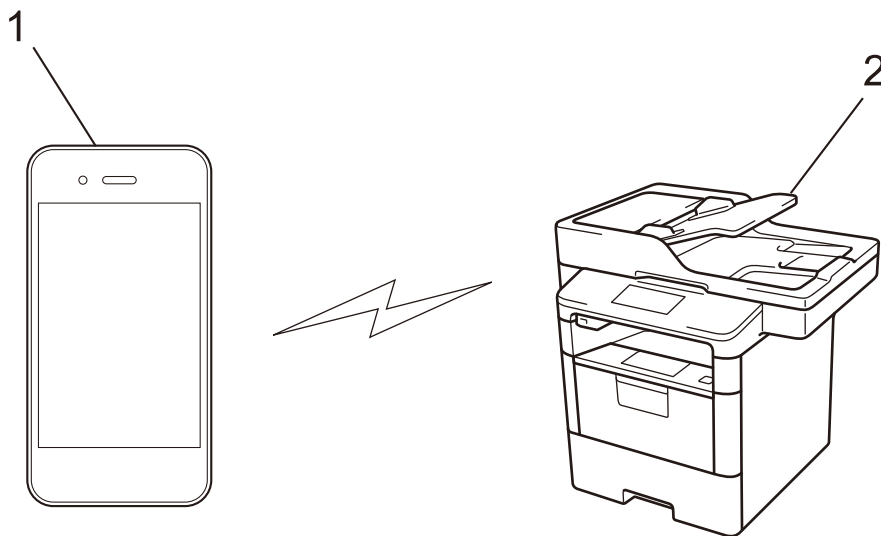

1. Mobile device
2. Your Fuji Xerox machine



- Although the Fuji Xerox machine can be used in both a wired and wireless network, only one connection method can be used at a time. However, a wireless network connection and Wi-Fi Direct connection, or a wired network connection (supported models only) and Wi-Fi Direct connection can be used at the same time.
- The Wi-Fi Direct-supported device can become a Group Owner (G/O). When configuring the Wi-Fi Direct network, the G/O serves as an access point.
- Ad-hoc mode and Wi-Fi Direct cannot be used at the same time. Disable one function to enable the other. If you want to use Wi-Fi Direct while you are using Ad-hoc mode, set Network I/F to Wired LAN or disable Ad-hoc mode and connect your Fuji Xerox machine to the access point.



Related Information

- [Use Wi-Fi Direct®](#)

Configure Your Wi-Fi Direct Network

Configure your Wi-Fi Direct network settings from your machine's control panel.

- [Wi-Fi Direct Network Configuration Overview](#)
- [Configure Your Wi-Fi Direct Network Using the One-Push Method](#)
- [Configure Your Wi-Fi Direct Network Using the One-Push Method of Wi-Fi Protected Setup™ \(WPS\)](#)
- [Configure Your Wi-Fi Direct Network Using the PIN Method](#)
- [Configure Your Wi-Fi Direct Network Using the PIN Method of Wi-Fi Protected Setup™ \(WPS\)](#)
- [Configure Your Wi-Fi Direct Network Manually](#)

Wi-Fi Direct Network Configuration Overview

Related Models: DocuPrint M385 z/DocuPrint M375 z

The following instructions offer five methods for configuring your Fuji Xerox machine in a wireless network environment. Select the method you prefer for your environment.

Check your mobile device for configuration.

1. Does your mobile device support Wi-Fi Direct?

Option	Description
Yes	Go to Step 2
No	Go to Step 3

2. Does your mobile device support one-push configuration for Wi-Fi Direct?

Option	Description
Yes	See <i>Related Information</i> : Configure Your Wi-Fi Direct Network Using the One-Push Method.
No	See <i>Related Information</i> : Configure Your Wi-Fi Direct Network Using the PIN Method.

3. Does your mobile device support Wi-Fi Protected Setup™ (WPS)?

Option	Description
Yes	Go to Step 4
No	See <i>Related Information</i> : Configure Your Wi-Fi Direct Network Manually.

4. Does your mobile device support one-push configuration for Wi-Fi Protected Setup™ (WPS)?

Option	Description
Yes	See <i>Related Information</i> : Configure Your Wi-Fi Direct Network Using the One-Push Method of Wi-Fi Protected Setup™ (WPS).
No	See <i>Related Information</i> : Configure Your Wi-Fi Direct Network Using the PIN Method of Wi-Fi Protected Setup™ (WPS).

To use Fuji Xerox iPrint&Scan functionality in a Wi-Fi Direct network configured by one-push configuration using Wi-Fi Direct or by PIN Method configuration using Wi-Fi Direct, the device you use to configure Wi-Fi Direct must be running Android™ 4.0 or greater.



Related Information

- [Configure Your Wi-Fi Direct Network](#)

Related Topics

- [Configure Your Wi-Fi Direct Network Using the One-Push Method](#)
- [Configure Your Wi-Fi Direct Network Using the One-Push Method of Wi-Fi Protected Setup™ \(WPS\)](#)
- [Configure Your Wi-Fi Direct Network Using the PIN Method](#)
- [Configure Your Wi-Fi Direct Network Using the PIN Method of Wi-Fi Protected Setup™ \(WPS\)](#)
- [Configure Your Wi-Fi Direct Network Manually](#)

Configure Your Wi-Fi Direct Network Using the One-Push Method

Related Models: DocuPrint M385 z/DocuPrint M375 z

If your mobile device supports Wi-Fi Direct, follow these steps to configure a Wi-Fi Direct network.



When the machine receives the Wi-Fi Direct request from your mobile device, the message [Wi-Fi Direct connection request received. Press [OK] to connect.] will appear on the LCD. Press [OK] to connect.

1. Press [] [Settings] > [All Settings] > [Network] > [Wi-Fi Direct] > [Push Button].
2. Activate Wi-Fi Direct on your mobile device (see your mobile device's user's guide for instructions) when [Activate Wi-Fi Direct on other device. Then Press [OK].] appears on the machine's LCD. Press [OK] on your machine.

This will start the Wi-Fi Direct setup. To cancel, press .

3. Do one of the following:
 - When your Fuji Xerox machine is the Group Owner (G/O), connect your mobile device to the machine directly.
 - When your Fuji Xerox machine is not the G/O, it displays available device names with which to configure a Wi-Fi Direct network. Select the mobile device you want to connect to. Search for available devices again by pressing [Rescan].
4. If your mobile device connects successfully, the machine's LCD displays [Connected]. You have completed the Wi-Fi Direct network setup.



Related Information

- [Configure Your Wi-Fi Direct Network](#)

Related Topics

- [Wi-Fi Direct Network Configuration Overview](#)



Configure Your Wi-Fi Direct Network Using the One-Push Method of Wi-Fi Protected Setup™ (WPS)

Related Models: DocuPrint M385 z/DocuPrint M375 z

If your mobile device supports WPS (PBC; Push Button Configuration), follow these steps to configure a Wi-Fi Direct network.



When the machine receives the Wi-Fi Direct request from your mobile device, the message [Wi-Fi Direct connection request received. Press [OK] to connect.] will appear on the LCD. Press [OK] to connect.

1. Press [] [Settings] > [All Settings] > [Network] > [Wi-Fi Direct] > [Group Owner].
2. Press [On].
3. Swipe up or down or press ▲ or ▼ to select the [Push Button] option. Press [Push Button].
4. Activate your mobile device's WPS one-push configuration method (see your mobile device's user's guide for instructions) when [Activate Wi-Fi Direct on other device. Then Press [OK].] appears on the machine's LCD. Press [OK] on your Fuji Xerox machine.
This will start the Wi-Fi Direct setup. To cancel, press .
5. If your mobile device connects successfully, the machine's LCD displays [Connected]. You have completed the Wi-Fi Direct network setup.



Related Information

- [Configure Your Wi-Fi Direct Network](#)

Related Topics

- [Wi-Fi Direct Network Configuration Overview](#)

Configure Your Wi-Fi Direct Network Using the PIN Method

Related Models: DocuPrint M385 z/DocuPrint M375 z

If your mobile device supports the PIN Method of Wi-Fi Direct, follow these steps to configure a Wi-Fi Direct network:



When the machine receives the Wi-Fi Direct request from your mobile device, the message [Wi-Fi Direct connection request received. Press [OK] to connect.] will appear on the LCD. Press [OK] to connect.

1. Press [] [Settings] > [All Settings] > [Network] > [Wi-Fi Direct] > [PIN Code].
2. Activate Wi-Fi Direct on your mobile device (see your mobile device's user's guide for instructions) when [Activate Wi-Fi Direct on other device. Then Press [OK].] appears on the machine's LCD. Press [OK] on your machine.
This will start the Wi-Fi Direct setup. To cancel, press .
3. Do one of the following:
 - When your Fuji Xerox machine is the Group Owner (G/O), it will wait for a connection request from your mobile device. When [PIN Code] appears, enter the PIN displayed on your mobile device in the machine. Press [OK] to complete the setup.
If the PIN is displayed on your Fuji Xerox machine, enter the PIN in your mobile device.
 - When your Fuji Xerox machine is not the G/O, it displays available device names with which to configure a Wi-Fi Direct network. Select the mobile device you want to connect to. Search for available devices again by pressing [Rescan].
4. Do one of the following:
 - Press [Display PIN Code] to display the PIN on your machine and enter the PIN in your mobile device. Go to the next step.
 - Press [Input PIN Code] to enter the PIN displayed on your mobile device in the machine, and then press [OK]. Go to the next step.
If your mobile device does not display a PIN, press on your Fuji Xerox machine. Go back to the first step and try again.
5. If your mobile device connects successfully, the machine's LCD displays [Connected]. You have completed the Wi-Fi Direct network setup.



Related Information

- [Configure Your Wi-Fi Direct Network](#)

Related Topics

- [Wi-Fi Direct Network Configuration Overview](#)



Configure Your Wi-Fi Direct Network Using the PIN Method of Wi-Fi Protected Setup™ (WPS)

Related Models: DocuPrint M385 z/DocuPrint M375 z

If your mobile device supports the PIN Method of Wi-Fi Protected Setup™ (WPS), follow these steps to configure a Wi-Fi Direct network.



When the machine receives the Wi-Fi Direct request from your mobile device, the message [Wi-Fi Direct connection request received. Press [OK] to connect.] will appear on the LCD. Press [OK] to connect.

1. Press [] [Settings] > [All Settings] > [Network] > [Wi-Fi Direct] > [Group Owner].
2. Press [On].
3. Swipe up or down or press ▲ or ▼ to select the [PIN Code] option. Press [PIN Code].
4. When [Activate Wi-Fi Direct on other device. Then Press [OK].] appears, activate your mobile device's WPS PIN configuration method (see your mobile device's user's guide for instructions) and then press [OK] on your Fuji Xerox machine.
This will start the Wi-Fi Direct setup. To cancel, press .
5. The machine will wait for a connection request from your mobile device. When [PIN Code] appears, enter the PIN displayed on your mobile device in to the machine. Press [OK].
6. If your mobile device connects successfully, the machine's LCD displays [Connected]. You have completed the Wi-Fi Direct network setup.



Related Information

- [Configure Your Wi-Fi Direct Network](#)

Related Topics

- [Wi-Fi Direct Network Configuration Overview](#)

Configure Your Wi-Fi Direct Network Manually

Related Models: DocuPrint M385 z/DocuPrint M375 z

If your mobile device does not support Wi-Fi Direct or WPS, you must configure a Wi-Fi Direct network manually.



When the machine receives the Wi-Fi Direct request from your mobile device, the message [Wi-Fi Direct connection request received. Press [OK] to connect.] will appear on the LCD. Press [OK] to connect.

1. Press [] [Settings] > [All Settings] > [Network] > [Wi-Fi Direct] > [Manual].
2. The machine will display the SSID name and Password for two minutes. Go to your mobile device's wireless network settings screen, select the SSID name, and then enter the password.
3. If your mobile device connects successfully, the machine's LCD displays [Connected]. You have completed the Wi-Fi Direct network setup.



Related Information

- [Configure Your Wi-Fi Direct Network](#)

Related Topics

- [Wi-Fi Direct Network Configuration Overview](#)

Advanced Network Features

- [Print the Network Configuration Report](#)
- [Configure Your Mail Server Settings Using Web Based Management](#)
- [Configure the Fuji Xerox Machine for Email or Internet Fax \(I-Fax\)](#)
- [I-Fax Options](#)
- [Use the Send Fax to Server Feature](#)
- [Print the WLAN Report](#)
- [Configure and Operate LDAP Search](#)
- [Synchronize Time with the SNTP Server Using Web Based Management](#)

Print the Network Configuration Report

The Network Configuration Report lists the network configuration, including the network print server settings.



- **Node Name:** The Node Name appears on the current Network Configuration Report. The default Node Name is "FXxxxxxxxxxxx" (where "xxxxxxxxxxx" is your machine's MAC Address / Ethernet Address.)
- If the [IP Address] on the Network Configuration Report shows 0.0.0.0, wait for one minute and try printing it again.
- You can find your machine's settings, such as the IP address, subnet mask, node name, and MAC Address on the report, for example:
 - IP address: 192.0.2.1
 - Subnet mask: 255.255.255.0
 - Node name: FX000ca0000499
 - MAC Address: 00-0c-a0-00-04-99

1. Press [] [Settings] > [All Settings] > [Print Reports] > [Network Configuration].
2. Press [Yes].



Related Information

- [Advanced Network Features](#)

Related Topics

- [Where Can I Find My Fuji Xerox Machine's Network Settings?](#)
- [Use the Network Connection Repair Tool \(Windows®\)](#)
- [I Want to Check that My Network Devices are Working Correctly](#)
- [Access Web Based Management](#)
- [Configure the Gigabit Ethernet Settings Using Web Based Management](#)

Configure Your Mail Server Settings Using Web Based Management

Related Models: DocuPrint M385 z/DocuPrint M375 z

Use Web Based Management to configure your Fuji Xerox machine to connect with your mail server.

1. Start your web browser.
2. Type "http://machine's IP address" in your browser's address bar (where "machine's IP address" is the machine's IP address).
For example:
http://192.0.2.1
3. Type a password, and then click . The default password is "x-admin". To ensure security, it is important you change the password.
4. Click the **Network** tab.
5. Click **Protocol** in the left navigation bar.
6. In the **POP3/IMAP4/SMTP** field, click **Advanced Settings** and make sure the **Status** is **Enabled**.

POP3/IMAP4/SMTP



Status Enabled

Send E-mail Settings(SMTP)

Server Address	<input type="text" value="0.0.0.0"/>
Port	<input type="text" value="25"/>
Server Authentication Method	<input checked="" type="radio"/> None <input type="radio"/> SMTP-AUTH
SMTP-AUTH Account Name	<input type="text"/>
SMTP-AUTH Account Password	<input type="text" value="Enter password"/> <input type="text" value="Retype password"/>
SSL/TLS	<input checked="" type="radio"/> None <input type="radio"/> SSL <input type="radio"/> TLS <input type="checkbox"/> Verify Server Certificate
Device E-mail Address	<input type="text" value="fxnxxxxxxxxxxxxx@example.com"/>

Receive E-mail Settings(POP3/IMAP4)

Protocol	<input checked="" type="radio"/> POP3 <input type="radio"/> IMAP4
Server Address	<input type="text" value="0.0.0.0"/>
Port	<input type="text" value="110"/>
Mailbox Name	<input type="text"/>
Mailbox Password	<input type="text" value="Enter password"/> <input type="text" value="Retype password"/>
	<input type="checkbox"/> Use APOP (POP3 Only)
Select Mail Folder Name(IMAP4 Only)	<input checked="" type="radio"/> Default(Inbox) <input type="radio"/> Specified : <input type="text"/>
SSL/TLS	<input checked="" type="radio"/> None <input type="radio"/> SSL <input type="radio"/> TLS <input type="checkbox"/> Verify Server Certificate
Segmented Message Timeout	<input type="text" value="120"/> minute(s)

[I-Fax>>](#)

[CA Certificate>>](#)

[E-mail report>>](#)

[Notification>>](#)

-
7. Select the mail server you want to configure.
 8. Enter the necessary settings for the mail server.



If you select the **IMAP4** option, you must enter the full path of the mail folder using single byte characters only, and then enter "Inbox" for the root mail folder.

9. When finished, click **Submit**.
The **Test Send/Receive E-mail Configuration** dialog box appears.
10. Follow the instructions in the dialog box to test the current settings.



Related Information

- [Advanced Network Features](#)
-

Configure the Fuji Xerox Machine for Email or Internet Fax (I-Fax)

Related Models: DocuPrint M385 z/DocuPrint M375 z

Before using I-Fax, configure your Fuji Xerox machine to communicate with your network and mail server. You can configure these items using the machine's control panel, Web Based Management, or Remote setup. Make sure the following items are configured on your machine:

- IP address (If you are already using your machine on your network, the machine's IP address has been configured correctly.)
- Email address
- SMTP, POP3, IMAP4 server address/port/Authentication method/Encryption method/Server Certificate Verification
- Mailbox name and password

If you are unsure of any of these items, contact your system administrator.



Related Information

- [Advanced Network Features](#)
- [Fax Using the Internet \(I-Fax\)](#)
- [Initial Setup for Email or Internet Fax \(I-Fax\)](#)
- [Send an Internet Fax \(I-Fax\)](#)
- [How Your Fuji Xerox Machine Receives an Internet Fax \(I-Fax\)](#)
- [Poll the Server Manually](#)
- [How Your Computer Receives an I-Fax](#)
- [Forward Received Email and Fax Messages](#)
- [Relay Broadcast](#)

Related Topics

- [I-Fax Options](#)

Fax Using the Internet (I-Fax)

Related Models: DocuPrint M385 z/DocuPrint M375 z

With Internet Fax (I-Fax), you can send and receive fax documents using the Internet as the transport mechanism. Documents are transmitted in email messages as attached TIFF-F files. Your computer can send and receive documents as long as it has an application that can generate and view TIFF-F files. You can use any TIFF-F viewer application. Documents sent via the machine will be converted into a TIFF-F format automatically. If you want to send and receive messages to and from your machine, your computer's email application must support Multipurpose Internet Mail Extensions (MIME).

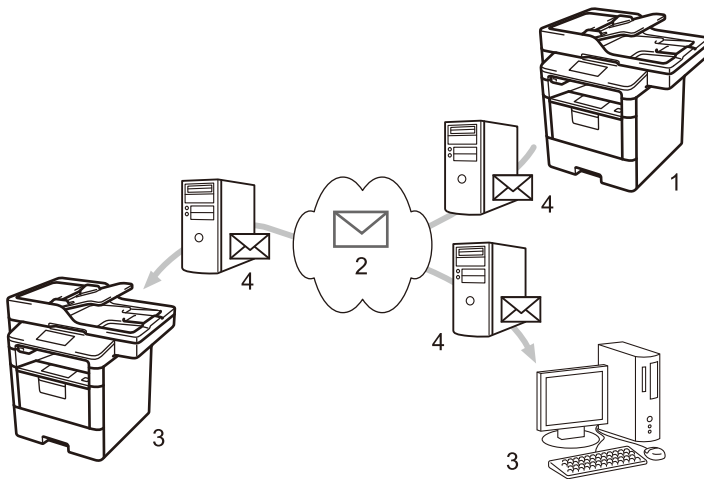

1. Sender
2. Internet
3. Receiver
4. Email server



- I-Fax supports sending and receiving documents in Letter or A4 format and in monochrome only.



Related Information

- [Configure the Fuji Xerox Machine for Email or Internet Fax \(I-Fax\)](#)
 - [Important Information about Internet Fax \(I-Fax\)](#)

Related Topics

- [Forward Received Email and Fax Messages](#)

Important Information about Internet Fax (I-Fax)

Related Models: DocuPrint M385 z/DocuPrint M375 z

I-Fax communication on a LAN is very similar to communication via email; however, it is different from fax communication using standard phone lines. The following is important information for using I-Fax:

- Factors such as the receiver's location, structure of the LAN and how busy the circuit (such as the Internet) is may cause the system to take a longer time than usual to send an error mail.
- When sending confidential documents, we recommend using standard phone lines instead of the Internet (due to its low level of security).
- If the receiver's mail system is not MIME-compatible, you cannot use I-Fax to send documents. If possible, find out in advance, and note that some servers will not send an error reply.
- If a document is too large to send via I-Fax, it may not reach the receiver.
- You cannot change the font or size of the text in any Internet mail you receive.



Related Information

- [Fax Using the Internet \(I-Fax\)](#)

Initial Setup for Email or Internet Fax (I-Fax)

Related Models: DocuPrint M385 z/DocuPrint M375 z

Before sending your I-Fax, use the control panel, Web Based Management, or Remote Setup to configure the following optional items:

- **E-mail Subject**
- **E-mail Message**
- **Size Limit**
- **Request Delivery Notification (Send)**

E-mail Send

E-mail Subject	<input type="text" value="Internet Fax Job"/>
E-mail Message	<input type="text"/>
Size Limit	<input checked="" type="radio"/> Off <input type="radio"/> On
Maximum Size	<input type="text" value="0"/> MB
Request Delivery Notification (Send)	<input checked="" type="radio"/> Off <input type="radio"/> On

[POP3/IMAP4/SMTP>>](#)

If you are unsure of any of these items, contact your system administrator.



Related Information

- [Configure the Fuji Xerox Machine for Email or Internet Fax \(I-Fax\)](#)

Related Topics

- [Forward Received Email and Fax Messages](#)

Send an Internet Fax (I-Fax)



Related Models: DocuPrint M385 z/DocuPrint M375 z

Sending an I-Fax is like sending a normal fax. Make sure that your recipient's information is saved in your email address book, and load the document you want to I-Fax into your Fuji Xerox machine.



- If the computer to which you want to send a document is not running Windows Server® 2008/2012/2012 R2/2016, Windows® 7, Windows® 8, or Windows® 10, ask the computer's owner to install software that can view TIFF-F files.
- To send multiple pages, use the ADF.

1. Load your document.
2. Do one of the following:
 - If Fax Preview is set to [Off], press [Fax].
 - If Fax Preview is set to [On], press [Fax], and then press [Sending Faxes].
3. To change the fax-sending settings, press [Options].
4. Swipe up or down or press ▲ or ▼ to scroll through the fax settings. When the setting you want appears, press it and select your preference. When you have finished changing settings, press [OK].
5. Do one of the following:
 - Press , and then enter the email address using the touchscreen.
 - Press [Address Book], select the email address of your recipient, and then press [Apply].
6. Press [Fax Start].

The machine starts scanning. After the document is scanned, it is transmitted to the recipient via your SMTP server. You can cancel the send operation by pressing  during scanning.
7. Press .



Related Information

- [Configure the Fuji Xerox Machine for Email or Internet Fax \(I-Fax\)](#)

Related Topics

- [How to Enter Text on Your Fuji Xerox Machine](#)

How Your Fuji Xerox Machine Receives an Internet Fax (I-Fax)

Related Models: DocuPrint M385 z/DocuPrint M375 z

When your Fuji Xerox machine receives an incoming I-Fax, it will print the I-Fax automatically. To receive an I-Fax, we recommend using the control panel or Web Based Management to configure the following optional items:

- **Auto Polling**
- **Polling Frequency**
- **Print Mail Header**
- **Delete/Read Receive Error Mail**
- **Send Delivery Notification (Receive)**

E-mail Receive

Auto Polling	<input type="radio"/> Off <input checked="" type="radio"/> On
Polling Frequency	<input type="text" value="10"/> minute(s)
Print Mail Header	<input type="text" value="None"/> ▾
Delete/Read Receive Error Mail	<input type="radio"/> Off <input checked="" type="radio"/> On
Send Delivery Notification (Receive)	<input type="text" value="Off"/> ▾

[POP3/IMAP4/SMTP>>](#)

There are two ways you can receive email messages:

- POP3/IMAP4 receiving at regular intervals
- POP3/IMAP4 receiving, manually initiated

When using POP3/IMAP4 receiving, the machine polls your email server to receive data. Polling can occur at set intervals (for example, you can configure the machine to poll the email server every ten minutes) or you can manually poll the server.



-
- If your machine starts to receive email data, the LCD displays [Receiving]. The email will be printed automatically.
 - If your machine is out of paper when receiving data, the received data will be held in the machine's memory. This data will be printed automatically after paper is reloaded in the paper tray.
 - When the machine's Temporary Fax Backup Function is turned on, received data will be stored for a certain period of time.
 - If the received mail is not in a plain text format, or an attached file is not in the TIFF-F format, the error message **"ATTACHED FILE FORMAT NOT SUPPORTED"** will be printed.
 - If the received mail is too large, the error message **"E-MAIL FILE TOO LARGE"** will be printed.
 - If **Delete/Read Receive Error Mail** is **On** (default), then the error mail will be deleted from the email server automatically.
-



Related Information

- [Configure the Fuji Xerox Machine for Email or Internet Fax \(I-Fax\)](#)

Related Topics

- [Store Incoming Faxes in the Machine's Memory](#)
 - [How Your Computer Receives an I-Fax](#)
 - [Forward Received Email and Fax Messages](#)
-

Poll the Server Manually

Related Models: DocuPrint M385 z/DocuPrint M375 z

1. Press  [Settings] > [All Settings] > [Network] > [E-mail/IFAX] > [Manual POP3 Receive].
2. Press [Yes] to confirm.
3. The LCD displays [Receiving] and your machine will print the data from the email server.



Related Information

- [Configure the Fuji Xerox Machine for Email or Internet Fax \(I-Fax\)](#)

How Your Computer Receives an I-Fax

Related Models: DocuPrint M385 z/DocuPrint M375 z

When your computer receives an I-Fax, you will receive an email in your email application. The incoming I-Fax is attached to an email message that notifies you in its **Subject** line that your email server has received an I-Fax. You can either wait for your Fuji Xerox machine to poll the email server, or you can manually poll the email server to receive the incoming data.



Related Information

- [Configure the Fuji Xerox Machine for Email or Internet Fax \(I-Fax\)](#)

Related Topics

- [How Your Fuji Xerox Machine Receives an Internet Fax \(I-Fax\)](#)

Forward Received Email and Fax Messages

Related Models: DocuPrint M385 z/DocuPrint M375 z

Use Fuji Xerox's I-Fax feature to forward email or standard fax messages to another computer, to a fax machine, or to another I-Fax machine. Enable the Forwarding feature using your machine's control panel.

To enable forwarding using your machine's control panel :

1. Press  [Settings] > [All Settings] > [Fax] > [Setup Receive] > [Memory Receive] > [Fax Forward].
2. Enter the recipient's fax number or email address using the touchscreen.
3. Select the file type you want.
4. Do one of the following:
 - Press [Manual] to enter the forwarding fax number (up to 20 characters) using the LCD. Press [OK].
 - Press [Address Book].
Swipe up or down or press ▲ or ▼ to display to scroll until you find the fax number or email address where you want your faxes to be forwarded.
Press the fax number or email address you want.



Press [Backup Print: On] to print received faxes at your machine so you will have a copy.

5. Press .



Related Information

- [Configure the Fuji Xerox Machine for Email or Internet Fax \(I-Fax\)](#)

Related Topics

- [How to Enter Text on Your Fuji Xerox Machine](#)
 - [Fax Using the Internet \(I-Fax\)](#)
 - [Initial Setup for Email or Internet Fax \(I-Fax\)](#)
 - [How Your Fuji Xerox Machine Receives an Internet Fax \(I-Fax\)](#)
-

Relay Broadcast

Related Models: DocuPrint M385 z/DocuPrint M375 z

A Relay Broadcast is when your Fuji Xerox machine receives a message over the Internet and then relays it to another fax machine using conventional telephone lines. If you must fax a document over a long distance or abroad, use the Relay Broadcast Function to save the communication fee.

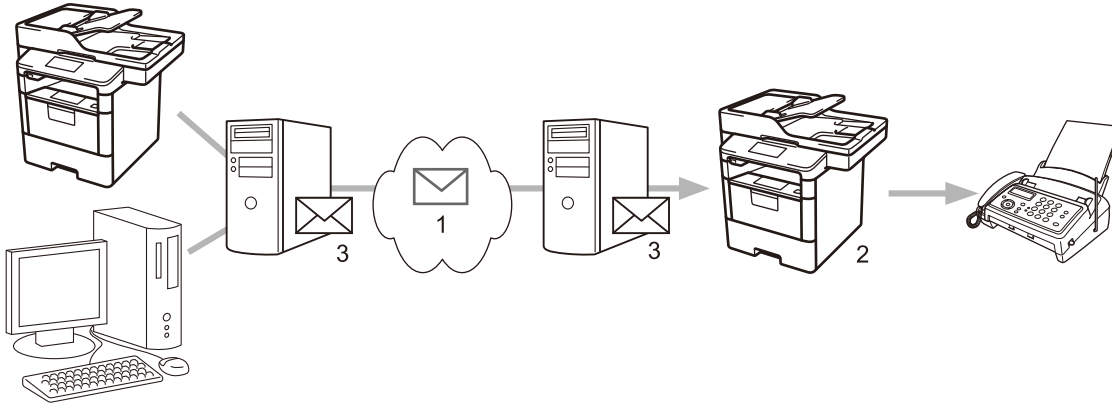

1. The Internet
2. Telephone line
3. Email server

Use the Fuji Xerox machine's control panel or Web Based Management to configure the following items:

- **Relay Broadcast Function**

Set the **Relay Broadcast Function** to **On**.

- **Relay Domain**

Configure your machine's domain name on the machine that will broadcast the document to the conventional fax machine. If you wish to use your machine as a relay broadcast device, you must specify the trusted domain name (the portion of the name after the "@" sign) at the machine. Use care in selecting a trusted domain: any user on a trusted domain will be able to send a relay broadcast. You can register up to ten domain names.

- **Relay Broadcast Report**

Specify whether or not you want a report to print after the machine completes the relay broadcast.

Relay Function

Relay Broadcast Function

Off On

Relay Domain

Relay Broadcast Report

Off On



Related Information

- [Configure the Fuji Xerox Machine for Email or Internet Fax \(I-Fax\)](#)
- [Relay Broadcast from Your Fuji Xerox Machine](#)
- [Relay Broadcast from Your Computer](#)

Relay Broadcast from Your Fuji Xerox Machine

Related Models: DocuPrint M385 z/DocuPrint M375 z

Use the Relay Broadcast Function to send email from your machine to a conventional fax machine.

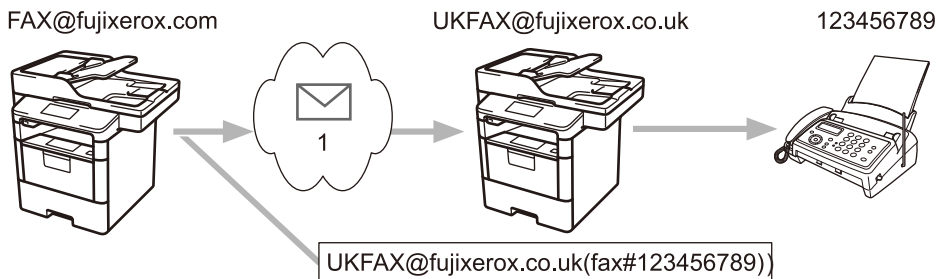

1. The Internet

In this example, your machine's email address is FAX@fujixerox.com and you want to send a document from your machine to a standard fax machine in England with the email address UKFAX@fujixerox.co.uk, and you want your machine to send the document using a conventional telephone line.

1. Load your document.
2. Do one of the following:
 - If Fax Preview is set to [Off], press [Fax].
 - If Fax Preview is set to [On], press [Fax], and then press [Sending Faxes].
3. Press [Options].
4. Swipe up or down or press ▲ or ▼ to display the [Broadcasting] option.
5. Press [Broadcasting].
6. Press [Add Number].
7. You can add email addresses to the broadcast in the following ways:
 - Press [Add Number] and press , enter the email address and press [OK].
 - Press [Add from Address book]. Press the check box of the email address you want to add to the broadcast. After you have selected all the email addresses you want, press [OK].
 - Press [Search in Address book]. Enter the name and press [OK]. The search results will be displayed. Press the name and then press the email address you want to add to the broadcast.

The following is an example of how to enter the email address and phone number:

UKFAX@fujixerox.co.uk(fax#123456789)

email address Fax Phone Number

The word "fax#" must be included with the phone number inside the parenthesis.

After you have entered all of the fax numbers, press [OK].

8. Press [Fax Start].



Related Information

- [Relay Broadcast](#)

Related Topics

- [How to Enter Text on Your Fuji Xerox Machine](#)
-

Relay Broadcast from Your Computer

Related Models: DocuPrint M385 z/DocuPrint M375 z

Use the Relay Broadcast Function to send email from your computer to a conventional fax machine.

Some email applications do not support sending an email to multiple fax numbers. If your email application cannot support multiple fax numbers, you can relay to only one fax machine at a time.

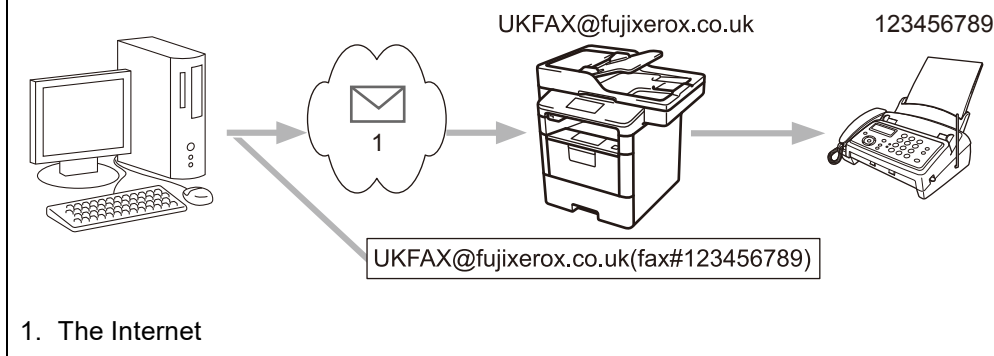

If you are sending an email to a conventional fax machine, the method of entering the fax machine's fax number will vary, depending on the mail application you are using.

1. In your email application, create a new mail message and type the email address of the relay machine and fax number of the first fax machine in the "TO" box.

The following is an example of how to enter the email address and fax number:

UKFAX@fujixerox.co.uk(fax#123456789)

email address Fax Phone Number

The word "fax#" must be included with the phone number inside the parenthesis.



For Microsoft® Outlook®, the address information must be entered into the address book as follows:

Name: fax#123456789

Email address: UKFAX@fujixerox.co.uk

2. Type the email address of the relay machine and fax number of the second fax machine in the "TO" box.
3. Send the email.



Related Information

- [Relay Broadcast](#)

I-Fax Options

- [Internet Fax \(I-Fax\) Verification Mail](#)
- [Error Mail](#)
- [Configure the Fuji Xerox Machine for Email or Internet Fax \(I-Fax\)](#)

Internet Fax (I-Fax) Verification Mail

Related Models: DocuPrint M385 z/DocuPrint M375 z

- Verification Mail for sending allows you to request notification from the receiving station where your I-Fax or email was received and processed.
- Verification Mail for receiving allows you to transmit a default report back to the sending station after successfully receiving and processing an I-Fax or email.

To use this feature, set the [Notification] options in the [Setup Mail RX] and [Setup Mail TX] options of your Fuji Xerox machine's control panel menu.



Related Information

- [I-Fax Options](#)
 - [Enable Send Notifications for TX Verification Mail](#)
 - [Enable Receive Notification for TX Verification Mail](#)

Enable Send Notifications for TX Verification Mail

Related Models: DocuPrint M385 z/DocuPrint M375 z

1. Press  [Settings] > [All Settings] > [Network] > [E-mail/IFAX] > [Setup Mail TX] > [Notification].
2. Select [On] or [Off] to enable or disable the Send Notification feature.
When Send Notification is On, the fax includes an additional field, named Message Disposition Notification (MDN), that contains message delivery information. By default, Send Notification is set to Off.



Your fax recipient's machine must support the MDN field in order to send a notification report.

3. Press .



Related Information

- [Internet Fax \(I-Fax\) Verification Mail](#)

Enable Receive Notification for TX Verification Mail

Related Models: DocuPrint M385 z/DocuPrint M375 z

1. Press  [Settings] > [All Settings] > [Network] > [E-mail/IFAX] > [Setup Mail RX] > [Notification].
2. Press one of the three possible settings:

Option	Description
Receive Notification On	When Receive Notification is On, a template is sent back to the sender to indicate successful reception and processing of the message. These templates depend on the operation requested by the sender. Example: SUCCESS: Received From <Mail Address>
Receive Notification MDN	When Receive Notification is MDN, a report to indicate successful reception and processing is sent back to the sender if the originating station sent a request confirmation to the MDN (Message Disposition Notification) field.
Receive Notification Off	When Receive Notification is Off, all forms of receive notification are disabled and no message is sent back to the sender regardless of the request.



- To send TX Verification Mail, the Sender must configure these settings:
 - Switch [Notification] in [Setup Mail TX] to [On].
 - Switch [Header] in [Setup Mail RX] to [All] or [Subject+From+To].
- To receive TX Verification Mail, the Receiver must configure these settings:
 - Switch [Notification] in [Setup Mail RX] to [On].

3. Press .



Related Information

- [Internet Fax \(I-Fax\) Verification Mail](#)

Error Mail

Related Models: DocuPrint M385 z/DocuPrint M375 z

If there is a delivery error while sending an I-Fax, the mail server will send an error message back to the Fuji Xerox machine and the error message will be printed.

If there is an error while receiving an I-Fax, an error message will be printed, for example, "The message being sent to the machine was not in a TIFF-F format."

To receive the error mail and have it print on your machine, in [Setup Mail RX], switch the [Header] option to [All] or to [Subject+From+To].



Related Information

- [I-Fax Options](#)

Use the Send Fax to Server Feature

Related Models: DocuPrint M385 z/DocuPrint M375 z

The Fax to Server feature allows the machine to scan a document and send it over the network to a separate fax server. The document will then be sent from the server as fax data to the destination fax number over standard phone lines. When the Fax to Server feature is set to On, all automatic fax transmissions from the machine will be sent to the fax server for fax transmission.

You can send a fax directly from the machine using the manual fax feature when the Send to Server feature is on.





Related Information

- [Advanced Network Features](#)
- [Before Sending a Fax to the Fax Server](#)
- [Enable Fax to Server](#)
- [Operate Fax to Server](#)

Enable Fax to Server

Related Models: DocuPrint M385 z/DocuPrint M375 z

- Store the prefix/suffix address for the fax server in your Fuji Xerox machine.

1. Press [] [Settings] > [All Settings] > [Network] > [Fax to Server].
2. Press [Fax to Server].
3. Press [On].
4. Press [Prefix].
5. Enter the prefix using the touchscreen, and then press [OK].
6. Press [Suffix].
7. Enter the suffix using the touchscreen, and then press [OK].
8. Press [.



Related Information

- [Use the Send Fax to Server Feature](#)

Operate Fax to Server

Related Models: DocuPrint M385 z/DocuPrint M375 z

1. Place the document in the ADF or on the scanner glass.
2. Enter the fax number.
3. Press [Fax Start].

The machine will send the message over a TCP/IP network to the fax server.





Related Information

- [Use the Send Fax to Server Feature](#)

Print the WLAN Report

Related Models: DocuPrint M385 z/DocuPrint M375 z

The WLAN Report reflects your machine's wireless status. If the wireless connection fails, check the error code on the printed report.

1. Press  [Settings] > [All Settings] > [Print Reports] > [WLAN Report].
2. Press [Yes].
The machine will print the WLAN Report.
3. Press .

If the WLAN Report does not print, check your machine for errors. If there are no visible errors, wait for one minute and then try to print the report again.



Related Information

- [Advanced Network Features](#)
- [Wireless LAN Report Error Codes](#)

Related Topics

- [My Fuji Xerox Machine Cannot Print, Scan, or PC-FAX Receive over the Network](#)
- [I Want to Check that My Network Devices are Working Correctly](#)

Wireless LAN Report Error Codes

Related Models: DocuPrint M385 z/DocuPrint M375 z

If the Wireless LAN Report shows that the connection failed, check the error code on the printed report and see the corresponding instructions in the table:

Error Code	Problem and Recommended Solutions
TS-01	<p>The wireless setting is not activated, change the wireless setting to ON.</p> <p>If a network cable is connected to your machine, disconnect it and change the wireless setting of your machine to ON.</p>
TS-02	<p>The wireless access point/router cannot be detected.</p> <ol style="list-style-type: none"> Check the following two points: <ul style="list-style-type: none"> Unplug the power to your wireless access point/router, wait for 10 seconds, and then plug it back in. If your WLAN access point/router is using MAC address filtering, confirm that the MAC address of the Fuji Xerox machine is allowed in the filter. If you manually entered the SSID and security information (SSID/authentication method/encryption method/Network Key), the information may be incorrect. <p>Reconfirm the SSID and security information and re-enter the correct information as necessary.</p> <p>How to confirm wireless security information (SSID/authentication method/encryption method/Network Key)</p> <ol style="list-style-type: none"> The Default security settings may be provided on a label attached to the WLAN access point/router. Or the manufacturer's name or model no. of the WLAN access point/router may be used as the default security settings. See the documentation provided with your WLAN access point/router for information on how to find the security settings. <ul style="list-style-type: none"> If WLAN access point/router is set to not broadcast the SSID, the SSID will not automatically be detected. You will have to manually enter the SSID name. The Network key may also be described as the Password, Security Key or Encryption Key. <p>This device does not support a 5GHz SSID/ESSID and you must select a 2.4 GHz SSID/ESSID. Make sure the access point/router is set to 2.4 GHz or 2.4 GHz/5 GHz mixed mode.</p> <p>If you do not know the SSID and wireless security settings of your WLAN access point/router or how to change the configuration, see the documentation provided with your WLAN access point/router, ask the manufacturer of your access point/router or ask to your Internet provider or network administrator.</p>
TS-03	<p>The wireless network and security setting you entered may be incorrect. Reconfirm the wireless network settings.</p> <p>If you do not know this information, ask your network administrator.</p>

Error Code	Problem and Recommended Solutions
TS-04	<p>The Authentication/Encryption methods used by the selected wireless access point/router are not supported by your machine.</p> <p>For infrastructure mode, change the authentication and encryption methods of the wireless access point/router. Your machine supports the following authentication methods:</p> <ul style="list-style-type: none"> • WPA-Personal TKIP or AES • WPA2-Personal AES • Open WEP or None (without encryption) • Shared key WEP <p>If your problem is not solved, the SSID or network settings you entered may be incorrect. Confirm the wireless network settings.</p> <p>For Ad-Hoc Mode, change the authentication and encryption methods of your computer for the wireless setting. Your machine supports Open authentication only, with optional WEP encryption.</p>
TS-05	<p>The security information (SSID/Network Key) is incorrect.</p> <p>Confirm the SSID and Network Key. If your router uses WEP encryption, enter the key used as the first WEP key. Your Fuji Xerox machine supports the use of the first WEP key only.</p>
TS-06	<p>The wireless security information (Authentication method/Encryption method/Network Key) is incorrect.</p> <p>Confirm the wireless security information (Authentication method/Encryption method/Network Key) listed in TS-04. If your router uses WEP encryption, enter the key used as the first WEP key. Your Fuji Xerox machine supports the use of the first WEP key only.</p>
TS-07	<p>The machine cannot detect a WLAN access point/router that has WPS enabled.</p> <p>If you would like to connect with WPS, you must operate both your machine and the WLAN access point/router. Confirm the connection method for WPS on WLAN access point/router and try starting again.</p> <p>If you do not know how to operate your WLAN access point/router using WPS, see the documentation provided with your WLAN access point/router, ask the manufacturer of your WLAN access point/router or ask your network administrator.</p>
TS-08	<p>Two or more WLAN access points that have WPS enabled are detected.</p> <ul style="list-style-type: none"> • Confirm that only one WLAN access point/router within range has the WPS method active and try again. • Try starting again after few minutes in order to avoid effects from other access points.



Related Information

- [Print the WLAN Report](#)

Related Topics

- [My Fuji Xerox Machine Cannot Print, Scan, or PC-FAX Receive over the Network](#)
- [I Want to Check that My Network Devices are Working Correctly](#)
- [Configure Your Machine for a Wireless Network Using the One Push Method of Wi-Fi Protected Setup™ \(WPS\)](#)
- [Configure Your Machine for a Wireless Network Using the PIN Method of Wi-Fi Protected Setup™ \(WPS\)](#)
- [Configure Your Machine for a Wireless Network in Ad-Hoc Mode Using an Existing SSID](#)
- [Configure Your Machine for a Wireless Network in Ad-Hoc Mode Using a New SSID](#)
- [Configure Your Machine for a Wireless Network Using the Machine's Control Panel Setup Wizard](#)
- [Configure Your Machine for a Wireless Network When the SSID Is Not Broadcast](#)
- [Configure Your Machine for an Enterprise Wireless Network](#)

Configure and Operate LDAP Search

Related Models: DocuPrint M385 z/DocuPrint M375 z

The LDAP feature allows you to search for information, such as fax numbers and email addresses, on your server. When you use the Fax, I-Fax, or Scan to Email server feature, you can use the LDAP search to find fax numbers or email addresses.



- The LDAP feature does not support simplified Chinese, traditional Chinese, or Korean.
- The LDAP feature supports LDAPv3.
- The LDAP feature does not support SSL/TLS.



Related Information

- [Advanced Network Features](#)
- [Change LDAP Configuration Using Web Based Management](#)
- [Perform an LDAP Search Using Your Machine's Control Panel](#)

Change LDAP Configuration Using Web Based Management

Related Models: DocuPrint M385 z/DocuPrint M375 z

Use Web Based Management to configure your LDAP settings in a web browser.

1. Start your web browser.
2. Type "http://machine's IP address" in your browser's address bar (where "machine's IP address" is the machine's IP address).
For example:
http://192.0.2.1
3. Type a password, and then click . The default password is "x-admin". To ensure security, it is important you change the password.
4. Click **Network** on the machine's web page.
5. Click **Protocol** in the left navigation bar.
6. Select the **LDAP** check box, and then click **Submit**.
7. Restart your Fuji Xerox machine to activate the configuration.
8. On your computer, in Web Based Management's **Address Book** tab, select **LDAP** in the left navigation bar.

- **LDAP Search**
- **LDAP Server Address**
- **Port** (The default port number is 389.)
- **Search Root**
- **Authentication**
- **Username**
This selection will be available depending on the authentication method used.
- **Password**
This selection will be available depending on the authentication method used.



- If the LDAP server supports Kerberos authentication, we recommend selecting Kerberos for the Authentication settings. It provides strong authentication between the LDAP server and your machine.
- You must configure the SNTP protocol (network time server), or you must set the date, time and time zone correctly on the control panel for Kerberos authentication.

- **Kerberos Server Address**
This selection will be available depending on the authentication method used.
- **Timeout for LDAP**
- **Attribute of Name (Search Key)**
- **Attribute of E-mail**
- **Attribute of Fax Number**

9. When finished, click **Submit**. Make sure the **Status** field reads **OK**.



Related Information

- [Configure and Operate LDAP Search](#)

Related Topics

- [Synchronize Time with the SNTP Server Using Web Based Management](#)

Perform an LDAP Search Using Your Machine's Control Panel

Related Models: DocuPrint M385 z/DocuPrint M375 z

After you configure LDAP settings, you can use the LDAP search feature to find fax numbers or email addresses to use for:

- Sending a Fax
- Sending an Internet Fax (I-Fax)
- Scanning to Email Server



- The LDAP feature supports LDAPv3.
- The LDAP feature does not support SSL/TLS.
- You may need to use Kerberos Authentication or Simple Authentication to connect to your LDAP server, depending on the security policy set by your network administrator.
- You must configure the SNTP protocol (network time server), or you must set the date, time and time zone correctly on the control panel for Kerberos authentication.

1. Press  to search.
2. Enter the initial characters for your search using the LCD.
3. Press [OK].

The LDAP search result will be shown on the LCD; the  icon appears before the email (local) address book search results.

- If there is no match on the server or the email (local) address book, the LCD displays [Results cannot be found.] for about 60 seconds.
4. Swipe up or down or press ▲ or ▼ to display the name you want.
 5. Press the name.
To view the details of the name, press [Detail].
 6. If the result includes more than one fax number or email address, the machine will prompt you to select just one. Press [Apply]. Do one of the following:
 - If you are sending a fax or an I-Fax, press [Fax Start].
 - If you are scanning to the Email Server, load your document, press [Next], and then press [Start].



Related Information

- [Configure and Operate LDAP Search](#)

Related Topics

- [Synchronize Time with the SNTP Server Using Web Based Management](#)

Synchronize Time with the SNTP Server Using Web Based Management

The Simple Network Time Protocol (SNTP) is used to synchronize the time used by the machine for authentication with the SNTP time server. (This is not the time displayed on the machine's LCD.) You can automatically or manually synchronize the machine's time with the Coordinated Universal Time (UTC) provided by the SNTP time server.

- [Configure Date and Time Using Web Based Management](#)
- [Configure the SNTP Protocol Using Web Based Management](#)
- [Configure the Store Print Log to Network Settings Using Web Based Management](#)
- [Change LDAP Configuration Using Web Based Management](#)
- [Perform an LDAP Search Using Your Machine's Control Panel](#)

Configure Date and Time Using Web Based Management

Configure date and time to synchronize the time used by the machine with the SNTP time server.

This feature is not available in some countries.

1. Start your web browser.
2. Type "http://machine's IP address" in your browser's address bar (where "machine's IP address" is the machine's IP address).
For example:
http://192.0.2.1
3. Type a password, and then click . The default password is "x-admin". To ensure security, it is important you change the password.
4. Click the **Administrator** tab.
5. Click **Date&Time** in the left navigation bar.

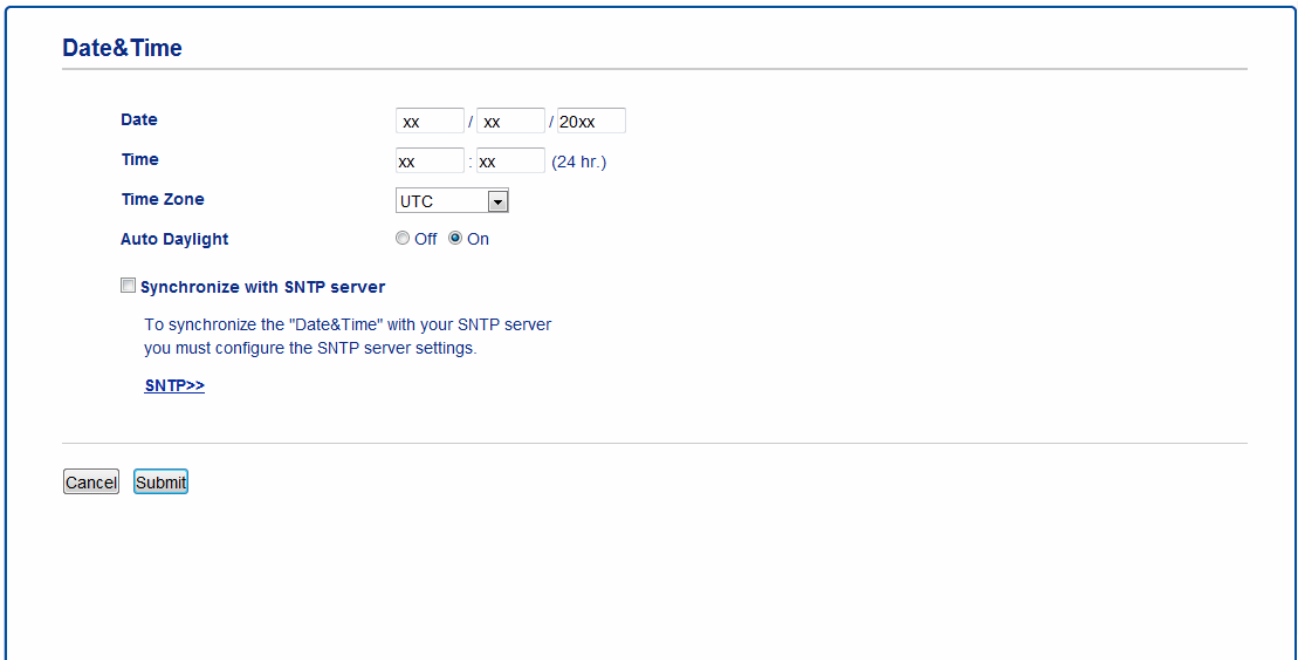

Date&Time

Date: / /

Time: : (24 hr.)

Time Zone:

Auto Daylight: Off On

Synchronize with SNTP server

To synchronize the "Date&Time" with your SNTP server you must configure the SNTP server settings.

[SNTP>>](#)



Select the time difference between your location and UTC from the **Time Zone** drop-down list. For example, the time zone for Eastern Time in the USA and Canada is UTC-05:00.

6. Verify the **Time Zone** settings.
7. Select the **Synchronize with SNTP server** check box.
8. Click **Submit**.



Related Information

- [Synchronize Time with the SNTP Server Using Web Based Management](#)

Configure the SNTP Protocol Using Web Based Management

Configure the SNTP protocol to synchronize the time the machine uses for authentication with the time kept by the SNTP time server.

1. Start your web browser.
2. Type "http://machine's IP address" in your browser's address bar (where "machine's IP address" is the machine's IP address).
For example:
http://192.0.2.1
3. Type a password, and then click . The default password is "x-admin". To ensure security, it is important you change the password.
4. Click the **Network** tab.
5. Click **Protocol** in the left navigation bar.
6. Select the **SNTP** check box to activate the settings.
7. Restart your Fuji Xerox machine to activate the configuration.
8. Next to the SNTP check box, click **Advanced Settings** and follow the instructions below:

SNTP

Status Enabled

Synchronization Status Succeeded

SNTP Server Method

Primary SNTP Server Address

Primary SNTP Server Port

Secondary SNTP Server Address

Secondary SNTP Server Port

Synchronization Interval hour(s)

Option	Description
Status	Displays whether the SNTP protocol is enabled or disabled.
Synchronization Status	Confirm the latest synchronization status.
SNTP Server Method	Select AUTO or STATIC . <ul style="list-style-type: none">• AUTO If you have a DHCP server in your network, the SNTP server will obtain the address from that server automatically.• STATIC Type the address you want to use.

Option	Description
Primary SNTP Server Address	Type the server address (up to 64 characters).
Secondary SNTP Server Address	The secondary SNTP server address is used as a backup to the primary SNTP server address. If the primary server is unavailable, the machine will contact the secondary SNTP server.
Primary SNTP Server Port	Type the port number (1-65535).
Secondary SNTP Server Port	The secondary SNTP server port is used as a backup to the primary SNTP server port. If the primary port is unavailable, the machine will contact the secondary SNTP port.
Synchronization Interval	Type the number of hours between server synchronization attempts (1-168 hours).

9. Click **Submit**.



Related Information

- [Synchronize Time with the SNTP Server Using Web Based Management](#)

Related Topics

- [Configure the Store Print Log to Network Settings Using Web Based Management](#)
-

Technical Information for Advanced Users

- [Gigabit Ethernet \(Wired Network Only\)](#)
- [Reset the Network Settings to the Factory Settings](#)

Gigabit Ethernet (Wired Network Only)

Your machine supports 1000BASE-T Gigabit Ethernet. To connect to a 1000BASE-T Gigabit Ethernet Network, you must set the machine's Ethernet link mode to Auto from the machine's control panel or Web Based Management (web browser).



- Use a straight-through Category 5 (or greater) twisted-pair cable for 10BASE-T, 100BASE-TX Fast Ethernet Network, or 1000BASE-T Gigabit Ethernet Network. When you connect the machine to a Gigabit Ethernet Network, use the network devices complying with 1000BASE-T.



Related Information

- [Technical Information for Advanced Users](#)
- [Configure the Gigabit Ethernet Settings Using Web Based Management](#)

Configure the Gigabit Ethernet Settings Using Web Based Management

1. Start your web browser.
2. Type "http://machine's IP address" in your browser's address bar (where "machine's IP address" is the machine's IP address).
For example:
http://192.0.2.1
3. Type a password, and then click . The default password is "x-admin". To ensure security, it is important you change the password.
4. Click the **Network** tab.
5. Click **Wired**.
6. Click **Ethernet** in the left navigation bar.
7. Select **Auto** from the **Ethernet Mode** drop-down list.
8. Click **Submit**.
9. To enable the settings, restart your machine.

You can confirm your settings by printing the Network Configuration Report.



Related Information

- [Gigabit Ethernet \(Wired Network Only\)](#)

Related Topics

- [Print the Network Configuration Report](#)

Reset the Network Settings to the Factory Settings

You can use your machine's control panel to reset the print server to its default factory settings. This resets all information, such as the password and IP address.



- This feature restores all wired and wireless network settings to the factory settings.
- You can also reset the print server to its factory settings using BRAdmin Light, or Web Based Management.

1. Press [] [Settings] > [All Settings] > [Network] > [Network Reset].
2. [Machine will reboot after resetting. Press [OK] for 2 seconds to confirm.] appears. Press [OK] for two seconds to confirm.
The machine will restart.



Related Information

- [Technical Information for Advanced Users](#)

Security

- [Lock the Machine Settings](#)
- [Network Security Features](#)

Lock the Machine Settings

Before turning on the machine's Access Lock, make a careful note of your password. If you forget the password, you must reset all passwords stored in the machine by contacting your administrator or Fuji Xerox customer service.

- [About Using Setting Lock](#)



About Using Setting Lock

Use the Setting Lock feature to block unauthorised access to machine settings.

When Setting Lock is set to [On], you cannot access the machine settings without entering the password.

- [Set the Setting Lock Password](#)
- [Change the Setting Lock Password](#)
- [Turn Setting Lock On](#)

Set the Setting Lock Password



1. Press  [Settings] > [All Settings] > [General Setup] > [Setting Lock].
2. Enter a four-digit number for the password.
3. Press [OK].
4. When the LCD displays [Verify:], re-enter the password.
5. Press [OK].
6. Press .



Related Information

- [About Using Setting Lock](#)

Change the Setting Lock Password

1. Press  [Settings] > [All Settings] > [General Setup] > [Setting Lock] > [Set Password].
2. Enter the current four-digit password.
3. Press [OK].
4. Enter a new four-digit password.
5. Press [OK].
6. When the LCD displays [Verify:], re-enter the password.
7. Press [OK].
8. Press .



Related Information

- [About Using Setting Lock](#)

Turn Setting Lock On

1. Press  [Settings] > [All Settings] > [General Setup] > [Setting Lock] > [Lock Off⇒On].
2. Enter the current four-digit password.
3. Press [OK].



To turn Setting Lock [Off], press  on the LCD, enter the current four-digit password, and then press [OK].



Related Information

- [About Using Setting Lock](#)

Network Security Features

- [Before Using Network Security Features](#)
- [Secure Function Lock 3.0](#)
- [Use Active Directory® Authentication](#)
- [Use LDAP Authentication](#)
- [Manage Your Network Machine Securely Using SSL/TLS](#)
- [Manage Your Network Machine Securely Using IPsec](#)
- [Send or Receive an Email Securely](#)
- [Use IEEE 802.1x Authentication for a Wired or a Wireless Network](#)
- [Store Print Log to Network](#)

Before Using Network Security Features

Your Fuji Xerox machine employs some of the latest network security and encryption protocols available today. These network features can be integrated into your overall network security plan to help protect your data and prevent unauthorised access to the machine.



We recommend disabling the Telnet, FTP server and TFTP protocols. Accessing the machine using these protocols is not secure.



Related Information

- [Network Security Features](#)
-

Secure Function Lock 3.0

Fuji Xerox's Secure Function Lock 3.0 increases security by restricting the functions available on your Fuji Xerox machine.

- [Before Using Secure Function Lock 3.0](#)
- [Configure Secure Function Lock 3.0 Using Web Based Management](#)
- [Scan Using Secure Function Lock 3.0](#)
- [Configure Public Mode for Secure Function Lock 3.0](#)
- [Additional Secure Function Lock 3.0 Features](#)

Before Using Secure Function Lock 3.0

Use Secure Function Lock to configure passwords, set specific user page limits, and grant access to some or all of the functions listed here.

You can configure and change the following Secure Function Lock 3.0 settings using Web Based Management:

- **Print**

Print includes print jobs sent via Google Cloud Print™ (supported models only) and Print Utility.

If you register users' login names in advance, the users will not need to enter their passwords when they use the print function.

- **Copy**

- **Scan**

Scan includes scan jobs sent via Print Utility.

- **Send** (supported models only)

- **Receive** (supported models only)

- USB Direct Print

- Scan to USB (supported models only)

- **Page Limits**

- **Page Counters**



Related Information

- [Secure Function Lock 3.0](#)

Configure Secure Function Lock 3.0 Using Web Based Management

1. Start your web browser.
2. Type "http://machine's IP address" in your browser's address bar (where "machine's IP address" is the machine's IP address).
For example:
http://192.0.2.1
3. Type a password, and then click . The default password is "x-admin". To ensure security, it is important you change the password.
4. Click the **Administrator** tab.
5. Click the **User Restriction Function** menu in the left navigation bar.
6. Select **Secure Function Lock**.
7. Click **Submit**.
8. Click the **Restricted Functions** menu in the left navigation bar.
9. In the **User List / Restricted Functions** field, type a group name or user name (alphanumeric, up to 15 digits).
10. In the **Print** and the other columns, select a check box to allow or clear a check box to restrict the function listed.
11. To configure the maximum page count, select the **On** check box in the **Page Limits** column, and then type the maximum number in the **Max. Pages** field.
12. Click **Submit**.
13. Click the **User List** menu in the left navigation bar.
14. In the **User List** field, type the user name.
15. In the **PIN Number** field, type a four-digit password.
16. Select **User List / Restricted Functions** from the drop-down list for each user.
17. Click **Submit**.



Related Information

- [Secure Function Lock 3.0](#)

Scan Using Secure Function Lock 3.0

Setting Scan restrictions (for administrators)

Secure Function Lock 3.0 allows an administrator to restrict which users are allowed to scan. When the Scan feature is set to Off for the public user setting, only users who have the **Scan** check box selected will be able to scan.

Using the Scan feature (for restricted users)

- To scan using the machine's control panel:
Restricted users must enter their PINs on the machine's control panel to access Scan mode.
- To scan from a computer:
Restricted users must enter their PINs on the machine's control panel before scanning from their computers. If the PIN is not entered on the machine's control panel, an error message will appear on the user's computer.



Related Information

- [Secure Function Lock 3.0](#)

Configure Public Mode for Secure Function Lock 3.0

Use the Secure Function Lock screen to set up Public Mode, which limits the functions available to public users. Public users will not need to enter a password to access the features made available through Public Mode settings.



Public Mode includes print jobs sent via Google Cloud Print™ (supported models only) and Print Utility.

1. Start your web browser.
2. Type "http://machine's IP address" in your browser's address bar (where "machine's IP address" is the machine's IP address).
For example:
http://192.0.2.1
3. Type a password, and then click . The default password is "x-admin". To ensure security, it is important you change the password.
4. Click the **Administrator** tab.
5. Click the **User Restriction Function** menu in the left navigation bar.
6. Select **Secure Function Lock**.
7. Click **Submit**.
8. Click the **Restricted Functions** menu.
9. In the **Public Mode** row, select a check box to allow or clear a check box to restrict the function listed.
10. Click **Submit**.



Related Information

- [Secure Function Lock 3.0](#)

Additional Secure Function Lock 3.0 Features

Configure the following features in the Secure Function Lock screen:

All Counter Reset

Click **All Counter Reset**, in the **Page Counters** column, to reset the page counter.

Export to CSV file

Click **Export to CSV file**, to export the current page counter including **User List / Restricted Functions** information as a CSV file.

Last Counter Record

Click **Last Counter Record** if you want the machine to retain the page count after the counter has been reset.

Counter Auto Reset

Click **Counter Auto Reset** to configure the time interval you want between page counter reset. Choose a daily, weekly, or monthly interval.



Related Information

- [Secure Function Lock 3.0](#)

Use Active Directory® Authentication

- [Introduction to Active Directory® Authentication](#)
- [Configure Active Directory® Authentication Using Web Based Management](#)
- [Log On to Change the Machine Settings Using the Machine's Control Panel \(Active Directory® Authentication\)](#)

Introduction to Active Directory® Authentication

Active Directory® Authentication restricts the use of your Fuji Xerox machine. If Active Directory® Authentication is enabled, the machine's control panel will be locked. You cannot change the machine's settings until you enter a User ID and password.

Active Directory® Authentication offers the following features:

- Stores incoming print data
- Stores incoming fax data
- (DocuPrint M385 z/DocuPrint M375 z)

Obtains the email address from the LDAP server based on your User ID, when sending scanned data to an email server.

To use this feature, select the **On** option for the **Get Mail Address** setting and **LDAP + kerberos** authentication method. Your email address will be set as the sender when the machine sends scanned data to an email server. If the machine cannot locate your email address, the machine's email address will be set as the sender.

When Active Directory® Authentication is enabled, your machine stores all incoming fax data. After you log on, the machine prints the stored fax data.

You can change the Active Directory® Authentication settings using Web Based Management.



Related Information

- [Use Active Directory® Authentication](#)

Configure Active Directory® Authentication Using Web Based Management

Active Directory® authentication supports Kerberos authentication and NTLMv2 authentication. You must configure the SNTP protocol (network time server) and DNS server configuration for authentication.

1. Start your web browser.
2. Type "http://machine's IP address" in your browser's address bar (where "machine's IP address" is the machine's IP address).
For example:
http://192.0.2.1
3. Type a password, and then click . The default password is "x-admin". To ensure security, it is important you change the password.
4. Click the **Administrator** tab.
5. Click the **User Restriction Function** menu in the left navigation bar.
6. Select **Active Directory Authentication**.
7. Click **Submit**.
8. Select **Active Directory Authentication** in the left navigation bar.
9. Configure the following settings:

Option	Description
Storage PC Print Data	Select this option to store incoming print data. After you log on to the machine, your PC print jobs will be printed automatically. This feature is available only for print data created by a Fuji Xerox native printer driver.
Storage Fax RX Data	Select this option to store incoming fax data. You can print all incoming fax data after you log on to the machine.
Remember User ID	Select this option to save your User ID.
Active Directory Server Address	Type the IP address or the server name (for example: ad.example.com) of the Active Directory® Server.
Active Directory Domain Name	Type the Active Directory® domain name.
Protocol & Authentication Method	Select the protocol and authentication method.
Get Mail Address (DocuPrint M385 z/ DocuPrint M375 z)	Select this option to obtain logged on user's email address from the LDAP server. (available only for LDAP + kerberos authentication method)
Get User's Home Directory	Select this option to obtain your home directory as the Scan to Network destination. (available only for LDAP + kerberos authentication method)
LDAP Server Port	Type the LDAP server port number (available only for LDAP + kerberos authentication method).
LDAP Search Root	Type the LDAP search root (available only for LDAP + kerberos authentication method).

10. Click **Submit**.



Related Information

- [Use Active Directory® Authentication](#)

Log On to Change the Machine Settings Using the Machine's Control Panel (Active Directory® Authentication)

When Active Directory® Authentication is enabled, the machine's control panel will be locked until you enter your User ID and password on the machine's control panel.

1. On the machine's control panel, use the touchscreen to enter your User ID and Password.
2. Press [OK].
3. When authentication is successful, the machine's control panel will be unlocked.



Related Information

- [Use Active Directory® Authentication](#)

Use LDAP Authentication

- [Introduction to LDAP Authentication](#)
- [Configure LDAP Authentication Using Web Based Management](#)
- [Log On to Change the Machine Settings Using the Machine's Control Panel \(LDAP Authentication\)](#)

Introduction to LDAP Authentication

LDAP Authentication restricts the use of your Fuji Xerox machine. If LDAP Authentication is enabled, the machine's control panel will be locked. You cannot change the machine's settings until you enter a User ID and password.

LDAP Authentication offers the following features:

- Stores incoming print data
- Stores incoming fax data
- (DocuPrint M385 z/DocuPrint M375 z)

Obtains the email address from the LDAP server based on your User ID, when sending scanned data to an email server.

To use this feature, select the **On** option for the **Get Mail Address** setting. Your email address will be set as the sender when the machine sends scanned data to an email server. If the machine cannot locate your email address, the machine's email address will be set as the sender.

When LDAP Authentication is enabled, your machine stores all incoming fax data. After you log on, the machine prints the stored fax data.

You can change the LDAP Authentication settings using Web Based Management.



Related Information

- [Use LDAP Authentication](#)

Configure LDAP Authentication Using Web Based Management

1. Start your web browser.
2. Type "http://machine's IP address" in your browser's address bar (where "machine's IP address" is the machine's IP address).
For example:
http://192.0.2.1
3. Type a password, and then click . The default password is "x-admin". To ensure security, it is important you change the password.
4. Click the **Administrator** tab.
5. Click the **User Restriction Function** menu in the left navigation bar.
6. Select **LDAP Authentication**.
7. Click **Submit**.
8. Click **LDAP Authentication** in the left navigation bar.
9. Configure the following settings:

Option	Description
Storage PC Print Data	Select this option to store incoming print data. After you log on to the machine, your PC print jobs will be printed automatically. This feature is available only for print data created by a Fuji Xerox native printer driver.
Storage Fax RX Data	Select this option to store incoming fax data. You can print all incoming fax data after you log on to the machine.
Remember User ID	Select this option to save your User ID.
LDAP Server Address	Type the IP address or the server name (for example: ad.example.com) of the LDAP server.
Get Mail Address (DocuPrint M385 z/ DocuPrint M375 z)	Select this option to obtain logged on user's email address from the LDAP server.
Get User's Home Directory	Select this option to obtain your home directory as the Scan to Network destination.
LDAP Server Port	Type the LDAP server port number.
LDAP Search Root	Type the LDAP search root directory.
Attribute of Name (Search Key)	Type the attribute you want to use as a search key.

10. Click **Submit**.



Related Information

- [Use LDAP Authentication](#)

Log On to Change the Machine Settings Using the Machine's Control Panel (LDAP Authentication)

When LDAP Authentication is enabled, the machine's control panel will be locked until you enter your User ID and password on the machine's control panel.

1. On the machine's control panel, use the touchscreen to enter your User ID and Password.
2. Press [OK].
3. When authentication is successful, the machine's control panel will be unlocked.



Related Information

- [Use LDAP Authentication](#)

Manage Your Network Machine Securely Using SSL/TLS

- [Introduction to SSL/TLS](#)
- [Certificates and Web Based Management](#)
- [Manage Your Network Machine Securely Using Web Based Management](#)
- [Print Documents Securely Using SSL/TLS](#)

Introduction to SSL/TLS

Secure Socket Layer (SSL) or Transport Layer Security (TLS) is an effective method of protecting data sent over a local or wide area network (LAN or WAN). It works by encrypting data, such as a print job, sent over a network, so anyone trying to capture it will not be able to read it.

SSL/TLS can be configured on both wired and wireless networks and will work with other forms of security such as WPA keys and firewalls.



Related Information

- [Manage Your Network Machine Securely Using SSL/TLS](#)
 - [Brief History of SSL/TLS](#)
 - [Benefits of Using SSL/TLS](#)

Brief History of SSL/TLS

SSL/TLS was originally created to secure web traffic information, particularly data sent between web browsers and servers. For example, when you use Internet Explorer® for Internet Banking and you see https:// and the little padlock icon in the web browser, you are using SSL. SSL grew to work with additional applications, such as Telnet, printer, and FTP software, in order to become a universal solution for online security. Its original design intentions are still being used today by many online retailers and banks to secure sensitive data, such as credit card numbers, customer records, etc.

SSL/TLS uses extremely high levels of encryption and is trusted by banks all over the world.



Related Information

- [Introduction to SSL/TLS](#)
-

Benefits of Using SSL/TLS

The primary benefit of using SSL/TLS on Fuji Xerox machines is to guarantee secure printing over an IP network by restricting unauthorised users from reading data sent to the machine. SSL's key selling point is that it can be used to print confidential data securely. For example, an HR department in a large company may be printing wage slips on a regular basis. Without encryption, the data contained on these wages slips can be read by other network users. However, with SSL/TLS, anyone trying to capture the data will see a confusing page of code and not the actual wage slip.



Related Information

- [Introduction to SSL/TLS](#)
-

Certificates and Web Based Management

You must configure a certificate to manage your networked Fuji Xerox machine securely using SSL/TLS. You must use Web Based Management to configure a certificate.

- [Supported Security Certificate Features](#)
- [Create and Install a Certificate](#)
- [Manage Multiple Certificates](#)

Supported Security Certificate Features

Your Fuji Xerox machine supports the use of multiple security certificates, which allows secure management, authentication, and communication with the machine. The following security certificate features can be used with the machine:

- SSL/TLS communication
- SSL communication for SMTP/POP3/IMAP4 (only available for certain models)
- IEEE 802.1x authentication
- IPsec

The Fuji Xerox machine supports the following:

- Pre-installed certificate

Your machine has a pre-installed self-signed certificate. This certificate enables you to use SSL/TLS communication without creating or installing a different certificate.



The pre-installed self-signed certificate cannot protect your communication from being compromised. We recommend using a certificate that is issued by a trusted organization for better security.

- Self-signed certificate

This print server issues its own certificate. Using this certificate, you can easily use the SSL/TLS communication without creating or installing a different certificate from a CA.

- Certificate from a Certificate Authority (CA)

There are two methods for installing a certificate from a CA. If you already have a certificate from a CA or if you want to use a certificate from an external trusted CA:

- When using a Certificates Signing Request (CSR) from this print server.
- When importing a certificate and a private key.

- Certificate Authority (CA) Certificate

To use a CA certificate that identifies the CA and owns its private key, you must import that CA certificate from the CA before configuring the security features of the Network.



- If you are going to use SSL/TLS communication, we recommend contacting your system administrator first.
- When you reset the print server back to its default factory settings, the certificate and the private key that are installed will be deleted. If you want to keep the same certificate and the private key after resetting the print server, export them before resetting, and then reinstall them.



Related Information

- [Certificates and Web Based Management](#)

Create and Install a Certificate

- [Step by Step Guide for Creating and Installing a Certificate](#)
- [Create and Install a Self-signed Certificate](#)
- [Create and Install a Certificate from a Certificate Authority \(CA\)](#)
- [Import and Export a CA Certificate](#)

Step by Step Guide for Creating and Installing a Certificate

There are two options when choosing a security certificate: use a self-signed certificate or use a certificate from a Certificate Authority (CA).

These are a brief summary of the actions required, based on the option you choose.

Option 1

Self-Signed Certificate

1. Create a self-signed certificate using Web Based Management.
2. Install the self-signed certificate on your computer.

Option 2

Certificate from a CA

1. Create a Certificate Signing Request (CSR) using Web Based Management.
2. Install the certificate issued by the CA on your Fuji Xerox machine using Web Based Management.
3. Install the certificate on your computer.



Related Information

- [Create and Install a Certificate](#)

Create and Install a Self-signed Certificate

- [Create a Self-signed Certificate](#)
- [Install the Self-signed Certificate for Windows® users with Administrator Rights](#)
- [Import and Export the Self-signed Certificate on your Fuji Xerox Machine](#)

Create a Self-signed Certificate

1. Start your web browser.
2. Type "http://machine's IP address" in your browser's address bar (where "machine's IP address" is the machine's IP address).

For example:

http://192.0.2.1



- If you are using a Domain Name System or enable a NetBIOS name, you can type another name, such as "SharedPrinter" instead of the IP address.

- For example:

- http://SharedPrinter

If you enable a NetBIOS name, you can also use the node name.

- For example:

- http://fxnxxxxxxxxxxxx

The NetBIOS name can be found in the Network Configuration Report.

- For Mac, access Web Based Management by clicking the machine's icon on the **Status Monitor** screen.

3. Type a password, and then click . The default password is "x-admin". To ensure security, it is important you change the password.
4. Click the **Network** tab.
5. Click the **Security** tab.
6. Click **Certificate**.
7. Click **Create Self-Signed Certificate**.
8. Enter a **Common Name** and a **Valid Date**.
 - The length of the **Common Name** is less than 64 bytes. Enter an identifier, such as an IP address, node name, or domain name to use when accessing this machine through SSL/TLS communication. The node name is displayed by default.
 - A warning will appear if you use the IPPS or HTTPS protocol and enter a different name in the URL than the **Common Name** that was used for the self-signed certificate.
9. Select your setting from the **Public Key Algorithm** drop-down list. The default setting is **RSA(2048bit)**.
10. Select your setting from the **Digest Algorithm** drop-down list. The default setting is **SHA256**.
11. Click **Submit**.
12. Click **Network**.
13. Click **Protocol**.
14. Click **HTTP Server Settings**.
15. Select the certificate you want to configure from the **Select the Certificate** drop-down list.
16. Click **Submit**.

The following screen appears.

HTTP Server Settings

The setting for high security in communication was done.

To activate your new settings, this Device needs to restart.

Note: Any jobs in progress will be aborted.

To activate other protocols that have secure settings after restarting, check the box below.

Activate other protocols that have secure settings.

Would you like to restart immediately?

Yes

No

17. Click **Yes** to restart your print server.

The self-signed certificate is created and saved in your machine's memory.

To use SSL/TLS communication, the self-signed certificate must be installed on your computer.



Related Information

- [Create and Install a Self-signed Certificate](#)
-

Install the Self-signed Certificate for Windows® users with Administrator Rights

The following steps are for Microsoft® Internet Explorer®. If you use another web browser, consult the documentation for your web browser to get help with installing certificates.

1. Do one of the following:

- (Windows® 7 and Windows Server® 2008)

Click  (**Start**) > **All Programs**.



- (Windows® 8)

Right-click the  (**Internet Explorer**) icon on the taskbar.

- (Windows® 10 and Windows Server® 2016)

Click  > **Windows Accessories**.

- (Windows Server® 2012 and Windows Server® 2012 R2)

Click  (**Internet Explorer**), and then right-click the  (**Internet Explorer**) icon that appears on the taskbar.

2. Right-click **Internet Explorer**, and then click **Run as administrator**.



If the **More** option appears, click **More**.

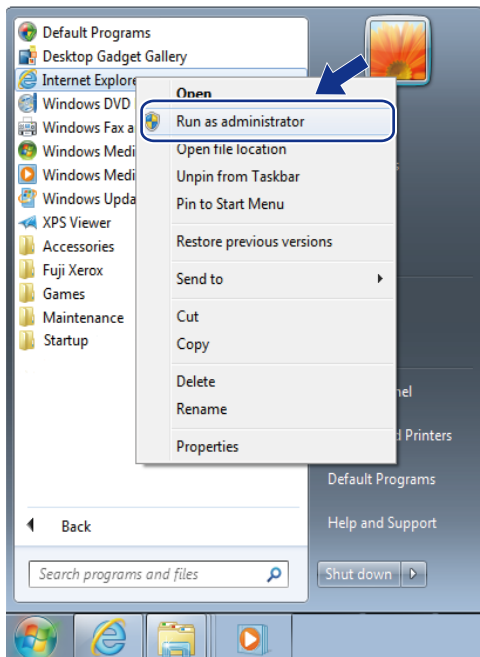

If the **User Account Control** screen appears, click **Yes**.

3. Type "https://machine's IP address" in your browser's address bar to access your machine (where "machine's IP address" is the machine's IP address or the node name that you assigned for the certificate).

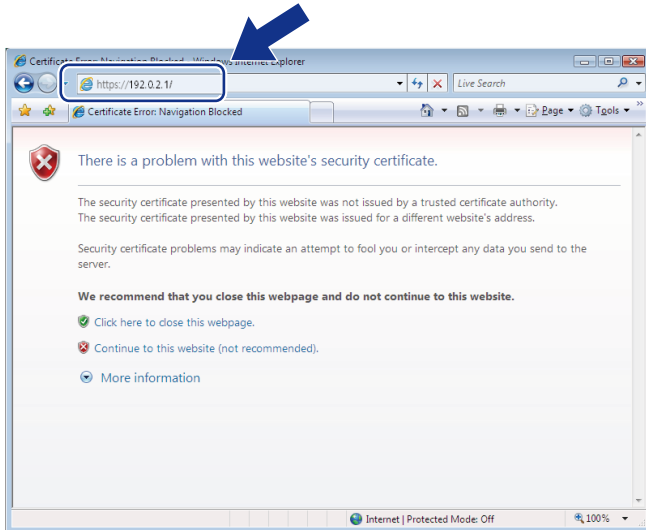

4. Click **Continue to this website (not recommended)**.

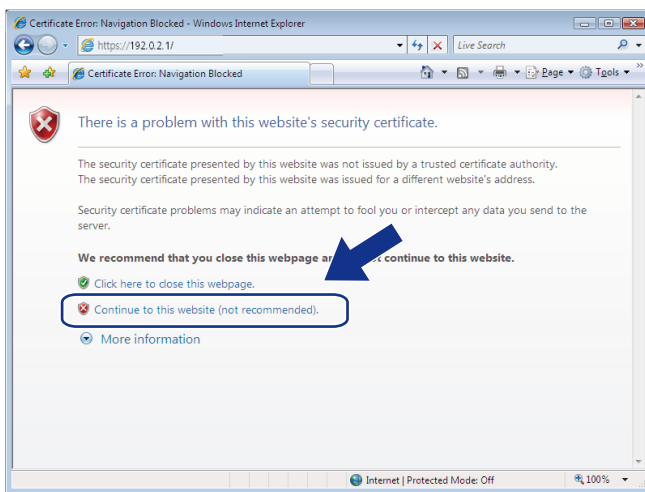

5. Click **Certificate Error**, and then click **View certificates**.

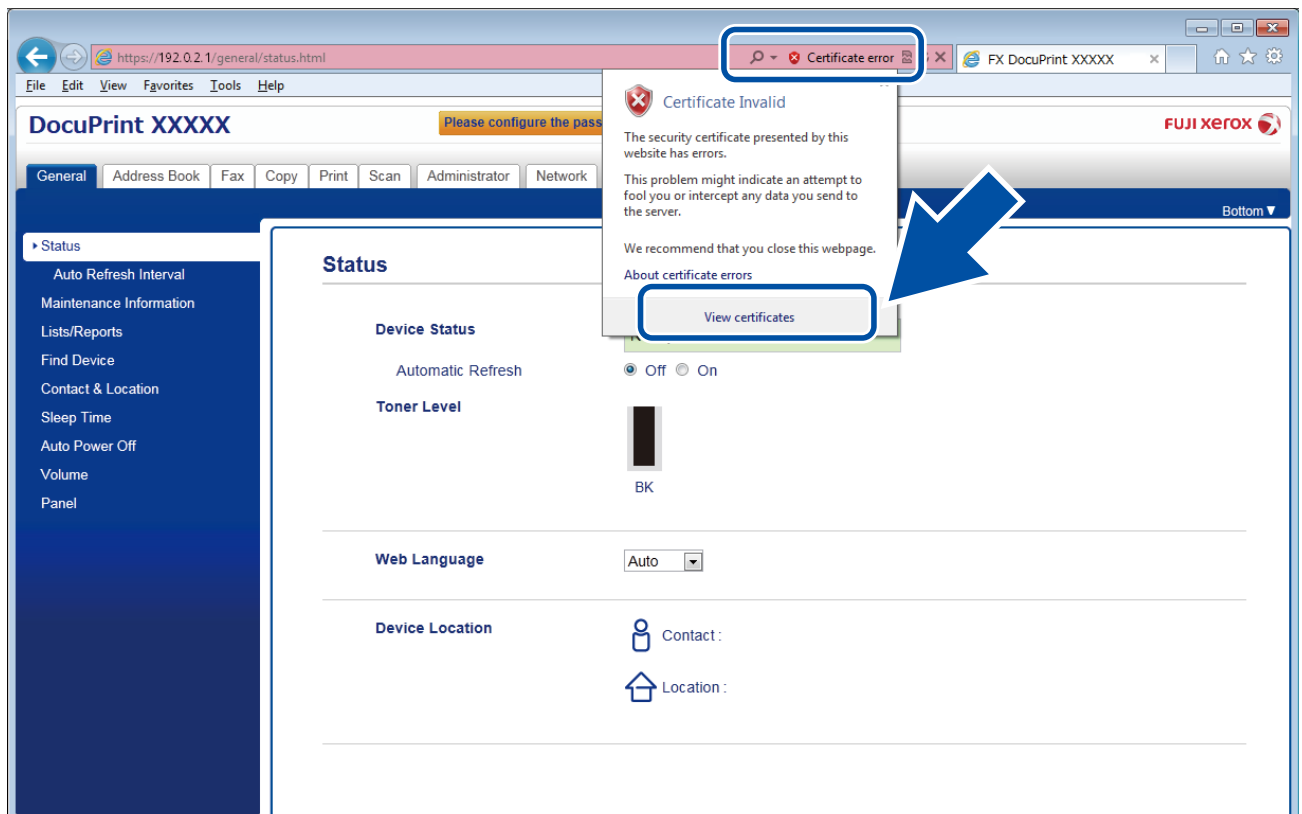

6. Click **Install Certificate....**

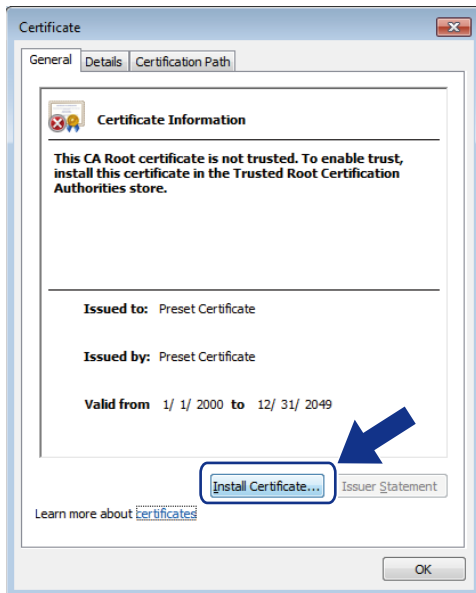

7. When the **Certificate Import Wizard** appears, click **Next**.

8. Select **Place all certificates in the following store**, and then click **Browse...**

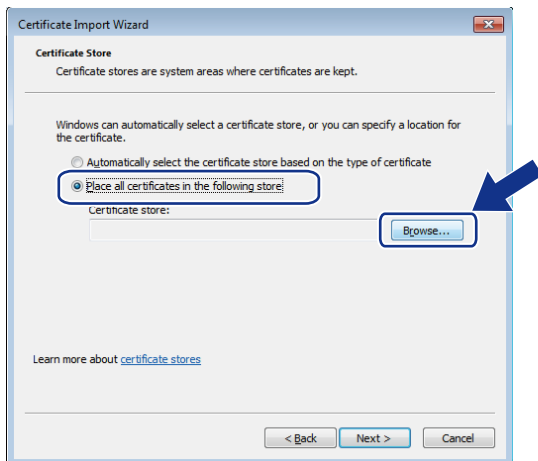

9. Select **Trusted Root Certification Authorities**, and then click **OK**.

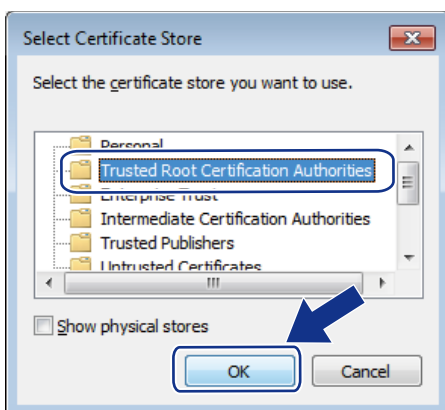

10. Click **Next**.

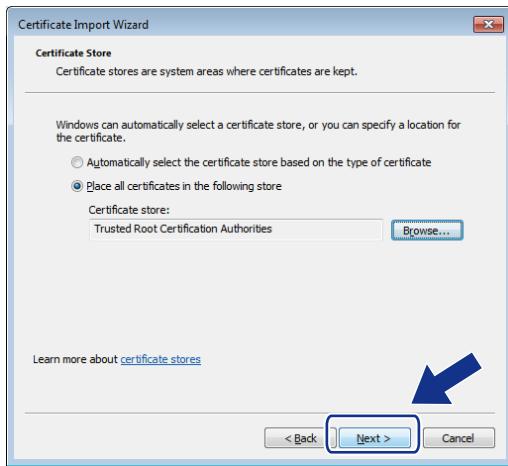

11. Click **Finish**.

12. Click **Yes**, if the fingerprint (thumbprint) is correct.

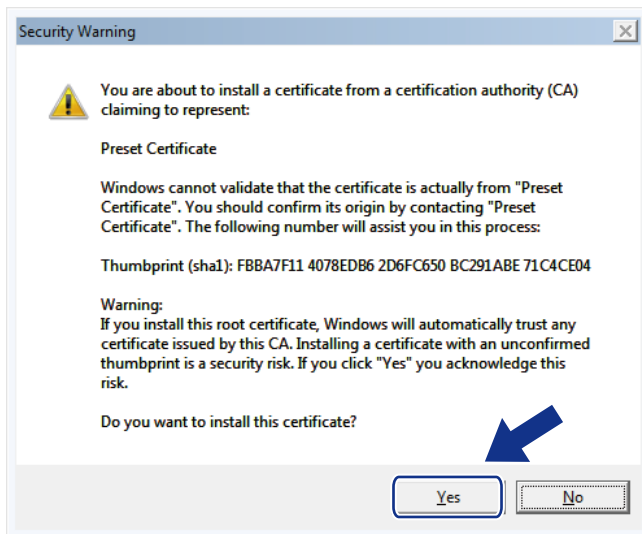

The fingerprint (thumbprint) is printed on the Network Configuration Report.

13. Click **OK**.

The self-signed certificate is now installed on your computer, and SSL/TLS communication is available.



Related Information

- [Create and Install a Self-signed Certificate](#)
-

Import and Export the Self-signed Certificate on your Fuji Xerox Machine

You can store the self-signed certificates on your Fuji Xerox machine and manage them by importing and exporting.

- [Import the Self-signed Certificate](#)
- [Export the Self-signed Certificate](#)

Import the Self-signed Certificate

1. Start your web browser.
2. Type "http://machine's IP address" in your browser's address bar (where "machine's IP address" is the machine's IP address).

For example:

http://192.0.2.1



- If you are using a Domain Name System or enable a NetBIOS name, you can type another name, such as "SharedPrinter" instead of the IP address.

- For example:

http://SharedPrinter

If you enable a NetBIOS name, you can also use the node name.

- For example:

http://fxnxxxxxxxxxxxx

The NetBIOS name can be found in the Network Configuration Report.

- For Mac, access Web Based Management by clicking the machine's icon on the **Status Monitor** screen.

3. Type a password, and then click . The default password is "x-admin". To ensure security, it is important you change the password.
4. Click the **Network** tab.
5. Click the **Security** tab.
6. Click **Certificate**.
7. Click **Import Certificate and Private Key**.
8. Browse to the file you want to import.
9. Type the password if the file is encrypted, and then click **Submit**.

The self-signed certificate is imported to your machine.

To use SSL/TLS communication, the self-signed certificate must also be installed on your computer. Contact your network administrator.



Related Information

- [Import and Export the Self-signed Certificate on your Fuji Xerox Machine](#)

Export the Self-signed Certificate

1. Start your web browser.
2. Type "http://machine's IP address" in your browser's address bar (where "machine's IP address" is the machine's IP address).
For example:
http://192.0.2.1



- If you are using a Domain Name System or enable a NetBIOS name, you can type another name, such as "SharedPrinter" instead of the IP address.
 - For example:
http://SharedPrinter
- If you enable a NetBIOS name, you can also use the node name.
 - For example:
http://fxnxxxxxxxxxxxx
- The NetBIOS name can be found in the Network Configuration Report.
- For Mac, access Web Based Management by clicking the machine's icon on the **Status Monitor** screen.

3. Type a password, and then click . The default password is "x-admin". To ensure security, it is important you change the password.
4. Click the **Network** tab.
5. Click the **Security** tab.
6. Click **Certificate**.
7. Click **Export** shown with **Certificate List**.
8. If you want to encrypt the file, type a password in the **Enter password** field.
If the **Enter password** field is blank, your output file will not be encrypted.
9. Type the password again in the **Retype password** field, and then click **Submit**.
10. Click **Save**.
11. Specify the location where you want to save the file.

The self-signed certificate is exported to your computer.

You can also import the self-signed certificate to your computer.



Related Information

- [Import and Export the Self-signed Certificate on your Fuji Xerox Machine](#)

Create and Install a Certificate from a Certificate Authority (CA)

If you already have a certificate from an external trusted CA, you can store the certificate and private key on the machine and manage them by importing and exporting. If you do not have a certificate from an external trusted CA, create a Certificate Signing Request (CSR), send it to a CA for authentication, and install the returned certificate on your machine.

- [Create a Certificate Signing Request \(CSR\)](#)
- [Install a Certificate on Your Fuji Xerox Machine](#)
- [Import and Export the Certificate and Private Key](#)

Create a Certificate Signing Request (CSR)

A Certificate Signing Request (CSR) is a request sent to a Certificate Authority (CA) to authenticate the credentials contained within the certificate.

We recommend installing a Root Certificate from the CA on your computer before creating the CSR.

1. Start your web browser.
2. Type "http://machine's IP address" in your browser's address bar (where "machine's IP address" is the machine's IP address).

For example:

http://192.0.2.1



- If you are using a Domain Name System or enable a NetBIOS name, you can type another name, such as "SharedPrinter" instead of the IP address.

- For example:

http://SharedPrinter

If you enable a NetBIOS name, you can also use the node name.

- For example:

http://fxnxxxxxxxxxxxx

The NetBIOS name can be found in the Network Configuration Report.

- For Mac, access Web Based Management by clicking the machine's icon on the **Status Monitor** screen.

3. Type a password, and then click . The default password is "x-admin". To ensure security, it is important you change the password.
4. Click the **Network** tab.
5. Click the **Security** tab.
6. Click **Certificate**.
7. Click **Create CSR**.
8. Type a **Common Name** (required) and add other information about your **Organization** (optional).



- Your company details are required so that a CA can confirm your identity and verify it to the outside world.
- The length of the **Common Name** must be less than 64 bytes. Enter an identifier, such as an IP address, node name, or domain name to use when accessing this printer through SSL/TLS communication. The node name is displayed by default. The **Common Name** is required.
- A warning will appear if you type a different name in the URL than the Common Name that was used for the certificate.
- The length of the **Organization**, the **Organization Unit**, the **City/Locality** and the **State/Province** must be less than 64 bytes.
- The **Country/Region** should be a two character ISO 3166 country code.
- If you are configuring an X.509v3 certificate extension, select the **Configure extended partition** check box, and then select **Auto (Register IPv4)** or **Manual**.

9. Select your setting from the **Public Key Algorithm** drop-down list. The default setting is **RSA(2048bit)**.
10. Select your setting from the **Digest Algorithm** drop-down list. The default setting is **SHA256**.
11. Click **Submit**.

The CSR appears on your screen. Save the CSR as a file or copy and paste it into an online CSR form offered by a Certificate Authority.

12. Click **Save**.



-
- Follow your CA's policy regarding the method to send a CSR to your CA.
 - If you are using the Enterprise root CA of Windows Server® 2008/2012/2012 R2/2016, we recommend using the Web Server for the certificate template to securely create the Client Certificate.
-



Related Information

- [Create and Install a Certificate from a Certificate Authority \(CA\)](#)
-

Install a Certificate on Your Fuji Xerox Machine

When you receive a certificate from a CA, follow the steps below to install it into the print server:

Only a certificate issued with your machine's CSR can be installed onto the machine. When you want to create another CSR, make sure that the certificate is installed before creating another CSR. Create another CSR only after installing the certificate on the machine. If you do not, the CSR you create before installing will be invalid.

1. Start your web browser.
2. Type "http://machine's IP address" in your browser's address bar (where "machine's IP address" is the machine's IP address).

For example:

http://192.0.2.1



- If you are using a Domain Name System or enable a NetBIOS name, you can type another name, such as "SharedPrinter" instead of the IP address.

- For example:

http://SharedPrinter

If you enable a NetBIOS name, you can also use the node name.

- For example:

http://fxnxxxxxxxxxxxx

The NetBIOS name can be found in the Network Configuration Report.

- For Mac, access Web Based Management by clicking the machine's icon on the **Status Monitor** screen.

3. Type a password, and then click . The default password is "x-admin". To ensure security, it is important you change the password.
4. Click the **Network** tab.
5. Click the **Security** tab.
6. Click **Certificate**.
7. Click **Install Certificate**.
8. Browse to the file that contains the certificate issued by the CA, and then click **Submit**.

The certificate has been created successfully and saved in your machine's memory successfully.

To use SSL/TLS communication, the Root Certificate from the CA must be installed on your computer. Contact your network administrator.



Related Information

- [Create and Install a Certificate from a Certificate Authority \(CA\)](#)

Import and Export the Certificate and Private Key

Store the certificate and private key on your machine and manage them by importing and exporting them.

- [Import a Certificate and Private Key](#)
- [Export the Certificate and Private Key](#)

Import a Certificate and Private Key

1. Start your web browser.
2. Type "http://machine's IP address" in your browser's address bar (where "machine's IP address" is the machine's IP address).

For example:

http://192.0.2.1



- If you are using a Domain Name System or enable a NetBIOS name, you can type another name, such as "SharedPrinter" instead of the IP address.

- For example:

http://SharedPrinter

If you enable a NetBIOS name, you can also use the node name.

- For example:

http://fxnxxxxxxxxxxxx

The NetBIOS name can be found in the Network Configuration Report.

- For Mac, access Web Based Management by clicking the machine's icon on the **Status Monitor** screen.

3. Type a password, and then click . The default password is "x-admin". To ensure security, it is important you change the password.
4. Click the **Network** tab.
5. Click the **Security** tab.
6. Click **Certificate**.
7. Click **Import Certificate and Private Key**.
8. Browse to the file you want to import.
9. Type the password if the file is encrypted, and then click **Submit**.

The certificate and private key are imported to your machine.

To use SSL/TLS communication, the Root Certificate from the CA must also be installed on your computer. Contact your network administrator.



Related Information

- [Import and Export the Certificate and Private Key](#)

Export the Certificate and Private Key

1. Start your web browser.
2. Type "http://machine's IP address" in your browser's address bar (where "machine's IP address" is the machine's IP address).

For example:

http://192.0.2.1



- If you are using a Domain Name System or enable a NetBIOS name, you can type another name, such as "SharedPrinter" instead of the IP address.

- For example:

http://SharedPrinter

If you enable a NetBIOS name, you can also use the node name.

- For example:

http://fxnxxxxxxxxxxxx

The NetBIOS name can be found in the Network Configuration Report.

- For Mac, access Web Based Management by clicking the machine's icon on the **Status Monitor** screen.

3. Type a password, and then click . The default password is "x-admin". To ensure security, it is important you change the password.
4. Click the **Network** tab.
5. Click the **Security** tab.
6. Click **Certificate**.
7. Click **Export** shown with **Certificate List**.
8. Enter the password if you want to encrypt the file.
If a blank password is used, the output is not encrypted.
9. Enter the password again for confirmation, and then click **Submit**.
10. Click **Save**.
11. Specify the location where you want to save the file.

The certificate and private key are exported to your computer.

You can also import the certificate to your computer.



Related Information

- [Import and Export the Certificate and Private Key](#)

Import and Export a CA Certificate

You can import, export and store CA certificates on your Fuji Xerox machine.

- [Import a CA Certificate](#)
- [Export a CA Certificate](#)

Import a CA Certificate

1. Start your web browser.
2. Type "http://machine's IP address" in your browser's address bar (where "machine's IP address" is the machine's IP address).

For example:

http://192.0.2.1



- If you are using a Domain Name System or enable a NetBIOS name, you can type another name, such as "SharedPrinter" instead of the IP address.

- For example:

- http://SharedPrinter

If you enable a NetBIOS name, you can also use the node name.

- For example:

- http://fxnxxxxxxxxxxxxx

The NetBIOS name can be found in the Network Configuration Report.

- For Mac, access Web Based Management by clicking the machine's icon on the **Status Monitor** screen.

3. Type a password, and then click . The default password is "x-admin". To ensure security, it is important you change the password.
4. Click the **Network** tab.
5. Click the **Security** tab.
6. Click **CA Certificate**.
7. Click **Import CA Certificate**.
8. Browse to the file you want to import.
9. Click **Submit**.



Related Information

- [Import and Export a CA Certificate](#)

Export a CA Certificate

1. Start your web browser.
2. Type "http://machine's IP address" in your browser's address bar (where "machine's IP address" is the machine's IP address).

For example:

http://192.0.2.1



- If you are using a Domain Name System or enable a NetBIOS name, you can type another name, such as "SharedPrinter" instead of the IP address.

- For example:

http://SharedPrinter

If you enable a NetBIOS name, you can also use the node name.

- For example:

http://fxnxxxxxxxxxxxxx

The NetBIOS name can be found in the Network Configuration Report.

- For Mac, access Web Based Management by clicking the machine's icon on the **Status Monitor** screen.

3. Type a password, and then click . The default password is "x-admin". To ensure security, it is important you change the password.
4. Click the **Network** tab.
5. Click the **Security** tab.
6. Click **CA Certificate**.
7. Select the certificate you want to export and click **Export**.
8. Click **Submit**.
9. Click **Save**.
10. Specify where on your computer you want to save the exported certificate, and save it.



Related Information

- [Import and Export a CA Certificate](#)

Manage Multiple Certificates

The multiple certificate feature allows you to use Web Based Management to manage each certificate installed on your machine. In Web Based Management, navigate to the **Certificate** or **CA Certificate** screen to view certificate content, delete, or export your certificates.

	Maximum Number of Certificates Stored UP on Fuji Xerox Machine
Self-signed Certificate or Certificate Issued by a CA	6
CA Certificate	9

We recommend storing one less certificate than allowed, reserving an empty spot in case of certificate expiration. When a certificate expires, import a new certificate into the reserved spot, and then delete the expired certificate. This ensures that you avoid configuration failure.



- When you use HTTPS/IPPS, IEEE 802.1x, or Signed PDF, you must select which certificate you are using.
- When you use SSL for SMTP/POP3/IMAP4 communications (only available for certain models), you do not have to choose the certificate. The necessary certificate will be chosen automatically.



Related Information

- [Certificates and Web Based Management](#)

Manage Your Network Machine Securely Using Web Based Management

To manage your network machine securely, you must use management utilities with security protocols.

We recommend using the HTTPS protocol for secure management. To use this protocol, HTTPS must be enabled on your machine.



- The HTTPS protocol is enabled by default.
- You can change the HTTPS protocol settings using the Web Based Management screen.
 1. Click the **Network** tab.
 2. Click the **Protocol** menu in the left navigation bar.
 3. Click **HTTP Server Settings**.

1. Start your web browser.
2. Type "https://Common Name" in your browser's address bar (where "Common Name" is the Common Name that you assigned to the certificate; this could be your IP address, node name, or domain name).
3. Type a password, and then click . The default password is "x-admin". To ensure security, it is important you change the password.
4. You can now access the machine using HTTPS.



- If you use the SNMPv3 protocol, follow the steps below.

5. Click the **Network** tab.
6. Click **Protocol**.
7. Make sure the **SNMP** setting is enabled, and then click **Advanced Settings**.
8. Configure the SNMP settings.

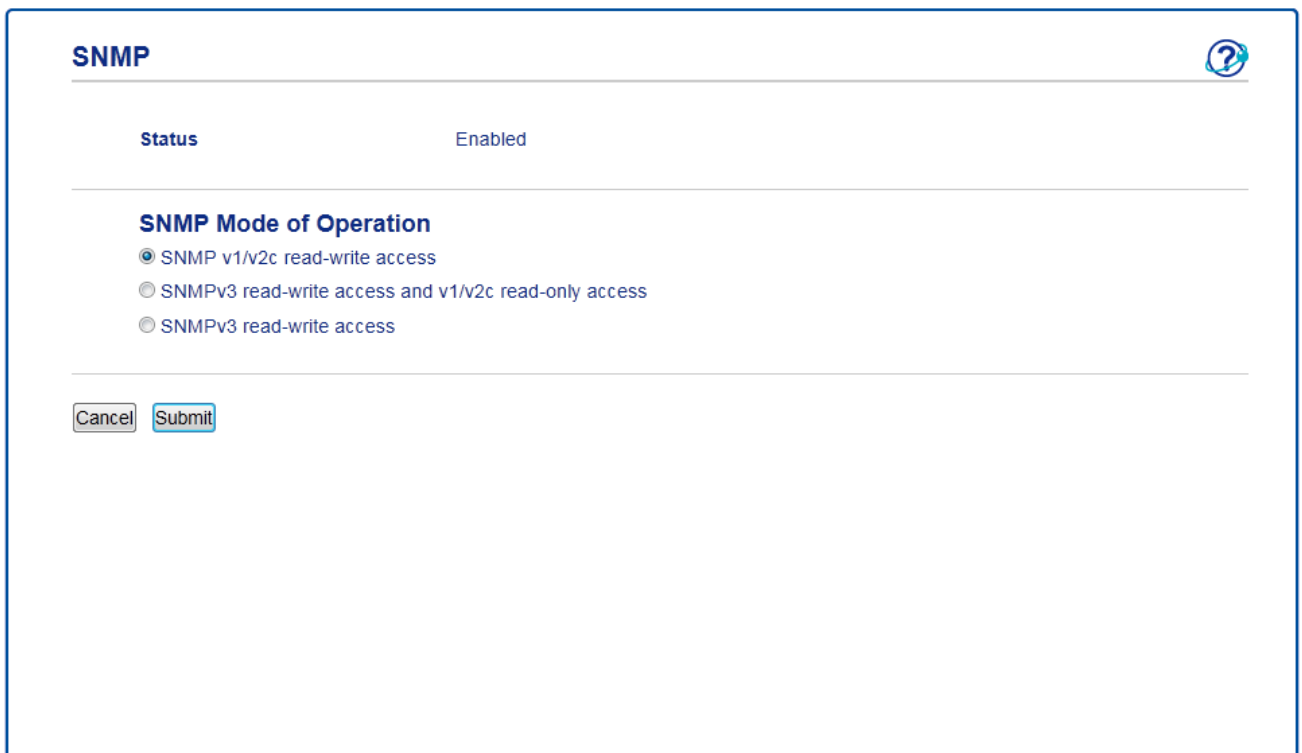

SNMP 

Status Enabled

SNMP Mode of Operation

SNMP v1/v2c read-write access

SNMPv3 read-write access and v1/v2c read-only access

SNMPv3 read-write access

There are three options for **SNMP Mode of Operation**.

- **SNMP v1/v2c read-write access**

In this mode, the print server uses version 1 and version 2c of the SNMP protocol. You can use all Fuji Xerox applications in this mode. However, it is not secure since it will not authenticate the user, and data will not be encrypted.

- **SNMPv3 read-write access and v1/v2c read-only access**

In this mode, the print server uses the read-write access of version 3 and the read-only access of version 1 and version 2c of the SNMP protocol.



When you use **SNMPv3 read-write access and v1/v2c read-only access** mode, some Fuji Xerox applications (such as BRAdmin Light) that access the print server do not work correctly since they authorize the read-only access of version 1 and version 2c. If you want to use all applications, we recommend using **SNMP v1/v2c read-write access** mode.

- **SNMPv3 read-write access**

In this mode, the print server uses version 3 of the SNMP protocol. If you want to manage the print server securely, use this mode.



When you use **SNMPv3 read-write access** mode, note the following:

- You can use only Web Based Management to manage the print server.
 - All applications that use SNMPv1/v2c will be restricted. To allow the use of SNMPv1/v2c applications, use **SNMPv3 read-write access and v1/v2c read-only access** or **SNMP v1/v2c read-write access** mode.
-



Related Information

- [Manage Your Network Machine Securely Using SSL/TLS](#)
-

Print Documents Securely Using SSL/TLS

To print documents securely with IPP protocol, use the IPPS protocol.

1. Start your web browser.
2. Type "http://machine's IP address" in your browser's address bar (where "machine's IP address" is the machine's IP address).

For example:

http://192.0.2.1



- If you are using a Domain Name System or enable a NetBIOS name, you can type another name, such as "SharedPrinter" instead of the IP address.

- For example:

http://SharedPrinter

If you enable a NetBIOS name, you can also use the node name.

- For example:

http://fxnxxxxxxxxxxxx

The NetBIOS name can be found in the Network Configuration Report.

- For Mac, access Web Based Management by clicking the machine's icon on the **Status Monitor** screen.

3. Type a password, and then click . The default password is "x-admin". To ensure security, it is important you change the password.
4. Click the **Network** tab.
5. Click **Protocol**. Make sure the **IPP** check box is selected.



If the **IPP** check box is not selected, select the **IPP** check box, and then click **Submit**.

Restart your machine to activate the configuration.

After the machine restarts, return to the machine's web page, click the **Network** tab, and then click **Protocol**.

6. Click **HTTP Server Settings**.
7. Select the **HTTPS(Port443)** check box in the **IPP**, and then click **Submit**.
8. Restart your machine to activate the configuration.

Communication using IPPS cannot prevent unauthorised access to the print server.



Related Information

- [Manage Your Network Machine Securely Using SSL/TLS](#)

Manage Your Network Machine Securely Using IPsec

- [Introduction to IPsec](#)
- [Configure IPsec Using Web Based Management](#)
- [Configure an IPsec Address Template Using Web Based Management](#)
- [Configure an IPsec Template Using Web Based Management](#)

Introduction to IPsec

IPsec (Internet Protocol Security) is a security protocol that uses an optional Internet Protocol function to prevent manipulation and ensure the confidentiality of data transmitted as IP packets. IPsec encrypts data carried over the network, such as print data sent from computers to a printer. Because the data is encrypted at the network layer, applications that employ a higher-level protocol use IPsec even if the user is not aware of its use.

IPsec supports the following functions:

- IPsec transmissions

According to the IPsec setting conditions, the network-connected computer sends data to and receives data from the specified device using IPsec. When the devices start communicating using IPsec, keys are exchanged using Internet Key Exchange (IKE) first, and then the encrypted data is transmitted using the keys. In addition, IPsec has two operation modes: the Transport mode and Tunnel mode. The Transport mode is used mainly for communication between devices and the Tunnel mode is used in environments such as a Virtual Private Network (VPN).



For IPsec transmissions, the following conditions are necessary:

- A computer that can communicate using IPsec is connected to the network.
 - Your Fuji Xerox machine is configured for IPsec communication.
 - The computer connected to your Fuji Xerox machine is configured for IPsec connections.
-

- IPsec settings

The settings that are necessary for connections using IPsec. These settings can be configured using Web Based Management.



To configure the IPsec settings, you must use the browser on a computer that is connected to the network.



Related Information

- [Manage Your Network Machine Securely Using IPsec](#)
-

Configure IPsec Using Web Based Management

The IPsec connection conditions are comprised of two **Template** types: **Address** and **IPsec**. You can configure up to 10 connection conditions.

1. Start your web browser.
2. Type "http://machine's IP address" in your browser's address bar (where "machine's IP address" is the machine's IP address).
For example:
http://192.0.2.1
3. Type a password, and then click . The default password is "x-admin". To ensure security, it is important you change the password.
4. Click the **Network** tab.
5. Click the **Security** tab.
6. Click the **IPsec** menu in the left navigation bar.

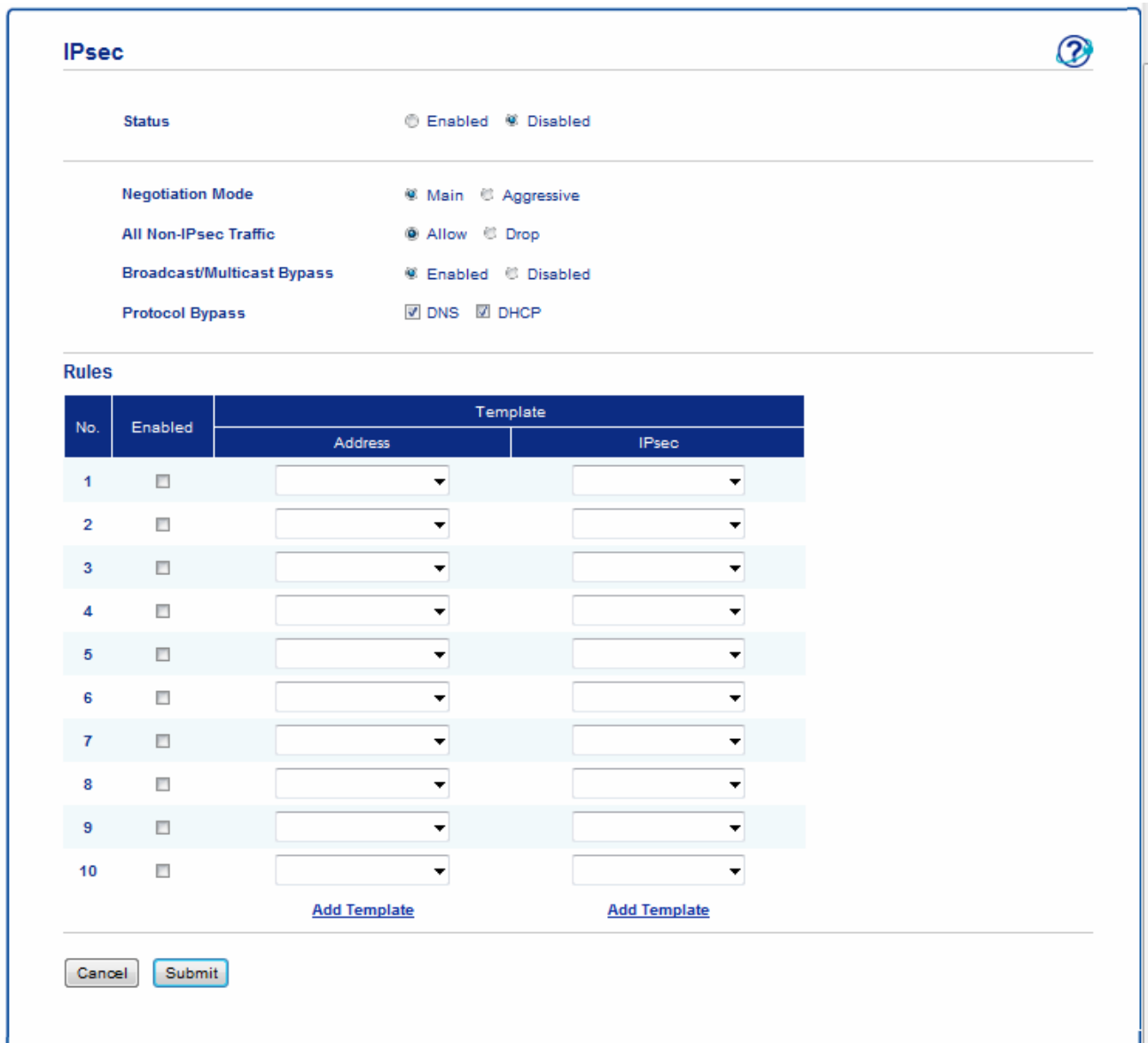

IPsec 

Status Enabled Disabled

Negotiation Mode Main Aggressive

All Non-IPsec Traffic Allow Drop

Broadcast/Multicast Bypass Enabled Disabled

Protocol Bypass DNS DHCP

Rules

No.	Enabled	Template	
		Address	IPsec
1	<input type="checkbox"/>	<input type="text"/>	<input type="text"/>
2	<input type="checkbox"/>	<input type="text"/>	<input type="text"/>
3	<input type="checkbox"/>	<input type="text"/>	<input type="text"/>
4	<input type="checkbox"/>	<input type="text"/>	<input type="text"/>
5	<input type="checkbox"/>	<input type="text"/>	<input type="text"/>
6	<input type="checkbox"/>	<input type="text"/>	<input type="text"/>
7	<input type="checkbox"/>	<input type="text"/>	<input type="text"/>
8	<input type="checkbox"/>	<input type="text"/>	<input type="text"/>
9	<input type="checkbox"/>	<input type="text"/>	<input type="text"/>
10	<input type="checkbox"/>	<input type="text"/>	<input type="text"/>

[Add Template](#) [Add Template](#)

7. In the **Status** field, enable or disable IPsec.

-
8. Select **Negotiation Mode** for IKE Phase 1.
IKE is a protocol that is used to exchange encryption keys in order to carry out encrypted communication using IPsec.
In **Main** mode, the processing speed is slow, but the security is high. In **Aggressive** mode, the processing speed is faster than **Main** mode, but the security is lower.
 9. In the **All Non-IPsec Traffic** field, select the action to be taken for non-IPsec packets.
When using Web Services, you must select **Allow** for **All Non-IPsec Traffic**. If you select **Drop**, Web Services cannot be used.
 10. In the **Broadcast/Multicast Bypass** field, select **Enabled** or **Disabled**.
 11. In the **Protocol Bypass** field, select the check box for the option or options you want.
 12. In the **Rules** table, select the **Enabled** check box to activate the template.
When you select multiple check boxes, the lower numbered check boxes have priority if the settings for the selected check boxes conflict.
 13. Click on the corresponding drop-down list to select the **Address Template** that is used for the IPsec connection conditions.
To add an **Address Template**, click **Add Template**.
 14. Click on the corresponding drop-down list to select the **IPsec Template** that is used for the IPsec connection conditions.
To add an **IPsec Template**, click **Add Template**.
 15. Click **Submit**.
If the machine must be restarted to register the new settings, the restart confirmation screen will appear.
If there is a blank item in the template you enabled in the **Rules** table, an error message appears. Confirm your choices and submit again.



Related Information

- [Manage Your Network Machine Securely Using IPsec](#)
-

Configure an IPsec Address Template Using Web Based Management

1. Start your web browser.
2. Type "http://machine's IP address" in your browser's address bar (where "machine's IP address" is the machine's IP address).
For example:
http://192.0.2.1
3. Type a password, and then click . The default password is "x-admin". To ensure security, it is important you change the password.
4. Click the **Network** tab.
5. Click the **Security** tab.
6. Click the **IPsec Address Template** menu in the left navigation bar.
The Template List appears, displaying 10 Address Templates.
Click the **Delete** button to delete an **Address Template**. When an **Address Template** is in use, it cannot be deleted.
7. Click the **Address Template** that you want to create. The **IPsec Address Template** appears.

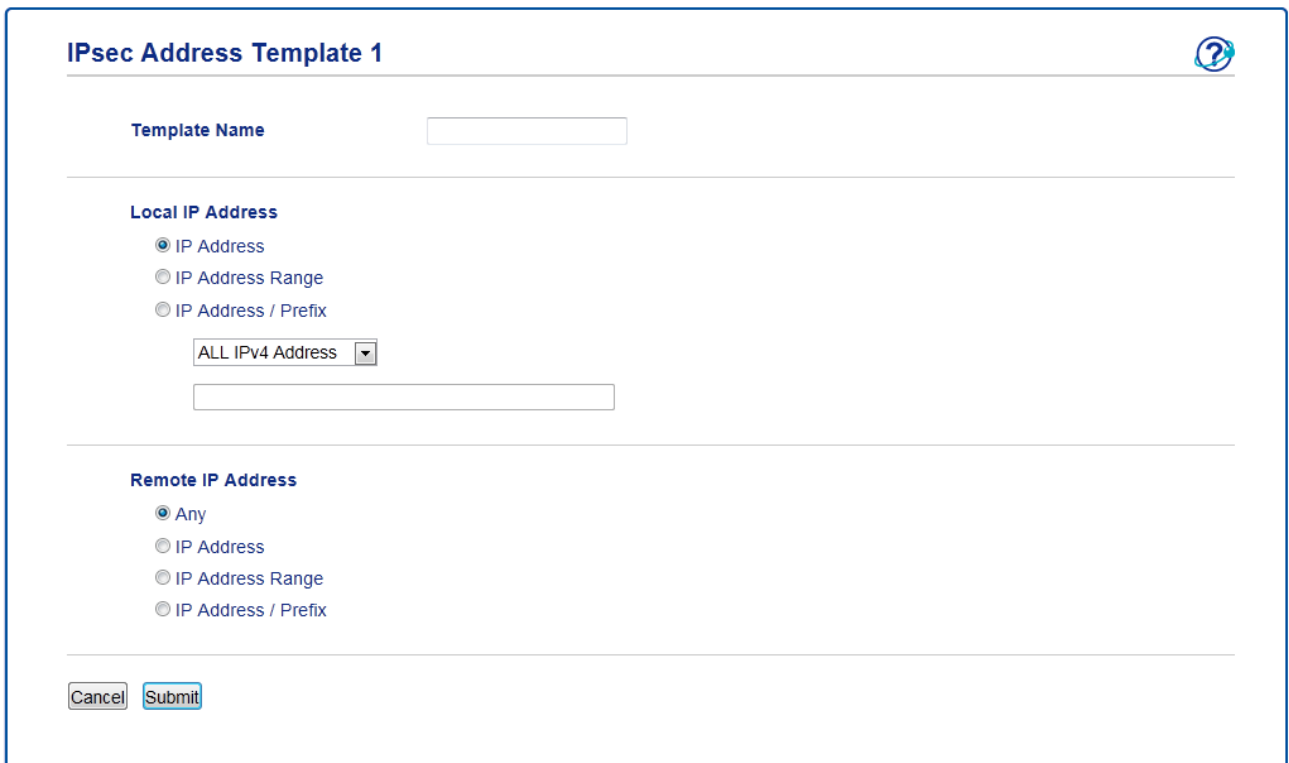

The screenshot shows a web form titled "IPsec Address Template 1" with a help icon in the top right corner. The form is divided into three main sections: "Template Name", "Local IP Address", and "Remote IP Address".

- Template Name:** A single text input field.
- Local IP Address:** Contains three radio button options: "IP Address" (selected), "IP Address Range", and "IP Address / Prefix". Below these is a dropdown menu currently set to "ALL IPv4 Address" and an empty text input field.
- Remote IP Address:** Contains four radio button options: "Any" (selected), "IP Address", "IP Address Range", and "IP Address / Prefix".

At the bottom left of the form are two buttons: "Cancel" and "Submit".

8. In the **Template Name** field, type a name for the template (up to 16 characters).
9. Select a **Local IP Address** option to specify the IP address conditions for the sender:
 - **IP Address**
Specify the IP address. Select **ALL IPv4 Address**, **ALL IPv6 Address**, **ALL Link Local IPv6**, or **Custom** from the drop-down list.
If you select **Custom** from the drop-down list, type the IP address (IPv4 or IPv6) in the text box.
 - **IP Address Range**
Type the starting and ending IP addresses for the IP address range in the text boxes. If the starting and ending IP addresses are not standardized to IPv4 or IPv6, or the ending IP address is smaller than the starting address, an error will occur.

- **IP Address / Prefix**

Specify the IP address using CIDR notation.

For example: 192.0.2.1/24

Because the prefix is specified in the form of a 24-bit subnet mask (255.255.255.0) for 192.0.2.1, the addresses 192.0.2.xxx are valid.

10. Select a **Remote IP Address** option to specify the IP address conditions for the recipient:

- **Any**

If you select **Any**, all IP addresses are enabled.

- **IP Address**

Type the specified IP address (IPv4 or IPv6) in the text box.

- **IP Address Range**

Type the starting and ending IP addresses for the IP address range. If the starting and ending IP addresses are not standardized to IPv4 or IPv6, or the ending IP address is smaller than the starting address, an error will occur.

- **IP Address / Prefix**

Specify the IP address using CIDR notation.

For example: 192.0.2.1/24

Because the prefix is specified in the form of a 24-bit subnet mask (255.255.255.0) for 192.0.2.1, the addresses 192.0.2.xxx are valid.

11. Click **Submit**.



When you change the settings for the template currently in use, restart your machine to active the configuration.



Related Information

- [Manage Your Network Machine Securely Using IPsec](#)
-

Configure an IPsec Template Using Web Based Management

1. Start your web browser.
2. Type "http://machine's IP address" in your browser's address bar (where "machine's IP address" is the machine's IP address).
For example:
http://192.0.2.1
3. Type a password, and then click . The default password is "x-admin". To ensure security, it is important you change the password.
4. Click the **Network** tab.
5. Click the **Security** tab.
6. Click **IPsec Template** in the left navigation bar.
The Template List appears, displaying 10 IPsec Templates.
Click the **Delete** button to delete an **IPsec Template**. When an **IPsec Template** is in use, it cannot be deleted.
7. Click **IPsec Template** that you want to create. The **IPsec Template** screen appears. The configuration fields differ based on the **Use Prefixed Template** and **Internet Key Exchange (IKE)** you select.
8. In the **Template Name** field, type a name for the template (up to 16 characters).
9. If you selected **Custom** in the **Use Prefixed Template** drop-down list, select the **Internet Key Exchange (IKE)** options, and then change the settings if needed.
10. Click **Submit**.

IPsec Template 1



Template Name
Use Prefixed Template

Internet Key Exchange (IKE) IKEv1

Authentication Type

Diffie-Hellman Group
Group14
Encryption
AES-CBC 256
Hash
SHA256
SHA512
SA Lifetime
(240 – 63072000)

(10 – 2097152)

Encapsulating Security

Protocol
Encryption
AES-CBC 256
Hash
SHA256
SHA512
SA Lifetime
(240 – 63072000)

(10 – 2097152)
Encapsulation Mode Transport Tunnel
Remote Router IP-Address

Perfect Forward Secrecy (PFS) Enabled Disabled

Authentication Method Pre-Shared Key
 Certificates

Pre-Shared Key

Local

ID Type
ID

Remote

ID Type
ID

[Certificate>>](#)



Related Information

- Manage Your Network Machine Securely Using IPsec
 - IKEv1 Settings for an IPsec Template
 - IKEv2 Settings for an IPsec Template
 - Manual Settings for an IPsec Template

IKEv1 Settings for an IPsec Template

IPsec Template 1 ?

Template Name

Use Prefixed Template

Internet Key Exchange (IKE) IKEv1 IKEv2 Manual

Authentication Type

Diffie-Hellman Group

Encryption

Hash

SA Lifetime second(s)
(240 – 63072000)

KByte
(10 – 2097152)

Encapsulating Security

Protocol ESP AH AH+ESP

Encryption

Hash

SA Lifetime second(s)
(120 – 4233600)

KByte
(10 – 4194304)

Encapsulation Mode Transport Tunnel

Remote Router IP-Address

Perfect Forward Security (PFS) Enabled Disabled

Authentication Method Pre-Shared Key Certificates

Pre-Shared Key

Local

ID Type

ID

Remote

ID Type

ID

[Certificate>>](#)

Template Name

Type a name for the template (up to 16 characters).

Use Prefixed Template

Select **Custom**, **IKEv1 High Security** or **IKEv1 Medium Security**. The setting items are different depending on the selected template.



The default template differs depending on whether you chose **Main** or **Aggressive** for **Negotiation Mode** on the **IPsec** configuration screen.

Internet Key Exchange (IKE)

IKE is a communication protocol that is used to exchange encryption keys in order to carry out encrypted communication using IPsec. To carry out encrypted communication for that time only, the encryption algorithm that is necessary for IPsec is determined and the encryption keys are shared. For IKE, the encryption keys are exchanged using the Diffie-Hellman key exchange method, and encrypted communication that is limited to IKE is carried out.

If you selected **Custom** in **Use Prefixed Template**, select **IKEv1**.

Authentication Type

Configure the IKE authentication and encryption.

- **Diffie-Hellman Group**

This key exchange method allows secret keys to be securely exchanged over an unprotected network. The Diffie-Hellman key exchange method uses a discrete logarithm problem, not the secret key, to send and receive open information that was generated using a random number and the secret key.

Select **Group1**, **Group2**, **Group5**, or **Group14**.

- **Encryption**

Select **DES**, **3DES**, **AES-CBC 128**, or **AES-CBC 256**.

- **Hash**

Select **MD5**, **SHA1**, **SHA256**, **SHA384** or **SHA512**.

- **SA Lifetime**

Specify the IKE SA lifetime.

Type the time (seconds) and number of kilobytes (KByte).

Encapsulating Security

- **Protocol**

Select **ESP**, **AH** or **AH+ESP**.



-
- ESP is a protocol for carrying out encrypted communication using IPsec. ESP encrypts the payload (communicated contents) and adds additional information. The IP packet is comprised of the header and the encrypted payload, which follows the header. In addition to the encrypted data, the IP packet also includes information regarding the encryption method and encryption key, the authentication data, and so on.
 - AH is part of the IPsec protocol that authenticates the sender and prevents manipulation (ensures the completeness) of the data. In the IP packet, the data is inserted immediately after the header. In addition, the packets include hash values, which are calculated using an equation from the communicated contents, secret key, and so on, in order to prevent the falsification of the sender and manipulation of the data. Unlike ESP, the communicated contents are not encrypted, and the data is sent and received as plain text.
-

- **Encryption**

Select **DES**, **3DES**, **AES-CBC 128**, or **AES-CBC 256**. The encryption can be selected only when **ESP** is selected in **Protocol**.

- **Hash**

Select **None**, **MD5**, **SHA1**, **SHA256**, **SHA384**, or **SHA512**.

When **AH+ESP** is selected in **Protocol**, select each protocol for **Hash(ESP)** and **Hash(AH)**.

- **SA Lifetime**

Specify the IPsec SA lifetime.

Type the time (seconds) and number of kilobytes (KByte) before the IPsec SA will expire.

- **Encapsulation Mode**

Select **Transport** or **Tunnel**.

- **Remote Router IP-Address**

Type the IP address (IPv4 or IPv6) of the remote router. Enter this information only when the **Tunnel** mode is selected.



SA (Security Association) is an encrypted communication method using IPsec or IPv6 that exchanges and shares information, such as the encryption method and encryption key, in order to establish a secure communication channel before communication begins. SA may also refer to a virtual encrypted communication channel that has been established. The SA used for IPsec establishes the encryption method, exchanges the keys, and carries out mutual authentication according to the IKE (Internet Key Exchange) standard procedure. In addition, the SA is updated periodically.

Perfect Forward Secrecy (PFS)

PFS does not derive keys from previous keys that were used to encrypt messages. In addition, if a key that is used to encrypt a message was derived from a parent key, that parent key is not used to derive other keys. Therefore, even if a key is compromised, the damage will be limited only to the messages that were encrypted using that key.

Select **Enabled** or **Disabled**.

Authentication Method

Select the authentication method. Select **Pre-Shared Key** or **Certificates**.

Pre-Shared Key

When encrypting communication, the encryption key is exchanged and shared beforehand using another channel.

If you selected **Pre-Shared Key** for the **Authentication Method**, type the **Pre-Shared Key** (up to 32 characters).

- **Local/ID Type/ID**

Select the sender's ID type, and then type the ID.

Select **IPv4 Address**, **IPv6 Address**, **FQDN**, **E-mail Address**, or **Certificate** for the type.

If you select **Certificate**, type the common name of the certificate in the **ID** field.

- **Remote/ID Type/ID**

Select the recipient's ID type, and then type the ID.

Select **IPv4 Address**, **IPv6 Address**, **FQDN**, **E-mail Address**, or **Certificate** for the type.

If you select **Certificate**, type the common name of the certificate in the **ID** field.

Certificate

If you selected **Certificates** for **Authentication Method**, select the certificate.



You can select only the certificates that were created using the **Certificate** page of Web Based Management's Security configuration screen.



Related Information

- [Configure an IPsec Template Using Web Based Management](#)
-

IKEv2 Settings for an IPsec Template

IPsec Template 1 ?

Template Name

Use Prefixed Template

Internet Key Exchange (IKE) IKEv1 IKEv2 Manual

Authentication Type

Diffie-Hellman Group Group1 Group2 Group5 Group14

Encryption DES 3DES AES-CBC 128
 AES-CBC 256

Hash MD5 SHA1 SHA256 SHA384
 SHA512

SA Lifetime second(s)
(240 – 63072000)
 KByte
(10 – 2097152)

Encapsulating Security

Protocol ESP

Encryption DES 3DES AES-CBC 128
 AES-CBC 256

Hash MD5 SHA1 SHA256 SHA384
 SHA512

SA Lifetime second(s)
(120 – 4233600)
 KByte
(10 – 4194304)

Encapsulation Mode Transport Tunnel

Remote Router IP-Address

Perfect Forward Secrecy (PFS) Enabled Disabled

Authentication Method Pre-Shared Key
 Certificates
 EAP - MD5
 EAP - MS-CHAPv2

Pre-Shared Key

Local

ID Type

ID

Remote

ID Type

ID

[Certificate>>](#)

Template Name

Type a name for the template (up to 16 characters).

Use Prefixed Template

Select **Custom**, **IKEv2 High Security**, or **IKEv2 Medium Security**. The setting items are different depending on the selected template.

Internet Key Exchange (IKE)

IKE is a communication protocol that is used to exchange encryption keys in order to carry out encrypted communication using IPsec. To carry out encrypted communication for that time only, the encryption algorithm that is necessary for IPsec is determined and the encryption keys are shared. For IKE, the encryption keys are exchanged using the Diffie-Hellman key exchange method, and encrypted communication that is limited to IKE is carried out.

If you selected **Custom** in **Use Prefixed Template**, select **IKEv2**.

Authentication Type

Configure the IKE authentication and encryption.

- **Diffie-Hellman Group**

This key exchange method allows secret keys to be securely exchanged over an unprotected network. The Diffie-Hellman key exchange method uses a discrete logarithm problem, not the secret key, to send and receive open information that was generated using a random number and the secret key.

Select **Group1**, **Group2**, **Group5**, or **Group14**.

- **Encryption**

Select **DES**, **3DES**, **AES-CBC 128**, or **AES-CBC 256**.

- **Hash**

Select **MD5**, **SHA1**, **SHA256**, **SHA384** or **SHA512**.

- **SA Lifetime**

Specify the IKE SA lifetime.

Type the time (seconds) and number of kilobytes (KByte).

Encapsulating Security

- **Protocol**

Select **ESP**.



ESP is a protocol for carrying out encrypted communication using IPsec. ESP encrypts the payload (communicated contents) and adds additional information. The IP packet is comprised of the header and the encrypted payload, which follows the header. In addition to the encrypted data, the IP packet also includes information regarding the encryption method and encryption key, the authentication data, and so on.

- **Encryption**

Select **DES**, **3DES**, **AES-CBC 128**, or **AES-CBC 256**.

- **Hash**

Select **MD5**, **SHA1**, **SHA256**, **SHA384**, or **SHA512**.

- **SA Lifetime**

Specify the IPsec SA lifetime.

Type the time (seconds) and number of kilobytes (KByte) before the IPsec SA will expire.

- **Encapsulation Mode**

Select **Transport** or **Tunnel**.

- **Remote Router IP-Address**

Type the IP address (IPv4 or IPv6) of the remote router. Enter this information only when the **Tunnel** mode is selected.



SA (Security Association) is an encrypted communication method using IPsec or IPv6 that exchanges and shares information, such as the encryption method and encryption key, in order to establish a secure communication channel before communication begins. SA may also refer to a virtual encrypted communication channel that has been established. The SA used for IPsec establishes the encryption method, exchanges the keys, and carries out mutual authentication according to the IKE (Internet Key Exchange) standard procedure. In addition, the SA is updated periodically.

Perfect Forward Secrecy (PFS)

PFS does not derive keys from previous keys that were used to encrypt messages. In addition, if a key that is used to encrypt a message was derived from a parent key, that parent key is not used to derive other keys. Therefore, even if a key is compromised, the damage will be limited only to the messages that were encrypted using that key.

Select **Enabled** or **Disabled**.

Authentication Method

Select the authentication method. Select **Pre-Shared Key**, **Certificates**, **EAP - MD5**, or **EAP - MS-CHAPv2**.

Pre-Shared Key

When encrypting communication, the encryption key is exchanged and shared beforehand using another channel.

If you selected **Pre-Shared Key** for the **Authentication Method**, type the **Pre-Shared Key** (up to 32 characters).

- **Local/ID Type/ID**

Select the sender's ID type, and then type the ID.

Select **IPv4 Address**, **IPv6 Address**, **FQDN**, **E-mail Address**, or **Certificate** for the type.

If you select **Certificate**, type the common name of the certificate in the **ID** field.

- **Remote/ID Type/ID**

Select the recipient's ID type, and then type the ID.

Select **IPv4 Address**, **IPv6 Address**, **FQDN**, **E-mail Address**, or **Certificate** for the type.

If you select **Certificate**, type the common name of the certificate in the **ID** field.

Certificate

If you selected **Certificates** for **Authentication Method**, select the certificate.



You can select only the certificates that were created using the **Certificate** page of Web Based Management's Security configuration screen.

EAP

EAP is an authentication protocol that is an extension of PPP. By using EAP with IEEE802.1x, a different key is used for user authentication during each session.

The following settings are necessary only when **EAP - MD5** or **EAP - MS-CHAPv2** is selected in **Authentication Method**:

- **Mode**

Select **Server-Mode** or **Client-Mode**.

- **Certificate**

Select the certificate.

- **User Name**

Type the user name (up to 32 characters).

- **Password**

Type the password (up to 32 characters). The password must be entered two times for confirmation.



Related Information

- [Configure an IPsec Template Using Web Based Management](#)

Manual Settings for an IPsec Template

IPsec Template 1 ?

Template Name

Use Prefixed Template

Internet Key Exchange (IKE) IKEv1 IKEv2 Manual

Authentication Key (ESP, AH)

In

Out

Code key (ESP)

In

Out

SPI

In

Out

Encapsulating Security

Protocol ESP AH

Encryption

Hash

SA Lifetime second(s)
(120 – 4233600)

KByte
(10 – 4194304)

Encapsulation Mode Transport Tunnel

Remote Router IP-Address

[Certificate](#)

Template Name

Type a name for the template (up to 16 characters).

Use Prefixed Template

Select **Custom**.

Internet Key Exchange (IKE)

IKE is a communication protocol that is used to exchange encryption keys in order to carry out encrypted communication using IPsec. To carry out encrypted communication for that time only, the encryption algorithm that is necessary for IPsec is determined and the encryption keys are shared. For IKE, the encryption keys are exchanged using the Diffie-Hellman key exchange method, and encrypted communication that is limited to IKE is carried out.

Select **Manual**.

Authentication Key (ESP,AH)

Specify the key to use for authentication. Type the **In/Out** values.

These settings are necessary when **Custom** is selected for **Use Prefixed Template**, **Manual** is selected for **Internet Key Exchange (IKE)**, and a setting other than **None** is selected for **Hash** for **Encapsulating Security** section.



The number of characters you can set differs depending on the setting you chose for **Hash** in the **Encapsulating Security** section.

If the length of the specified authentication key is different than the selected hash algorithm, an error will occur.

- **MD5**: 128 bits (16 bytes)
- **SHA1**: 160 bits (20 bytes)
- **SHA256**: 256 bits (32 bytes)
- **SHA384**: 384 bits (48 bytes)
- **SHA512**: 512 bits (64 bytes)

When you specify the key in ASCII Code, enclose the characters in double quotation marks (").

Code key (ESP)

Specify the key to use for encryption. Type the **In/Out** values.

These settings are necessary when **Custom** is selected in **Use Prefixed Template**, **Manual** is selected in **Internet Key Exchange (IKE)**, and **ESP** is selected in **Protocol** in **Encapsulating Security**.



The number of characters you can set differs depending on the setting you chose for **Encryption** in the **Encapsulating Security** section.

If the length of the specified code key is different than the selected encryption algorithm, an error will occur.

- **DES**: 64 bits (8 bytes)
- **3DES**: 192 bits (24 bytes)
- **AES-CBC 128**: 128 bits (16 bytes)
- **AES-CBC 256**: 256 bits (32 bytes)

When you specify the key in ASCII Code, enclose the characters in double quotation marks (").

SPI

These parameters are used to identify security information. Generally, a host has multiple Security Associations (SAs) for several types of IPsec communication. Therefore, it is necessary to identify the applicable SA when an IPsec packet is received. The SPI parameter, which identifies the SA, is included in the Authentication Header (AH) and Encapsulating Security Payload (ESP) header.

These settings are necessary when **Custom** is selected for **Use Prefixed Template**, and **Manual** is selected for **Internet Key Exchange (IKE)**.

Enter the **In/Out** values. (3-10 characters)

Encapsulating Security

- **Protocol**
Select **ESP** or **AH**.



-
- ESP is a protocol for carrying out encrypted communication using IPsec. ESP encrypts the payload (communicated contents) and adds additional information. The IP packet is comprised of the header and the encrypted payload, which follows the header. In addition to the encrypted data, the IP packet also includes information regarding the encryption method and encryption key, the authentication data, and so on.
 - AH is part of the IPsec protocol that authenticates the sender and prevents manipulation of the data (ensures the completeness of the data). In the IP packet, the data is inserted immediately after the header. In addition, the packets include hash values, which are calculated using an equation from the communicated contents, secret key, and so on, in order to prevent the falsification of the sender and manipulation of the data. Unlike ESP, the communicated contents are not encrypted, and the data is sent and received as plain text.
-

- **Encryption**

Select **DES**, **3DES**, **AES-CBC 128**, or **AES-CBC 256**. The encryption can be selected only when **ESP** is selected in **Protocol**.

- **Hash**

Select **None**, **MD5**, **SHA1**, **SHA256**, **SHA384**, or **SHA512**. **None** can be selected only when **ESP** is selected in **Protocol**.

- **SA Lifetime**

Specify the IKE SA lifetime.

Type the time (seconds) and number of kilobytes (KByte) before the IPsec SA will expire.

- **Encapsulation Mode**

Select **Transport** or **Tunnel**.

- **Remote Router IP-Address**

Specify the IP address (IPv4 or IPv6) of the connection destination. Enter this information only when the **Tunnel** mode is selected.



SA (Security Association) is an encrypted communication method using IPsec or IPv6 that exchanges and shares information, such as the encryption method and encryption key, in order to establish a secure communication channel before communication begins. SA may also refer to a virtual encrypted communication channel that has been established. The SA used for IPsec establishes the encryption method, exchanges the keys, and carries out mutual authentication according to the IKE (Internet Key Exchange) standard procedure. In addition, the SA is updated periodically.



Related Information

- [Configure an IPsec Template Using Web Based Management](#)
-

Send or Receive an Email Securely

- [Configure Email Sending or Receiving Using Web Based Management](#)
- [Send an Email with User Authentication](#)
- [Send or Receive an Email Securely Using SSL TLS](#)

Configure Email Sending or Receiving Using Web Based Management

Email Receiving is only available for DocuPrint M385 z/DocuPrint M375 z.

We recommend using Web Based Management to configure secured email sending with user authentication, or email sending and receiving using SSL/TLS.

1. Start your web browser.
2. Type "http://machine's IP address" in your browser's address bar (where "machine's IP address" is the machine's IP address).

For example:

http://192.0.2.1



- If you are using a Domain Name System or enable a NetBIOS name, you can type another name, such as "SharedPrinter" instead of the IP address.

- For example:

http://SharedPrinter

If you enable a NetBIOS name, you can also use the node name.

- For example:

http://fxnxxxxxxxxxxxx

The NetBIOS name can be found in the Network Configuration Report.

- For Mac, access Web Based Management by clicking the machine's icon on the **Status Monitor** screen.

3. Type a password, and then click . The default password is "x-admin". To ensure security, it is important you change the password.
4. Click the **Network** tab.
5. Click **Protocol** in the left navigation bar.
6. Do one of the following:
 - (DocuPrint M375 df)
In the **SMTP** field, click **Advanced Settings** and make sure the status of **SMTP** is **Enabled**.
 - (DocuPrint M385 z/DocuPrint M375 z)
In the **POP3/IMAP4/SMTP** field, click **Advanced Settings** and make sure the status of **POP3/IMAP4/SMTP** is **Enabled**.
7. Do one of the following:
 - (DocuPrint M375 df)
Configure the **SMTP** settings.
 - (DocuPrint M385 z/DocuPrint M375 z)
Configure the **POP3/IMAP4/SMTP** settings.



- Confirm that the email settings are correct after configuration by sending a test email.
- If you do not know the POP3/IMAP4/SMTP server settings, contact your network administrator or Internet Service Provider (ISP).

8. When finished, click **Submit**.
 - (DocuPrint M375 df)
The **Test Send E-mail Configuration** dialog box appears.
 - (DocuPrint M385 z/DocuPrint M375 z)
The **Test Send/Receive E-mail Configuration** dialog box appears.

9. Follow the instructions in the dialog box to test the current settings.



Related Information

- [Send or Receive an Email Securely](#)
-

Send an Email with User Authentication

Related Models: DocuPrint M385 z/DocuPrint M375 z

Your Fuji Xerox machine supports the SMTP-AUTH method to send email via an email server that requires user authentication. This method prevents unauthorised users from accessing the email server.

You can use SMTP-AUTH for email notification, email reports and I-Fax (available for certain models).



We recommend using Web Based Management to configure the SMTP authentication.

Email Server Settings

You must configure your machine's SMTP authentication method to match the method used by your email server. For details about your email server settings, contact your network administrator or Internet Service Provider (ISP).



- (DocuPrint M375 df)
To enable SMTP server authentication: in the Web Based Management **SMTP** screen, under **Server Authentication Method**, you must select **SMTP-AUTH**.
- (DocuPrint M385 z/DocuPrint M375 z)
To enable SMTP server authentication: in the Web Based Management **POP3/IMAP4/SMTP** screen, under **Server Authentication Method**, you must select **SMTP-AUTH**.



Related Information

- [Send or Receive an Email Securely](#)

Send or Receive an Email Securely Using SSL TLS

Email Receiving is only available for DocuPrint M385 z/DocuPrint M375 z.

Your Fuji Xerox machine supports SSL/TLS methods to send or receive an email via an email server that requires secure SSL/TLS communication. To send or receive email via an email server that is using SSL/TLS communication, you must configure SMTP over SSL/TLS, POP3 ¹ over SSL/TLS, or IMAP4 ¹ over SSL/TLS.



We recommend using Web Based Management to configure SSL/TLS.

Verify Server Certificate

Under **SSL/TLS**, if you choose **SSL** or **TLS**, the **Verify Server Certificate** check box will be selected automatically.

(DocuPrint M375 df)

SMTP

Status Enabled

Send E-mail Settings(SMTP)

Server Address

Port

Server Authentication Method None SMTP-AUTH

SMTP-AUTH Account Name

SMTP-AUTH Account Password

Enter password

Retype password

SSL/TLS None SSL TLS Verify Server Certificate

Device E-mail Address

[CA Certificate>>](#)

[E-mail report>>](#)

[Notification>>](#)

¹ DocuPrint M385 z/DocuPrint M375 z

POP3/IMAP4/SMTP



Status Enabled

Send E-mail Settings(SMTP)

Server Address

Port

Server Authentication Method None
 SMTP-AUTH

SMTP-AUTH Account Name

SMTP-AUTH Account Password

Enter password

Retype password

SSL/TLS None
 SSL
 TLS
 Verify Server Certificate

Device E-mail Address

Receive E-mail Settings(POP3/IMAP4)

Protocol POP3 IMAP4

Server Address

Port

Mailbox Name

Mailbox Password

Enter password

Retype password

Use APOP (POP3 Only)

Select Mail Folder Name(IMAP4 Only) Default(Inbox)
 Specified :

SSL/TLS None
 SSL
 TLS
 Verify Server Certificate

Segmented Message Timeout minute(s)

[I-Fax>>](#)

[CA Certificate>>](#)

[E-mail report>>](#)

[Notification>>](#)



- Before you verify the server certificate, you must import the CA certificate issued by the CA that signed the server certificate. Contact your network administrator or your Internet Service Provider (ISP) to confirm if importing a CA certificate is necessary.
- If you do not need to verify the server certificate, clear the **Verify Server Certificate** check box.

Port Number

If you select **SSL** or **TLS** for SMTP, POP3 ¹, or IMAP4 ¹, the **Port** value will be changed to match the protocol. To change the port number manually, type the port number after you choose **SSL** or **TLS** for the **SSL/TLS** settings.

You must configure your machine's POP3 ¹/IMAP4 ¹/SMTP communication method to match the method used by your email server. For details about your email server settings, contact your network administrator or your ISP.

In most cases, the secured webmail services require the following settings:

SMTP	Port	25
	Server Authentication Method	SMTP-AUTH
	SSL/TLS	TLS
POP3 ^{*1}	Port	995
	SSL/TLS	SSL
IMAP4 ^{*1}	Port	993
	SSL/TLS	SSL

^{*1} DocuPrint M385 z/DocuPrint M375 z



Related Information

- [Send or Receive an Email Securely](#)

¹ DocuPrint M385 z/DocuPrint M375 z

Use IEEE 802.1x Authentication for a Wired or a Wireless Network

- [What Is IEEE 802.1x Authentication?](#)
- [Configure IEEE 802.1x Authentication for a Wired or a Wireless Network Using Web Based Management \(Web Browser\)](#)
- [IEEE 802.1x Authentication Methods](#)

What Is IEEE 802.1x Authentication?

IEEE 802.1x is an IEEE standard for wired and wireless networks that limits access from unauthorised network devices. Your Fuji Xerox machine (supplicant) sends an authentication request to a RADIUS server (Authentication server) through your access point or HUB. After your request has been verified by the RADIUS server, your machine can access the network.



Related Information

- [Use IEEE 802.1x Authentication for a Wired or a Wireless Network](#)
-

Configure IEEE 802.1x Authentication for a Wired or a Wireless Network Using Web Based Management (Web Browser)

- If you configure your machine using EAP-TLS authentication, you must install the client certificate issued by a CA before you start configuration. Contact your network administrator about the client certificate. If you have installed more than one certificate, we recommend writing down the certificate name you want to use.
- Before you verify the server certificate, you must import the CA certificate that has been issued by the CA that signed the server certificate. Contact your network administrator or your Internet Service Provider (ISP) to confirm whether a CA certificate import is necessary.



You can also configure IEEE 802.1x authentication using:

- Wireless setup wizard from the control panel (Wireless network)
- Wireless setup wizard on the Fuji Xerox installation disc (Wireless network)

1. Start your web browser.
2. Type "http://machine's IP address" in your browser's address bar (where "machine's IP address" is the machine's IP address).

For example:

http://192.0.2.1



- If you are using a Domain Name System or enable a NetBIOS name, you can type another name, such as "SharedPrinter" instead of the IP address.

- For example:

http://SharedPrinter

If you enable a NetBIOS name, you can also use the node name.

- For example:

http://fxnxxxxxxxxxxxx

The NetBIOS name can be found in the Network Configuration Report.

- For Mac, access Web Based Management by clicking the machine's icon on the **Status Monitor** screen.

3. Type a password, and then click . The default password is "x-admin". To ensure security, it is important you change the password.
4. Click the **Network** tab.
5. Do one of the following:

Option	Description
Wired network	Click the Wired tab in the left navigation bar, and then select Wired 802.1x Authentication .
Wireless network	Click the Wireless tab in the left navigation bar, and then select Wireless (Enterprise) .

6. Configure the IEEE 802.1x authentication settings.



- To enable IEEE 802.1x authentication for wired networks, select **Enabled** for **Wired 802.1x status** on the **Wired 802.1x Authentication** page.
- If you are using **EAP-TLS** authentication, you must select the client certificate that has been installed (shown with certificate name) for verification from the **Client Certificate** drop-down list.
- If you select **EAP-FAST**, **PEAP**, **EAP-TTLS**, or **EAP-TLS** authentication, select the verification method from the **Server Certificate Verification** drop-down list. Verify the server certificate using the CA certificate, imported to the machine in advance, that has been issued by the CA that signed the server certificate.

Select one of the following verification methods from the **Server Certificate Verification** drop-down list:

Option	Description
No Verification	The server certificate can always be trusted. The verification is not performed.
CA Cert.	The verification method to check the CA reliability of the server certificate, using the CA certificate that has been issued by the CA that signed the server certificate.
CA Cert. + ServerID	The verification method to check the common name ^{*1} value of the server certificate, in addition to the CA reliability of the server certificate.

^{*1} The common name verification compares the common name of the server certificate to the character string configured for the **Server ID**. Before you use this method, contact your system administrator about the server certificate's common name and then configure **Server ID**.

7. When finished with configuration, click **Submit**.

For wired networks: After configuring, connect your machine to the IEEE 802.1x supported network. After a few minutes, print the Network Configuration Report to check the **<Wired IEEE 802.1x>** Status.

Option	Description
Success	The wired IEEE 802.1x function is enabled and the authentication was successful.
Failed	The wired IEEE 802.1x function is enabled; however, the authentication failed.
Off	The wired IEEE 802.1x function is not available.



Related Information

- [Use IEEE 802.1x Authentication for a Wired or a Wireless Network](#)

IEEE 802.1x Authentication Methods

LEAP(Wireless network)

Lightweight Extensible Authentication Protocol (LEAP) is a proprietary EAP method developed by Cisco Systems, Inc., which uses a user ID and password for authentication.

EAP-FAST

Extensible Authentication Protocol-Flexible Authentication via Secured Tunneling (EAP-FAST) has been developed by Cisco Systems, Inc., which uses a user ID and password for authentication, and symmetric key algorithms to achieve a tunnelled authentication process.

The Fuji Xerox machine supports the following inner authentication methods:

- EAP-FAST/NONE
- EAP-FAST/MS-CHAPv2
- EAP-FAST/GTC

EAP-MD5(Wired network)

Extensible Authentication Protocol-Message Digest Algorithm 5 (EAP-MD5) uses a user ID and password for challenge-response authentication.

PEAP

Protected Extensible Authentication Protocol (PEAP) is a version of EAP method developed by Cisco Systems, Inc., Microsoft® Corporation and RSA Security. PEAP creates an encrypted Secure Sockets Layer (SSL)/Transport Layer Security (TLS) tunnel between a client and an authentication server, for sending a user ID and password. PEAP provides mutual authentication between the server and the client.

The Fuji Xerox machine supports the following inner authentications:

- PEAP/MS-CHAPv2
- PEAP/GTC

EAP-TTLS

Extensible Authentication Protocol-Tunneled Transport Layer Security (EAP-TTLS) has been developed by Funk Software and Certicom. EAP-TTLS creates a similar encrypted SSL tunnel to PEAP, between a client and an authentication server, for sending a user ID and password. EAP-TTLS provides mutual authentication between the server and the client.

The Fuji Xerox machine supports the following inner authentications:

- EAP-TTLS/CHAP
- EAP-TTLS/MS-CHAP
- EAP-TTLS/MS-CHAPv2
- EAP-TTLS/PAP

EAP-TLS

Extensible Authentication Protocol-Transport Layer Security (EAP-TLS) requires digital certificate authentication both at a client and an authentication server.



Related Information

- [Use IEEE 802.1x Authentication for a Wired or a Wireless Network](#)

Store Print Log to Network

- [Store Log to Network Overview](#)
- [Configure the Store Print Log to Network Settings Using Web Based Management](#)
- [Use the Store Print Log to Network's Error Detection Setting](#)
- [Use Store Print Log to Network with Secure Function Lock 3.0](#)

Store Log to Network Overview

The Store Print Log to Network feature allows you to save the print log file from your Fuji Xerox machine to a network server using the Common Internet File System (CIFS) protocol. You can record the ID, type of print job, job name, user name, date, time and the number of printed pages for every print job. CIFS is a protocol that runs over TCP/IP, allowing computers on a network to share files over an intranet or the Internet.

The following print functions are recorded in the print log:

- Print jobs from your computer
- USB Direct Print (supported models only)
- Copy
- Received Fax (supported models only)



- The Store Print Log to Network feature supports Kerberos authentication and NTLMv2 authentication. You must configure the SNTP protocol (network time server), or you must set the date, time and time zone correctly on the control panel for authentication.
- You can set the file type to TXT or CSV when storing a file to the server.





Related Information

- [Store Print Log to Network](#)

Configure the Store Print Log to Network Settings Using Web Based Management

1. Start your web browser.
2. Type "http://machine's IP address" in your browser's address bar (where "machine's IP address" is the machine's IP address).
For example:
http://192.0.2.1
3. Type a password, and then click . The default password is "x-admin". To ensure security, it is important you change the password.
4. Click the **Administrator** tab.
5. Click the **Store Print Log to Network** menu.
6. In the **Print Log** field, click **On**.
7. Configure the following settings:

Option	Description
Network Folder Path	Type the destination folder where your log will be stored on the CIFS server (for example: fujixerox\abc).
File Name	Type the file name you want to use for the print log (up to 32 characters).
File Type	Select the TXT or CSV option for the Print Log file type.
Auth. Method	<p>Select the authentication method required for access to the CIFS server: Auto, Kerberos, or NTLMv2. Kerberos is an authentication protocol which allows devices or individuals to securely prove their identity to network servers using a single sign-on. NTLMv2 is the authentication method used by Windows® to log into servers.</p> <ul style="list-style-type: none">• Auto: If you select Auto, NTLMv2 will be used to the authentication method.• Kerberos: Select the Kerberos option to use Kerberos authentication only.• NTLMv2: Select the NTLMv2 option to use NTLMv2 authentication only. <p> For the Kerberos and NTLMv2 authentication, you must also configure the Date&Time settings or the SNTP protocol (network time server) and DNS server.</p> <ul style="list-style-type: none">• You can also configure the Date & Time settings from the machine's control panel.
Username	Type the user name for the authentication (up to 96 characters).  If the user name is part of a domain, enter the user name in one of the following styles: user@domain or domain\user.
Password	Type the password for the authentication (up to 32 characters).
Kerberos Server Address (if needed)	Type the KDC host address (for example: kerberos.example.com; up to 64 characters) or the IP address.
Error Detection Setting	Choose what action should be taken when the Print Log cannot be stored to the server due to a network error.

8. In the **Connection Status** field, confirm the last log status.



You can also confirm the error status on the LCD of your machine.

9. Click **Submit** to display the **Test Print Log to Network** page.

To test your settings, click **Yes** and then go to the next step.

To skip the test, click **No**. Your settings will be submitted automatically.

10. The machine will test your settings.

11. If your settings are accepted, **Test OK** appears on the screen.

If **Test Error** appears, check all settings, and then click **Submit** to display the Test page again.



Related Information

- [Store Print Log to Network](#)

Related Topics

- [Synchronize Time with the SNTP Server Using Web Based Management](#)
 - [Configure the SNTP Protocol Using Web Based Management](#)
-

Use the Store Print Log to Network's Error Detection Setting

Use Error Detection Settings to determine the action that is taken when the print log cannot be stored to the server due to a network error.

1. Start your web browser.
2. Type "http://machine's IP address" in your browser's address bar (where "machine's IP address" is the machine's IP address).
For example:
http://192.0.2.1
3. Type a password, and then click . The default password is "x-admin". To ensure security, it is important you change the password.
4. Click the **Administrator** tab.
5. Click the **Store Print Log to Network** menu in the left navigation bar.
6. In the **Error Detection Setting** section, select the **Cancel Print** or **Ignore Log & Print** option.

Option	Description
Cancel Print	If you select the Cancel Print option, the print jobs are cancelled when the print log cannot be stored to the server.  Even if you select the Cancel Print option, your machine will print a received fax.

Ignore Log & Print If you select the **Ignore Log & Print** option, the machine prints the documentation even if the print log cannot be stored to the server.

When the store print log function has recovered, the print log is recorded as follows:

```
Id, Type, Job Name, User Name, Date, Time, Print Pages
1, Print (xxxxxxx), "Document01.doc", "user01", 03/03/20xx, 14:01:32, 52
2, Print (xxxxxxx), "Document02.doc", "user01", 03/03/20xx, 14:45:30, ?
3, <ERROR>, ?, ?, ?, ?, ?
4, Print (xxxxxxx), "Report01.xls", "user02", 03/03/20xx, 19:30:40, 4
```

a —

b —

- a. If the log cannot be stored at the end of printing, the print log except the number of printed pages will be recorded.
- b. If the print log cannot be stored at the beginning and the end of printing, the print log of the job will not be recorded. When the function has recovered, the error is reflected in the log.

7. Click **Submit** to display the **Test Print Log to Network** page.
To test your settings, click **Yes** and then go to the next step.
To skip the test, click **No**. Your settings will be submitted automatically.
8. The machine will test your settings.
9. If your settings are accepted, **Test OK** appears on the screen.
If **Test Error** appears, check all settings, and then click **Submit** to display the Test page again.

Related Information

- [Store Print Log to Network](#)

Use Store Print Log to Network with Secure Function Lock 3.0

When Secure Function Lock 3.0 is active, the names of the registered users for copy, Fax RX and USB Direct Print (if available) are recorded in the Store Print Log to Network report. When the Active Directory® Authentication is enabled, logged on user name will be recorded in the Store Print Log to Network report:

```
Id, Type, Job Name, User Name, Date, Time, Print Pages
1, Copy, -, -, 04/04/20xx, 09:05:12, 3
2, Fax, -, -, 04/04/20xx, 09:45:30, 5
3, Copy, -, "BOB", 04/04/20xx, 10:20:30, 4
4, Fax, -, "BOB", 04/04/20xx, 10:35:12, 3
5, USB Direct, -, "JOHN", 04/04/20xx, 11:15:43, 6
```



Related Information

- [Store Print Log to Network](#)

Mobile

- [Google Cloud Print](#)
- [Mobile Printing for Windows®](#)
- [Mopria® Print Service](#)
- [Print Utility](#)

Google Cloud Print

- [Google Cloud Print Overview](#)
- [Before Using Google Cloud Print](#)
- [Print from Google Chrome™ or Chrome OS™](#)
- [Print from Google Drive™ for Mobile](#)
- [Print from Gmail™ Webmail Service for Mobile](#)

Google Cloud Print Overview

Related Models: DocuPrint M375 z/DocuPrint M375 df

Google Cloud Print™ is a Google service that allows you to print to a printer registered to your Google account using a network-compatible device (such as a mobile phone or computer) without installing the printer driver on the device.

Printing from Android™ apps requires installing the Google Cloud Print™ app from the Google Play™ Store.

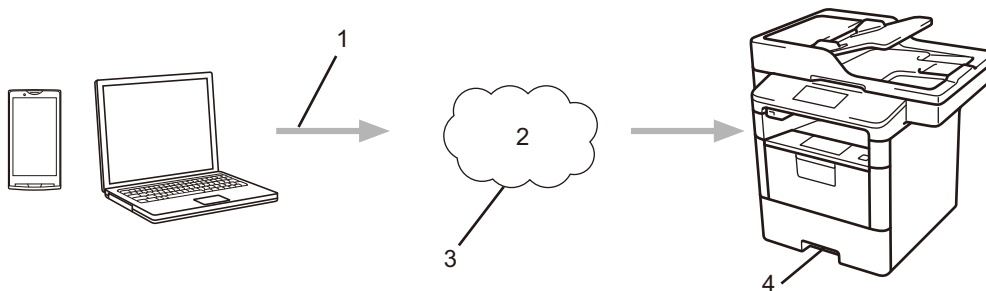

1. Print request
2. Internet
3. Google Cloud Print™
4. Printing

✓ Related Information

- [Google Cloud Print](#)

Before Using Google Cloud Print

- [Network Settings for Using Google Cloud Print](#)
- [Register Your Machine with Google Cloud Print Using Google Chrome™](#)
- [Register Your Machine with Google Cloud Print Using Web Based Management](#)

Network Settings for Using Google Cloud Print

Related Models: DocuPrint M375 z/DocuPrint M375 df

In order to use Google Cloud Print™, your Fuji Xerox machine must be connected to a network that has access to the Internet, either through a wired or wireless connection. To connect and configure your machine correctly, see the *Quick Setup Guide* or related topics in this guide.



Related Information

- [Before Using Google Cloud Print](#)

Related Topics

- [Google Cloud Print Problems](#)

Register Your Machine with Google Cloud Print Using Google Chrome™

Related Models: DocuPrint M375 z/DocuPrint M375 df

Make sure you have already created a Google Account. If you do not have an account, use a computer or mobile device to access the Google website (<https://accounts.google.com/signup>) and create an account.
Make sure your Fuji Xerox machine is idle before starting the registration process.



The steps in this section are examples for Windows® users.
Screens on your computer may vary depending on your operating system and environment.

1. Open Google Chrome™ on your computer.
2. Sign in to your Google Account.
3. Click the Google Chrome™ menu icon, and then **Settings > Show advanced settings....**
4. In the **Google Cloud Print** section, click **Manage**.
5. Follow the on-screen instructions to register your machine.
6. When a confirmation message appears on your machine, press the [OK] button.



If the confirmation message does not appear on your machine's LCD, repeat these steps.

7. When your Fuji Xerox machine is successfully registered, it will appear in the **My devices** field.



Related Information

- [Before Using Google Cloud Print](#)

Register Your Machine with Google Cloud Print Using Web Based Management

Related Models: DocuPrint M375 z/DocuPrint M375 df

Make sure you have already created a Google Account. If you do not have an account, use a computer or mobile device to access the Google website (<https://accounts.google.com/signup>) and create an account.

Make sure your Fuji Xerox machine is idle before starting the registration process.

Before you begin to register your machine, confirm that the correct date and time are set on the machine.

1. Confirm that your Fuji Xerox machine is connected to the same network as your computer or mobile device.
2. Start your web browser.
3. Type "http://machine's IP address" in your browser's address bar (where "machine's IP address" is the machine's IP address).
For example:
http://192.0.2.1
4. Type a password, and then click . The default password is "x-admin". To ensure security, it is important you change the password.
5. Click the **Network** tab.
6. Click the **Protocol** menu in the left navigation bar.
7. Make sure that **Google Cloud Print** is selected, and then click **Advanced Settings**.
8. Make sure that **Status** is set to **Enabled**. Click **Register**.
9. Follow the on-screen instructions to register your machine.
10. When a confirmation message appears on your machine, press the OK button.



If the confirmation message does not appear on your machine's LCD, repeat these steps.

11. Click **Google**.
12. The sign-in screen for Google Cloud Print™ appears. Sign in with your Google Account and follow the on-screen instructions to register your machine.
13. When you have finished registering your machine, return to the Web Based Management screen and make sure that **Registration Status** is set to **Registered**.



If your machine supports the Secure Function Lock feature, printing via Google Cloud Print™ is possible even if PC print for each user is restricted. To restrict printing via Google Cloud Print™, disable Google Cloud Print™ using Web Based Management or set the Secure Function Lock feature to Public Mode, and then restrict print for public users. See *Related Information*.



Related Information

- [Before Using Google Cloud Print](#)

Print from Google Chrome™ or Chrome OS™

Related Models: DocuPrint M375 z/DocuPrint M375 df

1. Make sure your Fuji Xerox machine is turned on.
2. Open the web page that you want to print.
3. Click the Google Chrome™ menu icon.
4. Click **Print**.
5. Select your machine from the printer list.
6. Change print options, if needed.
7. Click **Print**.



Related Information

- [Google Cloud Print](#)

Print from Google Drive™ for Mobile

Related Models: DocuPrint M375 z/DocuPrint M375 df

1. Make sure your Fuji Xerox machine is turned on.
2. Access Google Drive™ from your Android™ or iOS device's web browser.
3. Open the document that you want to print.
4. Tap the menu icon.
5. Tap **Print**.
6. Select your machine from the printer list.
7. Change print options, if needed.
8. Tap  or **Print**.



Related Information

- [Google Cloud Print](#)

Print from Gmail™ Webmail Service for Mobile

Related Models: DocuPrint M375 z/DocuPrint M375 df

1. Make sure your Fuji Xerox machine is turned on.
2. Access the Gmail™ webmail service from your Android™ or iOS device's web browser.
3. Open the email that you want to print.
4. Tap the menu icon.



If **Print** appears beside the attachment name, you can also print the attachment. Tap **Print**, and then follow the instructions on your mobile device.

5. Tap **Print**.
6. Select your machine from the printer list.
7. Change print options, if needed.
8. Tap  or **Print**.



Related Information

- [Google Cloud Print](#)

Mobile Printing for Windows®

Mobile printing for Windows® is a function to print wirelessly from your Windows® mobile device. You can connect to the same network that your Fuji Xerox machine is connected to and print without installing the printer driver on the device. Many Windows® apps support this function.

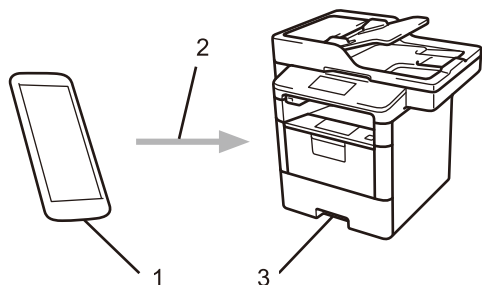

1. Windows® mobile device (Windows® 10 Mobile or later)
2. Wi-Fi® connection
3. Your Fuji Xerox machine



Related Information

- [Mobile](#)

Mopria® Print Service

Mopria® Print Service is a print feature on Android™ mobile devices (Android™ version 4.4 or later) developed by the Mopria® Alliance. With this service, you can connect to the same network as your machine and print without additional setup. Many native Android™ apps support printing.

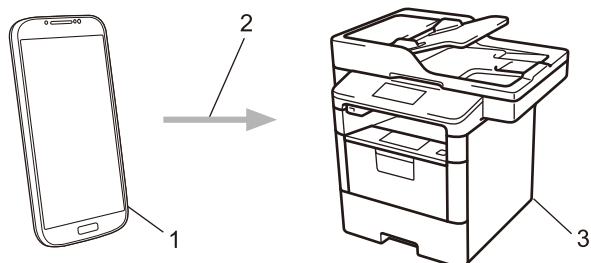

1. Android™ 4.4 or later
2. Wi-Fi® Connection
3. Your Fuji Xerox machine

You must download the Mopria® Print Service from the Google Play™ Store and install it on your Android™ device. Before using this service, you must turn it on.



Related Information

- [Mobile](#)

Print Utility

The Print Utility program allows you to scan to and print from your iOS or Android mobile device.

For details, visit the following web sites:

<http://www.fujixerox.com>



Related Information

- [Mobile](#)
-

ControlCenter

Use Fuji Xerox's ControlCenter software utility to quickly access your frequently-used applications. Using ControlCenter gives you direct access to specific applications.

- [ControlCenter4 \(Windows®\)](#)

ControlCenter4 (Windows®)

- [Change the Operation Mode in ControlCenter4 \(Windows®\)](#)
- [Scan Using ControlCenter4 Home Mode \(Windows®\)](#)
- [Scan Using ControlCenter4 Advanced Mode \(Windows®\)](#)
- [Set Up the Fuji Xerox Machine Using ControlCenter4 \(Windows®\)](#)
- [Create a Custom Tab Using ControlCenter4 Advanced Mode \(Windows®\)](#)

Change the Operation Mode in ControlCenter4 (Windows®)

ControlCenter4 has two operation modes: **Home Mode** and **Advanced Mode**. You can change modes at any time.

Home Mode

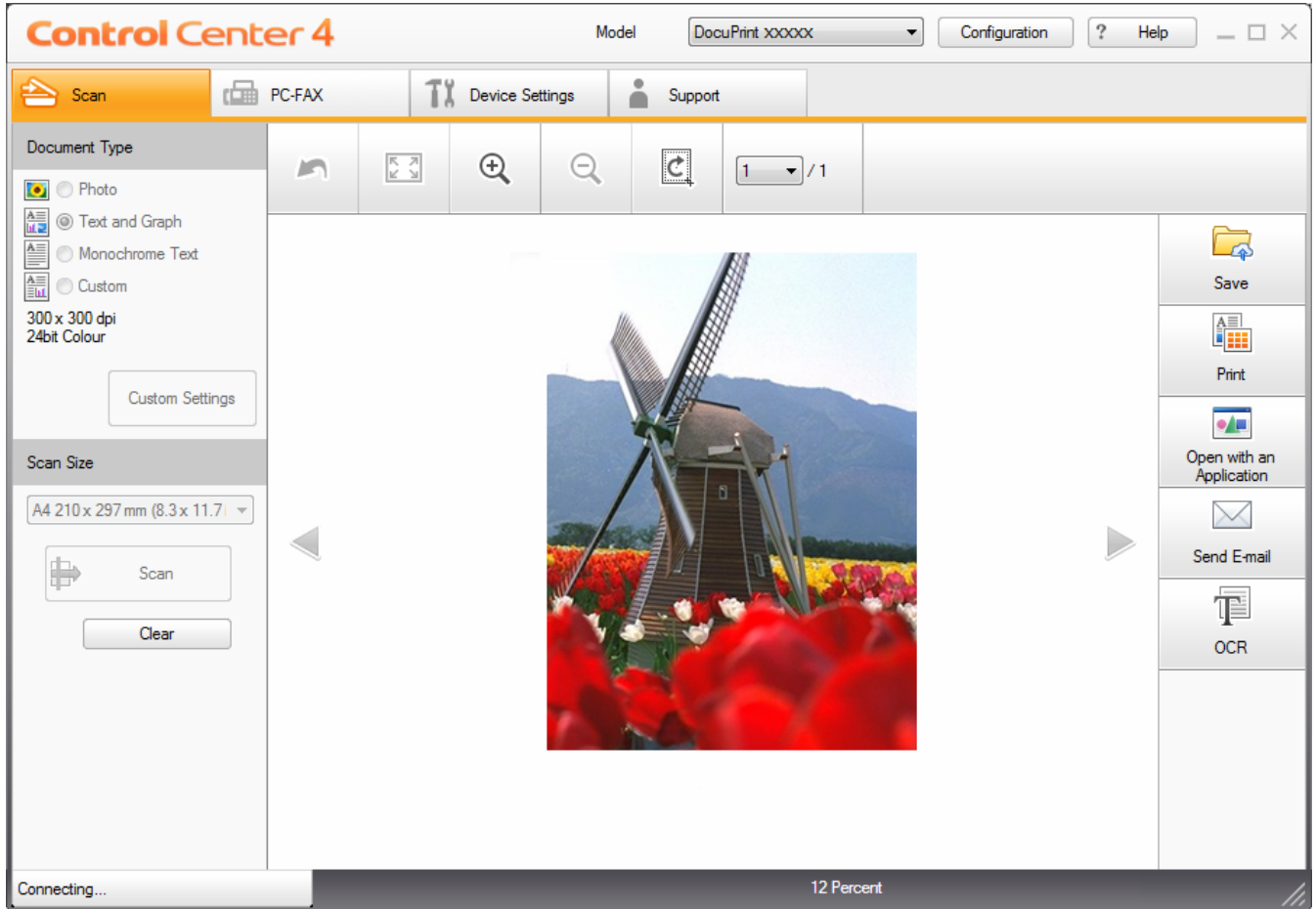

Advanced Mode



- **Home Mode**

ControlCenter4 Home Mode lets you access your machine's main features easily.

- **Advanced Mode**

ControlCenter4 Advanced Mode gives you more control over the details of your machine's features and allows you to customise one-button scan actions.

To change operation mode:

1. Click the  (**ControlCenter4**) icon in the task tray, and then select **Open**.
2. Click the **Configuration** button, and then select **Mode Select**.
3. The mode selection dialog box appears. Select either the **Home Mode** or **Advanced Mode** option.

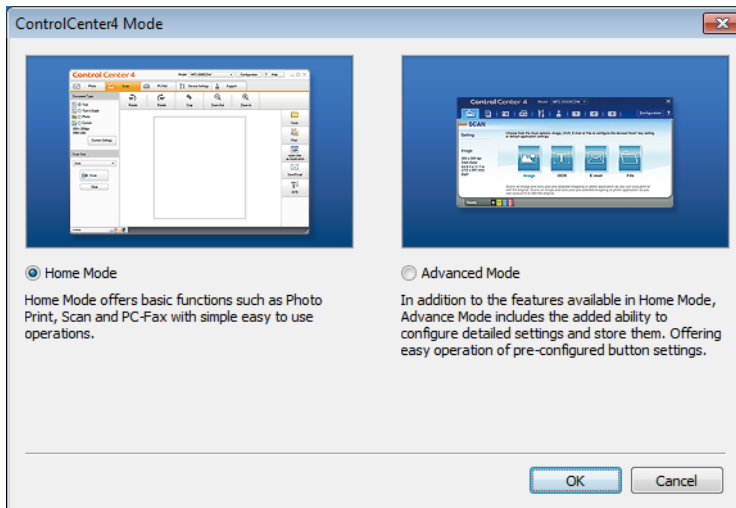

4. Click **OK**.



Related Information

- [ControlCenter4 \(Windows®\)](#)

Scan Using ControlCenter4 Home Mode (Windows®)

Use ControlCenter4 Home Mode to access your machine's main features.

- [Scan Using ControlCenter4 Home Mode \(Windows®\)](#)
- [Save Scanned Data to a Folder as a PDF File Using ControlCenter4 Home Mode \(Windows®\)](#)
- [Scan Both Sides of a Document Automatically Using ControlCenter4 Home Mode \(Windows®\)](#)
- [Scan Settings for ControlCenter4 Home Mode \(Windows®\)](#)

Scan Using ControlCenter4 Advanced Mode (Windows®)

ControlCenter4 Advanced Mode gives you more control over the details of your machine's features and allows you to customise one-button scan actions.

- [Scan Photos and Graphics Using ControlCenter4 Advanced Mode \(Windows®\)](#)
- [Save Scanned Data to a Folder as a PDF File Using ControlCenter4 Advanced Mode \(Windows®\)](#)
- [Scan Both Sides of a Document Automatically Using ControlCenter4 Advanced Mode \(Windows®\)](#)
- [Scan Both Sides of an ID Card Using ControlCenter4 Advanced Mode \(Windows®\)](#)
- [Scan to Email Attachment Using ControlCenter4 Advanced Mode \(Windows®\)](#)
- [Scan to an Editable Text File \(OCR\) Using ControlCenter4 Advanced Mode \(Windows\)](#)
- [Scan Settings for ControlCenter4 Advanced Mode \(Windows®\)](#)

Set Up the Fuji Xerox Machine Using ControlCenter4 (Windows®)



If Secure Function Lock is set to On, you cannot use Remote Setup.

1. Click the  (ControlCenter4) icon in the task tray, and then click **Open**.
2. Click the **Device Settings** tab.
3. Click the **Remote Setup** button.
4. Configure the settings as needed.

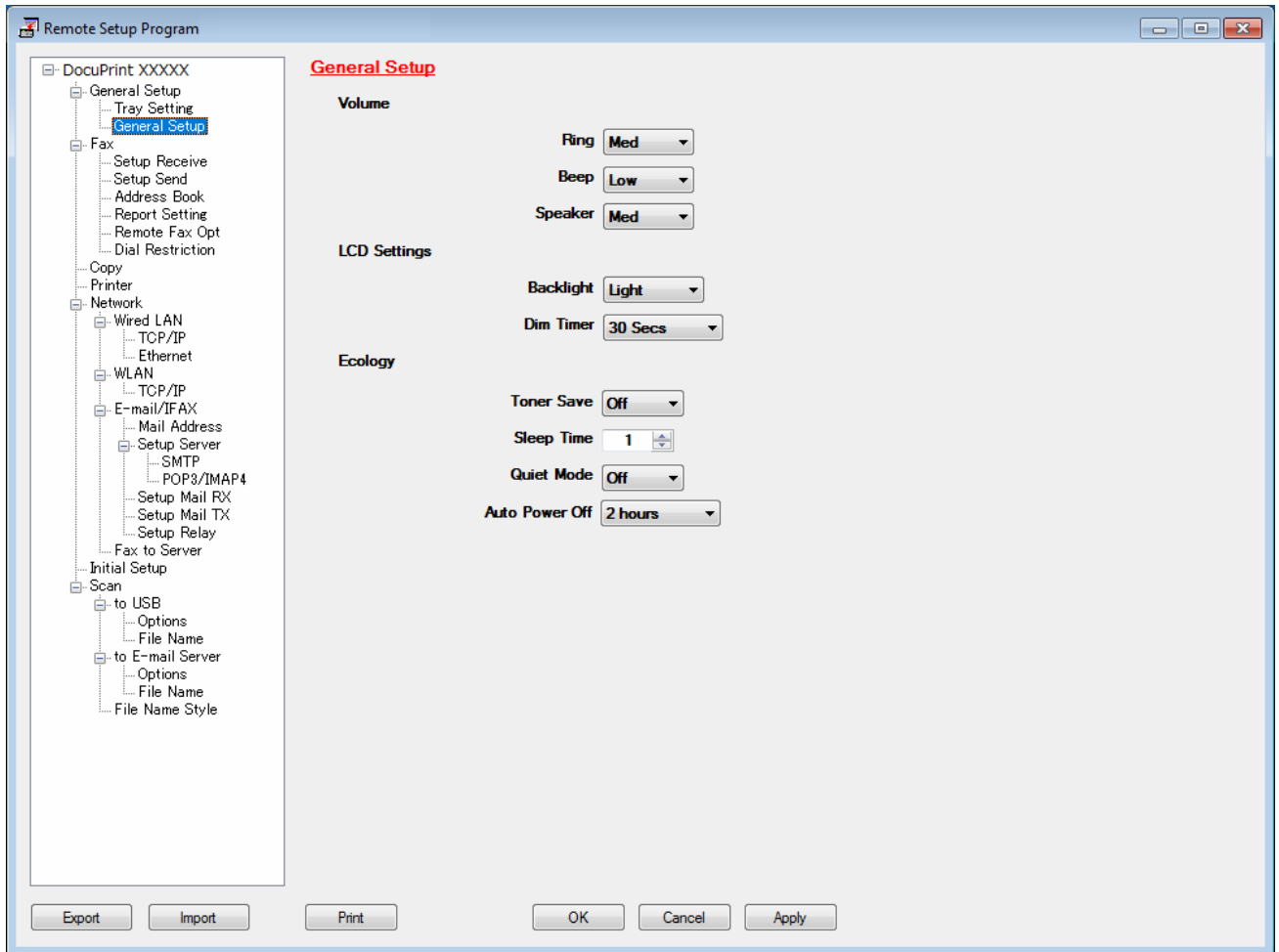

Export

Click to save the current configuration settings to a file.



Click **Export** to save your address book or all settings for your machine.

Import

Click to import a file and read its settings.

Print

Click to print the selected items on the machine. You cannot print the data until it is uploaded to the machine. Click **Apply** to upload the new data to the machine, and then click **Print**.

OK

Click to start uploading data to the machine, and then exit the Remote Setup Program. If an error message appears, confirm that your data is correct, and then click **OK**.

Cancel

Click to exit the Remote Setup Program without uploading data to the machine.

Apply

Click to upload data to the machine without exiting the Remote Setup Program.

5. Click **OK**.

- If your computer is protected by a firewall and is unable to use Remote Setup, you may need to configure the firewall settings to allow communication through port numbers 137 and 161.
- If you are using Windows® Firewall and you installed the Fuji Xerox software and drivers from the Fuji Xerox installation disc, the necessary firewall settings have already been set.

**Related Information**

- [ControlCenter4 \(Windows®\)](#)
 - [Remote Setup \(Windows®\)](#)
-

Create a Custom Tab Using ControlCenter4 Advanced Mode (Windows®)

You can create up to three customised tabs, each including up to five customised buttons, with your preferred settings.

Select **Advanced Mode** as the mode setting for ControlCenter4.

1. Click the  (ControlCenter4) icon in the task tray, and then click **Open**.
2. Click the **Configuration** button, and then select **Create custom tab**.
A custom tab is created.
3. To change the name of a custom tab, right-click the custom tab, and then select **Rename custom tab**.
4. Click the **Configuration** button, select **Create custom button**, and then select the button you want to create.
The settings dialog box appears.
5. Type the button name, and then change the settings, if needed. Click **OK**.
The setting options vary depending on the button you select.

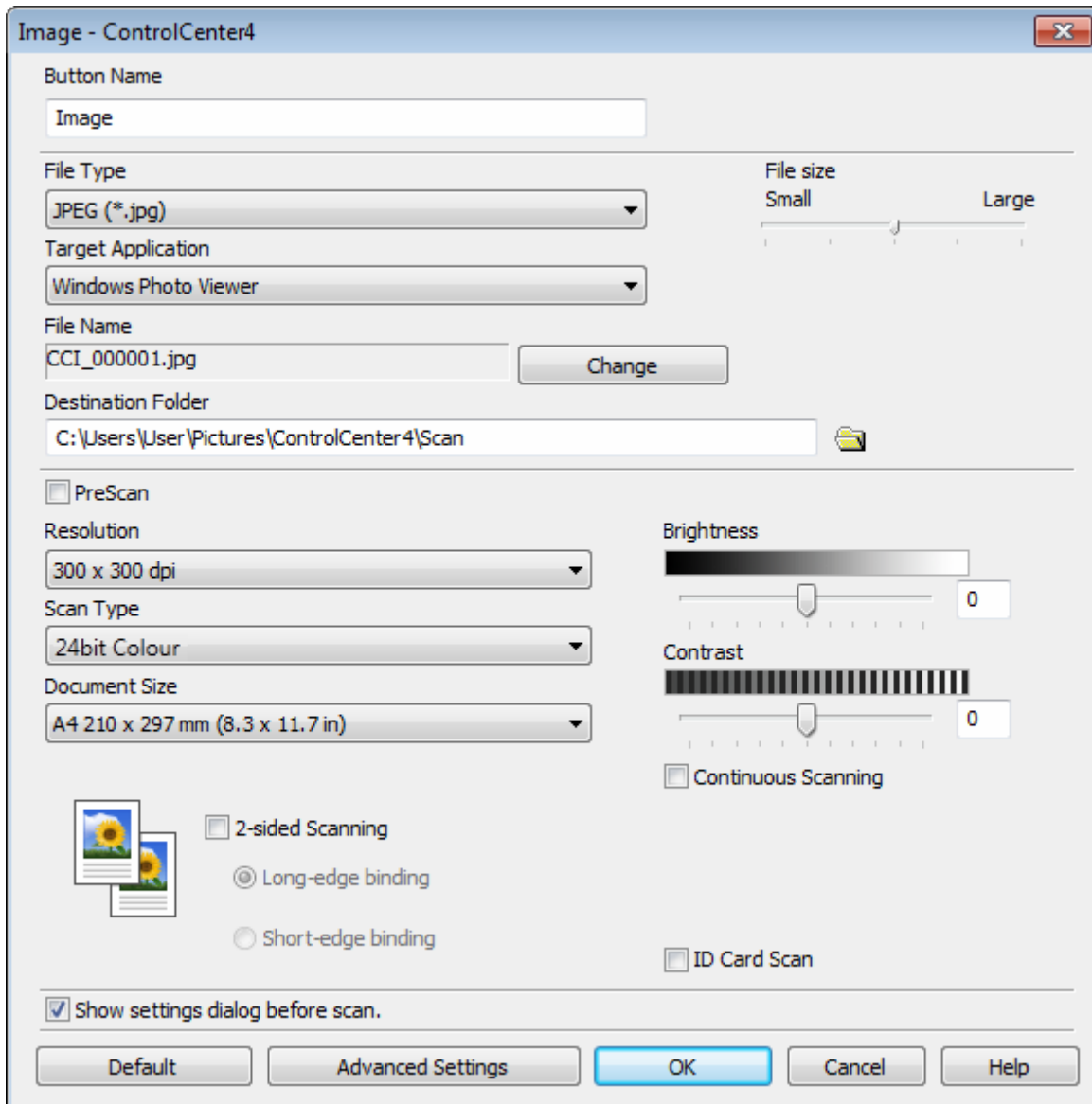



You can change or remove the created tab, button, or settings. Click the **Configuration** button, and then follow the menu.



Related Information

- [ControlCenter4 \(Windows®\)](#)
-

iPrint&Scan for Mac

- [iPrint&Scan Overview](#)
- [Scan Using iPrint&Scan \(Mac\)](#)

iPrint&Scan Overview

Use iPrint&Scan for Mac to print and scan from your computer.

The following screen shows an example of iPrint&Scan. The actual screen may differ depending on the version of the application.

- For Mac
Install iPrint&Scan from the Fuji Xerox installation disc.

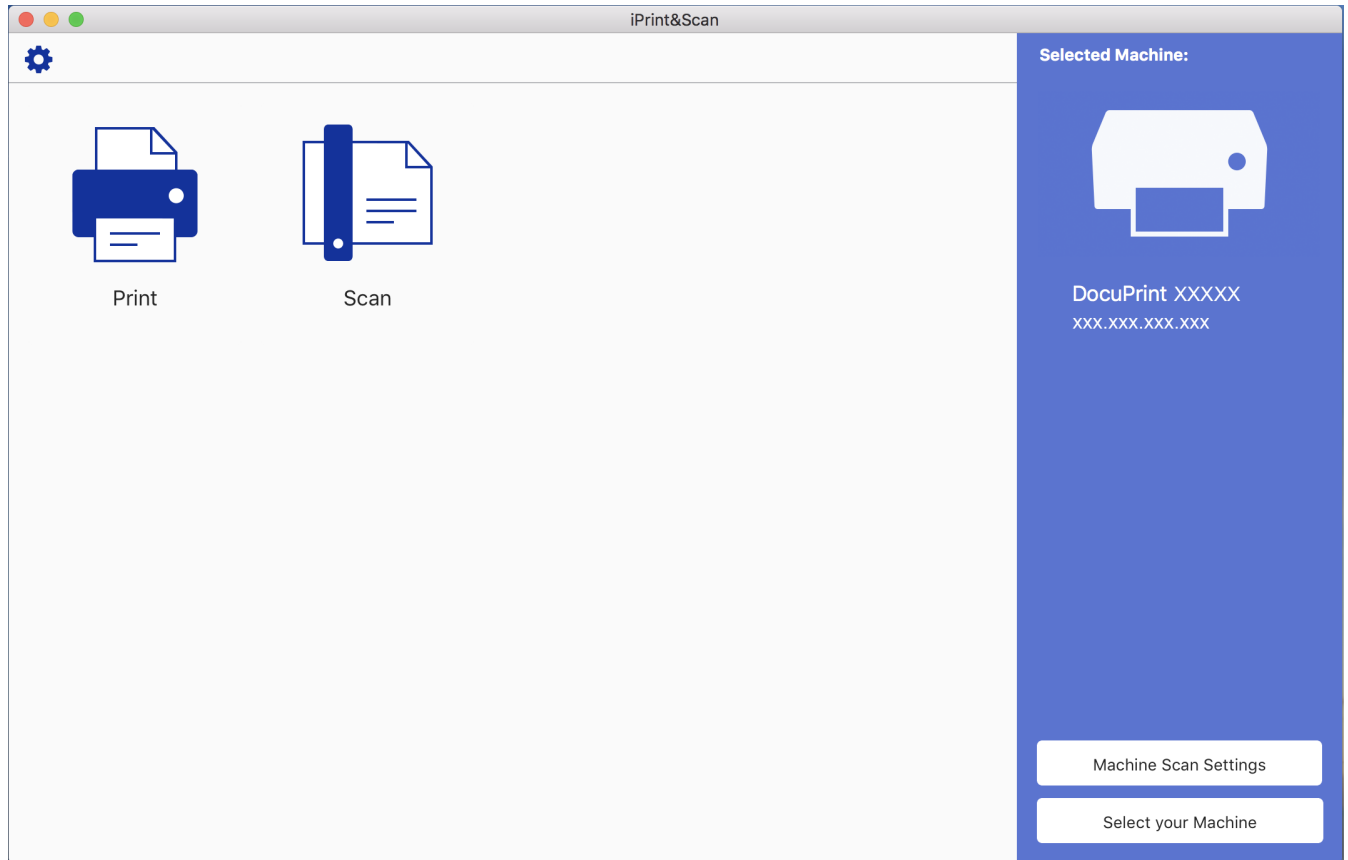

Related Information

- [iPrint&Scan for Mac](#)

Troubleshooting

Use this section to resolve typical problems you may encounter when using your Fuji Xerox machine. You can correct most problems yourself.

IMPORTANT

For technical help, you must call Fuji Xerox customer service or your local Fuji Xerox dealer. Using non-Fuji Xerox supplies may affect the print quality, hardware performance, and machine reliability.

First, check the following:

- The machine's power cord is connected correctly and the machine's power is on. See the *Quick Setup Guide*.
- All of the protective materials have been removed. See the *Quick Setup Guide*.
- Paper is loaded correctly in the paper tray.
- The interface cables are securely connected to the machine and the computer, or the wireless connection is set up on both the machine and your computer.
- Error and maintenance messages

If you did not solve the problem with the checks, identify the problem and then see *Related Information*.



Related Information

- [Error and Maintenance Messages](#)
- [Document Jams](#)
- [Paper Jams](#)
- [Printing Problems](#)
- [Improve the Print Quality](#)
- [Telephone and Fax Problems](#)
- [Network Problems](#)
- [Google Cloud Print Problems](#)
- [Other Problems](#)
- [Check the Machine Information](#)
- [Reset Your Fuji Xerox Machine](#)

Error and Maintenance Messages

As with any sophisticated office product, errors may occur and supply items may have to be replaced. If this happens, your machine identifies the error or required routine maintenance and shows the appropriate message. The most common error and maintenance messages are shown in the table.





Follow the instructions in the **Action** column to solve the error and remove the message.

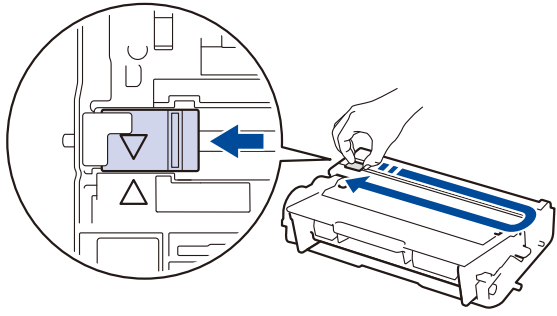



You can correct most errors and perform routine maintenance by yourself.

Error Message	Cause	Action
2-sided Disabled	The back cover of the machine is not closed completely.	Close the back cover of the machine until it locks in the closed position.
	The 2-sided tray is not installed completely.	Install the 2-sided tray firmly in the machine.
Access Denied	The function you want to use is restricted by Secure Function Lock 3.0.	Call your administrator to check your Secure Function Lock Settings.
Cartridge Error	The toner cartridge is not installed correctly.	Remove the toner cartridge and drum cartridge assembly. Take out the toner cartridge, and put it back in the drum cartridge again. Reinstall the toner cartridge and drum cartridge assembly in the machine. If the problem continues, contact Fuji Xerox customer service or your local Fuji Xerox dealer.
Comm.Error	Poor telephone line quality caused a communication error.	Send the fax again or connect the machine to another telephone line. If the problem continues, contact the telephone company and ask them to check your telephone line.
Cooling Down	The temperature of the inside of the machine is too hot. The machine will pause its current print job and go into cooling down mode.	Make sure you can hear the fan in the machine spinning and that the exhaust outlet is not blocked. If the fan is spinning, remove any obstacles that surround the exhaust outlet, and then leave the machine turned on but do not use it for several minutes. If the fan is not spinning, disconnect the machine from the power for several minutes, then reconnect it.
Cover is Open	The front cover is not completely closed.	Open and then firmly close the front cover of the machine.
Cover is Open.	The fusing unit cover is not completely closed or paper was jammed in the back of the machine when you turned on the power.	Close the fusing unit cover located inside the back cover of the machine. Make sure paper is not jammed inside the back of the machine, and then close the fusing unit cover.
Cover is Open.	The ADF cover is not completely closed.	Close the ADF cover. If the error message remains, press  .
Disconnected	The other person or other person's fax machine stopped the call.	Try to send or receive again. If calls are stopped repeatedly and you are using a VoIP (Voice over IP) system, try changing the Compatibility to Basic (for VoIP).

Error Message	Cause	Action
Document Jam	The document was not inserted or fed correctly, or the document scanned from the ADF was too long.	Remove the jammed paper from the ADF unit. Clear any debris or scraps of paper from the ADF unit paper path. Press  .
DR Mode in Use (Except New Zealand)	The machine is set to Distinctive Ring mode. You cannot change the Receive Mode from Manual to another mode.	Set Distinctive Ring to Off.
Drum !	The corona wire on the drum cartridge must be cleaned.	Clean the corona wire on the drum cartridge.  See <i>Related Information: Clean the Corona Wire.</i> If the problem continues, replace the drum cartridge with a new one.
	The drum cartridge or the toner cartridge and drum cartridge assembly is not installed correctly.	Remove the drum cartridge, remove the toner cartridge from the drum cartridge, and put the toner cartridge back into the drum cartridge. Reinstall the drum cartridge in the machine.
FaxAbility On (For New Zealand)	The machine is set to Faxability mode. You can not change the Receive Mode from Manual to another mode.	Set FaxAbility to Off.
Jam 2-sided	The paper is jammed in the 2-sided tray or inside the back cover.	Remove the 2-sided tray and open the back cover to pull out all jammed paper.
Jam Inside	The paper is jammed inside the machine.	Open the front cover, remove the toner cartridge and drum cartridge assembly, and pull out all jammed paper. Close the front cover.
Jam MP Tray	The paper is jammed in the MP tray.	Remove all jammed paper from in and around the MP tray. Press Retry .
Jam Rear	The paper is jammed in the back of the machine.	Open the fusing unit cover and remove all jammed paper. Close the fusing unit cover.
Jam Tray 1 Jam Tray 2 Jam Tray 3	The paper is jammed in the indicated paper tray.	Pull out the paper tray and remove all jammed paper as shown in the animation on the LCD.
Limit Exceeded	The print limit set in Secure Function Lock 3.0 was reached.	Call your administrator to check your Secure Function Lock Settings.

Error Message	Cause	Action
Media Type Mismatch	The media type specified in the printer driver differs from the paper type specified in the machine's menu.	Load the correct type of paper in the tray indicated on the LCD, and then select the correct media type in the Paper Type setting on the machine.
No Drum Unit	The drum cartridge is not installed correctly.	Reinstall the toner cartridge and drum cartridge assembly.
No HUB Support	A USB hub device is connected to the USB direct interface.	Disconnect the USB hub device from the USB direct interface.
No Paper	The machine is out of paper, or paper is not loaded correctly in the paper tray.	<ul style="list-style-type: none"> • Refill paper in the paper tray. Make sure the paper guides are set to the correct size. • If paper is in the tray, remove it and load it again. Make sure the paper guides are set to the correct size. • Do not overfill the paper tray.
No Paper Fed T1 No Paper Fed T2 No Paper Fed T3	The machine failed to feed paper from the indicated paper tray.	Pull out the paper tray indicated on the LCD and remove all jammed paper.
No Paper MP	The MP tray is out of paper, or paper is not loaded correctly in the MP tray.	<p>Do one of the following:</p> <ul style="list-style-type: none"> • Refill paper in the MP tray. Make sure the paper guides are set to the correct size. • If paper is in the tray, remove it and load it again. Make sure the paper guides are set to the correct size.
No Paper No Paper T1 No Paper T2 No Paper T3	The machine failed to feed paper from the indicated paper tray.	<p>Do one of the following:</p> <ul style="list-style-type: none"> • Refill paper in the paper tray indicated on the LCD. Make sure the paper guides are set to the correct size. • If paper is in the tray, remove it and load it again. Make sure the paper guides are set to the correct size. <p>Do not overfill the paper tray.</p>
No Response/Busy	The number you dialed does not answer or is busy.	Verify the number and try again.
No Toner	The toner cartridge or the toner cartridge and drum cartridge assembly is not installed correctly.	Remove the toner cartridge and drum cartridge assembly. Remove the toner cartridge from the drum cartridge, and reinstall the toner cartridge back in the drum cartridge. Reinstall the toner cartridge and drum cartridge assembly back in the machine. If the problem continues, replace the toner cartridge with a new one.
No Tray T1 No Tray T2 No Tray T3	The paper tray is not installed or not installed correctly.	Reinstall the paper tray indicated on the LCD.

Error Message	Cause	Action
Out of Fax Memory	The machine's fax memory is full.	<p>If you are using Fax Preview function, delete unwanted received fax data.</p> <p>If you are using Memory Receive function and are not using fax preview function, print received fax data. To print fax data, press</p>  Settings > All Settings > Fax > Print Document.
Out of Memory	The machine's memory is full.	<p>If a fax-sending or copy operation is in process</p> <p>Do one of the following:</p> <ul style="list-style-type: none"> • Press Send Now to send the pages scanned so far. • Press Partial Print to copy the pages scanned so far. • Press Quit or  and wait until the other operations that are in progress finish, and then try again. <p>If a scan operation is in process</p> <ul style="list-style-type: none"> • Split the document into multiple parts. • Reduce the Resolution. • Reduce the File Size. • Select the high compression PDF file type. • Clear faxes from the memory. <p>If a print operation is in process</p> <p>Press  and reduce the print resolution.</p>
Output Tray Full	The output paper tray is full.	Remove printed paper from output tray indicated on the LCD.
Paper Low Paper Low T1 Paper Low T2 Paper Low T3	The paper tray is nearly empty.	Refill the paper in the paper tray indicated on the LCD.
Print Data Full	The machine's memory is full.	Press  and delete the previously stored secure print data.
Print Unable ##	The machine has a mechanical problem.	<ul style="list-style-type: none"> • Press and hold  to turn the machine off, wait a few minutes, and then turn it on again. • If the problem continues, contact Fuji Xerox customer service.
Received Fax ##	An unprinted received fax is waiting to print on the correct size paper.	To print the received fax, load the correct size of paper in the tray indicated on the LCD. Paper sizes available for fax printing are A4, Letter, Legal, Folio, Mexico Legal and India Legal.
Replace Toner	The toner cartridge is at the end of its life. The machine stops all print operations. While memory is available, faxes are stored in the memory.	Replace the toner cartridge with a new one.

Error Message	Cause	Action
Scan Unable	The document is too long for 2-sided scanning.	Press  . For 2-sided scanning, use A4 size paper. Other paper must be within the following size: Length: 150 to 357.6 mm Width: 146 to 218 mm
Scan Unable ##	The machine has a mechanical problem.	<ul style="list-style-type: none"> Press and hold  to turn the machine off, and then turn it on again. If the problem continues, contact Fuji Xerox customer service.
Self-Diagnostic	The temperature of the fusing unit does not rise to a specified temperature within the specified time.	Press and hold  to turn the machine off, wait a few seconds, and then turn it on again. Leave the machine idle for 15 minutes with the power on.
	The fusing unit is too hot.	
Service Error ##	Machine's firmware has a problem.	<ul style="list-style-type: none"> Contact Fuji Xerox customer service.
Size Error	The paper size defined in the printer driver is not supported by the defined tray.	Choose a paper size supported by the defined tray.
Size Error 2-sided	The paper size specified in the machine's paper size setting is not available for automatic 2-sided printing.	Press  (if required). Load the correct size of paper in the tray and set the tray for that paper size.
	The paper in the tray is not the correct size and is not available for automatic 2-sided printing.	Choose a paper size supported by 2-sided printing. (For models without the lever on the 2-sided tray) Paper size available for automatic 2-sided printing is A4. (For models with the lever on the 2-sided tray) Paper sizes available for automatic 2-sided printing are A4, Letter, Legal, Mexico Legal, India Legal and Folio.
Size Mismatch	The paper in the tray is not the correct size.	Load the correct size of paper in the tray indicated on the LCD and set the size of paper for the tray.
Supplies Drum End Soon	The drum cartridge is near the end of its life.	Order a new drum cartridge before the LCD displays <i>Replace Drum</i> .
Supplies Replace Drum	It is time to replace the drum cartridge.	Replace the drum cartridge with a new one.
	The drum cartridge counter was not reset when a new drum cartridge was installed.	Reset the drum cartridge counter. See the instructions included with the new drum cartridge.
Supplies Toner Low	If the LCD displays this message, you can still print. The toner cartridge is near the end of its life.	Order a new toner cartridge now so a replacement toner cartridge is available when the LCD displays <i>Replace Toner</i> .
Too Many Trays	The number of installed Tray Modules (Optional) exceeds the maximum number.	Reduce the number of Tray Modules (Optional).

Error Message	Cause	Action
Touchscreen Initialisation Failed	The touchscreen was pressed before the power on initialisation was completed.	Make sure nothing is touching the touchscreen.
	Debris may be stuck between the lower part of the touchscreen and its frame.	Insert a piece of stiff paper between the lower part of the touchscreen and its frame and slide it back and forth to push out any debris.
Unusable Device	A USB device or USB Flash memory drive that is encrypted or not supported has been connected to the USB direct interface.	Unplug the device from the USB direct interface.
Unusable Device Remove the Device. Turn the power off and back on again.	A defective USB device or a high power consumption USB device has been connected to the USB direct interface.	<ul style="list-style-type: none"> Unplug the device from the USB direct interface. Press and hold  to turn the machine off, and then turn it on again.
Wrong Paper Size MP Wrong Paper Size T1 Wrong Paper Size T2 Wrong Paper Size T3	The specified tray ran out of paper during copying and the machine could not feed the same size paper from the next priority tray.	Refill the paper in the paper tray.



Related Information

- [Troubleshooting](#)
- [Transfer Your Faxes or Fax Journal Report](#)

Related Topics

- [Replace Supplies](#)
- [Load and Print Using the Paper Tray](#)
- [Load and Print Using the Multi-purpose Tray \(MP Tray\)](#)
- [Clean the Corona Wire](#)

Transfer Your Faxes or Fax Journal Report

If the LCD displays:

- [Print Unable] ##
- [Scan Unable] ##

We recommend transferring your faxes to another fax machine or to your computer.

You can also transfer the Fax Journal report to see if there are any faxes you must transfer.



If there is an error message on the LCD after you transfer the faxes, disconnect your Fuji Xerox machine from the power source for several minutes, and then reconnect it.



Related Information

- [Error and Maintenance Messages](#)
 - [Transfer Faxes to Another Fax Machine](#)
 - [Transfer Faxes to Your Computer](#)
 - [Transfer the Fax Journal Report to Another Fax Machine](#)
-

Transfer Faxes to Another Fax Machine

If you have not set up your Station ID, you cannot enter Fax Transfer mode.

1. Press  [Settings] > [All Settings] > [Service] > [Data Transfer] > [Fax Transfer].
2. Do one of the following:
 - If the LCD displays [No Data], there are no faxes left in the machine's memory. Press [Close].
 - Enter the fax number to which faxes will be forwarded.
3. Press [Fax Start].



Related Information

- [Transfer Your Faxes or Fax Journal Report](#)

Related Topics

- [Set Your Station ID](#)

Transfer Faxes to Your Computer

1. Make sure you have installed the software and drivers on your computer, and then turn on **PC-FAX Receive** on the computer.

DO one of the following:

- (Windows® 7)

From the  (**Start**) menu, select **All Programs > Fuji Xerox > Fuji Xerox Utilities**.

Click the drop-down list and select your model name (if not already selected). Click **PC-FAX** in the left navigation bar, and then click **Receive**.

- (Windows® 8 and Windows® 10)

Click  (**Fuji Xerox Utilities**), and then click the drop-down list and select your model name (if not already selected). Click **PC-FAX** in the left navigation bar, and then click **Receive**.

2. Make sure you have set [PC Fax Receive] on the machine.

If faxes are in the machine's memory when you set up PC-Fax Receive, the LCD displays [Send Fax to PC?].

3. Do one of the following:

- To transfer all faxes to your computer, press [Yes].
- To exit and leave the faxes in the memory, press [No].

4. Press .



Related Information

- [Transfer Your Faxes or Fax Journal Report](#)

Related Topics

- [Use PC-Fax Receive to Transfer Received Faxes to Your Computer \(Windows® only\)](#)
- [Configure PC-FAX \(Windows®\)](#)

Transfer the Fax Journal Report to Another Fax Machine

If you have not set up your Station ID, you cannot enter fax transfer mode.

1. Press  [Settings] > [All Settings] > [Service] > [Data Transfer] > [Report Transfer].
2. Enter the fax number to which the Fax Journal will be forwarded.
3. Press [Fax Start].



Related Information

- [Transfer Your Faxes or Fax Journal Report](#)

Related Topics

- [Set Your Station ID](#)

Document Jams

- Document is Jammed in the Top of the ADF Unit
- Document is Jammed under the Document Cover
- Remove Small Scraps of Paper Jammed in the ADF

Document is Jammed in the Top of the ADF Unit

1. Remove any paper from the ADF that is not jammed.
2. Open the ADF cover.
3. Pull the jammed document out to the left. If the document rips or tears, be sure you remove any debris or scraps to prevent future jams.

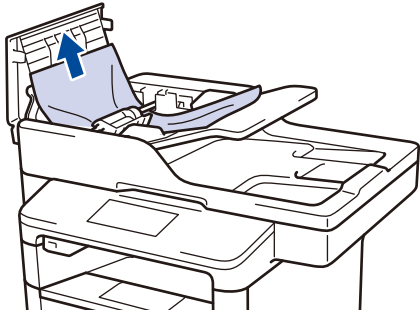

4. Close the ADF cover.
5. Press .





Related Information

- [Document Jams](#)

Document is Jammed under the Document Cover

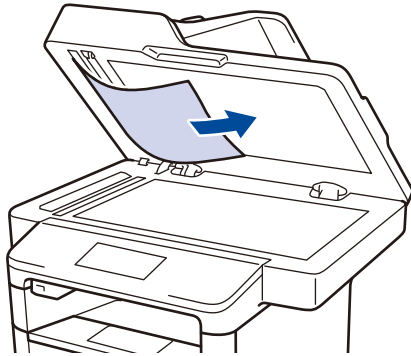
1. Remove any paper from the ADF that is not jammed.
2. Lift the document cover.
3. Pull the jammed document out to the right. If the document rips or tears, be sure you remove any debris or scraps to prevent future jams.



4. Close the document cover.
5. Press .





Related Information

- [Document Jams](#)

Remove Small Scraps of Paper Jammed in the ADF

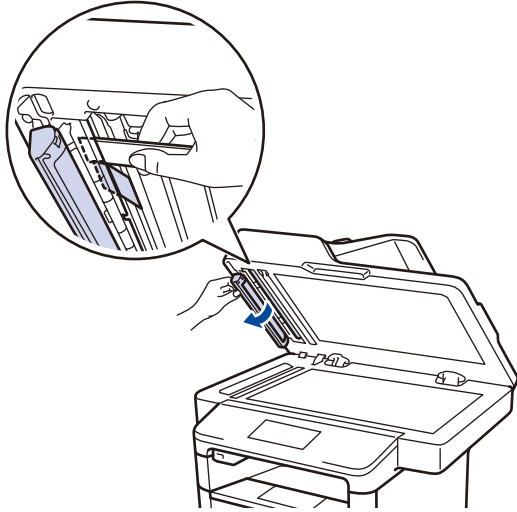
1. Lift the document cover.
2. Insert a piece of stiff paper, such as cardstock, into the ADF to push any small paper scraps through.
(DocuPrint M385 z/DocuPrint M375 z/DocuPrint M375 df)



3. Close the document cover.
4. Press .



Related Information

- [Document Jams](#)

Paper Jams

Always remove the remaining paper from the paper tray and straighten the stack when you are adding new paper. This helps prevent multiple sheets of paper from feeding through the machine at one time and prevents paper jams.

WARNING

- If you need to pull out a tray to remove paper jam, contact your local Fuji Xerox representative. Do not pull out a tray, otherwise it may cause injuries.

CAUTION

- Do not attempt to remove a paper deeply jammed inside the product, particularly a paper wrapped around the fusing unit or the heat roller. Otherwise, it may cause injuries or burns. Switch off the product immediately and contact your local Fuji Xerox representative.

Related Information

- [Troubleshooting](#)
 - [Paper is Jammed in the MP tray](#)
 - [Paper is Jammed in the Paper Tray](#)
 - [Paper is Jammed in the Back of the Machine](#)
 - [Paper is Jammed inside the Machine](#)
 - [Paper is Jammed in the 2-sided Tray](#)

Paper is Jammed in the MP tray

If the machine's control panel or the Status Monitor indicates that there is a jam in the machine's MP tray, follow these steps:

1. Remove the paper from the MP tray.
2. Remove any jammed paper from in and around the MP tray.



3. Fan the paper stack, and then put it back in the MP tray.
4. Reload paper in the MP tray and make sure the paper stays under the maximum paper height guides (1) on both sides of the tray.

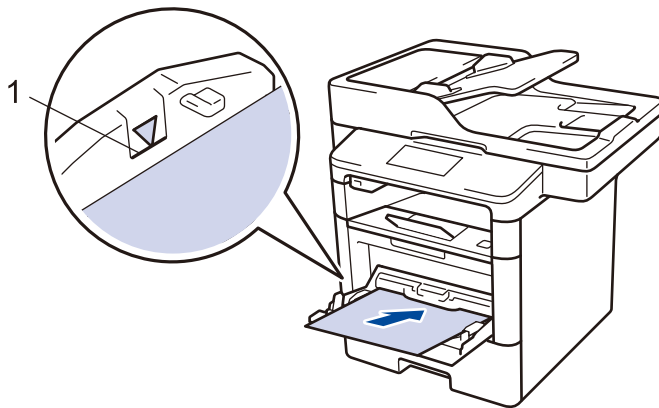

5. Press [Retry] to resume printing.



Related Information

- [Paper Jams](#)

Paper is Jammed in the Paper Tray

If the machine's control panel or the Status Monitor indicates that there is a jam in the paper tray, follow these steps:

1. Pull the paper tray completely out of the machine.

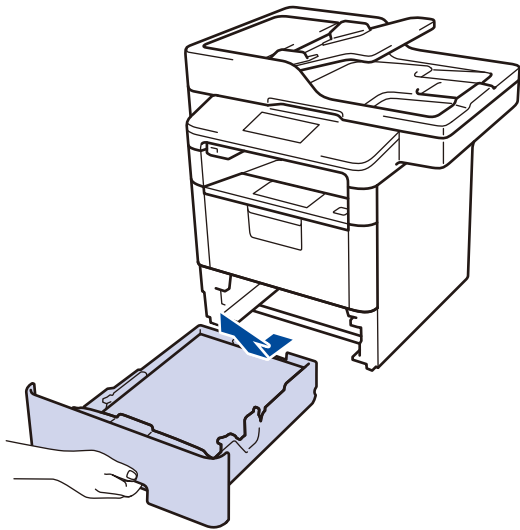

2. Slowly pull out the jammed paper.

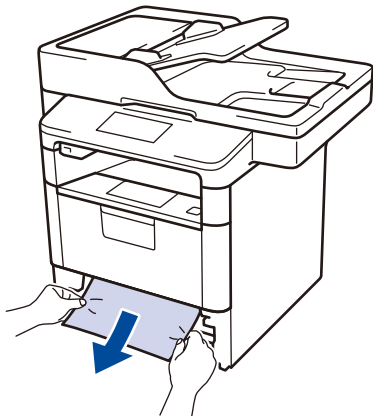

Pulling the jammed paper downward using both hands allows you to remove the paper more easily.

3. Fan the stack of paper to prevent further jams, and slide the paper guides to fit the paper size.

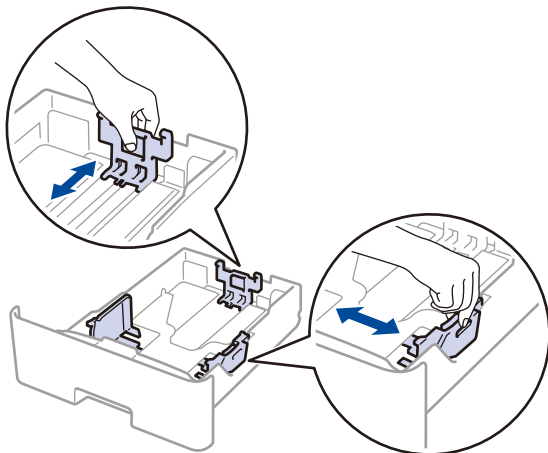

4. Make sure the paper is below the maximum paper mark (▼ ▼ ▼).

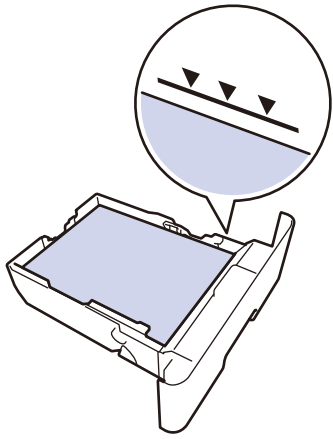

5. Put the paper tray firmly back in the machine.



Related Information

- [Paper Jams](#)

Paper is Jammed in the Back of the Machine

If the machine's control panel or the Status Monitor indicates that there is a jam in the back (Rear) of the machine, follow these steps:

1. Leave the machine turned on for 10 minutes for the internal fan to cool the extremely hot parts inside the machine.
2. Open the back cover.

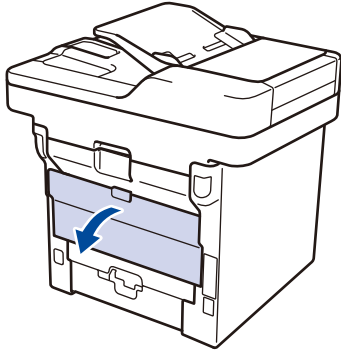

3. Pull the green levers at the left and right sides toward you to release the fusing unit cover.

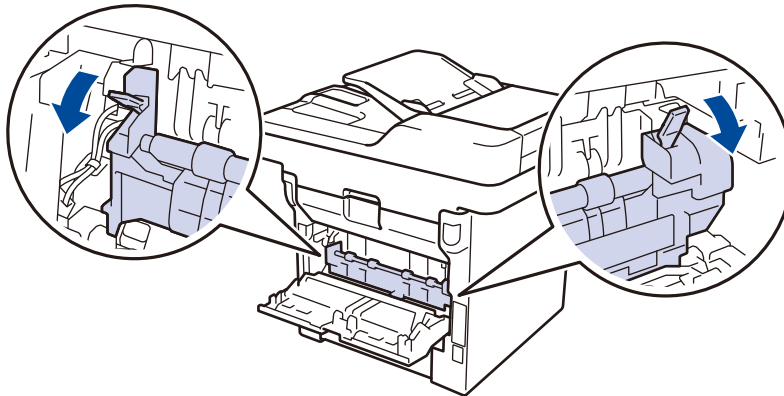

CAUTION

HOT SURFACE

Always follow all warning instructions marked on or supplied with this product. To avoid the risk of burn injuries and electric shock, never touch the area with the "High Temperature" or "High Voltage" marks on.

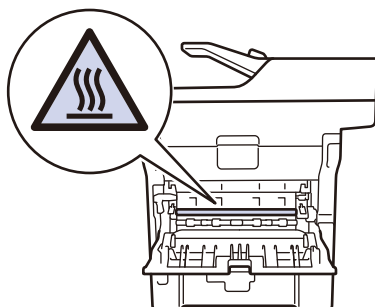

4. Use both hands to gently pull the jammed paper out of the fusing unit.

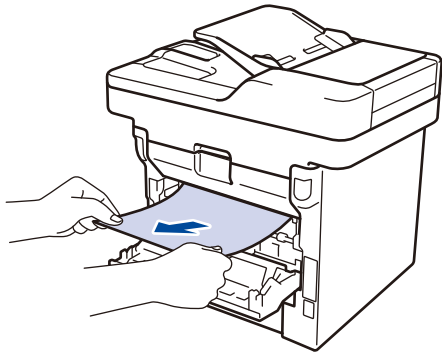

5. Close the fusing unit cover.

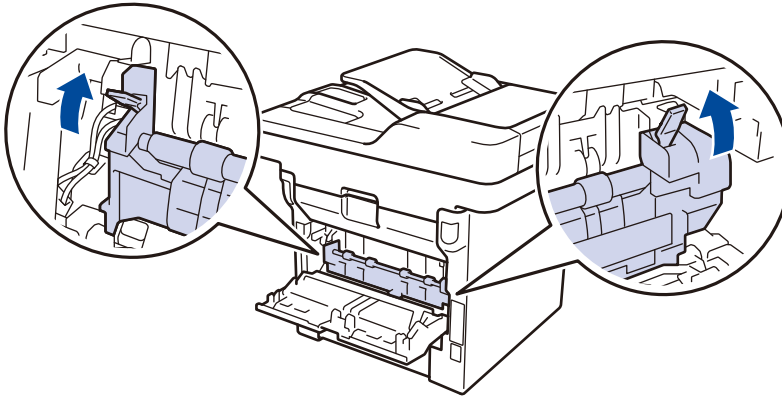

6. Close the back cover until it locks in the closed position.



Related Information

- [Paper Jams](#)

Paper is Jammed inside the Machine

If the machine's control panel or the Status Monitor indicates that there is a jam inside the machine, follow these steps:

1. Leave the machine turned on for 10 minutes for the internal fan to cool the extremely hot parts inside the machine.
2. Open the front cover.

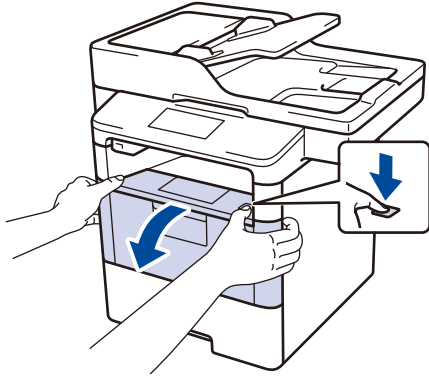

3. Remove the toner cartridge and drum cartridge assembly.

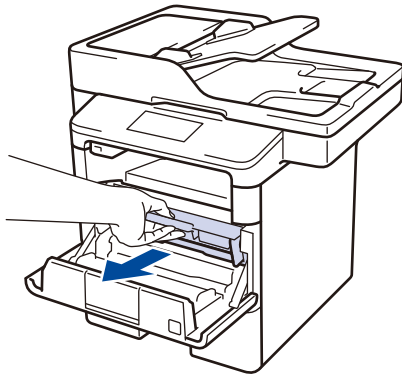

⚠ CAUTION

HOT SURFACE

Always follow all warning instructions marked on or supplied with this product. To avoid the risk of burn injuries and electric shock, never touch the area with the "High Temperature" or "High Voltage" marks on.

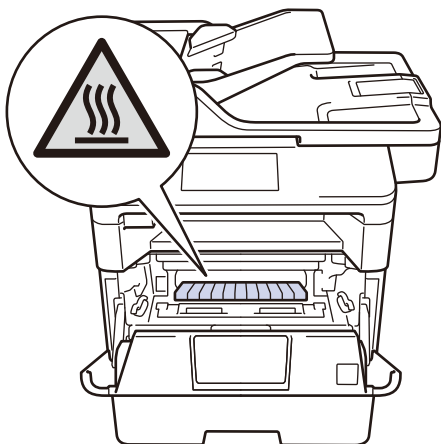

4. Pull out the jammed paper slowly.

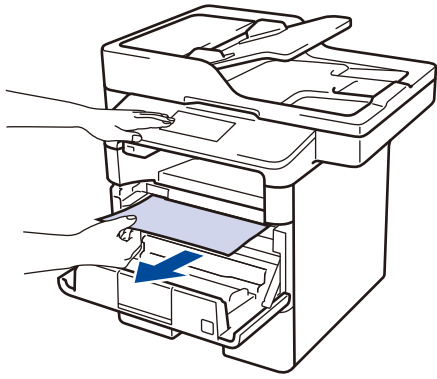

5. Install the toner cartridge and drum cartridge assembly into the machine.

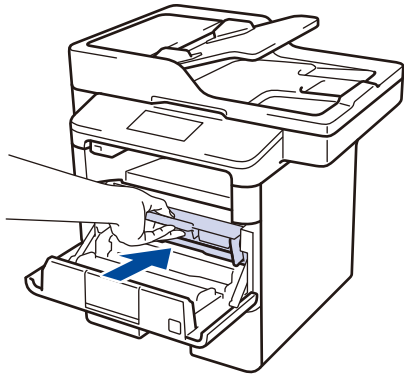

6. Close the front cover.



Related Information

- [Paper Jams](#)

Paper is Jammed in the 2-sided Tray

If the machine's control panel or the Status Monitor indicates that there is a jam in the 2-sided paper tray, follow these steps:

1. Leave the machine turned on for 10 minutes for the internal fan to cool the extremely hot parts inside the machine.
2. Pull the paper tray completely out of the machine.

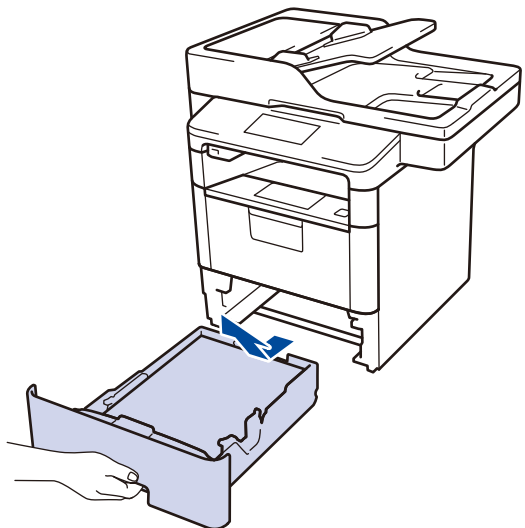

3. At the back of the machine, pull the 2-sided tray completely out of the machine.

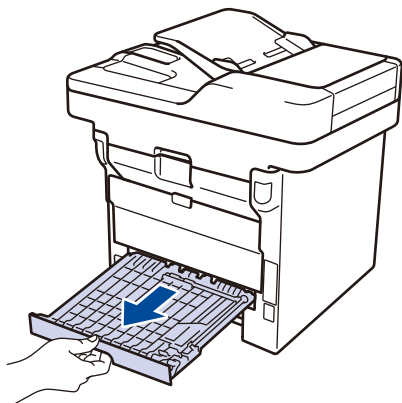

4. Pull the jammed paper out of the machine or out of the 2-sided tray.

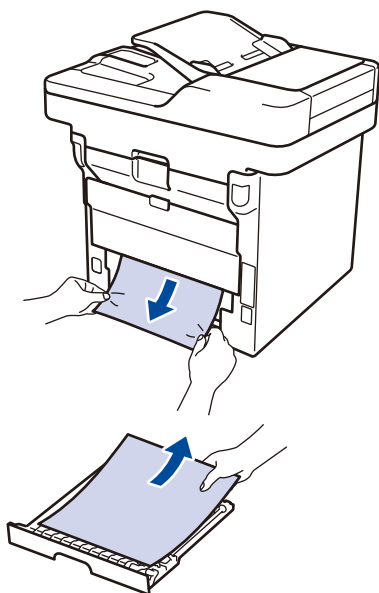

5. Remove paper that may have jammed under the machine due to static electricity.

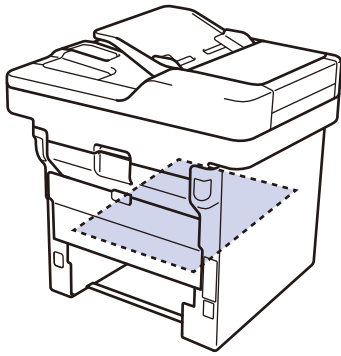

6. If paper is not caught inside the 2-sided tray, open the back cover.

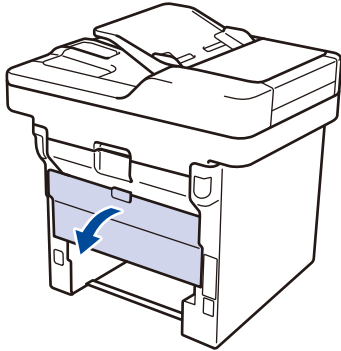

⚠ CAUTION

HOT SURFACE

Always follow all warning instructions marked on or supplied with this product. To avoid the risk of burn injuries and electric shock, never touch the area with the "High Temperature" or "High Voltage" marks on.

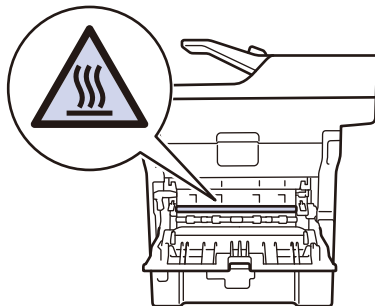

7. Use both hands to gently pull the jammed paper out of the back of the machine.

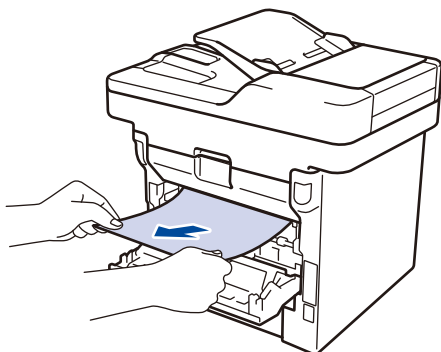

8. Close the back cover until it locks in the closed position.

9. Put the 2-sided tray firmly back in the rear of the machine.





10. Put the paper tray firmly back in the front of the machine.





Related Information

- Paper Jams

Printing Problems

Difficulties	Suggestions
<p>No printout</p>	<p>Check that the correct printer driver has been installed and selected.</p>
	<p>Check to see if the Status Monitor or the machine's control panel displays an error status.</p>
	<p>Check that the machine is online:</p> <ul style="list-style-type: none"> • Windows® 7 and Windows Server® 2008 R2 Click /Start > Devices and Printers . Right-click FX DocuPrint XXXXX and click See what's printing. Click Printer in the menu bar. Make sure Use Printer Offline is not selected. • Windows Server® 2008 Click /Start > Control Panel > Hardware and Sound > Printers. Right-click FX DocuPrint XXXXX. Make sure Use Printer Online is not listed. If it is listed, click this option to set the driver Online. • Windows® 8 and Windows Server® 2012 Move your mouse to the lower right corner of your desktop. When the menu bar appears, click Settings > Control Panel. In the Hardware and Sound group, click View devices and printers. Right-click the FX DocuPrint XXXXX. Click See what's printing. If printer driver options appear, select your printer driver. Click Printer in the menu bar and make sure that Use Printer Offline is not selected. • Windows® 10 and Windows Server® 2016 Click  > Windows System > Control Panel. In the Hardware and Sound group, click View devices and printers. Right-click the FX DocuPrint XXXXX. Click See what's printing. If printer driver options appear, select your printer driver. Click Printer in the menu bar and make sure that Use Printer Offline is not selected. • Windows Server® 2012 R2 Click Control Panel on the Start screen. In the Hardware group, click View devices and printers. Right-click the FX DocuPrint XXXXX. Click See what's printing. If printer driver options appear, select your printer driver. Click Printer in the menu bar and make sure Use Printer Offline is not selected.
	<p>Check the machine is not in Power Off mode.</p> <p>If the machine is in Power Off mode, press  on the control panel, and then send the print data again.</p>

Difficulties	Suggestions
The machine is not printing or has stopped printing.	Press  . The machine will cancel the print job and clear it from the machine's memory. The printout may be incomplete. Send the print data again.
The machine prints unexpectedly or it prints garbage. The headers or footers appear when the document displays on the screen but they do not show up when it is printed.	There is an unprintable area on the top and bottom of the page. Adjust the top and bottom margins in your document to allow for this.
	Press  .
	Check the settings in your application to make sure they are set up to work with your machine.
The machine prints the first couple of pages correctly, then some pages have missing text.	Check the settings in your application to make sure they are set up to work with your machine.
	Your computer is not recognising the full signal of the machine's input buffer. Make sure you connected the interface cable correctly.
The machine does not print on both sides of the paper even though the printer driver setting is 2-sided and the machine supports automatic 2-sided printing.	(For models without the lever on the 2-sided tray)Check the paper size setting in the printer driver. You must select A4 paper that is 60 to 105 g/m ² . (For models with the lever on the 2-sided tray)Check the paper size setting in the printer driver. You must select A4, Letter, Legal, Folio, Mexico Legal and India Legal paper that is 60 to 105 g/m ²
Print speed is too slow.	Try changing the printer driver setting. The highest resolution needs longer data processing, sending and printing time.
The machine does not feed paper.	If there is paper in the paper tray, make sure it is straight. If the paper is curled, straighten it. Sometimes it is helpful to remove the paper, turn the stack over and put it back in the paper tray.
	Reduce the amount of paper in the paper tray, and then try again.
	Make sure MP Tray is not selected for Paper Source in the printer driver.
	Clean the paper pick-up rollers.
The machine does not feed paper from the MP tray.	Fan the paper well and put it back in the MP tray firmly.
	Make sure MP Tray is selected as Paper Source in the printer driver.
The machine does not feed envelopes.	Load envelopes in the MP tray. Your application must be set to print the envelope size you are using. This is usually done in the Page Setup or Document Setup menu of your application.



Related Information

- [Troubleshooting](#)

Related Topics

- [Monitor the Status of the Machine from Your Computer \(Windows®\)](#)
 - [Monitor the Status of the Machine from Your Computer \(Mac\)](#)
 - [Unscannable and Unprintable Areas](#)
 - [Cancel a Print Job](#)
 - [Load and Print Using the Paper Tray](#)
 - [Clean the Paper Pick-up Rollers](#)
 - [Load and Print Using the Multi-purpose Tray \(MP Tray\)](#)
-



Improve the Print Quality





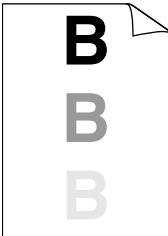

If you have a print quality problem, print a test page first. If the printout looks good, the problem is probably not the machine. Check the interface cable connections and try printing a different document. If the printout or test page printed from the machine has a quality problem, check the examples of poor print quality in the table and follow the recommendations.

IMPORTANT

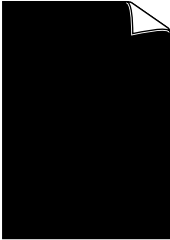

Using non-Fuji Xerox supplies may affect the print quality, hardware performance, and machine reliability.

1. To get the best print quality, we suggest using recommended print media. Make sure you use paper that meets our specifications.
2. Check that the toner cartridge and drum cartridge are installed correctly.

Examples of poor print quality	Recommendation
 <p>ABCDEF GH abcde fghijk A B C D abcde 01234</p> <p>Faint</p>	<ul style="list-style-type: none"> • If the machine indicates Replace Toner status, install a new toner cartridge. • Check the machine's environment. Conditions such as humidity, high temperatures, and so on, may cause this print fault. • If the whole page is too light, Toner Save may be turned on. Turn off Toner Save mode in the machine's menu settings or the printer driver. • Clean the drum cartridge. • Clean the corona wire on the drum cartridge. • Replace the toner cartridge with a new toner cartridge. • Replace the drum cartridge with a new drum cartridge.
 <p>ABCDEF GH abcde fghijk A B C D abcde 01234</p> <p>Grey background</p>	<ul style="list-style-type: none"> • Check the machine's environment. Conditions such as high temperatures and high humidity can increase the amount of background shading. • Clean the drum cartridge. • Replace the toner cartridge with a new toner cartridge. • Replace the drum cartridge with a new drum cartridge.
 <p>B B B</p> <p>Ghost</p>	<ul style="list-style-type: none"> • Check the machine's environment. Conditions such as low humidity and low temperatures may cause this print quality problem. • Select the appropriate media type in the printer driver. • Clean the drum cartridge. • Replace the drum cartridge with a new drum cartridge. • Replace the toner cartridge with a new toner cartridge. • The fusing unit may be contaminated. Contact Fuji Xerox customer service.

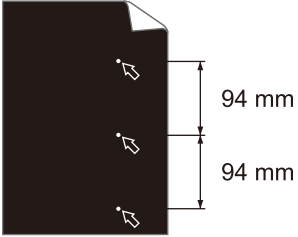
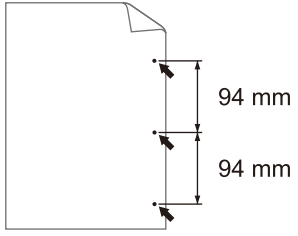
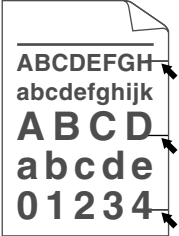
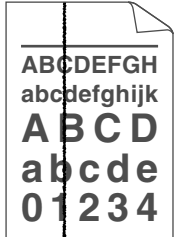
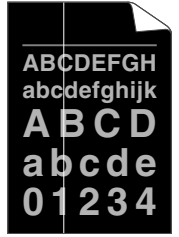
Examples of poor print quality	Recommendation
 <p data-bbox="395 434 549 465">Toner specks</p>	<ul data-bbox="815 174 1473 501" style="list-style-type: none"> • Make sure the media type setting in the driver matches the type of paper you are using. • Clean the drum cartridge. • The toner cartridge may be damaged. Replace the toner cartridge with a new toner cartridge. • The drum cartridge may be damaged. Replace the drum cartridge with a new drum cartridge. • The fusing unit may be contaminated. Contact Fuji Xerox customer service.
 <p data-bbox="403 784 533 815">Hollow print</p>	<ul data-bbox="815 524 1473 779" style="list-style-type: none"> • Select Thick Paper mode in the printer driver or use thinner paper than you are currently using. • Select the appropriate media type in the menu setting. • Check the machine's environment. Conditions such as high humidity can cause hollow print. • The drum cartridge may be damaged. Replace the drum cartridge with a new drum cartridge.
 <p data-bbox="421 1095 515 1126">All black</p>	<ul data-bbox="815 835 1473 943" style="list-style-type: none"> • Clean the corona wire inside the drum cartridge. • The drum cartridge may be damaged. Replace the drum cartridge with a new drum cartridge.
 <p data-bbox="316 1406 628 1438">White lines across the page</p>	<ul data-bbox="815 1146 1473 1442" style="list-style-type: none"> • Select the appropriate media type in the printer driver. • Select the appropriate media type in the menu setting. • The problem may disappear by itself. Print multiple blank pages to clear this problem, especially if the machine has not been used for a long time. • Clean the drum cartridge. • The drum cartridge may be damaged. Replace the drum cartridge with a new drum cartridge.
 <p data-bbox="347 1724 596 1756">Lines across the page</p>	<ul data-bbox="815 1464 1473 1572" style="list-style-type: none"> • Clean the drum cartridge. • The drum cartridge may be damaged. Replace the drum cartridge with a new drum cartridge.
 <p data-bbox="217 2036 727 2067">White lines, bands or ribbing across the page</p>	<ul data-bbox="815 1776 1473 1982" style="list-style-type: none"> • Check the machine's environment. Conditions such as high humidity and high temperatures may cause this print quality problem. • Clean the drum cartridge. • If the problem is not solved after printing a few pages, replace the drum cartridge with a new drum cartridge.

Examples of poor print quality	Recommendation
 <p>White Spots on black text and graphics at 94 mm intervals</p>  <p>Black spots at 94 mm intervals</p>	<ul style="list-style-type: none"> • Make 10-15 copies of a blank, white sheet of paper. If the problem is not solved after printing the blank pages, the drum cartridge may have foreign material, such as glue from a label, stuck on the drum. Clean the drum cartridge. <i>See Related Information: Clean the Drum Cartridge.</i> • The drum cartridge may be damaged. Replace the drum cartridge with a new drum cartridge.
 <p>Black toner marks across the page</p>	<ul style="list-style-type: none"> • If you use label sheets for laser printers, the glue from the sheets may sometimes stick to the drum surface. Clean the drum cartridge. <i>See Related Information: Clean the Drum Cartridge.</i> • If you used paper that has clips or staples, the drum cartridge may be damaged. • If the unpacked drum cartridge is in direct sunlight (or room light for long periods of time), the unit may be damaged. • Clean the drum cartridge. • The toner cartridge may be damaged. Replace the toner cartridge with a new toner cartridge. • The drum cartridge may be damaged. Replace the drum cartridge with a new drum cartridge.
 <p>Black lines down the page</p> <p>Printed pages have toner stains down the page</p>	<ul style="list-style-type: none"> • Clean the corona wire inside the drum cartridge by sliding the green tab. Make sure that the green tab on the drum cartridge is in the Home position. • The toner cartridge may be damaged. Replace the toner cartridge with a new toner cartridge. • The drum cartridge may be damaged. Replace the drum cartridge with a new drum cartridge. • The fusing unit may be contaminated. Contact Fuji Xerox customer service.
 <p>White lines down the page</p>	<ul style="list-style-type: none"> • Make sure foreign material such as a torn piece of paper, sticky notes or dust is not inside the machine and around the toner cartridge and drum cartridge. • The toner cartridge may be damaged. Replace the toner cartridge with a new toner cartridge. • The drum cartridge may be damaged. Replace the drum cartridge with a new drum cartridge.

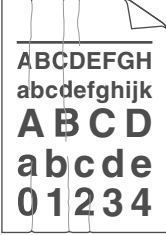
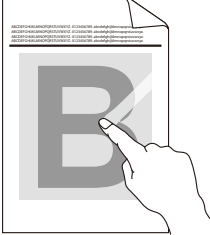
Examples of poor print quality	Recommendation
 <p data-bbox="389 432 555 459">Image skewed</p>	<ul data-bbox="817 181 1468 712" style="list-style-type: none"> • Set the document correctly in the ADF or on the scanner glass if the skew only occurs when making copies. • Make sure the paper or other print media is loaded correctly in the paper tray and the guides are not too tight or too loose against the paper stack. • Set the paper guides correctly. • The paper tray may be too full. • Check the paper type and quality. • Check for loose objects such as torn paper inside the machine. • If the problem only occurs during automatic 2-sided printing, check for torn paper in the 2-sided tray. Verify the 2-sided tray is inserted completely and the back cover is closed completely.
 <p data-bbox="389 1003 555 1030">Curling or wavy</p>	<ul data-bbox="817 741 1468 1075" style="list-style-type: none"> • Check the paper type and quality. High temperatures and high humidity will cause paper to curl. • If you do not use the machine often, the paper may have been in the paper tray too long. Turn over the stack of paper in the paper tray. Also, fan the paper stack, and then rotate the paper 180° in the paper tray. • Open the back cover (face up output tray) to let the printed paper exit onto the face up output tray. • Choose Reduce Paper Curl mode in the printer driver when you do not use our recommended print media.
 <p data-bbox="360 1361 584 1388">Wrinkles or creases</p>	<ul data-bbox="817 1111 1439 1249" style="list-style-type: none"> • Make sure paper is loaded correctly. • Check the paper type and quality. • Turn over the stack of paper in the tray or rotate the paper 180° in the input tray.
 <p data-bbox="411 1671 533 1697">Poor fixing</p>	<ul data-bbox="817 1420 1433 1697" style="list-style-type: none"> • Make sure the media type setting in the driver matches the type of paper you are using. • Choose Improve Toner Fixing mode in the printer driver. If this selection does not provide enough improvement, change the printer driver setting in Media Type to a thick setting. If you are printing an envelope, choose Env. Thick in the media type setting.

Examples of poor print quality	Recommendation
 <p data-bbox="371 533 571 566">Envelope creases</p>	<ul style="list-style-type: none"> • Make sure envelopes are printed with the back cover (face up output tray) opened. • Make sure envelopes are fed only from the MP tray.



Related Information

- [Troubleshooting](#)

Related Topics

- [Test Print](#)
- [Clean the Drum Cartridge](#)

Telephone and Fax Problems

Telephone Line or Connections

Difficulties	Suggestions
Dialling does not work. (No dial tone)	Check all line cord connections. Make sure the telephone line cord is plugged into the telephone wall socket and the LINE socket of the machine. If you subscribe to DSL or VoIP services, contact your service provider for connection instructions.
	(Available only for some countries.) Change the Tone/Pulse setting.
	Send a manual fax by pressing Hook button, and dialing the number. Wait to hear fax-receiving tones before pressing Start button.
	If there is no dial tone, connect a known working telephone and telephone line cord to the socket. Then lift the external telephone's handset and listen for a dial tone. If there is still no dial tone, ask your telephone company to check the line and/or wall socket.
The machine does not answer when called.	Make sure the machine is in the correct receive mode for your setup. Check for a dial tone. If possible, call your machine to hear it answer. If there is still no answer, check that the telephone line cord is plugged into the telephone wall socket and the LINE socket of the machine. If there is no ringing when you call your machine, ask your telephone company to check the line.

Handling Incoming Calls

Difficulties	Suggestions
Sending a Fax Call to the machine.	If you answered on an extension or external telephone, press your Remote Activation Code (the factory setting is *51 (*91 for New Zealand)). If you answered on the external telephone, press the Start button to receive the fax. When your machine answers, hang up.
Custom features on a single line.	If you have Call Waiting, Voice Mail, an answering machine, an alarm system or other custom feature on a single telephone line with your machine, it may create a problem sending or receiving faxes. For Example: If you subscribe to Call Waiting or some other custom service and its signal comes through the line while your machine is sending or receiving a fax, the signal can temporarily interrupt or disrupt the faxes. Fuji Xerox's ECM (Error Correction Mode) feature should help overcome this problem. This condition is related to the telephone system industry and is common to all devices that send and receive information on a single, shared line with custom features. If avoiding a slight interruption is crucial to your business, we recommend using a separate telephone line with no custom features.

Receiving Faxes

Difficulties	Suggestions
Cannot receive a fax.	Check all line cord connections. Make sure the telephone line cord is plugged into the telephone wall socket and the LINE socket of the machine. If you subscribe to DSL or VoIP services, contact your service provider for connection instructions. If you are using a VoIP system, try changing the VoIP setting to <i>Basic (for VoIP)</i> . This will lower modem speed and turn off Error Correction Mode (ECM).
	Make sure your machine has a dial tone by pressing the Hook button in Fax mode. If you hear static or interference on your fax line, contact your local telephone provider.

Difficulties	Suggestions
Cannot receive a fax.	<p>Make sure the machine is in the correct Receive Mode. This is determined by the external devices and telephone subscriber services you have on the same line as the Fuji Xerox machine.</p> <ul style="list-style-type: none"> • If you have a dedicated fax line and want your Fuji Xerox machine to automatically answer all incoming faxes, you should select Fax only mode. • If your Fuji Xerox machine shares a line with an external answering machine, you should select the External TAD mode. In External TAD mode, your Fuji Xerox machine will receive incoming faxes automatically and voice callers will be able to leave a message on your answering machine. • If your Fuji Xerox machine shares a line with other telephones and you want it to automatically answer all incoming faxes, you should select the Fax/Tel mode. In Fax/Tel mode, your Fuji Xerox machine will receive faxes automatically and produce a pseudo/double-ring to alert you to answer voice calls. • If you do not want your Fuji Xerox machine to answer any incoming faxes automatically, you should select the Manual mode. In Manual mode, you must answer every incoming call and activate the machine to receive faxes.
	<p>Another device or service at your location may be answering the call before your Fuji Xerox machine answers. To test this, lower the Ring Delay setting:</p> <ul style="list-style-type: none"> • If the Receive Mode is set to Fax Only or Fax/Tel, reduce the Ring Delay to one ring. • If the Receive Mode is set to External TAD, reduce the number of rings programmed on your answering machine to two. • If the Receive Mode is set to Manual, DO NOT adjust the Ring Delay setting.
	<p>Have someone send you a test fax:</p> <ul style="list-style-type: none"> • If you received the test fax successfully, your machine is operating correctly. Remember to reset your Ring Delay or answering machine setting back to your original setting. If receiving problems recur after resetting the Ring Delay, then a person, device, or subscriber service is answering the fax call before the machine has a chance to answer. • If you were not able to receive the fax, then another device or subscriber service may be interfering with your fax reception or there may be a problem with your fax line.
	<p>If you are using a telephone answering machine (External TAD mode) on the same line as the Fuji Xerox machine, make sure your answering machine is set up correctly.</p> <ol style="list-style-type: none"> 1. Set your answering machine to answer in one or two rings. 2. Record the outgoing message on your answering machine. <ul style="list-style-type: none"> • Record five seconds of silence at the beginning of your outgoing message. • Limit your speaking to 20 seconds. • End your outgoing message with your Remote Activation Code for people sending manual faxes. For example: "After the beep, leave a message or press *51 (*91 for New Zealand) and Start to send a fax." 3. Set your answering machine to answer calls. 4. Set your Fuji Xerox machine's Receive Mode to External TAD.
	<p>Make sure your Fuji Xerox machine's Fax Detect feature is turned On. Fax Detect is a feature that allows you to receive a fax even if you answered the call on an external or extension telephone.</p>
	<p>If you often get transmission errors due to possible interference on the telephone line or if you are using a VoIP system, try changing the Compatibility setting to <i>Basic(for VoIP)</i>.</p>
	<p>Contact your administrator to check your Secure Function Lock Settings.</p>

Sending Faxes

Difficulties	Suggestions
Cannot send a fax.	<p>Check all line cord connections. Make sure the telephone line cord is plugged into the telephone wall socket and the LINE socket of the machine. If you subscribe to DSL or VoIP services, contact your service provider for connection instructions.</p>
	<p>Make sure you pressed Fax and the machine is in Fax mode.</p>

Difficulties	Suggestions
Cannot send a fax.	Print the Transmission Verification Report and check for an error.
	Contact your administrator to check your Secure Function Lock Settings.
	Ask the other party to check that the receiving machine has paper.
Poor sending quality.	Try changing your resolution to Fine or S.Fine. Make a copy to check your machine's scanner operation. If the copy quality is poor, clean the scanner.
Transmission Verification Report says RESULT:ERROR.	There is probably temporary noise or static on the line. Try sending the fax again. If you are sending a PC-Fax message and get RESULT:ERROR on the Transmission Verification Report, your machine may be out of memory. To free up extra memory, you can turn off Fax Storage, print fax messages in memory or cancel a delayed fax. If the problem continues, ask the telephone company to check your telephone line.
	If you often get transmission errors due to possible interference on the telephone line or if you are using a VoIP system, try changing the Compatibility setting to Basic(for VoIP).
Sent faxes are blank.	Make sure you are loading the document correctly. When using the ADF, the document should be face up. When using the scanner glass, the document should be face down.
Vertical black lines when sending.	Black vertical lines on faxes you send are typically caused by dirt or correction fluid on the glass strip. Clean the glass strip.

Printing received faxes

Difficulties	Suggestions
<ul style="list-style-type: none"> • Condensed print • Horizontal streaks • Top and bottom sentences are cut off • Missing lines 	<p>This is usually caused by a poor telephone connection. Make a copy; if your copy looks good, you probably had a bad connection, with static or interference on the telephone line. Ask the other party to send the fax again.</p>
Vertical black lines when receiving	The corona wire for printing may be dirty. Clean the corona wire in the drum cartridge.
	The sender's scanner may be dirty. Ask the sender to make a copy to see if the problem is with the sending machine. Try receiving from another fax machine.
Received faxes appear as split or blank pages.	Left and right margins are cut off or a single page is printed on two pages.
	Turn on Auto Reduction.



Related Information



- [Troubleshooting](#)
- [Set Dial Tone Detection](#)
- [Set Telephone Line Compatibility for Interference and VoIP Systems](#)

Related Topics

- [Clean the Scanner](#)
- [Set the Number of Rings Before the Machine Answers \(Ring Delay\)](#)
- [Choose the Correct Receive Mode](#)

Set Dial Tone Detection

Setting the Dial Tone to [Detection] will shorten the Dial Tone detect pause.

1. Press  [Settings] > [All Settings] > [Initial Setup] > [Dial Tone].
2. Press [Detection] or [No Detection]
3. Press .



Related Information



- [Telephone and Fax Problems](#)

Set Telephone Line Compatibility for Interference and VoIP Systems

Problems sending and receiving faxes due to possible interference on the telephone line may be solved by reducing the modem speed to minimise errors in fax transmission. If you are using a Voice over IP (VoIP) service, Fuji Xerox recommends changing the compatibility to Basic (for VoIP).



- VoIP is a type of phone system that uses an Internet connection, rather than a traditional phone line.
- Telephone providers frequently bundle VoIP together with Internet and cable services.
- Fuji Xerox does not recommend the use of a VoIP line. VoIP limitations in general can cause some functions of the fax machine not to work correctly.

1. Press  [Settings] > [All Settings] > [Initial Setup] > [Compatibility].
2. Press the option you want.
 - Select [High] to set the modem speed to 33600 bps.
 - Select [Normal] to set the modem speed to 14400 bps.
 - Select [Basic (for VoIP)] to reduce the modem speed to 9600 bps and turn off Error Correction Mode (ECM). Unless interference is a recurring problem on your telephone line, you may prefer to use this option only when needed.
3. Press .



Related Information

- [Telephone and Fax Problems](#)

Network Problems

- [Error Messages](#)
- [Use the Network Connection Repair Tool \(Windows®\)](#)
- [Where Can I Find My Fuji Xerox Machine's Network Settings?](#)
- [I Cannot Complete the Wireless Network Setup Configuration](#)
- [My Fuji Xerox Machine Cannot Print, Scan, or PC-FAX Receive over the Network](#)
- [I Want to Check that My Network Devices are Working Correctly](#)

Error Messages

Your Fuji Xerox machine will display an error message if an error occurs. The most common error messages are shown in the table.

Error Messages	Cause	Action
The maximum number of devices are already connected using Wi-Fi Direct.	Two mobile devices are already connected to the Wi-Fi Direct network when the Fuji Xerox machine is the Group Owner (G/O).	After the current connection between your Fuji Xerox machine and another mobile device has shut down, try to configure the Wi-Fi Direct settings again. You can confirm the connection status by printing the Network Configuration Report.
Authentication Error, contact your administrator.	Your authentication setting for the Store Print Log to Network feature is not correct.	<ul style="list-style-type: none"> Make sure the Username and Password in Authentication Setting are correct. If the username is part of a domain, enter the username in one of the following styles: user@domain or domain\user. Make sure the time of the log file server matches the time from the SNTP server, or the Date&Time settings. Make sure the SNTP time server settings are configured correctly so the time matches the time used for authentication by Kerberos or NTLMv2. If there is no SNTP server, make sure the Date&Time and Time Zone settings are set correctly using Web Based Management or the control panel so the machine matches the time being used by the server providing the authentication.
Check User ID and Password.	The Kerberos Authentication error.	Make sure you have entered a correct user name and a password for the Kerberos server. For more information on the Kerberos server settings, contact your network administrator.
	The date, time and time zone settings of the Fuji Xerox machine are not correct.	Confirm your machine's date, time and time zone settings.
	The DNS server configuration is not correct.	Contact your network administrator for the information on the DNS server settings.
	The Fuji Xerox machine cannot connect to the Kerberos server.	Contact your network administrator for the information on the Kerberos server settings.
Connection Error	Other devices are trying to connect to the Wi-Fi Direct network at the same time.	<ul style="list-style-type: none"> Make sure there are no other devices trying to connect to the Wi-Fi Direct network, and then try to configure the Wi-Fi Direct settings again.
Connection Failed	The Fuji Xerox machine and your mobile device cannot communicate during the Wi-Fi Direct network configuration.	<ul style="list-style-type: none"> Move the mobile device closer to your Fuji Xerox machine. Move your Fuji Xerox machine and the mobile device to an obstruction-free area. If you are using the PIN Method of WPS, make sure you have entered the correct PIN.

Error Messages	Cause	Action
File Access Error, contact your administrator.	The Fuji Xerox machine cannot access the destination folder for the Store Print Log to Network feature.	<ul style="list-style-type: none"> • Make sure the stored directory name is correct. • Make sure the stored directory is write-enabled. • Make sure the file is not locked.
	In Web Based Management, you have selected the Cancel Print option in the Error Detection Setting of Store Print Log to Network .	Wait for about 120 seconds until this message disappears from the LCD.
No Device	When configuring the Wi-Fi Direct network, the Fuji Xerox machine cannot find your mobile device.	<ul style="list-style-type: none"> • Make sure your machine and mobile device are in the Wi-Fi Direct mode. • Move the mobile device closer to your Fuji Xerox machine. • Move your Fuji Xerox machine and the mobile device to an obstruction-free area. • If you are manually configuring the Wi-Fi Direct network, make sure you have entered the correct password. • If your mobile device has a configuration page for how to obtain an IP address, make sure the IP address of your mobile device has been configured via DHCP.
Server Timeout, contact your administrator.	The Fuji Xerox machine cannot connect to the server for the Store Print Log to Network feature.	<ul style="list-style-type: none"> • Make sure your server address is correct. • Make sure your server is connected to the network. • Make sure the machine is connected to the network.
Server Timeout	The Fuji Xerox machine cannot connect to the LDAP server.	<ul style="list-style-type: none"> • Make sure your server address is correct. • Make sure your server is connected to the network. • Make sure the machine is connected to the network.
	The Fuji Xerox machine cannot connect to the Active Directory® server.	<ul style="list-style-type: none"> • Make sure your server address is correct. • Make sure your server is connected to the network. • Make sure the machine is connected to the network.
Wrong Date&Time, contact your administrator.	The Fuji Xerox machine does not obtain the time from the SNTP time server or you have not configured the Date&Time for the machine.	<ul style="list-style-type: none"> • Make sure the settings to access the SNTP time server are configured correctly in Web Based Management. • Confirm the Date&Time settings of your machine are correct in Web Based Management.
Internal Error	The Fuji Xerox machine's LDAP protocol is disabled.	Confirm your authentication method, and then enable the necessary protocol setting in the Web Based Management.
	The Fuji Xerox machine's CIFS protocol is disabled.	



Related Information



- [Network Problems](#)

Use the Network Connection Repair Tool (Windows®)

Use the Network Connection Repair Tool to fix the Fuji Xerox machine's network settings. It will assign the correct IP address and Subnet Mask.

- (Windows® 7/Windows® 8/Windows® 10)
You must log on with Administrator rights.
- Make sure the Fuji Xerox machine is turned on and is connected to the same network as your computer.

1. Do one of the following:

Option	Description
Windows® 7	Click  (Start) > Computer.
Windows® 8/Windows® 10	Click the  (File Explorer) icon on the taskbar, and then click Computer (This PC) in the left navigation bar.

2. Double-click **XXX(C:)** (where XXX is the name of your local disk drive) > **Program Files** > **Brownny02** > **Fuji Xerox** > **Fuji XeroxNetTool.exe**.



- For 64-bit OS users, double-click **XXX(C:)** (where XXX is the name of your local disk drive) > **Program Files (x86)** > **Brownny02** > **Fuji Xerox** > **Fuji XeroxNetTool.exe**.
- If the **User Account Control** screen appears, click **Yes**.

3. Follow the on-screen instructions.

4. Check the diagnosis by printing the Network Configuration Report.



The Network Connection Repair Tool will start automatically if you select the **Enable Connection Repair Tool** option in the Status Monitor. Right-click the Status Monitor screen, and then click **Other Settings** > **Enable Connection Repair Tool**. This is not recommended when your network administrator has set the IP address to Static, since it will automatically change the IP address.

If the correct IP address and the Subnet Mask are still not assigned even after using the Network Connection Repair Tool, ask your network administrator for this information.



Related Information

- [Network Problems](#)

Related Topics

- [Print the Network Configuration Report](#)
- [My Fuji Xerox Machine Cannot Print, Scan, or PC-FAX Receive over the Network](#)
- [I Want to Check that My Network Devices are Working Correctly](#)

Where Can I Find My Fuji Xerox Machine's Network Settings?

- [Print the Network Configuration Report](#)
- [Change Machine Settings from Your Computer](#)

I Cannot Complete the Wireless Network Setup Configuration

Related Models: DocuPrint M385 z/DocuPrint M375 z

Turn your wireless router off and back on. Then try to configure the wireless settings again. If you are unable to resolve the problem, follow the instructions below:

Investigate the problem using the WLAN Report.

Cause	Action	Interface
Your security settings (SSID/ Network Key) are not correct.	<ul style="list-style-type: none"> • Select and confirm that you are using the correct security settings. <ul style="list-style-type: none"> - See the instructions supplied with your wireless LAN access point/router for information on how to find the security settings. - The manufacturer's name or model number of the wireless LAN access point/router may be used as the default security settings. - Consult with the access point/router manufacturer, your Internet provider, or network administrator. 	Wireless
Your Fuji Xerox machine's MAC address is not allowed.	Confirm that the Fuji Xerox machine's MAC Address is allowed in the filter. You can find the MAC Address on your Fuji Xerox machine's control panel.	Wireless
Your wireless LAN access point/router is in stealth mode (not broadcasting the SSID).	<ul style="list-style-type: none"> • Enter the correct SSID name or Network Key manually. • Check the SSID name or the Network Key in the instructions supplied with your wireless LAN access point/router and reconfigure the wireless network setup. 	Wireless
Your security settings (SSID/ password) are not correct.	<ul style="list-style-type: none"> • Confirm the SSID and password. <ul style="list-style-type: none"> - When you are configuring the network manually, the SSID and password are displayed on your Fuji Xerox machine. If your mobile device supports the manual configuration, the SSID and password will be displayed on your mobile device's screen. 	Wi-Fi Direct
You are using Android™ 4.0.	If your mobile device disconnects (approximately six minutes after using Wi-Fi Direct), try the one-push configuration using WPS (recommended) and set the Fuji Xerox machine as a G/O.	Wi-Fi Direct
Your Fuji Xerox machine is placed too far from your mobile device.	Move your Fuji Xerox machine within about 3.3 feet (1 metre) of the mobile device when you configure the Wi-Fi Direct network settings.	Wi-Fi Direct
There are some obstructions (walls or furniture, for example) between your machine and the mobile device.	Move your Fuji Xerox machine to an obstruction-free area.	Wi-Fi Direct
There is a wireless computer, Bluetooth-supported device, microwave oven, or digital cordless phone near the Fuji Xerox machine or the mobile device.	Move other devices away from the Fuji Xerox machine or the mobile device.	Wi-Fi Direct

Cause	Action	Interface
If you have checked and tried all of the above, but still cannot complete the Wi-Fi Direct configuration, do the following:	<ul style="list-style-type: none"> • Turn your Fuji Xerox machine off and back on. Then try to configure the Wi-Fi Direct settings again. • If you are using your Fuji Xerox machine as a client, confirm how many devices are allowed in the current Wi-Fi Direct network, and then check how many devices are connected. 	Wi-Fi Direct

For Windows®

If your wireless connection has been interrupted, and you have checked and tried all of the above, we recommend using the Network Connection Repair Tool.



Related Information



- [Network Problems](#)

Related Topics

- [Configure Your Machine for a Wireless Network When the SSID Is Not Broadcast](#)
- [Use Wi-Fi Direct®](#)

My Fuji Xerox Machine Cannot Print, Scan, or PC-FAX Receive over the Network

Cause	Action	Interface
<p>Your security software blocks your machine's access to the network. (The Network scanning feature does not work.)</p>	<ul style="list-style-type: none"> • (Windows®) Configure the third-party Security/Firewall Software to allow Network scanning. To add port 54925 for Network scanning, type the information below: <ul style="list-style-type: none"> - In Name: Type any description, for example Fuji Xerox NetScan. - In Port number: Type 54925. - In Protocol: UDP is selected. <p>See the instruction manual that came with your third-party Security/Firewall Software or contact the software manufacturer.</p>	Wired/Wireless
<p>Your security software blocks your machine's access to the network. (The network PC-Fax Receive feature does not work.) (Windows®)</p>	<p>Set the third-party Security/Firewall Software to allow PC-FAX Rx. To add port 54926 for Network PC-FAX Rx, type the information below:</p> <ul style="list-style-type: none"> • In Name: Type any description, for example Fuji Xerox PC-FAX Rx. • In Port number: Type 54926. • In Protocol: UDP is selected. <p>See the instruction manual that came with your third-party Security/Firewall Software or contact the software manufacturer.</p>	Wired/Wireless
<p>Your security software blocks your machine's access to the network.</p>	<p>Some security software might block access without showing a security alert dialog box even after successful installation.</p> <p>To allow access, see the instructions for your security software or ask the software manufacturer.</p>	Wired/Wireless
<p>Your Fuji Xerox machine was not assigned an available IP address.</p>	<ul style="list-style-type: none"> • Confirm the IP address and the Subnet Mask. Verify that both the IP addresses and Subnet Masks of your computer and the Fuji Xerox machine are correct and located on the same network. For more information about how to verify the IP address and the Subnet Mask, ask your network administrator. • (Windows®) Confirm the IP address and the Subnet Mask using the Network Connection Repair Tool. 	Wired/Wireless

Cause	Action	Interface
<p>The failed print job is still in your computer's print queue.</p>	<ul style="list-style-type: none"> • If the failed print job is still in your computer's print queue, delete it. • Otherwise, double-click the printer icon in the following folder and cancel all documents: <ul style="list-style-type: none"> - (Windows® 7) <p>Click  (Start) > Devices and Printers > Printers and Faxes.</p> - (Windows® 8) <p>Move your mouse to the lower right corner of your desktop. When the menu bar appears, click Settings > Control Panel. In the Hardware and Sound group, click View devices and printers > Printers.</p> - (Windows® 10 and Windows Server® 2016) <p>Click  > Windows System > Control Panel. In the Hardware and Sound group, click View devices and printers.</p> - (Windows Server® 2008) <p>Click Start > Control Panel > Printers.</p> - (Windows Server® 2012) <p>Move your mouse to the lower right corner of your desktop. When the menu bar appears, click Settings > Control Panel. In the Hardware group, click View devices and printers > Printers.</p> - (Windows Server® 2012 R2) <p>Click Control Panel on the Start screen. In the Hardware group, click View devices and printers.</p> - (Mac) <p>Click System Preferences > Printers & Scanners.</p> 	<p>Wired/Wireless</p>
<p>Your Fuji Xerox machine is not connected to the wireless network.</p>	<p>Print the WLAN Report to check the error code on the printed report.</p>	<p>Wireless</p>

If you have checked and tried all of the above, but your Fuji Xerox machine still cannot print and scan, uninstall the Fuji Xerox software and drivers and reinstall them.



Related Information

- [Network Problems](#)

Related Topics

- [Print the WLAN Report](#)
- [Wireless LAN Report Error Codes](#)
- [Use the Network Connection Repair Tool \(Windows®\)](#)
- [I Want to Check that My Network Devices are Working Correctly](#)

I Want to Check that My Network Devices are Working Correctly

Check	Action	Interface
Check that your Fuji Xerox machine, access point/router, or network hub is turned on.	<p>Check the following:</p> <ul style="list-style-type: none"> The power cord is connected correctly and the Fuji Xerox machine is turned on. The access point/router or hub is turned on and its link button is blinking. All protective packaging has been removed from the machine. The toner cartridge and drum cartridge are installed correctly. The front and back covers are fully closed. Paper is inserted correctly in the paper tray. (For wired networks) A network cable is securely connected to the Fuji Xerox machine and to the router or hub. 	Wired/Wireless
Check the Link Status in the Network Configuration Report.	Print the Network Configuration Report and check that Ethernet Link Status or Wireless Link Status is Link OK .	Wired/Wireless
Check that you can "ping" the Fuji Xerox machine from your computer.	<p>Ping the Fuji Xerox machine from your computer using the IP address or the node name in the Windows® command prompt or Mac Terminal application:</p> <p>ping <ipaddress> or <nodename>.</p> <ul style="list-style-type: none"> Successful: Your Fuji Xerox machine is working correctly and connected to the same network as your computer. Unsuccessful: Your Fuji Xerox machine is not connected to the same network as your computer. <p>(Windows®)</p> <p>Ask the network administrator and use the Network Connection Repair Tool to fix the IP address and the subnet mask.</p> <p>(Mac)</p> <p>Confirm that the IP address and the Subnet Mask are set correctly.</p>	Wired/Wireless
Check that your Fuji Xerox machine is connected to the wireless network.	Print the WLAN Report to check the error code on the printed report.	Wireless

If you have checked and tried all of the above but you are still having problems, see the instructions supplied with your wireless LAN access point/router to find the SSID and the Network Key information and set them correctly.



Related Information

- [Network Problems](#)

Related Topics

- [Print the Network Configuration Report](#)
- [Print the WLAN Report](#)
- [Wireless LAN Report Error Codes](#)
- [Use the Network Connection Repair Tool \(Windows®\)](#)
- [My Fuji Xerox Machine Cannot Print, Scan, or PC-FAX Receive over the Network](#)

Google Cloud Print Problems

Related Models: DocuPrint M375 z/DocuPrint M375 df

Difficulty	Suggestions
My Fuji Xerox machine is not displayed in the printer list.	Make sure your machine is turned on.
	Confirm that Google Cloud Print™ is enabled.
	Confirm that your machine is registered with Google Cloud Print™. If it is not registered, try to register again.
I cannot print.	Make sure your machine is turned on.
	Confirm your network settings. See <i>Related Information</i> .
	Certain files may not be printable, or may not appear exactly as they are displayed.
I cannot register my Fuji Xerox machine with Google Cloud Print™.	Make sure your machine is connected to a network with Internet access.
	Verify that the date and time are set correctly on your machine.
I do not see a confirmation message on my Fuji Xerox machine when I try to register with Google Cloud Print™, even after repeating the registration steps.	Make sure your Fuji Xerox machine is idle while you are registering with Google Cloud Print™.







Related Information

- [Troubleshooting](#)

Related Topics

- [Network Settings for Using Google Cloud Print](#)

Other Problems

Difficulties	Suggestions
<p>The machine will not turn on.</p>	<p>Adverse conditions on the power connection (such as lightning or a power surge) may have triggered the machine's internal safety mechanisms. Unplug the power cord. Wait for ten minutes, then plug in the power cord and press  to turn on the machine.</p> <p>If the problem is not solved and you are using a power breaker, disconnect it to make sure it is not the problem. Plug the machine's power cord directly into a different known working wall electrical socket. If there is still no power, try a different power cable.</p>
<p>The machine cannot print EPS data that includes binary with the PS3 emulate printer driver.</p>	<p>(Windows®)</p> <p>To print EPS data, do the following:</p> <ol style="list-style-type: none"> For Windows® 7 and Windows Server® 2008 R2: <ul style="list-style-type: none"> Click the  (Start) button > Devices and Printers. For Windows Server® 2008: <ul style="list-style-type: none"> Click the  (Start) button > Control Panel > Hardware and Sound > Printers. For Windows® 8 and Windows Server® 2012: <ul style="list-style-type: none"> Move your mouse to the lower right corner of your desktop. When the menu bar appears, click Settings > Control Panel. In the Hardware and Sound *1 group, click View devices and printers. For Windows® 10 and Windows Server® 2016: <ul style="list-style-type: none"> Click  > Windows System > Control Panel. In the Hardware and Sound group, click View devices and printers. For Windows Server® 2012 R2: <ul style="list-style-type: none"> Click Control Panel on the Start screen. In the Hardware group, click View devices and printers. <ol style="list-style-type: none"> Right-click the FX DocuPrint XXXXX PS3 emulate icon, select Printer properties. From the Device Settings tab, choose TBCP (Tagged binary communication protocol) in Output Protocol.
<p>The Fuji Xerox software cannot be installed.</p>	<p>(Windows®)</p> <p>If the Security Software warning appears on the computer screen during the installation, change the Security Software settings to permit the Fuji Xerox product setup program or other program to run.</p> <p>(Mac)</p> <p>If you are using a firewall function of anti-spyware or antivirus security software, temporarily disable it and then install the Fuji Xerox software.</p>

*1 For Windows Server® 2012: **Hardware and Sound**

Copying difficulties

Difficulties	Suggestions
Cannot make a copy.	Make sure you pressed Copy and the machine is in Copy mode. Contact your administrator to check your Secure Function Lock Settings.
Vertical black line appears in copies.	Black vertical lines on copies are typically caused by dirt or correction fluid on the glass strip, or the corona wire is dirty. Clean the glass strip and scanner glass and the white bar and white plastic above them.
Copies are blank.	Make sure you are loading the document correctly.

Scanning difficulties

Difficulties	Suggestions
TWAIN or Windows Image Acquisition (WIA) errors appear when starting to scan. (Windows®)	Make sure the Fuji Xerox TWAIN or Windows Image Acquisition (WIA) driver is selected as the primary source in your scanning application. For example, in Nuance™ PaperPort™ 14SE, click Desktop > Scan Settings > Select to choose the Fuji Xerox TWAIN/Windows Image Acquisition (WIA) driver.
OCR does not work.	Try increasing the scanning resolution.
Cannot scan.	Contact your administrator to check your Secure Function Lock Settings.

Software difficulties

Difficulties	Suggestions
Cannot install software or print.	(Windows®) Run the install program again. This program will repair and reinstall the software.



Related Information

- [Troubleshooting](#)

Related Topics

- [Clean the Scanner](#)
-

Check the Machine Information

Follow these instructions to check your Fuji Xerox machine's serial number and firmware version.

1. Press  [Settings] > [All Settings] > [Machine Info.].
2. Press one of the following options:

Option	Description
Serial No.	Check your machine's serial number.
Firmware Version	Check your machine's firmware version.
Page Counter	Check the number of total pages the machine has printed.
Parts Life	Check the percentage of the supplies' life that remains available.



3. Press .



Related Information

- [Troubleshooting](#)

Reset Your Fuji Xerox Machine

1. Press  [Settings] > [All Settings] > [Initial Setup] > [Reset].
2. Swipe up or down or press ▲ or ▼ to display the type of reset functions, and then press the reset function you want to use.
3. [Machine will reboot after resetting. Press [OK] for 2 seconds to confirm.] appears. Press [OK] for two seconds to confirm.
The machine will restart.
4. Press .



You can also reset the Network settings by pressing  [Settings] > [All Settings] > [Network] > [Network Reset].



Related Information

- [Troubleshooting](#)
 - [Reset Functions Overview](#)
-

Reset Functions Overview

The following reset functions are available:



Unplug the interface cable before you choose Network Settings Reset function, All Settings Reset function or Factory Reset function.

1. Machine Reset

Reset all the machine's settings that you have changed, such as Date and Time and Ring Delay. The Address Book, fax reports, and Call history will remain.

2. Network Settings Reset

Reset the print server back to its default factory settings (includes Password and IP Address information).

3. Address Book and Fax Settings Reset

This function resets the following settings:

- Address Book
(Addresses and Groups)
- Programmed fax jobs in the memory
(Delayed Fax)
- Station ID
(name and number)
- Coverpage Message
- Fax receive settings
(Remote Access Code, Fax Storage, Fax Forwarding, and PC-Fax Receive (Windows® only))
- Report
(Transmission Verification Report / Tel Index List / Fax Journal)
- Setting Lock password

4. All Settings Reset

Reset all the machine's settings back to the settings that were set at the factory. All Settings Reset takes less time than Factory Reset.

5. Factory Reset

Use the Settings Reset function to reset all machine's settings to the settings originally set at the factory. Factory Reset takes more time than All Settings Reset. Fuji Xerox strongly recommends you perform this operation when you dispose of the machine.



Unplug the interface cable before you choose Network Settings Reset function, All Settings Reset function or Factory Reset function.



Related Information

- [Reset Your Fuji Xerox Machine](#)

Routine Maintenance

- [Replace Supplies](#)
- [Clean the Machine](#)
- [Check the Remaining Life of Parts](#)
- [Replace Periodic Maintenance Parts](#)

Replace Supplies

You must replace supplies when the machine indicates that the life of the supply is over.

Using non-Fuji Xerox supplies may affect the print quality, hardware performance, and machine reliability. The toner cartridge and drum cartridge are two separate supplies. Make sure both are installed as an assembly. The model name of supplies may vary depending on the country.

NOTE

- Contact your local Fuji Xerox office for further details.
- Be sure to seal up the used supplies tightly in a bag so that toner powder does not spill out of the cartridge.
- Discard used consumable items according to local regulations, keeping it separate from domestic waste. If you have questions, call your local waste disposal office. Be sure to reseal the consumable items tightly so that the material inside does not spill.
- We recommend placing used and new supplies on a piece of paper to prevent accidentally spilling or scattering the material inside.
- If you use paper that is not a direct equivalent for the recommended print media, the life of supplies and machine parts may be reduced.
- The projected life for each of the toner cartridges is based on ISO/IEC 19752. Frequency of replacement will vary depending on the print volume, percentage of coverage, types of media used, and powering on/off the machine.
- Frequency of replacing supplies except toner cartridges will vary depending on the print volume, types of media used, and powering on/off the machine.
- Handle the toner cartridge carefully. If toner scatters on your hands or clothes, immediately wipe or wash it off with cold water.

⚠ WARNING

- Never use a vacuum cleaner for spilled toner and residual toner in this product, toner cartridge or toner bottle. It may catch fire by electric sparks inside a vacuum cleaner and cause explosion. Use a broom or a wet cloth to wipe off the spills. If you spill a large volume of toner, contact your local Fuji Xerox representative.
- Never throw a toner cartridge into an open flame. Remaining toner in the cartridge may catch fire and cause burn injuries or explosion. If you have a used toner cartridge no longer needed, contact your local Fuji Xerox representative for its disposal.

⚠ CAUTION

- Keep drum cartridges (or drum if not a cartridge type) and toner cartridges out of the reach of children. If a child accidentally swallows toner, spit it out, rinse mouth with water, drink water and consult a physician immediately.
- When replacing drum cartridges (or drum if not a cartridge type) and toner cartridges, be careful not to spill the toner. In case of any toner spills, avoid contact with clothes, skin, eyes and mouth as well as inhalation.

IMPORTANT

- Fuji Xerox machines are designed to work with toner of a particular specification and will work to a level of optimum performance when used with Fuji Xerox Original toner cartridges. Fuji Xerox cannot guarantee this optimum performance if toner or toner cartridges of other specifications are used. The machine may not detect toner or toner cartridges of other specifications correctly but may instead detect such items as standard capacity toner cartridges. Fuji Xerox does not therefore recommend the use of cartridges other than Fuji Xerox Original cartridges with this machine, or the refilling of empty cartridges with toner from other

sources. If damage is caused to the drum cartridge or other parts of this machine as a result of the use of toner or toner cartridges other than Fuji Xerox Original products due to the incompatibility or lack of suitability of those products with this machine, any repairs required as a result may not be covered by the warranty.

- For best performance, use a Fuji Xerox Original drum cartridge and toner cartridge. Printing with a third party drum cartridge or toner cartridge may reduce not only the print quality but also the quality and life of the machine itself. Warranty coverage may not apply to problems caused by the use of a third party drum cartridge or toner cartridge.
- To avoid print quality problems, DO NOT touch the shaded parts shown in the illustrations.

Toner cartridge

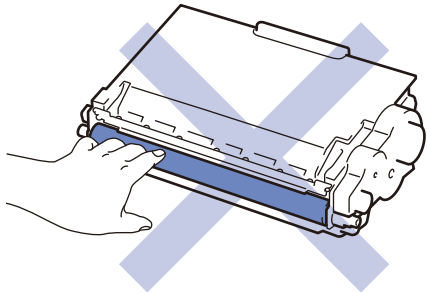

Drum cartridge

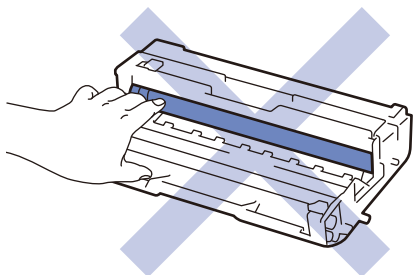
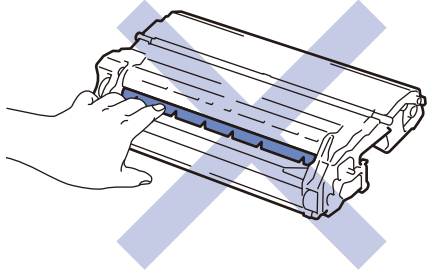

Related Information

- [Routine Maintenance](#)
 - [Replace the Toner Cartridge](#)
 - [Replace the Drum Cartridge](#)

Related Topics

- [Error and Maintenance Messages](#)
 - [Supplies](#)
-

Replace the Toner Cartridge

1. Make sure the machine is turned on.
2. Open the front cover.

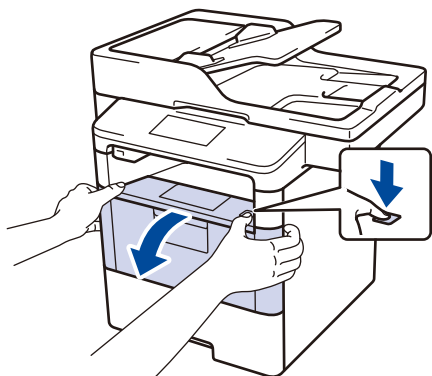

3. Remove the toner cartridge and drum cartridge assembly from the machine.

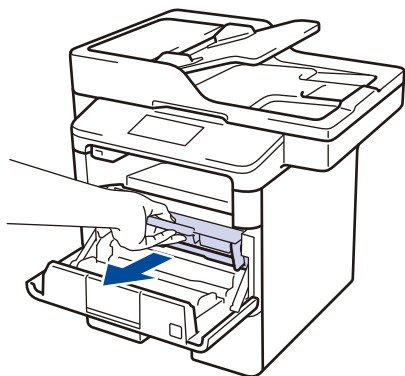

4. Push down the green lock lever and take the toner cartridge out of the drum cartridge.

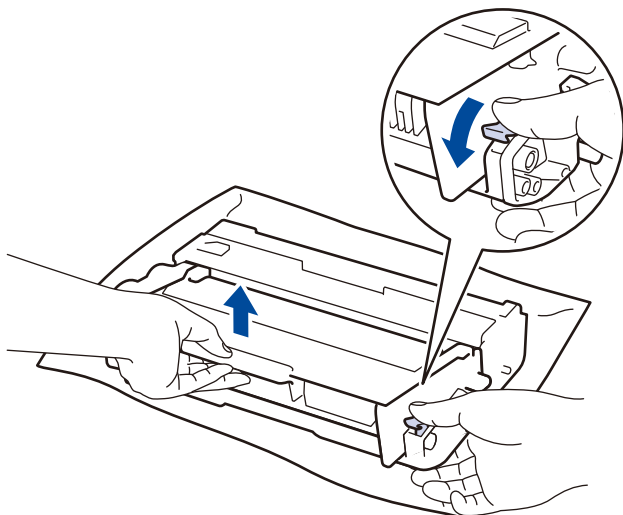

5. Unpack the new toner cartridge.
6. Remove the protective cover.

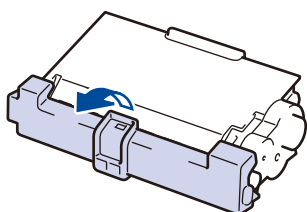

7. Put the new toner cartridge firmly into the drum cartridge until you hear it lock into place.

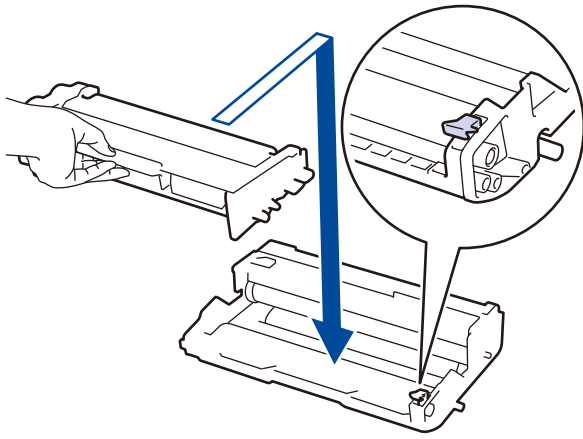

Make sure you put the toner cartridge in correctly or it may separate from the drum cartridge.

8. Clean the corona wire inside the drum cartridge by gently sliding the green tab from left to right and right to left several times.

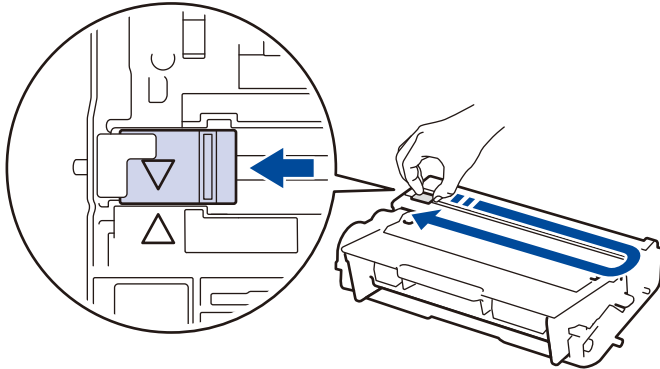

Be sure to return the tab to the Home position (▲). The arrow on the tab must be aligned with the arrow on the drum cartridge. If it is not, printed pages may have a vertical stripe.

9. Install the toner cartridge and drum cartridge assembly back into the machine.

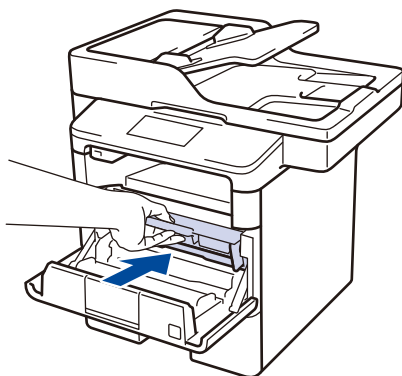

10. Close the front cover of the machine.



-
- After replacing a toner cartridge, DO NOT turn off the machine or open the front cover until the machine's display returns to Ready Mode.
 - The toner cartridge that comes with your Fuji Xerox machine is a Inbox toner cartridge.
 - It is a good idea to keep a new toner cartridge ready for use when you see the Toner Low warning.
 - To ensure high quality printing, we recommend using only Fuji Xerox Original toner cartridges. When you want to buy toner cartridges, contact Fuji Xerox Dealer.
 - DO NOT unpack the new toner cartridge until you are ready to install it.
 - If a toner cartridge is left unpacked for a long time, the toner cartridge life will be shortened.
 - Fuji Xerox strongly recommends you DO NOT refill the toner cartridge provided with your machine. We also strongly recommend you continue to use only Fuji Xerox Original replacement toner cartridges. Use or attempted use of third party toner and/or cartridges in the Fuji Xerox machine may cause damage to the machine and/or may result in unsatisfactory print quality. Our limited warranty coverage does not apply to any problem that is caused by the use of third party toner and/or cartridges. To protect your investment and obtain premium performance from the Fuji Xerox machine, we strongly recommend the use of Fuji Xerox Original Supplies.
-



Related Information

- [Replace Supplies](#)
-

Replace the Drum Cartridge

1. Make sure the machine is turned on.
2. Open the front cover.

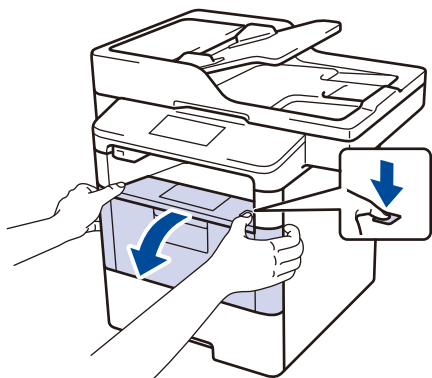

3. Remove the toner cartridge and drum cartridge assembly from the machine.

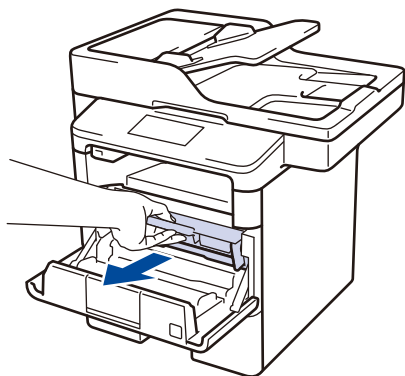

4. Push down the green lock lever and take the toner cartridge out of the drum cartridge.

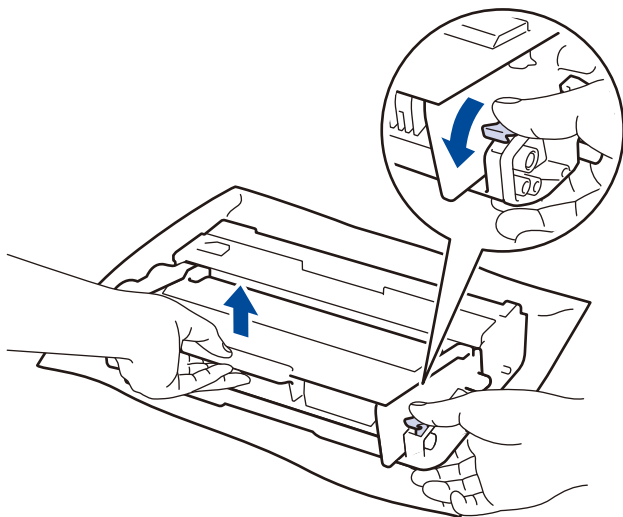

5. Unpack the new drum cartridge.

6. Put the toner cartridge firmly into the new drum cartridge until you hear it lock into place.

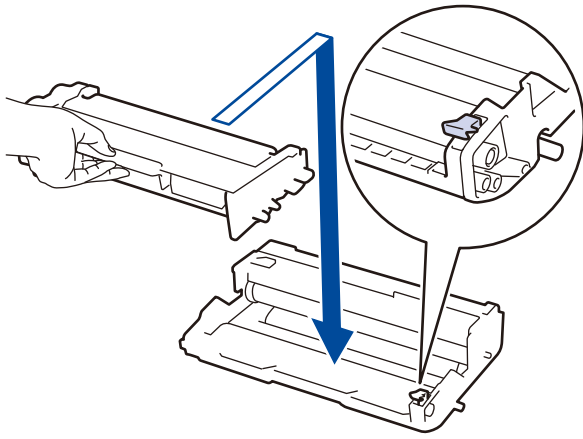

Make sure you put the toner cartridge in correctly or it may separate from the drum cartridge.

7. Clean the corona wire inside the drum cartridge by gently sliding the green tab from left to right and right to left several times.

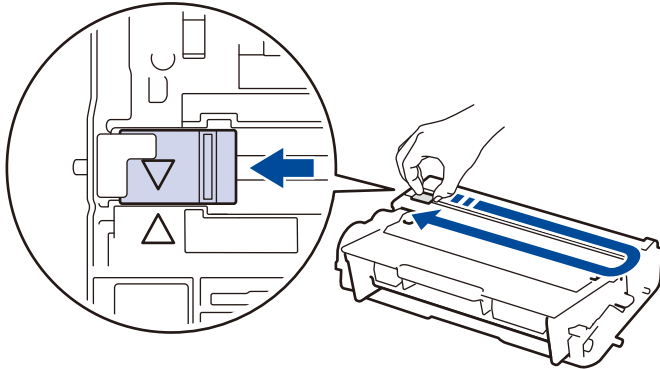

Be sure to return the tab to the Home position (▲). The arrow on the tab must be aligned with the arrow on the drum cartridge. If it is not, printed pages may have a vertical stripe.

8. Install the toner cartridge and drum cartridge assembly back into the machine.

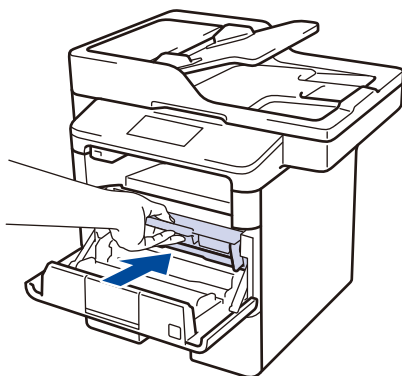

9. Close the front cover of the machine.
10. Reset the drum cartridge counter.



For more information on how to reset the drum cartridge counter, see the *How to Replace the Drum Cartridge*.

NOTE

- Drum cartridge wear and tear occurs due to use and rotation of the drum cartridge and interaction with paper, toner and other materials in the paper path. In designing this product, Fuji Xerox decided to use the number of rotations of the drum cartridge as a reasonable determinant of the drum cartridge life. When a drum cartridge reaches the factory-established rotation limit corresponding to the rated page yield, the product's LCD will advise you to replace the drum cartridge. The product will continue to function; however, print quality may not be optimal.
- If an unpacked drum cartridge is placed in direct sunlight (or room light for long periods of time), the unit may be damaged.
- There are many factors that determine the actual drum cartridge life, such as the temperature, humidity, type of paper, type of toner used and so on. Under ideal conditions, the average drum cartridge life is estimated at approximately 30,000 pages based on 1 page per job and 50,000 pages based on 3 pages per job [A4/letter simplex pages]. The number of pages may be affected due to a variety of factors including but not limited to media type and media size.

Because we have no control over the many factors that determine the actual drum cartridge life, we cannot guarantee a minimum number of pages that will be printed by your drum cartridge.

- For best performance, use only Fuji Xerox Original toner cartridge.
 - The machine should be used only in a clean, dust-free environment with adequate ventilation.
- Printing with a non-Fuji Xerox drum cartridge may reduce not only the print quality but also the quality and life of the machine itself. Warranty coverage does not apply to problems caused by the use of a non-Fuji Xerox drum cartridge.



Related Information

- [Replace Supplies](#)
-

Clean the Machine

Clean the outside and inside of the machine regularly with a dry, lint-free cloth.

When you replace the toner cartridge or the drum cartridge, make sure you clean the inside of the machine. If printed pages are stained with toner, clean the inside of the machine with a dry, lint-free cloth.

! WARNING

- When cleaning this product, use the designated cleaning materials exclusive to it. Other cleaning materials may result in poor performance of the product. Never use aerosol cleaners to avoid catching fire and explosion.



! CAUTION

- When cleaning this product, always switch off and unplug it. Access to a live machine interior may cause electric shock.

IMPORTANT

- DO NOT use isopropyl alcohol to remove dirt from the control panel. It may crack the panel.
- To avoid print quality problems, DO NOT touch the shaded parts shown in the illustrations.

Toner cartridge

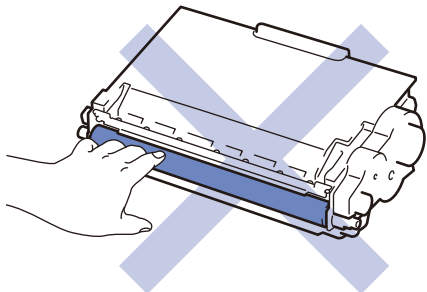

Drum cartridge

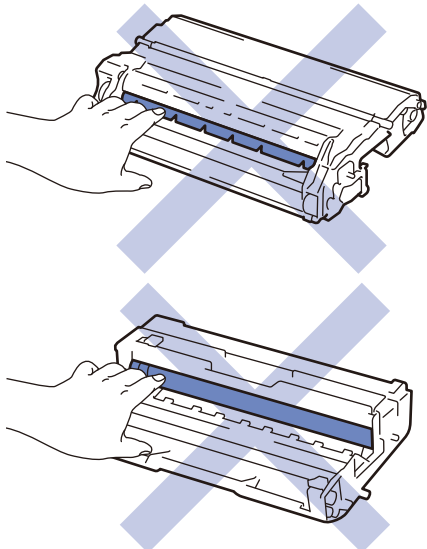



Related Information

- Routine Maintenance
 - Clean the Scanner
 - Clean the Touchscreen LCD
 - Clean the Corona Wire
 - Clean the Drum Cartridge
 - Clean the Paper Pick-up Rollers
-

Clean the Scanner

1. Press and hold  to turn the machine off.
2. Lift the document cover (1). Clean the white plastic surface (2) and scanner glass (3) underneath it with a soft lint-free cloth moistened with water.

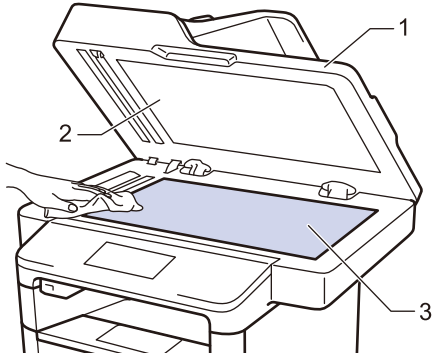

3. (DocuPrint M385 z/DocuPrint M375 z/DocuPrint M375 df) Open the scanner glass cover (1), and then clean the other white bar (2) and scanner glass strip (3).

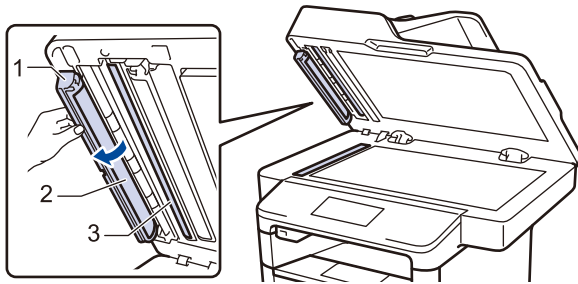

4. Close the document cover.
5. Press  to turn the machine on.



Related Information

- [Clean the Machine](#)

Related Topics

- [Other Problems](#)
- [Telephone and Fax Problems](#)

Clean the Touchscreen LCD

IMPORTANT

DO NOT use any type of liquid cleaners (including ethanol).

1. Press and hold  to turn the machine off.
2. Clean the touchscreen with a dry, soft lint-free cloth.

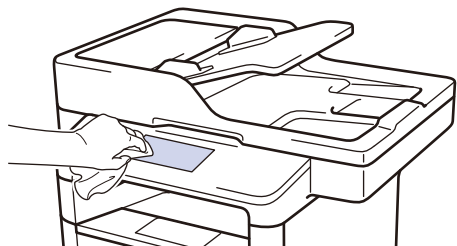

3. Press  to turn the machine on.



Related Information

- [Clean the Machine](#)

Clean the Corona Wire

If you have print quality problems or the control panel displays [Drum !] status, clean the corona wire.

1. Open the front cover.

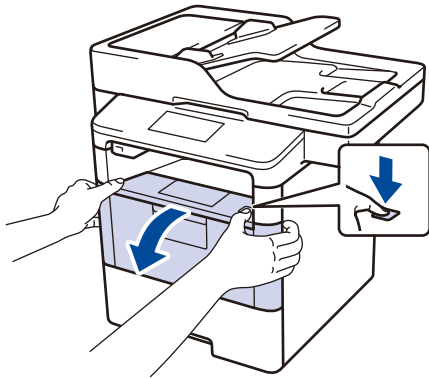

2. Remove the toner cartridge and drum cartridge assembly from the machine.

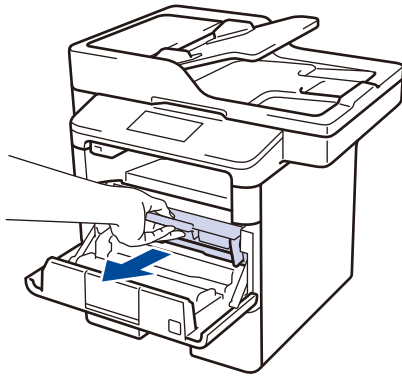

3. Clean the corona wire inside the drum cartridge by gently sliding the green tab from left to right and right to left several times.

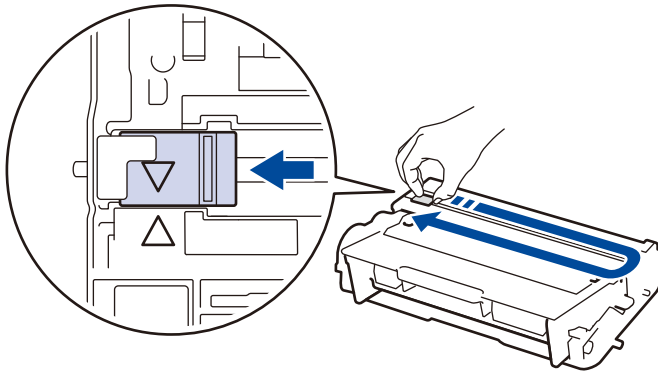

Be sure to return the tab to the Home position (▲). The arrow on the tab must be aligned with the arrow on the drum cartridge. If it is not, printed pages may have a vertical stripe.

-
4. Install the toner cartridge and drum cartridge assembly back into the machine.

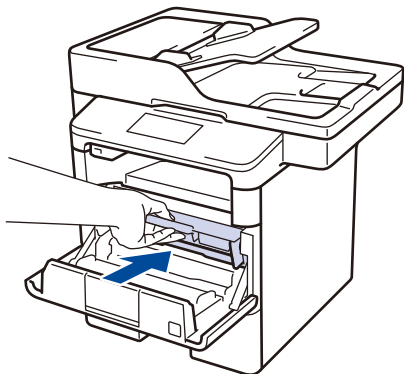

5. Close the front cover of the machine.



Related Information



- [Clean the Machine](#)

Related Topics

- [Error and Maintenance Messages](#)
-

Clean the Drum Cartridge

If your printout has dots or other repeating marks at 94 mm intervals, the drum may have foreign material, such as glue from a label, stuck on the drum surface.

1. Make sure the machine is in Ready Mode.
2. Press  [Settings] > [All Settings] > [Print Reports] > [Drum Dot Print].
3. Press [Yes].
The machine prints the Drum Dot Check Sheet.
4. Press .
5. Press and hold  to turn the machine off.
6. Open the front cover.

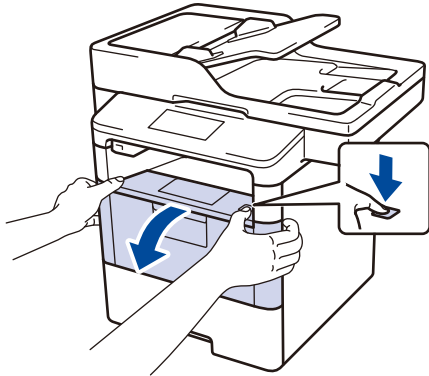

7. Remove the toner cartridge and drum cartridge assembly from the machine.

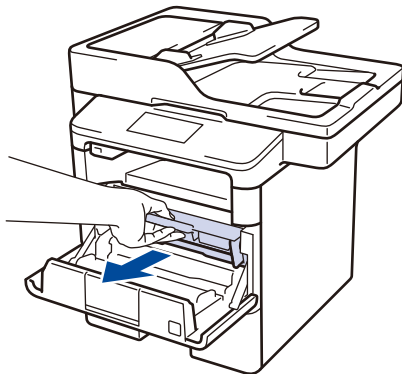

8. Push down the green lock lever and take the toner cartridge out of the drum cartridge.

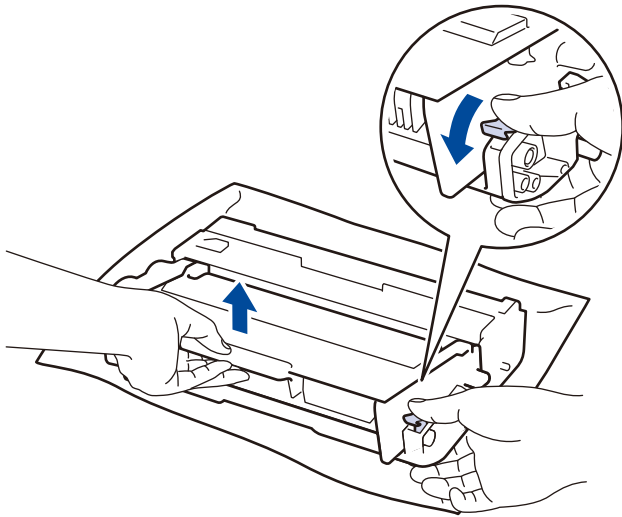

9. Turn the drum cartridge as shown in the illustration. Make sure that the drum cartridge gear is on the left side.

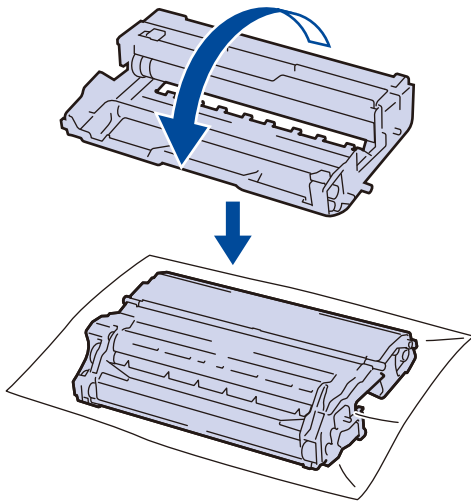

10. Use the numbered markers next to the drum roller to find the mark on the drum. For example, a dot in column 2 on the check sheet means that there is a mark in drum region "2".

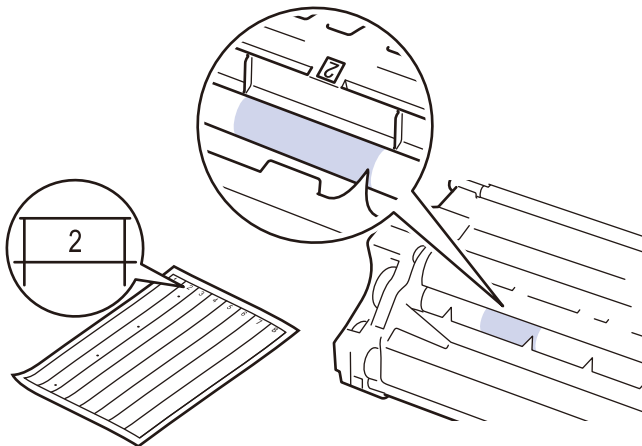

11. Turn the edge of the drum cartridge toward you while looking at the drum surface to find the mark.

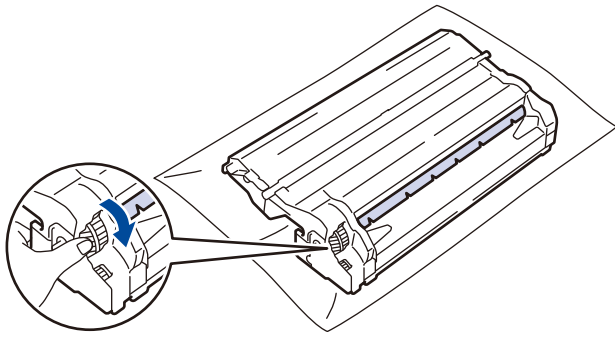

- To avoid print quality problems, DO NOT touch the surface of the drum cartridge, only the edge.
- You can turn the drum cartridge gear more easily by pulling down the black levers. When you have finished turning the gear, push the levers back to the original position.

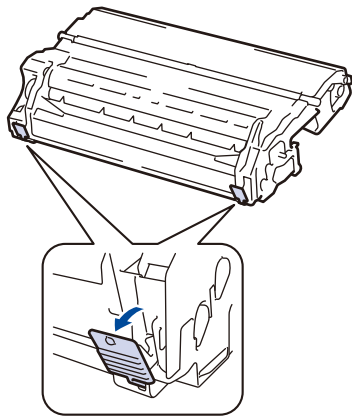

12. Wipe the surface of the drum gently with a dry cotton swab until the mark on the surface comes off.

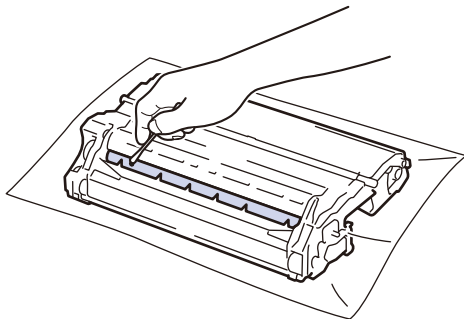

NOTE

DO NOT clean the surface of the photosensitive drum with a sharp object or any liquids.

13. Put the toner cartridge firmly into the drum cartridge until you hear it lock into place.

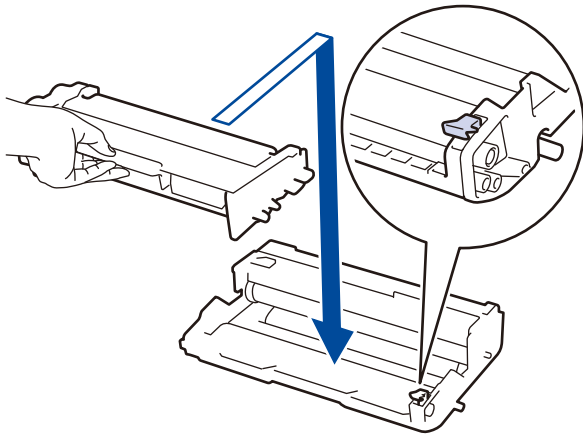

Make sure you put the toner cartridge in correctly or it may separate from the drum cartridge.

14. Install the toner cartridge and drum cartridge assembly back into the machine.

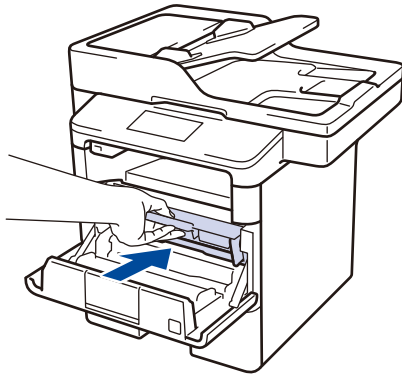

15. Close the front cover of the machine.

16. Press  to turn the machine on.



Related Information

- [Clean the Machine](#)

Related Topics

- [Improve the Print Quality](#)

Clean the Paper Pick-up Rollers

Cleaning the paper pick-up rollers periodically may prevent paper jams by ensuring that paper feeds properly.

If you have paper feed problems, clean the pick-up rollers as follows:

1. Press and hold  to turn the machine off.
2. Pull the paper tray completely out of the machine.

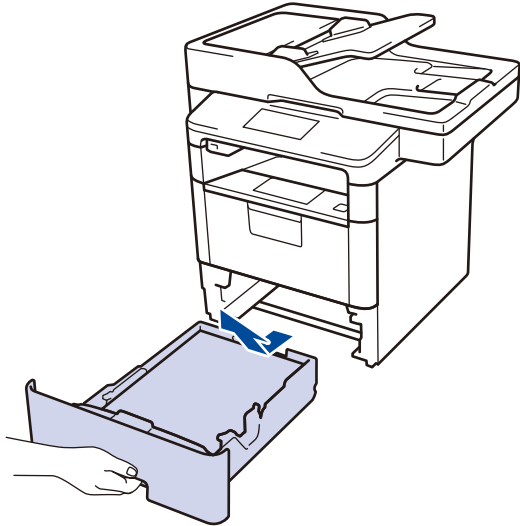

3. If paper is loaded or something is stuck inside in the paper tray, remove it.
4. Tightly wring out a lint-free cloth soaked in lukewarm water, and then wipe the separator pad on the paper tray to remove dust.

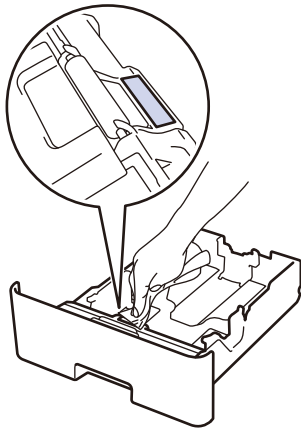

5. Wipe the two pick-up rollers inside the machine to remove dust.

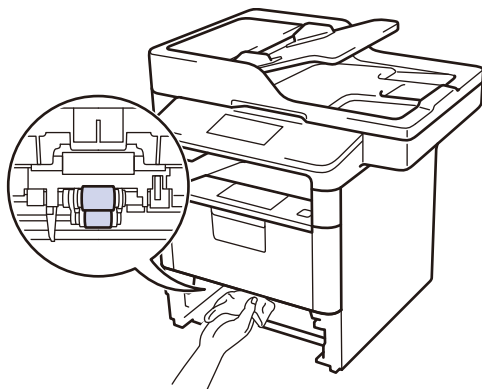

6. Reload the paper and put the paper tray firmly back in the machine.

7. Press  to turn the machine on.





Related Information

- [Clean the Machine](#)

Related Topics

- [Printing Problems](#)
-

Check the Remaining Life of Parts

1. Press  [Settings] > [All Settings] > [Machine Info.] > [Parts Life].
2. Press the machine part you want to check.
The LCD displays the approximate remaining part life.
3. Press .



To display the approximate remaining life of the toner cartridge, press  on the LCD.



Related Information

- [Routine Maintenance](#)

Replace Periodic Maintenance Parts

Replace the following parts regularly to maintain print quality. The parts listed below must be replaced after printing approximately 50,000 pages ¹ for the PF Kit MP and 200,000 pages ¹ for the PF Kit for the Paper Tray, PF Kit for the Tray Module(s) (Optional), Fusing Unit, and Laser Unit.

Contact Fuji Xerox customer service or your local Fuji Xerox dealer when the following message appears on the LCD:

LCD Message	Description
Replace Fuser ^{*1}	Replace the Fusing Unit.
Replace Laser ^{*1}	Replace the Laser Unit.
Replace PF Kit 1 ^{*1}	Replace the Paper Feeding Kit for the Paper Tray.
Replace PF Kit 2 ^{*1 *2}	Replace the Paper Feeding Kit for the Tray Module(s) (Optional).
Replace PF Kit MP ^{*1}	Replace the Paper Feeding Kit for the Multi-purpose Tray.

^{*1} Replacement frequency depends on the complexity of printed pages, percentage of coverage, and the type of media used.

^{*2} If you use the Tray Module(s) (Optional) with your machine, this message will appear on the LCD. When the machine has multiple Tray Modules (Optional), the machine displays messages using numbers corresponding to each Tray Module (Optional).



Related Information

- [Routine Maintenance](#)

¹ Letter or A4 size 1-sided pages

Machine Settings

Customise settings and features, create shortcuts, and work with options displayed on the machine's LCD to make your Fuji Xerox machine a more efficient work tool.

- [Change Machine Settings from the Control Panel](#)
- [Change Machine Settings from Your Computer](#)

Change Machine Settings from the Control Panel

- [In the Event of Power Failure \(Memory Storage\)](#)
- [General Settings](#)
- [Save Your Favourite Settings as a Shortcut](#)
- [Print Reports](#)
- [Settings and Features Tables](#)

In the Event of Power Failure (Memory Storage)

Your menu settings are stored permanently, and in the event of a power failure will not be lost. Temporary settings (for example, Contrast, Overseas Mode) will be lost.

- During a power failure, the machine will retain the date and time and programmed fax timer jobs (for example: Delayed Fax) for approximately 60 hours. Other fax jobs in the machine's memory will not be lost.





Related Information

- [Change Machine Settings from the Control Panel](#)
-

General Settings

- [Adjust the Machine's Volume](#)
- [Change for Daylight Saving Time Automatically](#)
- [Change for Daylight Saving Time](#)
- [Set Sleep Mode Countdown](#)
- [About Deep Sleep Mode](#)
- [Set Auto Power Off Mode](#)
- [Set the Date and Time](#)
- [Set the Time Zone](#)
- [Adjust the LCD Backlight Brightness](#)
- [Change How Long the LCD Backlight Stays On](#)
- [Set Your Station ID](#)
- [Set Tone or Pulse Dialling Mode](#)
- [Reduce Toner Consumption](#)
- [Add a Prefix to Every Fax Number](#)
- [Prevent Dialling a Wrong Number \(Dial Restriction\)](#)
- [Reduce Printing Noise](#)
- [Change the Language on the LCD](#)

Adjust the Machine's Volume

1. Press  [Settings] > [All Settings] > [General Setup] > [Volume].
2. Press one of the following options:
(The options will vary depending on your machine.)
 - [Ring]
Adjust the ring volume.
 - [Beep]
Adjust the volume of the beep you hear when you press a button, make a mistake, or after you send or receive a fax.
 - [Speaker]
Adjust the speaker volume.
3. Select the [Off], [Low], [Med] or [High] option, and then press the option you want.
4. Press .





Related Information

- [General Settings](#)

Change for Daylight Saving Time Automatically

You can program the machine to change automatically for Daylight Saving Time.

It will reset itself forward one hour in the spring, and backward one hour in the autumn. Make sure you have set the correct date and time in the Date & Time setting.

1. Press  [Settings] > [All Settings] > [Initial Setup] > [Date & Time] > [Auto Daylight].
2. Press [On] or [Off].
3. Press .



Related Information



- [General Settings](#)

Change for Daylight Saving Time

You can program the machine to change for Daylight Saving Time.

To forward the time by one hour or backward one hour, select the setting in accordance with the following table. Make sure you have set the correct date and time in the Date & Time setting.

Applicable Models	To Forward One Hour	To Backward One Hour
All models	Forward Hour	Backward Hour

1. Press  [Settings] > [All Settings] > [Initial Setup] > [Date & Time] > [Daylight Save].
2. Press [Forward Hour] or [Backward Hour].
3. Press .





Related Information

- [General Settings](#)

Set Sleep Mode Countdown

The Sleep Mode (or Power Save Mode) setting can reduce power consumption. When the machine is in Sleep Mode, it acts as though it is turned off. The machine will wake up and start printing when it receives a print job or a fax. Use these instructions to set a time delay (countdown) before the machine enters Sleep Mode.

- You can choose how long the machine must be idle before it goes into Sleep Mode.
- The timer will restart if any operation is carried out on the machine, such as receiving a print job.

1. Press  [Settings] > [All Settings] > [General Setup] > [Ecology] > [Sleep Time].
2. Enter the length of time (maximum 50 minutes) the machine will remain idle before entering Sleep Mode, and then press [OK].
3. Press .





Related Information

- [General Settings](#)

About Deep Sleep Mode

If the machine is in Sleep Mode and does not receive any jobs for certain length of time, the machine will automatically enter Deep Sleep Mode. The length of time is based on your specific model and settings.

Deep Sleep Mode uses less power than Sleep Mode.

Applicable Models	Machine's LCD in Deep Sleep Mode	Conditions That Will Wake the Machine
All models	The LCD backlight turns off and  blinks.	<ul style="list-style-type: none">The machine receives a job.Someone presses  or the touchscreen LCD.





Related Information

- [General Settings](#)

Set Auto Power Off Mode

If the machine is in Deep Sleep Mode for certain length of time, based on your model and settings, the machine will go into Power Off Mode automatically. The machine does not go into Power Off Mode when the machine is connected to a network or has secure print data in the memory.

- To start printing, press  on the control panel and then send a print job.



1. Press  [Settings] > [All Settings] > [General Setup] > [Ecology] > [Auto Power Off].
2. Swipe up or down or press ▲ or ▼ to display the [Off], [1hour], [2hours], [4hours] or [8hours] option, and then press the option you want.
3. Press .



Related Information

- [General Settings](#)

Set the Date and Time

1. Press  [Settings] > [All Settings] > [Initial Setup] > [Date & Time] > [Date].
2. Enter the last two digits of the year using the LCD, and then press [OK].
3. Enter the two digits for the month using the LCD, and then press [OK].
4. Enter the two digits for the day using the LCD, and then press [OK].
5. Press [Time].
6. Enter the time (in 24-hour format) using the LCD, and then press [OK].
(For example: enter 19:45 for 7:45 PM.)
7. Press .





Related Information

- [General Settings](#)

Set the Time Zone

Set the time zone for your location on the machine.

1. Press  [Settings] > [All Settings] > [Initial Setup] > [Date & Time] > [Time Zone].
2. Enter your time zone.
3. Press [OK].
4. Press .





Related Information

- [General Settings](#)

Adjust the LCD Backlight Brightness

If you are having difficulty reading the LCD, changing the brightness setting may help.

1. Press  [Settings] > [All Settings] > [General Setup] > [LCD Settings] > [Backlight].
2. Press the [Light], [Med] or [Dark] option.
3. Press .





Related Information

- [General Settings](#)
-

Change How Long the LCD Backlight Stays On

Set how long the LCD backlight stays on.

1. Press  [Settings] > [All Settings] > [General Setup] > [LCD Settings] > [Dim Timer].
2. Press the [Off], [10Secs], [20Secs] or [30Secs] option.
3. Press .



Related Information



- [General Settings](#)
-

Set Your Station ID

Set the machine to print your Station ID and the fax's date and time at the top of each fax you send.

1. Press  [Settings] > [All Settings] > [Initial Setup] > [Station ID] > [Fax].
2. Enter your fax number (up to 20 digits) using the LCD, and then press [OK].
3. Press [Tel].
4. Enter your telephone number (up to 20 digits) using the LCD, and then press [OK].
5. Press [Name].
6. Enter your name (up to 20 characters) using the LCD, and then press [OK].



- Press  to cycle between letters, numbers and special characters. (The characters available may differ depending on your country.)
- If you enter an incorrect character, press ◀ or ▶ to move the cursor to it and press . Press the correct character.
- To enter a space, press [Space] or ▶.
- For more information, see *Related Information*.

7. Press .



Related Information

- [General Settings](#)



Related Topics

- [How to Enter Text on Your Fuji Xerox Machine](#)
- [Transfer Faxes to Another Fax Machine](#)
- [Transfer the Fax Journal Report to Another Fax Machine](#)

Set Tone or Pulse Dialling Mode

Your Fuji Xerox machine is set for a Tone dialling service. If you have a Pulse dialling (rotary) service, you must change the dialling mode.

This feature is not available in some countries.

1. Press  [Settings] > [All Settings] > [Initial Setup] > [Tone/Pulse].
2. Press [Tone] or [Pulse].
3. Press .





Related Information

- [General Settings](#)

Reduce Toner Consumption

Using the Toner Save feature may reduce toner consumption. When Toner Save is set to on, the print on your documents appears lighter.

We DO NOT recommend using the Toner Save feature for printing photo or greyscale images.

1. Press  [Settings] > [All Settings] > [General Setup] > [Ecology] > [Toner Save].
2. Press [On] or [Off].
3. Press .



Related Information

- [General Settings](#)

Add a Prefix to Every Fax Number

The Dial Prefix setting will automatically dial a predefined number before every fax number you dial. For example: If your telephone system requires a 9 to dial an outside number, use this setting to automatically dial 9 for every fax you send.



- Use the numbers and symbols from 0 to 9, #, and *. (You cannot use ! with any other numbers or symbols.)
- If your telephone system requires a time break recall (hookflash), press ! on the LCD.

1. Press  [Settings] > [All Settings] > [Initial Setup] > [Dial Prefix].
2. Press [On] or [Off].

Option	Description
On	To activate the prefix number setting, select On. If you selected On, go to the next step to set a prefix number.
Off	To deactivate the prefix number setting, select Off. If you selected Off, press  to exit.

3. Press [Dial Prefix].
4. Enter a prefix number (up to five digits) using the LCD, and then press [OK].



To change the prefix number, press ◀ or ▶ to position the cursor under the digit to be deleted and press the Back Space button . Then press the correct digit.
Repeat until the prefix number is correct, and then press [OK].

5. Press .



Related Information

- [General Settings](#)

Prevent Dialling a Wrong Number (Dial Restriction)

This feature prevents users from sending a fax or call to the wrong number by mistake. You can set the machine to restrict dialling when you use the dial pad, Address Book, Shortcuts and LDAP search (Available only for certain models).

1. Press  [Settings] > [All Settings] > [Fax] > [Dial Restriction].
2. Press one of the following options:
 - [Dial Pad]
 - [Address Book]



If you combine Address Book numbers when dialling, the numbers will be recognised as dial pad input and will not be restricted.

- [Shortcuts]
 - [LDAP Server] (DocuPrint M385 z/DocuPrint M375 z)
3. Press one of the following options:

Option	Description
Enter # Twice	The machine prompts you to re-enter the number, and then if you re-enter the same number correctly, the machine will start dialling. If you re-enter the wrong number, the LCD will display an error message.
On	The machine restricts all fax sending and outbound calls for that dialling method.
Off	The machine does not restrict the dialling method.



- The [Enter # Twice] setting will not work if you use an external phone or press [Hook] before entering the number. You will not be asked to re-enter the number.
- If you choose [On] or [Enter # Twice], you cannot use the Broadcasting feature.

4. Press .





Related Information

- [General Settings](#)

Reduce Printing Noise

The Quiet Mode setting can reduce printing noise. When Quiet Mode is turned on, the print speed becomes slower. The factory setting is off.

1. Press  [Settings] > [All Settings] > [General Setup] > [Ecology] > [Quiet Mode].
2. Press [On] or [Off].
3. Press .





Related Information

- [General Settings](#)
-

Change the Language on the LCD

Change the LCD language if needed.

This feature is not available in some countries.

1. Press  [Settings] > [All Settings] > [Initial Setup] > [Local Language].
2. Press your language.
3. Press .



Related Information

- [General Settings](#)
-

Save Your Favourite Settings as a Shortcut

- [Add Shortcuts](#)
- [Change or Delete Shortcuts](#)



Add Shortcuts

You can add the Fax, Copy, or Scan settings you use most frequently by saving them as your Shortcuts. Later you can press the Shortcut to apply these settings instead of manually re-entering them.



Some Shortcut menus are not available depending on your model.

These instructions describe how to add a Copy Shortcut. The steps for adding a Fax or Scan Shortcut are very similar.

1. Press  [Shortcuts].
2. Press a tab from [1] to [8].
3. Press  where you have not added a Shortcut.
4. Press ▲ or ▼ to display [Copy], and then press [Copy].
5. Swipe up or down or press ▲ or ▼ to display the copy presets, and then press the copy preset you want.
6. Swipe up or down or press ▲ or ▼ to display the available settings, and then press the setting you want to change.
7. Swipe up or down or press ▲ or ▼ to display the available options for the setting, and then press the option you want.
Repeat these two steps until you have selected all the settings and options you want.
8. When you have finished changing settings, press [Save as Shortcut].
9. Read and confirm the displayed list of settings you have selected, and then press [OK].
10. Enter a name for the Shortcut using the LCD, and then press [OK].



Related Information

- [Save Your Favourite Settings as a Shortcut](#)

Change or Delete Shortcuts

1. Press  [Shortcuts].
2. Press a tab from [1] to [8] to display the Shortcut you want to change.
3. Press the Shortcut you want to change.
The settings for the Shortcut you selected appear.



To delete the Shortcut or edit the name, press and hold the Shortcut until the options appear, and then follow the on-screen menus.

4. Press [Options].
5. Change the settings for the Shortcut if needed.
6. Press [OK] (if needed).
7. When finished, press [Save as Shortcut].
8. Read and confirm the displayed list of settings you have selected, and then press [OK].
9. Do one of the following:
 - To overwrite the Shortcut, press [Yes].
 - If you do not want to overwrite the Shortcut, press [No] to enter a new Shortcut name. Enter a new name using the LCD, and then press [OK].



To edit the name, hold down  to delete the current name.



Related Information

- [Save Your Favourite Settings as a Shortcut](#)
-

Print Reports

- [Reports](#)
- [Print a Report](#)

Reports

The following reports are available:

Transmission

The Transmission report prints a Transmission Verification Report of your last transmission.

Address Book

The Address Book report prints an alphabetical list of names and numbers stored in the Address Book memory.

Fax Journal

The Fax Journal prints a list of information about your last 200 incoming and outgoing faxes. (TX means Transmit, RX means Receive)

User Settings

The User Settings report prints a list of your current settings.

Printer Settings

The Printer Settings report prints a list of your current printer settings.

Network Configuration(Models with network functionality)

The Network Configuration report prints a list of your current network settings.

Print File List

The Print File List prints a list of the fonts and print macros stored in the machine.

Drum Dot Print

The Drum Dot Print prints the drum dot sheet, which helps when it is time to clean the drum cartridge.

WLAN Report (Models with wireless network functionality)

The WLAN Report prints the wireless LAN connectivity diagnosis.



Related Information

- [Print Reports](#)

Print a Report

1. Press  [Settings] > [All Settings] > [Print Reports].
2. Swipe up or down or press ▲ or ▼ to display the report you want to print, and then press it.
3. Do one of the following:
 - If you choose [XMIT Verify], do one of the following:
 - To view the Transmission Verification Report, press [View on LCD].
 - To print the Transmission Verification Report, press [Print Report].
 - If you choose other reports, go to next step.
4. Press [Yes].
5. Press .



Related Information

- [Print Reports](#)

Settings and Features Tables

The Settings tables will help you understand the menu selections and options that are found in the machine's programs.

- [Settings Tables](#)
- [Features Tables](#)

Settings Tables



[Settings]

Level 1	Level 2	Descriptions
	Date & Time	Access the Date and Time setting menus.
Toner	Toner Life	View the approximate remaining toner cartridge life.
	Test Print	Print a test page.
Network	Wired LAN	Access the Wired LAN setting menus.
	WLAN (For wireless network models)	Access the WLAN setting menus.
Screen Settings	-	Access the default screen setting menus.
Wi-Fi Direct (For wireless network models)	-	Access the Wi-Fi Direct setting menus.
Fax Preview (Available only for certain models)	-	View received faxes on the LCD.
Tray Setting	-	Access the tray setting menus.
All Settings	-	Configure the detailed settings.

[All Settings] > [General Setup]

Level 1	Level 2	Level 3	Descriptions
Tray Setting	Paper Type	MP Tray	Select the paper type that matches the paper in the MP tray.
		Tray #1	Select the paper type that matches the paper in the standard paper tray.
		Tray #2 *1	Select the paper type that matches the paper in the Tray Module (Optional) (Tray 2).
		Tray #3 *1	Select the paper type that matches the paper in the Tray Module (Optional) (Tray 3).
	Paper Size	MP Tray	Select the size of paper you loaded in the MP tray.
		Tray #1	Select the size of paper you loaded in the standard paper tray.
		Tray #2 *1	Select the size of paper you loaded in the Tray Module (Optional) (Tray 2).
		Tray #3 *1	Select the size of paper you loaded in the Tray Module (Optional) (Tray 3).
	Paper Low Notice (Available only for certain models)	Paper Low Notice	Select whether to display a message telling you that the paper tray is nearly empty.
		Notice Level	Select the minimum paper level that will trigger the message.
	Paper Low Notice (Available only for certain models)	Paper Low Notice	Select whether to display a message telling you that the paper tray is nearly empty.
		Notice Level	Select the minimum paper level that will trigger the message.

Level 1	Level 2	Level 3	Descriptions
Tray Setting	Check Size	-	Select whether to display a message telling you to check that the size of the paper in the machine and the machine's Paper Size setting match.
	Tray Use: Copy	-	Select the tray to be used for Copy.
	Tray Use: Fax	-	Select the tray to be used for Fax.
	Tray Use: Print	-	Select the tray to be used for Print.
	Skip Tray * ¹	-	Select a specific tray you do not want to use; if it is loaded with paper of the wrong size.
	Separator Tray * ¹	-	Select the tray that contains the paper used as the separator paper, which is inserted between each print job.
Volume	Ring	-	Adjust the ring volume.
	Beep	-	Adjust the beeper volume.
	Speaker	-	Adjust the speaker volume.
LCD Settings	Backlight	-	Adjust the brightness of the LCD backlight.
	Dim Timer	-	Set how long the LCD backlight stays on after you go back to your Home screen.
Screen Settings	Home Screen	-	Set the default Home screen settings.
	Copy Screen	-	Set the default Copy screen settings.
	Scan Screen	-	Set the default Scan screen settings.
	Display Information	Date & Time IP Address	Set the default display information settings.
Ecology	Toner Save	-	Increase the page yield of the toner cartridge.
	Sleep Time	-	Set how much time will pass before the machine enters Power Saving Mode.
	Quiet Mode	-	Decrease printing noise.
	Auto Power Off	-	Set the number of hours that the machine will remain in Deep Sleep Mode before going into Power Off Mode.
Setting Lock	Set Password	-	Restrict unauthorised users from changing the machine's settings.
	Lock Off⇒On	-	
Interface	Fixed Port	On	Enable or disable the Fixed Port function.
		Off	
Delete Storage	Macro ID	Macro ID XX	Delete the registered Macro data.
	Font ID	Font ID XX	Delete the registered Font data.
	Format	-	Restore the Macro and Font data of your machine to the default settings.

*¹ Available if the Tray Module(s) (Optional) is installed.

[All Settings] > [Shortcut Settings]

Level 1	Level 2	Descriptions
(Select shortcut button)	Rename	Change the shortcut name.
	Edit	Change the shortcut settings.
	Delete	Delete the shortcut.

[All Settings] > [Fax]

Level 1	Level 2	Level 3	Descriptions	
Setup Receive	Receive Mode	-	Select the Receive Mode that best suits your needs.	
	Ring Delay	-	Set the number of rings before the machine answers in Fax or Fax/Tel mode.	
	F/T Ring Time	-	Set the length of the pseudo/double-ring time in Fax/Tel mode.	
	Fax Preview	-	View received faxes on the LCD.	
	Fax Detect	-	Receive fax messages automatically when you answer a call and hear fax tones.	
	Remote Codes	Remote Codes	-	Answer calls at an extension or external telephone and use codes to turn the machine on or off. You can personalise the codes.
		Act.Code		
		Deact.Code		
	Auto Reduction	-	Reduce the size of incoming faxes.	
	PC Fax Receive	On	-	Set the machine to send faxes to your computer.
		Off	-	You can turn on the Backup Print safety feature.
	Memory Receive	Off	-	-
		Fax Forward	-	Set the machine to forward fax messages or to store incoming faxes in the memory (so you can retrieve them while you are away from your machine). If you select Fax Forward, you can turn on the Backup Print safety feature.
		Fax Storage	-	Store incoming faxes in the memory.
Forward to Cloud		-	Forward incoming faxes to the online service.	
Fax Rx Stamp	-	Print the received time and date on the top of received faxes.		
2-sided	-	Print received faxes on both sides of the paper.		
Setup Send	Batch TX	-	Combine delayed faxes to the same fax number at the same time of day into one transmission.	
	Coverpage Setting	Print Sample	Print a sample of the fax cover page. You can fill in information and fax it with your document.	
		Coverpage Note	Set up your own comments for the fax cover page.	
	Auto Redial	-	Set the machine to redial the last fax number after five minutes if the fax did not go through because the line was busy.	
Destination	-	Set the machine to display the destination information on the LCD during fax dialling.		
Report Setting	XMIT Report	-	Select the initial setup for the Transmission Verification Report.	
	Journal Period	Journal Period	Set the interval for automatic printing of the Fax Journal.	
		Time	If you select an option other than Off and Every 50 Faxes, you can set the time for the option.	
	Day	If you select Every 7 Days, you can set the day of the week.		

Level 1	Level 2	Level 3	Descriptions
Print Document	-	-	Print received faxes stored in the machine's memory.
Remote Access	-	-	Set your own code for Remote Retrieval.
Dial Restriction	Dial Pad	-	Set the machine to restrict dialling when using the dial pad.
	Address Book	-	Set the machine to restrict the dialling when using the Address Book.
	Shortcuts	-	Set the machine to restrict the dialling when using a Shortcut.
	LDAP Server (DocuPrint M385 z/ DocuPrint M375 z)	-	Set the machine to restrict the dialling of LDAP server numbers.
Remaining Jobs	-	-	Check which scheduled jobs are in the machine's memory and cancel selected jobs.
Miscellaneous	Distinctive (Not available in New Zealand)	On	Turn on the telephone company's Distinctive Ring subscriber service to register your new ring pattern on the machine.
		Off	
	FaxAbility (For New Zealand)	-	If you have FaxAbility from Telecom, you can use this function to store the ringing pattern of your fax number. And if you set in to ON, you should use the registered number only.
Call Waiting (For New Zealand)	-	-	If you have Call Waiting service, you can use this function to answer second call when you are on the phone and someone rings you.

[All Settings] > [Printer]

Level 1	Level 2	Level 3	Descriptions
Emulation	-	-	Select the emulation mode.
Print Options	Internal Font	PCL emulation	Print a list of the machine's internal fonts.
		PS3 emulation	
	Test Print	-	Print a test page.
2-sided	2-sided Print	-	Enable or disable 2-sided printing and choose long edge or short edge.
	Single Image	-	For a print job where the last page is a 1-sided image, select the 1-sided Feed option to reduce printing time. When you use Letterhead or Preprinted paper, you must select the 2-sided Feed option. If you select 1-sided Feed for Letterhead or Preprinted paper, the last page will be printed on the reverse side.
Auto Continue	-	-	Select this setting if you want the machine to clear paper size errors or media type errors, and use paper from other trays.
Carbon Menu	Carbon Copy	-	Enable or disable the Carbon Copy function.
	Copies	-	Sets the number of printed pages.
	Copy1 Tray	-	Select the tray you use for Copy1.
	Copy1 Macro	-	Select a macro for Copy1.

Level 1	Level 2	Level 3	Descriptions
Carbon Menu	Copy2 Tray... Copy8 Tray	-	Select the tray you use for Copy2 to 8. The menu appears when printing two pages or more.
	Copy2 Macro... Copy8 Macro	-	Select a macro for Copy2 to 8. The menu appears when printing two pages or more.
Tray Command	-	-	Select the correct version of PCL emulation.
Reset Printer	-	-	Restore the printer settings to the factory settings.

[All Settings] > [Network]

Level 1	Level 2	Level 3	Level 4	Descriptions
Wired LAN	TCP/IP	BOOT Method	IP Boot Tries	Select the BOOT method that best suits your needs.
		IP Address	-	Enter the IP address.
		Subnet Mask	-	Enter the Subnet mask.
		Gateway	-	Enter the Gateway address.
		Node Name	-	Enter the Node name. (up to 32 characters)
		WINS Configuration	-	Select the WINS configuration mode.
		WINS Server	Primary	Specify the IP address of the primary WINS server.
			Secondary	Specify the IP address of the secondary WINS server.
		DNS Server	Primary	Specify the IP address of the primary DNS server.
			Secondary	Specify the IP address of the secondary DNS server.
	APIPA	-	Set the machine to allocate the IP address from the link-local address range automatically.	
	IPv6	-	Turn the IPv6 protocol on or off.	
	Ethernet	-	-	Select the Ethernet link mode.
	Wired Status	-	-	View the current wired status.
	MAC Address	-	-	View the machine's MAC address.
Set to Default	-	-	Restore the wired network settings to the factory settings.	
Wired Enable (For wireless network models)	-	-	Turn the Wired LAN on or off manually.	
WLAN (For wireless network models)	TCP/IP	BOOT Method	IP Boot Tries	Select the BOOT method that best suits your needs.
		IP Address	-	Enter the IP address.
		Subnet Mask	-	Enter the Subnet mask.
		Gateway	-	Enter the Gateway address.

Level 1	Level 2	Level 3	Level 4	Descriptions
WLAN (For wireless network models)	TCP/IP	Node Name	-	Enter the Node name. (up to 32 characters)
		WINS Configuration	-	Select the WINS configuration mode.
		WINS Server	Primary	Specify the IP address of the primary WINS server.
			Secondary	Specify the IP address of the secondary WINS server.
		DNS Server	Primary	Specify the IP address of the primary DNS server.
			Secondary	Specify the IP address of the secondary DNS server.
		APIPA	-	Set the machine to allocate the IP address from the link-local address range automatically.
	IPv6	-	Turn the IPv6 protocol on or off.	
	Setup Wizard	-	-	Configure the wireless network settings using the setup wizard.
	WLAN Assistant	-	-	Configure your wireless network settings using the Fuji Xerox installation disc.
	WPS	-	-	Configure your wireless network settings using the one-button push method.
	WPS w/ PIN Code	-	-	Configure your wireless network settings using WPS with a PIN.
	WLAN Status	Status	-	View the current wireless network status.
		Signal	-	View the current wireless network signal strength.
		SSID	-	View the current SSID.
		Comm. Mode	-	View the current Communication Mode.
	MAC Address	-	-	View the machine's MAC address.
Set to Default	-	-	Restore the wireless network settings to the factory settings.	
WLAN Enable	-	-	Turns the wireless interface on or off.	
Wi-Fi Direct (For wireless network models)	Push Button	-	-	Configure your Wi-Fi Direct network settings using the one-button push method.
	PIN Code	-	-	Configure your Wi-Fi Direct network settings using WPS with a PIN code.
	Manual	-	-	Configure your Wi-Fi Direct network settings manually.

Level 1	Level 2	Level 3	Level 4	Descriptions
Wi-Fi Direct (For wireless network models)	Group Owner	-	-	Set your machine as the Group Owner.
	Device Information	Device Name	-	View your machine's device name.
		SSID	-	View the Group Owner's SSID. When the machine is not connected, the LCD displays Not Connected.
		IP Address	-	View your machine's current IP Address.
	Status Information	Status	-	View the current Wi-Fi Direct network status.
		Signal	-	View the current Wi-Fi Direct network signal strength. When your machine acts as Group Owner, the LCD always indicates a strong signal.
	I/F Enable	-	-	Turn the Wi-Fi Direct connection on or off.
	E-mail/IFAX (DocuPrint M385 z/ DocuPrint M375 z)	Mail Address	-	-
Setup Server		SMTP	Server	Enter the SMTP server name and address.
			Port	Enter the SMTP port number.
			Auth. for SMTP	Select the Security method for email notification.
			SSL/TLS	Send or receive an email via an email server that requires secure SSL/TLS communication.
			Verify Cert.	Verify the SMTP Server Certificate automatically.
		POP3/IMAP4	Protocol	Select the protocol for receiving an email from the server.
			Server	Enter the server name and address.
			Port	Enter the port number.
			Mailbox Name	Enter the mailbox name. (Up to 60 characters)
			Mailbox Password	Enter the password to login to the server. (Up to 32 characters)
			Select Folder	Select the specified folder in the mailbox using the IMAP4 protocol.

Level 1	Level 2	Level 3	Level 4	Descriptions
E-mail/IFAX (DocuPrint M385 z/ DocuPrint M375 z)	Setup Server	POP3/IMAP4	SSL/TLS	Send or receive an email via an email server that requires secure SSL/TLS communication.
			Verify Cert.	Verify the SMTP Server Certificate automatically.
			APOP	Turn APOP on or off.
	Setup Mail RX	Auto Polling	Auto Polling	Check the server for new messages automatically.
			Poll Frequency	Set the interval for checking new messages on the server.
		Header	-	Select the contents of the email header to be printed.
		Del/Read Error Mail	-	The POP3 server deletes error emails automatically. The IMAP4 server deletes error emails automatically after you read them.
		Notification	-	Receive notification messages.
	Setup Mail TX	Sender Subject	-	View the subject.
		Size Limit	Size Limit	Limit the size of email documents.
			Maximum Size (MB)	
	Notification	-	Send notification messages.	
	Setup Relay	Relay Broadcast	-	Relay a document to another fax machine.
		Relay Domain	Relay XX	Register the Domain name.
		Relay Report	-	Print the relay Broadcast Report.
Manual Receive	-	-	Check the POP3 or IMAP4 server for new messages manually.	
Fax to Server (DocuPrint M385 z/ DocuPrint M375 z)	Fax to Server	-	-	Select the network connection type.
	Prefix	-	-	
	Suffix	-	-	
Security	IPsec	-	-	IPsec is an optional security feature of the IP protocol that provides authentication and encryption services. We recommend contacting your network administrator before changing this setting.
Network Reset	-	-	-	Restore all network settings back to the factory settings.

[All Settings] > [Print Reports]

Level 1	Level 2	Descriptions
XMIT Verify	View on LCD	Display a Transmission Verification Report of your last transmission.
	Print Report	Print a Transmission Verification Report of your last transmission.
Address Book	-	Print a list of names and numbers stored in the Address Book.
Fax Journal	-	Print a list of information about your last 200 incoming and outgoing faxes. (TX means Transmit. RX means Receive.)
User Settings	-	Print a list of your settings.
Printer Settings	-	Print a list of your Printer settings.
Network Configuration	-	Print a list of your Network settings.
Print File List	-	Print a list of data saved in the machine's memory.
Drum Dot Print	-	Print the Drum Dot Check Sheet.
WLAN Report (For wireless network models)	-	Print the wireless LAN connection results.
Meter Report (DocuPrint M385 z)	-	Print a list of the number of the pages the machine has printed.

[All Settings] > [Machine Info.]

Level 1	Level 2	Descriptions
Serial No.	-	Check your machine's serial number.
Firmware Version	Main Version	Check your machine's firmware version.
	Sub1 Version	
Page Counter	Total	Check the number of the pages the machine has printed.
	Fax	
	Copy	
	Print	
	Other	
Billing Information (DocuPrint M385 z)	Meter Readings	Display the number of print pages for each meter.
	Serial Number	Display the serial number of the machine.

Level 1	Level 2	Descriptions
Parts Life *1	Drum	Display the remaining life of the drum cartridge.
	Fuser	Display the remaining life of the fusing unit.
	Laser Unit	Display the remaining life of the laser unit.
	PF Kit MP	Display the remaining life of the PF kit MP.
	PF Kit 1	Display the remaining life of the PF Kit 1.
	PF Kit 2 *2	Display the remaining life of the PF Kit 2.
	PF Kit 3 *2	Display the remaining life of the PF Kit 3.

*1 Life is approximate and may vary by type of use.

*2 Available if the Tray Module(s) (Optional) is installed.

[All Settings] > [Initial Setup]

Level 1	Level 2	Descriptions
Date & Time	Date	Add the date and time on the screen and in the headings of the faxes you send.
	Time	
	Auto Daylight (For Taiwan and Australia)	Set the machine to change automatically for Daylight Saving Time.
	Time Zone	Set your time zone.
Station ID	Fax	Enter your name and fax number so it appears on each page you fax.
	Tel	
	Name	
Tone/Pulse (Not available in New Zealand)	-	Select the dialling mode.
Dial Tone	-	Shorten the dial tone detect pause.
Dial Prefix	-	Set a prefix number to always be added before the fax number every time you dial.
Compatibility	-	Adjust the equalisation for transmission difficulties. VoIP service providers offer fax support using various standards. If you regularly experience fax transmission errors, select Basic (for VoIP).
Reset	Machine Reset	Restore all the machine settings that you have changed, such as Date and Time.
	Network	Restore all network settings back to the factory settings.
	Address Book & Fax	Erase all stored phone numbers and fax settings.
	All Settings	Restore all the machine's settings back to the factory settings.
	Factory Reset	Restore all settings back to the factory settings.
Local Language (Available only for some countries)	-	Change your LCD language.



Related Information

- [Settings and Features Tables](#)
-

Features Tables

[Toner]

Level 1	Descriptions
Toner Life	View the approximate remaining toner cartridge life.
Test Print	Print a test page.

[Fax] (When Fax Preview is Off)

Level 1	Level 2	Level 3	Level 4	Descriptions
Redial(Pause)	-	-	-	Redial the last number called. When you are entering a fax or telephone number on the Touchpanel, Redial changes to Pause on the LCD. Press Pause when you need a delay while dialling numbers, such as access codes and credit card numbers. You can also store a pause when you set up addresses.
Hook	-	-	-	Press before dialling if you want to listen to make sure a fax machine has answered, and then press Fax Start.
Address Book	 (Search:)	-	-	Search within the Address Book.
	Edit	Add New Address	Name	Store Address Book numbers, set up Group numbers for Broadcasting, change and delete Address Book numbers.
			Address	
		Setup Groups	Name	
			Add/Delete	
	Change	(Select Address)		
Delete	(Select Address)			
(Select Address Book)	Apply	-	Start sending a fax using the Address Book.	
Call History	Outgoing Call	(Select Outgoing Call)	Apply	Select a number from the Outgoing Call history and then send a fax to it, add it to the Address Book, or delete it.
			Edit	
Fax Start	-	-	-	Send a fax.
Options	Fax Resolution	-	-	Set the resolution for outgoing faxes.
	2-sided Fax (For automatic 2-sided scanning models)	-	-	Set the 2-sided scanning format.
	Contrast	-	-	Adjust the contrast.

Level 1	Level 2	Level 3	Level 4	Descriptions
Options	Broadcasting	Add Number	Add Number	Send the same fax message to more than one fax number.
			Add from Address book	
			Search in Address book	
	Delayed Fax	Delayed Fax	-	Set the time of day the delayed faxes will be sent.
			Set Time	
	Real Time TX	-	-	Send a fax without using the memory.
	Coverage Setup	Coverpage Setup	-	Set the machine to automatically send a cover page that you have pre-programmed.
		Coverpage Note	-	
Total Pages		-		
Overseas Mode	-	-	Set to On if you have difficulty sending faxes overseas.	
Glass Scan Size	-	-	Adjust the scan area of the scanner glass to the size of the document.	
Set New Default	-	-	Save your settings as the default.	
Factory Reset	-	-	Restore all settings back to the factory settings.	
Save as Shortcut	-	-	-	Save the current settings as a shortcut.



[Fax] (When Fax Preview is On)

Level 1	Level 2	Level 3	Level 4	Descriptions
Sending Faxes	Redial(Pause)	-	-	Redial the last number called. When you are entering a fax or telephone number on the Touchpanel, Redial changes to Pause on the LCD. Press Pause when you need a delay while dialling numbers, such as access codes and credit card numbers. You can also store a pause when you set up addresses.
	Hook	-	-	Press before dialling if you want to listen to make sure a fax machine has answered, and then press Fax Start.
	Address Book	-	-	Select the address of the recipient from the address book.
	Call History	-	-	Select a number from the Outgoing Call history and then send a fax to it, add it to the Address Book, or delete it.
	Fax Start	-	-	Send a fax.
	Options	-	-	Select your settings.
	Save as Shortcut	-	-	Save the current settings as a shortcut.

Level 1	Level 2	Level 3	Level 4	Descriptions
Received Faxes	Print/Delete	Print All (New Faxes)	-	Print the new received faxes.
		Print All (Old Faxes)	-	Print the old received faxes.
		Delete All (New Faxes)	-	Delete the new received faxes.
		Delete All (Old Faxes)	-	Delete the old received faxes.
Address Book	-	-	-	Select the address of the recipient from the address book.
Call History	-	-	-	Select a number from the Outgoing Call history and then send a fax to it, add it to the Address Book, or delete it.



[Copy]

Level 1	Level 2	Level 3	Descriptions
Start	-	-	Make a monochrome or greyscale copy.
Quick Copy	Receipt	Start	Set the preset copy settings of Receipt.
		Quick Copy	
		Options	
	Normal	Start	Set the preset copy settings of Normal.
		Quick Copy	
		Options	
	2in1 (ID)	Start	Set the preset copy settings of 2in1(ID).
		Quick Copy	
		Options	
	2in1	Start	Set the preset copy settings of 2in1.
		Quick Copy	
		Options	
	2sided(1⇒2)	Start	Set the preset copy settings of 2-sided(1⇒2).
		Quick Copy	
		Options	
	2sided(2⇒2)	Start	Set the preset copy settings of 2-sided(2⇒2).
		Quick Copy	
		Options	
	Paper Save	Start	Set the preset copy settings of Paper Save.
		Quick Copy	
		Options	
Start	-	Start Copying.	
Options	-	Select your settings.	

Level 1	Level 2	Level 3	Descriptions
Options	Quality	-	Select the Copy resolution for your document type.
	Enlarge/Reduce	100%	-
		Enlarge	Select an enlargement ratio for the next copy.
		Reduce	Select a reduction ratio for the next copy.
		Auto	Adjusts the copy size to fit on the paper size you have set.
		Custom (25-400%)	Enter an enlargement or reduction ratio.
	Density	-	Adjust the density.
	Contrast	-	Adjust the contrast.
	Stack/Sort	-	Select to stack or sort multiple copies.
	Page Layout	-	Make N in 1 and 2 in 1 ID copies.
	2-sided Copy	Layout	Turn off or turn on 2-sided copying and select flip on long edge or flip on short edge.
	2-sided Copy Page Layout	-	Select a page layout option when you make 2-sided N in 1 copies from a 2-sided document.
	Tray Use	-	Select the tray that will be used.
Save as Shortcut	-	Save the current settings as a shortcut.	



[Scan]

Level 1	Level 2	Level 3	Descriptions
to OCR	Scan Actions (Select USB or PC)	-	Convert your scanned document to an editable text file.
		Options	
		Save as Shortcut	
		Start	
to File	Scan Actions (Select USB or PC)	-	Scan documents and save them to a folder on your computer.
		Options	
		Save as Shortcut	
		Start	
to Image	Scan Actions (Select USB or PC)	-	Scan photos or graphics into your graphics applications.
		Options	
		Save as Shortcut	
		Start	
to USB	Scan Actions	-	Scan documents to a USB Flash memory drive.
	Options	2-sided Scan (For automatic 2-sided scanning models)	
		Scan Type	
		Resolution	

Level 1	Level 2	Level 3	Descriptions
to USB	Options	File Type	Scan documents to a USB Flash memory drive.
		Document Size	
		File Name	
		File Name Style	
		File Size	
		Brightness	
		Contrast	
		ADF Auto Deskew	
		Skip Blank Page	
		Remove Background Colour	
	Set New Default		
Factory Reset			
Save as Shortcut	-		
Start	-		
to E-mail	Scan Actions	-	Send a scanned document as an email attachment.
	(Select USB or PC)	Options	
		Save as Shortcut	
		Start	
to FTP/SFTP	Scan Actions	-	Send scanned data via FTP/SFTP.
	(Select Profile name)	Options	
		Save as Shortcut	
		Start	
to Network	Scan Actions	-	Send scanned data to a CIFS server on your local network or on the Internet.
	(Select Profile name)	Options	
		Save as Shortcut	
		Start	
to SharePoint	Scan Actions	-	Send scanned data via a SharePoint® server.
	(Select Profile name)	Options	
		Save as Shortcut	
		Start	
to Web	-	-	Upload the scanned data to an Internet service.
WS Scan (Appears when you install a Web Services Scanner, which is displayed in your computer's Network explorer.)	Scan	-	Scan data using the Web Service protocol.
	Scan for E-mail	-	
	Scan for Fax	-	
	Scan for Print	-	

(Wi-Fi® Setup)

For wireless network models



After the Wi-Fi® is set up, you cannot change the settings from your Home screen. Change the settings for Wi-Fi® in the Settings screen.

Level 1	Descriptions
Setup Wizard	Configure the wireless network settings using the setup wizard.
WLAN Assistant	Configure your wireless network settings using the Fuji Xerox installation disc.
WPS	Configure your wireless network settings using the one-button push method.



[Shortcuts]

Level 1	Level 2	Level 3	Level 4	Descriptions
Add Shortcut	Copy	Receipt	-	Select the settings you want.
		Normal	-	
		2in1 (ID)	-	
		2in1	-	
		2-sided (1⇒2)	-	
		2-sided (2⇒2)	-	
		Paper Save	-	
	Fax	-	-	Select the settings you want.
	Scan	to File	(Select PC)	Scan a monochrome or a colour document to your computer.
		to OCR	(Select PC)	Convert your scanned document to an editable text file.
		to Image	(Select PC)	Scan a colour picture into your graphics application.
		to USB	Options Save as Shortcut	Scan documents to a USB Flash memory drive.
		to E-mail	(Select PC)	Scan a monochrome or a colour document into your email application.
		to Network	(Select Profile name)	Send scanned data to a CIFS server on your local network or on the Internet.
to FTP/SFTP		(Select Profile name)	Send scanned data via FTP/SFTP.	
	to SharePoint	(Select Profile name)	Send scanned data via a SharePoint® server.	
These lists appears when each Shortcut name is pressed for two seconds.	Rename	-	-	Change the shortcut name.
	Edit	-	-	Change the shortcut settings.
	Delete	-	-	Delete the shortcut.



[Secure Print]

Level 1	Level 2	Level 3	Descriptions
Secure Print	(Select User)	(Select Secure Print Job)	You can print data saved in the machine's memory when you enter your four-digit password. Active only when the machine has secure print data.



[USB]

Level 1	Level 2	Descriptions
USB	Scan to USB	Scan documents to a USB Flash memory drive.
	Direct Print	Print the data directly from the USB flash drive.



[2 in 1 ID Copy]

Level 1	Descriptions
2 in 1 ID Copy	Copy both sides of an identification card onto one page.



Related Information

- [Settings and Features Tables](#)

Change Machine Settings from Your Computer

- [Change Machine Settings Using Web Based Management](#)
- [Change the Machine Settings Using Remote Setup](#)
- [Where Can I Find My Fuji Xerox Machine's Network Settings?](#)
- [Network Management Software and Utilities](#)

Change Machine Settings Using Web Based Management

Web Based Management is a utility that uses a standard web browser to manage your machine using the Hyper Text Transfer Protocol (HTTP) or Hyper Text Transfer Protocol over Secure Socket Layer (HTTPS).

- [What is Web Based Management?](#)
- [Access Web Based Management](#)
- [Set a Login Password for Web Based Management](#)
- [Network Management Software and Utilities](#)

What is Web Based Management?

Web Based Management is a utility that uses a standard web browser to manage your machine using the Hyper Text Transfer Protocol (HTTP) or Hyper Text Transfer Protocol over Secure Socket Layer (HTTPS). Type your machine's IP address into your web browser to access and change your print server settings.



- We recommend Microsoft® Internet Explorer® 8.0/10.0/11.0 for Windows®, and Safari 8.0 for Mac. Make sure that JavaScript and Cookies are always enabled in whichever browser you use. If you use different web browser, make sure it is compatible with HTTP 1.0 and HTTP 1.1.
- You must use the TCP/IP protocol on your network and have a valid IP address programmed into the print server and your computer.

The screenshot shows the DocuPrint XXXXX web interface. At the top, there's a navigation bar with tabs: General, Address Book, Fax, Copy, Print, Scan, Administrator, and Network. The 'Status' tab is selected. On the left, there's a sidebar with a 'Status' section containing links: Auto Refresh Interval, Maintenance Information, Lists/Reports, Find Device, Contact & Location, Sleep Time, Auto Power Off, Volume, and Panel. The main content area displays the 'Status' page. It shows 'Device Status' as 'Ready' with a green progress bar. Below that, 'Automatic Refresh' is set to 'Off' (radio button selected). 'Toner Level' is shown as a vertical bar graph with 'BK' below it. 'Web Language' is set to 'Auto' with a dropdown arrow. 'Device Location' has fields for 'Contact' (with a person icon) and 'Location' (with a house icon).

- The actual screen may differ from the screen shown above.
- The following explanations are examples. The available functions vary according to the model.

General

Use this tab to confirm the current status of your Fuji Xerox machine and to change basic settings, such as the timer settings.

Address Book

Use this tab to edit your Fuji Xerox machine's address book.

Fax

Use this tab to confirm and change the fax settings and to change the Internet fax (I-Fax) settings.

Copy

Use this tab to confirm and change the copy settings.

Print

Use this tab to confirm and change the print settings.

Scan

Use this tab to confirm and change the scan settings and to create Scan to FTP and Scan to Network profiles.

Administrator

Use this tab to set the Web Based Management password, reset various settings, and configure the function settings that are mainly used by administrators. You can also use Secure Function Lock to restrict functions according to the user.

Network

Use this tab to change the network settings, enable or disable the network protocols, and configure the security and certificate settings.



Related Information

- [Change Machine Settings Using Web Based Management](#)
-

Access Web Based Management

- We recommend using the HTTPS security protocol when configuring settings using Web Based Management.
- When you use HTTPS for Web Based Management configuration, your browser will display a warning dialog box.

1. Start your web browser.
2. Type "http://machine's IP address" in your browser's address bar (where "machine's IP address" is the machine's IP address).

For example:

http://192.0.2.1



- If you are using a Domain Name System or enable a NetBIOS name, you can type another name, such as "SharedPrinter" instead of the IP address.

- For example:

http://SharedPrinter

If you enable a NetBIOS name, you can also use the node name.

- For example:

http://fxnxxxxxxxxxxxx

The NetBIOS name can be found in the Network Configuration Report.

- For Mac, access Web Based Management by clicking the machine's icon on the **Status Monitor** screen.

3. Type a password, and then click . The default password is "x-admin". To ensure security, it is important you change the password.

You can now change the print server settings.

If you change the protocol settings, you must restart the machine after clicking **Submit** to activate the configuration.



Related Information

- [Change Machine Settings Using Web Based Management](#)

Related Topics

- [Print the Network Configuration Report](#)

Set a Login Password for Web Based Management

We recommend setting a login password to prevent unauthorised access to Web Based Management.

1. Start your web browser.
2. Type "http://machine's IP address" in your browser's address bar (where "machine's IP address" is the machine's IP address).

For example:

http://192.0.2.1



- If you are using a Domain Name System or enable a NetBIOS name, you can type another name, such as "SharedPrinter" instead of the IP address.

- For example:

http://SharedPrinter

If you enable a NetBIOS name, you can also use the node name.

- For example:

http://fxnxxxxxxxxxxxx

The NetBIOS name can be found in the Network Configuration Report.

- For Mac, access Web Based Management by clicking the machine's icon on the **Status Monitor** screen.

3. Type a password, and then click . The default password is "x-admin". To ensure security, it is important you change the password.
4. Click **Administrator**.
5. Type the password you want to use in the **Enter New Password** field (7 to 32 characters).
6. Retype the password in the **Confirm New Password** field.
7. Click **Submit**.

In the future, every time you access Web Based Management, type the password in the **Login** field, and then click



After configuring the settings, log off by clicking .



If you have not previously set a login password, you can also set a password by clicking the **Please configure the password** button on the machine's web page.



Related Information

- [Change Machine Settings Using Web Based Management](#)

Change the Machine Settings Using Remote Setup

The Remote Setup program lets you configure many of your Fuji Xerox machine's settings from your computer. When you start Remote Setup, the settings on your Fuji Xerox machine will be downloaded to your computer and displayed on your screen. If you change the settings on your computer, you can upload them directly to the machine.

- [Remote Setup \(Windows®\)](#)

Remote Setup (Windows®)

- [Set Up the Fuji Xerox Machine from Your Computer \(Windows®\)](#)
- [Set Up the Fuji Xerox Machine Using ControlCenter4 \(Windows®\)](#)
- [Set Up Your Machine's Address Book Using ControlCenter4 \(Windows®\)](#)

Set Up the Fuji Xerox Machine from Your Computer (Windows®)



If Secure Function Lock is set to On, you cannot use Remote Setup.

1. Do one of the following:

- Windows® 7

Click  (**Start**) > **All Programs** > **Fuji Xerox** > **Fuji Xerox Utilities**.

Click the drop-down list and select your model name (if not already selected). Click **Tools** in the left navigation bar, and then click **Remote Setup**.

- Windows® 8 and Windows® 10

Launch  (**Fuji Xerox Utilities**), and then click the drop-down list and select your model name (if not already selected). Click **Tools** in the left navigation bar, and then click **Remote Setup**.

The Remote Setup Program window appears.



When your machine is connected via a Network, type the password if required.

2. Configure the settings as needed.

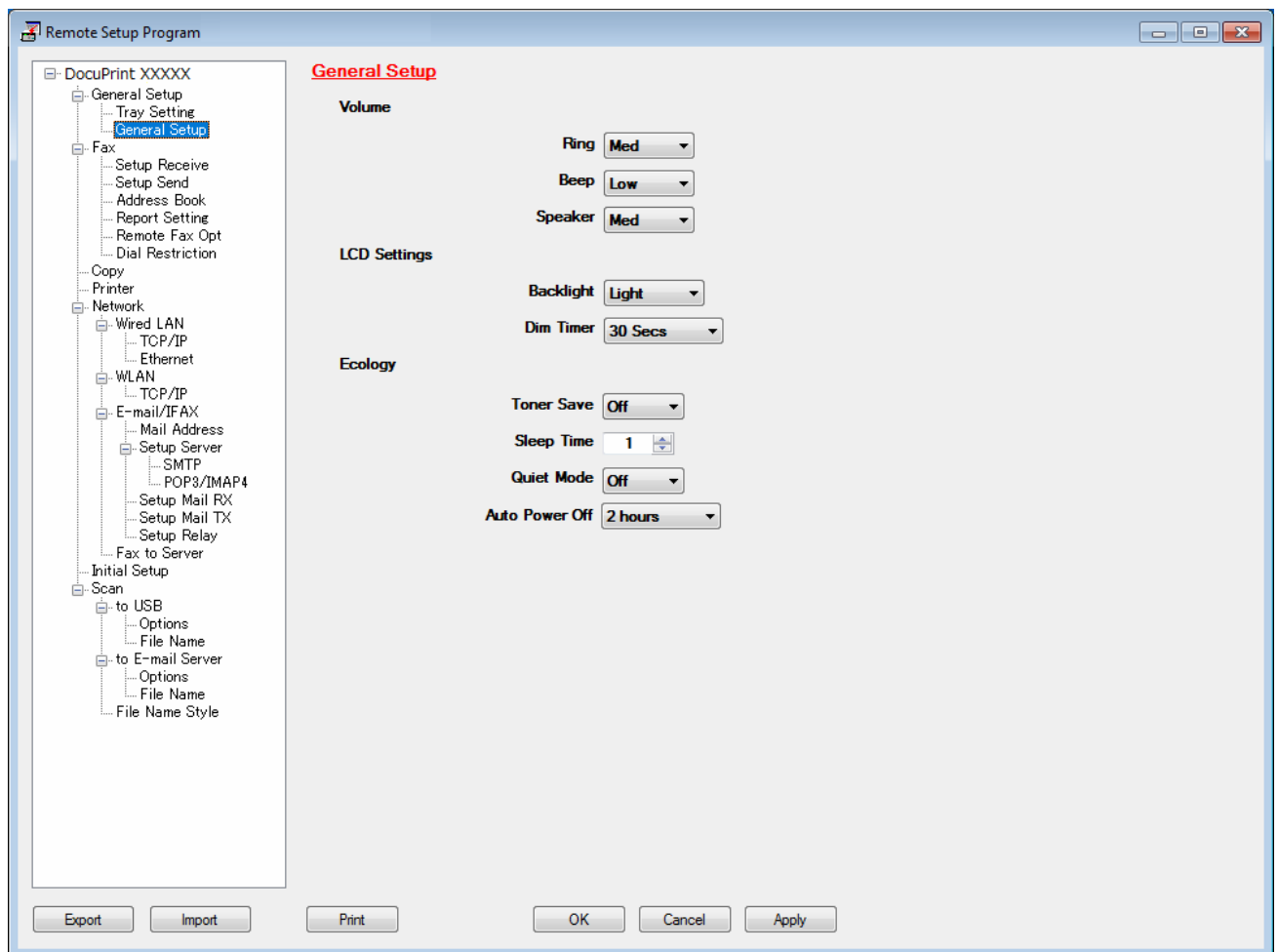

Export

Click to save the current configuration settings to a file.



Click **Export** to save your address book or all settings for your machine.

Import

Click to import a file and read its settings.

Print

Click to print the selected items on the machine. You cannot print the data until it is uploaded to the machine. Click **Apply** to upload the new data to the machine, and then click **Print**.

OK

Click to start uploading data to the machine, and then exit the Remote Setup Program. If an error message appears, confirm that your data is correct, and then click **OK**.

Cancel

Click to exit the Remote Setup Program without uploading data to the machine.

Apply

Click to upload data to the machine without exiting the Remote Setup Program.

3. Click **OK**.

- If your computer is protected by a firewall and is unable to use Remote Setup, you may need to configure the firewall settings to allow communication through port numbers 137 and 161.
- If you are using Windows® Firewall and you installed the Fuji Xerox software and drivers from the Fuji Xerox installation disc, the necessary firewall settings have already been set.



Related Information

- [Remote Setup \(Windows®\)](#)
-

Set Up the Fuji Xerox Machine Using ControlCenter4 (Windows®)



If Secure Function Lock is set to On, you cannot use Remote Setup.

1. Click the  (ControlCenter4) icon in the task tray, and then click **Open**.
2. Click the **Device Settings** tab.
3. Click the **Remote Setup** button.
4. Configure the settings as needed.

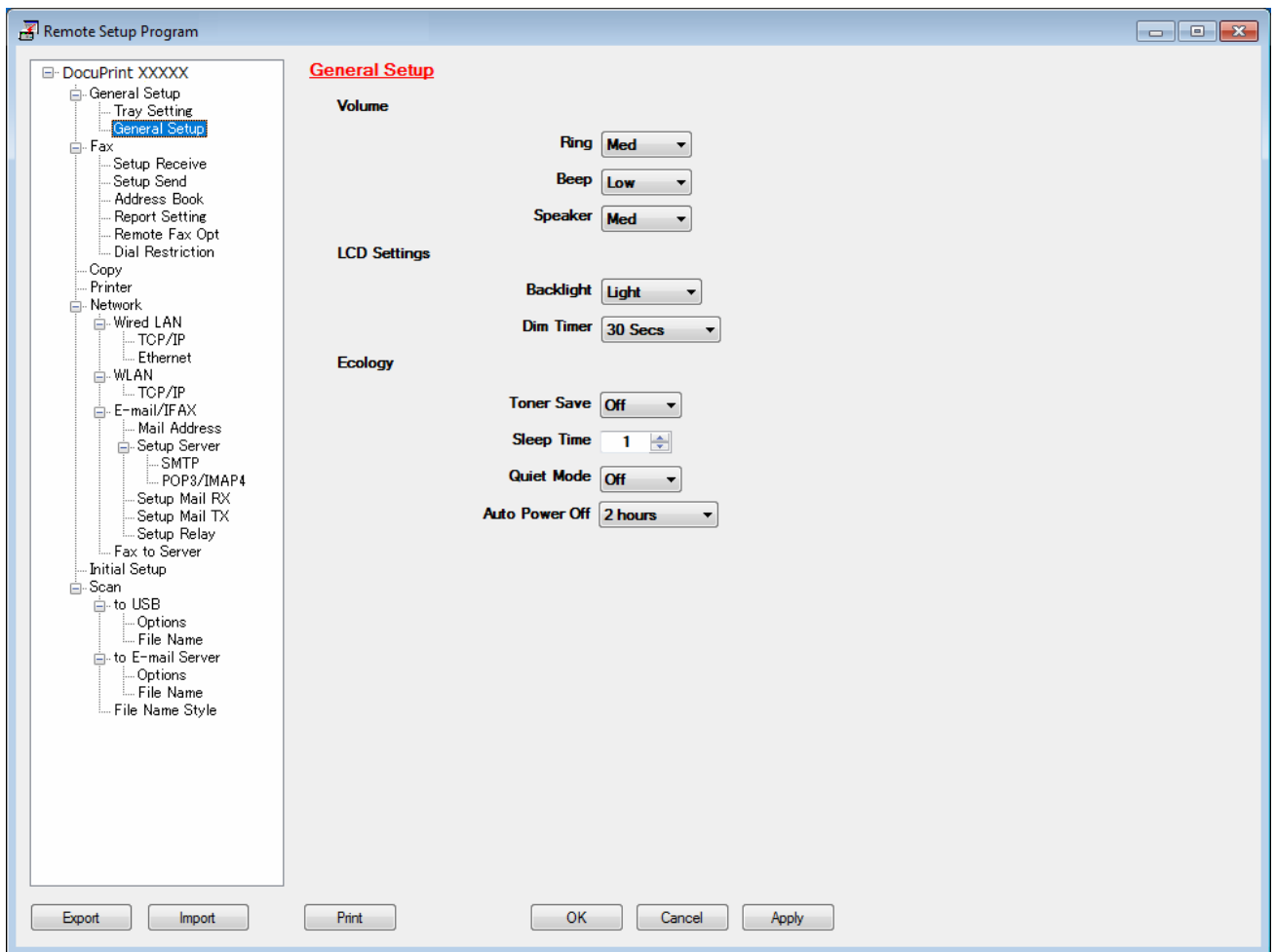

Export

Click to save the current configuration settings to a file.



Click **Export** to save your address book or all settings for your machine.

Import

Click to import a file and read its settings.

Print

Click to print the selected items on the machine. You cannot print the data until it is uploaded to the machine. Click **Apply** to upload the new data to the machine, and then click **Print**.

OK

Click to start uploading data to the machine, and then exit the Remote Setup Program. If an error message appears, confirm that your data is correct, and then click **OK**.

Cancel

Click to exit the Remote Setup Program without uploading data to the machine.

Apply

Click to upload data to the machine without exiting the Remote Setup Program.

5. Click **OK**.

- If your computer is protected by a firewall and is unable to use Remote Setup, you may need to configure the firewall settings to allow communication through port numbers 137 and 161.
- If you are using Windows® Firewall and you installed the Fuji Xerox software and drivers from the Fuji Xerox installation disc, the necessary firewall settings have already been set.

**Related Information**

- [ControlCenter4 \(Windows®\)](#)
 - [Remote Setup \(Windows®\)](#)
-

Set Up Your Machine's Address Book Using ControlCenter4 (Windows®)

Use Remote Setup through CC4 to add or change Address Book numbers on your computer.



If Secure Function Lock is set to On, you cannot use Remote Setup.

1. Click the  (**ControlCenter4**) icon in the task tray, and then click **Open**.
2. Click the **Device Settings** tab.
3. Click the **Address Book** button.
The **Address Book** opens in a Remote Setup window.
4. Add or update the Address Book information as needed.
5. Click **OK**.



Related Information

- [Remote Setup \(Windows®\)](#)

Appendix

- [Specifications](#)
- [How to Enter Text on Your Fuji Xerox Machine](#)
- [Supplies](#)
- [Accessories](#)
- [Contacting Fuji Xerox](#)
- [New Zealand FAX Modem Statements](#)

Specifications

- >> General Specifications
- >> Document Size Specification
- >> Print Media Specifications
- >> Fax Specifications
- >> Copy Specification
- >> Scanner Specifications
- >> Printer Specifications
- >> Interfaces Specifications
- >> Supported Protocols and Security Features
- >> Direct Print Feature Specifications
- >> Computer Requirements Specifications

General Specifications

Printer Type	<ul style="list-style-type: none"> • Laser
Print Method	<ul style="list-style-type: none"> • Electrophotographic Laser Printer
Memory Capacity	<ul style="list-style-type: none"> • (DocuPrint M375 df) 256 MB • (DocuPrint M375 z) 512 MB • (DocuPrint M385 z) 1 GB
LCD (liquid crystal display)	<ul style="list-style-type: none"> • (DocuPrint M375 z/DocuPrint M375 df) 3.7 in. (93.4 mm) TFT Colour Touchscreen LCD *1 • (DocuPrint M385 z) 4.85 in. (123.2 mm) TFT Colour Touchscreen LCD *1
Power Source	<ul style="list-style-type: none"> • 220 to 240 V AC 50/60Hz

Power Consumption (Average)	Peak ^{*2}	<ul style="list-style-type: none"> Approximately 1,344 W
	Printing ^{*2}	<ul style="list-style-type: none"> (DocuPrint M375 z/DocuPrint M375 df) Approximately 645 W at 25 °C (DocuPrint M385 z) Approximately 805 W at 25 °C
	Printing (Quiet Mode) ^{*2}	<ul style="list-style-type: none"> Approximately 390 W at 25 °C
	Copying ^{*2}	<ul style="list-style-type: none"> (DocuPrint M375 z/DocuPrint M375 df) Approximately 645 W at 25 °C (DocuPrint M385 z) Approximately 805 W at 25 °C
	Copying (Quiet Mode) ^{*2}	<ul style="list-style-type: none"> Approximately 390 W at 25 °C
	Ready ^{*2}	<ul style="list-style-type: none"> Approximately 34 W at 25 °C
	Deep Sleep ^{*2}	<ul style="list-style-type: none"> Approximately 1.1 W
	Power Off ^{*2 *3 *4}	<ul style="list-style-type: none"> Approximately 0.04 W
Dimensions		
		Unit: mm <ul style="list-style-type: none"> (DocuPrint M375 df) <ul style="list-style-type: none"> * 435 ** 486 *** 427 (DocuPrint M375 z) <ul style="list-style-type: none"> * 495 ** 486 *** 427 (DocuPrint M385 z) <ul style="list-style-type: none"> * 495 ** 518 *** 427
Weights (with supplies)		<ul style="list-style-type: none"> (DocuPrint M375 df) 16.6 kg (DocuPrint M375 z) 17.3 kg (DocuPrint M385 z) (For Australia and New Zealand) 18.7 kg (For Other countries) 18.8 kg

Noise Level	Sound Pressure	Printing	<ul style="list-style-type: none"> • (DocuPrint M375 df) LpAm = 52 dB (A) • (DocuPrint M375 z) LpAm = 52 dB (A) • (DocuPrint M385 z) LpAm = 53 dB (A)
		Ready	<ul style="list-style-type: none"> • LpAm = 35.0 dB (A)
		Printing (Quiet Mode)	<ul style="list-style-type: none"> • LpAm = 51 dB (A)
	Sound Power	Printing	<ul style="list-style-type: none"> • (DocuPrint M375 df) LWAd = 6.80 B (A) • (DocuPrint M375 z) LWAd = 6.80 B (A) • (DocuPrint M385 z) LWAd = 6.95 B (A)
		Ready	<ul style="list-style-type: none"> • LWAd = 4.80 B (A)
		Printing (Quiet Mode)	<ul style="list-style-type: none"> • LWAd = 6.47 B (A)
Temperature	Operating		<ul style="list-style-type: none"> • 10 to 32.5 °C
	Storage		<ul style="list-style-type: none"> • 0 to 40 °C
Humidity	Operating		<ul style="list-style-type: none"> • 20 to 80% (without condensation)
	Storage		<ul style="list-style-type: none"> • 35 to 85% (without condensation)
ADF (automatic document feeder)			<ul style="list-style-type: none"> • (DocuPrint M375 df) Up to 50 sheets • (DocuPrint M385 z/DocuPrint M375 z) Up to 70 sheets <p>For best results we recommend:</p> <ul style="list-style-type: none"> • Temperature: 20 to 30 °C • Humidity: 50 to 70% • Paper: 80 g/m²

*1 Measured diagonally

*2 USB connections to computer

*3 Measured according to IEC 62301 Edition 2.0.

*4 Power consumption varies slightly depending on the usage environment.

Document Size Specification

Document Size	ADF Width	<ul style="list-style-type: none"> • 146 to 218 mm
	ADF Length	<ul style="list-style-type: none"> • 150 to 357.6 mm
	Scanner Glass Width	<ul style="list-style-type: none"> • Maximum 215.9 mm
	Scanner Glass Length	<ul style="list-style-type: none"> • (DocuPrint M375 df) Maximum 300 mm • (DocuPrint M385 z/DocuPrint M375 z) Maximum 355.6 mm

Print Media Specifications

Paper Input	Paper Tray (Standard)	Paper Type	<ul style="list-style-type: none"> Plain Paper, Letterhead, Coloured Paper, Thin Paper, Recycled Paper, Thick Paper *1
		Paper Size	<ul style="list-style-type: none"> A4, Letter, A5, A5 (Long Edge), A6, Executive, Legal, Folio, Mexico Legal, India Legal
		Paper Weight	<ul style="list-style-type: none"> 60 to 120 g/m²
		Maximum Paper Capacity	<ul style="list-style-type: none"> (DocuPrint M375 z/DocuPrint M375 df) Up to 250 sheets of 80 g/m² Plain Paper (DocuPrint M385 z) Up to 520 sheets of 80 g/m² Plain Paper
	Multi-purpose tray (MP tray)	Paper Type	<ul style="list-style-type: none"> Plain Paper, Letterhead, Coloured Paper, Thin Paper, Thick Paper, Thicker Paper, Recycled Paper, Bond, Label, Envelope, Env.Thin, Env.Thick
		Paper Size	<ul style="list-style-type: none"> Width: 69.8 to 216 mm Length: 127 to 355.6 mm Envelope: COM-10, DL, C5, Monarch
		Paper Weight	<ul style="list-style-type: none"> 60 to 200 g/m²
		Maximum Paper Capacity	<ul style="list-style-type: none"> Up to 50 sheets of 80 g/m² Plain Paper Envelope: 10 envelopes up to 10 mm thick
	Tray Module 2, 3 (Optional) *2	Paper Type	<ul style="list-style-type: none"> Plain Paper, Letterhead, Coloured Paper, Thin Paper, Recycled Paper, Thick Paper *1
		Paper Size	<ul style="list-style-type: none"> A4, Letter, A5, Executive, Legal, Folio, Mexico Legal, India Legal
		Paper Weight	<ul style="list-style-type: none"> 60 to 120 g/m²
		Maximum Paper Capacity	<ul style="list-style-type: none"> (EL300934) Up to 250 sheets of 80 g/m² Plain Paper (EL300935) Up to 520 sheets of 80 g/m² Plain Paper
Paper Output *3	Face Down Output Tray		<ul style="list-style-type: none"> Up to 150 Sheets of 80 g/m² Plain Paper (face down delivery to the face down output paper tray)
	Face Up Output Tray		<ul style="list-style-type: none"> Up to 10 sheets (face up delivery to the face up output tray)
2-sided	Automatic 2-sided Printing	Paper Type	<ul style="list-style-type: none"> Plain Paper, Letterhead, Coloured Paper, Thin Paper, Recycled Paper
		Paper Size	<ul style="list-style-type: none"> (For models without the lever on the 2-sided tray) A4 (For models with the lever on the 2-sided tray) Select the paper size you want to use by sliding the 2-sided lever: <ul style="list-style-type: none"> - A4 - Letter, Legal, Mexico Legal, India Legal, Folio
		Paper Weight	<ul style="list-style-type: none"> 60 to 105 g/m²

*1 Open the back cover (face up output tray) before printing to let the printed paper exit onto the face up output tray.

*2 You can install up to two Tray Modules.

*3 For labels, we recommend removing the printed sheets from the output paper tray immediately after they exit the machine to avoid the possibility of smudging.

Fax Specifications

Compatibility	• ITU-T Super Group 3	
Coding System	• MH / MR / MMR / JBIG	
Modem Speed	• 33,600 bps (with Automatic Fallback)	
2-sided Print Receiving	• Yes	
Automatic 2-sided Sending	• (DocuPrint M385 z/DocuPrint M375 z) Yes (from ADF)	
Scanning Width	• Maximum 208 mm	
Printing Width	• Maximum 208 mm	
Greyscale	• 8bit / 256 levels	
Resolution	Horizontal	• 203 dpi
	Vertical	• Standard: 98 dpi • Fine: 196 dpi • Super fine: 392 dpi • Photo: 196 dpi
Address Book	• 300 Locations	
Groups	• Up to 20	
Broadcasting	• 350 Locations	
Automatic Redial	• (For Vietnam, Thailand, Cambodia and Brunei) 1 time at 5 minutes intervals • (For Other countries) 3 times at 5 minutes intervals	
Memory Transmission	• Up to 500 pages *1	
Out of Paper Reception	• Up to 500 pages *1	

*1 'Pages' refers to the 'ITU-T Test Chart #1' (a typical business letter, Standard resolution, JBIG code). Specifications and printed materials are subject to change without prior notice.

Copy Specification

Copy Width	• Maximum 210 mm
Automatic 2-sided Copy	• (DocuPrint M385 z/DocuPrint M375 z) Yes (from ADF)
Multiple Copies	• Sorts/Stacks up to 999 pages
Enlarge/Reduce	• 25 to 400% (in increments of 1%)
Resolution	• Maximum 1200 x 600 dpi
First Copy Out Time *1	• (DocuPrint M375 z/DocuPrint M375 df) Less than 9.2 seconds at 23 °C / 230 V • (DocuPrint M385 z) Less than 9.5 seconds at 23 °C / 230 V

*1 From Ready Mode and standard tray

Scanner Specifications

Colour / Black	<ul style="list-style-type: none"> • Yes / Yes
TWAIN Compliant	<ul style="list-style-type: none"> • Yes (Windows® 7 / Windows® 8 / Windows® 8.1 / Windows® 10)
Windows Image Acquisition (WIA) Compliant	<ul style="list-style-type: none"> • Yes (Windows® 7 / Windows® 8 / Windows® 8.1 / Windows® 10)
ICA Compliant	<ul style="list-style-type: none"> • Yes (macOS v10.12.x, v10.13.x, v10.14.x)
Colour Depth	<ul style="list-style-type: none"> • 48 bit colour Processing (Input) • 24 bit colour Processing (Output)
Grey Scale	<ul style="list-style-type: none"> • 16 bit colour Processing (Input) • 8 bit colour Processing (Output)
Resolution *1	<ul style="list-style-type: none"> • Up to 19200 × 19200 dpi (interpolated) • Up to 1200 x 1200 dpi (from Scanner Glass) • Up to 600 x 600 dpi (from ADF)
Scanning Width	<ul style="list-style-type: none"> • Maximum 210 mm
Automatic 2-sided Scanning	<ul style="list-style-type: none"> • (DocuPrint M385 z/DocuPrint M375 z) Yes (from ADF)

*1 Maximum 1200 × 1200 dpi scanning with the Windows Image Acquisition (WIA) driver in Windows® 7, Windows® 8, Windows® 8.1 and Windows® 10 (resolution up to 19200 × 19200 dpi can be selected by using the scanner utility)

Printer Specifications

Automatic 2-sided Print	<ul style="list-style-type: none"> • Yes 	
Emulation	<ul style="list-style-type: none"> • PCL6, PS3 emulation, PDF version 1.7, XPS (XML Paper Specification) version 1.0 	
Resolution	<ul style="list-style-type: none"> • Up to 1200 x 1200 dpi 	
Print Speed *1 *2	1-sided print	<ul style="list-style-type: none"> • (DocuPrint M375 z/DocuPrint M375 df) Up to 40 pages/minute (A4 size) • (DocuPrint M385 z) Up to 50 pages/minute (A4 size)
	2-sided Print	<ul style="list-style-type: none"> • (DocuPrint M375 z/DocuPrint M375 df) Up to 20 sides/minute (Up to 10 sheets/minute) (Letter or A4 size) • (DocuPrint M385 z) Up to 24 sides/minute (Up to 12 sheets/minute) (Letter or A4 size)
First Print Time *3	<ul style="list-style-type: none"> • (DocuPrint M375 z/DocuPrint M375 df) Less than 7.2 seconds at 23 °C / 230 V • (DocuPrint M385 z) Less than 7.5 seconds at 23 °C / 230 V 	

*1 The print speed may change depending on the type of document you print.

*2 Print speed may be slower when the machine is connected by wireless LAN.

*3 From Ready mode and standard tray

Interfaces Specifications

USB *1 *2	<ul style="list-style-type: none"> Hi-Speed USB 2.0 Use a USB 2.0 interface cable that is no more than 2.0 metres long.
LAN	<ul style="list-style-type: none"> 10Base-T / 100Base-TX /1000Base-T *3 *4
Wireless LAN	<ul style="list-style-type: none"> (DocuPrint M385 z/DocuPrint M375 z) IEEE 802.11b/g/n (Infrastructure/Ad-hoc Mode) IEEE 802.11g/n (Wi-Fi Direct™)

*1 Your machine has a USB 2.0 Hi-Speed interface. The machine can also be connected to a computer that has a USB 1.1 interface.

*2 Third party USB ports are not supported.

*3 Use a straight-through Category 5 (or greater) twisted-pair cable.

*4 If you connect the machine to a Gigabit network, use network devices and cables that comply with the 1000BASE-T specification.

Supported Protocols and Security Features

Ethernet

10Base-T/100Base-TX/1000Base-T

Wireless LAN

IEEE 802.11b/g/n (Infrastructure Mode/Ad-hoc Mode), IEEE 802.11g/n (Wi-Fi Direct)

Protocols (IPv4)

ARP, RARP, BOOTP, DHCP, APIPA(Auto IP), WINS/NetBIOS name resolution, DNS Resolver, mDNS, LLMNR responder, LPR/LPD, Custom Raw Port/Port9100, POP3, SMTP Client, IPP/IPPS, FTP Client and Server, CIFS Client, TELNET Server, SNMPv1/v2c/v3, HTTP/HTTPS server, TFTP client and server, ICMP, Web Services (Print/Scan), SNTTP Client, LDAP, IMAP4

(Supported protocols may vary depending on your models)

Protocols (IPv6)

NDP, RA, DNS resolver, mDNS, LLMNR responder, LPR/LPD, Custom Raw Port/Port9100, IPP/IPPS, POP3, SMTP Client, FTP Client and Server, CIFS Client, TELNET Server, SNMPv1/v2c/v3, HTTP/HTTPS server, TFTP client and server, ICMPv6, SNTTP Client, LDAP, Web Services (Print/Scan), IMAP4

(Supported protocols may vary depending on your models)

Network Security (Wired)

APOP, SMTP-AUTH, SSL/TLS (IPPS, HTTPS, SMTP, POP3, IMAP4), SNMP v3 802.1x (EAP-MD5, EAP-FAST, PEAP, EAP-TLS, EAP-TTLS), Kerberos, IPSec

(Supported protocols may vary depending on your models)

Network Security (Wireless)

APOP, SMTP-AUTH, SSL/TLS (IPPS, HTTPS, SMTP, POP3, IMAP4), SNMP v3, 802.1x (LEAP, EAP-FAST, PEAP, EAP-TLS, EAP-TTLS), Kerberos, IPSec

(Supported protocols may vary depending on your models)

Wireless Network Security

WEP 64/128 bit, WPA-PSK (TKIP/AES), WPA2-PSK (AES)

Wireless Certification

Wi-Fi Certification Mark License (WPA™/WPA2™ - Enterprise, Personal), Wi-Fi Protected Setup (WPS) Identifier Mark License, Wi-Fi CERTIFIED Wi-Fi Direct

Direct Print Feature Specifications

Compatibility	<ul style="list-style-type: none"> PDF version1.7, JPEG, Exif+JPEG, PRN (created by own printer driver), TIFF (scanned by Fuji Xerox models), XPS (XML Paper Specification) version 1.0
Interface	<ul style="list-style-type: none"> USB direct interface : Front x 1

Computer Requirements Specifications

Supported Operating Systems And Software Functions

Computer Platform & Operating System Version		PC Interface			Processor	Hard Disk Space to Install	
		USB *1	10Base-T / 100Base-TX / 1000Base-T (Ethernet)	Wireless 802.11b/g/n		For Drivers	For Applications (including Drivers)
Windows® Operating System	Windows® 7 *2 *3	Printing PC Fax *4 Scanning			32 bit (x86) (SP3) or 64 bit (x64)(SP2) processor	650 MB	1.2 GB
	Windows® 8 *2 *3						
	Windows® 8.1 *2 *3						
	Windows® 10 Home / 10 Pro / 10 Education / 10 Enterprise *2 *3						
	Windows Server® 2008	N/A	Printing		32 bit (x86) or 64 bit (x64) processor	50 MB	N/A
	Windows Server® 2008 R2						
	Windows Server® 2012						
	Windows Server® 2012 R2						
Windows Server® 2016							
Windows Server® 2019							
Mac Operating System	macOS v10.12.x macOS v10.13.x macOS v10.14.x	Printing PC-Fax (Send) *4 Scanning			Intel® Processor	80 MB	400 MB

*1 Third party USB ports are not supported.

*2 For Windows Image Acquisition (WIA), 1200x1200 resolution. Fuji Xerox Scanner Utility enables resolutions up to 19200 x 19200 dpi.

*3 PaperPort™ 14SE supports Windows® 7, Windows® 8, Windows® 8.1 and Windows® 10

*4 PC-Fax supports black and white only.

For the latest driver updates, go to your model's page on the Fuji Xerox website at <http://www.fujixerox.com>.



Related Information

- [Appendix](#)

How to Enter Text on Your Fuji Xerox Machine

- When you must enter text on your Fuji Xerox machine, a keyboard appears on the LCD.
- The characters that are available may differ depending on your country.
- The keyboard layout may differ depending on the operation you perform.

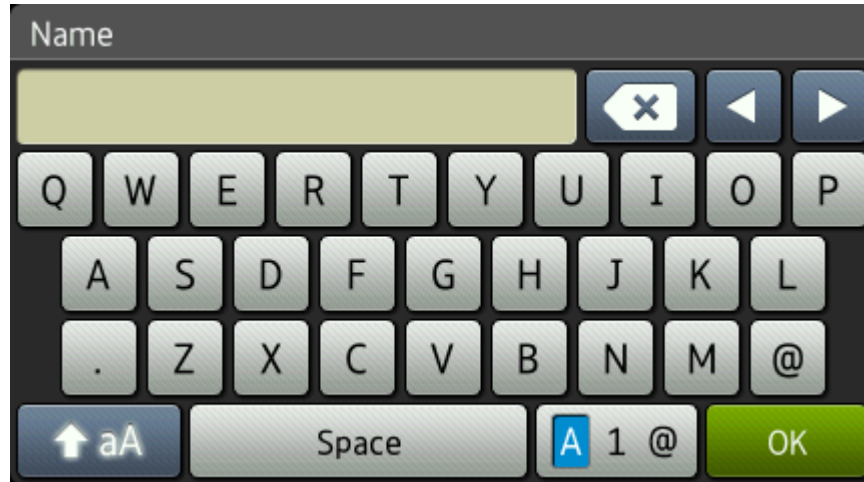

- Press to cycle between letters, numbers and special characters.
- Press to cycle between lowercase and uppercase letters.
- To move the cursor to the left or right, press or .

Inserting spaces

- To enter a space, press [Space] or .

Making corrections

- If you entered a character incorrectly and want to change it, press or to move the cursor to the incorrect character, and then press . Enter the correct character.
- To insert a character, press or to move the cursor to the correct place, and then enter the character.
- Press for each character you want to erase, or press and hold to erase all the characters.

✓ Related Information

- [Appendix](#)

Related Topics

- [Send Scanned Data to an Email Server](#)
- [Upload Scanned Data to an FTP Server](#)
- [Set Your Station ID](#)
- [Store Fax Numbers](#)
- [Configure Your Machine for a Wireless Network in Ad-Hoc Mode Using an Existing SSID](#)
- [Configure Your Machine for a Wireless Network Using the Machine's Control Panel Setup Wizard](#)
- [Configure Your Machine for a Wireless Network in Ad-Hoc Mode Using a New SSID](#)
- [Configure Your Machine for a Wireless Network When the SSID Is Not Broadcast](#)
- [Send an Internet Fax \(I-Fax\)](#)
- [Forward Received Email and Fax Messages](#)
- [Relay Broadcast from Your Fuji Xerox Machine](#)

Supplies

When the time comes to replace supplies, such as the toner cartridge or drum cartridge, an error message will appear on your machine's control panel or in the Status Monitor. Contact your local Fuji Xerox dealer.

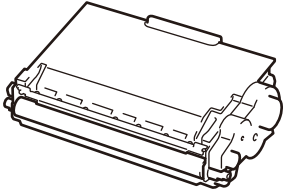
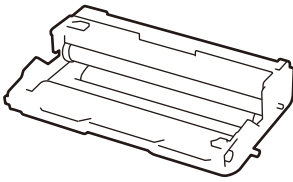

- The toner cartridge and drum cartridge are two separate parts.

Supply	Supply Model Name	Approximate Life (Page Yield)	Applicable Models
Toner Cartridge 	Standard Capacity: CT203108	Approximately 4,000 pages *1 (Letter or A4 page)	DocuPrint M375 z/ DocuPrint M375 df
	High Capacity: CT203109	Approximately 12,000 pages *1 (Letter or A4 page)	DocuPrint M385 z/ DocuPrint M375 z/ DocuPrint M375 df
	(Ultra) High Capacity: CT203371	Approximately 20,000 pages *1 (Letter or A4 page)	DocuPrint M385 z
	Starter Toner: supplied with your machine	Approximately 4,000 pages *1 (Letter or A4 page)	DocuPrint M375 z/ DocuPrint M375 df
		Approximately 8,000 pages *1 (Letter or A4 page)	DocuPrint M385 z
Drum Cartridge 	CT351174	Approximately 30,000 pages/ 50,000 pages *2	DocuPrint M385 z/ DocuPrint M375 z/ DocuPrint M375 df

*1 Approximate cartridge yield is declared in accordance with ISO/IEC 19752.

*2 Approximately 30,000 pages based on 1 page per job and 50,000 pages based on 3 pages per job [A4/letter simplex pages]. The number of pages changes depending on various paper conditions such as type and size etc.



Related Information

- [Appendix](#)

Related Topics

- [Replace Supplies](#)

Accessories

Model Name	Item
EL300934	Tray Module (250 sheets)
EL300935	Tray Module (520 sheets)



Related Information

- [Appendix](#)

Contacting Fuji Xerox

IMPORTANT

For technical help, you must call Fuji Xerox customer service or your local Fuji Xerox dealer.

>> [Technical Support](#)

>> [Online Services](#)

Technical Support

Fuji Xerox recommends the Customer first utilize support materials shipped with the product, product diagnostics, information contained on the Web, and email support. If unsuccessful, to obtain service under product warranty the Customer must notify Fuji Xerox Telephone Support or its authorized service representative of the defect before the expiration of the warranty period. Customer will provide appropriate assistance to Telephone Support personnel to resolve issues, such as restoration of the operating system, software program and drivers to their default configuration and settings, verification of functionality of Fuji Xerox supplied products, replacement of customer replaceable units, clearing paper misfeeds and cleaning the unit and other prescribed routine and preventative maintenance.

If the Customer's product contains features that enable Fuji Xerox or its authorized service representative to diagnose and repair problems with the product remotely, Fuji Xerox may request that the Customer allow such remote access to the product.

Online Services

You can find detail Product and Consumable warranty information on our website at

<http://www.fujixerox.com>

Fuji Xerox Online Support Assistant provides instructions and troubleshooting guides to resolve your printer problems. It is an easy-to-use, searchable online Help. To find out more, please visit our online support at

<http://www.fujixerox.com>



Related Information

- [Appendix](#)

New Zealand FAX Modem Statements

[>> General](#)

[>> Important Notice](#)

General

"The grant of a Telepermit for any item of terminal equipment indicates only that Telecom has accepted that the item complies with minimum conditions for connection to its network. It indicates no endorsement of the product by Telecom, nor does it provide any sort of warranty. Above all, it provides no assurance that any item will work correctly in all respects with another item of Telepermitted equipment of a different make or model, nor does it imply that any product is compatible with all of Telecom's network services."

"This equipment does not fully meet Telecom's impedance requirements. Performance limitations may occur when used in conjunction with some parts of the network. Telecom will accept no responsibility should difficulties arise in such circumstances."

"This equipment shall not be set up to make automatic calls to the Telecom '111' Emergence Service."

"If a charge for local calls is unacceptable, the 'Dial' button should NOT be used for local calls. Only the 7-digits of the local number should be dialed from your telephone. DO NOT dial the area code digit or the '0' prefix."

"This equipment may not provide for the effective hand-over of a call to another equipment connected to the same line."

Important Notice

"Under power failure conditions, this telephone may not operate. Please ensure that a separate telephone, not dependent on local power, is available for emergency use."

"Some parameters required for compliance with Telecom's Telepermit requirements are dependent on the equipment (PC) associated with this equipment. The associated equipment shall be set to operate within the following limits for compliance with Telecom's Specification:

There shall be no more than 10 call attempts to the same number within any 30-minute period for any single manual call initiation, and the equipment shall go on-hook for a period of not less than 30 seconds between the end of one attempt and the beginning of the next attempt.

Where automatic calls are made to different numbers, the equipment shall go on-line for a period of not less than 5 seconds between the end of one attempt and the beginning of the next attempt.

The equipment shall be set to ensure that calls are answered between 3 and 30 seconds of receipt of ringing."

"All persons using this equipment for recording telephone conversations shall comply with New Zealand law. This requires that at least one party to the conversation is to be aware that it is being recorded. In addition, the Principles enumerated in the Privacy Act of 1993 shall be complied with in respect to the nature of the personal information collected, the purpose for its collection, how it is used and what is disclosed to any other party."



Related Information

- [Appendix](#)

DocuPrint M385 z/DocuPrint M375 z/DocuPrint M375 df
User Guide

ME8541E2-5 (Edition 1)
September 2020

Free Manuals Download Website

<http://myh66.com>

<http://usermanuals.us>

<http://www.somanuals.com>

<http://www.4manuals.cc>

<http://www.manual-lib.com>

<http://www.404manual.com>

<http://www.luxmanual.com>

<http://aubethermostatmanual.com>

Golf course search by state

<http://golfingnear.com>

Email search by domain

<http://emailbydomain.com>

Auto manuals search

<http://auto.somanuals.com>

TV manuals search

<http://tv.somanuals.com>