

AGES 8+

13744

LAZER TAG®

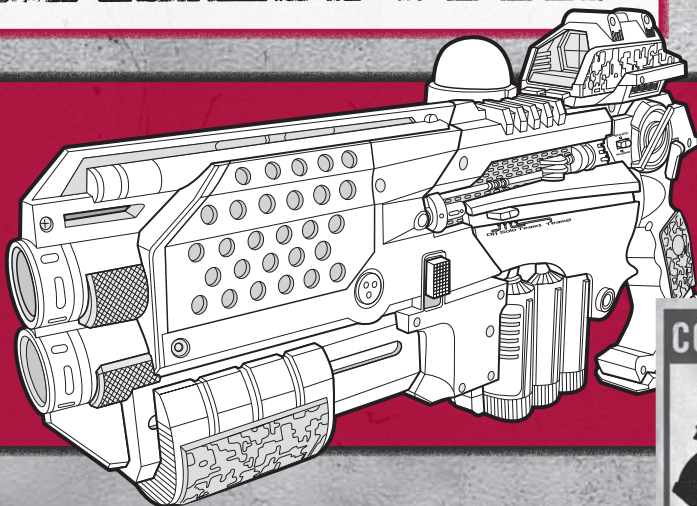

CONTAINS 2 EACH



FEATURES

- VIDEO GAME MODULE ■
- RECOIL HAMMER ■
- RUMBLE PACK ■

POWERED BY

POWER FUEL

X12 | BATTERIES INCLUDED

Replace with 12 x 1.5V "AA" or R6 size alkaline batteries.
Phillips/cross head screwdriver (not included) needed to
replace batteries.

**STANDARD, CRT TV ONLY. NOT FOR USE WITH PROJECTION, LCD,
HIGH-DEFINITION, OR PLASMA TV.**

Replacing the batteries:

1. Using a Phillips/cross head screwdriver (not included), unscrew the battery covers on your Tagger units.
2. Insert 6 fresh 1.5 V "AA" or R6 size batteries (not included) in each Tagger unit. Alkaline batteries recommended. See diagram for polarity.
3. Replace battery covers and tighten screws.

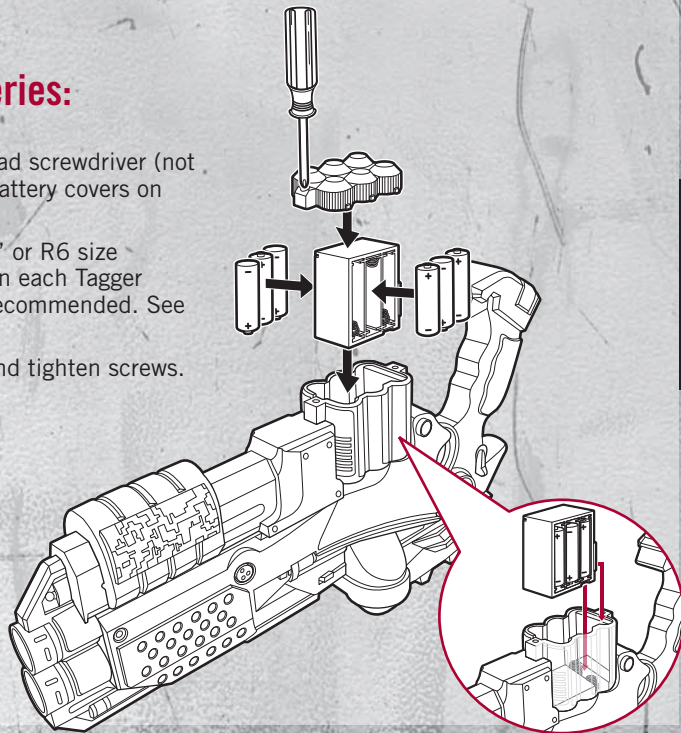



CAUTION: TO AVOID BATTERY LEAKAGE

1. Be sure to insert the batteries correctly and always follow the toy and battery manufacturers' instructions;
2. Do not mix old and new batteries or alkaline, standard (carbon-zinc) or rechargeable (nickel-cadmium) batteries;
3. Always remove weak or dead batteries from the product.

IMPORTANT: BATTERY INFORMATION

Please retain this information for future reference.

Batteries should be replaced by an adult.



CAUTION:

1. Always follow the instructions carefully. Use only batteries specified and be sure to insert item correctly by matching the + and - polarity markings.
2. Do not mix old and new batteries or standard (carbon-zinc) with alkaline batteries.
3. Remove exhausted or dead batteries from the product.
4. Remove batteries if product is not to be played with for a long time.
5. Do not short-circuit the supply terminals.
6. Should this product cause, or be affected by, local electrical interference, move it away from other electrical equipment. Reset (switching off and back on again or removing and reinserting batteries) if necessary.
7. **RECHARGEABLE BATTERIES:** Do not mix these with any other types of batteries. Always remove from the product before recharging. Recharge batteries under adult supervision. **DO NOT RECHARGE OTHER TYPES OF BATTERIES.**

THE PARTS OF YOUR TAGGER

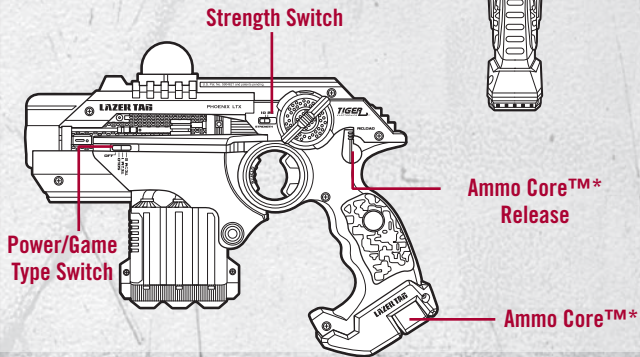
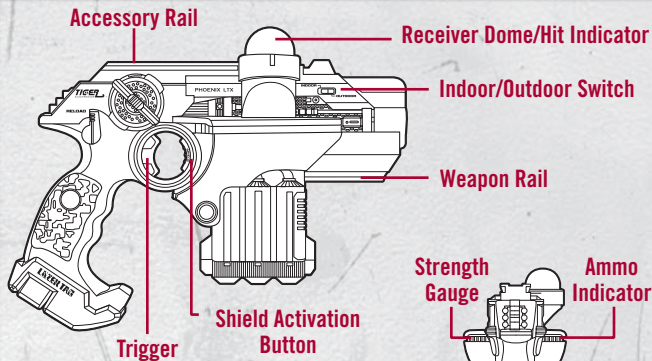

VIDEO GAME MODULE

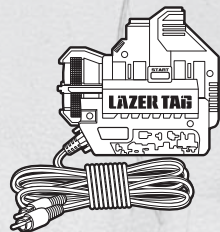

PINPOINT SIGHT



SHOT BLAST™* Attachment

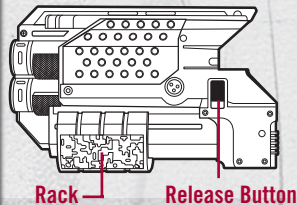

BEFORE YOU TURN ON YOUR TAGGER

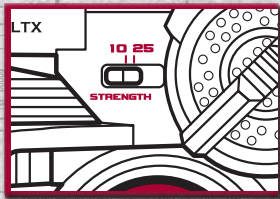

1. All players should agree on Strength scores for the game, and set the **Strength Switch** to either 10 or 25. You can't change your Strength score once the game begins!
 - **10 Strength** means you can be tagged 10 times before you are out of the game.
 - **25 Strength** means you can be tagged 25 times before you are out of the game. Your **Strength Gauge** will stay filled until you are on your last 10 Strength points.
2. Set the **Indoor/Outdoor Switch** to the proper position based on where you are.
3. Decide what game type to play – **Solo** or **Team**.
 - **Solo Game** means that all players are on their own. The last player with any Strength Points left wins!
 - **Team Game** means that players organize themselves into two teams that battle against each other. You can't tag someone on your own team. There are many different team games you can play – make up your own, or check out lazertag.com for team game rules!

PLAYING A GAME

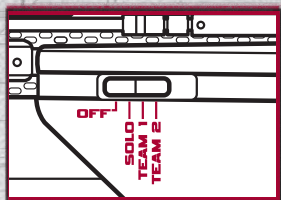

Note: You have ten rounds of Ammo after each reload. When you fire one round, one of the lights on your Ammo Indicator will blink. When you fire the second, the blinking light will go out.

1. Switch your Tagger to **Solo**, **Team 1** or **Team 2**.
2. When all players have set their Taggers to the right game type, point your Tagger in the air and pull the **Trigger**. This will activate a 10-second countdown, after which the game begins!
3. To tag another Player, point your Tagger at him and pull the **Trigger**. This will use one round of Ammo.
4. When all of the lights on the **Ammo Indicator** are out, you need to reload. Press the **Ammo Core™* Release** to pop out the **Ammo Core™***. Now, push the Power Core back in. You are reloaded and ready to continue tagging!
5. When you are tagged, your Tagger will rumble, and one (or more, depending on the Weapon Accessory you're using) of your Strength points will be lost. When all of the lights on your **Strength Gauge** go out, you are out of the game (your Tagger will warn you when your Strength is down to dangerous levels).
6. The last player (or players on the same team in a team game) with Strength points left wins!

The PHOENIX LTX™* Tagger is compatible with all LAZER TAG Team Ops gear from TIGER ELECTRONICS™* and HASBRO®*. See LAZER TAG.com for more details.

USING THE SHIELDS

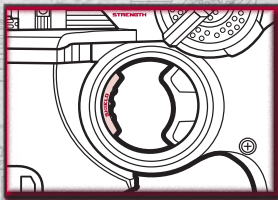

When your shield is active, you cannot be tagged, but you also can't tag anyone.

1. To activate your Shields, press and hold the **Shield Activation Button**.
2. The shield will stay on for up to 10 seconds. You will hear it power up and hum. While your shield is up, you cannot tag or be tagged.
3. After you release the **Shield Activation Button**, you will hear your shield power down. You are now vulnerable to tags, and can tag other players.
4. You must wait 2 seconds before activating your shields again.
5. You only have a few seconds of shield charge per game, so use them wisely!

You get 15 seconds of Shields during a 10 Strength game.

You get 30 seconds of Shields during a 25 Strength game.

USING THE SHOT BLAST™* WEAPON ACCESSORY

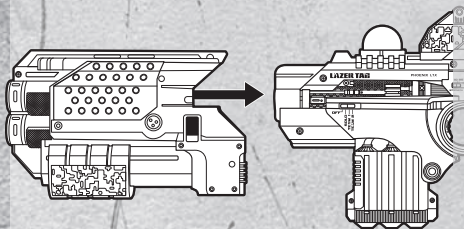

Note: Tags fired by the SHOT BLAST accessory have a shorter range than regular tags, but affect a wider area. If you catch several opponents standing close to one another, you can actually hit all of them at once!

1. Slide the SHOT BLAST accessory onto the front of the Tagger until it snaps into place.
2. To arm the SHOT BLAST, slide the **Rack** toward you, and then forward again.
3. When you pull the trigger, your Tagger will fire an extra-powerful blast. Depending on how accurate your shot is, you could take as many as three points off your target's **Strength Gauge**.
4. You will need to **Rack** the SHOT BLAST again before you can fire it.
5. If you pull the **Trigger** without using the Rack, you will fire a single, regular Tagger shot.
6. To remove the SHOT BLAST, slide the **Release Button** down and pull it off the Tagger.

USING THE PINPOINT SIGHT

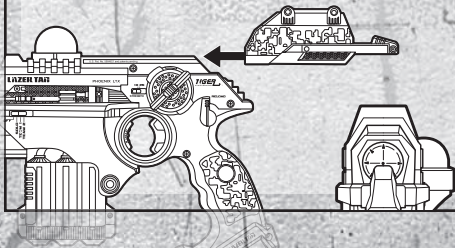

1. Slide the PINPOINT SIGHT onto the accessory rail on the top of your Tagger until it locks into place.
2. Look into the PINPOINT SIGHT. If it is properly attached, you will see a green dot reflected on the crosshairs.
3. Line up the green dot in the center of the crosshairs with your target for pinpoint accuracy!

USING THE VIDEO GAME MODULE

Plug it in, and experience intense, single-player Lazer Tag action on your television!

REQUIREMENTS

TV with AV input OR VCR or DVD player with AV input attached to your TV.

- RF Adapter (not included) required if your TV does not have an AV input.
- **STANDARD, CRT TV ONLY. NOT FOR USE WITH PROJECTION, LCD, HIGH-DEFINITION, OR PLASMA TV.**
- You cannot play this game through a cable box or satellite hookup. Game must be connected directly to the TV, VCR, or DVD player.
- If the game malfunctions or freezes, you can reset it by turning your Tagger off and then on again.

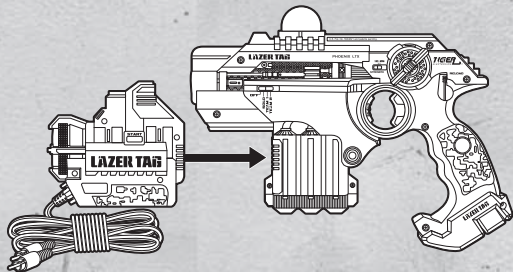

ASSEMBLY

Slide the Video Game Module onto the accessory rail on the front of your Tagger, until it locks into place.

To remove it, slide the **Release Button** down and pull the Module off the Tagger.

Note: Do not use the **PINPOINT SIGHT** with the Video Game Module.

SETUP

Insert the cable plugs into the AV inputs on your TV, VCR or DVD player.

Connecting to a TV:

1. Insert the cable's white plug into the white audio-in jack on the TV.
2. Insert the cable's yellow plug into the yellow video-in jack on the TV.

Note: these jacks are normally found on the front of the TV near the adjustment controls, or on the back of the TV near the antenna and cable connections

3. Turn on your TV, and set it to the channel/video input mode directed by your TV owner's manual.

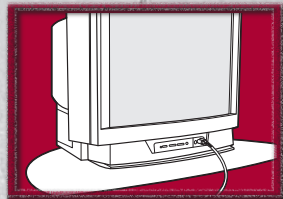

Connecting to a VCR or DVD player:

1. Make sure the VCR or DVD player is properly connected to the TV.
2. Insert the cable's white plug into the white audio-in jack on the VCR or DVD player.
3. Insert the cable's yellow plug into the yellow video-in jack on the VCR or DVD player.
4. Turn on your TV and VCR or DVD player.
5. Set your TV, VCR or DVD player to the channel/video input mode directed by your TV, VCR or DVD player owner's manual.

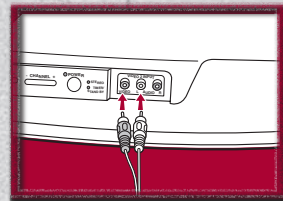

VIDEO GAME MODULE BUTTONS & CONTROLS

Left & Right Scroll Buttons – Scroll through menu options. Dodge incoming tags. Launch Grenades while holding down SHIELD Button.

Start Button – Start/Pause game

Release Button

TAGGER BUTTONS & CONTROLS

Some of the features of your Tagger will be disabled during video game play, and are not listed.

Power/Game Type Switch – Set to “Solo” for video game play

Shield Activation Button – Activates Shields in game; switches between menu options.

Trigger – Fire/Select

Ammo Core™* Release – Press forward to pop out the Ammo Core

Ammo Core™* – Pop out and push back in to reload

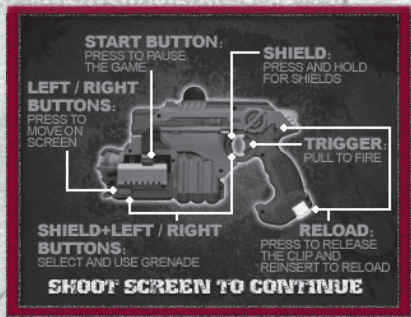

HOW TO PLAY

Object of the game: Defeat your opponents and take command of the environment in which you are battling. Gain points by defeating opponents in order to unlock new weapons, environments, and game types.

1. Slide the **Power/Game Type Switch** to Solo.
2. After a brief introduction, either pull the **Trigger** to begin play as directed on the screen. The Main Menu will appear. Make menu selections by scrolling through the options using the **L and R Buttons** on the Video Game Module. Pull the Trigger to select the game type of your choice. Press the Shield Button to switch between menus.
3. The first thing you should do is create a player, so that you can save your game and unlock weapons and environments. Select this option from the menu and follow the on-screen directions. You can create up to 5 different players.
4. Once a Player is created, you're ready to play a game! There are three game types:

Single Game – Play a single round in an environment randomly chosen from the environments you have unlocked.

Tournament – Play a full Tournament. Battle your way through all five environments. Environments and new weapons will unlock as you play, and become available to you in the Single Game type. Tournament is locked when you first play the game.

Target Practice – Hone your skills with Target Practice. Targets will randomly pop up on screen for you to tag. Difficulty increases as you play.

4. Once you select a game, you will enter the first environment. Target your opponents and tag them by pulling the **Trigger**. You can also collect the power-ups scattered throughout each environment by tagging them.

5. When you are hit, you will notice the **Strength Gauge** on your Tagger decreasing.
6. You score points when you defeat opponents. As you score points, more weapons and environments will unlock.
7. A game or an environment ends when you tag all of the opponents, or you run out of Strength Points.

Notes: For best performance, stand 3-4 feet away from your television while playing. Always be sure to keep some slack in the cable, to avoid damaging your Tagger or television. The Tagger and game will shut down if no buttons are pressed for about four minutes.

THE GAME SCREEN

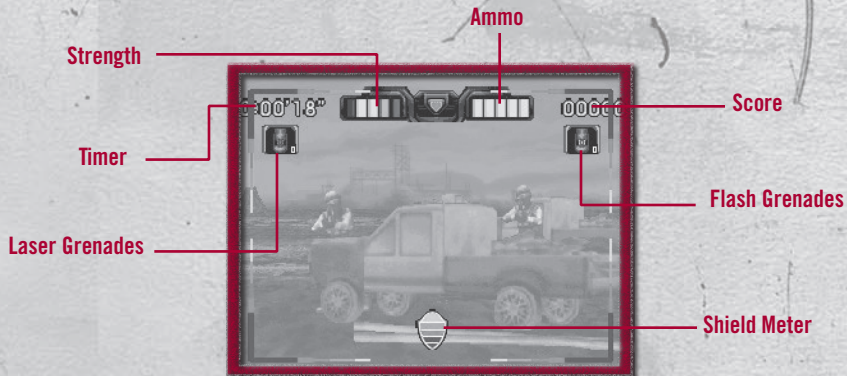

BATTLE ACTIONS

Fire your Tagger – To fire your Tagger, aim it at an opponent on-screen (using the crosshairs to aim), and pull the **Trigger**.

Dodge – Dodge incoming fire by pressing the **R** or **L** buttons.

Launch a Grenade – Aim at a target onscreen using the crosshairs, and press the **Shield Button** at the same time as either the **R Button** (flash grenade, stuns enemies), or the **L Button** (EM grenade, damages enemies).

Activate Shields – Shields work exactly as described above in USING THE SHIELDS.

Reload – When your **Ammo Indicator** is empty, you need to reload. This works exactly as described above in PLAY A GAME. You can also set the game to Reload your Tagger automatically from the Pause Menu.

Pause – Press the **Start Button** to pause your game. From here, you can exit your game, or switch weapons.

Switch Weapons – Pause the game, and use the **R** and **L Buttons** to scroll to the Switch Weapons option. Pull the **Trigger** to select. Scroll through your unlocked weapon options until you get to the one you want. Pull the **Trigger** again to arm that weapon.

WEAPON TYPES

Standard Tagger – This weapon is the one you start with. Every pull of the Trigger fires one round of ammunition. After 10 shots, you will need to reload.

SHOTBLAST™* - Can drain up to 3 points of Strength from your target. Can also hit multiple targets that are clustered close together. You must reload every 3 shots.

Auto Assault – Press and hold the Trigger for continuous fire, for up to ten seconds. Reload after 10 bursts.

Burner – Press and hold the Trigger for continuous fire that hits a wider area than the Auto Assault. Reload after 10 bursts.



FCC STATEMENT

This device complies with part 15 of the FCC Rules. Operation is subject to the following two conditions: (1) This device may not cause harmful interference, and (2) this device must accept any interference received, including interference that may cause undesired operation.

This equipment has been tested and found to comply with the limits for a Class B digital device, pursuant to part 15 of the FCC Rules. These limits are designed to provide reasonable protection against harmful interference in a residential installation. This equipment generates, uses and can radiate radio frequency energy, and, if not installed and used in accordance with the instructions, may cause harmful interference to radio communications. However, there is no guarantee that interference will not occur in a particular installation. If this equipment does cause harmful interference to radio or television reception, which can be determined by turning the equipment off and on, the user is encouraged to try to correct the interference by one or more of the following measures:

- Reorient or relocate the receiving antenna.
- Increase the separation between the equipment and receiver.
- Consult the dealer or an experienced radio/TV technician for help.

CAUTION: Changes or modifications not expressly approved by the party responsible for compliance could void the user's authority to operate the equipment.



TIGER
ELECTRONICS

LAZER TAG is a registered trademark of Shoot the Moon Products and is used with permission.

®* and/or TM* and © 2008 Hasbro. All Rights Reserved.
TM & ® denote U.S. Trademarks.
U.S. Patent No. 5904621 & patents pending.
PN 6841540000



for game types, detailed instructions, new products and more!

Questions? Call 1-800-844-3733

Free Manuals Download Website

<http://myh66.com>

<http://usermanuals.us>

<http://www.somanuals.com>

<http://www.4manuals.cc>

<http://www.manual-lib.com>

<http://www.404manual.com>

<http://www.luxmanual.com>

<http://aubethermostatmanual.com>

Golf course search by state

<http://golfingnear.com>

Email search by domain

<http://emailbydomain.com>

Auto manuals search

<http://auto.somanuals.com>

TV manuals search

<http://tv.somanuals.com>