

AGES 5+
20251



WARNING:

CHOKING HAZARD- Small parts.
Not for children under 3 years.

Lite Brite®
FX

**Thank you for choosing this
LITE BRITE product!**

**Batteries included. Replace
with 4 x 1.5V "C" or LR14 size
alkaline batteries. Phillips/cross
head screwdriver (not included)
needed to replace batteries.**

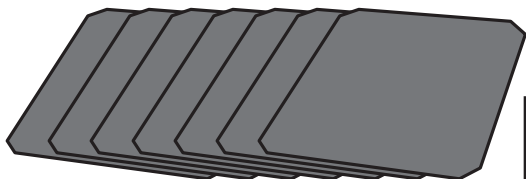
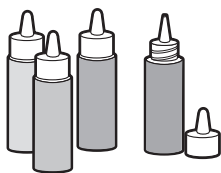

**Includes paint spinner,
4 bottles of paint and
7 design cards**

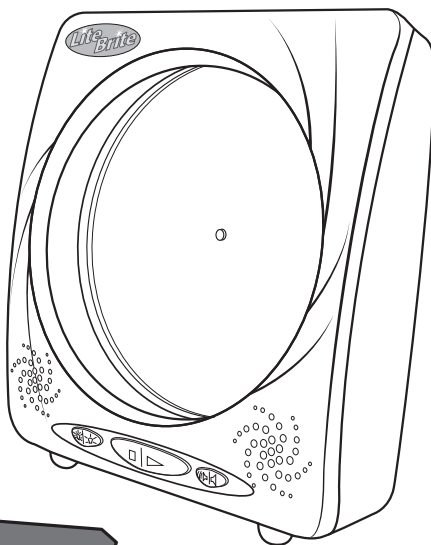

**FLASH
ART™**
NEON PAINT SPINNER



**Note that paint may stain
some surfaces. Wash with
soap and warm water.**

NOTE: To take the FLASH ART Neon Paint Spinner out of demo mode, press either the  or  buttons while the spinner is on (you will need to do this within the first 6 seconds the spinner is on). Each time you replace the batteries, you will need to repeat this step.

BASICS

There are all kinds of amazing designs you can make with the FLASH ART Neon Paint Spinner toy! Here are a few basics you'll need to follow before you begin to create:

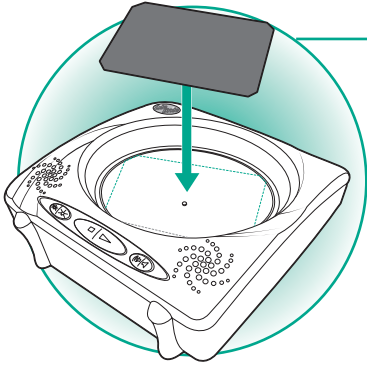

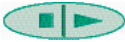

1. Secure a design card onto the spinner platform as shown. Make sure all four corners are in place.
2. Press the  button once to start the spinning action! You'll want to turn off the lights in your room to get the full glowing effect! (first time playing: SEE NOTE)

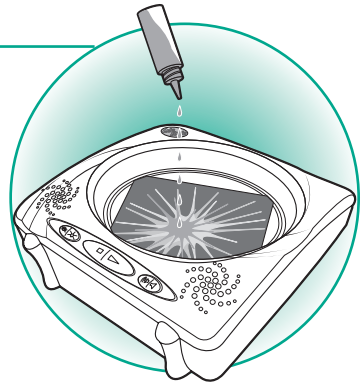
3. Drip paint onto the spinning design card. When finished, press the  button once or twice to turn the paint spinner off.



GETTING CREATIVE

Once you have a feel for using the paints on your design cards, you'll want to experiment with different paint colors and strobe patterns to create different effects. Here are a few play suggestions:

1. Once spinning, you can press the  button to control the strobe patterns. Press the  button to shuffle through all of the strobe patterns.
2. Press the  button once to shut off the music; press it a second time to change the music.

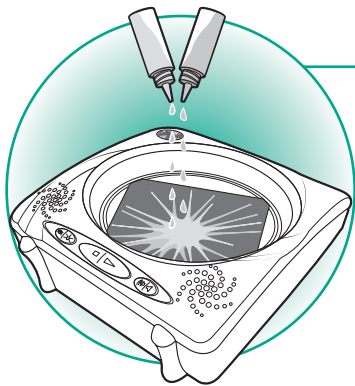

3. You can drip two paints at once to create a whole new effect. Remember, you can use your imagination to make all kinds of cool designs!

OTHER IDEAS

Here are a few extra play features and suggestions:

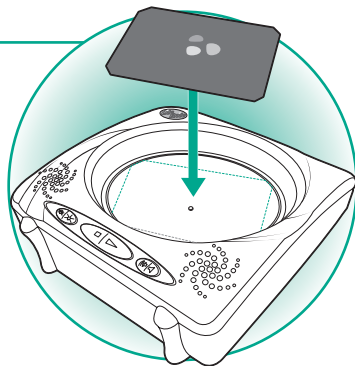

1. Put paint on your design card before you place it on the spinner platform. Try making a smiley face, a favorite symbol or any design you wish!
2. Once the paint has dried on your design card, you can stand the FLASH ART Neon Paint Spinner upright and put it on display in your room!
3. You can also frame or hang your dry design cards.
4. Check out our FLASH ART Neon Paint Spinner refill sets to create other cool designs. Available at your local LITE BRITE retailer!



CLEANING UP

Turn off the FLASH ART Neon Paint Spinner and wipe with a damp paper towel to clean and prevent paint build-up.

TROUBLESHOOTING

If your FLASH ART Neon Paint Spinner shuts off automatically after 6 seconds, press either the  or  buttons while the spinner is on. You will need to repeat this step each time you replace the batteries.

TO REPLACE BATTERIES

Use a Phillips/cross head screwdriver to loosen screw in battery compartment door (screw remains attached to door). Insert 4 fresh 1.5V "C" or LR14 size alkaline batteries. Fit door back into place and tighten screw.

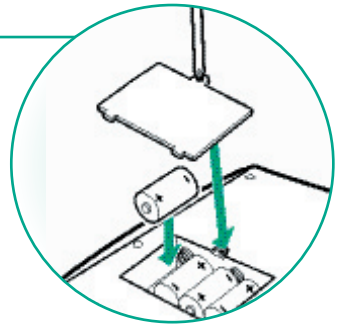

CAUTION: TO AVOID BATTERY LEAKAGE

1. Be sure to insert the batteries correctly and always follow the toy and battery manufacturers' instructions;
2. Do not mix old and new batteries or alkaline, standard (carbon-zinc) or rechargeable (nickel-cadmium) batteries;
3. Always remove weak or dead batteries from the product.

IMPORTANT: BATTERY INFORMATION

Please retain this information for future reference.
Batteries should be replaced by an adult.



CAUTION:

1. Always follow the instructions carefully. Use only batteries specified and be sure to insert them correctly by matching the + and - polarity markings.
2. Do not mix old batteries and new batteries or standard (carbon-zinc) with alkaline batteries.
3. Remove exhausted or dead batteries from the product.
4. Remove batteries if product is not to be played with for a long time.
5. Do not short circuit the supply terminals.
6. Should this product cause, or be affected by, local electrical interference, move it away from other electrical equipment. Reset (switching off and back on again or removing and re-inserting batteries) if necessary.
7. **RECHARGEABLE BATTERIES:** Do not mix these with any other types of battery. Always remove from the product before recharging. Recharge batteries under adult supervision. **DO NOT RECHARGE OTHER TYPES OF BATTERIES.**

FCC STATEMENT

This equipment has been tested and found to comply with the limits for a Class B digital device, pursuant to part 15 of the FCC Rules. These limits are designed to provide reasonable protection against harmful interference in a residential installation. This equipment generates, uses and can radiate radio frequency energy, and, if not installed and used in accordance with the instructions, may cause harmful interference to radio communications. However, there is no guarantee that interference will not occur in a particular installation. If this equipment does cause harmful interference to radio or television reception, which can be determined by turning the equipment off and on, the user is encouraged to try to correct the interference by one or more of the following measures:

- Reorient or relocate the receiving antenna.
- Increase the separation between the equipment and the receiver.
- Consult the dealer or an experienced radio/TV technician for help.



© 2005 Hasbro. All Rights Reserved.
TM & ® denote U.S. Trademarks.
U.S. Patent Pending
20251 P/N 6453540100



Questions? Call: 1-800-327-8284

Free Manuals Download Website

<http://myh66.com>

<http://usermanuals.us>

<http://www.somanuals.com>

<http://www.4manuals.cc>

<http://www.manual-lib.com>

<http://www.404manual.com>

<http://www.luxmanual.com>

<http://aubethermostatmanual.com>

Golf course search by state

<http://golfingnear.com>

Email search by domain

<http://emailbydomain.com>

Auto manuals search

<http://auto.somanuals.com>

TV manuals search

<http://tv.somanuals.com>