

Disney • PIXAR

TOY STORY

AND BEYOND!

AGES 4+
03173



Buzz Lightyear's Electronic Spaceship

Thanks for purchasing this Toy Story toy!

Includes ship, launcher, 2 projectiles and figure.

Batteries included.
Replace with 2
x 1.5V "AA" or
R6 size batteries.
Alkaline batteries
recommended.
Phillips/cross head
screwdriver (not
included) needed to
replace batteries.

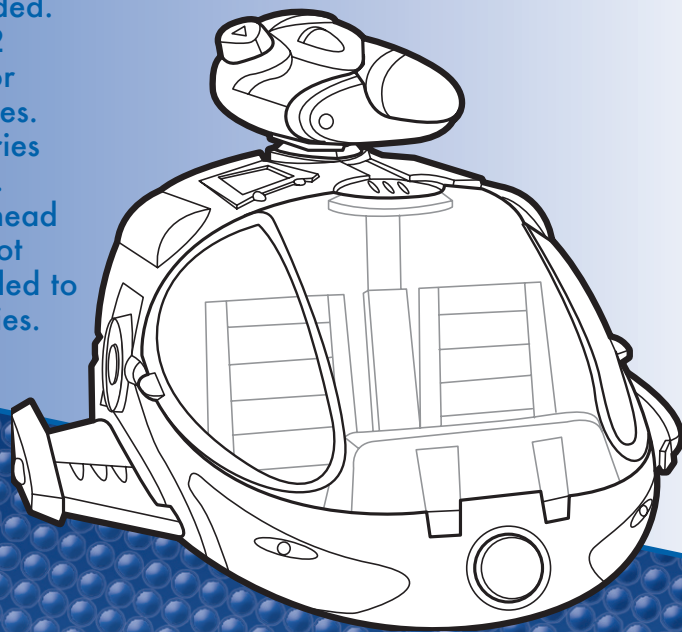

NOTE: Adult should remove and discard all plastic fasteners.

Playtime

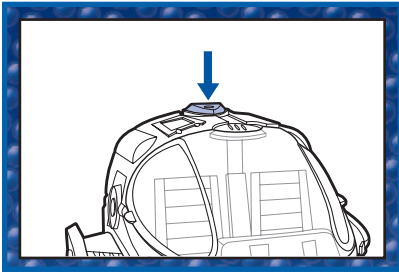

- Press green button to activate engine lights and blasting sounds.

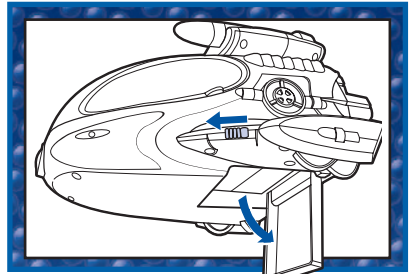

- Push "secret" switch to activate trap door.

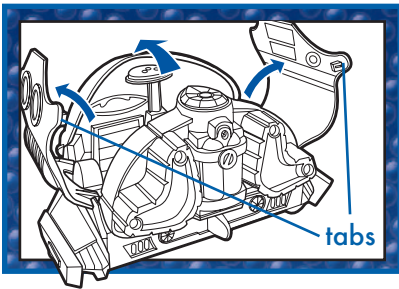

- Use tabs on back to reveal command center

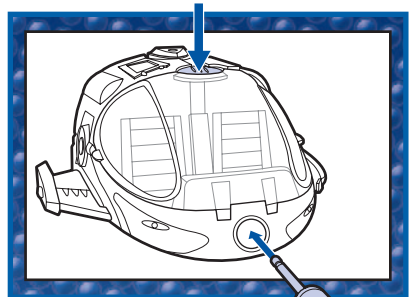

1. Insert projectile.
2. Press red button to launch.

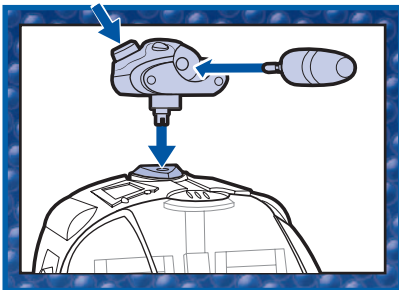

1. Lock projectile in launcher.
2. Mount launcher in hole on green button.
3. Press button to launch projectile and activate lights and sounds.

Note: Launcher can be used with other awesome Toy Story playsets and vehicles.

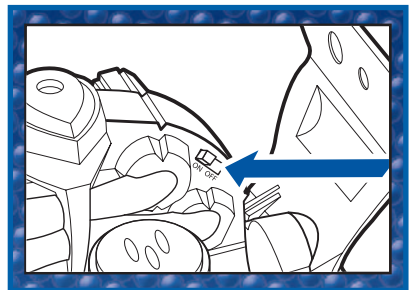

Please turn the spaceship off when not in use to conserve battery life.

To Replace Batteries

Use a Phillips/cross head screwdriver (not included) to loosen screw in battery compartment door (screw remains attached to door). Remove door and discard old batteries. Insert 2 x 1.5V fresh "AA" or R6 size batteries. Alkaline batteries recommended. Replace door and tighten screw.

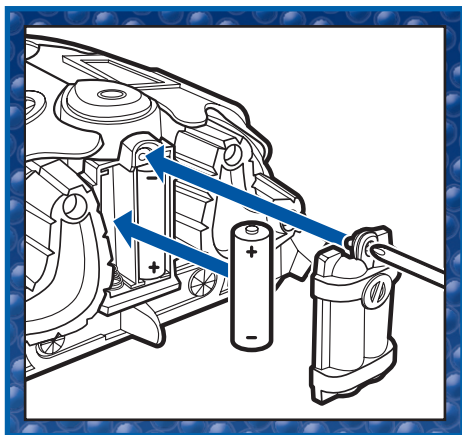

CAUTION:

1. Be sure to insert the batteries correctly and always follow the toy and battery manufacturers' instructions;
2. Do not mix old and new batteries or alkaline, standard (carbon-zinc) or rechargeable (nickel-cadmium) batteries;
3. Always remove weak or dead batteries from the product.

IMPORTANT: BATTERY INFORMATION

Please retain this information for future reference.

Batteries should be replaced by an adult.



CAUTION:

1. Always follow the instructions carefully. Use only batteries specified and be sure to insert item correctly by matching the + and - polarity markings.
2. Do not mix old and new batteries or standard (carbon-zinc) with alkaline batteries.
3. Remove exhausted or dead batteries from the product.
4. Remove batteries if product is not to be played with for a long time.
5. Do not short-circuit the supply terminals.
6. Should this product cause, or be affected by, local electrical interference, move it away from other electrical equipment. Reset (switching off and back on again or removing and re-inserting batteries) if necessary.
7. **RECHARGEABLE BATTERIES:** Do not mix these with any other types of batteries. Always remove from the product before recharging. Recharge batteries under adult supervision. **DO NOT RECHARGE OTHER TYPES OF BATTERIES.**

FCC STATEMENT

This device complies with part 15 of the FCC Rules. Operation is subject to the following two conditions: (1) This device may not cause harmful interference, and (2) this device must accept any interference received, including interference that may cause undesired operation. This equipment has been tested and found to comply with the limits for a Class B digital device, pursuant to part 15 of the FCC Rules. These limits are designed to provide reasonable protection against harmful interference in a residential installation. This equipment generates, uses and can radiate radio frequency energy, and, if not installed and used in accordance with the instructions, may cause harmful interference to radio communications. However, there is no guarantee that interference will not occur in a particular installation. If this equipment does cause harmful interference to radio or television reception, which can be determined by turning the equipment off and on, the user is encouraged to try to correct the interference by one or more of the following measures:

- Reorient or relocate the receiving antenna.
- Increase the separation between the equipment and receiver.
- Consult the dealer or an experienced radio/TV technician for help.



**Not suitable for children under 3 years
because of small parts - choking hazard.**

© Disney/Pixar
®* and/or ™* & © 2004 Hasbro. All Rights Reserved.
® denotes Reg. U.S. Pat. & TM Office.

03173

P/N 6479280000



Questions? Call: 1-800-327-8264

Free Manuals Download Website

<http://myh66.com>

<http://usermanuals.us>

<http://www.somanuals.com>

<http://www.4manuals.cc>

<http://www.manual-lib.com>

<http://www.404manual.com>

<http://www.luxmanual.com>

<http://aubethermostatmanual.com>

Golf course search by state

<http://golfingnear.com>

Email search by domain

<http://emailbydomain.com>

Auto manuals search

<http://auto.somanuals.com>

TV manuals search

<http://tv.somanuals.com>