

TRANSFORMERS

UNIVERSE



WARNING:
CHOKING HAZARD-Small parts.
Not for children under 3 years.

AGES 5+

83841/83794 Asst.

NOTE: Some parts are made to detach if excessive force is applied and are designed to be reattached if separation occurs. Adult supervision may be necessary for younger children.

CHANGING TO VEHICLE

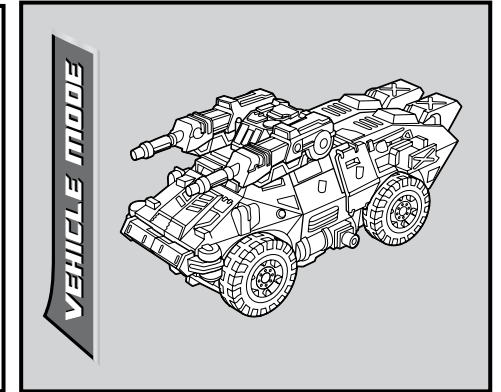
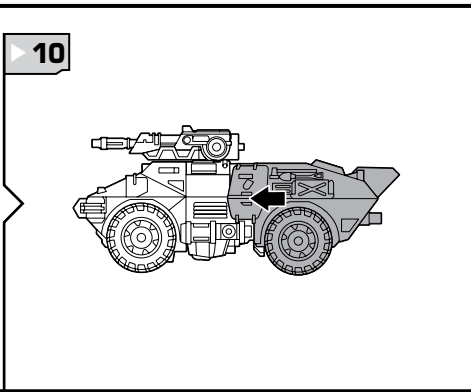
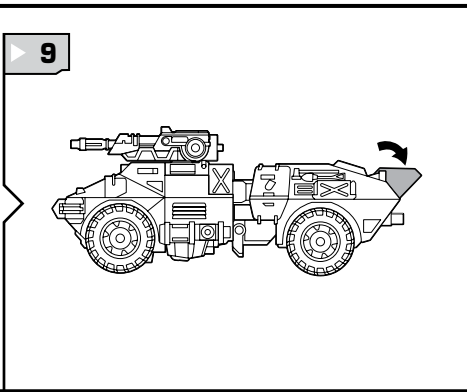
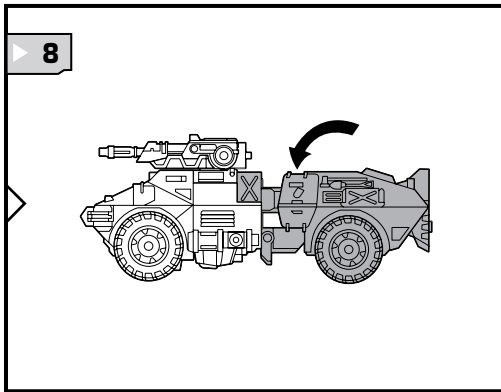
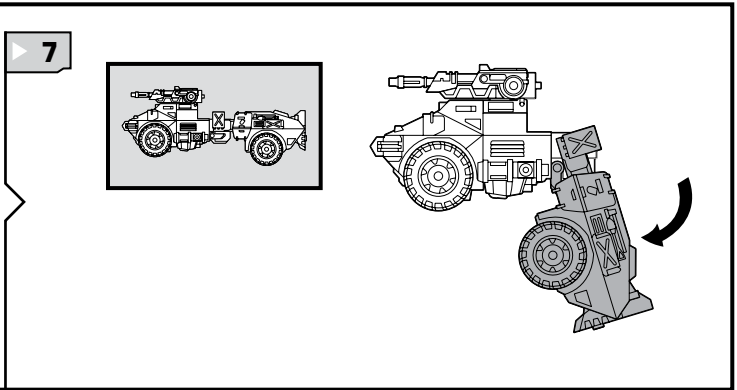
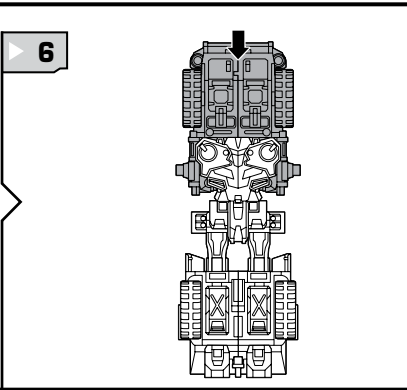
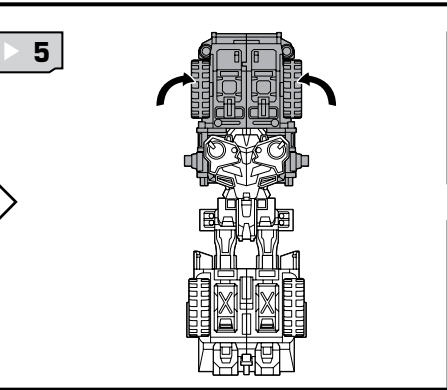
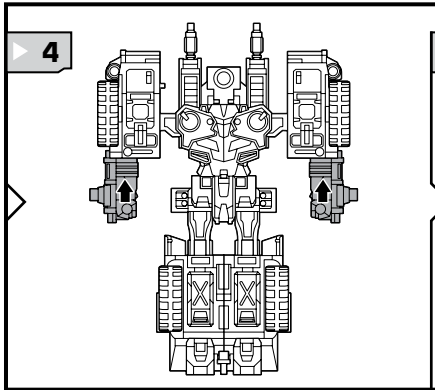
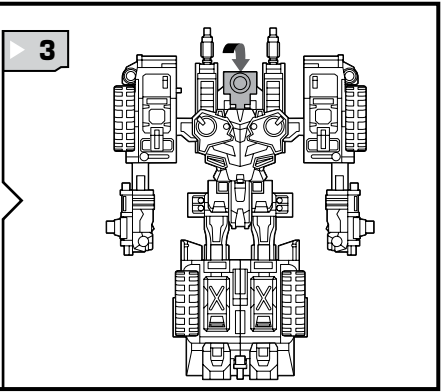
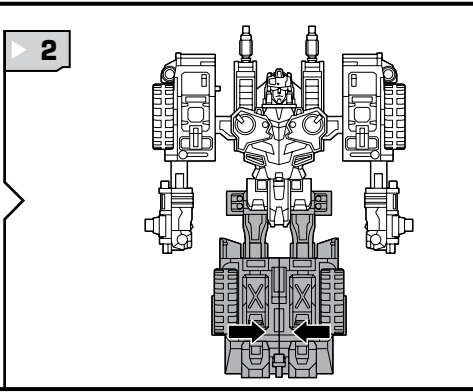
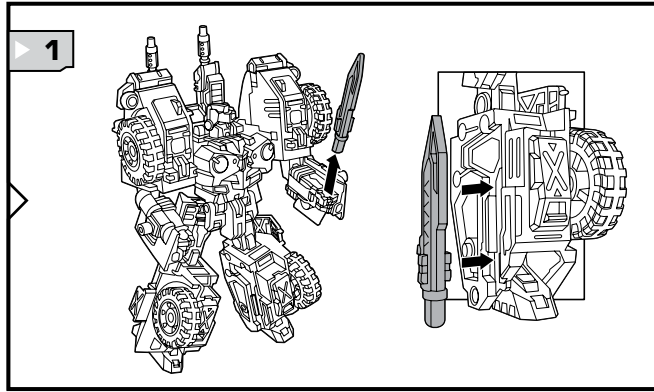
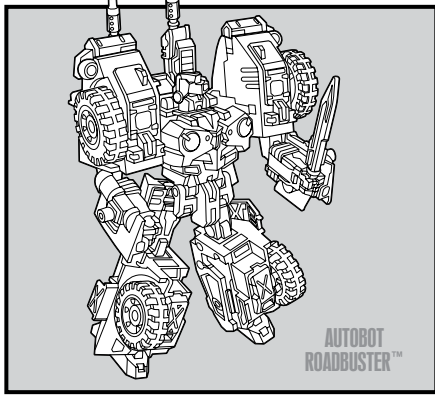

Reverse order of instructions to convert back to robot.

ATTACK MODE

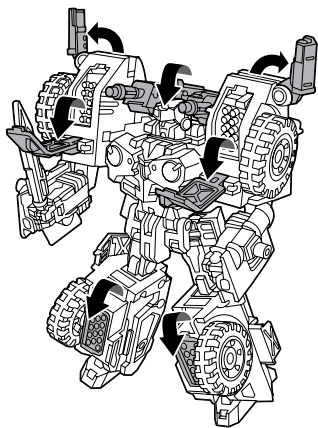
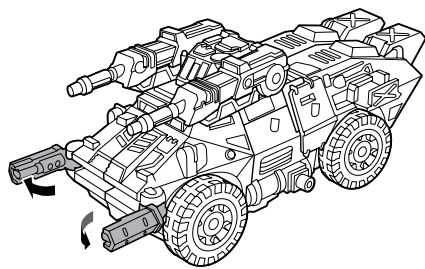

INSERT KEY TO ACTIVATE FEATURES!

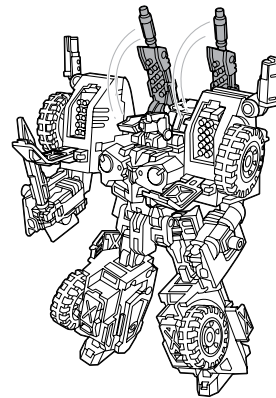

Insert KEY to pop open recoilless rifles and reveal missile pods!

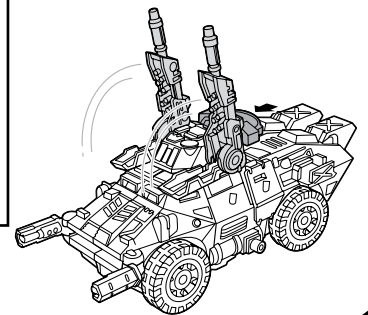
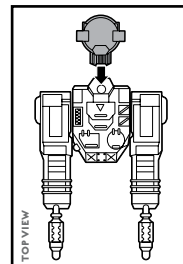

CHANGING TO VEHICLE

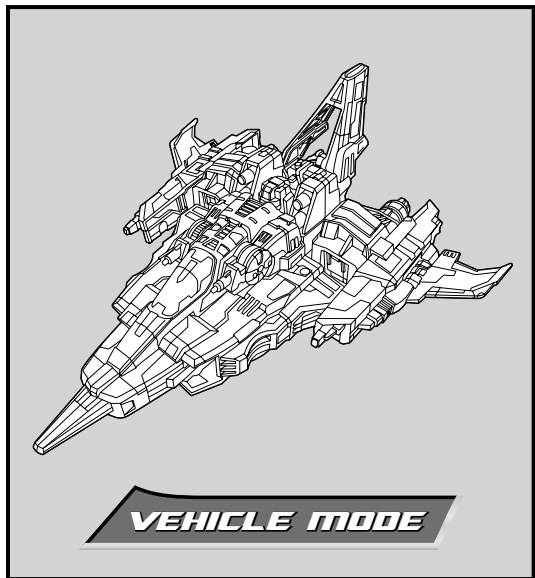
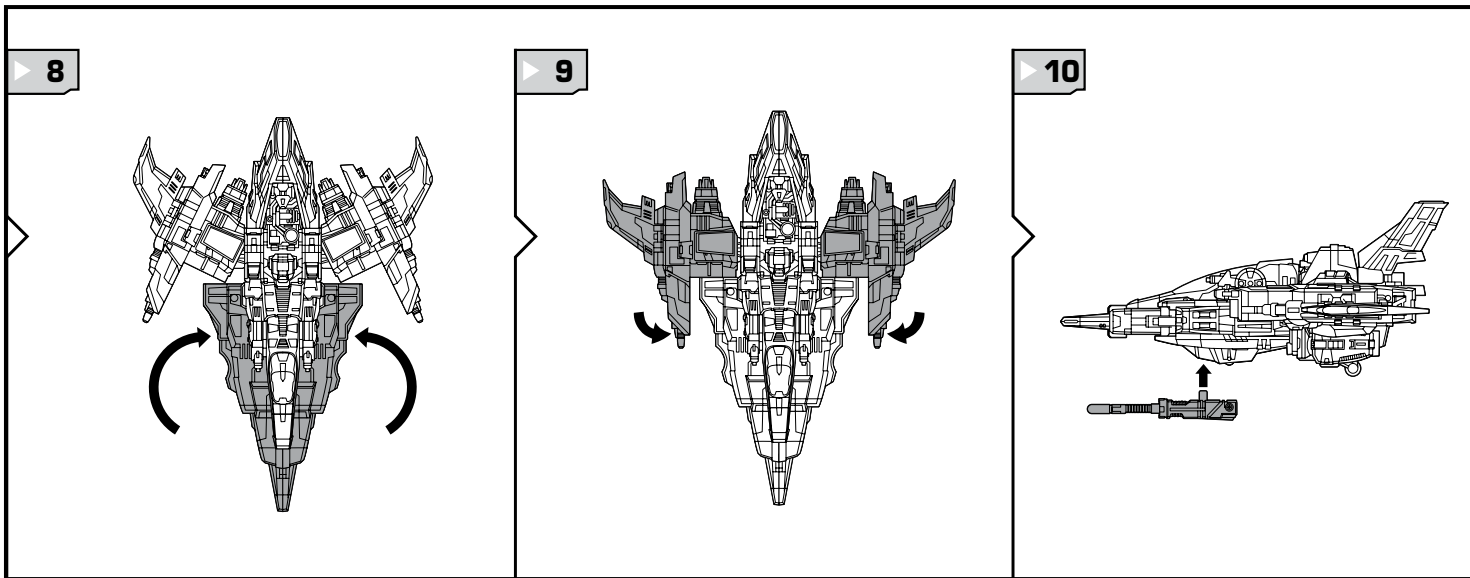
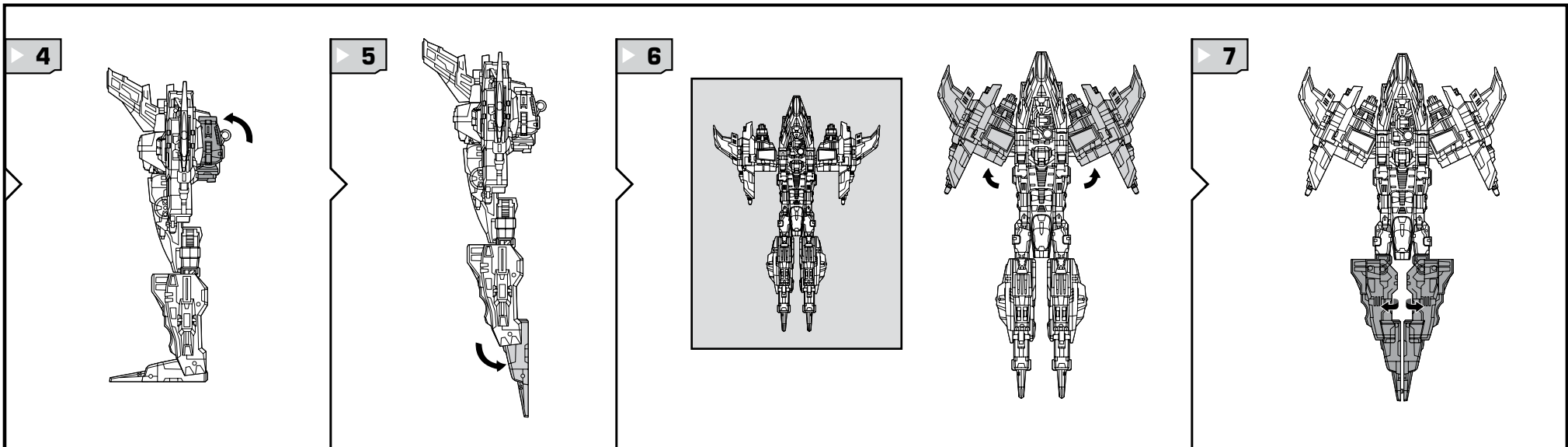
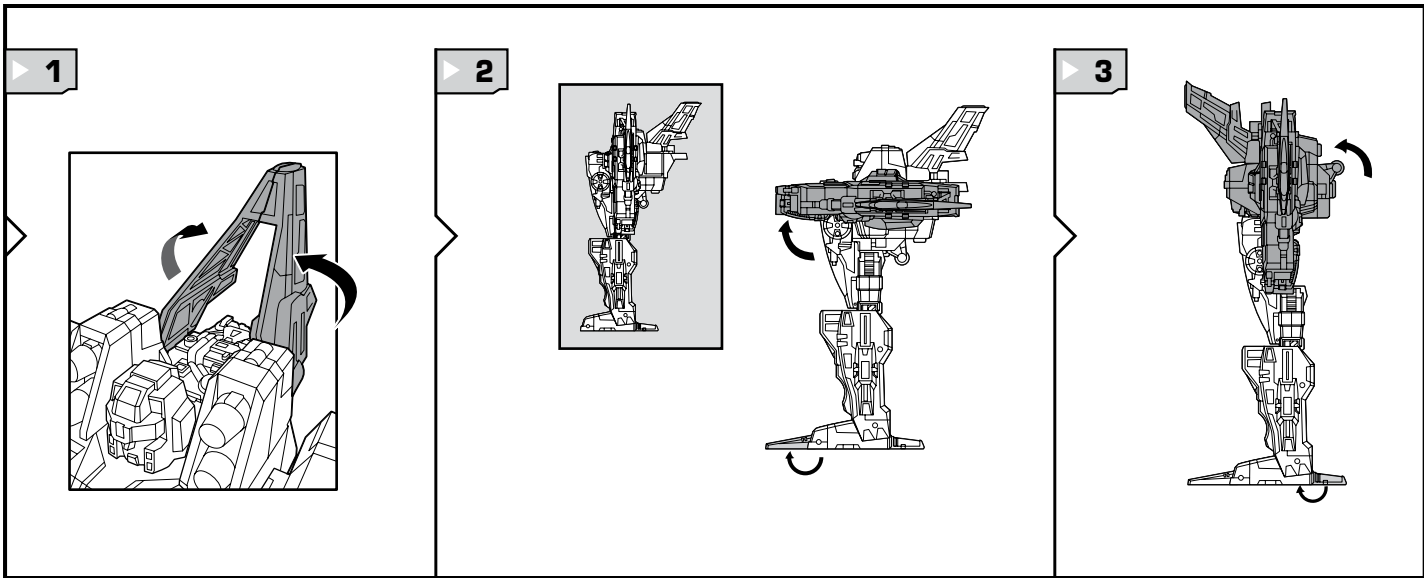
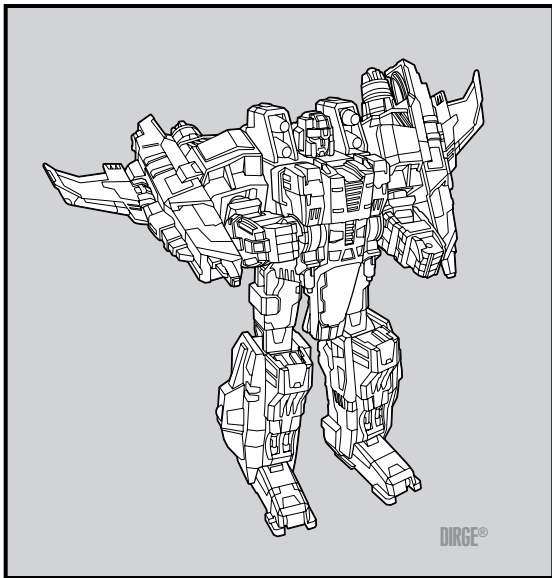

Reverse order of instructions to convert back to robot.

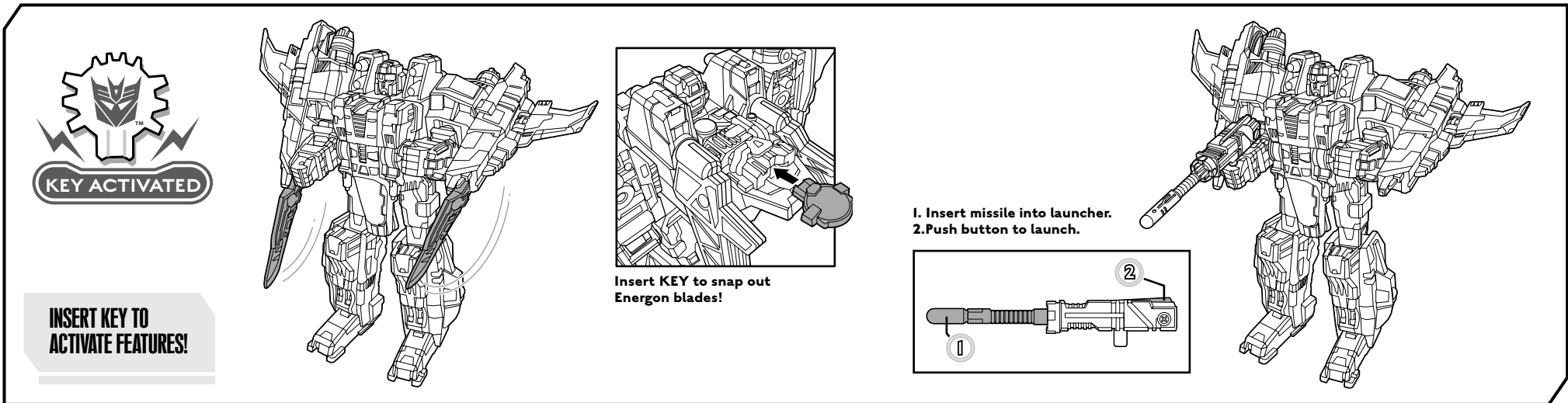

Free Manuals Download Website

<http://myh66.com>

<http://usermanuals.us>

<http://www.somanuals.com>

<http://www.4manuals.cc>

<http://www.manual-lib.com>

<http://www.404manual.com>

<http://www.luxmanual.com>

<http://aubethermostatmanual.com>

Golf course search by state

<http://golfingnear.com>

Email search by domain

<http://emailbydomain.com>

Auto manuals search

<http://auto.somanuals.com>

TV manuals search

<http://tv.somanuals.com>